



Congratulations on your new purchase of **SOYO P4X400 Series** motherboard for the Intel platform!

This new motherboard offers support for ultra fast DDR400 memory. However, since DDR400 is not a JEDEC (The Joint Electron Device Engineering Council) approved memory specification, some users might experience DDR400 incompatibilities as a result of discrepancy in memory manufacturing.

In an effort to provide our customers the highest product quality and performance, SOYO has tested a number of memory modules to ensure compatibility. Please visit our web site at <http://www.soyousa.com/products/proddesc.php?id=159> for information on Recommended Memory.

In some cases BIOS upgrade might be required to take advantage of this new feature. Please refer to our Support section on the web site for more information.



SY-P4X400 DRAGON Ultra Motherboard

mPGA Socket 478 Processor supported

VIA P4X400 AGP PRO/PCI

400/533 MHz Front Side Bus supported

ATX Form Factor

User's Manual

Trademarks:

SOYO is the registered trademark of SOYO Computer Inc. All trademarks are the properties of their owners.

Product Rights:

All names of the product and corporate mentioned in this publication are used for identification purposes only. The registered trademarks and copyrights belong to their respective companies.

Copyright Notice:

All rights reserved. This manual has been copyrighted by SOYO Computer Inc. No part of this manual may be reproduced, transmitted, transcribed, translated into any other language, or stored in a retrieval system, in any form or by any means, such as by electronic, mechanical, magnetic, optical, chemical, manual or otherwise, without permission in writing from SOYO Computer Inc.

Disclaimer:

SOYO Computer Inc. makes no representations or warranties regarding the contents of this manual. We reserve the right to amend the manual or revise the specifications of the product described in it from time to time without obligation to notify any person of such revision or amend. The information contained in this manual is provided to our customers for general use. Customers should be aware that the personal computer field is subject to many patents. All of our customers should ensure that their use of our products does not infringe upon any patents. It is the policy of SOYO Computer Inc. to respect the valid patent rights of third parties and not to infringe upon or to cause others to infringe upon such rights.

Disclaimer:

Please be advised that some SOYO motherboards are designed with overclocking features and may allow users to run the components beyond manufacturer's recommended specifications. Overclocking beyond manufacturer's specifications is not recommended nor endorsed by SOYO, Inc. and will void your manufacturer's warranty. Overclocking beyond manufacturer's specifications is not encouraged and should be assumed at the user's own risk. Unsafe overclocking can damage the user's system or cause serious personal injury. If the user is unsure or in doubt about overclocking, please seek professional advise. SOYO, Inc. is not responsible for any direct or indirect damage resulting from overclocking.

Restricted Rights Legend:

Use, duplication, or disclosure by the Government is subject to restrictions set forth in subparagraph (c)(1)(ii) of the Rights in Technical Data and Computer Software clause at 252.277-7013.

About This Guide:

This Quick Start Guide can help system manufacturers and end users in setting up and installing the Motherboard. Information in this guide has been carefully checked for reliability; however, to the correctness of the contents there is no guarantee given. The information in this document is subject to amend without notice.

For further information, please visit our **Web Site** on the Internet. The address is "<http://www.soyo.com.tw>".

Edition: September 2003
Version 1.2
P4X400 DRAGON Ultra SERIAL

FC Tested To Comply
With FCC Standards
FOR HOME OR OFFICE USE

100% POST CONSUMER
RECYCLED PAPER

Table of Contents

CHAPTER 1	MOTHERBOARD DESCRIPTION.....	1
1-1	INTRODUCTION.....	1
1-2	UNPACKING THE MOTHERBOARD	1
1-3	KEY FEATURES	2
1-4	HANDLING THE MOTHERBOARD	6
1-5	ELECTROSTATIC DISCHARGE PRECAUTIONS.....	6
1-6	SY-P4X400 DRAGON Ultra MOTHERBOARD LAYOUT	7
1-7	SY-P4X400 DRAGON Ultra MOTHERBOARD COMPONENTS	8
CHAPTER 2	HARDWARE INSTALLATION	10
2-1	PREPARATIONS.....	10
2-2	INSTALLATION GUIDE	11
2-3	QUICK BIOS SETUP.....	34
CHAPTER 3	BIOS SETUP UTILITY.....	36
3-1	SOYO COMBO SETUP	39
3-2	STANDARD CMOS SETUP	46
3-3	ADVANCED BIOS FEATURES	50
3-4	ADVANCED CHIPSET FEATURES	54
3-5	INTEGRATED PERIPHERALS.....	58
3-6	POWER MANAGEMENT SETUP	64
3-7	PNP/PCI CONFIGURATIONS.....	69
3-8	PC HEALTH STATUS.....	72
3-9	LOAD FAIL-SAFE DEFAULTS	74
3-10	LOAD OPTIMIZED DEFAULTS.....	75
3-11	SET SUPERVISOR PASSWORD	76
3-12	SET USER PASSWORD	77
CAHPTER 4	DRIVERS INSTALLATION.....	79
CAHPTER 5	AUDIO DRIVER INSTALLATION.....	87
CAHPTER 6	HIGHPOINT HPT372 DRIVER INSTALLATION... 	88



CHAPTER 7 REALTEK LAN DRIVER INSTALLATION.....94

APPENDIX A HIGHPOINT HPT372 MANUAL95

APPENDIX B C-MEDIA 6 CHANNEL AUDIO SOLUTION MANUAL.....127

APPENDIX C TROUBLE SHOOTING AT FIRST START166

APPENDIX D CONTACT INFORMATION.....173

Chapter 1

MOTHERBOARD DESCRIPTION

1-1 INTRODUCTION

The SY-P4X400 DRAGON Ultra AGP PRO/PCI Motherboard is a high-performance Socket 478 processor supported ATX form-factor system board. The SY-P4X400 DRAGON Ultra uses VIA Chipset technology and supports Socket 478 class processors. This Motherboard is fully compatible with industry standards and adds many technical enhancements.

1-2 UNPACKING THE MOTHERBOARD

When unpacking the Motherboard, check for the following items:

-
- ◆ The SY-P4X400 DRAGON Ultra AGP PRO/PCI Motherboard
-

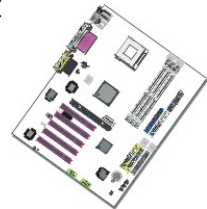

-
- ◆ The user manual
-



-
- ◆ The Installation CD-ROM
-



-
- ◆ SOYO Bonus Pack CD-ROM
-



-
- ◆ Three IDE Device ATA 100 Flat Cable
-

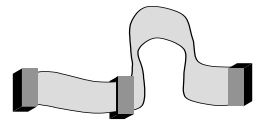

-
- ◆ One Floppy Disk Drive Flat Cable
-

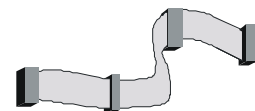

-
- ◆ One Audio Connector Card(optional)
-



- ◆ One Flat Cable for Audio Card
-



- ◆ Σ BOX (optional)
-



Warning: Do not unpack the Motherboard from its anti-static packaging until you are ready to install it.

Like most electronic equipment, your Motherboard may be damaged by electrostatic discharge. To avoid permanent damage to components ground yourself while working by using a grounding strap. Otherwise, ground yourself frequently by touching the unpainted portion of the computer chassis to drain the static charges.

Handle the Motherboard carefully, holding it by the edges.

You are now ready to start the installation.

1-3 KEY FEATURES

➤ CPU SUPPORT

Supports Intel® mPGA Socket 478 processors

- Pentium® 4 Northwood or Willamette (400MHz /533MHz FSB)
- Pentium® 4 Celeron

➤ CPU SETTINGS

The SY-P4X400 DRAGON Ultra provides the user with a very complete and convenient CPU setting environment. The CPU settings are all adjusted through the special SOYO COMBO page in the BIOS, therefore rendering the use of jumpers obsolete.

■ CPU FSB Frequency

The SY-P4X400 DRAGON Ultra supports a wide range of CPU FSB frequency settings:

100~132MHz, 133~165MHz. (CPU FSB Frequency can be setup by 1MHz increment)



This ensures that the SY-P4X400 DRAGON Ultra has an overwhelming overclocking potential.

■ **CPU Multiplier**

The SY-P4X400 DRAGON Ultra supports a wide range of multipliers: 10X ~ 24X depend on CPU.

➤ **MEMORY SUPPORT**

The SY-P4X400 DRAGON Ultra supports PC1600, PC2100 and PC2700 DDR Memory module.

➤ **EXPANDABILITY**

The SY-P4X400 DRAGON Ultra provides all the standard expansion slots, and many more additional expansion features:

◆ **Expansion slots**

- 1 x 32-bit bus master AGP PRO, supports 2x, 4x, 8x with 1.5v only.
- 5 x 32-bit bus master PCI slots

◆ **Enhanced IO**

- Floppy disk controller
- 2x EIDE controllers with support for up to 4 Ultra DMA 33/66 /100/133 devices
- Standard EPP/ECP parallel port
- 2x 16550 compatible serial ports
- IrDA compatible infrared port
- 6x USB2.0 (Universal Serial Bus) connectors
- PS/2 mouse connector
- PS/2 keyboard connector

➤ **USB Support**

The P4X400 DRAGON Ultra supports.
6 x USB 2.0 connectors for USB port.

➤ **IDE RAID FUNCTION**

The P4X400 DRAGON Ultra uses the HighPoint HPT372 chipset. It supports striping (RAID 0), mirroring (RAID 1), striping+mirroring (RAID0+1) or function as regular IDE port.



➤ **C-MEDIA HARDWARE AUDIO**

Supports 2/4/5.1 speakers and DLS based wave table music. Also provides professional SPDIF IN/OUT non-distortion digital interface. Uses the C-Media CMI8738-MX chipset.

➤ **LAN ON-BOARD**

Supports 10/100 Mbps base-T Ethernet. Use the Realtek RTL8100B chipset.

➤ **ADVANCED FUNCTIONS**

The SY-P4X400 DRAGON Ultra supports advanced functions such as:

■ **Wake-On-LAN**

Supports Wake-On-LAN (*Some advanced network cards can wake the system up over the network, the WOL connector is provided by the SY-P4X400 DRAGON Ultra to support this function*).

■ **Multiple boot**

The SY-P4X400 DRAGON Ultra supports booting from devices such as CD-ROM, LS-120, etc.

■ **Power on by modem or alarm**

If the SY-P4X400 DRAGON Ultra system is in suspend mode, it can be switched back on through the modem or RTC alarm through this function. This opens a lot of possibilities, such as remote access that switches the system on only after the modem receives a call.

➤ **FAIL SAFE**

The SY-P4X400 DRAGON Ultra comes with added functionality to make managing the system easy and safe

◆ **Hardware Monitor**

The integrated Hardware Monitor IC and Hardware doctor software enables the user to monitor system voltages, temperatures and FAN speeds. This makes sure that the user is full control of the system

◆ **Power Failure Resume Function**

This function can be set in the BIOS, and determines whether the system will automatically turn on again after a power failure. This function is



indispensable for server systems that need to always be on line.

➤ **SOYO Bonus Pack CD-ROM**

➤ **COMPLIANCE**

The SY-P4X400 DRAGON Ultra complies with all important industry standards. The following underlines the reliability of the SY-P4X400 DRAGON Ultra, a motherboard to trust.

- PC99, ACPI compliant

➤ **WARRANTY**

All SOYO motherboards are back with one-year manufacturer's warranty from the date of purchase. Please retain your original receipt for future warranty inquiries.

➤ **USER FRIENDLY**

- SOYO COMBO Setup
- Jumperless design
- You can set up the following options through the BIOS setup
 - CPU FSB frequency
 - CPU multiplier
 - CPU Vcore voltage
 - DDR RAM Clock
 - AGP Voltage
 - DDR Voltage



1-4 HANDLING THE MOTHERBOARD

To avoid damage to your Motherboard, follow these simple rules while unpacking:

- Before handling the Motherboard, ground yourself by grasping an unpainted portion of the system's metal chassis.
- Remove the Motherboard from its anti-static packaging. Hold the Motherboard by the edges and avoid touching its components.
- Check the Motherboard for damage. If any chip appears loose, press carefully to seat it firmly in its socket.



Warning: Do not apply power if the Motherboard appears damaged. If there is damage to the board, contact your dealer immediately.

1-5 ELECTROSTATIC DISCHARGE PRECAUTIONS

Make sure to ground yourself before handling the Motherboard or other system components. Electrostatic discharge can easily damage the components. Note that you must take special precautions when handling the Motherboard in dry or air-conditioned environment.

To protect your equipment from electrostatic discharge, take the following precautions:

- Do not remove the anti-static packaging until you are ready to install.
- Ground yourself before removing any system component from its protective anti-static packaging. (To ground yourself, grasp the expansion slot covers or other unpainted portions of the computer chassis.)
- Frequently ground yourself while working or use a grounding strap.
- Handle the Motherboard by its edges and avoid touching its components.

1-6 SY-P4X400 DRAGON Ultra MOTHERBOARD LAYOUT

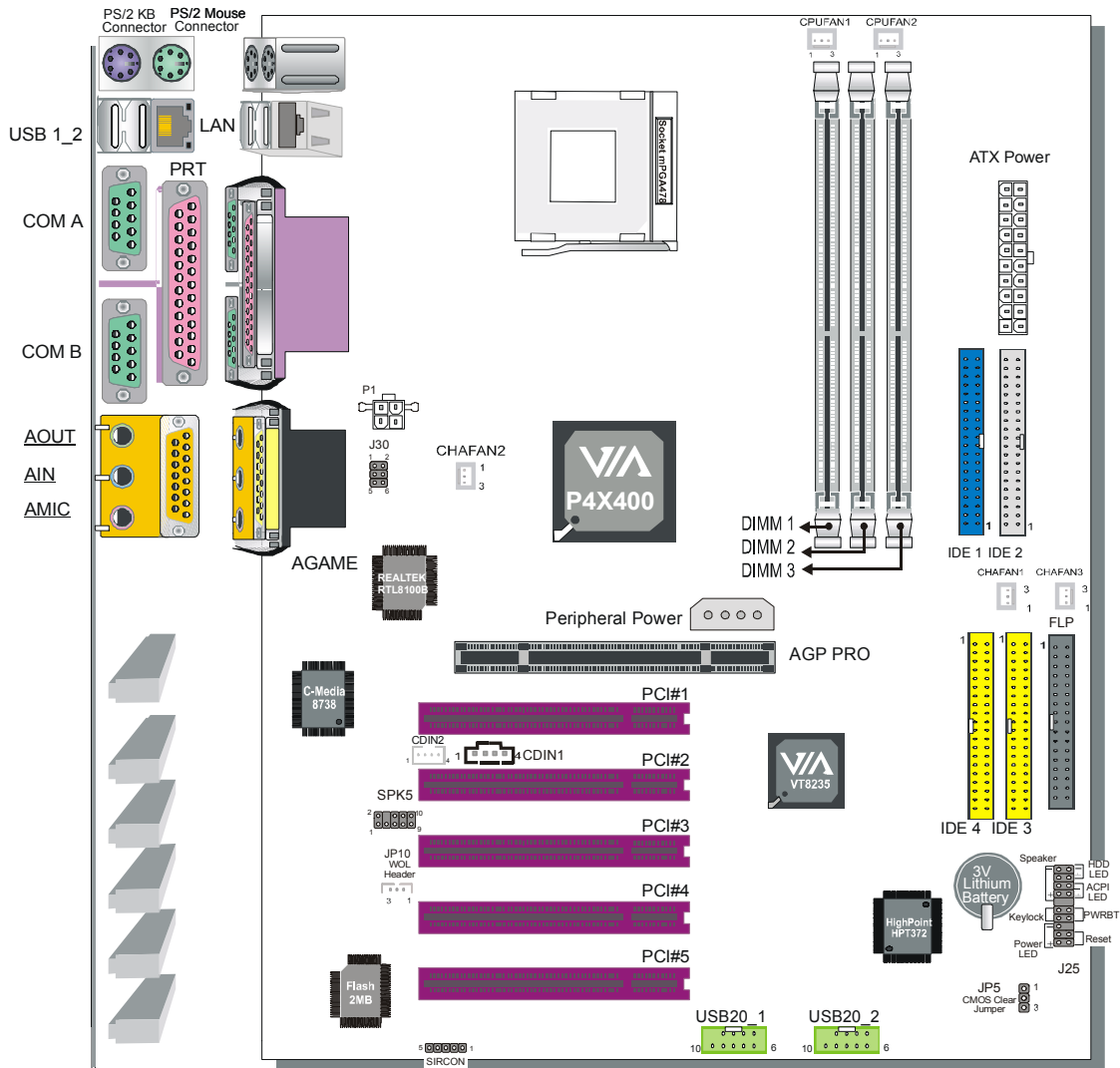

Back Panel

SY-P4X400 DRAGON Ultra Platform

1-7 SY-P4X400 DRAGON Ultra MOTHERBOARD COMPONENTS

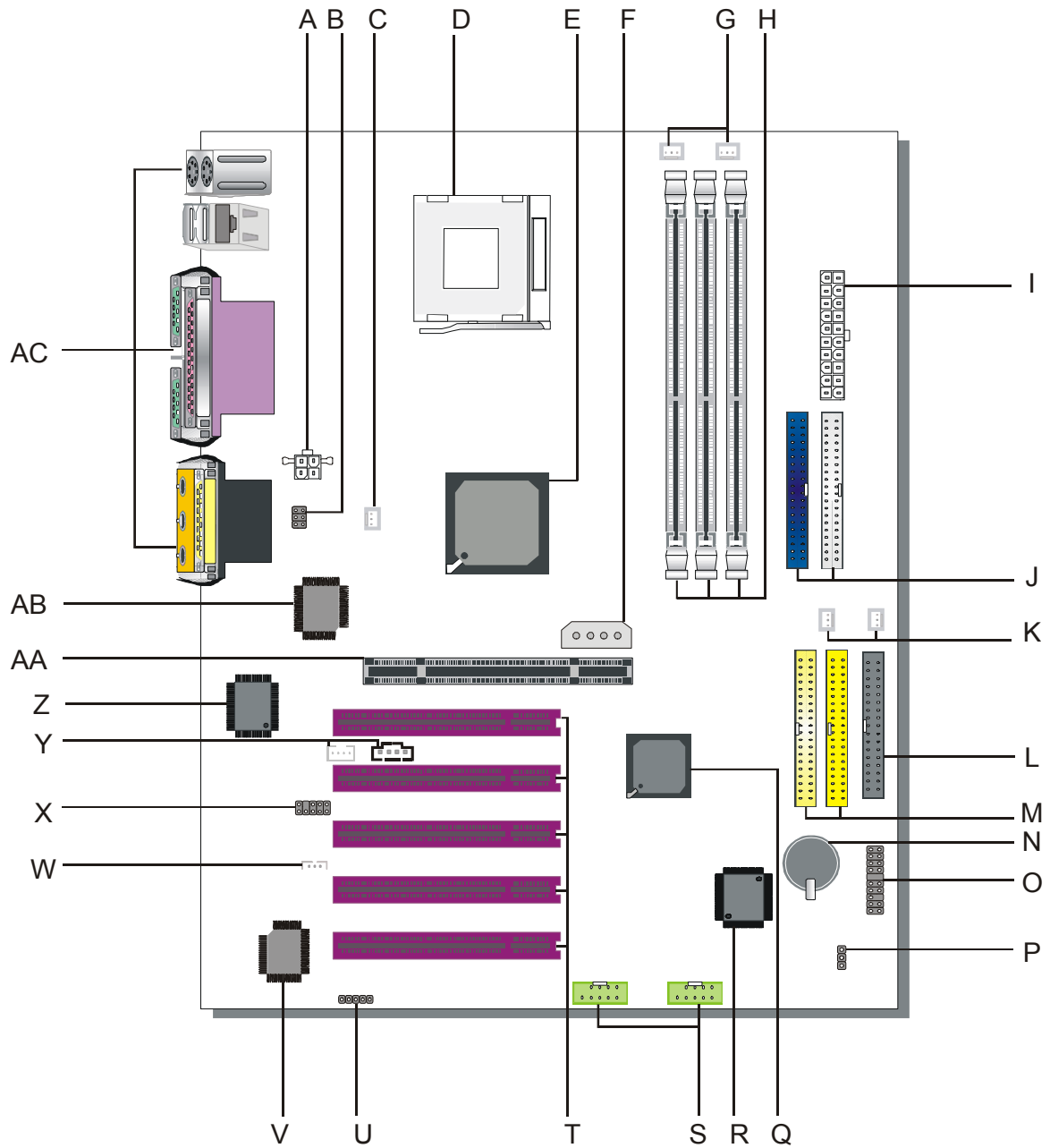



- A +12V Power Connector**
- B Front panel Connectors**
- C Chassis Cooling Fan Connector**
- D Socket 478 Connector**
- E VIA P4X400 North Bridge Chip**
- F Peripheral Power Connector**
- G CPU Cooling Fan Connector**
- H DIMM Banks**
- I ATX Power Supply Connector**
- J Bus Mastering EIDE/ATAPI Ports**
- K Chassis Cooling Fan Connector**
- L Floppy Disk Drive (FDD) Port**
- M IDE RAID Port**
- N 3V Lithium Battery**
- O Front Panel connectors**
- P CMOS Clear Jumper**
- Q VIA VT8235 South Bridge Chip**
- R HighPoint IDE RAID Chip**
- S USB 2.0 Connector**
- T 32-bit PCI Slots**
- U Serial Infrared (IrDA) Device Header**
- V Flash BIOS**
- W Wake-On-LAN (WOL) Header**
- X SPK5 Connector**
- Y CD-IN Connector**
- Z C-Media Onboard Audio Chip**
- AA AGP PRO Slot**
- AB Realtek LAN Chip**
- AC Back panel Connectors**

Chapter 2

HARDWARE INSTALLATION

Congratulations on your purchase of **SY-P4X400 DRAGON Ultra** Motherboard. You are about to install and connect your new Motherboard.



Note: Do not unpack the Motherboard from its protective anti-static packaging until you have made the following preparations.

2-1 PREPARATIONS

Gather and prepare all the following hardware equipment to complete the installation successfully:

1. Socket mPGA 478 processor with built-in CPU cooling fan (boxed type)



Note: This Motherboard supports non-boxed type CPUs. The heavier CPU cooling fan requires the installation of a CPU support stand.

2. DDR RAM memory module (s)
3. Computer case and chassis with adequate power supply unit
4. Monitor
5. PS/2 Keyboard
6. Pointing Device (PS/2 mouse)
7. Speaker(s) (optional)
8. Disk Drives: HDD, CD-ROM, Floppy drive...
9. External Peripherals: Printer, Plotter, and Modem (optional)
10. Internal Peripherals: Modem and LAN cards (optional)



2-2 INSTALLATION GUIDE

We will now begin the installation of the Motherboard. Please follow the step-by-step procedure designed to lead you to a complete and correct installation.

Step 1- Install the Central Processing Unit (CPU)

Step 2- Install memory modules

Step 3- Install expansion cards

Step 4- Connect cables, case wires, and power supply

Step 5- Power on and enter BIOS setup

Step 6- Install supporting software tools. See Chapter 4 for more info.



Warning: Turn off the power to the Motherboard, system chassis, and peripheral devices before performing any work on the Motherboard or system.

BEGIN THE INSTALLATION

STEP 1 Install the CPU

CPU Mount Procedure: To mount the Pentium® 4 Socket mPGA478 processor that you have purchased separately, follow these instructions.

1. Lift the socket handle up to a vertical position.

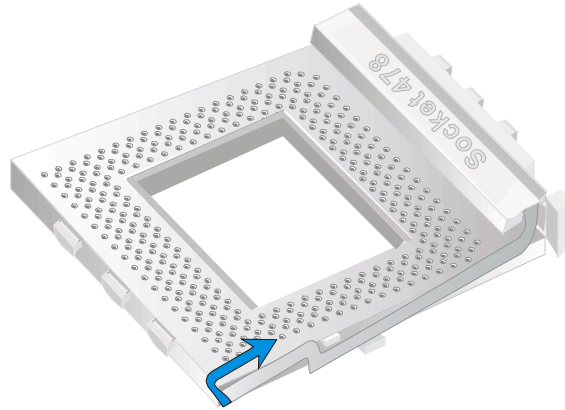

2. Align the blunt edge of the CPU with the matching pinhole distinctive edge on the socket.

- 3.

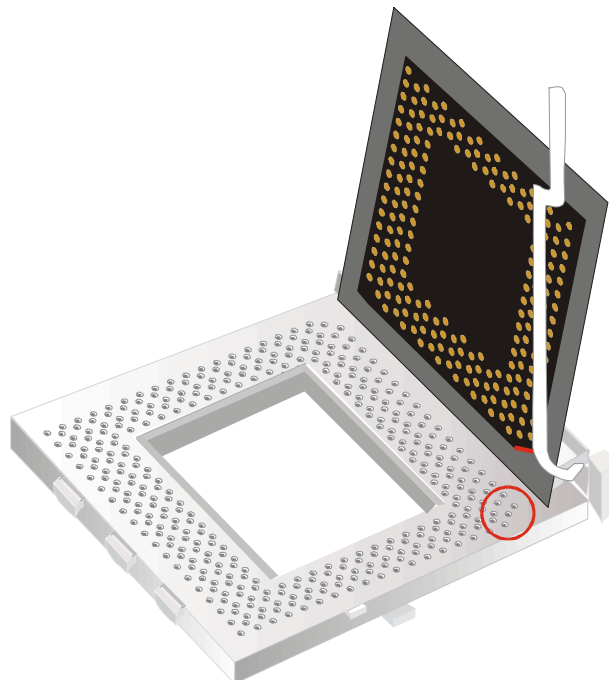

Seat the processor in the socket completely and without forcing.

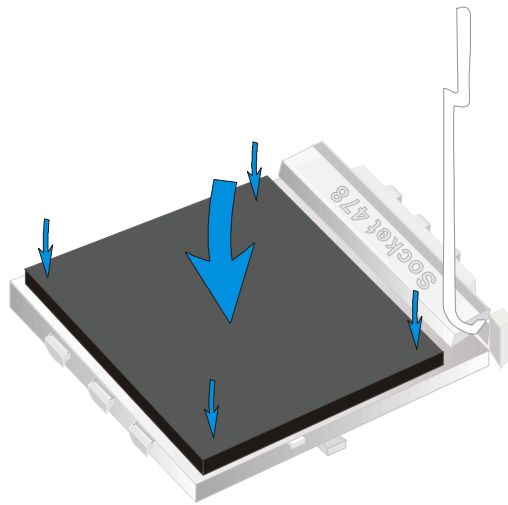

4. Then close the socket handle to secure the CPU in place.

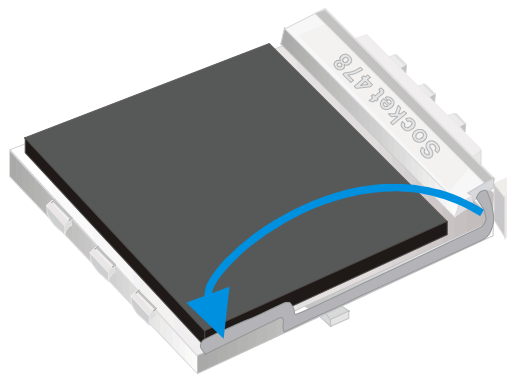

Remember to connect the CPU Cooling Fan to the appropriate power connector on the Motherboard. *The fan is a key component that will ensure system stability. The fan prevents overheating, therefore prolonging the life of your CPU.*

CPU Fan Installation

Your Socket 478 processor kit comes with a cooling fan. Mount the fan on the processor according to the instructions provided by the manufacturer. The fan is a key component that will ensure system stability. The fan prevents overheating, therefore prolonging the life of your CPU.



Note: Remember to connect the fan to the appropriate power source.

Step 2 Install Memory Module

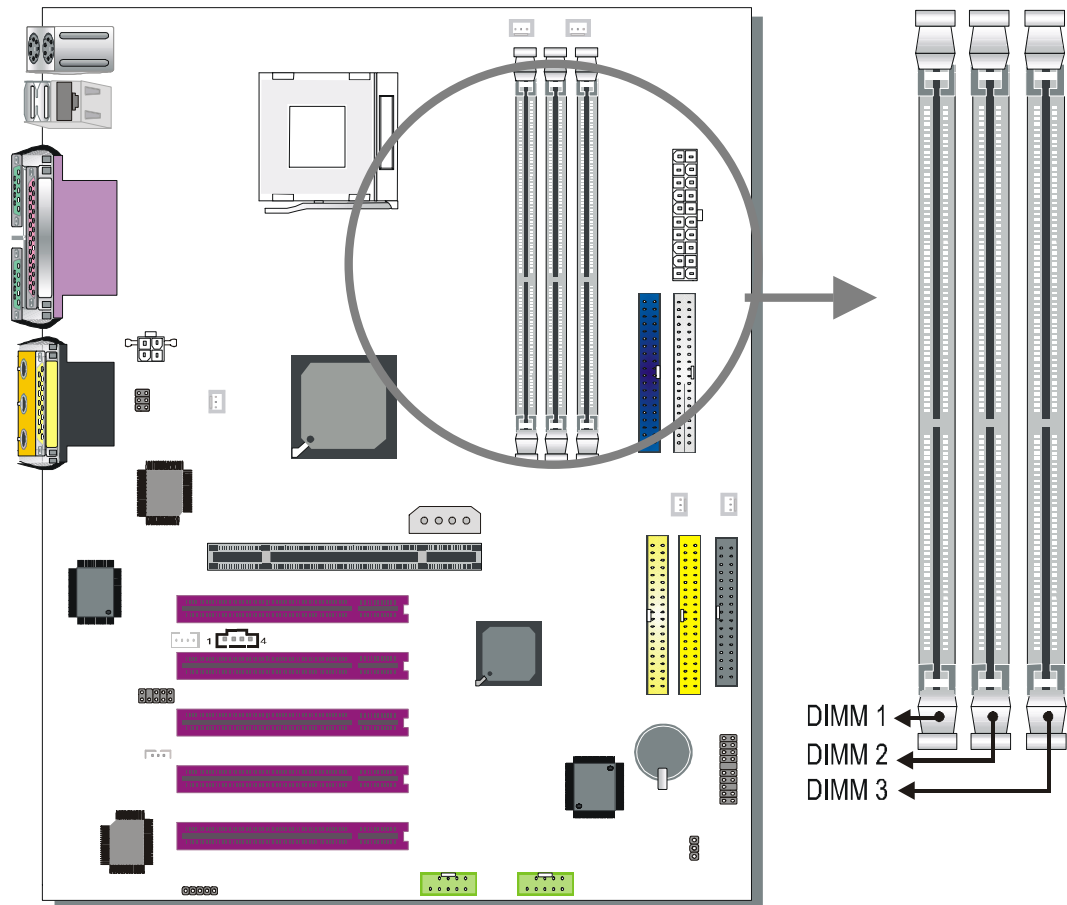

Your board comes with three DIMM sockets, Directly supports one DDR SDRAM channel, 64b wide, providing support max of 3 Double-Sided DIMMs with unbuffered DDR 266. ***The largest memory capacity possible is 3GB.*** On this motherboard, DRAM speed can be set independent from the CPU front side bus speed. Depending on the DRAM clock speed setting in the BIOS setup.

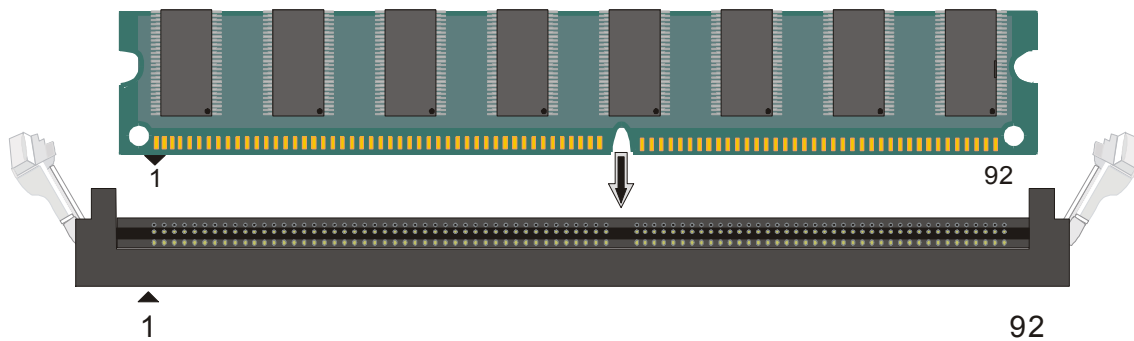



Memory Configuration Table

Number of Memory Modules	DIMM 1	DIMM 2	DIMM 3
RAM Type	DDR SDRAM (Un-buffered and Non-ECC)		
Memory Module Size (MB)	64/128/256/512 MB/1 GB		

Step 3 Install Expansion Card

The motherboard has 1 AGP PRO and 5 PCI slot.

1. Read the related expansion card's instruction document before inserting the expansion card into the computer.
2. Press the expansion card firmly into expansion slot in motherboard.
3. Be sure the metal contacts on the card are indeed seated in the slot.
4. Replace the screw to secure the slot bracket of the expansion card.
5. Install related driver from the operating system.

AGP Pro Slot

This motherboard supports AGP 2x/4x/8x Pro VGA CARD.



DO NOT remove the safety tab underneath it if you will be using an AGP card without a retention notch. Removing may cause the card to shift and may cause damage to your card, slot, and motherboard. Remove ONLY when you will be using an AGP Pro card. You can use a pen tip to remove the tab from the bay.

When 8x VGA card is used, “AGP mode” option in the BIOS will be disabled and the “DBI Output for AGP Trans” option will appear.



Note: This Motherboard supports only 1.5 volts AGP card. Using 3.3v AGP card might damage your M/B.

PCI Device Assigned Interrupt Table

Device	INT
AGP	INT A
PCI slot 1/5	INT A
PCI slot 2	INT B
PCI slot 3	INT C
PCI slot 4	INT D
On-board Audio	INT A
On-board RAID	INT B
On-board LAN	INT C

Step 4 Connect cables, case wires, and power supply
A. IDE Device Installation (HDD, CD-ROM)

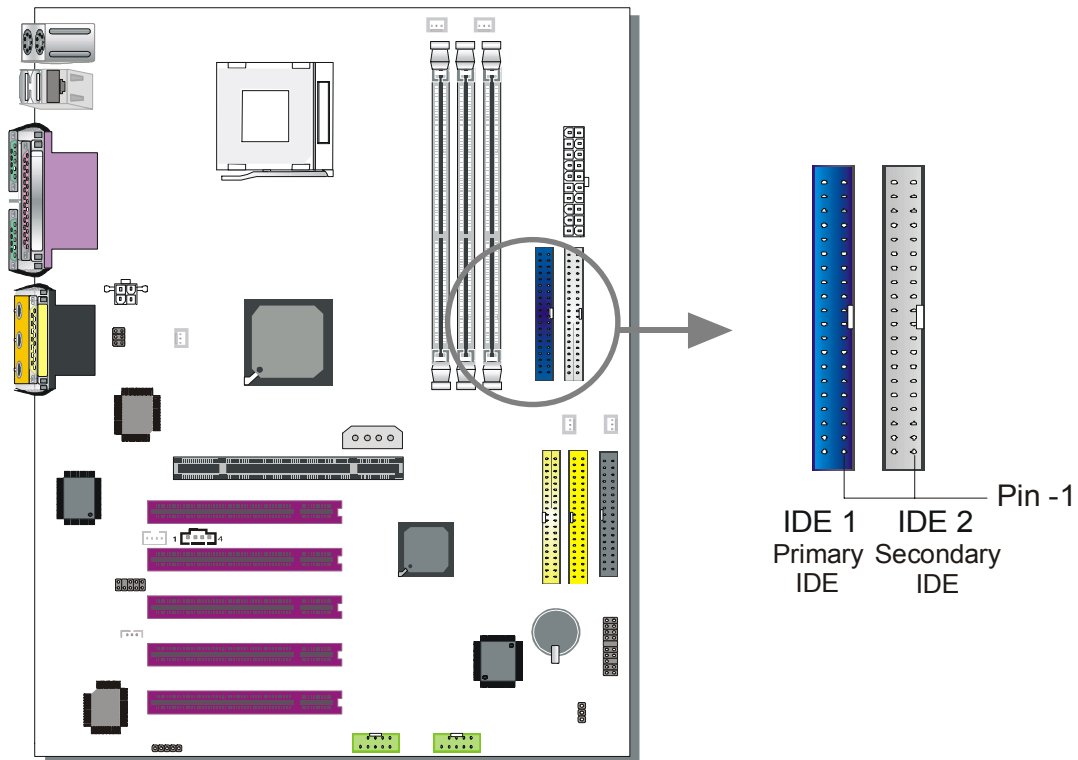

This Motherboard offers two primary and secondary IDE device connectors (IDE1, IDE2). It can support up to four high-speed Ultra DMA 33/ 66/100/133 HDD or CD-ROM.

Connect one side of the ATA66/100 flat cable to the IDE device (HDD or CD-ROM) and plug the other end to the primary (IDE1) or secondary (IDE2) directionally keyed IDE connector on the Motherboard. The ATA66/100 cable is backward compatible with ATA33 HDDs.

This Motherboard can support up to 4 HDDs.

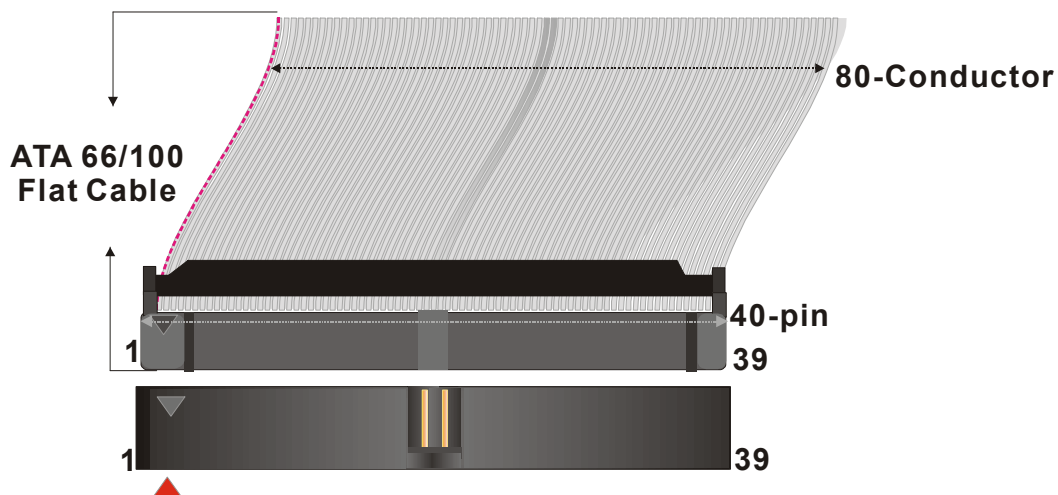

B. Floppy Drive Installation

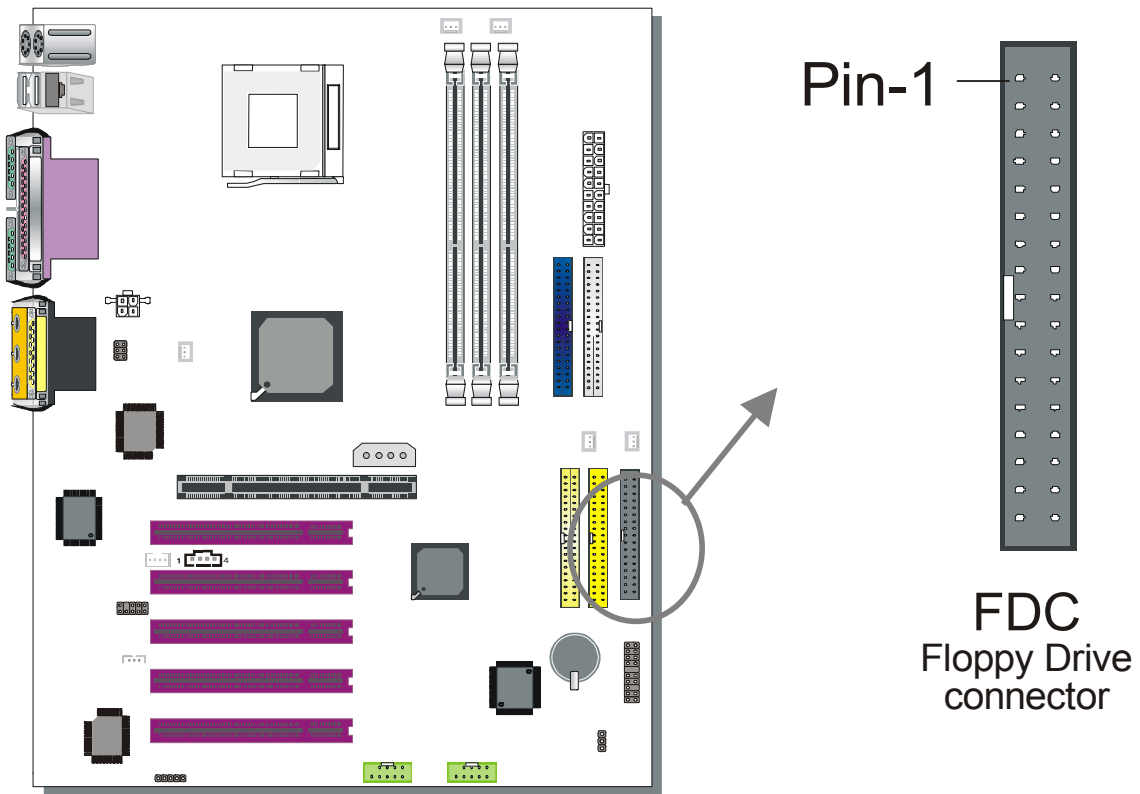

The system supports 5 possible floppy drive types: 720 KB, 1.2 MB, 1.44 MB, 2.88 MB, and LS-120.

Connect one side of the 34-pin flat cable to the floppy drive and plug the other end to the floppy drive connector on the Motherboard.

This Motherboard can support up to 1 floppy drives.

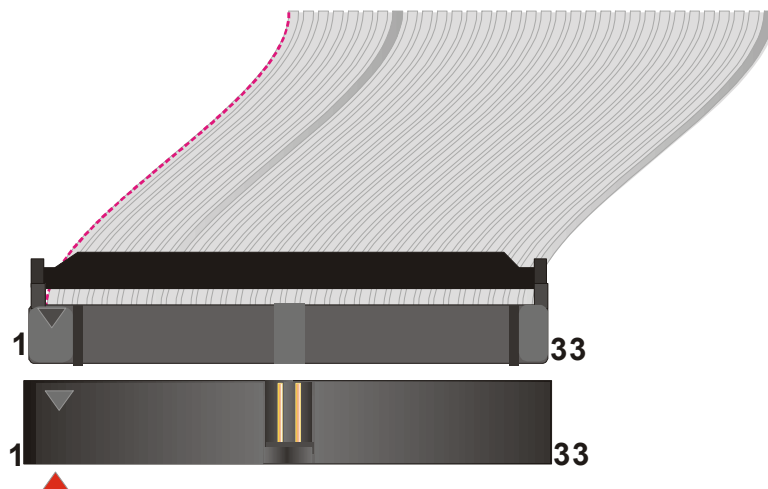

C. Front Panel Connections

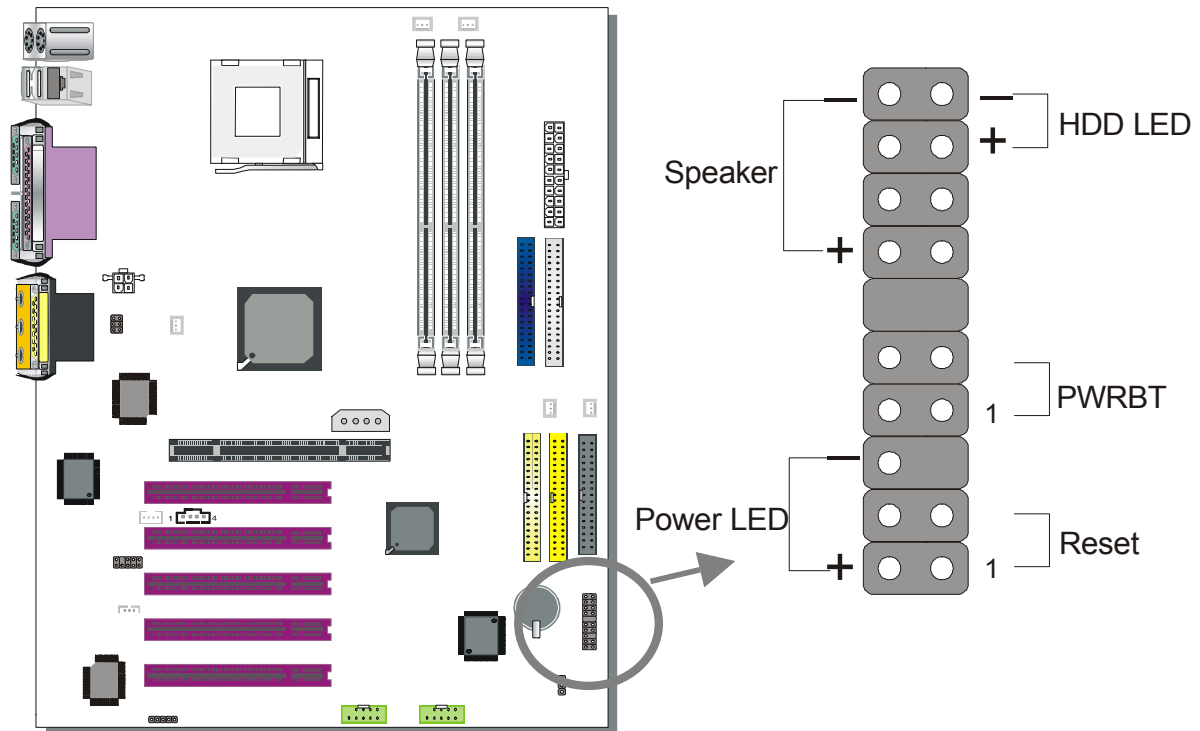

Plug the computer case's front panel devices to the corresponding headers on the Motherboard.

1. Power LED & KeyLock

Plug the Power LED cable into the 5-pin Keylock header.

Some systems may feature a KeyLock function with a front panel switch for enabling or disabling the keyboard. Connect the KeyLock switch to the 5-pin Keylock header on the Motherboard.

Please install according to the following pin assignment: pin 1,3 are for Power LED and pin 4,5 are for Keylock.

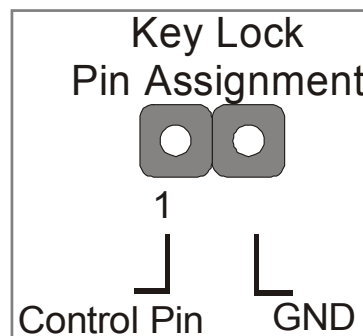
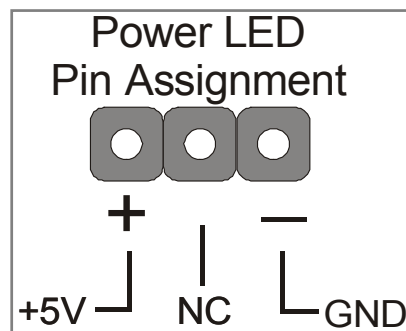

2. Reset

Plug the Reset push-button cable into the 2-pin Reset header on the Motherboard. Pushing the Reset button on the front panel will cause the system to restart the boot-up sequence.

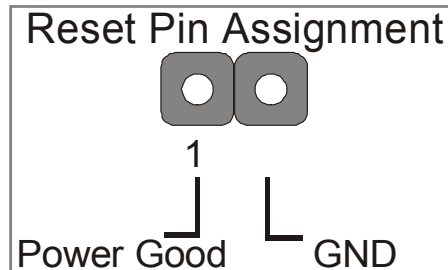

3. Speaker

Attach the 4-pin PC speaker cable from the case to the Speaker header on the Motherboard.

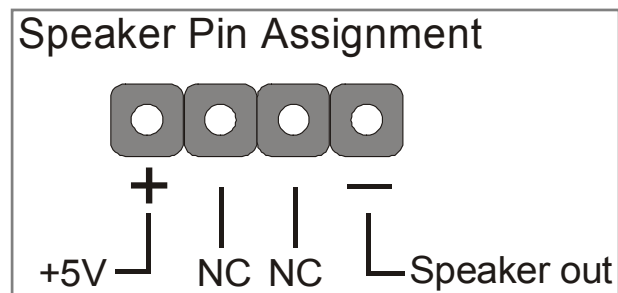

4. IDE LED

Attach the 2-pin IDE device LED cable to the corresponding IDE LED header on the Motherboard. This will cause the LED to lighten when an IDE (HDD, CD-ROM) device is active.

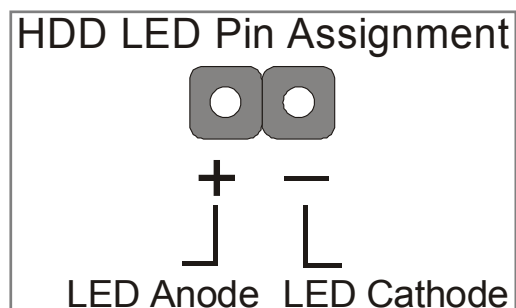

5. ATX Power On/Off Switch

Attach the 2-pin momentary type switch to the PWRBT header for turning On or Off your ATX power supply.

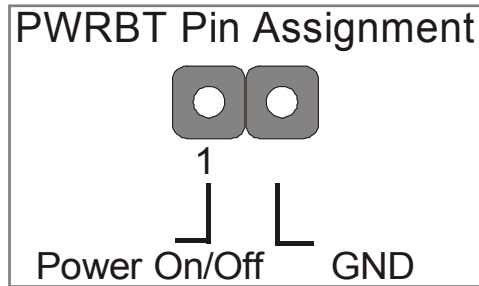

D. Back Panel Connections

All external devices such as the PS/2 keyboard, PS/2 mouse, printer, modem, USB can be plugged directly onto the Motherboard back panel. Only after you have fixed and locked the Motherboard to the computer case can you start connecting the external peripheral devices.

When connecting an external device, use the following figure to locate and identify which back panel connector to plug the device to.

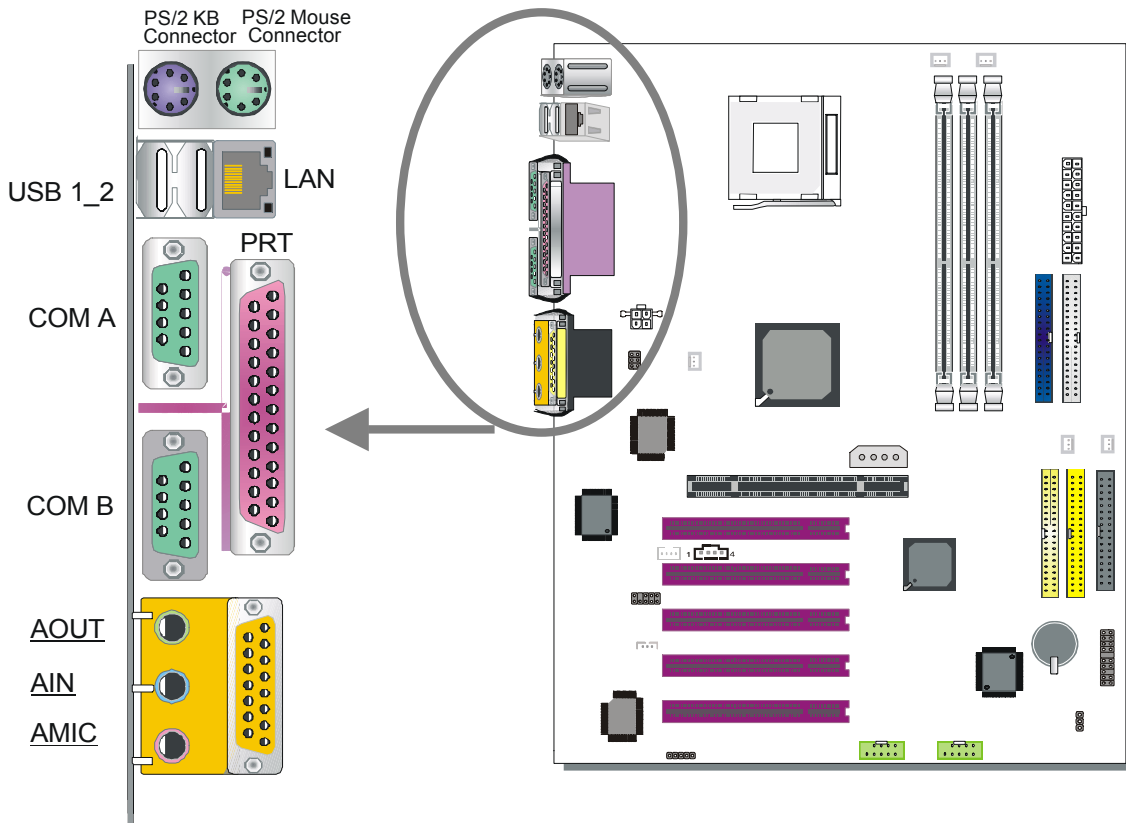

1. Onboard Serial Ports COMA/COMB

External peripherals that use serial transmission scheme include:

- serial mouse,
- and modem.

Plug the serial device cables directly into the COMA/COMB 9-pin male connectors located at the rear panel of the Motherboard.

2. Parallel Port PRT

This parallel port is used to connect the printer or other parallel devices.

Plug the parallel device cable into the 25-pin female connector located at the rear panel of the Motherboard.

3. PS/2 Keyboard

Plug the keyboard jack directly into the 6-pin female PS/2 keyboard connector located at the rear panel of the Motherboard.

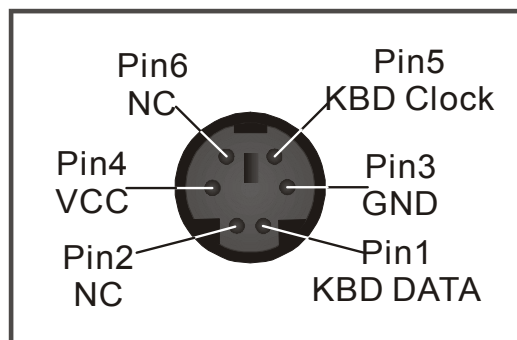

4. PS/2 Mouse

Similarly, plug the mouse jack directly into the 6-pin female PS/2 mouse connector.

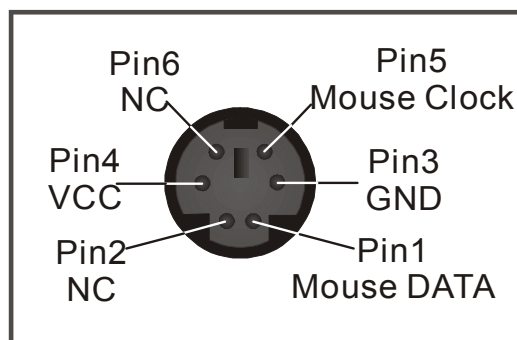

5. Universal Serial Bus (USB1/USB2, USB20_1/USB20_2)

This Motherboard provides four USB ports for your additional devices. Plug the USB device jack into the available USB connector USB1 or USB2.

- Standard device drivers come with the Win98 for commonly used USB devices.
- With Win95, use the flow UHCI specifications. To use USB devices under Win95, usually you have to install the device that driver comes with the USB device you have purchased.

USB20_1 and USB20_2 are available. To make use of these USB ports, purchase a USB cable from your dealer. The lay-out of USB20_1 and USB20_2 are as follows:

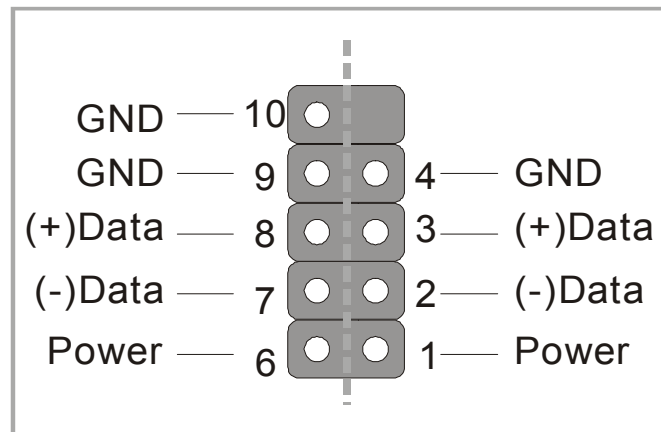

USB1, USB2, USB20_1 and USB20_2 support USB2.0 devices.

USB20_1 and USB20_2 support USB2.0 devices.

6. Onboard Game port/audio

This Motherboard provides Joystick port and audio.

- Attach the joystick cable to the 15-pin GAME port at the rear panel of you motherboard.
- This Motherboard features three built-in audio-stereo ports (labeled line-in, line-out, and mic jack) convenient to directly plug-in all your external audio devices.

E. Other Connections

1. Wake-On-LAN (WOL)

Attach the 3-pin connector from the LAN card which supports the Wake-On-LAN (WOL) function to the JP10 header on the Motherboard. This WOL function lets users wake up the connected computer through the LAN card.

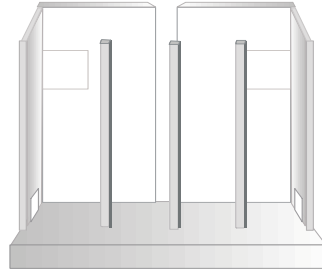

Please install according to the following pin assignment:

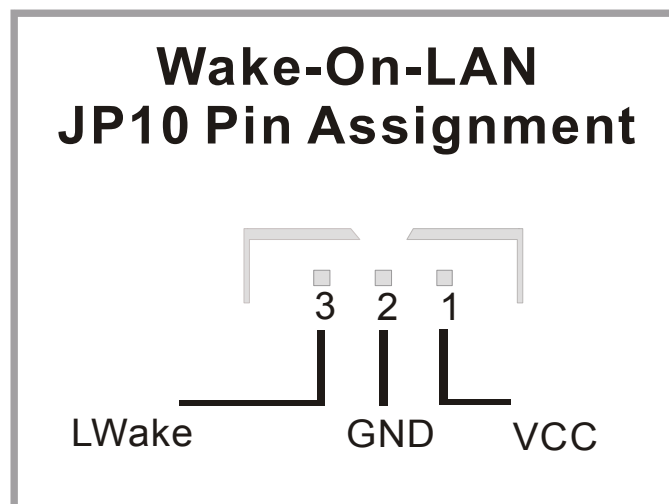

2. Standard Infrared (SIRCON)

Plug the 10-pin infrared device cable to the SIRCON header.

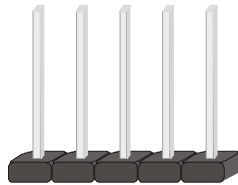

This will enable the infrared transfer function. This Motherboard meets both the ASKIR and HPSIR specifications.

Please install according to the following pin assignment:

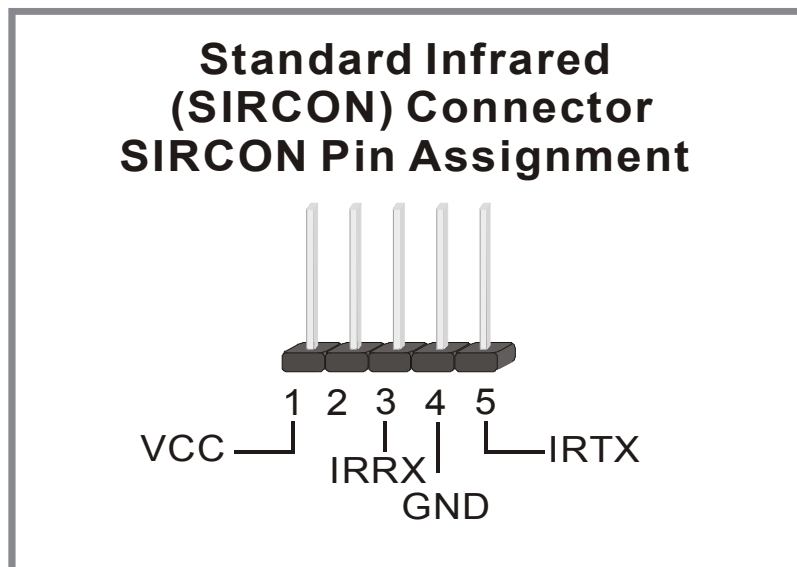

3. Cooling Fan Installation

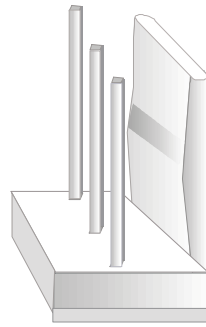

(1) CPU Cooling Fan (CPUFAN1, CPUFAN2)

After you have seated the CPU properly on the processor, attach the 3-pin fan cable to the CPUFAN connector on the Motherboard. The fan will stop when the system enters into Suspend Mode. (Suspend mode can be enabled from the BIOS Setup Utility, [POWER MANAGEMENT] menu.)

To avoid damage to the system, install according to the following pin assignment:

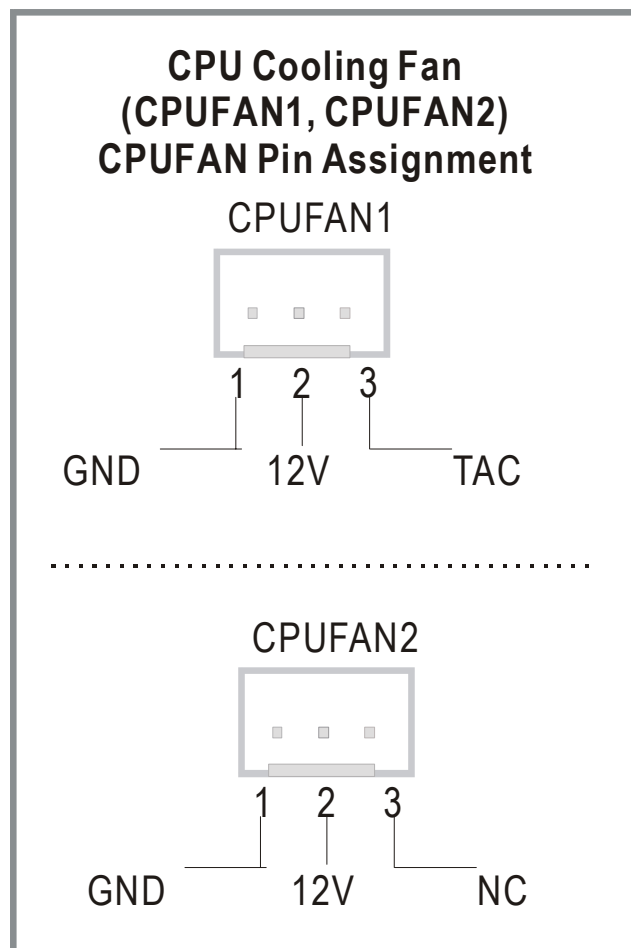

(2) Chassis Cooling Fan (CHAFAN1, CHAFAN2, CHAFAN3)

Some chassis also feature a cooling fan. This Motherboard features a CHAFAN connector to provide 12V power to the chassis fan. Connect the cable from the chassis fan to the CHAFAN 3-pin connector. Install according to the following pin assignment:

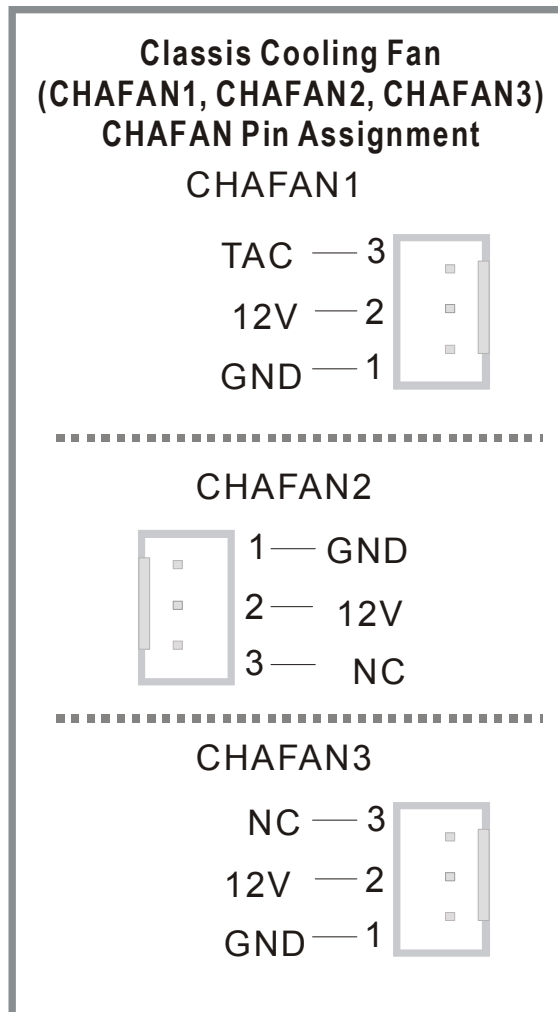

Note: CPUFAN must be installed for this Motherboard, CHAFAN is optional.

4. CD Line-in (CDIN1,CDIN2)

This Motherboard provides one CD-Line in connectors. Please connect the 4-pin audio cable from your CD-ROM drive to either CDIN2. (It fits in only one, depending on the cable that came with your CD-ROM drive)

Please install according to the following pin assignment:

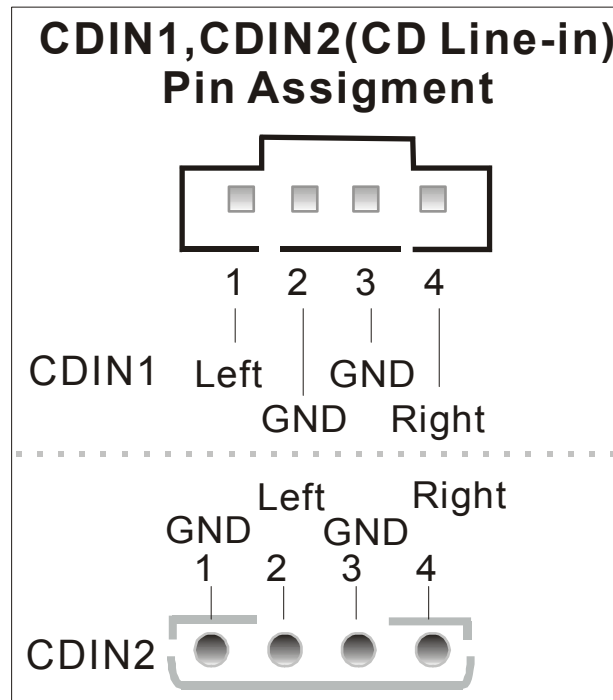

5. SPK5(optional)

Connect one end of the Audio flat cable to SPK5 connector in the motherboard, and the other end to the small audio connector. (See unpacking the motherboard in Chapter 1 for more info on the audio flat cable)

Please refer to Appendix B C-Media sound solution for more information on AUDIO function.

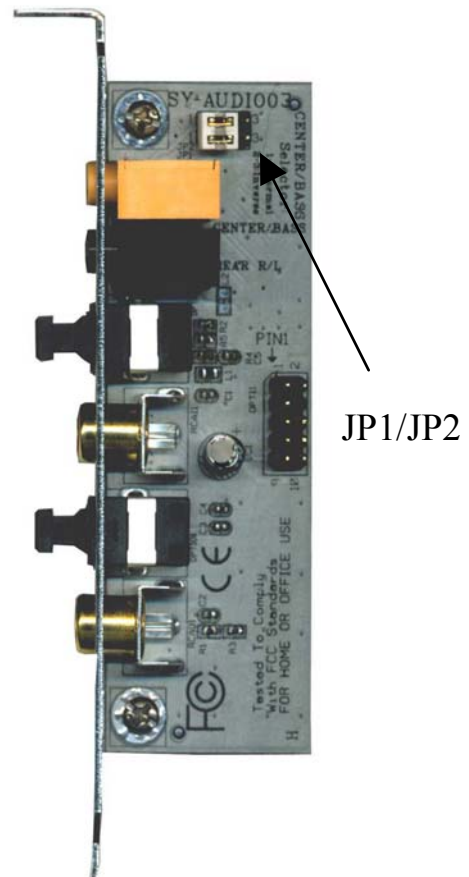
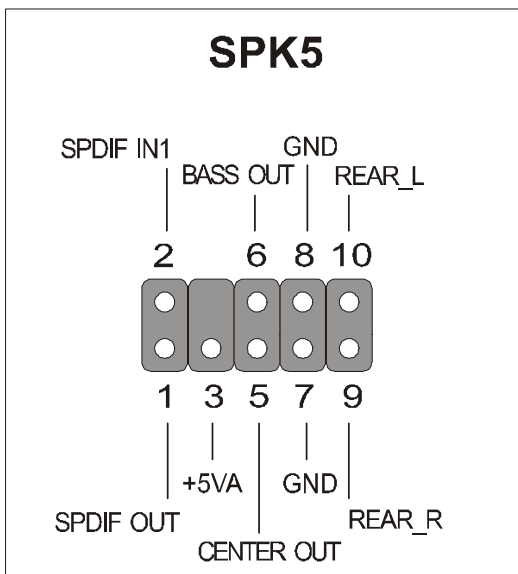

Note: Some 5.1 speaker have different center/base assignment. Please use the C-media Multi-Channel Audio demo software to check if sounds coming from the center/base speaker are correct. If not, short pin 2-3 of JP1 and JP2.

6. MIC & LED Connector (J30)

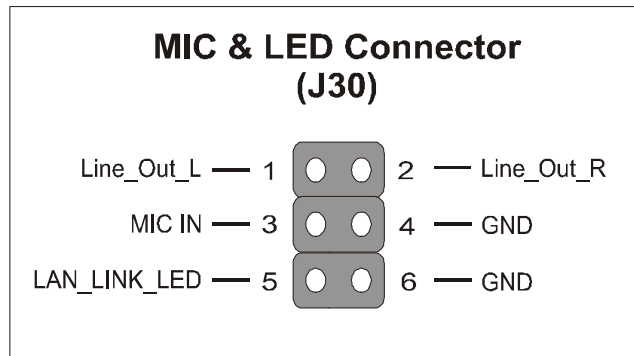

You can connect the Line-out /MIC in/LAN LED to the front panel of your PC case. (If this option is available in your PC case.)

F. ATX Power Supply

Use power supply specifically for P4 M/B. (ATX 12V power supply)

The ATX12V power supply includes a 20-pin ATX connector that comply with the ATX specification, Version 2.03 for M/B specification, a new 4-pin receptacle/header combination--the +12V power connector--has been defined. The presence of the +12V power connector indicates that a power supply is ATX12V; the absence of the +12V power connector indicates that a supply is ATX. To allow for greater than +3.3V current, the Aux power connector is recommended for ATX and ATX12V power supplies with +3.3V current >18A.

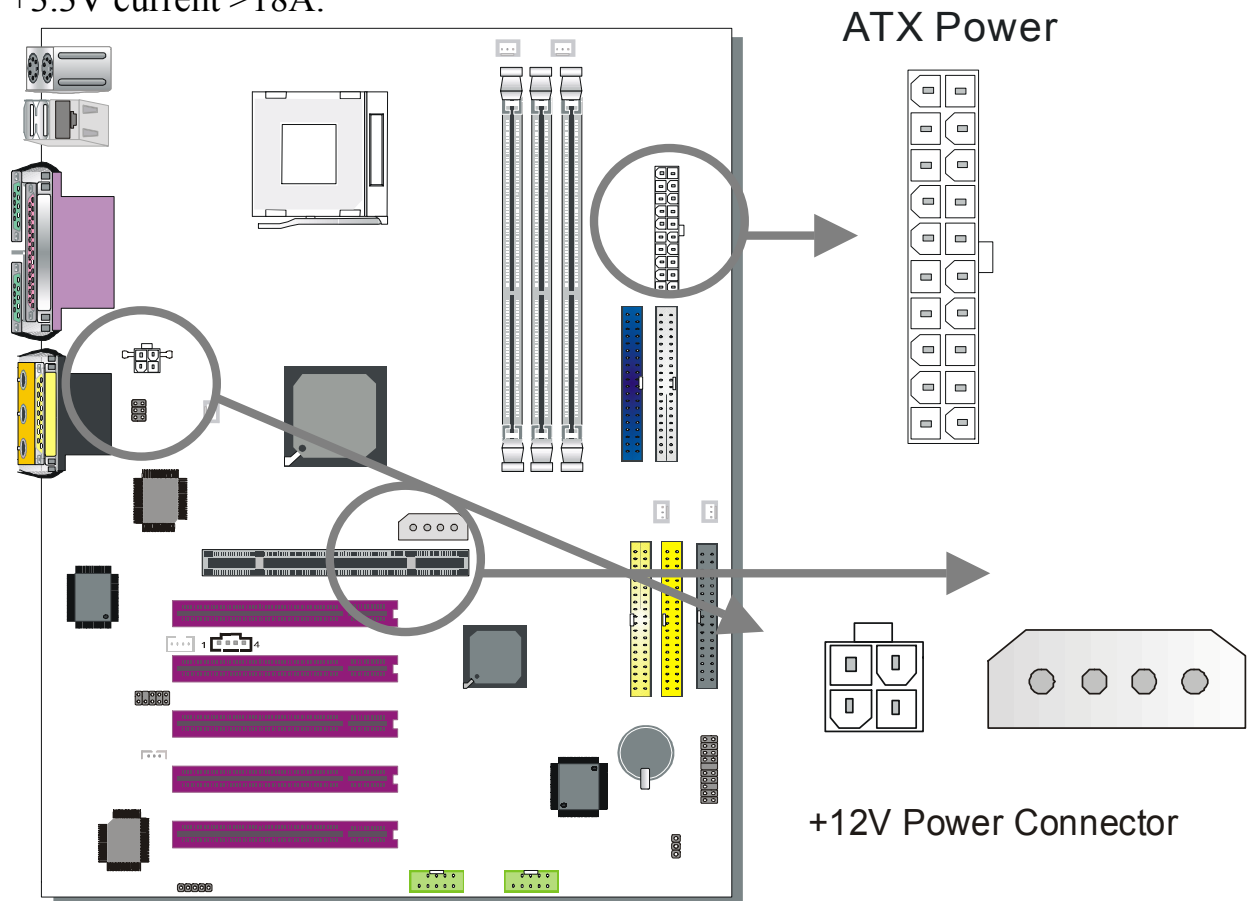



Warning: Follow these precautions to preserve your Motherboard from any remnant currents when connecting to ATX power supply: **Turn off the power supply and unplug the power cord of the ATX power supply before connecting to ATX PW connector.**

The Motherboard requires a power supply with at least 250 Watts and a "power good" signal. Make sure the ATX power supply can take at 1.5 A max current * load on the 5V Standby lead (5VSB) to meet the standard ATX specification.

Note:

- ATX 12V power supply is different from the normal ATX power supply.
- If you use the Wake-On-LAN (WOL) function, make sure the ATX power supply can support at least 720 mA on the 5V Standby lead (5VSB).

Please install the ATX power according to the following pin assignment:

ATX Power

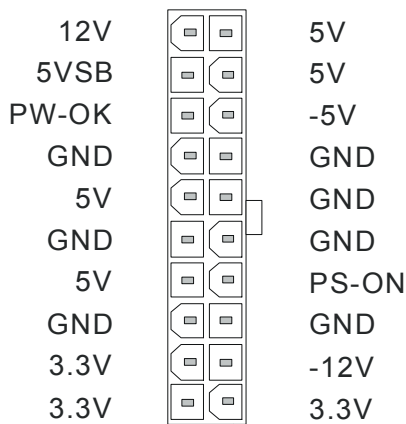

➤ **Pay special care to the directionality.**

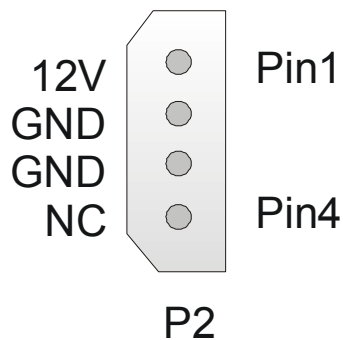
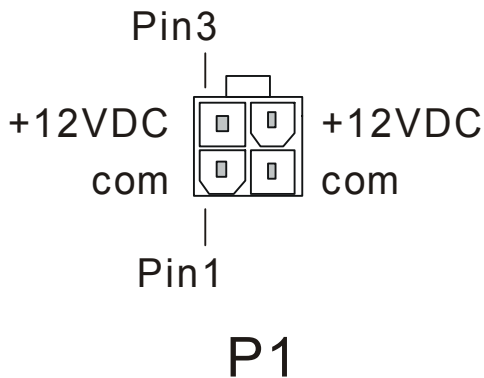

G. CMOS Clear (JP5)

In some cases the CMOS memory may contain wrong data, follow the steps below to clear the CMOS memory.

1. Clear the CMOS memory by momentarily shorting pin 2-3 on jumper JP5. This jumper can be easily identified by its white colored cap.
2. Then put the jumper back to 1-2 to allow writing of new data into the CMOS memory.

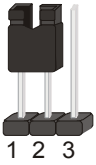
CMOS Clearing	Clear CMOS Data	Retain CMOS Data
JP5 Setting	Short pin 2-3 for at least 5 seconds to clear the CMOS 	Short pin 1-2 to retain new settings 
<i>Note: You must unplug the ATX power cable from the ATX power connector when performing the CMOS Clear operation.</i>		

Step 5 Power On

You have now completed the hardware installation of your Motherboard successfully.

1. Turn the power on
2. To enter the BIOS Setup Utility, press the key while the system is performing the diagnostic checks,



Note: If you have failed to enter the BIOS, wait until the boot up sequence is completed. Then push the RESET button and press key again at the beginning of boot-up, during diagnostic checks.

Repeat this operation until you get the following screen.

3. The BIOS Setup screen appears:

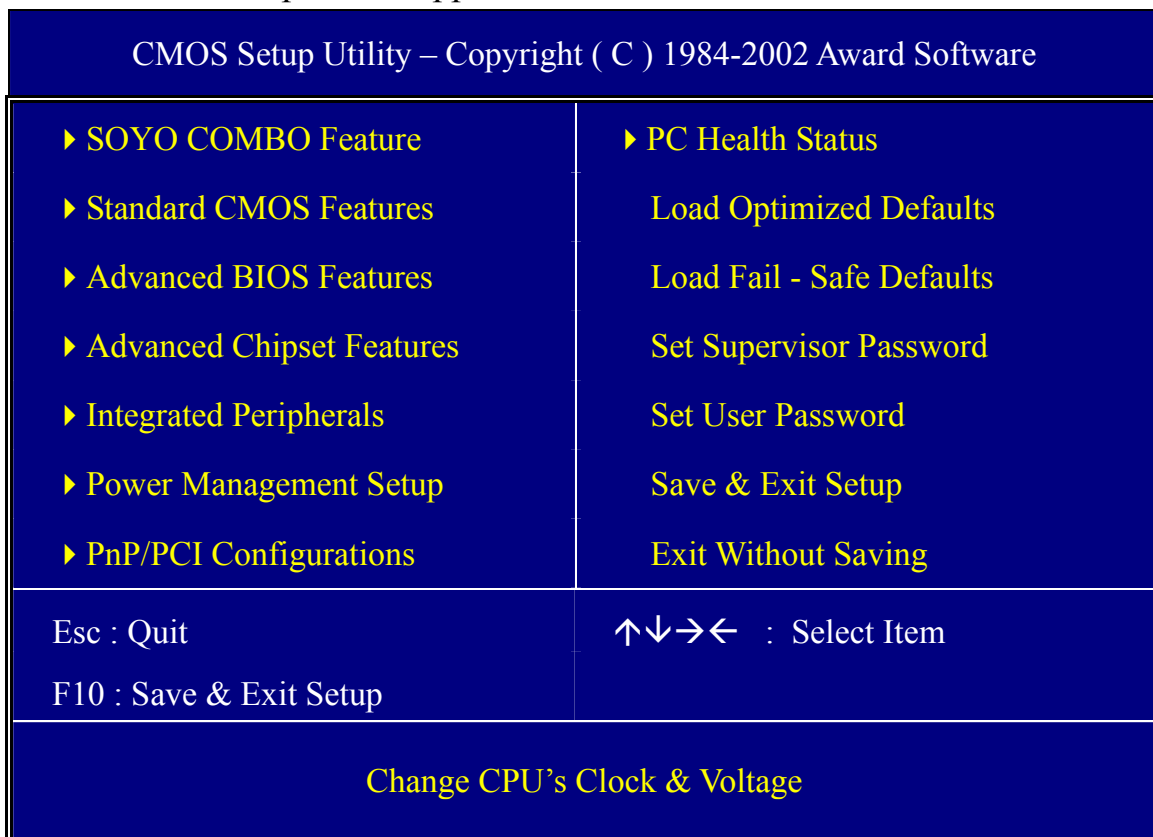

2-3 QUICK BIOS SETUP

This Motherboard does not use any hardware jumpers to set the CPU frequency. Instead, CPU settings are software configurable with the BIOS [SOYO COMBO FEATURE]. The [SOYO COMBO FEATURE] combines the main parameters that you need to configure, all in one menu, for a quick setup in BIOS.

After the hardware installation is complete, turn the power switch on, then press the key during the system diagnostic checks to



enter the Award BIOS Setup program. The CMOS SETUP UTILITY will be shown on the screen. Then, follow these steps to configure the CPU settings.

Step 1. Select [STANDARD CMOS FEATURE]

Set [Date/Time] and [Floppy drive type], then set [Hard Disk Type] to “Auto”.

Step 2. Select [LOAD OPTIMIZED DEFAULTS]

Select the “LOAD OPTIMIZED DEFAULTS” menu and type “Y” at the prompt to load the BIOS optimal setup.

Step 3. Select [SOYO COMBO FEATURE]

Move the cursor to the [CPU Frequency Select], [CPU Ratio] field to set CPU Clock/Ratio.

Note: Set the [CPU Frequency Select] field to “Manual”, to be able to change the CPU frequency 1 MHz stepping..

Step 4. Select [SAVE & EXIT SETUP]

Press <Enter> to save the new configuration to the CMOS memory, and continue the boot sequence.

You are now ready to configure your system with the BIOS setup program. Go to *Chapter 3: BIOS SETUP*

Chapter 3

BIOS SETUP UTILITY

This Motherboard's BIOS setup program uses the ROM PCI BIOS program from Award Software Inc.

To enter the Award BIOS program's Main Menu:

1. Turn on or reboot the system.
2. After the diagnostic checks, press the [Del] key to enter the Award BIOS Setup Utility.

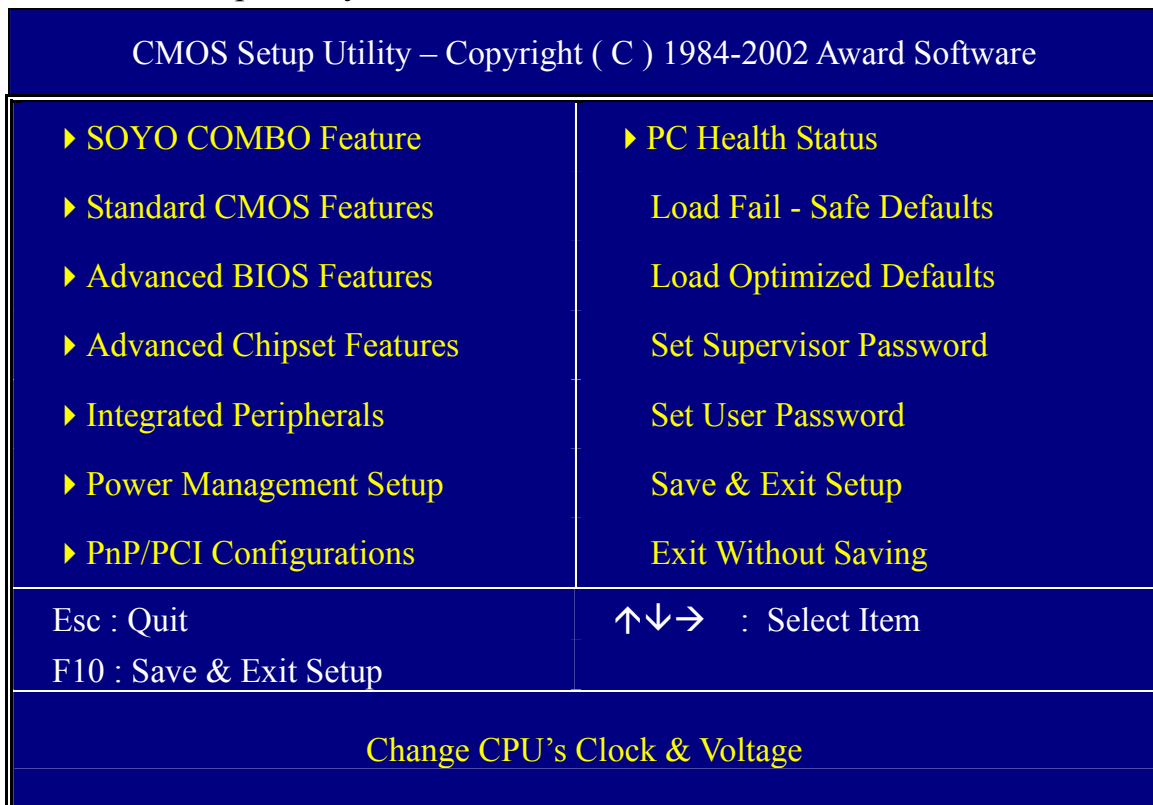

Selecting items

- Use the arrow keys to move between items and select fields.
- From the Main Menu press arrow keys to enter the selected submenu.

Modifying selected items

- Use the [Up]/[Down] keys to modify values within the selected fields. Some fields let you enter values directly.



Hot Keys: Function keys give you access to a group of commands throughout the BIOS utility.

Function	Command	Description
F1	General Help	Gives the list of options available for each item.
F5	Previous Values	Restore the old values. These are the values that the user started the current session with.
F6	Load Fail-Safe Defaults	Loads all items with the most conservative values.
F7	Load Optimized Defaults	Loads all options with the optimize values.
F10	Save	Saves your changes and reboots the system.
[Esc]	Exit	Returns at anytime and from any location to the Main Menu.
[Enter]	Select	Will display a overlapping window with all options for the current item.
[+/-/PU/PD]	Value	Using the +, -, Page Up and Page Down keys the user can toggle the value of the current item.

SAVE AND EXIT SETUP

Select the [SAVE & EXIT SETUP] option from the Main Menu to save data to CMOS and exit the setup utility. This option saves all your changes and causes the system to reboot.

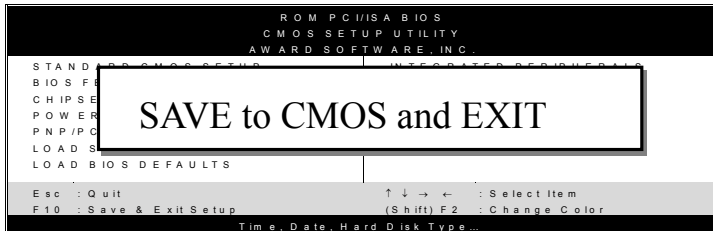

Type [Y] to save the changes and exit or [N] to return to the Main Menu and keep current values.

EXIT WITHOUT SAVING

Selecting the [EXIT WITHOUT SAVING] option allows you to abandon all data and exit setup, therefore ignoring all your changes.

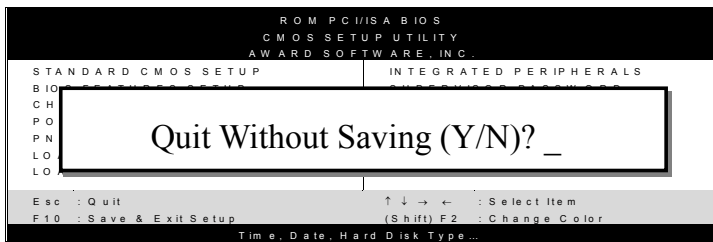

Type [Y] to abandon changes and exit or [N] to return to the Main Menu and keep current values.

3-1 SOYO COMBO SETUP

This Motherboard does not use any hardware jumpers to set the CPU frequency. Instead, CPU settings are software configurable with the BIOS [SOYO COMBO SETUP].

After the hardware installation is complete, turn the power switch on, then press the key during the system diagnostic checks to enter the Award BIOS Setup program. The CMOS SETUP UTILITY will display on screen. Then, select the [SOYO COMBO SETUP] option from the main menu and press the <Enter> key.

CMOS Setup Utility – Copyright (C) 1984-2002 Award Software SOYO COMBO Feature					
System Performance	Normal	Item Help Menu Level ▶			
Frequency 1MHz Stepping	100 MHz				
CPU Ratio Select	8X				
DRAM Clock	By SPD				
Auto Detect PCI/Dimm Clk	Disabled				
Spread Spectrum	Disabled				
CPU Vcore Select	Default				
AGP(1.5) Voltage Select	Default				
DDR(2.5) Voltage Select	Default				
▶ Advance Tune-Up Settings	Press Enter				
Onboard IDE RAID	Enabled				
Onboard 6Ch H/W Audio	Enabled				
Onboard (10/100) Lan	Enabled				
Quick Power On Self Test	Enabled				
First Boot Device	Floppy				
Second Boot Device	HDD-0				
Third Boot Device	LS120				
Boot Other Device	Enabled				
RAID/ATA & SCSI Boot Order	RAID/ATA,SCSI				
↑↓→ Move	Enter:Select	+/-/PU/PD:Value	F10:Save	ESC:Exit	F1:General Help
F5:Previous Values		F6:Fail-Safe Defaults		F7: Optimized Defaults	

The [SOYO COMBO SETUP] menu combines the main parameters that you need to configure, all in one menu, for a quick setup in BIOS.



System Performance

	Setting	Description	Note
System Performance	Normal	Adjust your computer performance.	Default
	Fast		
	Turbo		

SOYO COMBO Feature

	Setting	Description	Note
Frequency 1MHz Stepping	100 MHz ~ 132 MHz	Press “Page Up” / “Page Down” key to Over Clock the CPU Front Side Bus in 1MHz increment or Press “Enter” key, then type the desired CPU Front Side Bus.	
CPU Clock Ratio	Auto	The available CPU ratio you can select will depends on your CPU ID.	Default
	10X ~ 24X		
DRAM Clock	By SPD	This item allows you to control the DRAM speed.	Default
	100 MHz		
	133 MHz		
	166 MHz		
	200 MHz		
Auto Detect PCI/DIMM Clk	Disabled	When enabled, this item will auto detect if the DIMM and PCI socket have devices and will send clock signal to DIMM and PCI devices. When disabled, it will send the clock signal to all DIMM and PCI socket.	Default
	Enabled		
Spread Spectrum	Disabled	This item allows you to Disabled / Enabled the spread spectrum modulate.	Default
	Enabled		

CPU Vcore Select

	Setting	Description	Note
CPU Vcore Select	Default	This function adjust the CPU voltage.	Default
	1.100V, 1.125V,		
	1.150V, 1.175V,		
	1.200V, 1.225V,		
	1.250V, 1.275V,		
	1.300V, 1.325V,		
	1.350V, 1.375V,		
	1.400V, 1.425V,		
	1.450V, 1.475V,		
	1.500V, 1.525V,		
	1.550V, 1.575V,		
	1.600V, 1.625V,		
	1.650V, 1.675V,		
	1.700V, 1.725V,		
	1.750V, 1.775V,		
1.800V, 1.825V,			
1.850V			

AGP Voltage Adjust

	Setting	Description	Note
AGP (1.5V) Voltage Select	Default	This function allow to adjust the AGP voltage.	Default
	1.6V		
	1.7V		
	1.8V		

DDR Voltage Adjust

	Setting	Description	Note
DDR (2.5V) Voltage Select	Default	This function allow to adjust the DDR voltage.	Default
	2.6V		
	2.7V		
	2.8V		

Onboard IDE RAID

	Setting	Description	Note
Onboard IDE RAID	Enabled	Enabled/Disabled Onboard IDE RAID.	Default
	Disabled		

**Onboard 6Ch H/W Audio**

	Setting	Description	Note
Onboard 6Ch H/W Audio	Enabled	Enabled/Disabled Onboard 6Ch H/W Audio.	Default
	Disabled		

Onboard (10/100) LAN

	Setting	Description	Note
Onboard (10/100) LAN	Enabled	Enabled/Disabled Onboard LAN.	Default
	Disabled		

Quick Power On Self Test

	Setting	Description	Note
Quick Power On Self Test	Disabled		
	Enabled	Provides a fast POST at boot-up.	Default



System Boot Control Settings

	Setting	Description	Note
First /Second/Third Boot Device	Floppy	Select Your Boot Device Priority	
	LS120		
	HDD-0		
	SCSI		
	CDROM		
	HDD-1		
	HDD-2		
	HDD-3		
	ZIP100		
	USB-FDD		
	USB-ZIP		
	USB-CDROM		
	USB-HDD		
	LAN		
	Disabled		
Boot Other Device	Disabled	Select Your Boot Device Priority	
	Enabled	Select Your Boot Device Priority	Default
RAID/ATA & SCSI Boot Order	RAID/ATA, SCSI	Select Your RAID/ATA & SCSI Boot Device Priority.	Default
	SCSI, RAID/ATA		

3-1.1 Advance Turn-up Settings



Caution: Change these settings only if you are already familiar with the Chipset.

The [Advanced Turn-up Settings] option changes the values of the chipset registers. These registers control the system options in the computer.

CMOS Setup Utility – Copyright (C) 1984-2002 Award Software Advance Turn-up Settings														
Current FSB Frequency	100 MHz	Item Help												
Current DRAM Frequency	133 MHz													
DRAM Timing	By SPD													
x SDRAM CAS Latency	3													
x Bank Interleave	Disabled													
x Precharge to Active (Trp)	3T													
x Active to precharge (Tras)	7T													
x Active to CMD (Trcd)	3T													
x DRAM Command Rate	2T Command													
DRAM Burst Len	4													
Write Recovery Time	3T													
Dram Access Time	3T													
<table border="0"> <tr> <td>↑↓→:Move</td> <td>Enter:Select</td> <td>+/-/PU/PD:Value</td> <td>F10:Save</td> <td>ESC:Exit</td> <td>F1:General Help</td> </tr> <tr> <td colspan="2">F5:Previous Values</td> <td colspan="2">F6:Fail-Safe Defaults</td> <td colspan="2">F7: Optimized Defaults</td> </tr> </table>			↑↓→:Move	Enter:Select	+/-/PU/PD:Value	F10:Save	ESC:Exit	F1:General Help	F5:Previous Values		F6:Fail-Safe Defaults		F7: Optimized Defaults	
↑↓→:Move	Enter:Select	+/-/PU/PD:Value	F10:Save	ESC:Exit	F1:General Help									
F5:Previous Values		F6:Fail-Safe Defaults		F7: Optimized Defaults										

After you have completed the changes, press [Esc] and follow the instructions on your screen to save your settings or exit without saving.

DRAM Timing/Drive Control

	Setting	Description	Note
DRAM Timing	By SPD	If enable the DRAM will auto detect the DRAM timing.	Default
	Manual		
SDRAM CAS Latency	2.5	When synchronous DRAM is installed, the number of clock cycles of CAS latency depends on the DRAM timing. Do not reset this field from the default value specified by the system designer.	Default
	2		
Bank Interleave	Disabled	Increase DRAM performance.	Default
	2 Bank		
	4 Bank		
Precharge to Active(Trp)	2T	Increase DRAM performance.	
	3T		Default
Active to Precharge(Tras)	6T	Increase DRAM performance.	
	7T		Default
Active to CMD(Trcd)	3T	Increase DRAM performance.	Default
	2T		
DRAM Command Rate	1T Command	Increase DRAM performance.	
	2T Command		Default
DRAM Burst Len	4	Increase DRAM performance.	Default
	8		

3-2 STANDARD CMOS SETUP

Select the [STANDARD CMOS SETUP] option from the Main Menu and press [Enter] key.

CMOS Setup Utility – Copyright (C) 1984-2002 Award Software Standard CMOS Features		
Date (mm:dd:yy) Time (hh:mm:ss)	Mon, Jan 1 2002 1 : 1 : 8	Item Help
▶ IDE Primary Master ▶ IDE Primary Slave ▶ IDE Secondary Master ▶ IDE Secondary Slave	None None None None	Menu Level ▶ Change the day, month, year and century.
Drive A Drive B Floppy 3 Mode Support	1.44M, 3.5 in. None Disabled	
Video Halt On	EGA/VGA All Errors	
Base Memory Extended Memory Total Memory	640K 130048K 131072K	
↑↓→ Move	Enter:Select	+/-/PU/PD:Value
F5:Previous Values	F6:Fail-Safe Defaults	F10:Save
		ESC:Exit
		F1:General Help
		F7: Optimized Defaults

This screen allows you to modify the basic CMOS settings.

After you have completed the changes, press [Esc] key to return to the Main Menu.

This Main Menu function automatically detects the hard disk type and configures the [Standard CMOS Features] accordingly.

CMOS Setup Utility – Copyright (C) 1984-2002 Award Software
IDE Primary Master

IDE HDD Auto-Detection IDE Primary Master Access Mode Capacity Cylinder Head Precomp Landing Zone Sector	Press Enter Auto Auto 0 MB 0 0 0 0 0	Item Help Menu Level ▶ To auto-detect the HDD's size, head... on this channel
--	--	--

↑↓→:Move	Enter:Select	+/-/PU/PD:Value	F10:Save	ESC:Exit	F1:General Help
F5:Previous Values	F6:Fail-Safe Defaults	F7: Optimized Defaults			



Note: This function is only valid for IDE type of hard disk drives.

Date & Time

	Display	Setting	Please Note
Date	mm/dd/yyyy	Type the current date	You can also the PUp/PDn keys to toggle
Time	hh:mm:ss	Type the current time	24-hour clock format 3:15 PM is displayed as 15:15:00

Hard Disks Type & Mode

Choose the type and mode for the hard disks that you have already installed.

Primary (Secondary) Master & Slave	Setting	Description	Note
IDE HDD Auto-Detection	Press Enter	To auto-detect the HDD's size, head... on this channel	
IDE Primary Slave (User Type)	Auto	BIOS detects hard disk type automatically.	Default
	User	User defines the type of hard disk.	
	None		
Access Mode	CHS	Normal IDE hard disk	<528MB
	LBA	Enhanced IDE hard disk	>528MB
	Large	Large IDE hard disk (for certain hard disk)	
	Auto	BIOS detects hard disk mode automatically.	Default



Note: If you have any questions on your hard disk type or mode, ask your hard disk provider or previous user for details.

Floppy Drives

Floppy Drives	Setting	Description	Note
Drives A	360KB, 5.25 in.		Default
	1.2MB, 5.25 in.		
	720KB, 3.5 in.		
	1.44MB, 3.5 in.		
	2.88MB, 3.5 in.		
	None	Not installed	
Floppy 3-Mode Support	Disabled		Default
	Drive A, Drive B, Both	Supports 3-mode floppy diskette: 740KB/1.2MB/ 1.44MB on selected disk drive.	Special disk drive commonly used in Japan

**Others Optional**

	Setting	Description	Note
Video	EGA/VGA	Select the video mode.	Default
	CGA 40		
	CGA 80		
	MONO (Monochrome)		
Halt On	ALL Errors	When the BIOS detects system errors, this function will stop the system. Select which type of error will cause the system halt.	Default
	No Errors		
	All, But Keyboard		
	All, But Diskette		
	All, But Disk/Key		

3-3 ADVANCED BIOS FEATURES

Select the [Advanced BIOS Features] option from the Main Menu and press [Enter] key.

CMOS Setup Utility – Copyright (C) 1984-2002 Award Software
 Advanced BIOS Features

Virus Warning CPU L1 & L2 Cache CPU L2 Cache ECC Chicking Swap Floppy Drive Boot Up Floppy Seek Boot Up NumLock Status Gate A20 Option Typematic Rate Setting x Typematic Rate (Chars/Sec) x Typematic Delay (Msec) Security Option APIC Mode x MPS Version Control For OS OS Select For DRAM > 64MB HDD S.M.A.R.T. Capability Video BIOS Shadow Full Screen LOGO Show EPA LOGO SELECT Small Logo (EPA) Show	Disabled Enabled Enabled Disabled Enabled On Fast Disabled 6 250 Setup Enabled 1.1 Non-OS2 Disabled Enabled Enabled LOGO-0 Enabled	<table border="1" style="width: 100%; border-collapse: collapse;"> <tr> <th style="text-align: center;">Item Help</th> </tr> <tr> <td> Menu Level ▶ Allows you to choose the VIRUS warning feature for IDE Hard Disk boot sector protection. If this function is enabled and someone attempt to write data into this area, BIOS will show a warning message on screen and alarm beep. </td> </tr> </table>	Item Help	Menu Level ▶ Allows you to choose the VIRUS warning feature for IDE Hard Disk boot sector protection. If this function is enabled and someone attempt to write data into this area, BIOS will show a warning message on screen and alarm beep.
Item Help				
Menu Level ▶ Allows you to choose the VIRUS warning feature for IDE Hard Disk boot sector protection. If this function is enabled and someone attempt to write data into this area, BIOS will show a warning message on screen and alarm beep.				

↑↓→ Move	Enter:Select	+/-/PU/PD:Value	F10:Save	ESC:Exit	F1:General Help
F5:Previous Values	F6:Fail-Safe Defaults	F7: Optimized Defaults			

After you have completed the changes, press [Esc] key and follow the instructions on your screen to save your settings or exit without saving.

Virus Warning

	Setting	Description	Note
Virus Warning	Disabled	If set to enabled, the Paragon Anti-Virus. Function will scan your boot drive for boot virusses. If a boot virus is detected, the BIOS will display a warning message.	Default
	Enabled		

Cache Memory Options

	Setting	Description	Note
CPU L1 & L2 Cache	Disabled		
	Enabled	Enables the CPU's L1 & L2 cache.	Default
Swap Floppy Drive	Disabled		Default
	Enabled		

Boot Up Floppy Seek

	Setting	Description	Note
Boot Up Floppy Seek	Disabled	Seeks disk drives during boot up. Disabling speeds boot up.	
	Enabled		Default

Boot Up NumLock Status

	Setting	Description	Note
Boot Up NumLock Status	On	Puts numeric keypad in NumLock mode at boot-up.	Default
	Off	Puts numeric keypad in arrow key mode at boot-up.	

Gate A20 Options

	Setting	Description	Note
Gate A20 Options	Normal	Lets chipset control GateA20.	
	Fast	A pin in the keyboard controller controls GateA20.	Default

Typematic Settings

Typematic Settings	Setting	Description	Note
Typematic Rate Setting	Disabled	Keystrokes repeat at a rate determined by the keyboard.	Default
	Enabled	When enabled, the typematic rate and typematic delay can be selected.	
The following [Typematic Rate] and [Typematic Delay] fields are active only if [Typematic Rate Setting] is set to [Enabled]			
Typematic Rate (Chars/sec)	6 (Char/sec)	Choose the rate at which a character is repeated when holding down a key.	Default
	8 (Char/sec)		
	10 (Char/sec)		
	12 (Char/sec)		
	15 (Char/sec)		
	20 (Char/sec)		
	30 (Char/sec)		
Typematic Delay (Msec)	250 (msec)	Choose how long after you press a key down the character begins repeating.	Default
	500 (msec)		
	750 (msec)		
	1000 (msec)		

Security Option

Use this feature to prevent unauthorized system boot-up or use of BIOS Setup. The following table describes the security settings.

	Setting	Description	Note
Security Option	Setup	If a password is set, the password prompt only appears when you attempt to enter the BIOS Setup program.	Default
	System	Each time the system is booted, the password prompt appears.	

Security Option(Continue)

	Setting	Description	Note
ACPI Mode	Disabled	Enabled the Advanced Programmable Interrupt Controller (APIC) mode.	Default
	Enabled		
MPS Version Control for OS	1.1	Allows you to choose the Multi Processor Specification (MPS) version.	Default
	1.4		

Other Control Options

	Setting	Description	Note
OS Select for DRAM>64MB	OS2	When using an OS2 operating system.	Default
	Non-OS2	When using another, non-OS2 operating system.	
HDD S.M.A.R.T. Capability	Disabled	Enabled this field when your HDD supports the S.M.A.R.T. function. Consult your HDD provider for details.	Default
	Enabled		
Video BIOS Shadow	Disabled	The BIOS is shadowed in a 16K segment if it is enabled and if it has BIOS present. These 16 segments can be shadowed from ROM to RAM. BIOS shadow copies BIOS code from slower ROM to faster RAM. BIOS can then execute from RAM.	Default
	Enabled		
Full Screen LOGO Show	Disabled	Set Enabled to Show Logo (Dragon).	Default
	Enabled		
EPA LOGO SELECT	LOGO-0	Allows user to display SOYO logo or own logo. Logo-0 Shows SOYO logo. Logo-1 Shows user logo (Default Blank).	Default
	LOGO-1		
Small Logo(EPA) Show	Disabled	Set Enabled to Show Logo(EPA).	Default
	Enabled		

3-4 ADVANCED CHIPSET FEATURES

Select the [Advanced Chipset Features] option from the Main Menu and press [Enter] key.



Caution: Change these settings only if you are already familiar with the Chipset.

The [Advanced Chipset Features] option changes the values of the chipset registers. These registers control the system options in the computer.

CMOS Setup Utility – Copyright (C) 1984-2002 Award Software
 Advanced Chipset Features

▶ AGP & P2P Bridge Control ▶ CPU & PCI Bus Control System BIOS Cacheable Video RAM Cacheable	Press Enter Press Enter Disabled Disabled	Item Help Menu Level ▶
---	--	---------------------------

↑↓→Move	Enter:Select	+/-/PU/PD:Value	F10:Save	ESC:Exit	F1:General Help
F5:Previous Values		F6:Fail-Safe Defaults			F7: Optimized Defaults

After you have completed the changes, press [Esc] and follow the instructions on your screen to save your settings or exit without saving.

The following table describes each field in the Advanced Chipset Features Menu and how to configure each parameter.

CHIPSET FEATURES SETUP

	Setting	Description	Note
System BIOS Cacheable	Disabled		Default
	Enabled	The ROM area F0000H-FFFFFFH is cacheable.	
Video RAM Cacheable	Disabled	When synchronous DRAM is installed, the number of clock cycles of CAS latency depends on the DRAM timing. Do not reset this field from the default value specified by the system designer	Default
	Enabled		

3-4.1 AGP & P2P Bridge Control



Caution: Change these settings only if you are already familiar with the Chipset.

The [AGP & P2P Bridge Control] option changes the values of the chipset registers. These registers control the system options in the computer.

CMOS Setup Utility – Copyright (C) 1984-2002 Award Software
 AGP & P2P Bridge Control

AGP Aperture Size AGP Mode AGP Driving Control x AGP Driving Value AGP Fast Write AGP Master 1 WS Write AGP Master 1 WS Read DBI Output for AGP Trans	64M 4X Auto DA Enabled Disabled Disabled Disabled	Item Help Menu Level ▶
--	--	---------------------------

↑↓→:Move	Enter:Select	+/-/PU/PD:Value	F10:Save	ESC:Exit	F1:General Help
F5:Previous Values	F6:Fail-Safe Defaults	F7: Optimized Defaults			

After you have completed the changes, press [Esc] and follow the instructions on your screen to save your settings or exit without saving.

AGP & P2P Bridge Control

	Setting	Description	Note
AGP Aperture Size	256M	Select the size of Accelerated Graphics Port (AGP) aperture. The aperture is a portion of the PCI memory address range	
	128M		
	64M		Default
	32M		
AGP Mode	1X	This item allows you to your AGP mode, if 8X AGP Card is used, this option will disappear.	
	2X		
	4X		Default



AGP & P2P Bridge Control (Continue)

	Setting	Description	Note
AGP Driving Control	Auto	This item allows you to adjust the AGP driving force. Choose <i>Manual</i> to key in a AGP Driving Value in the next selection. This field is recommended to set in Auto for avoiding any error in your system.	Default
	Manual		
AGP Driving Value	Min=0000 ~ Max=00FF	This item allows you to adjust the AGP driving force.	
AGP Fast Write	Disabled	Enabled/Disabled AGP fast write capability.	Default
	Enabled		
AGP Master 1 WS Write	Disabled	When <i>Enabled</i> , writes to the AGP(Accelerated Graphics Port) are executed with one wait states.	Default
	Enabled		
AGP Master 1 WS Read	Disabled	When <i>Enabled</i> , read to the AGP (Accelerated Graphics Port) are executed with one wait states.	Default
	Enabled		
DBI Output for AGP Trans	Disabled	This option will appear if 8X AGP Card is used.	Default
	Enabled		

3-4.2 CPU & PCI Bus Control



Caution: Change these settings only if you are already familiar with the Chipset.

The [CPU & PCI Bus Control] option changes the values of the chipset registers. These registers control the system options in the computer.

CMOS Setup Utility – Copyright (C) 1984-2002 Award Software
CPU & PCI Bus Control

CPU to PCI Write Buffer PCI Master 0 WS Write PCI Delay Transaction VLink 8X Support	Enabled Enabled Disabled Enabled	Item Help Menu Level ▶
---	---	---------------------------

↑↓→:Move	Enter:Select	+/-/PU/PD:Value	F10:Save	ESC:Exit	F1:General Help
F5:Previous Values	F6:Fail-Safe Defaults	F7: Optimized Defaults			

After you have completed the changes, press [Esc] and follow the instructions on your screen to save your settings or exit without saving.

CPU & PCI Bus Control

	Setting	Description	Note
CPU to PCI Write Buffer	Disabled		
	Enabled	Enabled the CPU to PCI Write Buffer.	Default
PCI Master 0 WS Write	Disabled	This item allows you to enabled/disabled the PCI post write.	Default
	Enabled		
PCI Delay Transaction	Disabled	The chipset has an embedded 32-bit posted write buffer to support delay transactions cycles. Select <i>Enabled</i> to support compliance with PCI specification version 2.1.	Default
	Enabled		
VLink 8X Support	Disabled	Enabled item can support Quad Data Transfer interconnect to the VT8235 South Bridge.	Default
	Enabled		

3-5 INTEGRATED PERIPHERALS

Select the [Integrated Peripherals] option from the Main Menu and press [Enter] key.



Caution: Change these settings only if you are already familiar with the Chipset.

The [INTEGRATED PERIPHERALS] option changes the values of the chipset registers. These registers control the system options in the computer. The following screen shows setup default settings.

CMOS Setup Utility – Copyright (C) 1984-2002 Award Software Integrated Peripherals		
▶ VIA OnChip IDE Device	Press Enter	Item Help
▶ SuperIO Device	Press Enter	
Init Display First	AGP	Menu Level ▶
OnChip USB Controller	All Enabled	
USB Keyboard Support	Disabled	
IDE HDD Block Mode	Enabled	
↑↓→ Move	Enter:Select	+/-/PU/PD:Value
F5:Previous Values	F6:Fail-Safe Defaults	F10:Save
		ESC:Exit
		F1:General Help
		F7: Optimized Defaults

After you have completed the changes, press [Esc] and follow the instructions on your screen to save your settings or exit without saving.

INTEGRATED PERIPHERALS

	Setting	Description	Note
Init Display First	PCI Slot	Choose which card – AGP Display card or PCI VGA card – to initialize first.	
	AGP		Default



INTEGRATED PERIPHERALS (Continue)

	Setting	Description	Note
OnChip USB Controller	All Disabled	This should be enabled if your system has a USB installed on the system board and you want to use it. Even when so equipped, if you add a higher performance controller, you will need to disable this feature.	Default
	All Enabled		
USB Keyboard Support	Disabled	Select <i>Enabled</i> if your system contains a Universal Serial Bus (USB) controller and you have a USB keyboard.	Default
	Enabled		
IDE HDD Block Mode	Disabled	Invokes multi-sector transfer instead of one sector per transfer. Not all HDDs support this function.	Default
	Enabled		



3-5.1 VIA OnChip IDE Device



Caution: Change these settings only if you are already familiar with the Chipset.

The [VIA OnChip IDE Device] option changes the values of the chipset registers. These registers control the system options in the computer.

The following screen shows setup default settings.

CMOS Setup Utility – Copyright (C) 1984-2002 Award Software VIA OnChip IDE Device		
OnChip IDE Channel0	Enabled	Item Help Menu Level ▶
OnChip IDE Channel1	Enabled	
IDE Prefetch Mode	Enabled	
Primary Master PIO	Auto	
Primary Slave PIO	Auto	
Secondary Master PIO	Auto	
Secondary Slave PIO	Auto	
Primary Master UDMA	Auto	
Primary Slave UDMA	Auto	
Secondary Master UDMA	Auto	
Secondary Slave UDMA	Auto	
↑↓→:Move Enter:Select +/-/PU/PD:Value F10:Save ESC:Exit F1:General Help F5:Previous Values F6:Fail-Safe Defaults F7: Optimized Defaults		

After you have completed the changes, press [Esc] and follow the instructions on your screen to save your settings or exit without saving.

VIA OnChip IDE Device

	Setting	Description	Note
On-Chip PCI IDE ➤ Primary ➤ Secondary	Disabled	Turn off the on-board IDE.	
	Enabled	Use the on-board IDE.	Default
IDE ➤ Primary Master PIO ➤ Primary Slave PIO ➤ Secondary Master PIO ➤ Secondary Slave PIO	mode 0-4	0 is the slowest speed 4 is the fastest speed	
	Auto	For better performance and stability, we suggest you use the Auto setting to set the HDD control timing.	Default
IDE ➤ Primary Master UDMA ➤ Primary Slave UDMA ➤ Secondary Master UDMA ➤ Secondary Slave UDMA	Disabled		
	Auto	Select Auto to enable Ultra DMA Mode support.	Default

3-5.2 SuperIO Device



Caution: Change these settings only if you are already familiar with the Chipset.

The [SuperIO Device] option changes the values of the chipset registers. These registers control the system options in the computer.

The following screen shows setup default settings.

CMOS Setup Utility – Copyright (C) 1984-2002 Award Software SuperIO Device		
Onboard FDC Controller	Enabled	Item Help Menu Level ▶
Onboard Serial Port 1	3F8/IRQ4	
Onboard Serial Port 2	2F8/IRQ3	
UART Mode Select	Normal	
x RxD , TxD Active	Hi, Lo	
x IR Transmission Delay	Enabled	
x UR2 Duplex Mode	Half	
x Use IR Pins	IR-Rx2Tx2	
Onboard Parallel Port	378/IRQ7	
Parallel Port Mode	SPP	
x EPP Mode Select	EPP1.7	
x ECP Mode Use DMA	3	

↑↓→:Move	Enter:Select	+/-/PU/PD:Value	F10:Save	ESC:Exit	F1:General Help
F5:Previous Values		F6:Fail-Safe Defaults		F7: Optimized Defaults	

After you have completed the changes, press [Esc] and follow the instructions on your screen to save your settings or exit without saving.

SuperIO Device

	Setting	Description	Note
Onboard FDC controller	Disabled	Turn off the on-board floppy controller.	
	Enabled	Use the on-board floppy controller.	Default
Onboard Serial Port 1 / Serial Port 2	Disabled		
	3F8/IRQ4	Choose serial port 1 & 2's I/O address.	Default (port 1)
	2F8/IRQ3	Do not set port 1 & 2 to the same address except for Disabled or Auto.	Default (port 2)
	3E8/IRQ4		
	2E8/IRQ3		
	Auto		
UART Mode	IrDA	The second serial port offers these InfraRed interface modes.	
	ASKIR		
	Normal		Default
If [UART Mode Select] is set to [IrDA]/[ASKIR]			
UR2 Function Duplex	Half	Choose [Half] or [Duplex] to set UR2 in half duplex mode or full duplex mode respectively. Refer to your IR device specifications to select the suitable mode.	Default
	Full		
Onboard Parallel Port	Disabled	Choose the printer I/O address.	
	378/IRQ7		Default
	278/IRQ5		
	3BC/IRQ7		
Parallel Port Mode	SPP	The mode depends on your external device that connects to this port.	Default
	EPP		
	ECP		
	ECP+EPP		
	Normal		
If [Parallel Port Mode] is set to [ECP] or [ECP+EPP] mode			
EPP Mode Select	EPP1.9		
	EPP1.7		Default
ECP Mode use DMA	3	Choose DMA3	Default
	1	Choose DMA1	

3-6 POWER MANAGEMENT SETUP

The [POWER MANAGEMENT SETUP] sets the system's power saving functions.

CMOS Setup Utility – Copyright (C) 1984-2002 Award Software
Power Management Setup

ACPI Suspend Type	S1 (POS)	Item Help Menu Level ▶
Power Management Option	User Define	
HDD Power Down	Disable	
Suspend Mode	Disable	
Video Off Option	Suspend -> Off	
Video Off Method	V/H SYNC+Blank	
MODEM Use IRQ	3	
Soft-Off by PWRBTN	Instant-Off	
Run VGABIOS if S3 Resume	Auto	
PWRON After PWR-Fail	Off	
▶ IRQ/Event Activity Detect	Press Enter	

↑↓→ Move Enter:Select +/-/PU/PD:Value F10:Save ESC:Exit F1:General Help
 F5:Previous Values F6:Fail-Safe Defaults F7: Optimized Defaults

CMOS Setup Utility – Copyright (C) 1984-2002 Award Software
IRQ/Event Activity Detect

PS2KB Wakeup Select	Hot key	Item Help Menu Level ▶
PS2KB Wakeup from S3/S4/S5	Disabled	
VGA	OFF	
LPT & COM	LPT/COM	
HDD & FDD	ON	
PCI Master	OFF	
PowerOn by PCI Card	Disabled	
Modem Ring Resume	Disabled	
RTC Alarm Resume	Disabled	
x Date (of Month)	0	
x Resume Time (hh:mm:ss)	0 : 0 : 0	
▶ IRQs Activity Monitoring	Press Enter	

↑↓→ Move Enter:Select +/-/PU/PD:Value F10:Save ESC:Exit F1:General Help
 F5:Previous Values F6:Fail-Safe Defaults F7: Optimized Defaults

After you have completed the Power Management Setup, press [Esc] to return to the Main Menu.

Power Management Controls

	Setting	Description	Note
ACPI Suspend Type	S1(POS)	The system will enter the S1 state during suspend. (Low latency wake up)	Default
	S3(STR)		
	S1 & S3		
Power Management Option	User Define	Lets you define the system power down times.	Default
	Min Saving		15 Min
	Max Saving		1 Min
HDD Power Down	Disabled	Lets you define the system power down times.	Default
	1Min, 2Min, 3Min, 4Min, 5Min, 6Min, 7Min, 8Min, 9Min, 10Min, 11Min, 12Min, 13Min, 14Min, 15Min		
Suspend Mode	Disabled	Lets you define the system power down times.	Default
	1Min, 2Min, 4Min, 6Min, 8Min, 10Min, 20Min, 30Min, 40Min, 1Hour,		
Video Off Option	Always On	When enabled, this feature allows the VGA adapter to operate in a power saving mode.	
	Suspend --> Off		Default
Video Off Method	Blank screen	Selects the method by which the monitor is blanked.	
	V/H Sync+Blank		Default
	DPMS Support		



Power Management Controls (Continue)

	Setting	Description	Note
MODEM Use IRQ	3	Assigns an IRQ# to the modem device.	Default
	4-11, NA		
Soft-Off by PWR-BTTN	Delay 4 Sec.	Turns off the system power 4 seconds after pushing the power button.	
	Instant-off		Default
Run VGABIOS if S3 Resume	Auto	Some OS (win xp/2k) requires to load VGA BIOS after resume from S3.	Default
	Yes		
	No		
PWRON After Power Failure	On	The system will switch on when power comes back after a power failure.	
	Off	The system will remain off when power comes back after a power failure.	Default
	Former-Sts	The system will return to the state it was in before the power failure when power returns. (i.e: If the system was on, it will switch on again, if it was off, it will remain off)	
IRQ/Event Activity Detect	Press Enter	Select items that will wake up your system when in one of sleep modes. Press enter to go the select item page.	

IRQ/Event Activity Detect

	Setting	Description	Note
PS2KB Wakeup Select	Hot key	You can boot-up your system by PS/2	Default
	Password	K/B VIA hotkey or password.	
PS2KB Wakeup from S3/S4/S5	Disabled	You can set the following hotkey :	Default
	Ctrl+F1 ~ F12	1. Disable	
	Power	2. Choose CTRL+F1 up to F12	
	Wake	3. The power key in the K/B. (if available)	
	Any Key	4. The wake-up key in the K/B. (if available) 5. Any key in the K/B.	
VGA	ON	When <i>On of</i> VGA, any activity from	Default
	OFF	one of the listed system peripheral devices or IRQs wakes up the system.	
LPT & COM	LPT/COM	When <i>On of</i> LPT & COM, any activity	Default
	NONE, LPT, COM	from one of the listed system peripheral devices or IRQs wakes up the system.	
HDD & FDD	OFF	When <i>On of</i> HDD & FDD, any activity	Default
	ON	from one of the listed system peripheral devices wakes up the system.	
PCI Master	OFF	When <i>On of</i> PCI Master, any activity	Default
	ON	from one of the listed system peripheral devices wakes up the system	
PowerOn by PCI Card	Disabled	If enabled any PCI interrupt will wake	Default
	Enabled	up the system.	
Wake Up On LAN/Ring	Disabled	An input signal on the serial Ring	Default
	Enabled	Indicator (RI) line (in other words, an incoming call on the modem/LAN) awakens the system from a soft off state.	
RTC Alarm Resume	Disabled	The system ignores the alarm.	Default
	Enabled	Set alarm to power on the system by the date (1-31) or time (hh:mm:ss). If the date is set to [0], the system will self-power on by alarm everyday at the set time.	

3-6.1 IRQs Activity Monitoring

This option sets the IRQs Activity Monitoring.

CMOS Setup Utility – Copyright (C) 1984-2002 Award Software
 IRQs Activity Monitoring

Primary INTR IRQ3 (COM 2) IRQ4 (COM 1) IRQ5 (LPT 2) IRQ6 (Floppy Disk) IRQ7 (LPT 1) IRQ8 (RTC Alarm) IRQ9 (IRQ2 Redir) IRQ10 (Reserved) IRQ11 (Reserved) IRQ12 (PS/2 Mouse) IRQ13 (Coprocessor) IRQ14 (Hard Disk) IRQ15 (Reserved)	ON Disabled Enabled Enabled Enabled Enabled Disabled Disabled Disabled Disabled Enabled Enabled Enabled Disabled	Item Help <hr/> Menu Level ▶
---	---	---------------------------------

↑↓→ Move	Enter:Select	+/-/PU/PD:Value	F10:Save	ESC:Exit	F1:General Help
F5:Previous Values	F6:Fail-Safe Defaults		F7: Optimized Defaults		

After you have completed the changes, press [Esc] and follow the instructions on your screen to save your settings or exit without saving.

IRQs Activity Monitoring

Wake Up Events	Setting	Description	Note
Primary INTR	ON	When set to <i>On</i> , any event occurring at will awaken a system which has been powered down.	Default
	OFF		
IRQs Activity Monitoring (Press Enter)	Enabled	IRQ4(COM1), IRQ5(LPT2), IRQ6(Floppy Disk), IRQ7(LPT1), IRQ12(PS/2 mouse), IRQ13(Coprocessor), IRQ14(HardDisk)	
	Disabled	IRQ3(COM2), IRQ8 (RTC Alarm), IRQ9(IRQ2 Redir), IRQ10(Reserved), IRQ11(Reserved), IRQ15 (Reserved)	

3-7 PNP/PCI CONFIGURATIONS

This option sets the Motherboard's PCI Slots.

CMOS Setup Utility – Copyright (C) 1984-2002 Award Software
 PNP/PCI Configurations

PNP OS Installed Reset Configuration Data	NO Disabled	Item Help <hr/> Menu Level ▶ Select Yes if you are using a Plug and Play capable operating system Select No if you need the BIOS to configure non-boot devices.
Resources Controlled By x IRQ Resources	Auto (ESCD) Press Enter	
PCI/VGA Palette Snoop	Disabled	
Assign IRQ For VGA	Enabled	
Assign IRQ For USB	Enabled	
INT Pin 1 Assignment	Auto	
INT Pin 2 Assignment	Auto	
INT Pin 3 Assignment INT Pin 4 Assignment	Auto Auto	

↑↓→ Move	Enter:Select	+/-/PU/PD:Value	F10:Save	ESC:Exit	F1:General Help
F5:Previous Values	F6:Fail-Safe Defaults	F7: Optimized Defaults			



Note: Starred (*) items will disappear when the [Resources Controlled By] option is set to [Auto].

After you have completed the PCI Slot Configuration, press [Esc] and follow the instructions on your screen to save your settings or exit without saving.



PNP/PCI Configuration Controls

PNP/PCI Controls	Setting	Description	Note
PNP OS Installed	Yes	Set this field to [Yes] if you are running Windows 95, which is PnP compatible.	
	No	If the OS you are running does not support PnP configuration.	Default (If there is any doubt, set this field to [No])
Reset Configuration Data	Disabled	Retain PnP configuration data in BIOS.	Default
	Enabled	Reset PnP configuration data in BIOS.	
Resources Controlled By	Manual	BIOS does not manage PCI/ISA PnP card IRQ assignment. Requires to assign IRQ-# to PCI or ISA PnP manually. IRQ-3,4,5,7,9,10,11,12,14,15 assigned to: _ DMA-0,1,3,5,6,7 assigned to: _	
	Auto (ESCD)	The Plug-and-Play BIOS auto manages PCI/ISA PnP card IRQ assignment automatically.	Default (Recommended)
If [Resources Controlled By] is set to [Manual]			
IRQ Resource (Press Enter)	PCI Device	Choose IRQ-# assigned to PCI/ISA PnP card.	Default (IRQ-3,4,5,7,9,10,11,12,14,15)
	Reserved	Reserved IRQ	
<p>Under this item the user can assign an IRQ to a PCI slot. However, there under some conditions the IRQ will not be assigned as selected under this item:</p> <ol style="list-style-type: none"> 1. IRQs 0, 1, 2, 6, 8, 13 can NOT be assigned, because they are fixed. 2. IRQs 5, 9, 10, 11 are available 3. IRQs 3,4,7,12,14 and 15 will only be assigned if they are free. See the table below on how to free them: 			

PNP/PCI Configuration Setup (Continue)

PNP/PCI Setup	Setting	Description	Note
Interrupt Line	How to set the BIOS to release the IRQ to the PnP Interrupt pool:		
	PnP / PCI configuration	Integrated Peripherals	
IRQ 15	IRQ 15: PCI / ISA PnP	On-Chip Secondary PCI IDE: disabled	
IRQ 14	IRQ 14: PCI / ISA PnP	On-Chip Primary PCI IDE: disabled	
IRQ 12	IRQ 12: PCI / ISA PnP	<i>Interrupt 12 will be released by the PnP BIOS automatically if the PS/2 Mouse Port is not used.</i>	
IRQ 7	IRQ 7: PCI / ISA PnP	Onboard parallel port: disabled	
IRQ 4	IRQ 4: PCI / ISA PnP	Onboard Serial port 1: disabled	
IRQ 3	IRQ 3: PCI / ISA PnP	Onboard Serial port 2: disabled	
4. Your OS may reassign another interrupt to a PCI slot after BIOS passes control to the OS, especially if you use Windows 95, 98 or NT.			
Assign IRQ For VGA/USB	Disabled	BIOS will assign IRQ for VGA/USB port.	
	Enabled	BIOS won't assign IRQ for VGA/USB port.	Default

MULTI I/O ADDRESSES

Default settings for multi-I/O addresses are as follows:

Port	I/O Address	IRQ	Status
LPT1	378H	7	ECP/EPP
COM1	3F8H	4	
COM2	2F8H	3	



Warning: If a default I/O address conflicts with other I/O cards such as sound card, you must change one of the I/O addresses to remedy to this address conflict. (I/O addresses can be adjusted from the BIOS Setup Utility)

3-8 PC HEALTH STATUS

This option sets the Motherboard's PC Health Status.

CMOS Setup Utility – Copyright (C) 1984-2002 Award Software
PC Health Status

Shutdown Temperature	Disabled	Item Help
Vcore	1.77 V	Menu Level ▶
+ 3.3 V	3.24 V	
+ 12 V	12.16 V	
DDR Voltage	2.48 V	
AGP Voltage	1.48 V	
Current CPU Temp.	67 ° C / 152 ° F	
Current CHA Temp.	29 ° C / 84 ° F	
Current CPUFAN1 Speed	4856 RPM	
Current CHAFAN1 Speed	4411 RPM	

↑↓→ Move	Enter:Select	+/-/PU/PD:Value	F10:Save	ESC:Exit	F1:General Help
F5:Previous Values		F6:Fail-Safe Defaults		F7: Optimized Defaults	

After you have completed the changes, press [Esc] key and follow the instructions on your screen to save your settings or exit without saving.

CPU Device Monitoring

	Setting	Description	Note
Shutdown Temperature	Disabled	This item allows you to set up the CPU shutdown Temperature. This item only effective under Windows 98 ACPI mode.	Default
	45°C/113°F,		
	50°C/122°F,		
	55°C/131°F,		
	60°C/140°F,		
	65°C/149°F, 70°C/158°F		

**CPU Device Monitoring (Continue)**

	Setting	Description	Note
Vcore, +3.3V, +12V	V	Show the current voltage status.	
CPU Temperature	°C/°F	Show the current status of CPU temperature.	
CHA Temperature	°C/°F	Show the current status of the System temperature.	
CPUFAN1/ CHAFAN1 Speed	RPM	Show the current status of CPU/CHA Fan.	

3-9 LOAD FAIL-SAFE DEFAULTS

Select the [Load Fail-Safe Defaults] option from the Main Menu to load a pre-defined safe bios settings. This option is recommended if you have instability issue.

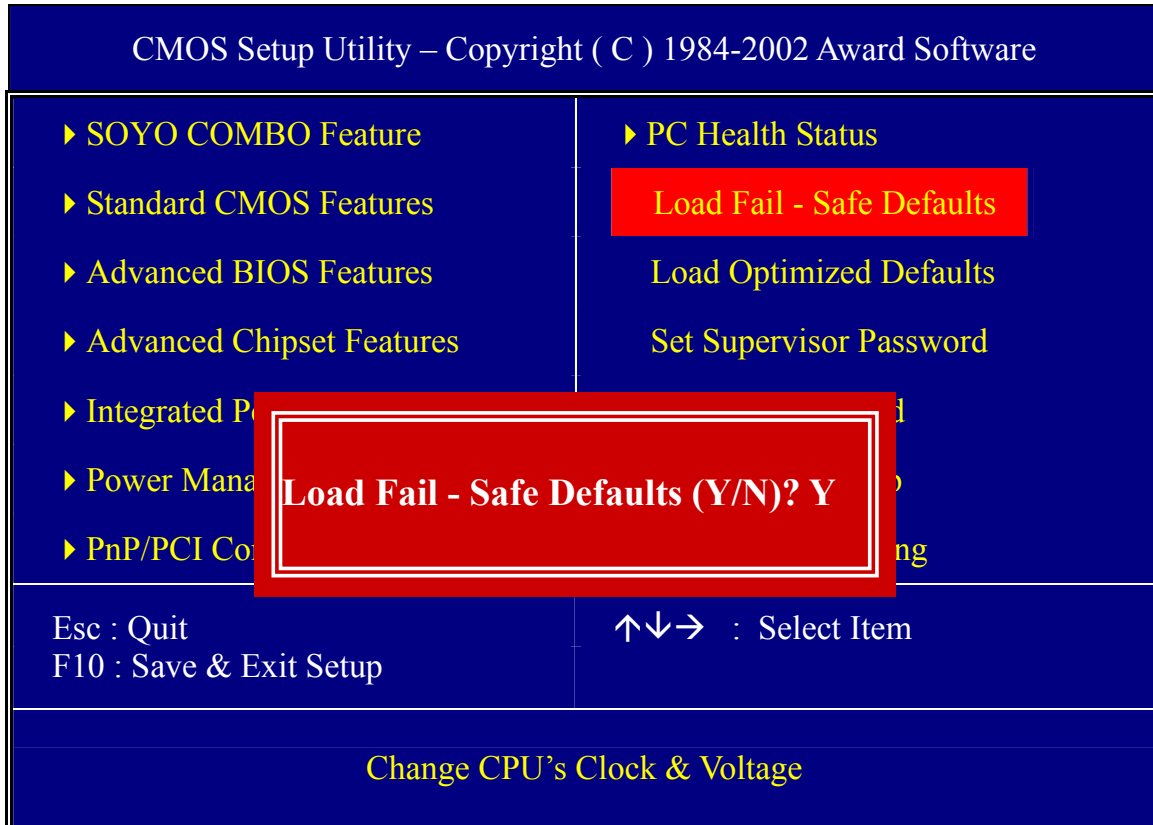

Type [Y] to use the Setup Defaults followed by [Enter] or otherwise [N] to return to the Main Menu and keep current values.

3-10 LOAD OPTIMIZED DEFAULTS

Select the [Load Optimized Defaults] option from the Main Menu to load a pre-defined optimized BIOS settings.

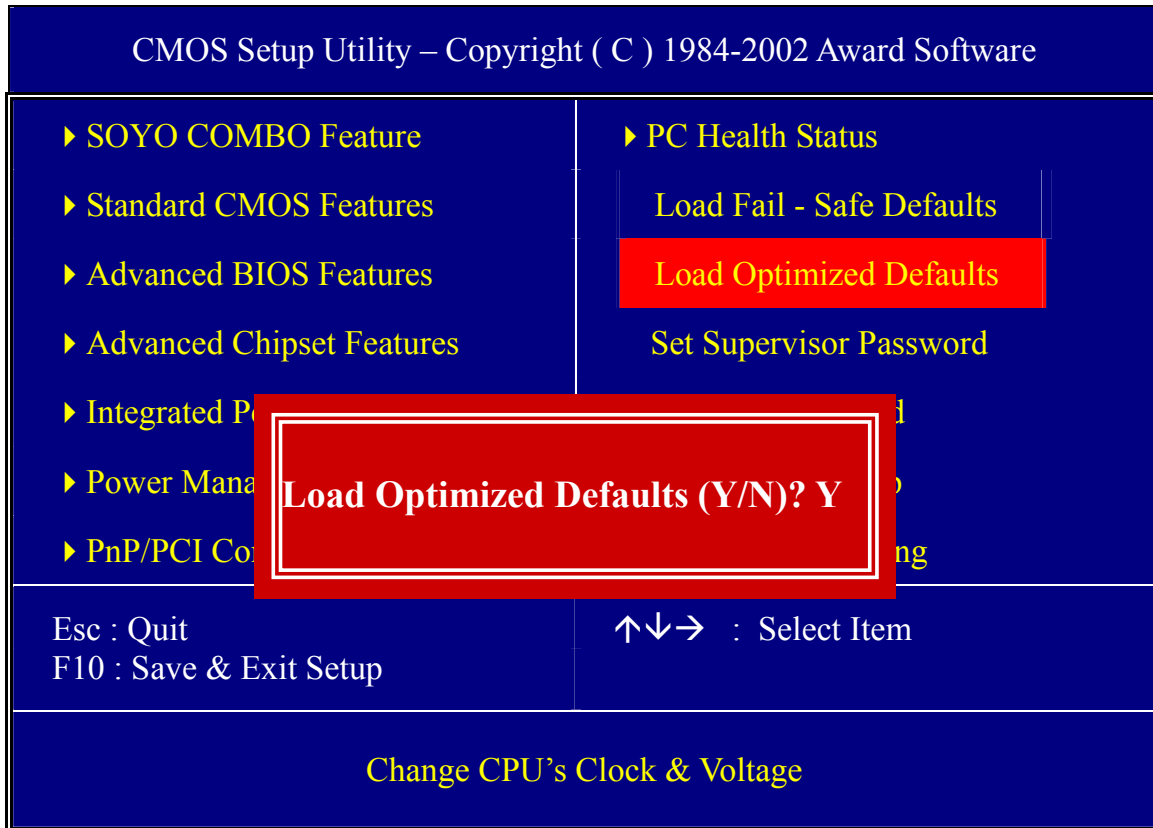

Type [Y] to use the Setup Defaults followed by [Enter] or otherwise [N] to return to the Main Menu and keep current values.



Warning: If you run into any problem after changing the BIOS configuration, please load the fail-safe Defaults for stable performance.

3-11 SET SUPERVISOR PASSWORD

Based on the setting you have made in the [Security Option] of the [BIOS FEATURES SETUP] section, the password prevents access to the system or the setup program by unauthorized users. Follow this procedure to set a new password or disable the password:

1. Choose [BIOS FEATURES SETUP] in the Main Menu and press [Enter]. Select the [Security Options] item and set the field to:
 - a. [System]: The password is required every time the system is booted. This means only a person who knows the password can use this computer.
 - b. [Setup]: The password is required only when you attempt to enter the BIOS Setup program.
2. Choose [SUPERVISOR PASSWORD] from the Main Menu and press [Enter]. The following prompt appear:

Enter Password:



Warning: If you forget or lose the password, the only way to access the system is to set jumper JP5 to clear the CMOS RAM. All setup information is lost and you must run the BIOS setup program again.



Note: If you do not wish to use the password function, press [Enter] directly and the following message appears:

Password Disabled!!

3. Enter your new password and press [Enter]. The following message appears, prompting to confirm the new password:

Confirm Password:

4. Re-enter your password and then press [Enter] to exit to the Main Menu.

This diagram outlines the password selection procedure:

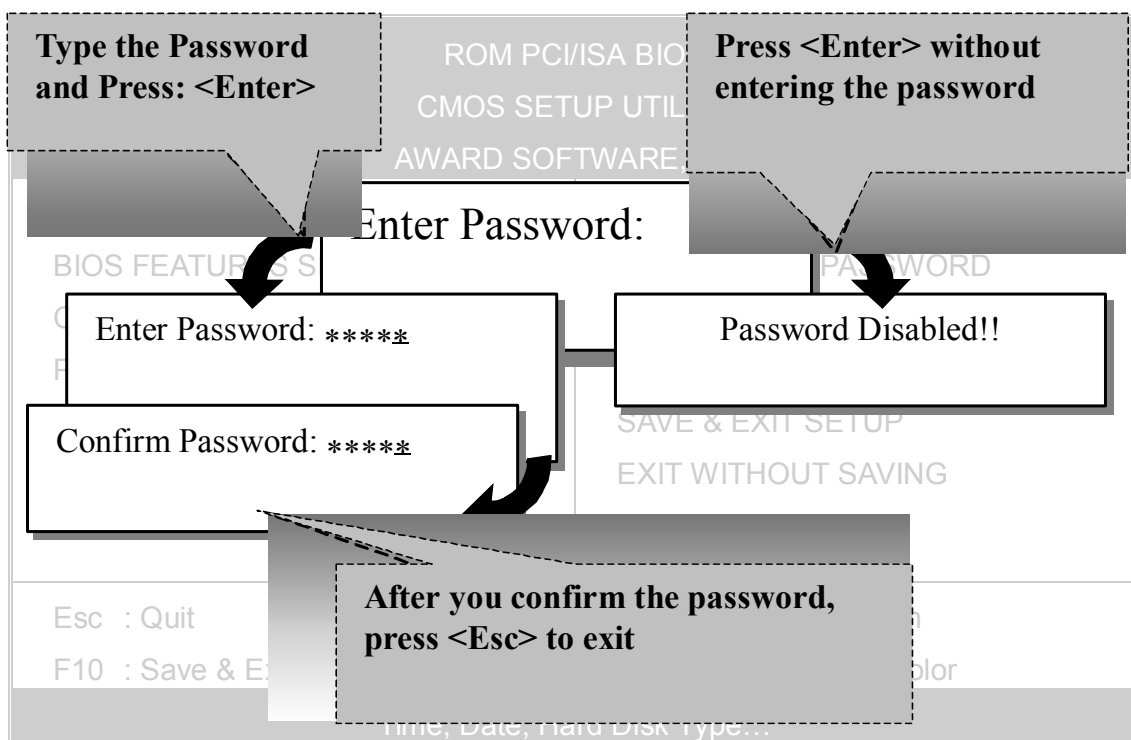

3-12 SET USER PASSWORD

When the user password option is on, you are not allowed to change any setting in the [CMOS SETUP UTILITY] except for changing the user's password.

The password setting procedure is similar to that for the [SUPERVISOR PASSWORD] (Refer to section 3-9).

BOOT MENU

Boot Menu enables user to boot-up on different boot device without going into the BIOS setup.

To enable boot Menu, press “ESC” after memory initialization, user will see a device menu, in which user can choose the device they wish to boot from.

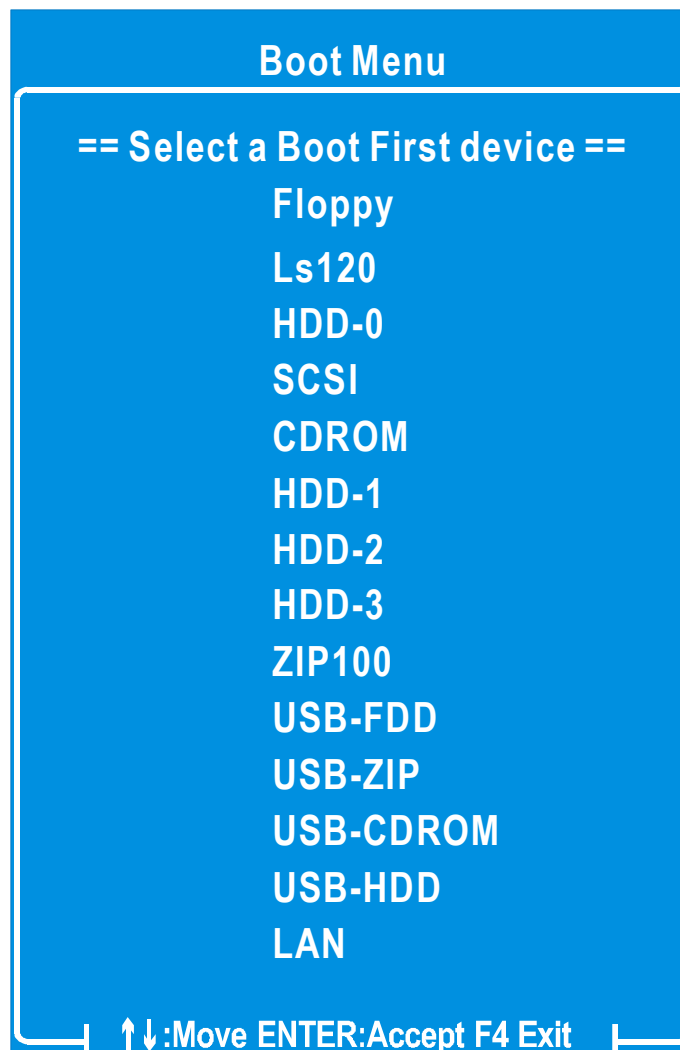

Chapter 4

DRIVERS INSTALLATION



The SOYO-CD will Auto Run only in Windows Base Operating System.

Your SY-P4X400 DRAGON Ultra Motherboard comes with a CD-ROM labeled "SOYO CD." The SOYO CD contains

- The user's manual for your new motherboard – in PDF format,
- The drivers software available for installation, and
- A database in HTML format with information on SOYO motherboards and other products.

Step 1. Insert the SOYO CD into the CD-ROM drive

If you use Windows 2000, NT or XP, the SOYO-CD will not detect your motherboard type. In that case the following dialog will pop up, please choose your motherboard and press OK. Now the SOYO-CD Start Up Menu will be shown.

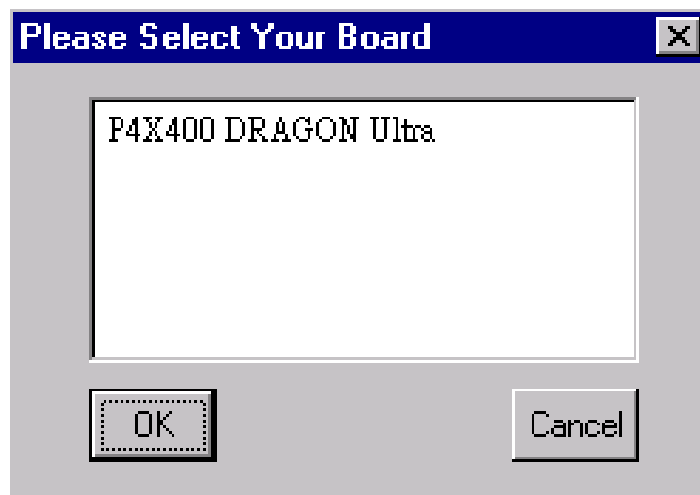

(SOYO CD Start Up Program Menu)

If you use Windows 95/98/98SE/ME, the SOYO CD Start Up Program automatically detects which SOYO Motherboard you own and displays the corresponding model name.



The user's manual files included on the SOYO CD are in PDF (Postscript Document) format. In order to read a PDF file, the appropriate Acrobat Reader software must be installed in your system.

Note: The Start Up program automatically detects if the Acrobat Reader utility is already present in your system, and otherwise prompts you on whether or not you want to install it. You must install the Acrobat Reader utility to be able to read the user's manual file. Follow the instructions on your screen during installation, then once the installation is completed, restart your system and re-run the SOYO CD.

Step 2. Install Drivers and Utilities

The following drivers need to be installed in order for the system to operate properly

1. VIA 4 in 1 driver.
2. C-Media 8738 audio driver. – Only required if you are using the onboard audio.
3. VIA USB 2.0 driver.
4. Realtek 8100b LAN driver. Should be installed manually.
5. HighPoint driver should be installed manually. Check Chapter 6.
6. Highpoint Utility for the on-board RAID function. Check Appendix A.

The rest of the available drivers are optional.

Click the **Install Drivers** button to display the list of drivers software that can be installed with your motherboard. The Start Up program displays the drivers available for the particular model of motherboard you own. We recommend that you only install those drivers.

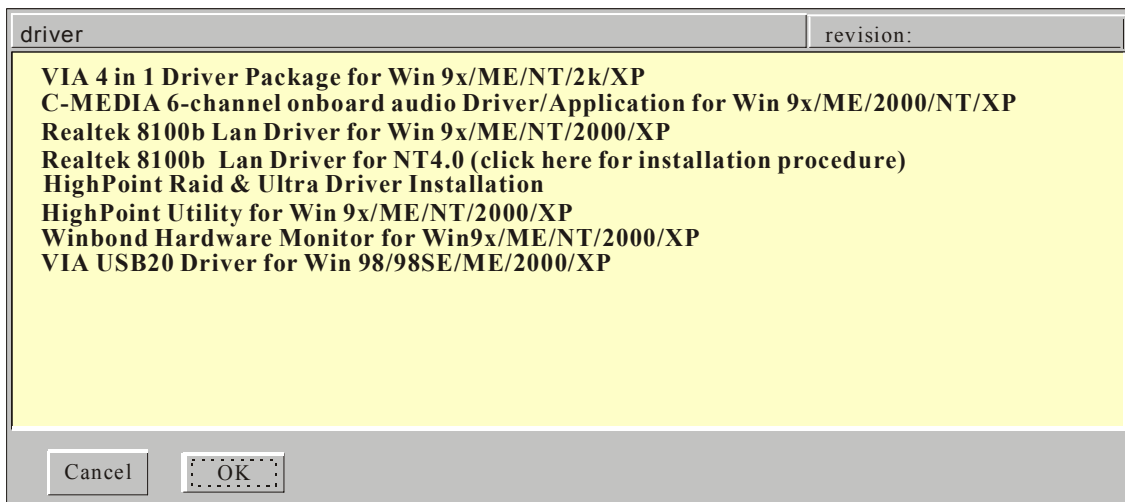

(Driver Installation Menu)

A short description of all available drivers follows:

➤ **VIA 4 in 1 Driver Package for Win 9x/ME/NT/2000/XP**

VIA 4 In 1 driver includes four system drivers to improve the performance



and maintain the stability of systems using VIA chipsets. These four drivers are:

VIA Registry (INF) Driver, VIA AGP VxD driver, VIA ATAPI Vendor Support Driver and VIA PCI IRQ Miniport Driver. For Windows NT users, the VIA IDE Bus Mastering driver is the only driver to be installed in your system.

A description of 4 drivers followa:

—**Bus Master PCI IDE Driver**

The ATAPI IDE driver enables the performance enhancing bus mastering functions on ATA-capable Hard Disk Drives and ensures IDE device compatibility.

—**AGP VxD Driver**

VIA AGP VxD Driver is to be installed if you are using an AGP VGA device. VIAGART.VXD will provide service routines to your VGA driver and interface directly to hardware, providing fast graphical access.

—**VIA Chipset Functions Registry**

VIA Registry (INF) Driver is to be installed under Windows. The driver will enable the VIA Power Management function.

—**IRQ remapping utility (This driver is installed automatically)**

VIA PCI IRQ Miniport Driver is to be installed under Windows 98 only, it sets the system's PCI IRQ routing sequence.

➤ **C-MEDIA 6-channel onboard audio Driver/Application for Win 9x/ME/2000/NT/XP**

1. The driver supports 2/4/5.1 speakers 3D positional audio.
2. The application is include *CD Player/MIDI Player/MP3/Wave Player/Mixer* with the control over your PC's audio functions.

➤ **Realtek 8100b Lan Driver for Win 9x/ME/NT/2000/XP**

This Program is for install Driver to use Realtek Lan function.

➤ **HighPoint Utility for Win 9x/ME/2000/NT/XP**

The RAID Administrator utility is used to monitor or perform maintenance on a RAID Administrator Mirror (RAID 1), Stripe (RAID 0), Span or Mirror plus Stripe (RAID 0+1). Visual messages are available to warn of possible problems with the disk array or controller.

If you have reader card, it must be installed.

➤ **Winbond Hardware Monitor for Win 9x/ME/NT/2000/XP**

Your motherboard comes with a hardware monitoring IC. By installing this utility Temperature, Fan speed and Voltages can be monitored. It is also possible to set alarms when current system values exceed or fall below pre-set values.

➤ **VIA USB2.0 Driver for Win 98/98SE/ME/2000/XP**

This setup program will install the driver for VIA USB 2.0 Host Controller.

Select which driver you want to install and click **OK**, or click **Cancel** to abort the driver installation and return to the main menu.

Note: Once you have selected a driver, the system will automatically exit the SOYO CD to begin the driver installation program. When the installation is complete, most drivers require to restart your system before they can become active.

Step 3. Check the Latest Releases

Click the 'Check the latest Releases' button to go the SOYO Website to automatically find the latest BIOS, manual and driver releases for your motherboard. This button will only work if your computer is connected to the internet through a network or modem connection. Make sure to get your modem connection up before clicking this button.

After Windows XP installation, your device manager should look like this:

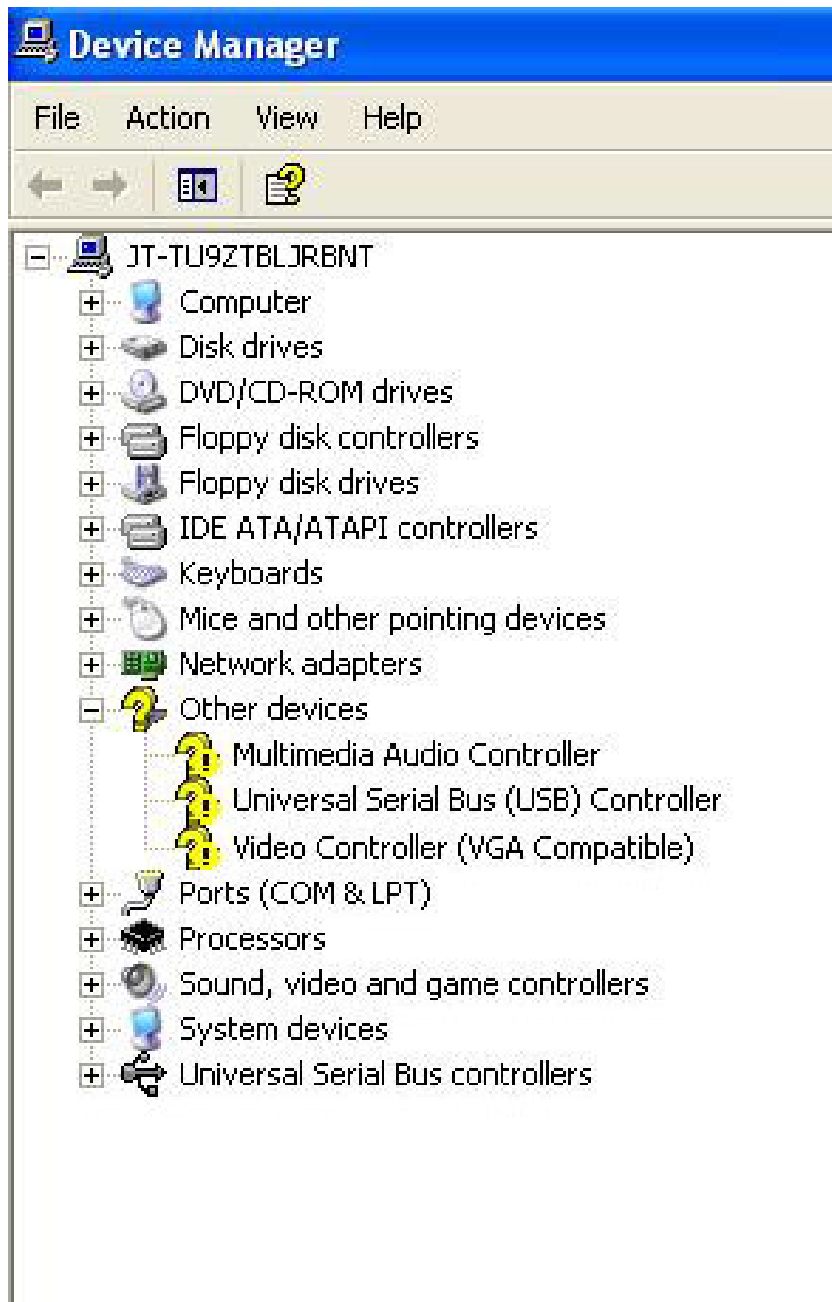

After driver installation, your Windows XP device manager should look like this:

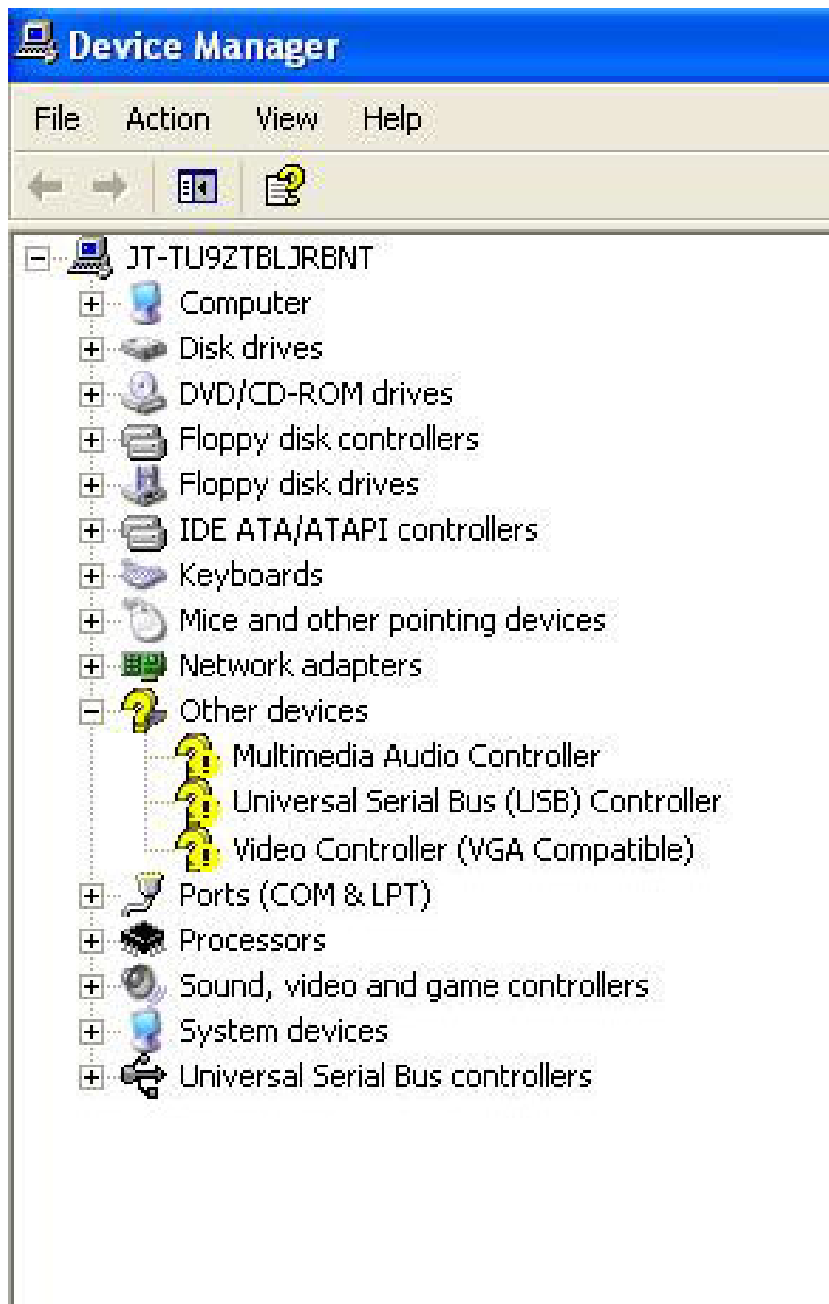

Drivers directory list in the CD driver

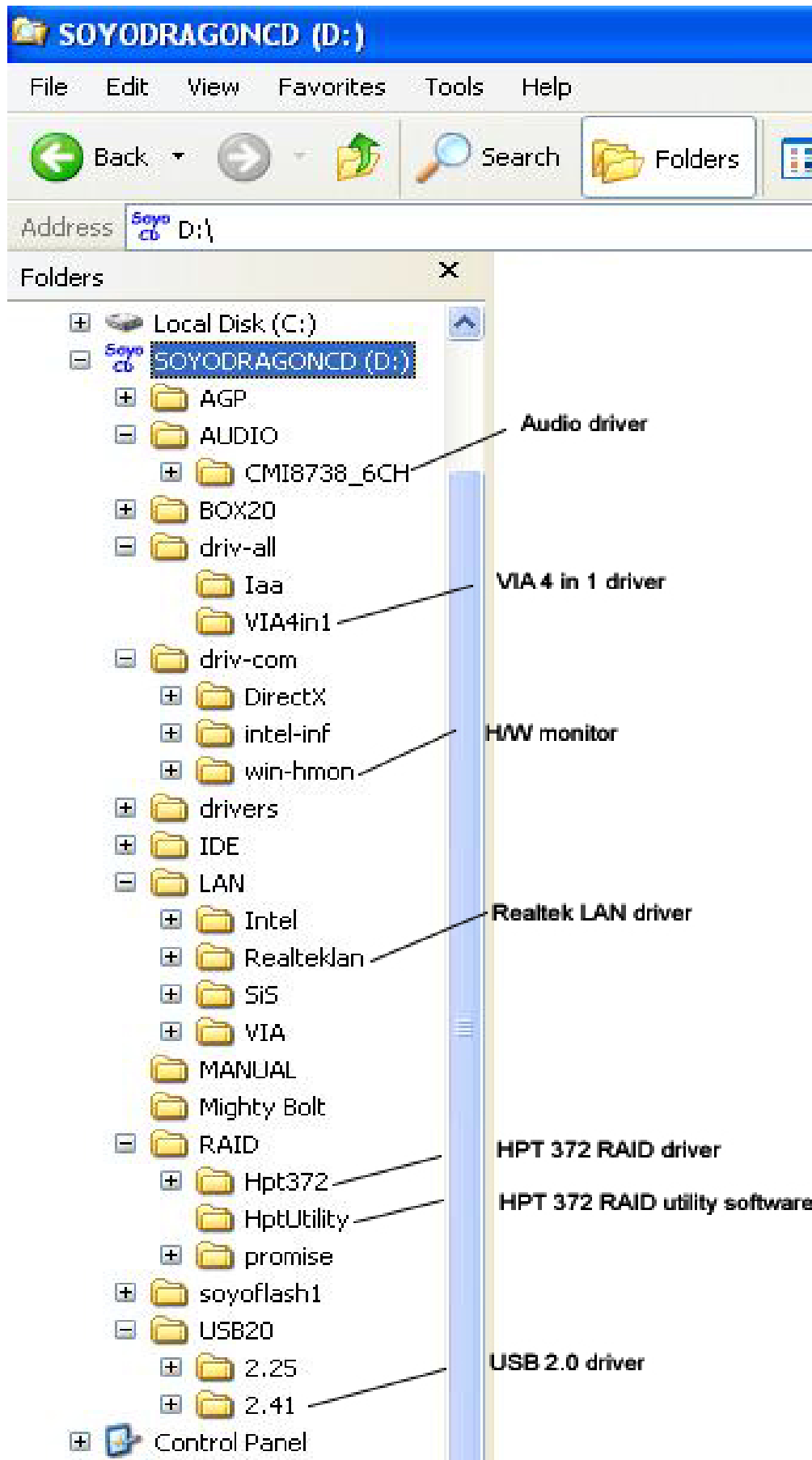

Chapter 5

Audio Driver Installation

Audio Driver Installation for Windows 98/98se

After you have installed the audio driver, windows may prompt you to restart your computer.

When your computer restarted it may look for windows driver from your Win98CD and ask you to insert your Win98/98se CD to your CD-drive. At this point you need to insert the Win98 CD to your CD-drive and type in D:\win98 (assuming your CD-ROM in driver D).

Audio Driver Installation for Windows NT

1. Double click my computer.
2. Double click control panel.
3. Double click multimedia and select devices.
4. Select ADD and select OK.
5. Click on “Browse” then point it to the SOYO CD for the Audio driver.
6. The audio driver path is in “d:\audio\cmi8738_6ch\Win_NT40\drv.”
(where D: is your CD-ROM)

How to setup speakers using SPDIF out

1. Go to start → program → PCI audio applicattion → audio rack → audio rack.
2. Click on the  (advance) Icon.
3. Click on speakers.
4. Choose the 2 speaker and then enable the SPDIF playback.



Chapter 6

Highpoint HPT 372 Driver Installation

You can use your HPT372 as

1. Normal IDE function.
2. RAID function.

To use IDE3 and IDE4 as normal IDE, please do the following steps

1. Enable on-board IDE RAID in the bios.
2. Install the HP372 driver, see driver installation instruction below.

To use IDE3 and IDE4 as RAID controller, see Appendix A (Getting Started Section) for installation procedure.

To boot from the HPT372 controller, (IDE 3 or IDE 4)

1. Go to the BIOS setup and set the First Boot device to SCSI.
2. Set the “RAID/ATA & SCSI boot order” to “RAID/ATA,SCSI”.

Installing RAID Driver on an Existing System

Windows 9x/ME Installation

If Windows can not find new hardware, the driver can be installed through the following steps:

1. Shut down all programs.
2. Click **Start-->Setup-->Control Panel**, then double-click on **Add New Hardware** icon.
3. Click **Next** in the popup window to continue.
4. A dialog box will appear and ask whether to let windows search new hardware. Select **No, I want to select the**



- hardware from a list**, and then click **Next** to continue.
5. Hardware's of different types will be shown in the follow-on window. Select **SCSI Controllers** and then click **Next** to continue.
 6. Insert the floppy disk of driver into the floppy drive, then click **Have Disk....**
 7. A dialog box will pop up, input the path of driver **SOYO CD:\Raid\Hpt372\Win98_ME**.Then click **OK** to continue.
 8. In the follow-on window, driver will list out the controller type you need to install, please just click **Next** to continue.
 9. Follow the system prompt to install driver. When finished, restart the computer.

Windows NT 4.0

1. Click **Start-->Setup-->Control Panel**, then double-click **SCSI Adapter** icon.
2. In the follow-on window, select **Driver** item, then click **Add** button.
3. In the follow-on window, select **Have Disk....**
4. Insert the SOYO CD of driver, input the path of driver **D:\Raid\Hot372\WinNT**, then click **OK**.
5. In the follow-on window, select **HPT370/HPT372 UDMA/ATA RAID Controller** item, then click **OK**.
6. Follow the system prompt to install the driver. When finished, re-start the computer.

Windows 2000

1. Click **Start-->Setup-->Control Panel --> Switch to classic View → system → hardware → device manager**.
2. You will see a “! RAID Controller” under unknown device
3. Double click “! RAID controller”
4. Re-install driver
5. Choose “search for a suitable driver....”



6. Insert SOYO Driver CD, click next
7. During installation, Win 2K will prompt you to insert the RAID driver diskette
8. Browse to the directory that contains the missing file (D:\raid\hpt372\winxp).
9. Follow the system prompt to finish the installation, and restart the computer.
10. After restart, Win 2k will detect "HPT RCM device"
11. Choose "search for a suitable driver....", click next
12. Follow the system prompt to finish the installation.

Windows XP

1. Click **Start-->Setup-->Control Panel** --> Switch to classic View → system → hardware → device manager.
2. You will see a "! RAID Controller" under unknown device
3. Double click "! RAID controller"
4. Re-install driver
5. Choose "install from a list or specific location"
6. Check "search removable media" and then click next
7. Choose the driver for Win XP
8. During installation, Win XP will prompt you to insert the RAID driver diskette
9. Browse to the directory that contains the missing file (D:\raid\hpt372\winxp). If you click yes without browsing, Win XP will not find the .inf file
10. Follow the system prompt to finish the installation, and restart the computer.



Installing Driver During OS Installation

Install driver during Windows NT4.0 installation

1. Go to “d:\raid\hpt372\” directory, (assuming that your CD-ROM is drive d) copy all the files and directory to a floppy disk.
2. Press **F6** key when the system prompts **Setup is inspecting your computer’s hardware configuration**.
3. Press **F6** key, the installation will continue. Later, installation program will remind user to press **S** key to specify other devices. Please press **S** key.
4. In the follow-up **Device Type** window, select **Other** item, then press **Enter** to confirm.
5. The installation program will prompt users to insert the floppy disk of driver. Please insert it and then press **Enter** to confirm.
6. In the follow-on window, select **HPT370/HPT372 UDMA/ATA RAID Controller**, then press **Enter** to confirm.
7. The follow-on interface will list the devices to be installed, in which **HPT370/HPT372 UDMA/ATA RAID Controller** item should be included. (If users want to install other devices, please operate at this time. If all devices have been successfully installed, please go to next.)
8. Press **Enter** to continue the installation of Windows NT4.0.



Install driver during Windows 2000 installation

1. Go to “d:\raid\hpt372\” directory, (assuming that your CD-ROM is drive d) copy all the files and directory to a floppy disk.
2. If Windows 2000 is installed from the floppy drive, please let the installing program run automatically. If Windows 2000 is installed from the CD-ROM drive, please **F6** key when the message **Press F6 if you need to install third party SCSI or RAID driver** appears.
3. Press **S** key to specify additional devices when the **Windows 2000 Setup** window appears.
4. Insert the floppy disk of driver, then press **Enter** to continue.
5. The system will ask whether to install driver under **WinNT** or under **Windows 2000**, please select to install driver under **Windows 2000**.
6. In the follow-on window of device type, please select **Other** and press **Enter** to continue.
7. The follow-on interface will list the devices to be installed, in which **HPT370/HPT372 UDMA/ATA RAID Controller** item should be included (If users want to install other devices, please operate at this time. If all devices have been successfully installed, please go to next.)



Install driver during Windows XP installation

1. Go to “d:\raid\hpt372\” directory, (assuming that your CD-ROM is drive d) copy all the files and directory to a floppy disk.
2. Booting from CD-ROM, when the **Windows XP Setup** blue screen appear and prompt user to press F6 key to install third party SCSI or RAID driver, please press F6 Key.
3. Press **S** key to specify additional devices when the **Windows XP Setup** window appears.
4. The system will ask whether to install driver under **WinNT** or under **Windows XP**, please select to install driver under **Windows XP**.
5. Insert the floppy disk of driver, then press **Enter** to continue.
6. In the follow-on window of device type, please select **HPT370/HPT372 UDMA/ATA RAID Controller for Windows XP** to continue.
7. Win XP will prompt you that a message that the driver is newer than the default driver, press S to continue.
8. The follow-on interface will list the devices to be installed, in which **HPT370/ HPT372 UDMA/ATA RAID Controller** item should be included. (If users want to install other devices, please operate at this time. If all devices have been successfully installed, please go to next.)
9. Press ENTER to continue Windows XP setup.



Chapter 7

Realtek LAN Driver Installation

Install the Realtek LAN Drivers under windows

NT4.0

1. Double click the Network icon in the control panel. The Network properties windows will appear. Click on the Devices tab and press the Add button.
2. Select “Unlisted or Updated Drivers” from the list of drivers in the Add window by placing the mouse pointer over it and clicking the left mouse button. Press the OK button.
3. The Install Driver dialog box will appear and request the path of the location of the drivers to be installed. Enter “D:\lan\Realtek\lan\WinNT4”. (where D: is your CDROM drive)
4. After installation, Windows NT will display a dialog box asking you to restart your system.

APPENDIX A

HighPoint HPT 372

Introduction

HPT372 is a UDMA/ATA133 RAID controller. You can either use HPT 372 (IDE3, IDE4) as a RAID controller or as a regular IDE controller.

RAID Administrator is a Windows-based RAID management utility for HPT372 RAID Controller. With graphical user interface, RAID Administrator enable users to easily configure, manage harddisk and disk arrays connected to HPT372 RAID controller.

Main Features & Benefits

- Below are the main features and benefits of RAID Administrator.
- Support RAID 0, 1, 0+1 & Span
- Allowed maximum 4 disks connection to every controller (Does not support ATAPI devices)
- Hot-swapping failed hard disk in mirror array
- Support independent use of hard disk
- Support hot spare disk
- Support Operating Systems: DOS/Windows 3.x, Windows 98/Me, Windows NT4.0, Windows 2000, Windows XP.
- Windows-based software for RAID management(compatible with BIOS)
- Disk error alarm mechanism
- Event log for easy trouble shooting
- Plug-and-play

Getting Started

This section is designed to get you started on the setup/installation of your HighPoint HPT372 RAID controller in your system. To use the HPT372 chip as a raid controller, you need to setup the HDD in the HPT372 bios menu (ctrl-H) or use the RAID administrator. If not, the HDD on IDE 3 and IDE 4 will act as a regular IDE HDD.

To be able to use the RAID function, please do the following:

1. Connect the 2 Hard disk on IDE3/4
2. Enable the RAID function in the BIOS
3. Create a Disk Array. For create instructions see below.
4. Install HPT 372 driver; check chapter 6 for driver installation procedure.

Note:

- You can disable the HPT372 controller in the BIOS setup.
- To boot from the HPT372 controller, (IDE 3 or IDE 4) go to the BIOS setup and set the First Boot device to SCSI.
- When setting up the RAID 0 or RAID 1, please use the IDE 3 master and IDE4 master. We do not recommend configuring the RAID array on the same IDE.

Create a Disk Array

You can create a disk array using:

1. HPT372 BIOS Utility Configuration
Need to use this utility if you plan to install an operating system on IDE3/4
2. Highpoint ATA RAID Management software
Recommend using this software if you already have an existing operating system in IDE1/2

HPT372 BIOS Utility Configuration

Enter into BIOS Configuration Utility

When the following information is displayed on screen during the system start-up, press **Ctrl+H** key to enter into BIOS configuration utility.

The main interface of BIOS configuration utility is as below:

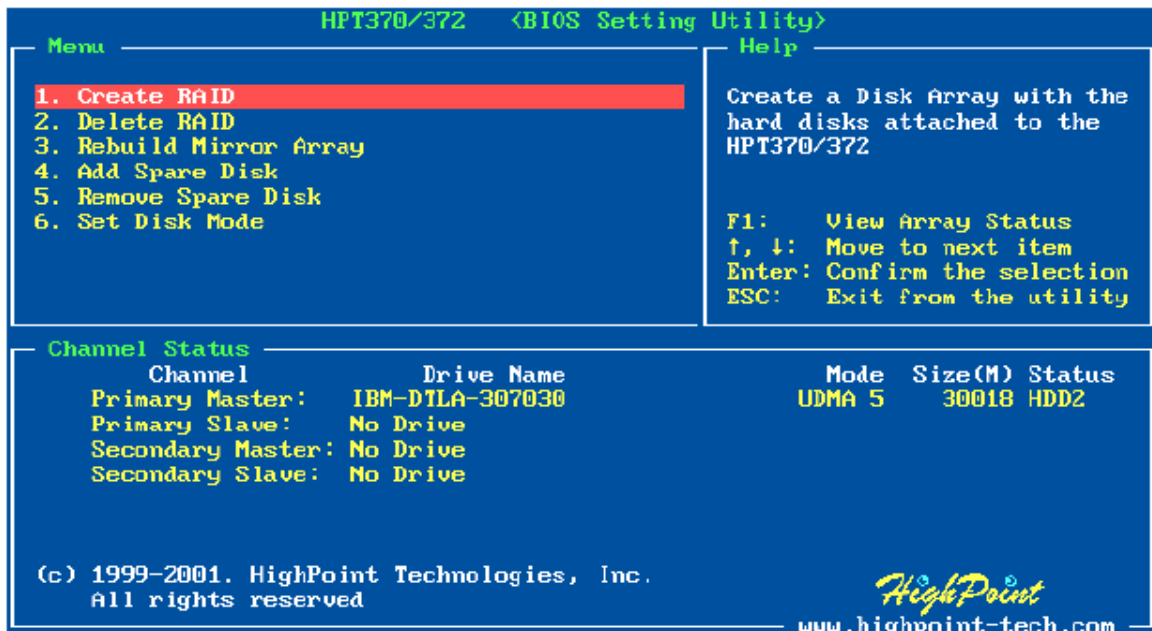

Menu:

It displays all items of the operating command.

Help:

It displays the illustrating information of the current selection and the available operation prompts.

Channel Status:

It displays the status information of all devices in connection. When it is active, users can select the device to be operated.

I. Create RAID

The following steps shall be taken to create RAID in BIOS.

1. Use the arrow key to select **1. Create RAID**.
2. Press **Enter** to confirm and go to next.
3. Select **1. Array Mode** in the next menu and press **Enter**.

4. Select the intended RAID level in the popup selection box and press **Enter**.
5. Select **2. Select Disk Drives** in the menu and press **Enter**.
6. Select the haddisks to be used for creating the disk array and press **Enter** to confirm.
7. Select **3. Start Creation Process**.
8. Pay attention to the warning message, and press **Y** to finish creation.

Note:

1. If you have selected **Striping (RAID 0) for Performance** in the popup sub-interface after the operation of **1. Array Mode**, you should directly go to **3. Strip Size 64K** and then select **4. Start Creation Process**. The default strip size is **64K**.
2. If user is creating RAID 0+1, then user must select four single disks. All data on these disks will be destroyed after creation of RAID 0+1.
3. Different warning messages appear according to different RAID levels.

II. Delete RAID

The following steps shall be taken to delete RAID.

1. In the menu zone, select **2. Delete RAID**, press **Enter** to confirm this operation and go to next.
2. In the validated channel status, use the arrow key to select the disk array to be deleted and press **Enter** to confirm.
- 3. Press Y when warned **Are you sure you want to remove the disk array?****

III. Rebuild Mirror Array

The following steps shall be taken to rebuild the mirror array.

1. In the menu, select **3. Rebuild Mirror Array**, press **Enter** to confirm.
2. In the menu, select **1. Select Source Disk: None** and press

- Enter** to confirm.
3. In the validated channel status, select the source disk of the mirror array and then press **Enter**.
 4. In the menu, select **2. Select Target Disk: None** and press **Enter** to confirm.
 5. In the validated channel status, select the target disk of the mirror array and then press **Enter**.
 6. In the menu, select **3. Start Duplication Process** and press **Enter** to confirm.
 7. Press **Y** when asked **The last time rebuild not completed. Continue?**

Note:

When there is no RAID 1 array, system will prompt user **No enough disks** at the second step, and rebuild cannot continue.

IV. Add Spare Disk

The following steps shall be taken to add the spare disk.

1. In the menu, select **4. Add Spare Disk** and press **Enter** to confirm.
2. In menu, select **1. Select Mirror Array: None** and press **Enter** to confirm.
3. In the validated channel status, select the mirror array and press **Enter** to confirm.
4. In the menu, select **2. Select Spare Drive: None** and press **Enter** to confirm.
5. In the validated channel status, select the spare disk to be added and press **Enter** to confirm.

V. Remove Spare Disk

The following steps shall be taken to remove the spare disk.

1. In the menu, select **5. Remove Spare Disk** and press **Enter** to confirm.
2. The **1. Select Mirror Array: None** item appears in the menu.

3. In the validated channel status, select the spare disk to be removed and press **Enter** to confirm.

VI. Set Disk Mode

The following steps shall be taken to set the disk mode.

1. Select **6. Set Disk Mode** in the menu and press **Enter** to confirm.
2. Select the disk mode to be set in the popup selection box and press **Enter** to confirm.

VII. Set Boot Disk.

The following steps shall be taken to set the boot disk:

1. In the menu, select **7. Set Boot Disk** item, press **Enter** to confirm.
2. In the validated channel status zone, use the arrow key to select the boot device and press **Enter** to confirm.

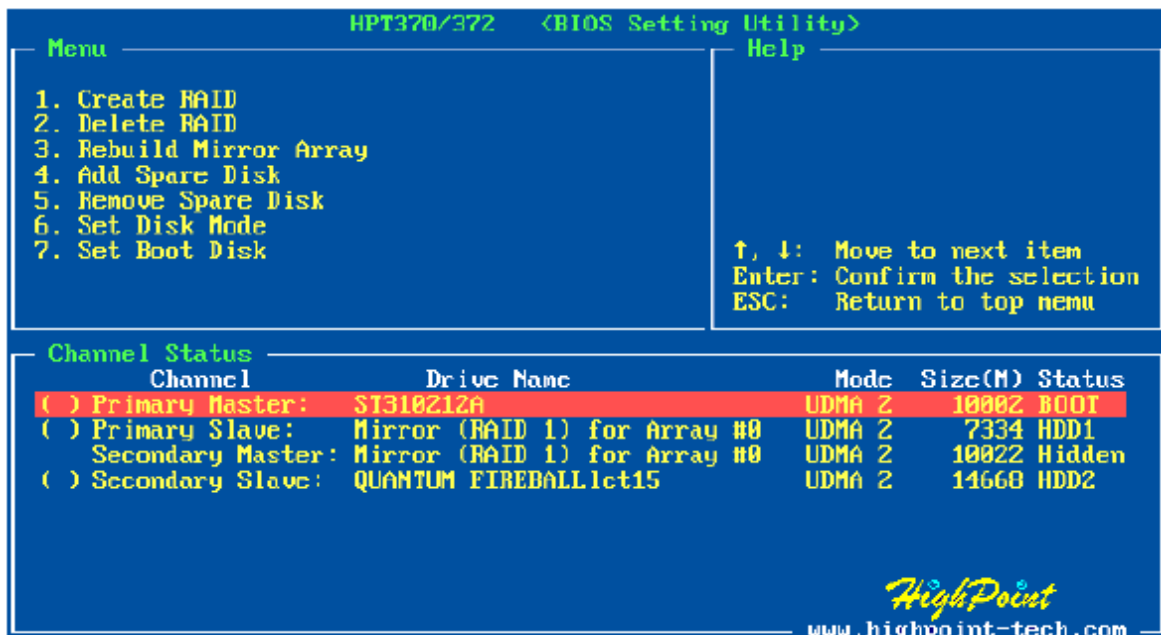

Note:

1. The **Set Boot Disk** item appears on condition that no hard disk is connected to IDE on motherboard.
2. After the boot disk is set, its status will become **Boot**.

Highpoint ATA RAID Management Software

Install Software

Insert SOYO driver utility CD, Highlight the driver **HighPoint Utility for Win 9x/ME/2000/NT/XP** and click ok

To manually install the RAID Administrator, insert the SOYO driver utility CD, then browse to the path “d:\ utility\disk1\setup.exe”

After the installation is complete, restart the computer. With the implicit option, the setup program will create program group: **Start --> Program-->HighPoint**. This program group contains the following contents:

- Highpoint ATA RAID Management Software
- Readme
- Uninstall Highpoint ATA RAID Management Software

Creating a RAID Array

Click on the **Configuration** tab, the Configuration window appears. There are four sub-tabs in this screen. The **Create RAID** window is the active screen by default.

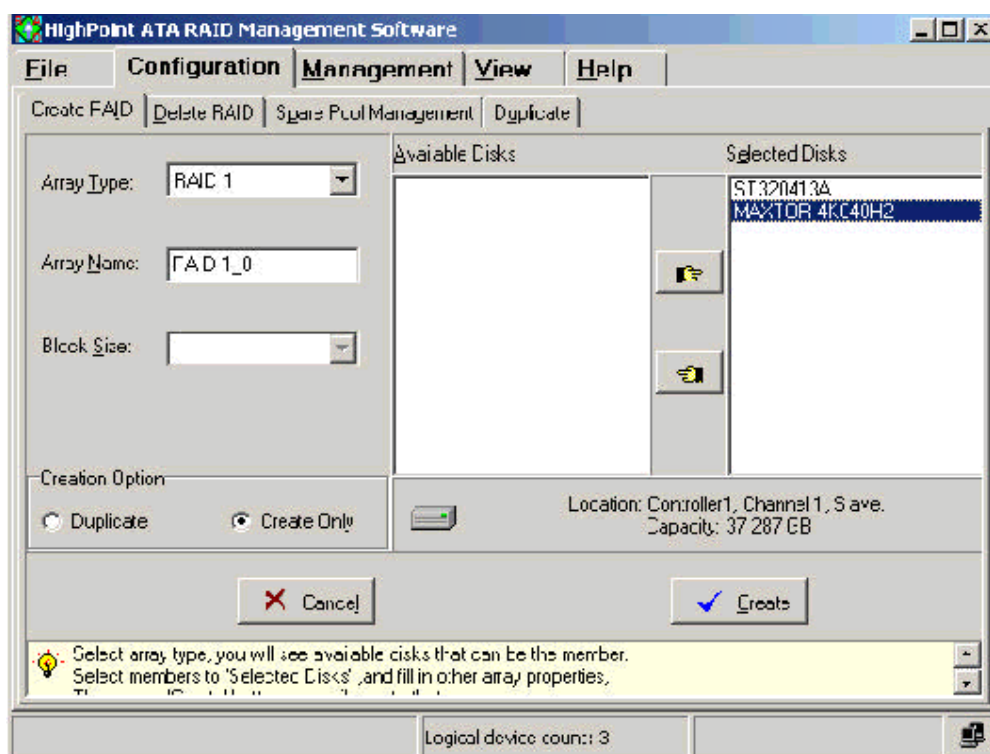

Array Type: Select the array type you want to create by RAID 0, RAID 1, JBOD and RAID 0/1 in this drop-down list box.

Array Name: Specify an array name of eight characters or less for the array you want to create. If you don't specify an array name, the system will assign one automatically.

Block Size: When you want to create a RAID 0 or RAID 0/1 array, you need to specify the block size for the array. Select the block size by 64K, 32K and 16K in the **Block Size** drop-down list box. Generally, the larger size is, the more performance the system gets.

Creation Option: When you want to create a RAID 1 array, you can select either **Duplicate** or **Create Only** radio buttons. The first option means creating a RAID 1 array and copying data from source disk to target disk. The second one means creating a RAID 1 array only, not copying data. So it is usually for two new disks.

Available Disks: All the auto-detected available disks of your computer are listed in this pane.

Selected Disks: Select the physical disks from the Available Disks list box and click the "right hand" button to add them to the Selected Disks list box. You may cancel your selection. First click the disks from the Selected Disks list box. Next, click the "left hand" button to return the disks to the Available Disks list box.

If the selected disks are not enough to create an array, an Information dialog will pop up, prompting you to select more disks to create the RAID array. Click **OK** to return to the **Create RAID** window.

The Brief Help pane is indicated at the bottom of the **Create RAID** window.

To create a RAID array, follow these steps:

1. Select the array type, name, block size (only for RAID 0 or RAID 0/1 array) and creation option (only for RAID 1 array).
2. Select the physical disks from the Available Disk list box to the Selected Disks list box.

3. Click **Create**. A warning will be displayed. Click **Yes** to continue.
4. You will get a confirmation screen notifying you that the RAID you specified has been created successfully. You will be prompted to reboot. Click **Yes** to reboot. Once you have rebooted your system, your main window will display your built arrays. Click **No** to reboot later.

Warning: If you have created an array and try to use it without first rebooting, you can get possible data corruption.

Deleting a RAID Array

Warning: Deleting an existing disk array could result in its data loss. To delete an array, follow these steps.

1. Click **Configuration -> Delete RAID** in the main window, the Delete RAID window appears.

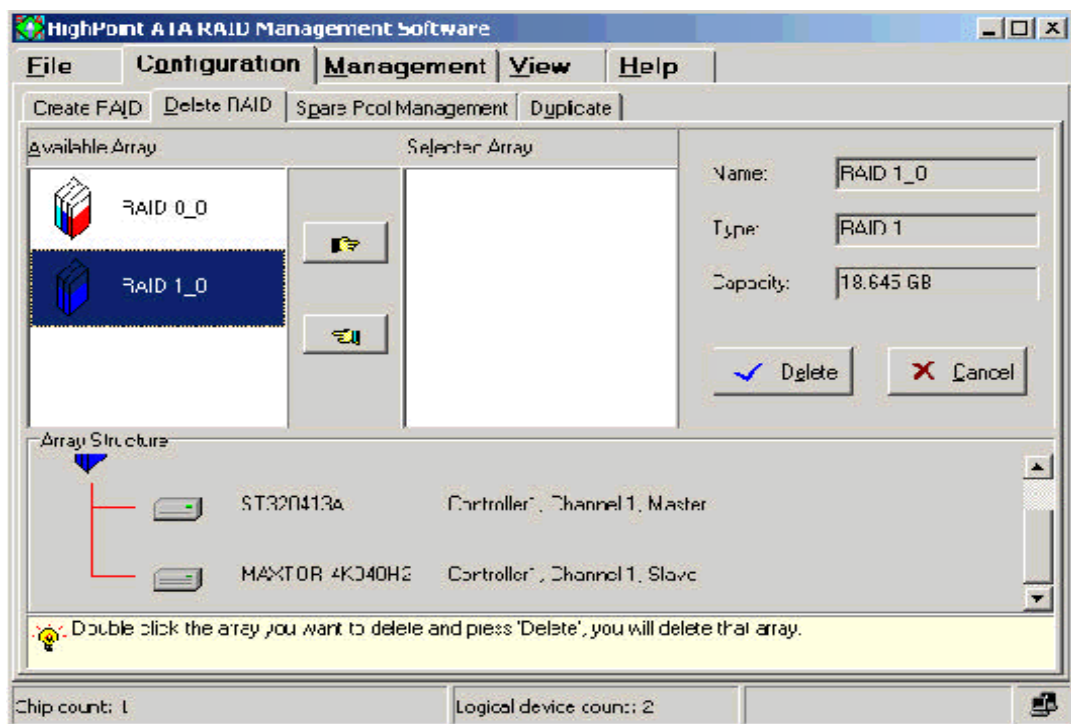

2. Select an array from the **Available Array** list box and click the "right hand" button to add it to the **Selected Array** list

box or double click the array in the **Available Array** list box. The right pane shows the information categories for that array, including **Name**, **Type** and **Capacity**. The **Array Structure** pane shows the device information in the selected array (such as Model Number and Location). If you want to unselect the array, just click the “left hand” button to return it from the **Selected Array** list box back to the **Available Array** list box.

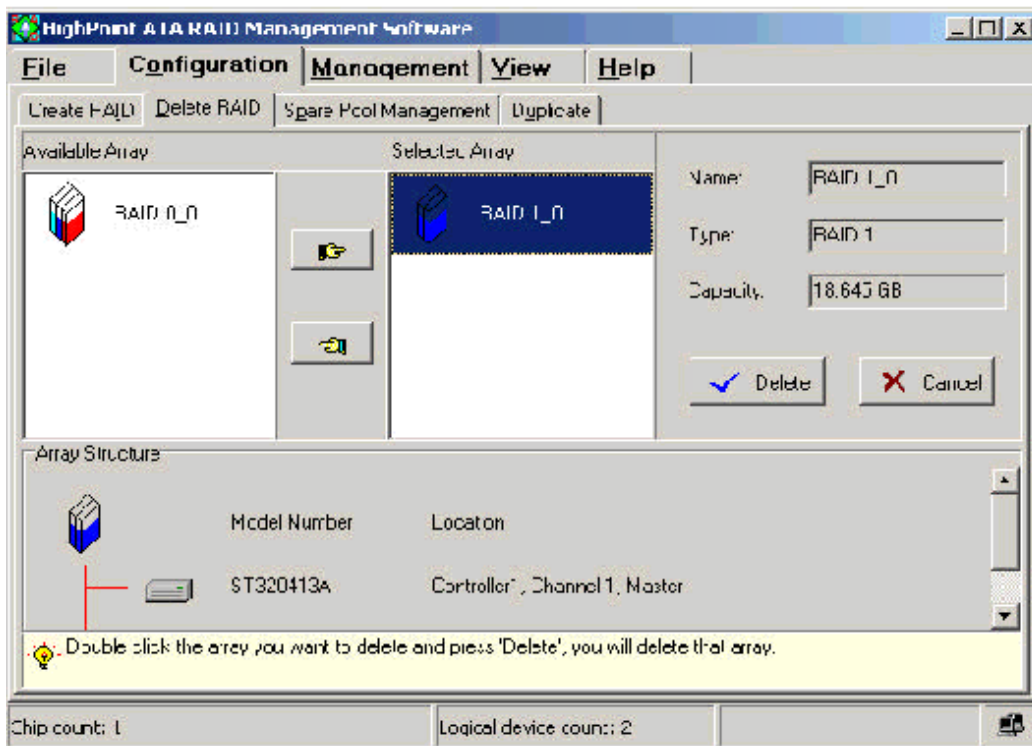

3. Click **Delete**. A warning will be displayed:

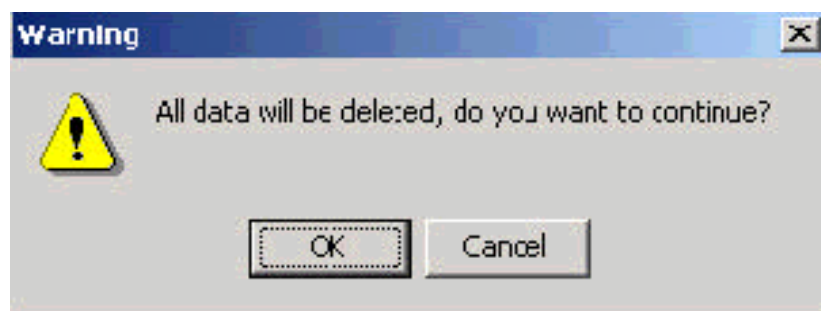

Click **OK** to delete the array. Click **Cancel** to cancel this operation.

4. Once the deletion is completed, you will get a confirmation screen notifying you that the RAID you specified has been deleted successfully. Click **Yes** to reboot the system when prompted for the changes to take effect. Click **No** to reboot the system later.

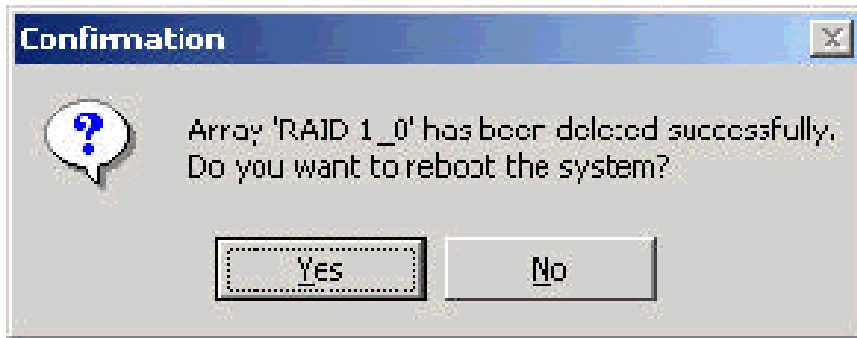

You can also delete an array in the System View window. See the **System View** section.

Managing a Spare Pool

With a spare disk, you can enhance security of RAID 1 and RAID 0/1 array. If one of the disks in the array fails, the system will rebuild the array using a spare disk automatically. **HighPoint ATA RAID Management Software** provides you the function of managing a spare pool. You can add one disk to the spare pool or remove it from the pool one time.

To add/remove a disk to/from the spare pool, follow these steps:

1. Click **Configuration- > Spare Pool Management** in the main window, the Spare Pool Management window appears.

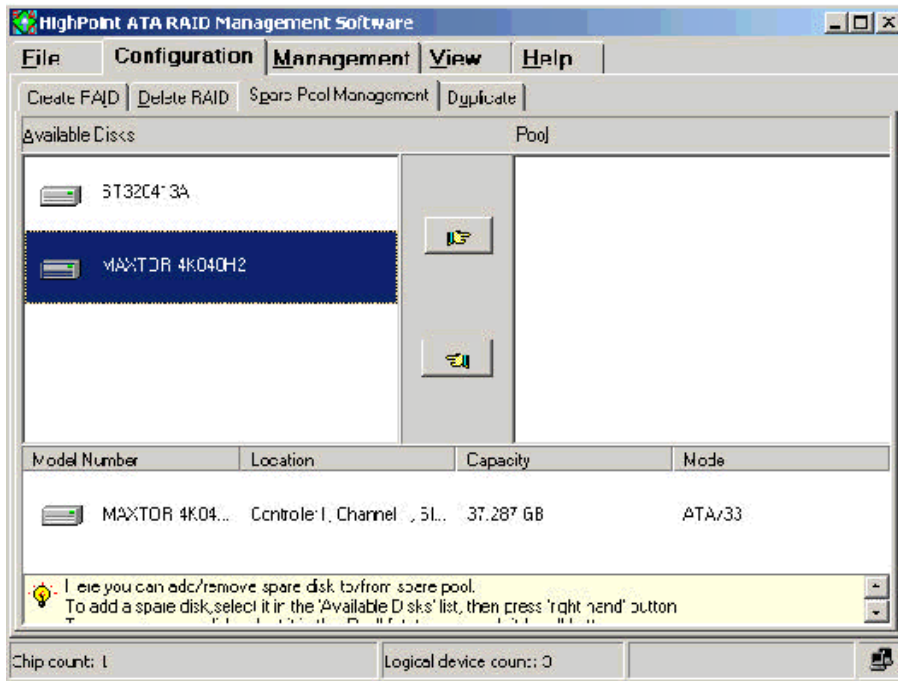

- To add a disk to the spare pool, select a disk from the **Available Disks** list box and click the “right hand” button to add it to the **Pool** list box. Or double click a disk in the **Available Disks** list box. A confirmation screen will pop up, inquiring you if you are sure to add the selected disk to the spare pool. Click **Yes** to continue or **No** to cancel the addition.

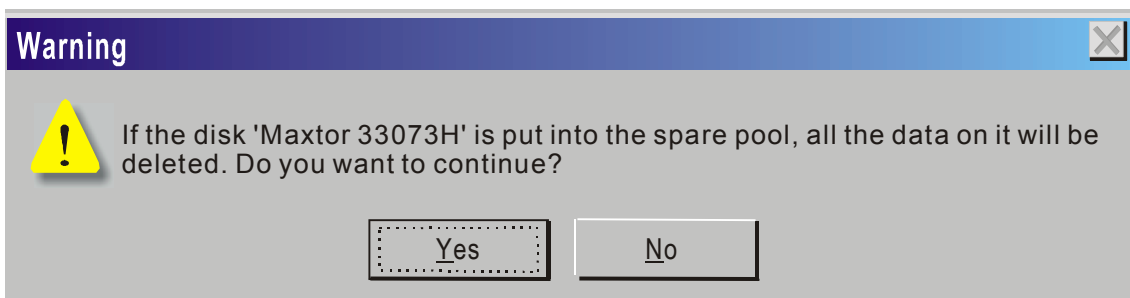

To remove a disk from the spare pool, select a disk from the **Pool** list box and click the “left hand” button to return it back to the **Available Disks** list box. Or double click a disk in the **Pool** list box. A confirmation screen will pop up, inquiring you if you are sure to remove the selected disk from the spare pool. Click **Yes** to continue or **No** to cancel.

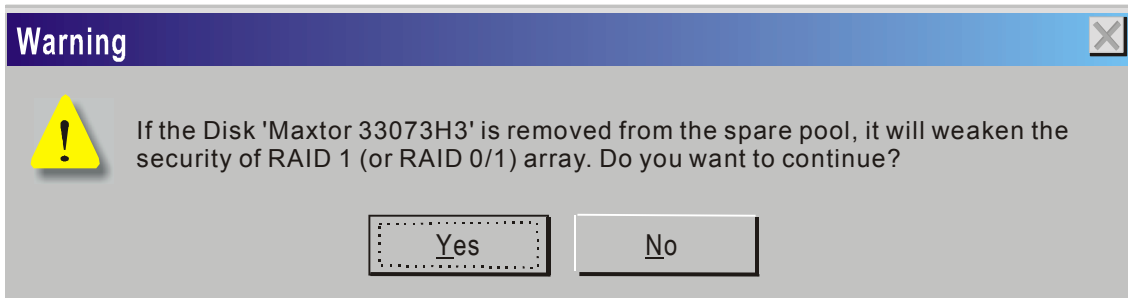

Once you click a disk in the **Available Disks** list box or the **Pool** list box, the device information for that disk appears, including **Model Number**, **Location**, **Capacity** and **Mode**. It will help you to determine which disks will be added/removed to/from the spare pool.

You may also refer to the brief help information at the bottom of the Spare Pool Management window.

Note:

1. When a disk is added/removed to/from the spare pool, the software will ask you to reboot the system, you can reboot at once or later.
2. When there is no RAID 1 or RAID 0/1 array, if you want to add a disk to spare pool, the spare disk will not take effect when the array is broken.

3. When the capacity of spare disk can't fit all the RAID 1 or RAID 0/1 arrays, the spare disk will not take effect when the arrays are broken.

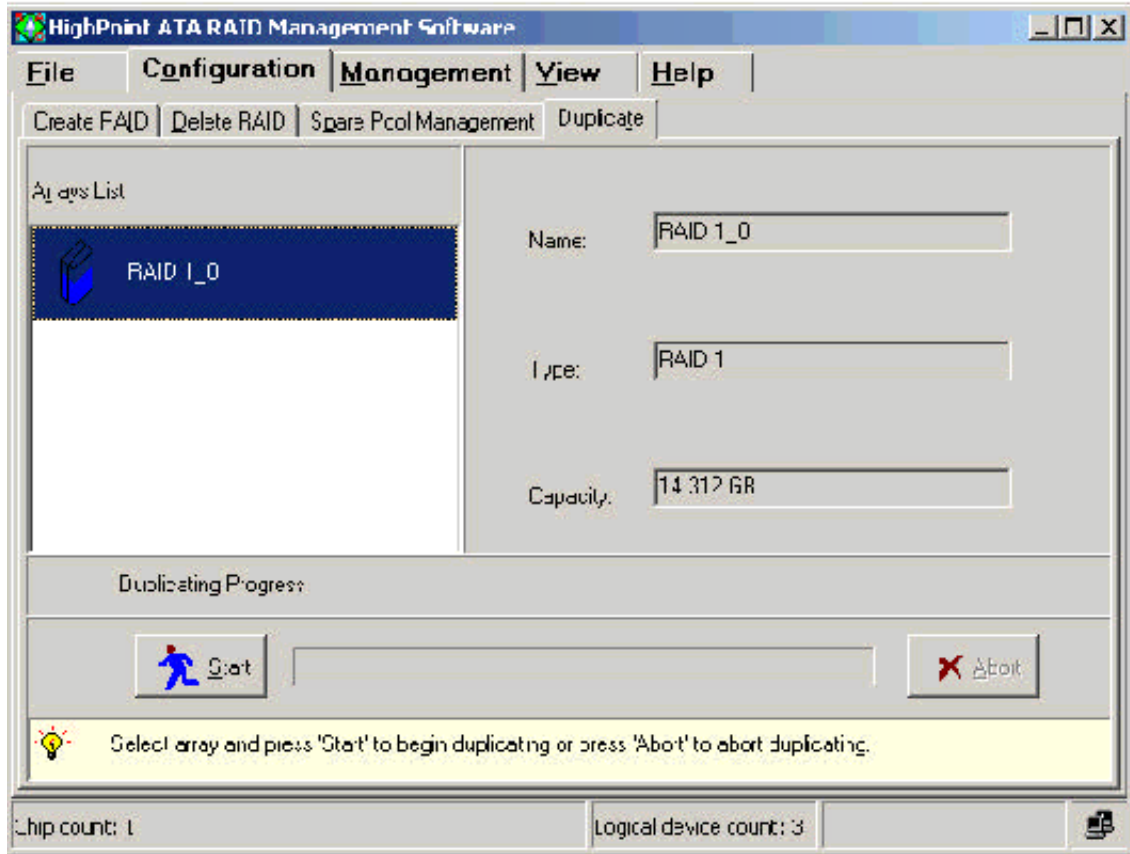

Duplicating an Array

Duplicating will copy data from the source disk to the target disk to ensure data consistency on the mirroring array. This operation will be performed when a failed array member is replaced. Only RAID 1 array and RAID 0/1 array can be duplicated.

To duplicate an array, follow these steps:

1. Click **Configuration** - > **Duplicate** in the main window, the Duplicate window appears.

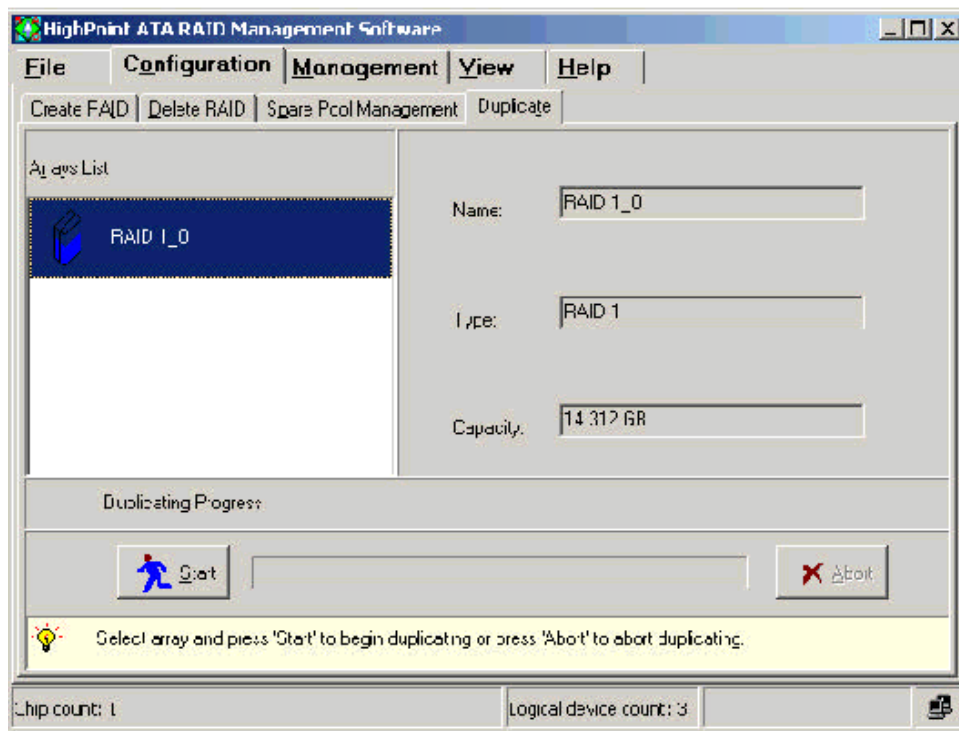

2. Select one of the arrays from the **Array List** box. The array information will display on the right pane, including **Name**, **Type** and **Capacity**
3. Click **Start**. A progress indicator will appear, showing duplicating in progress. Click **Abort** to abort the duplication.

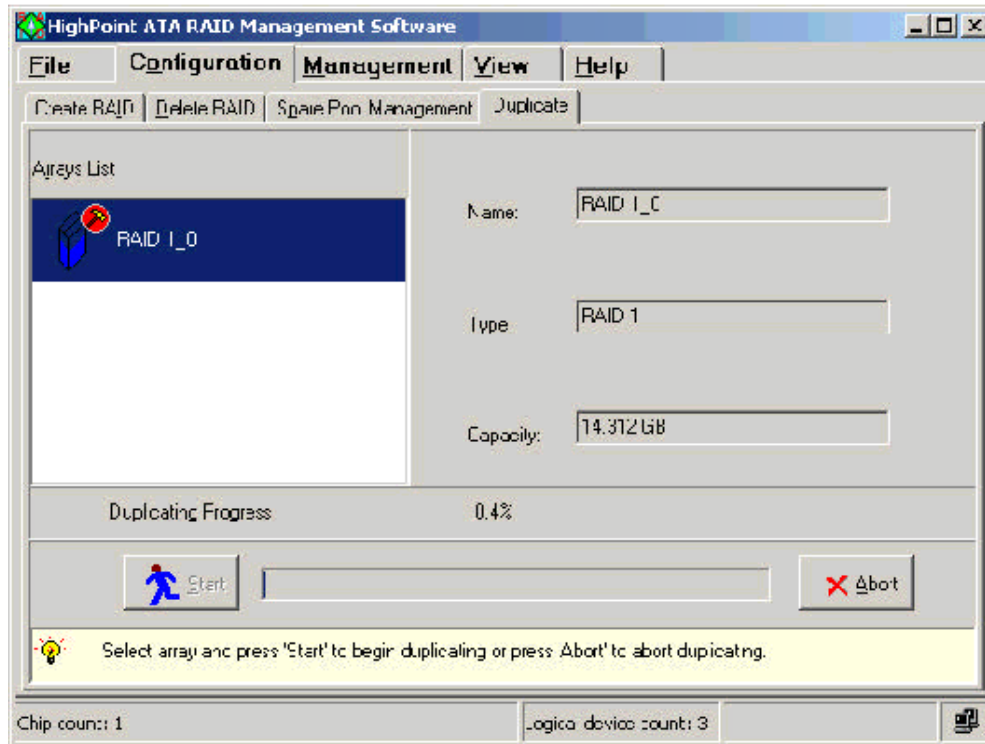

You may also refer to the brief help information at the bottom of the Duplicate window.

Setting Event Notification

HPT ATA RAID Management Software supports event notification function.

When a specified event occurs, the administrator will receive an email in time.

To set an event notification, follow these steps.

1. Click on the **Management** tab in the main window, the Management window appears. There are two sub-tabs in this screen. The **Event Notification** window is the active screen by default.

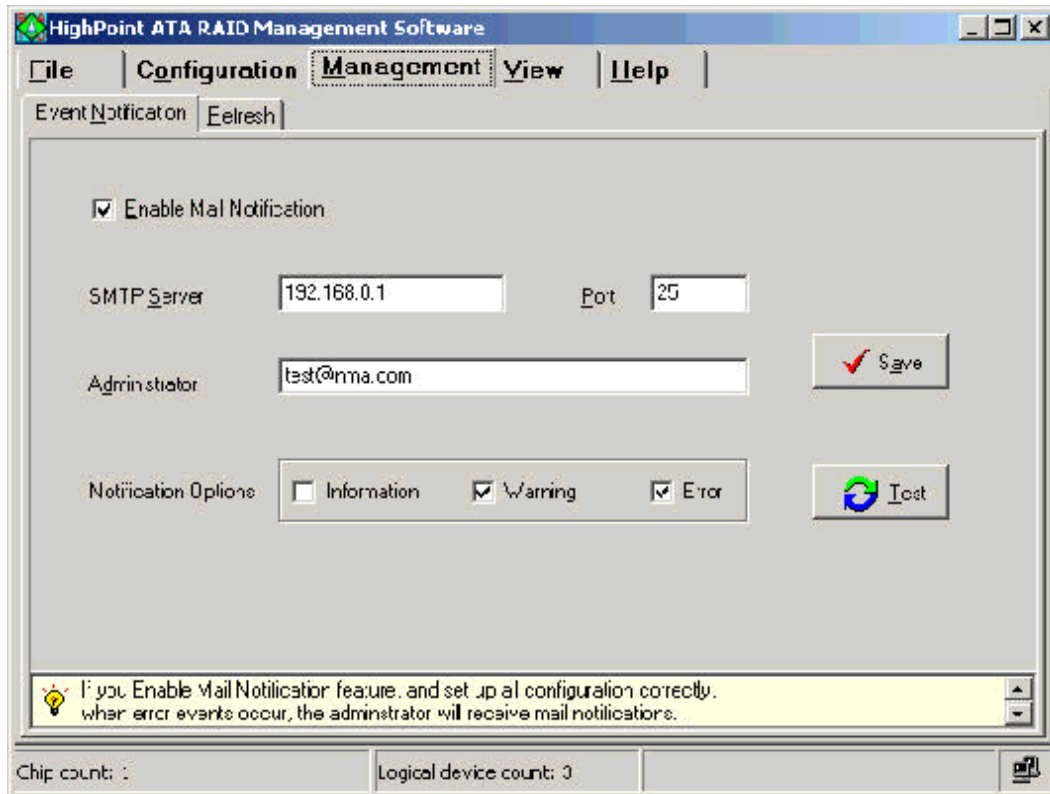

2. Select the **Enable Mail Notification** check box to enable mail notification function.
3. Select the different **Notification Options**.

Information-Select this option to send a common event to the administrator.

Warning-Select this option to send a warning event to the administrator.

Error-Select this option to send a critical event to the administrator.

You may also select one or more of the three options at one time.

4. Set the other layout options as follows:

SMTP Server - You will type the name of your outgoing mail server (SMTP). This setting is provided to you by your Internet Service Provider (ISP).

Port – You will type the server port number. The default is 25.

Administrator – You will type the administrator' s e- mail address that you want to notify in this option.

After you fill out all options in this window, you can click **Test** to send a testing mail to the relevant people. If the pop-up message reports success, click **Save** to save the settings. Otherwise, the **Error** dialog will be displayed:

Fail to send the mail to the administrator.

Click **OK** to return to the **Event Notification** window to modify the options in it.

You may also refer to the brief help information at the bottom of the **Event Notification** window.

Refresh

When you click on the **Refresh** tab in the Management window, the **Refresh** window will not appear. The system will rescan all devices and jump to the **System View** window automatically at the same time.

You can also rescan all devices in the System View window. See the **System View** section.

Viewing System Information

To run **HighPoint ATA RAID Management Software**, double-click the icon on the desktop. After the Welcome window, the main window appears. It has five tabs: **File**, **Configuration**, **Management**, **View** and **Help**. The **View** window is the active screen by default. And the **System View** window is the default screen in it. The devices that the system auto-detected show in this window, including the logical devices, the physical devices and the controllers. The status bar displays information about **Chip count**, **Logical device count**, etc. You'll get additional info when moving you mouse over an icon for a while.

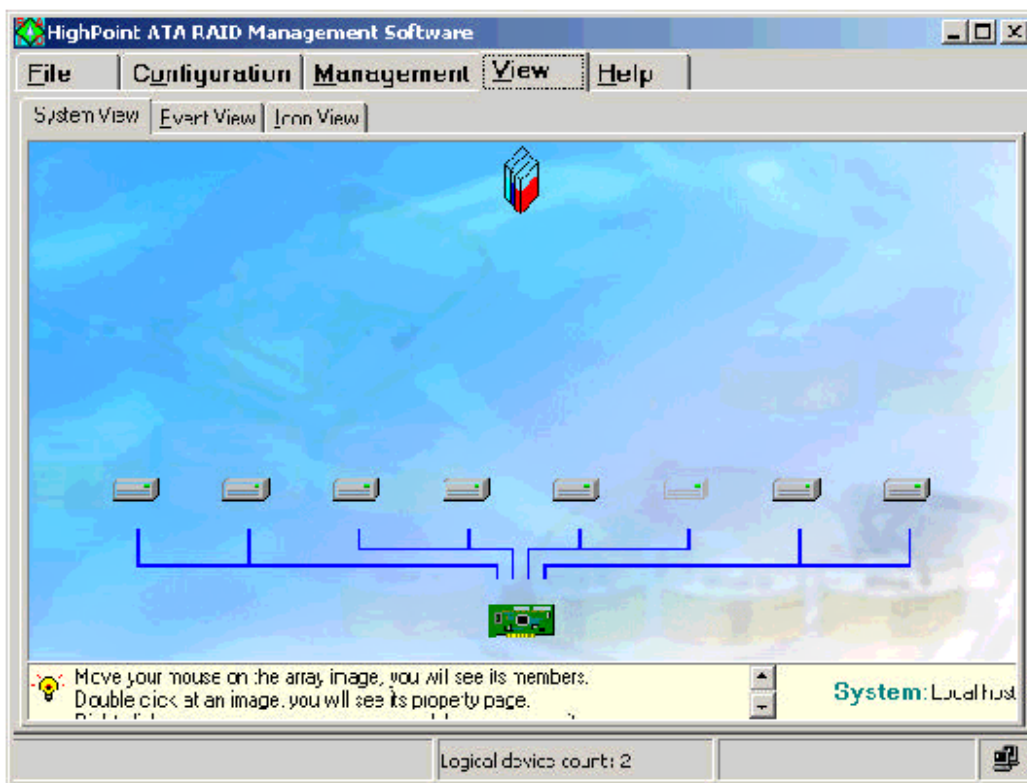

You can perform the following operations in this window.

1. Viewing Device Information

(1) Viewing Logical Device Information

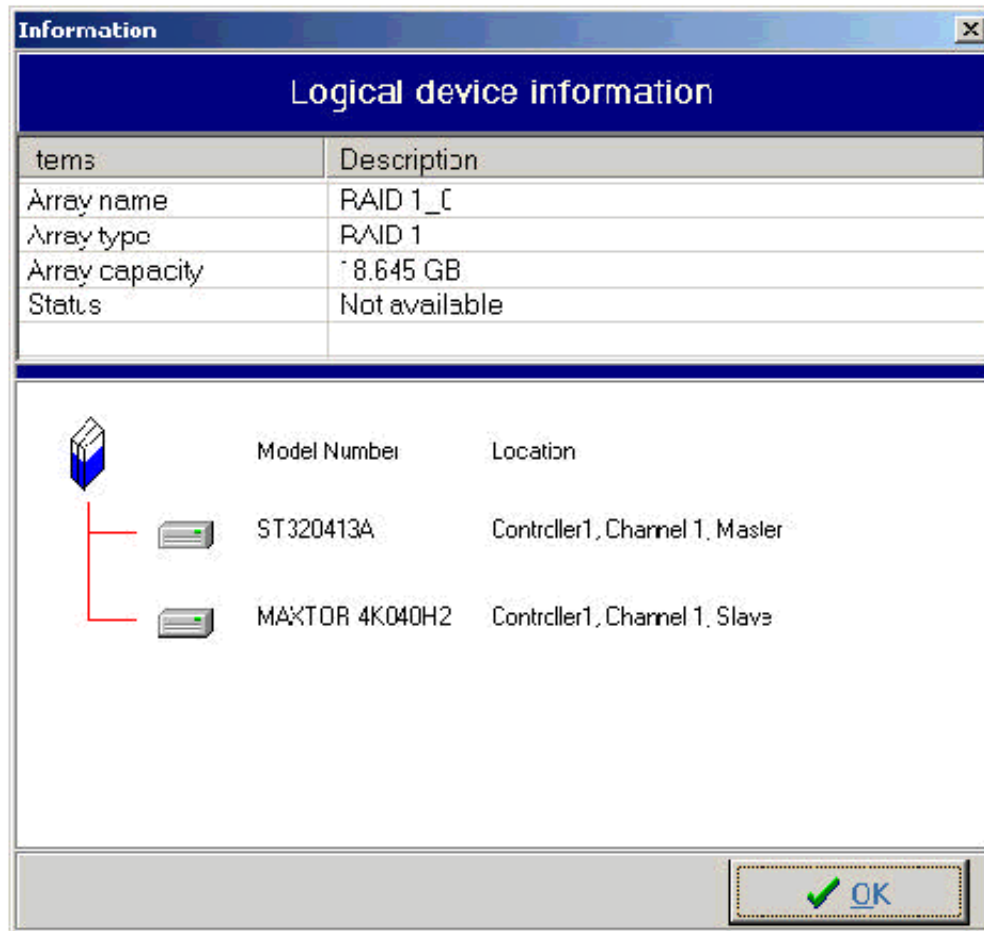

Double-click one of the array icons will pop up the **Logical Device Information** window, listing the following items with their corresponding descriptions and the structure information for that array. Those items include **Array Name**, **Array Type**, **Array Capacity** and **Status**. The structure displays the member disks of the array with their **Model Number** and **Location** information. Click **OK** to return to the **System View** window.

(2) Viewing Physical Device Information

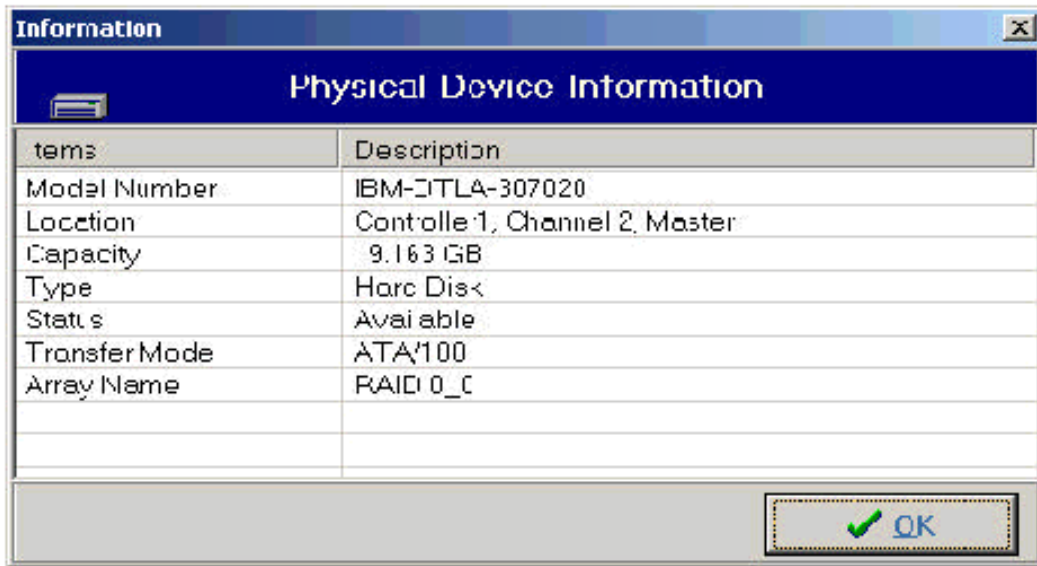

Double-click one of the physical device icons will invoke the **Physical Device Information** window, listing the following items with their relevant descriptions.

Those items include **Model Number**, **Location**, **Capacity**, **Type**, **Status**, **Transfer Mode** and **Array Name**. Click **OK** to return to the **System View** window.

(3) Viewing Controller Information

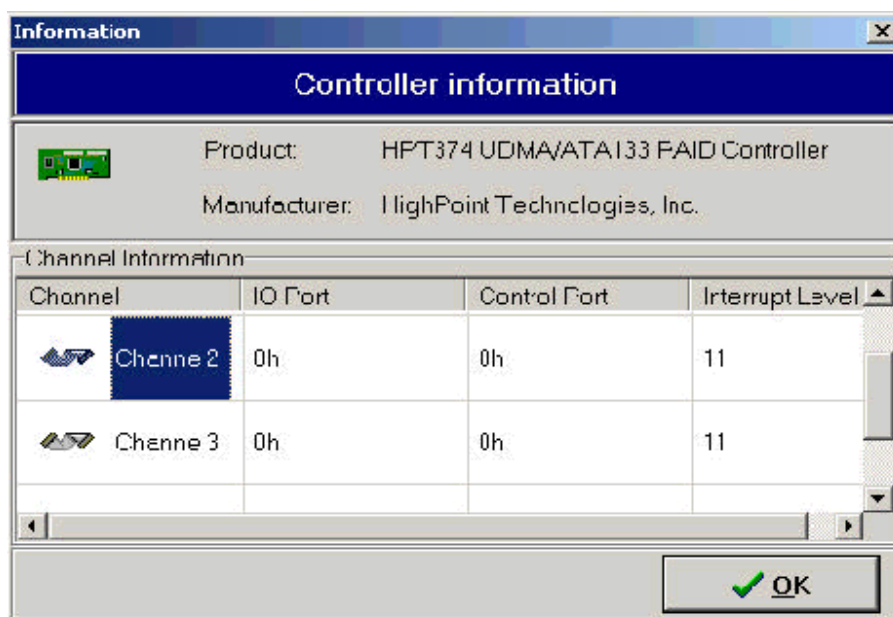

Double-click on one of the controller icons will bring up the **Controller Information** window, listing the **Controller Information** and **Channel Information** items. The Controller Information item includes the **Product** and **Manufacturer** info and the Channel Information item includes **Channel**, **I/O Port**, **Control Port** and **Interrupt Level** info. Click **OK** to return to the **System View** window.

2. Viewing Device Relationship

(1) Viewing Relationship between Logical Device and Physical Device
When you move your mouse on a logical device, a red line between the specified array and a group of physical device appears. These physical devices are the array members.

(2) Viewing Relationship between Physical Device and Controller
The blue lines represent data channels between the physical devices and the controllers.

3. Deleting a RAID array

Right click the array icon you want to delete, you will activate a drop-down menu. Choose the **Delete** item on the menu. A warning message box appears, prompting you all data will be deleted. Click **Yes** to confirm deletion and click **No** to cancel this operation. After the deletion of the array, you will be prompted to reboot the system. Choose **Yes**, the system will be rebooted and the changes will take effect. Choose **No** to reboot later.

You can also delete an array in the Delete RAID window. See the **Delete a RAID Array** section.

Note: If the array is bootable and being duplicated, it can not be deleted. You can delete it in BIOS.

4. Renaming a RAID Array

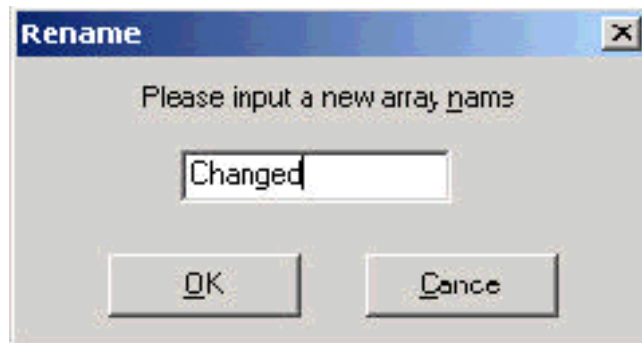

Right click the array icon you want to rename will activate a drop-down menu. Choose the **Rename** item on the menu. The **Rename** message will appear. Enter the new array name, and then click **OK**.

Note: If the array is broken or disabled or being duplicated, it can not be renamed.

5. Refreshing System Devices

Right click your mouse on the blank place in the **System View** window will appear the Refresh menu. Click the menu to refreshing the system devices.

You may also refer to the brief help information at the bottom of the System View window.

Viewing Events

Click **View-> Event View** to open the **Event View** window.

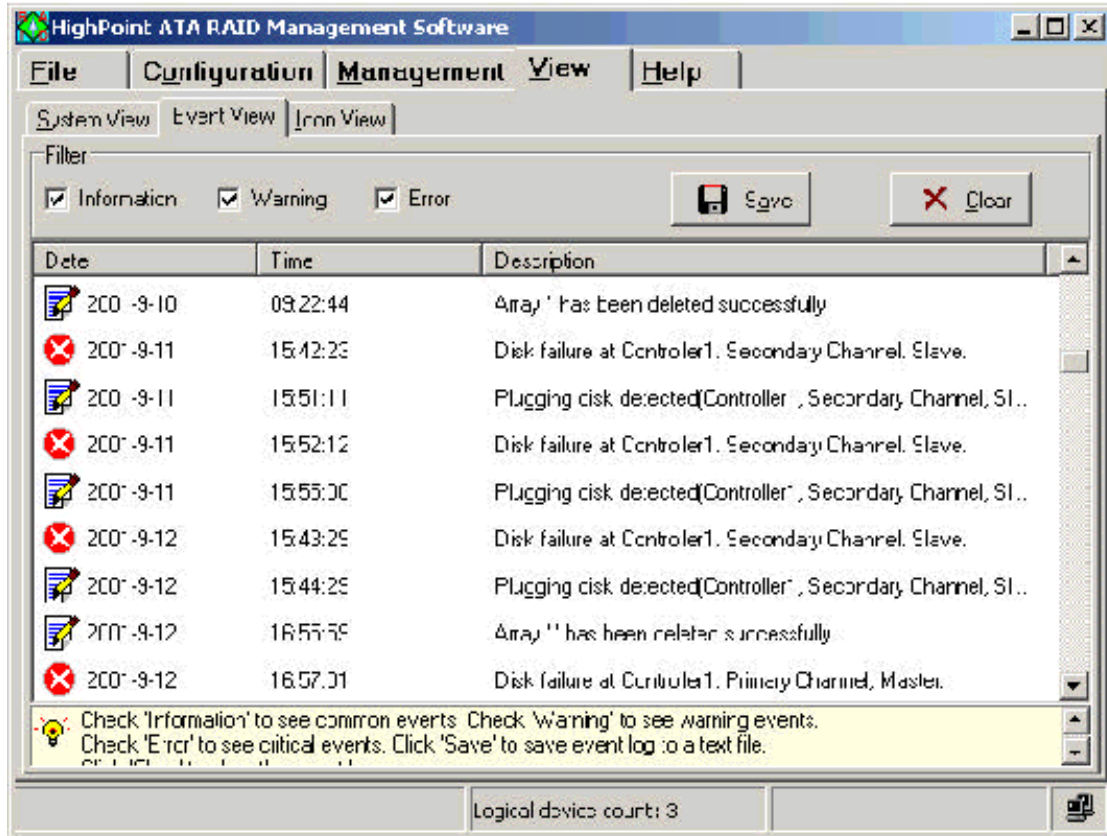

All events are logged in this window. The filter divides them into three types:

Information, Warning and Error.

Select the **Information** check box to view common events.

Select the **Warning** check box to view warning events.

Select the **Error** check box to view critical events.

Or you may select all the three check boxes to view all events info at one time.

The filtered events will be displayed in the lower pane, including **Date**, **Time** and the corresponding **Description**. You can drag the slider up and down in the scrolling bar to view the contents in the event window.

After selection of the events, click **Save** to save the filtered event logs to a test file or **Clear** to clear all events logs in the system.

You may also refer to the brief help information at the bottom of the Event View window.

Note:

You can enable mail notification function when an event occurs. See the **Setting Event Notification** section.

Viewing Icon Legend

Each icon has its unique meaning in **HighPoint ATA RAID Management Software**. You can get its meaning from the **Icon View** window.

Click **View- > Icon View** tab to open the **Icon View** window. All icons and their descriptions appear in this software.

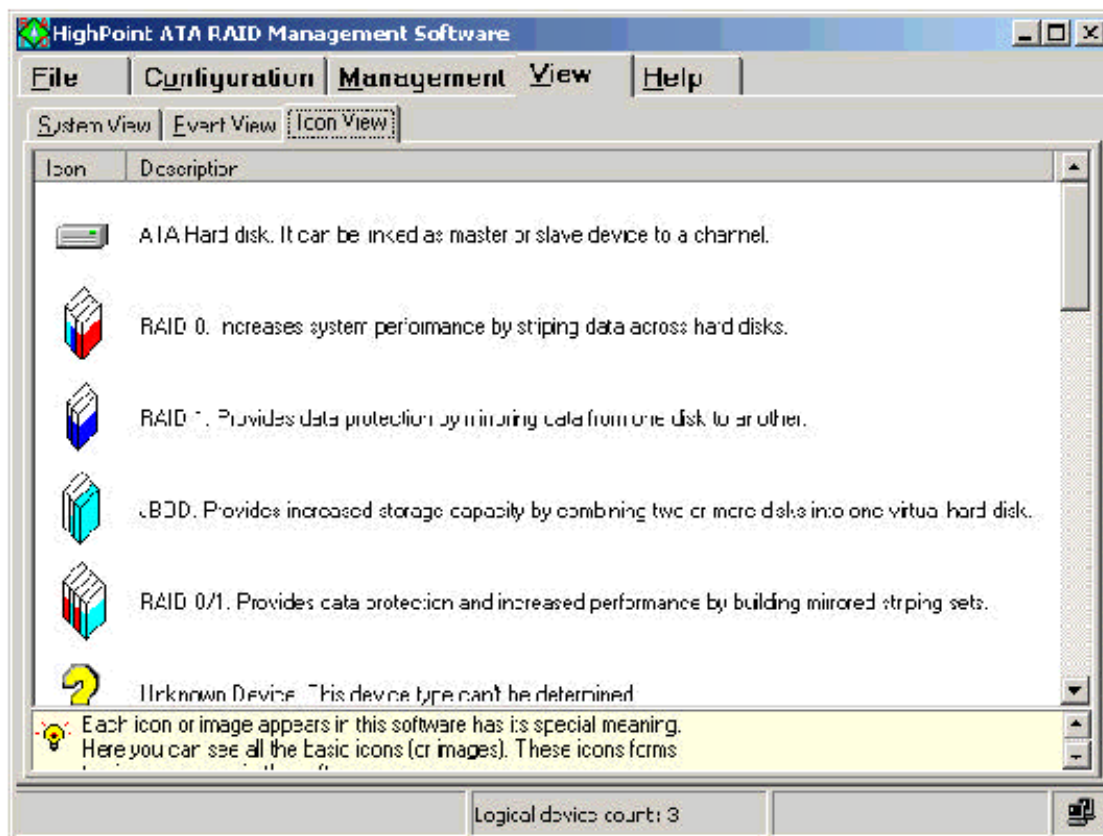

Other Features

Besides the above functions, HighPoint ATA RAID Management Software includes the following additional features, which can keep maximum data integrity and consistency in arrays.

Auto-detect hot-plug disks

If a disk is removed when it is running I/O operations or when some I/O errors occur in this disk, users will be informed. When the disk doesn't run read/write operations, users can use the refresh function to scan the system. Similarly, when you insert a new disk, refresh it, the software will find the disk.

Auto-rebuild RAID 1 or RAID 0/1 array

HighPoint ATA RAID Management Software supports the auto-rebuild function in the sense that data in the source disk will be copied to the mirror disk.

This software can help users to auto-rebuild RAID 1 or RAID 0/1 array under the following 2 conditions.

1. A spare disk exists in the spare pool. When a source disk in a RAID 1 array fails, a mirror disk will replace it automatically and the spare disk will become the mirror disk. If a mirror disk fails, the spare disk will auto-replace it to be the mirror disk.
2. When a disk is added to a RAID 1 or RAID 0/1 array and the array resumes normal, the auto-rebuild function will be started.

Add disks to broken arrays

If a RAID 1 or RAID 0/1 array is broken and there is an idle physical disk, you can add it to the array. The system will auto-rebuild the array at the same time.

You can use the above 3 features together. For example, insert a hard disk, refresh the system, the software will prompt you to add the disk to broken arrays. If you select one, the disk will be added to the broken array and the rebuild procedure will auto-start in the meantime.

How to Verify if the HPT372 RAID Controller Setup is Successful

Verify Installation on Windows 98/98SE/ME

When the driver has been successfully installed and the computer restarted:

1. Right-click **My Computer** icon on desktop, and then select **Property** item from the popup menu.
2. Select **Device Manager** item from the popup window.

If there is an HPT370/HPT372 item under **SCSI Controllers**, it indicates that the driver has been installed properly.

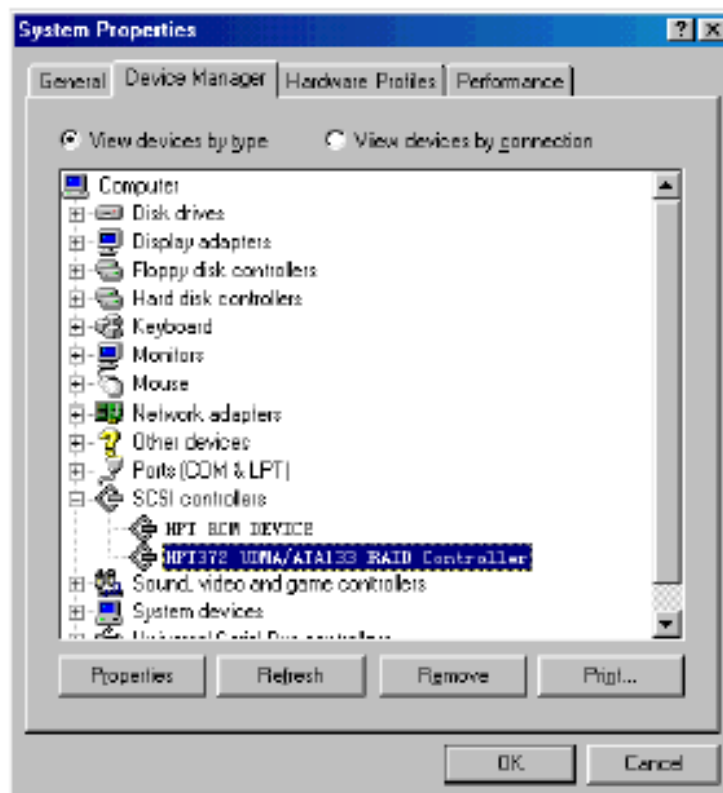

If you cannot find these two above-mentioned device items, or there are **?** or **!** on device icon, it indicates that the driver has not been correctly installed and needs reinstallation.

Verify Installation on Windows NT 4.0

When the driver has been successfully installed and the computer restarted:

1. Click **Start-->Setup-->Control Panel**, and then double-click **SCSI Adapter** item.
2. If there is **HPT370/HPT372 UDMA/ATA RAID Controller** item in the popup window, it indicates that the driver has been successfully installed. Otherwise, users need to reinstall the driver.

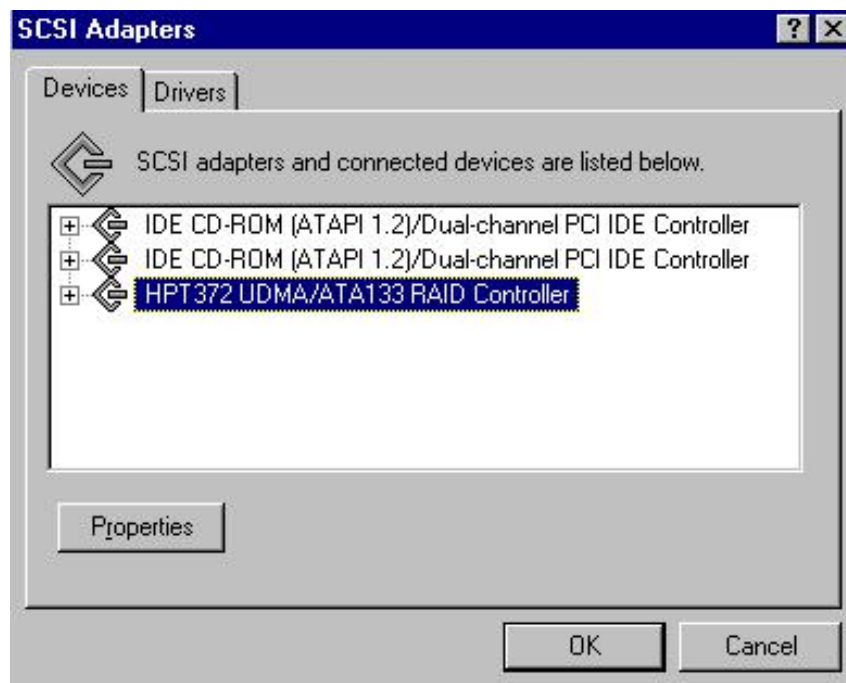

Verify Installation on Windows 2000

When the driver has been successfully installed and the computer restarted:

1. Right-click **My Computer** icon, select **Property** item in the popup menu.
2. In the popup window, select **Hardware** item and then click **Device Manager** button.

If there is **HPT370/HPT372 UDMA/ATA RAID Controller** item in the popup **Device Manager** window, it indicates that the driver has been successfully installed. Otherwise, please reinstall the driver.



Verify Installation on Windows XP

After the driver has been installed and the computer restarted:

1. Right-click **My Computer** icon, then select **Property** item from the popup menu
2. In the popup window, select **Hardware** tab and then click **Device Manager** button.

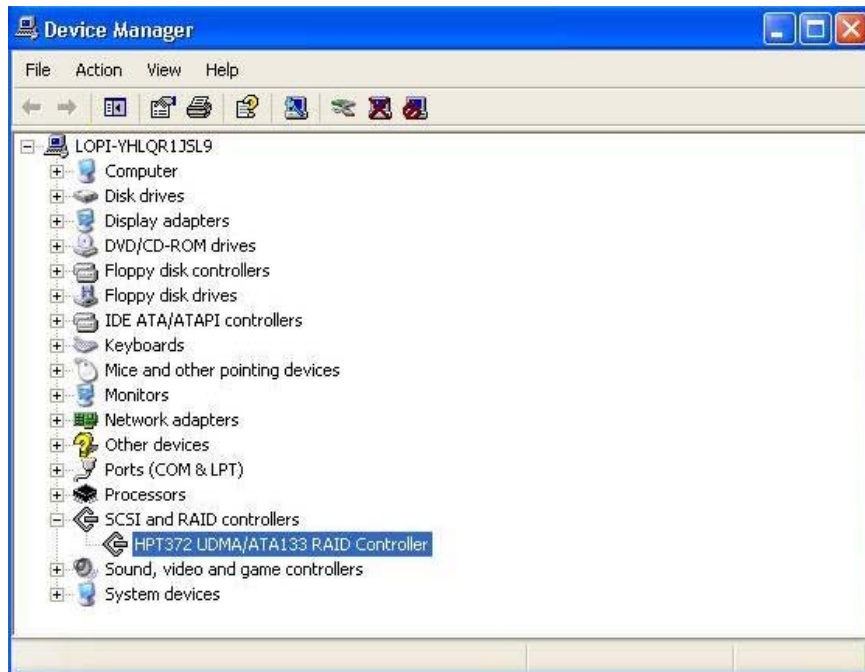

If an **HPT370/HPT372 UDMA/ATA RAID Controller and HighPoint RCM Device** item exists in the popup **Device Manager** window (see above), it indicates that the driver has been successfully installed.

Otherwise, if user cannot find these four device items, or there is **?** or **!** markings on device icon, it indicates that the driver has not been correctly installed and user needs to delete the devices and reinstall the drivers.

APPENDIX B

C-Media Sound Solution

OVERVIEW AND ACKNOWLEDGMENTS

C-Media 5.1 Channel Audio offers a new generation in audio solution: it utilizes the state-of-the-art CRL® 3D Audio technology (HRTF 3D positional audio), and supports Microsoft® DirectSound® 3D and Aureal®'s A3D® interfaces. Better yet, it supports 2/4/6 speakers and DLS based (DownLoadable Sound) wave table music synthesizer which supports the DirectMusic®. Besides being legacy audio SB pro® compatible and providing professional SPDIF IN/OUT non-distortion digital interface, it also supports MPU-401 interface, dual game ports, etc. What we provide at the side card are line-in/rear speaker jack, microphone jack, audio output jack, SPDIF/OUT jack, and 15pin D-SUB multiplexed joystick/MIDI

In additional, CMI8738 plus C-Media XeaR technology to brings forth a true earphone revolution in the way sound is heard and enjoyed in the multi-channel audio environment. Simply via an open-aired ear/headphone-like structure device, C-Media XeaR technology is capable of providing virtual rear sound effect compensation for the multi-channel audio system. For other virtues, C-Media XeaR technology helps to eliminate installation works (for example, speaker placement and installations), reduce the cost for purchasing rear speakers, and above all, retain major vintage benefits provide by the multi-channel audio system (accurate HRTF 3D, impressive EAX™ effects, to name a few).

Trademark Acknowledgements

Microsoft, Windows, DirectSound 3D, and DirectMusic are trademarks of Microsoft Corporation. Sound Blaster is a trademark of Creative Technology, Ltd. Sensaura EnvironmentFX™ is a trademark of Sensaura, Ltd. Aureal is a trademark of Aureal Inc. A3D is a registered trademark of Aureal Inc. C3DX™ is a trademark of C-Media electronics Inc. All other trademarks and registered trademarks mentioned in this manual are the property of

their respective holders and are hereby acknowledged.

World's 1st Earphone-like Apparatus for Compensating Rear Sound Effects



C-Media **XeaR technology** is capable of providing virtual rear sound effect compensation for the multi-channel audio system. For other virtues, C-Media **XeaR technology** helps to eliminate installation works (for example, speaker placement and installations), reduce the cost for purchasing rear speakers, and above all, retain major vintage benefits provide by the multi-channel audio system (accurate HRTF 3D, impressive EAX™ effects, to name a few). By way of software technology, **XeaR** supply all customers of C-Media Audio solution to enjoy this function. Moreover, its can unrestricted any brand of headphone and base on your budget to choice any device what you like.

Special Features

- Full-duplex playback and recording. Built-in 16-bit CODEC.
- HRTF-based 3D positional audio (C3DX™) for earphone and 4/6 CH speakers output, supporting both DirectSound 3D® & A3D® interfaces.
- Comprehensive driver support: Windows 98/98SE, Windows ME, Windows 2000, Windows XP and Windows NT 4.0 Linux, BeOS, etc....

- MPU-401 Game/Midi port and legacy audio SB Pro support.
- Downloadable Wave Table Synthesizer, supporting Direct Music®.
- Professional digital interface, supporting 24-bit SPDIF IN/OUT (Hardware 44.1K and 48K in/out).
- Microphone echo and Karaoke ascending/descending key effects.
- CMI8738/PCI-6CH with *XeaR technology* support.

Digital Audio (SPDIF IN/OUT)

- Up to 24-bit stereo 44KHz sampling rate; voice playback/recording.
- Full-duplex playback and recording. 120dB audio quality measured.
- Auto detectable SPDIF/IN signal level from 0.5V to 5V.

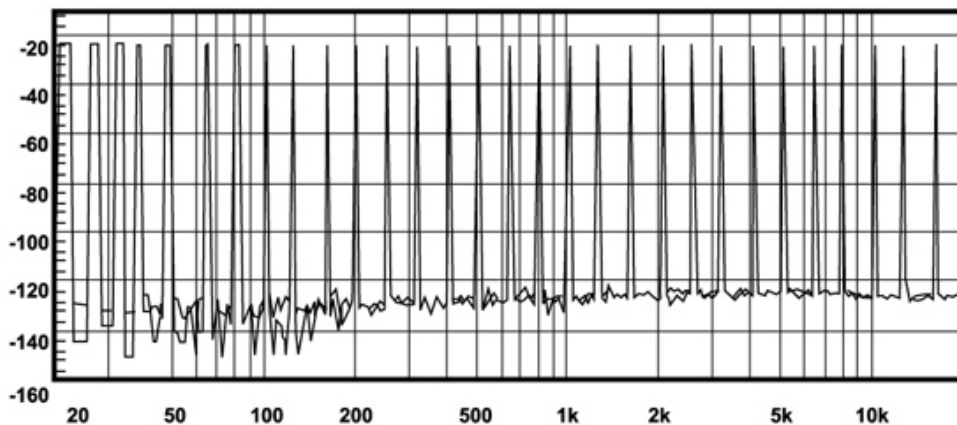

120dB audio quality in playback, recording, and bypass modes.

Stereo Mixer

- Stereo analog mixing from CD-Audio and Line-in
- Stereo digital mixing from Voice, FM/Wave-table, and Digital CD-Audio
- Mono mixing from MIC Software adjustable volume.

Game and MIDI Interface

- Fully compatible with MPU-401 Midi UART and Sound Blaster Midi mode/Standard IBM PC joystick/game port (dual channels)

Driver Installation/Un-installation Procedure

DOS INSTALLATION

Before the installation, please make sure that your hard disk has sufficient space (min. 4MB). Insert the Driver CD into the CD-ROM Drive.

- ❶ Change directory to PCI audio DOS drivers folder (ex. D:\Audio\cmi8738_6Ch\Dosdrv) at DOS prompt, and type:

INSTALL [Enter]

- ❷ Type the DOS utilities path you want to install the file in.
- ❸ Program will expand the file to the path you've specified.
- ❹ Install program will add initial drivers into AUTOEXEC.BAT file.

WIN95/98/98SE/ME/2000/XP INSTALLATION

C-Media audio device driver and software media application provide much more than your imagination. When you insert installation CD, set up program will automatically pop up installation dialog box and user can follow the program step by step to completed set up.

- ❶ Insert SOYO driver CD
- ❷ Set up program will pop up dialog box as follow:
- ❸ You can select to install both driver and application or one of them.

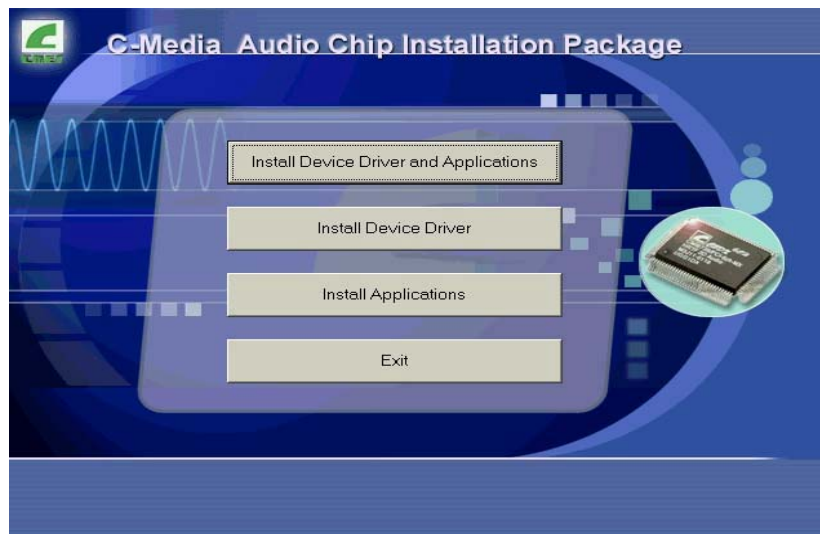

④ User can choose favorite language



⑤ This dialog box was reminded you some information about agreement.



- ⑥ Select folder to set up program. (Recommend select as default setting)



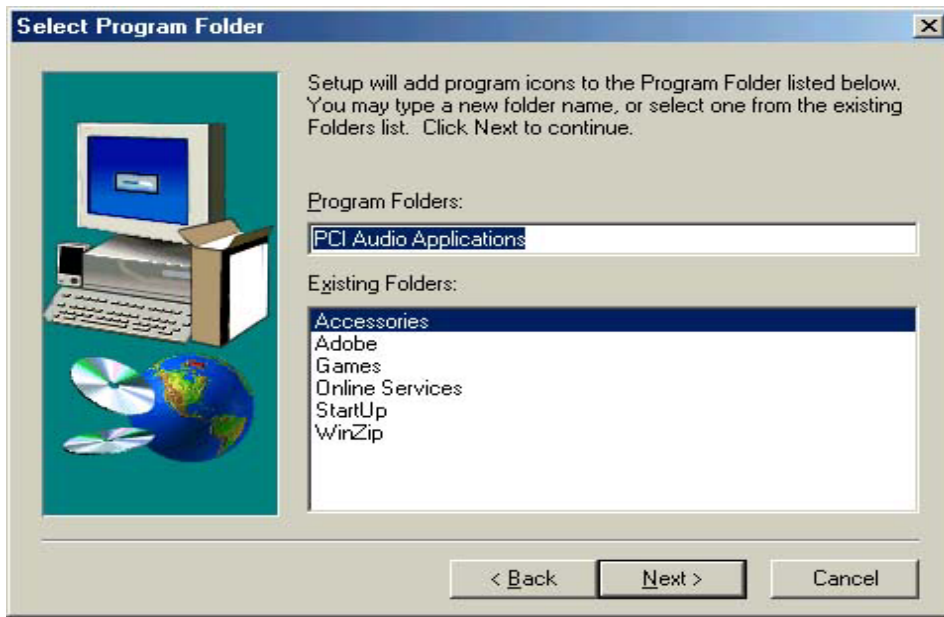

- Proceeding install procedure (Include components copy and device search...)



- Setup program will extract Microsoft DirectX and Direct media components.

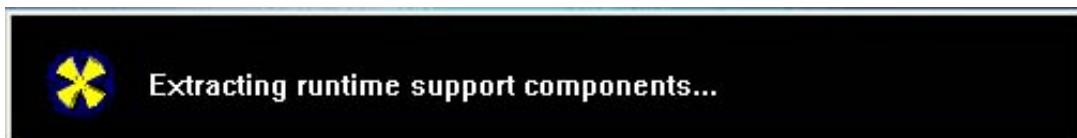

- ⑨ After copy and extracting, set up program will install device driver and this step will take some time, please be patient.

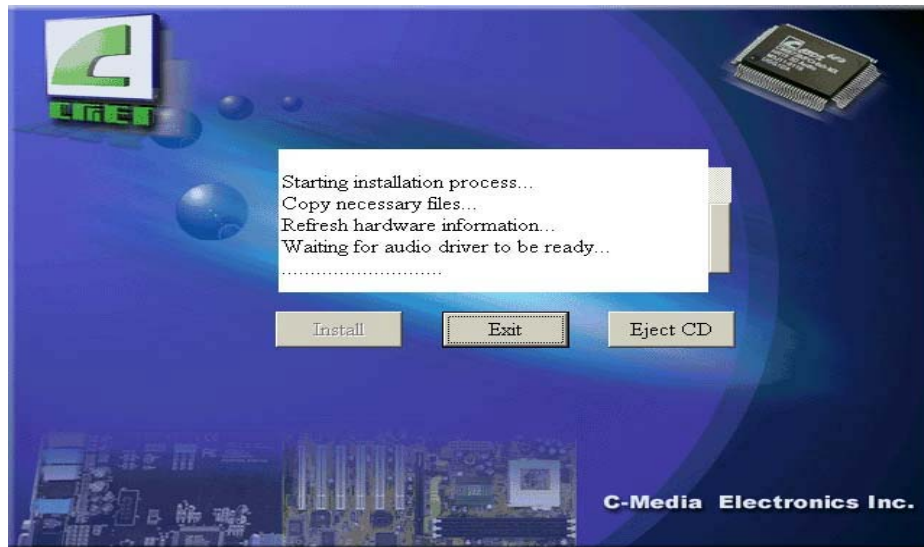

- ⑩ When finished set up the program will pop up a dialog picture to show multi-channel speaker environment. User should select which speaker mode he or she wants.



After whole installation procedure has finish, you will need to restart your computer for enable driver and application functions.

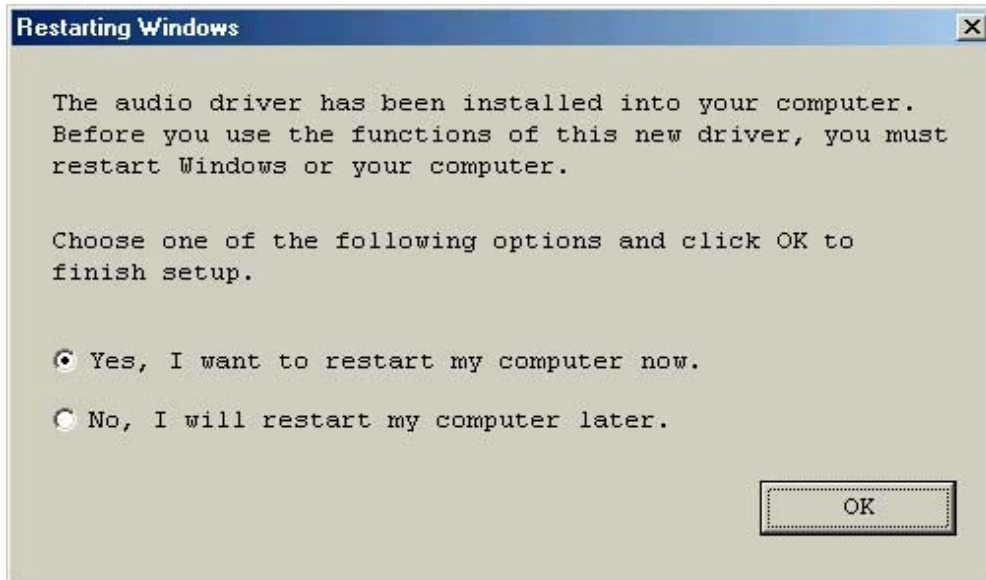

3.3 WIN95/98/98SE/ME/2000/XP UN-INSTALLATION

- ❶ If you want to remove audio driver or application you can use uninstall function on “PCI Audio Application”.



- ② The uninstall program will confirm your step. If you want to remove those programs then click “Yes”.



- ③ When you click “Yes”, program will remove files and components.

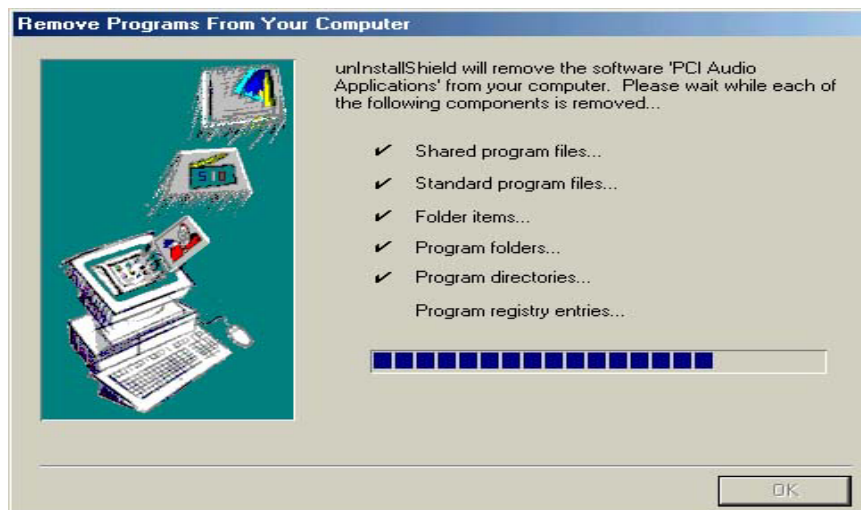

WINDOWS NT 4.0 INSTALLATION

We recommend that you install Windows NT 4.0 before you install this PCI audio card, and you not install any other sound card device drivers in your current system.

1. Click “Start”, move the highlight bar to “Setting”, and select the “Control Panel”.
2. Double-click “Multimedia”.
3. Select “Devices”, and press “Add”.
4. Select “Unlisted or Updated Driver” in “List of Drivers”.

5. Specify the drive path where NT drivers are in (such as D:\Audio\cmi8738_6Ch\NT40\Drv).
6. Select "C-Media CM8738," and press "OK".
7. Select proper I/O value.
8. Press "OK."
9. Restart the system when being asked.
10. Now, you have already installed the PCI Audio Adapter under Microsoft Windows NT 4.0 successfully. if you want to install the Windows applications, continue the following steps:
11. Click "Start".
12. Select "Run".
13. Key in drive path where the Windows NT application installation program are in; for example, "D:\Audio\cmi8738_6Ch\NT40\Drv\APP\SETUP.EXE"
14. Click "OK" to start the installation procedure, and follow the on-screen instructions to complete the installation. When all of application software has been installed, shut down the Windows NT system, and then reboot your system.

C-Media Power Mixer

①Volume Control

For each output signal, the control slider regulates the loudness whereas a horizontal slider the balance between the two speakers. The mute button can temporarily stop the output without changing slider positions. A button with a lit LED means the output is available, and vice versa. Several output signals can usually be enabled at once.

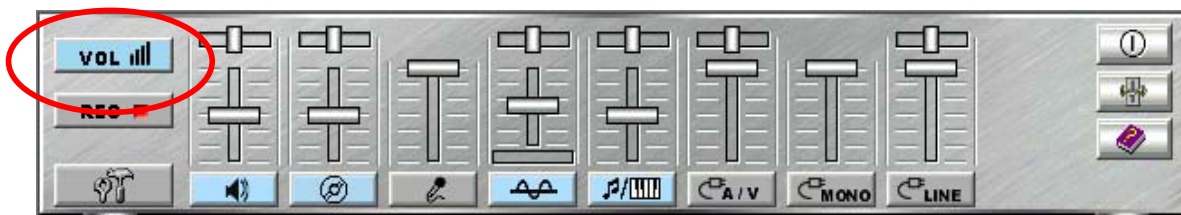

Volume: This is the master control over all outputs. The power of an output signal is determined by both of the volume slider and the slider for the individual output. To modify all the outputs, adjust the volume slider. To change individual output(s), adjust its(their) slider(s).

CD: Regulates the CD drive audio input level.

MIC: Regulates the input level of microphone.

WAVE: Regulates wave (voice) playback levels.

MIDI: Regulates the MIDI music play level.

AUX IN: Regulates the Auxiliary input play level.

LINE IN: Regulates the Line-In levels.

Advanced: Regulates the advanced settings.

Recording Control



For each input signal, a control slider regulates the loudness whereas a horizontal slider the balance between the two channels. The select button can temporarily select input signal without changing slider positions. A button with a lit LED means it is available, and vice versa.

CD: Regulates the CD drive audio input level.

MIC: Regulates the input level of microphone.

WAVE: Regulates wave (voice) playback level.

FM: Regulates the FM music play level.

AUX IN: Regulates the Auxiliary input play level.

LINE IN: Regulates the Line-In level.

SPDIF IN: Enables the recording from SPDIF in. SPDIF-in is mutually exclusive with other input signals.

Advanced: Regulates the advanced settings.

③ Advanced Dialog Box

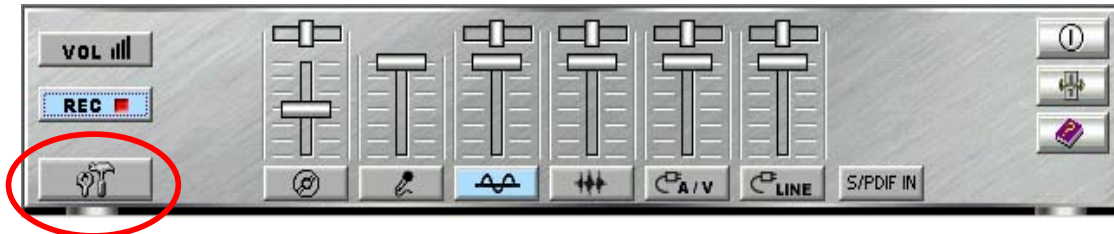

➤ Advanced – SPDIF (Sony/Philips Digital Interface)

SPDIF dialog provides a full control over SPDIF IN/OUT functions. You can use these settings to connect your computer to other pieces of audio device, such as: Mini Disc players, amplifiers...etc.

1. To enable **SPDIF-OUT** should be under 2-channel speaker mode since SPDIF standard only supports 2ch PCM audio data. If users would like to transmit multi-channels audio through SPDIF, users should choose AC-3 Dolby encoded format or DTS like DVD titles. Users can choose **44.1K or 48K Hz** sampling rate of PCM data when using SPDIF-Out.
2. SPDIF Input **Loopback** is used for digital-in to digital-out.
3. **Monitoring** is used for digital-in to analog-out.
4. **Validity Detection** is for data validity/correction check.
5. **Format** option is reserved for input digital data phase inverse since some source data may has reverse phase.
6. **Device** option is for choosing SPDIF input channel (8738 supports two SPDIF-In channels).
7. The **Copyright Protection** is to enable SPDIF Copyright bit. Then recording copyright- protected input data will be not available. For more information of SPDIF, please refer to the Appendixes C and D.

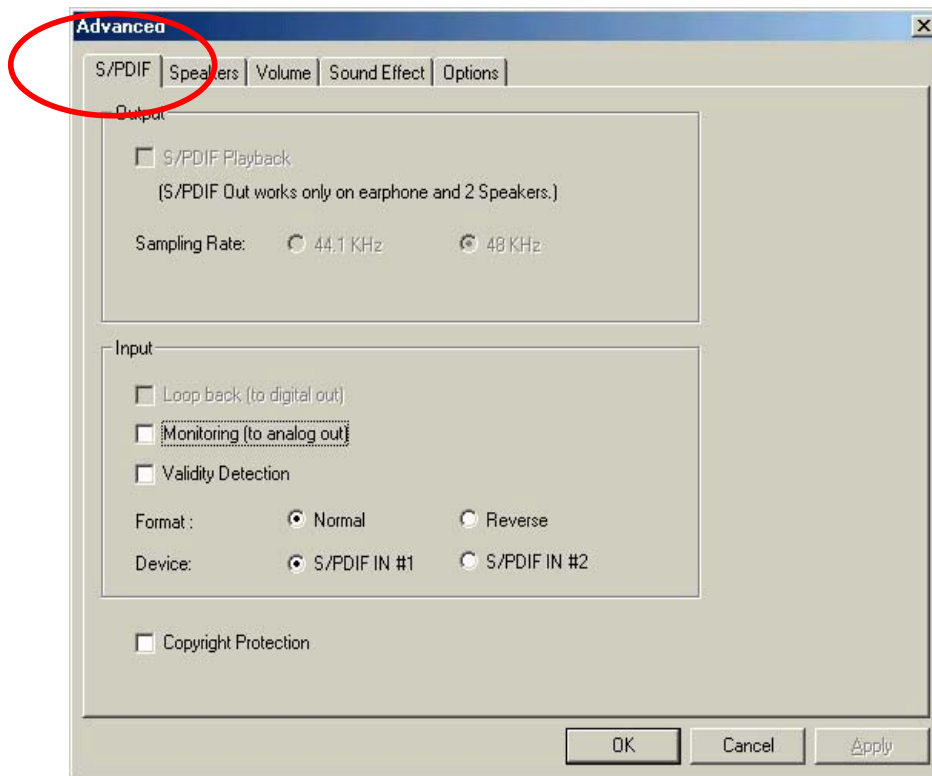

Advanced –Speakers (General Mode)

Speakers dialog box provides an interface allowing you to set your speaker mode. CMI8738-6ch supports earphone, 2ch, 4ch, and 5.1ch mode.

1. The “**Configuration**” tag shows the speakers figure corresponding to your setting.
2. The “**Phone Jacks**” tag shows the correct phone jack configuration for your Motherboard/sound card.

First, you should make sure what type your speakers are, and what the correct configurations are. You can always refer to this to make sure whether or not the connections of your speakers and plugs are correct.

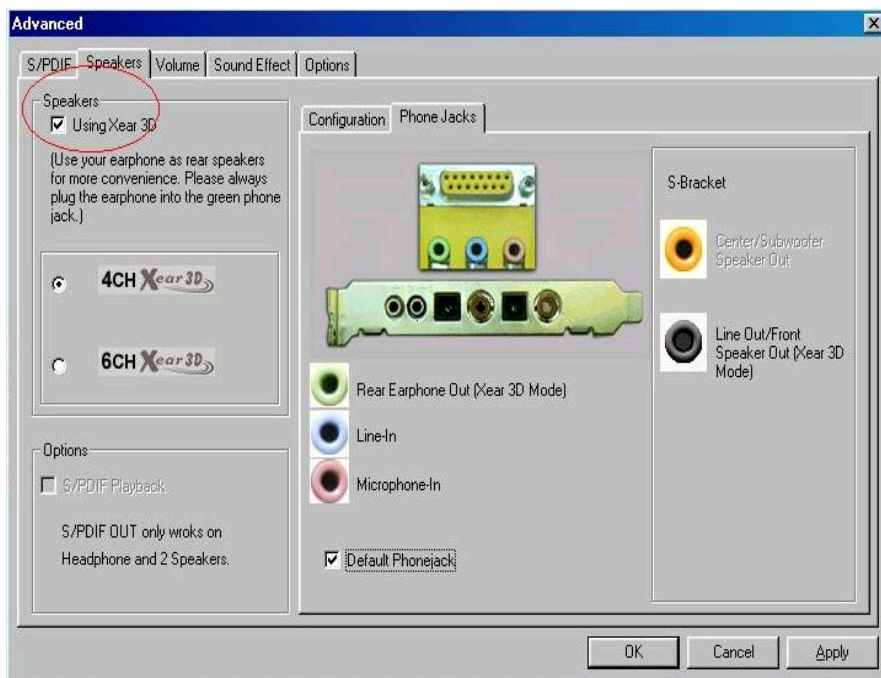
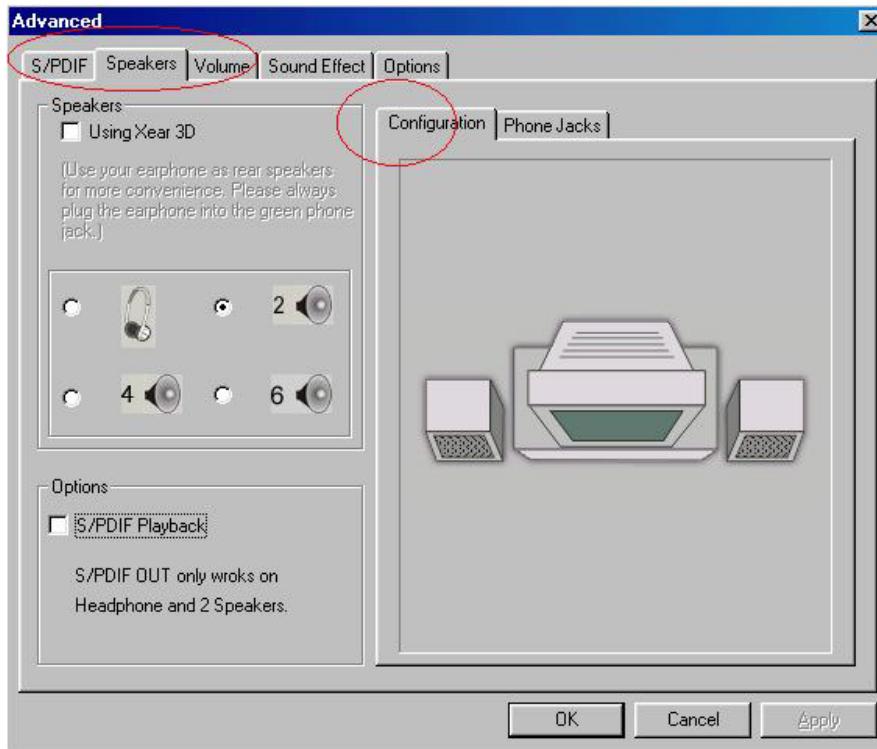

Advanced – Speakers (XeaR Mode)

XeaR technology provides a different multi-channel listening method and environment setting. Users can use general open-style earphones to replace rear speakers so that users will hear rear-out sounds from the earphone. Without rear speakers, users will need less setup-up effort, cost and space using XeaR technology. It will be also convenient for gamers to enjoy multi-channel 3D sound effect when playing games especially in Internet Cafés, which usually have less space.

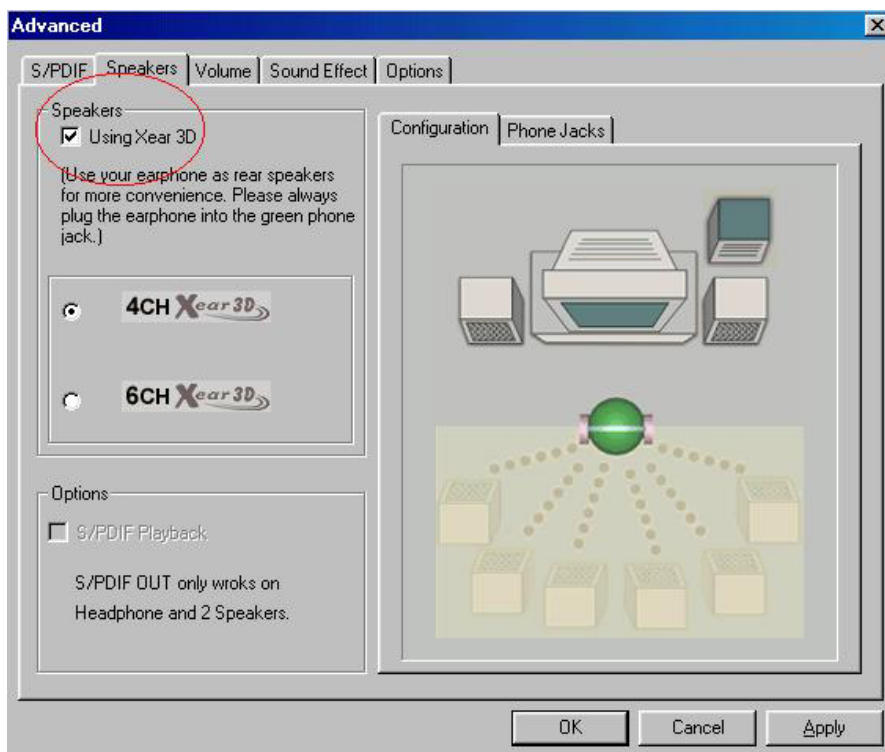

By clicking “Using XeaR” option, you can enter into XeaR Mode. **When choosing XeaR Mode, the driver will exchange the output channels of Front-Out and Rear-Out since the Rear-Out channels do not have earphone driving power. Therefore, users need to plug the front speakers into original Rear-Out phone jack and plug the XeaR earphone into Front-Out/Line-Out or Earphone jack as follows.**

XeaR Mode

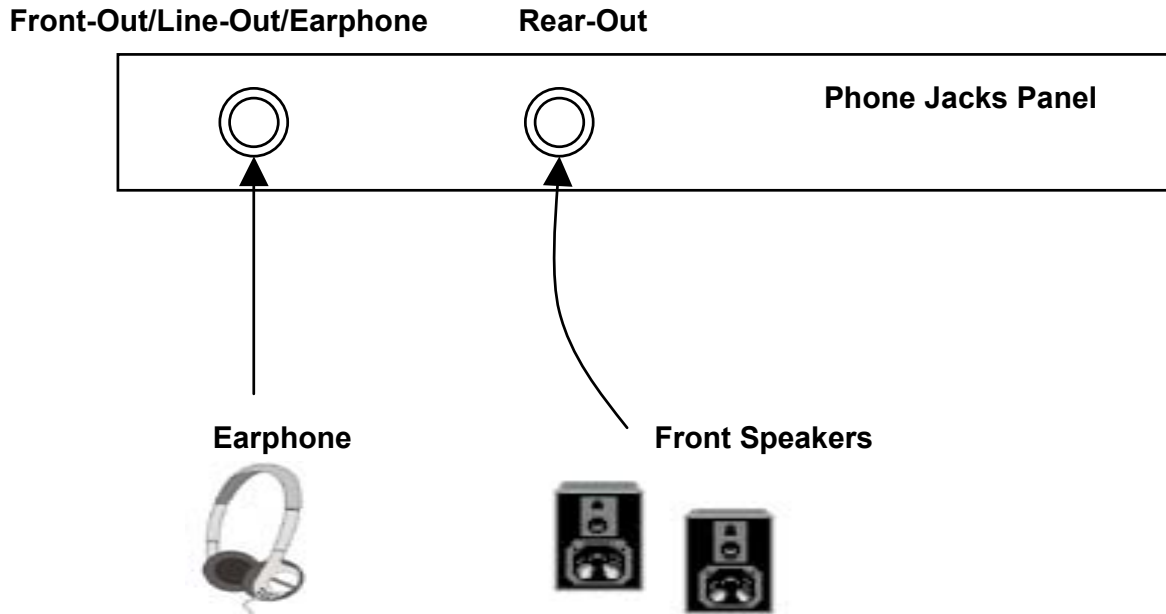

Please also refer to the phone jack tag in the mixer that will show you how to connect the speakers and your earphone in your machine and then enjoy your XeaR listening experience.

To reduce the inconvenience of manual changing plugs, it's recommended for users to always choose XeaR mode to enjoy personal listening environment and do not need to adjust plugging.

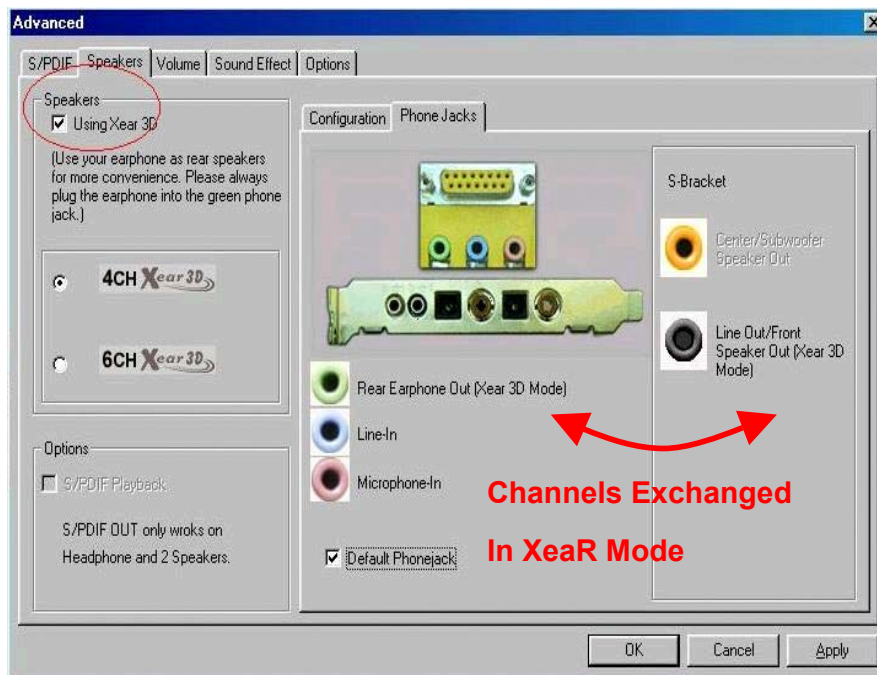

Advanced – Volume

Volume dialog provides a full control over the volume of the six channels digital output. You can adjust the volume of sounds from your respective speakers in this dialog. **It will be also useful in Xear mode to optimize the best 3D sound effects.** Please note that the volume of analog path is not controlled by this function.

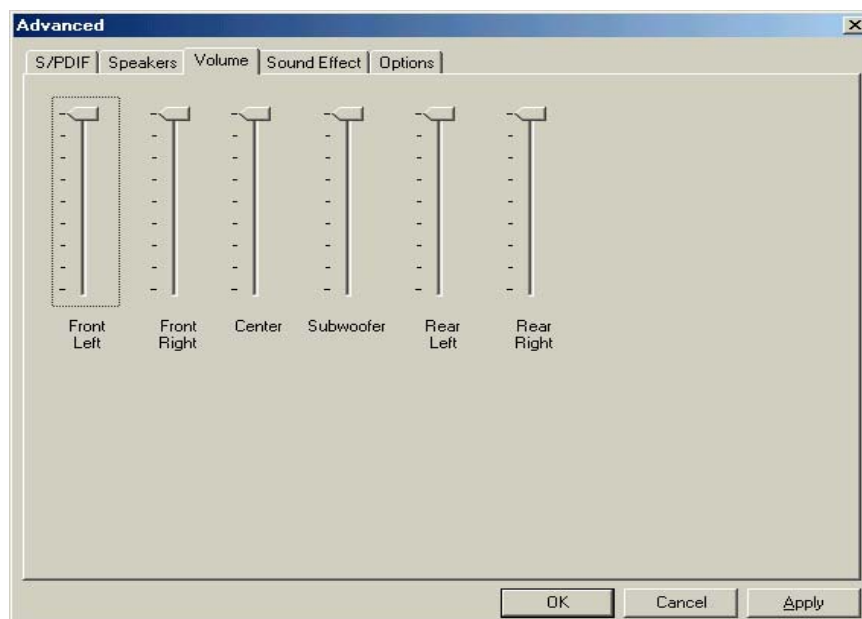

Advanced - Sound effects

Sound effects dialog allows you to modify the special environment sound effects of the song and game being played. Currently, these effectors can only be used for the player or the game which utilizes DirectSound 2D and 3D to playback their music. **Virtual 5.1** option will try to simulate surround sounds even your digital audio sources are only 2 channels.

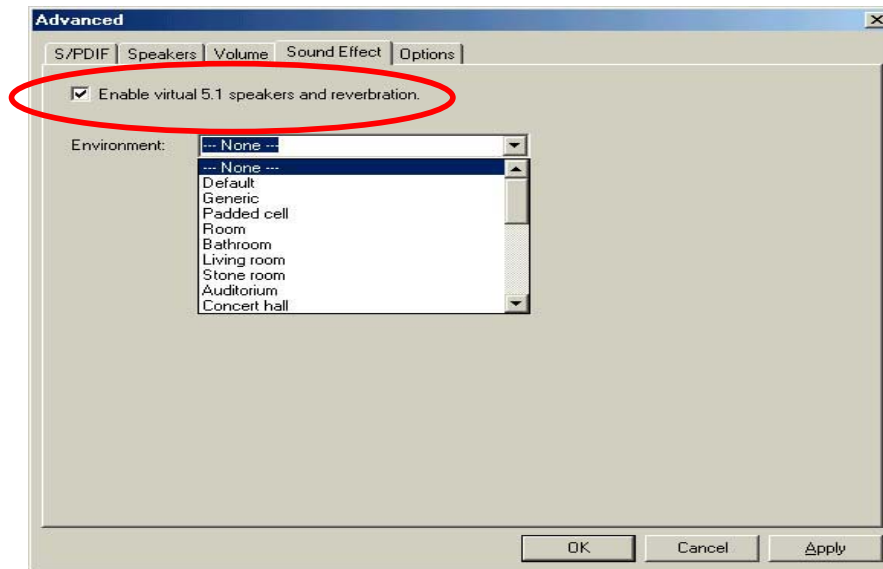

Advanced - Options

Options dialog provides a hot key setting to control the Mixer in an easy way. Please note that this might affect other applications if you use the same hot key setting. Please use '**Load Mixer Defaults**' to change all settings to default values. "**Enable Microphone Booster**" will enable +12dB microphone input signal gain.

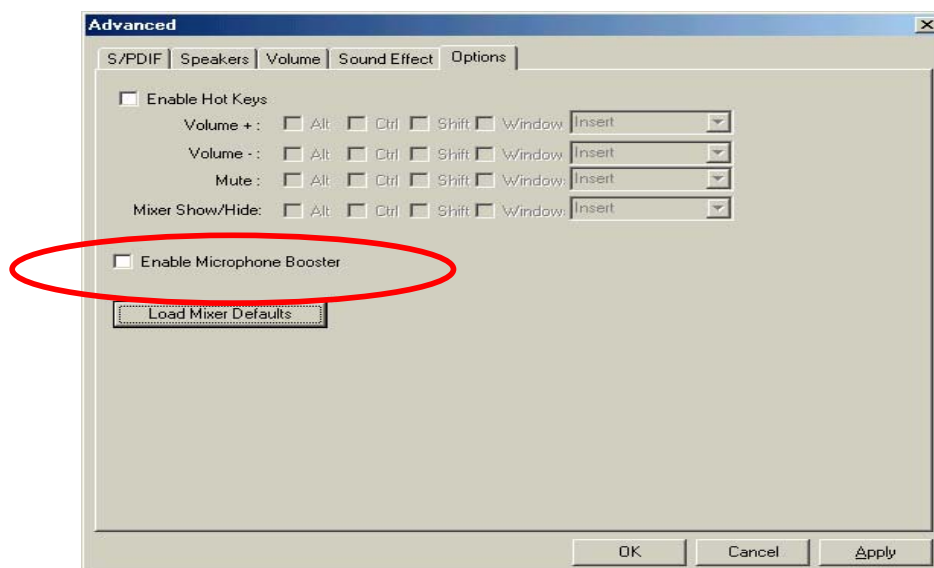

1. Windows Applications—Audio Rack

Audio Rack (for WDM driver)

By means of a user-friendly interface (as easy as operating your home stereo system), this PCI audio rack provides you with control over your PC's audio functions, including the advantage of 4/6 speakers mode enable/disable, and perfect digital sound (SPDIF) input /output control.



Control Center

Control Center: Controls the display of the PCI Audio Rack components.

This Audio Rack consists of several major components:



CD Player can play standard audio CDs, and allow you to create your own playlist.

MIDI Player can play MIDI files, *.mid/*.rmi, and allow you to create your own playlist.

MP3/Wave Player can play mp3, wave, and MPEG-1 files. It provides EAX and equalizer to improve the sound effects when you playback the audio files. If you want to sing a song, MP3/Wave Player also provides a Karaoke function. MP3/Wave Player can record input signals and save it in a wave file as well.

Mixer controls the volume level of your audio inputs and outputs.

Showing or Hiding Audio Rack Components

To show or hide a component from the display, click the component button(s) listed on the top.

❶ CD Player

CD Player: Plays standard audio CDs, and allows you to create your own playlist.











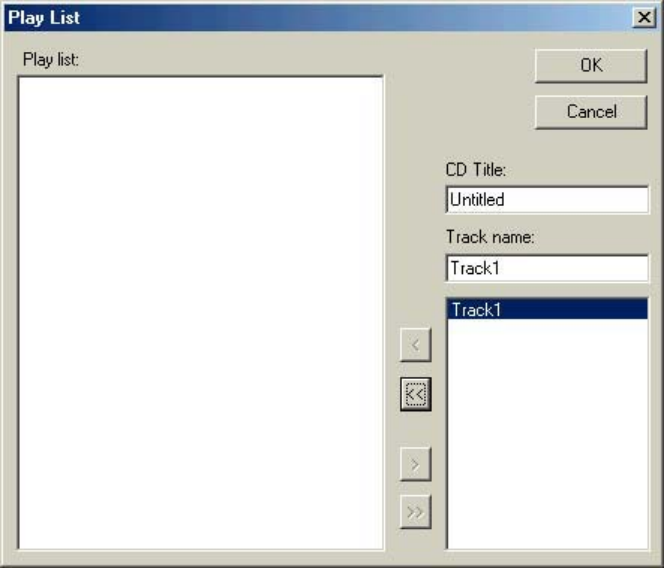

Current Track field shows the number of the currently selected CD track.





CD title and track name field shows CD title and track name. You can modify CD title and track name in [Playlist] function.

Total length field displays the total length of the selected track in minutes and seconds.

Playback time field displays the current playback time.

Button Function

	<p>Playlist: You can select or move tracks of audio CD from and into the playlist. The title of CD and the name of tracks can be modified as well. Playlist dialog will save and show them automatically when you want to play the same CD.</p> 
	<p>Previous song: Loads the previous track of playlist. If current track is the first track, the last track will become the current track.</p>
	<p>Next song: Loads the next track of playlist. If current track is the last track, the first track will become the current track.</p>
	<p>Playback: Starts to playback the current track.</p>
	<p>Pause/Restart: Pauses or restarts the current playback action.</p>
	<p>Stop: Stops playback.</p>
	<p>Playback backward for 10 seconds: Playback the current to 10 seconds before.</p>
	<p>Playback forward for 10 seconds: Playback the current to 10 seconds after.</p>
	<p>Loop: Playbacks the tracks over and over again.</p>
	<p>Eject: Opens the CD-ROM drive to change the audio CD.</p>

	<p>Setting: Selects the CD-ROM drive which analog output is connected to the Analog-CD in of your sound card. If your CD-ROM does not connect to the analog CD input wire, please use device manager to change the property of your CD-ROM.</p> 
	<p>Help: Shows the help screen for detailed button function descriptions.</p>
	<p>About: Shows software version and copyright information.</p>
	<p>Exit: Stops and leaves the CD player.</p>

② MIDI Player

MIDI Player can play MIDI files, *.mid/*.rmi, and allow you to create your own playlist.











Current file field shows the number of the currently selected MIDI files.

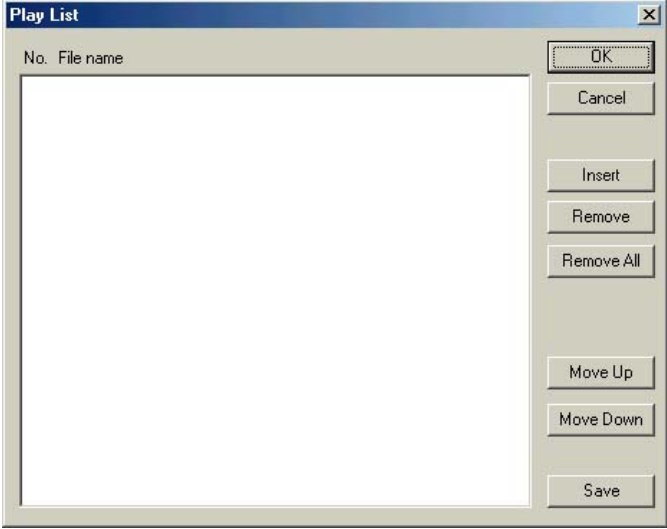



File name field shows the file name.

Total length field displays the total length of the selected file in minutes and seconds.

Playback time field displays the current playback time.

Button Function

	<p>Playlist: allows you to insert, remove, and record the MIDI files into and from the playlist. You can save the playlist into a file as well.</p> 
	<p>Previous song: Loads the previous MIDI file of playlist. If current file is the first MIDI file, the last one will become the current selection.</p>
	<p>Next song: Loads the next MIDI file of playlist. If current file is the last one, the first file will become the current selection.</p>
	<p>Playback: Starts to playback the current MIDI file.</p>
	<p>Pause/Restart: Pauses or restarts the current playback action.</p>
	<p>Stop: Stops playback.</p>
	<p>Playback Backward for 10 seconds: Playback the current to 10 seconds before.</p>
	<p>Playback Forward 10 seconds: Playback the current to 10 seconds after.</p>
	<p>Loop: Playbacks the MIDI files of the playlist over and over again.</p>

	<p>Setting: Selects the output device you want to use to playback the MIDI files.</p> 
	<p>Help: Shows the help screen for detailed button function descriptions.</p>
	<p>About: Shows software version and copyright information.</p>
	<p>Exit: Stops and leaves the MIDI Player.</p>

③ MP3/Wave Player

MP3/Wave Player can play mp3, wave, and MPEG-1 files. It provides EAX and equalizer to improve the sound effects when you playback the audio files. MP3/ Wave Player can record input signals and save it into a wave file as well.



Current file field shows the number of the currently selected audio files in the playlist.







Frequency display field shows the frequency distribution.

Total length field displays the total length of the currently selected file in minutes and seconds.

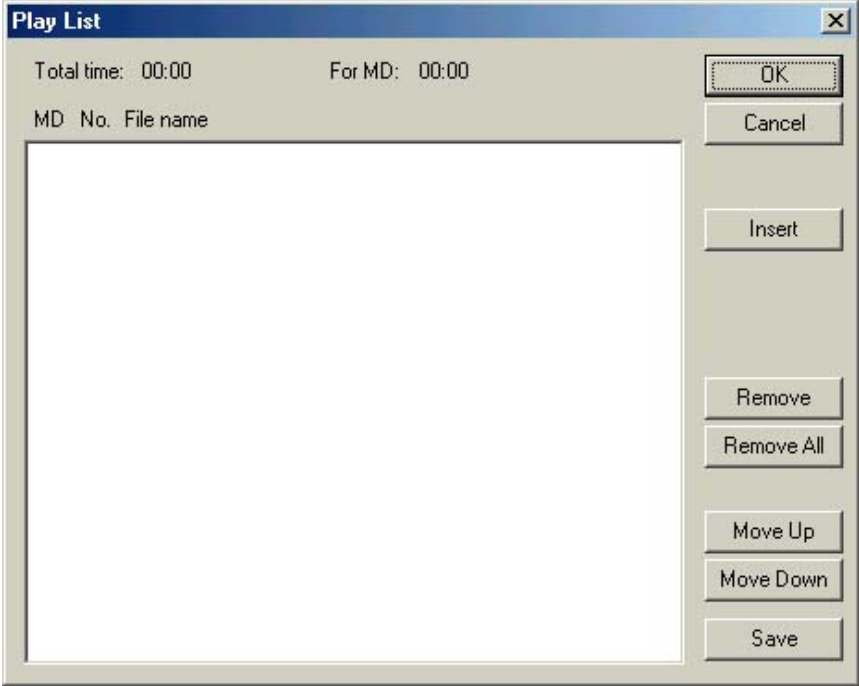
Playback time field displays the current playback time.

File name and status field displays the file name, audio format, sound effects selection, playback mode, Karaoke mode, and SPDIF status.

Button Function

	<p>Playlist: Playlist allows you to insert, remove, and record the audio files into and from the playlist. The audio files include wave, MP3, and MPEG-1 encoding files.</p> 
	<p>Previous song: Loads the previous audio file of playlist. If current file is the first file, the last one will become the current selection.</p>
	<p>Next song: Loads the next audio file of playlist. If current file is the last one, the first file will become the current selection.</p>
	<p>Playback: Starts to playback the current audio file.</p>
	<p>Pause/Restart: Pauses or restarts the current playback action.</p>
	<p>Stop: Stops playback.</p>
	<p>Playback backward for 10 seconds: Playback the current to 10 seconds before.</p>



Playback forward for 10 seconds: Playback the current to 10 seconds after.



Sound effector: You can use this function to modify the special effect of the song being played. Currently, these effectors can only be used for 44.1 KHz, 16-bit format.

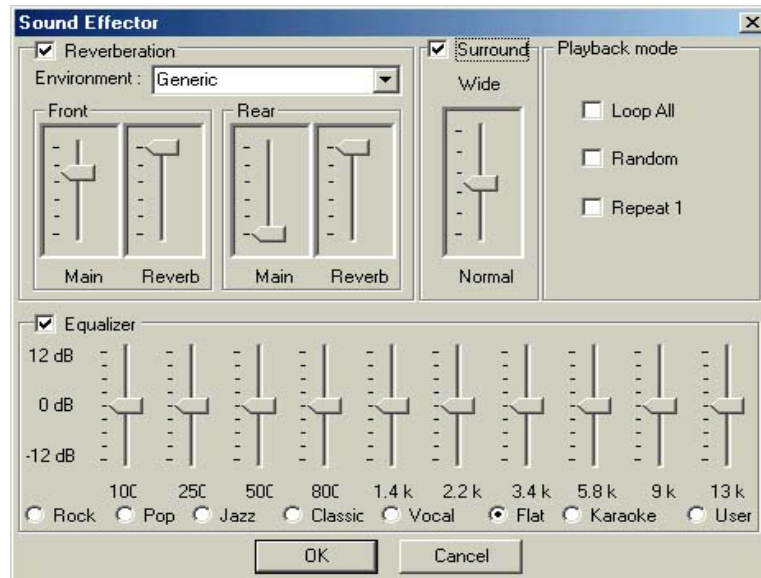

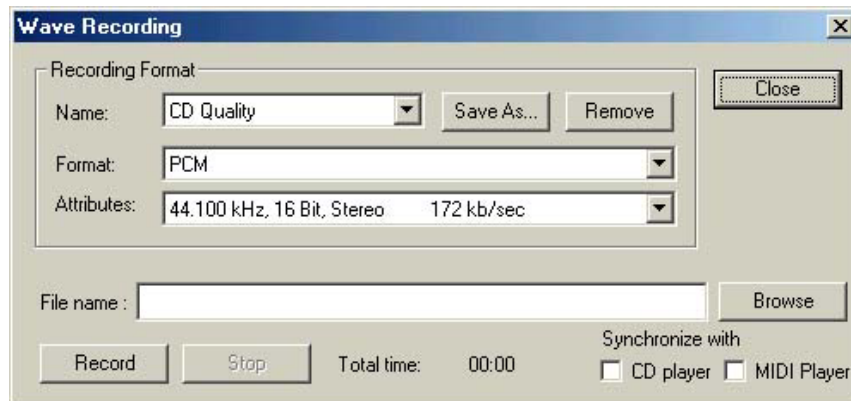

Recording: You can use this function to record a wave file from any recording channel.



Setting: You can use this dialog to set the playback parameters and the status of SPDIF IN/OUT. For more information of SPDIF, please refer to the Appendixes C and D.



	Help: Shows the help screen for detailed button function descriptions.
	About: Shows software version and copyright information.
	Exit: Stops and leaves the MP3 player.

Multi-Channel Audio Demo

CMI8738 PCI-Based C3DX Audio Chip provides many advanced functions, such as:

- HRTF-based CRL[®] 3D extensional/positional audio; API compatible with Microsoft[®] DirectSound[®] 3D and Aureal[®] A3D API.
- Supports rear side speakers;
- C3DX positional audio in 4/6CH speakers mode. (5.1 CH, DVD AC-3[®] home theater available).
- Compatible with EAX[™] (Environment Audio eXtention).
- KARAOKE ascending/descending keys, Echo.
- Supports Center/Subwoofer side speakers. (for chip model 039 and the following models).

To let everyone avail himself/herself of the above functions, a user-friendly interface (Multi-Channel Audio Demo) was designed with the following functions:

- ❶ 4 CH speakers mode, including Demo1 and Demo2.
- ❷ EAX[™] (Environment Audio eXtention) support.
- ❸ HRTF-based CRL[®] 3D extensional/positional audio.
- ❹ KARAOKE ascending/descending keys, Echo, and microphone ascending/descending keys.
- ❺ 6 CH speakers mode, including Demo1 and Demo2. (for chip models 039 and the following models).

Speakers and Microphone Connection

Before running this demo program to feeling the C-Media's Sound Banquet, you have to connect the speakers and the microphone to the correct phone jacks.

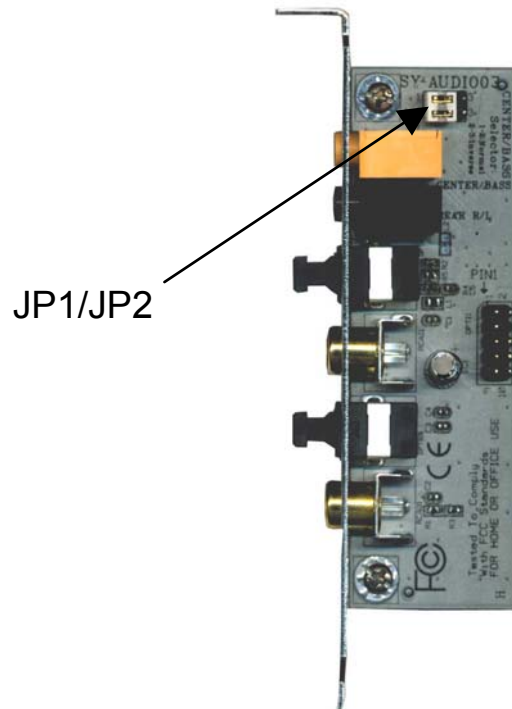

Note: Some 5.1 speaker have different center/base assignment. Please use the C-media Multi-Channel Audio demo software to check if sounds coming from the center/base speaker are correct. If not, short pin 2-3 of JP1 and JP2.

How to Enable 4/ 5/ 5.1 Speakers

You have to activate the "Mixer" program and click "Advanced" button. Then you can open speakers page and selected "4-Speaker", "5 Speakers", or "5.1 Speakers" mode to let the audio driver recognize your rear or center/subwoofer speakers, and have the front/rear/center/subwoofer speakers work. The audio driver will activate the audio chip to output different sounds from the front/rear/center/subwoofer speakers based on different playback formats. For more information, please refer to the "9 C-Media Power Mixer".

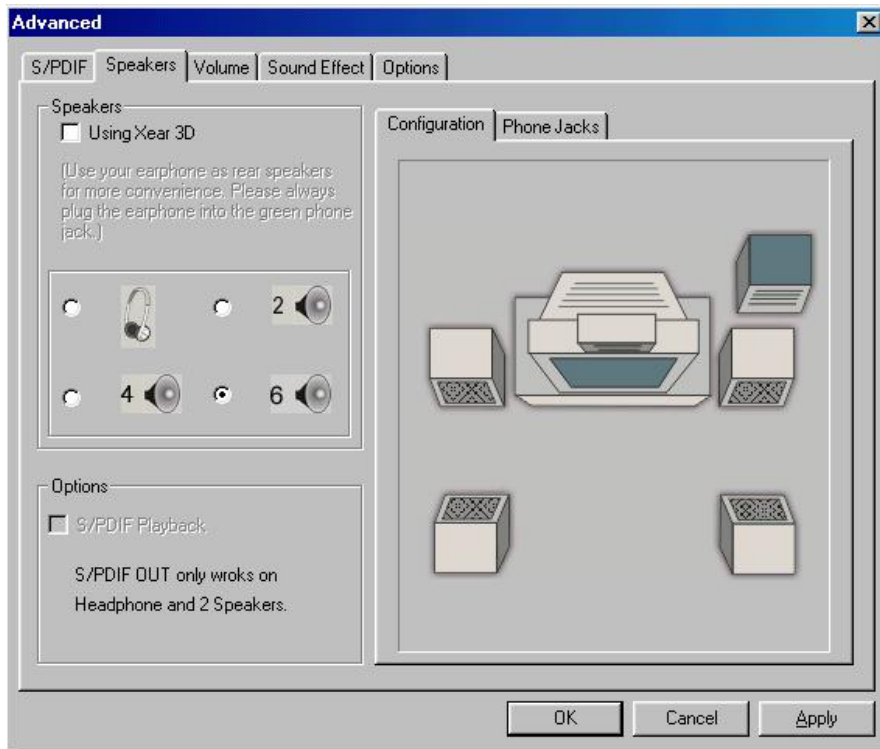
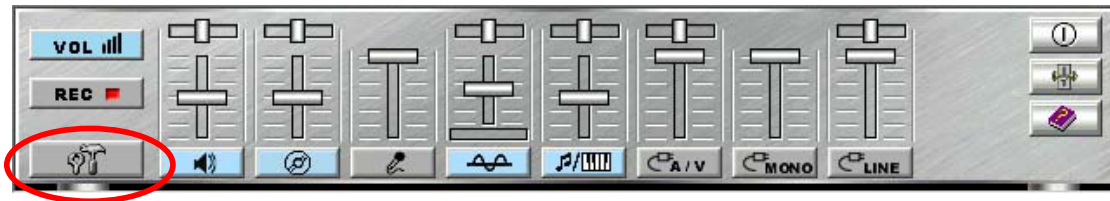

Beside this, you can open multi-channel audio program and click the “TV” on home theater graphic picture. The program will pop up a dialog box to set up advanced setting.



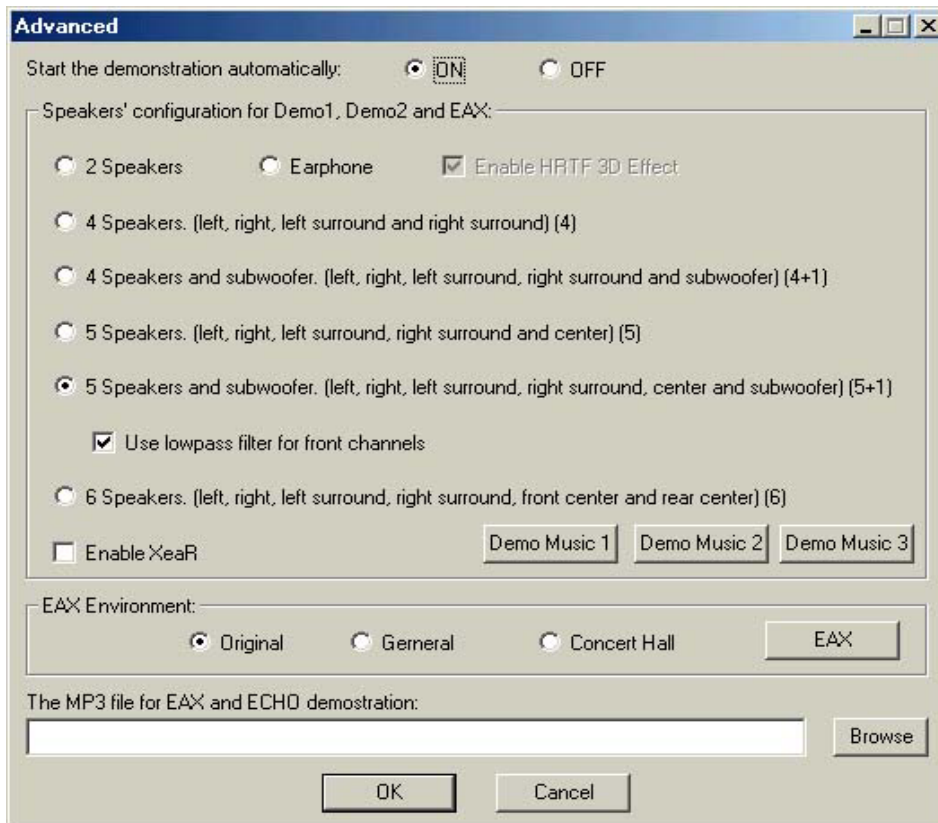

How to Adjust the Microphone Volume

You have to use the microphone when availing yourself of the "Echo" function. If the microphone is on and is very close to the speakers, it will cause feedback between the two. Also, unusual high frequencies or buzzing sounds might be heard from the speakers. To avoid this, you have to adjust the microphone volume in both recording and playback. Sometimes you might have to adjust the main and Wave volume as well. Please left-click the mouse to adjust the microphone (MIC) in both Volume and Recording Control.

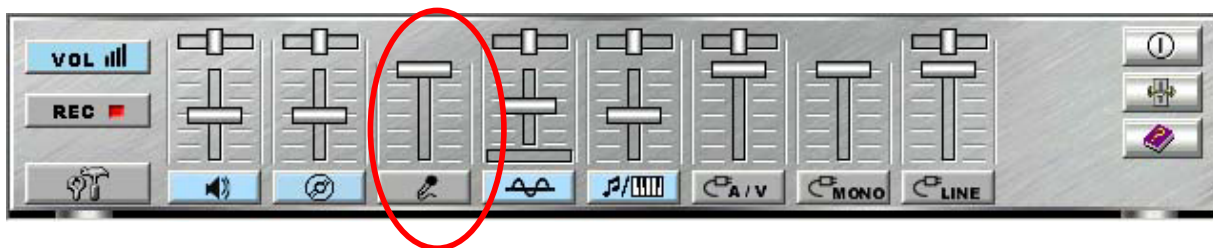

Test Your Speakers Connection

To make sure that the front and the rear speakers are correctly connected, you can use the following program to testify individual speaker output. Move cursor to whichever speaker you want to test and left-click the mouse. If the setup is correct, you can hear music coming from that speaker alone. Each music output is different for distinction.



You can move your mouse on any speaker, which at the graphic user interface. When you click speaker then its will sound from correct channel.

Demonstrations

C-Media provided three music melodies, which are specially designed for Multi-channel speakers system demonstration. Select Music by left-clicking the mouse. Sit back and relax, and let the music take control.

How was it like? Isn't it fantastic??? If you don't have multi-channel speaker system, hurry up and buy yourself one right away!



EAX

Monotonous footsteps generate distinctive sound effects in different environments. In this Demo, you can hear a lady wearing high heels walk in different surroundings: generic environment, bathroom, sewer pipe, and underwater. Left-click the mouse to activated this Demo and feel the differences.



HRTF

HRTF stands for Head Related Transfer Functions, and it is a set of audio filters varying locations of sound effects (spatial hearing cues) in three-dimension measured from the listener's eardrum.

This technology and special digital signal processing are used to recreate spatial hearing cues, making our ears hear realistic and three-dimensional sounds coming from a pairs of loud speakers or headphones.

When you activate this Demo, you can simply shooting, fire missile and fly helicopter.



Echo

Like to sing along with Karaoke? It might occur to you to use your PC for this. However, when you turn on the microphone, play the song, and ready to sing, you see that the effect is not as good as expected. Why? Echo is the answer. To help you solve this problem, this demo is designed to include the Echo function. Please left-click the upper right of the demo screen as shown below, and choose your own music file to play. Please note the file type has to be MP3 file.



Please left-click "Echo" to activate the function. For pitch adjustment, please use ↑ and ↓ keys on the keyboard. For microphone pitch adjustment, please use "+" and "-" keys on the numeric keyboard. To resume the original, please use ← and → keys.

Using MP3/Wave Player to Work With Mini Disc Recording

MP3/Wave Player is an easy and powerful tool for Mini Disc recording. Besides allowing you to create your own playlist, it also provides a control interface of SPDIF IN/OUT of C-Media's sound card. The following 4 steps can help you create your album into Mini Disc easily.

STEP 1. Using optical fiber to connect the sound card and the MD player. MD player will start to do the recording and turning on the SYNC mode. (See above 1. Output A. PC to MD player)

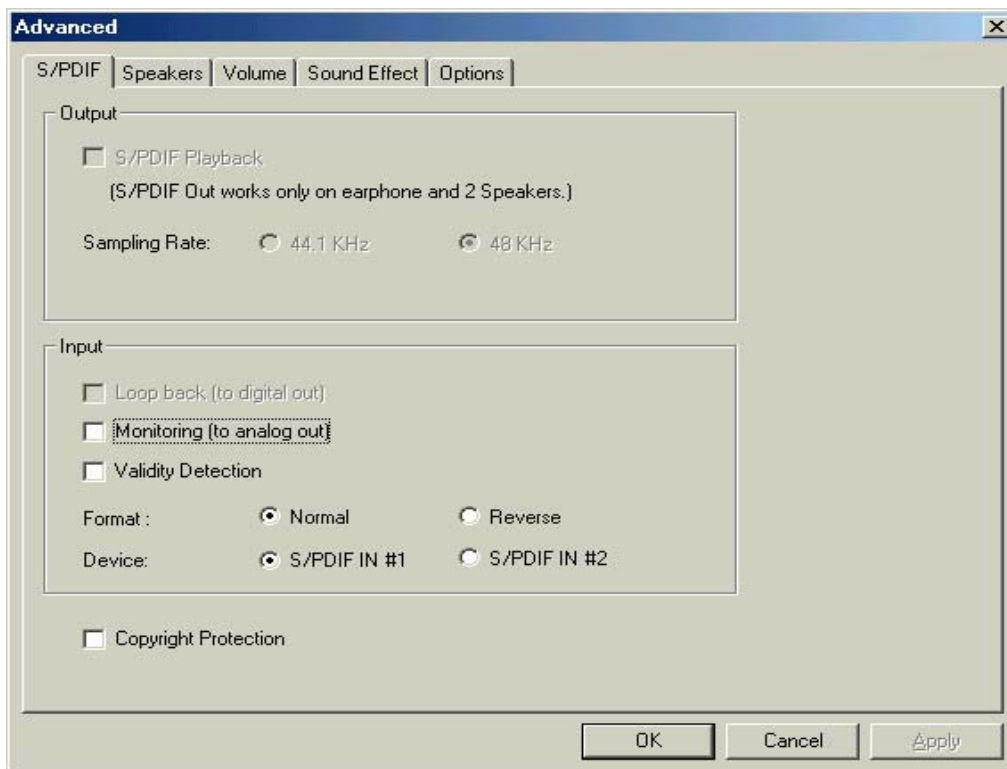

STEP 2. To execute MP3/Wave Player and modify the playlist. You should select those files whose format can be recognized by the MD Player. You can also change the sound effects if you like. (See also 5.1.4.)

STEP 3.In 'Setting' dialog, check 'Enable SPDIF-OUT', input the playback delay time, and select 5 Vp-p (Optical). Please note that in playback, if there is no lapse longer than three seconds between each track, the MD player cannot recognize the tracks and will record all of them into one. It is recommended that you set the lapse time to 3~5 seconds to meet all type of MD player requirements.

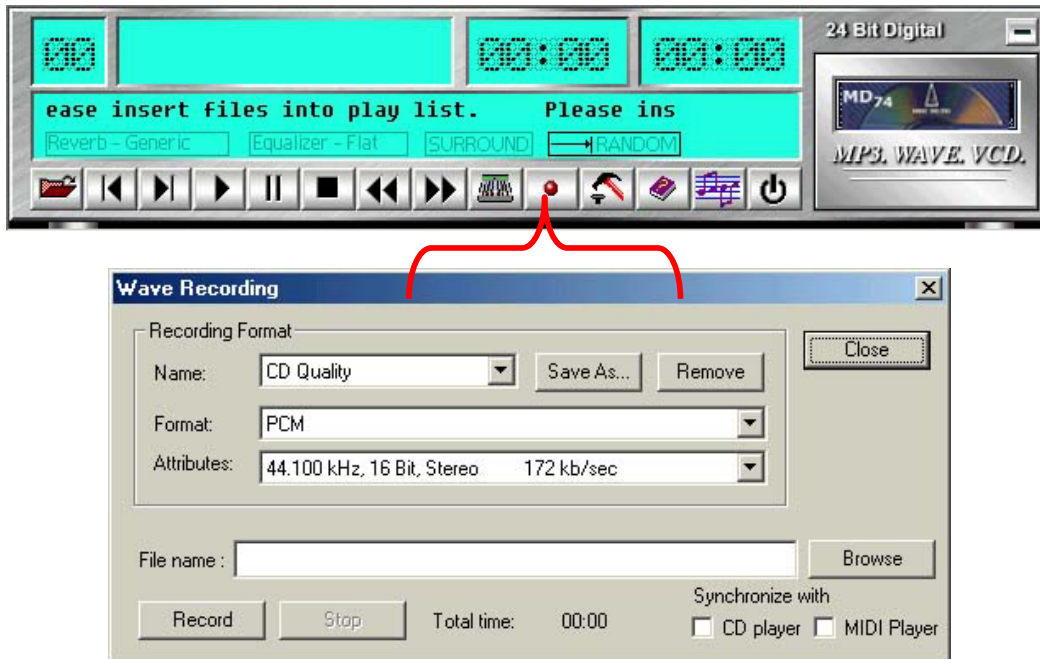

STEP 4.Start to play the songs. You will see that the MD player starts to do the recording as well.

Recording From SPDIF-In

The optical module can be connected to SPDIF-IN device, such as the portable CD-ROM player, the CD-ROM drive, the MD Player, to name a few. The Windows application and the MP3/Wave player can be used to do the recording of the signal from SPDIF-IN. The recording steps are as follows:

STEP 1.Use optical fiber or coaxial to connect the sound card and SPDIF-IN device. (See also Appendix C 2. Input)

STEP 2.Execute MP3/Wave Player. In 'Setting' dialog, select 5 Vp-p (Optical) or 0.5 Vp-p (Coaxial).

STEP 3.In 'Wave Recording' dialog, you should select the recording format and SPDIF-IN recording channel. Then input the file name. Before recording, please turn on your SPDIF-IN device and start to playback. Finally, press 'Record' to start the recording process.

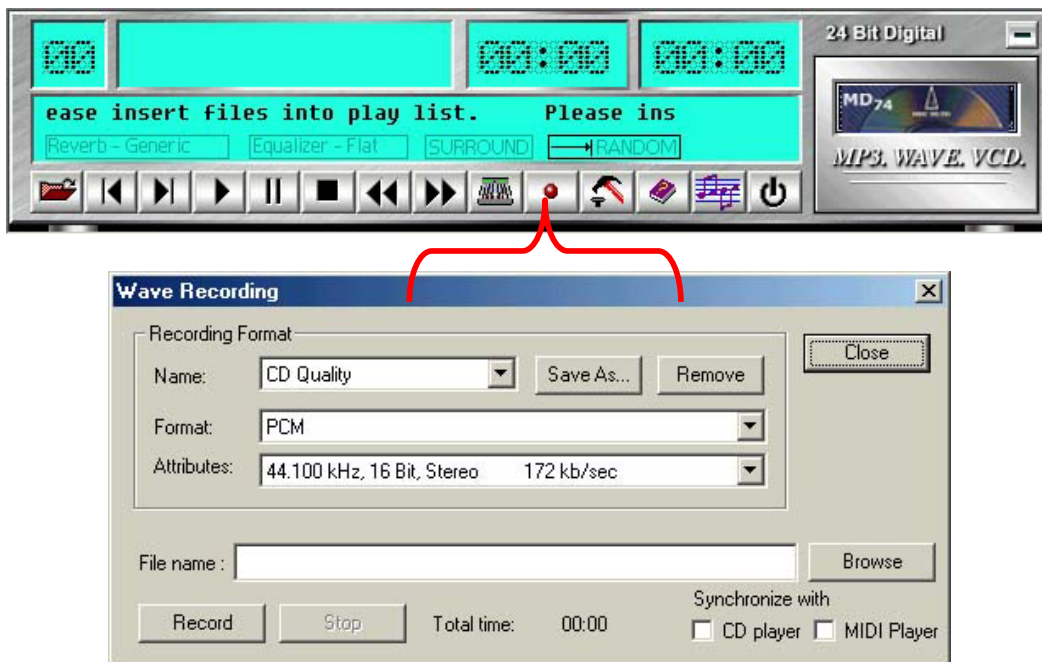

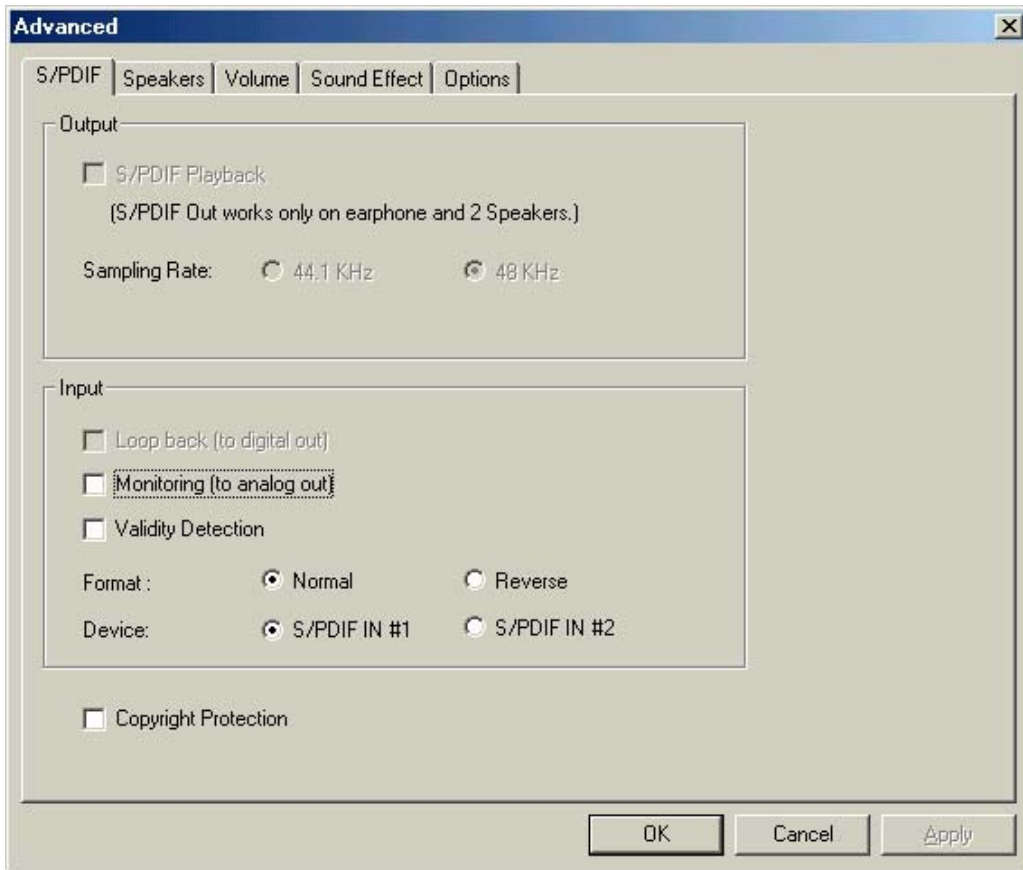

APPENDIX C

Troubleshooting at First Start

Boot-up Issues

The system do not power-up, no beeping sound heard and the CPU fan does not turn on.

1. Check if the power cord is plug to the power source.
2. Check if the power is connected to the M/B.
3. Check if the cable of the case power button is connected to the M/B power button connector (see connectors and plug-ins in the manual for more info).
4. Make sure the power supply is not defective. Change the power supply. The minimum should be 250 watts.
5. Remove the M/B from the case and test the system. The M/B might be shorted to the case.

The system power-up, no video, no beeping sound heard, but the CPU fan is turning.

1. Clear CMOS battery. (JP5 connector, see Quick start guide for more info on how to clear the CMOS).
2. Check all the jumper settings on the M/B. (if the M/B have any).
3. Check if the CPU is ok by using another CPU (check the Quick start guide for CPU supported on this M/B).
4. Check if the power supply is ok. The minimum should be 250 watts.
5. Make sure the CPU fan is connected to CPUFAN1 connector.
6. Remove the M/B from the case and test the system. The M/B might be shorted to the case.
7. Change the VGA card. If you have used a 3.3V AGP card, the M/B might be damage.

The system power-up, no video, beeping heard.

1. Clear CMOS battery. (JP5 connector, see Quick start guide for

more info on how to clear the CMOS).

2. Check all the jumper settings on the M/B. (if the M/B have any).
3. Check the memory module and the VGA card if inserted properly on the M/B.
4. If yes, change the memory module, it might be defective. Make sure the memory specification is supported by the M/B. (for more info on this, check our FAQ website).
5. Change the VGA card. Make sure the AGP card is 1.5v

The system turns on for some seconds then shutdown by itself.

1. Check if the CPU fan is connected to the CPUFAN1 connector.
2. The CPU might be overheating. Check the CPU FAN if it is defective or see if the CPU fan is in contact with the CPU.
3. Clear CMOS battery. (JP5 connector, see Quick start guide for more info on how to clear the CMOS).
4. Make sure the power supply you have on your system support the M/B specification. Example. If you have a P4 M/B, you need to use a P4 power supply.
5. If you already checked the power supply specification, change the power supply it might be defective. The minimum is 250 watts.

When I boot up my system, everything works fine, it sees my CPU and memory, detects my hard drive, floppy drive and CD-ROM but locks up at "Verify DMI pool data... ". Don't go any further. What should I do?

1. Clear CMOS battery. (JP5 connector, see Quick start guide for more info on how to clear the CMOS).
2. If still has the problem, remove all other add-on cards except video card see if it move further. Then put peripherals in one by one to identify which one cause the lockup.
3. Change the CPU.

During Boot-up, my computer says CMOS memory Checksum error. What is the problem?

1. Clear CMOS memory.

2. Re-flash BIOS. Check on how to flash BIOS on the later part of this book.
3. Change the CMOS battery, the battery might be drained.
4. The BIOS chip might be failing.

Stability Issue

My system intermittently locks up, very unstable

1. Check the CPU Temp, it might be overheating. Change the CPU FAN.
2. Do not over clock your CPU
3. Check the specification of the memory module, maybe the M/B do not support it.
4. Go to BIOS setup and load fail safe settings. Please check if the system performance in the BIOS setup is set to Turbo/Maximum.
5. Check website for latest BIOS update.
6. Check website for FAQ's regarding instability issue.
7. Change the memory module or CPU.
8. The power supply might not have enough wattage to support all the peripherals. If your system has other peripherals connected, like CD-RW, extra HDD, etc. disconnect them.
9. Install VIA 4 in 1 driver.

My system intermittently locks up, during Windows installation.

1. Go to BIOS and load "load optimized default".
2. Check website for any BIOS update.
3. If still has the problem, remove all other add-on cards except CPU/ Memory/ Video card/Hard disk. See if you can finish Windows installation. Then put peripherals in one by one to identify which one cause the lockup.

My system will not boot-up when I set my CPU to 133MHz FSB, works with 100MHz FSB

1. Make sure to put some thermal paste above the CPU.

2. CPU might be defective.

BIOS Issue

Where can I find the BIOS revision of my mainboard?

It will be displayed on the up-left corner on the screen during boot-up. It will show as your board type followed by the revision number, such as kvxa_2BA1 (meaning BIOS revision 2BA1 for the SY-K7V Dragon plus! board) or 6BA+ IV_2AA2 which means SY-6BA+ IV motherboard with 2AA2 BIOS.

Where can I find the latest BIOS of my motherboard?

Please go to the technical support page of one of the SOYO websites (Taiwan: www.soyo.com.tw), and look up your motherboard to find the latest BIOS revision.

How can I flash the BIOS?

1. Download the BIOS on our support website.
2. Make a bootable floppy disk with out any memory manager loaded (i.e. himem, emm386, etc...).
3. Copy the BIOS file and awdf flash utility to the diskette.
4. Type "awdf flash biosname.bin /sn /py".
5. Then reboot.

After flashing the BIOS, my system will not boot-up.

1. Try clearing the CMOS.
2. The BIOS chip is defected due to unsuccessful flash, contact your nearest SOYO branch for re-flashing.

Is there a way to reprogram my BIOS after an unsuccessful flash?

No other way, you need to send back the BIOS ROM to your nearest SOYO branch for re-flashing.

I'm using a 133MHz FSB CPU, I cannot find the DDR 100MHz option in the BIOS, why?

The DDR speed should not be lower than the CPU FSB speed.

VGA Issue

I cannot set my VGA to go higher than 16 color (640x 480).

1. Make sure that you have installed the VIA 4 in 1 driver.
2. Install/ re-install the VGA driver.

After wake-up from Suspend to RAM or Standby mode, the screen has no display but I can hear the hard disk operating

1. Install VIA 4 in 1 driver.
2. Check the VGA card manufacturer for driver update, or make sure the VGA card support Suspend to Ram function.

Audio Issue

How can I disable the on-board Audio?

Go to the SOYO Combo Feature in the BIOS setup, then set the “onboard 6CH H/W audio” to disable.

I cannot get the sound working on my system.

1. Check if the speaker wire is connected to the line out connector in the M/B.
2. Check if the speaker power is powered on.
3. Install the audio driver supplied on our driver disc.
4. Check BIOS setup if “onboard 6CH H/W audio” is enabled.
5. If sound already installed, check our website for audio driver update.

I cannot get the sound working on the 5.1 channel speaker.

1. Install the audio driver and application. Check driver installation for more info.
2. Check if the settings in the 5.1 speaker control box are correct, like if you have a SPDIF connector but the setup in the speaker box is set to analog.
3. Check if the speaker connection to the M/B is correct.
4. Make sure the software setup is correct. Check manual for more info.

The sound is working in my system, but when I play CD music from the CD-ROM, I do not get any sound. What is wrong?

This is because the 3-wire audio cable from the CD-ROM to the on-board CDIN1 connector in the M/B is not connected. See manual for location of CDIN1.

The sound from my sound card is distorted when Windows start. What is wrong?

If you are using an ISA sound card, please make sure the IRQ needed for the sound card is set to 'Legacy ISA' in the BIOS. In other word, if your ISA sound card takes IRQ5, then set IRQ5 to 'Legacy ISA'.

The sound and everything else works fine except that the recorder and microphone do not work. What is wrong?

1. Please go to sound properties and check if the recorder and microphone in the are enabled.
2. Check if Microphone is ok.

The sound coming from my Center and Base speaker is interchange, what should I do?

Set the JP1 and JP2 of the small audio card to pin2-3.

Hard disk/FDD/ CD-ROM issue

My Western digital HDD is not detected during boot-up

Change the jumper settings to cable select or single.

Sometimes the system finds my CD-ROM, sometimes not

1. Check CD-ROM if it is working properly.
2. The power supply might not have enough wattage to support all the peripherals. If your system has other peripherals connected, like CD-RW, extra HDD, etc. disconnect them.

When I boot up my new computer I got "floppy boot failure" and the LED on the floppy stays on

Make sure the red wire of floppy ribbon cable goes to Pin1 on the floppy drive side (don't trust the "key lock" or "notch") and use the end-connector of the cable (don't use middle one).

RAID issue

Windows do not detect the on-board RAID.

1. Enable the on-board RAID function in the BIOS.
2. install the RAID driver, see chapter 6 for more info

Can I use my CD-ROM or other IDE device (except HDD) on IDE 3 & 4?

No, HPT 372 only support Hard disk.

Can I use IDE 3 & 4 as a normal IDE channel?

Yes, no need to change any settings in the BIOS. Just make sure to install the driver, check Chapter 6 for more info.

I cannot get the HDD to boot from IDE 3 or IDE 4, why?

Make sure that the 1st boot device in the BIOS is set to SCSI.

Boot-up from my IDE3/4, I get blue screen upon entering Windows system

Make sure the raid option in the BIOS is enabled.

LAN Issues

During LAN driver installation, the system hangs on 75%, why?

Enable the onboard LAN in the BIOS setup.

I have problem installing Novell NetWare v.50

Disable the APIC option in the BIOS.

For updated FAQs, please check <http://www.soyo.com.tw/faq.htm> or <http://www.soyousa.com/faqs.html>

APPENDIX D

How to contact us:

- If you are interested in our products, please contact the SOYO sales department in the region you live.
- If you require Technical Assistance, please contact our Technical Support in the region you live.

SOYO prefers Email as communication medium, remember to *always add to the email the country that you live in.*

TAIWAN

SOYO COMPUTER INC.

No. 21 Wu-Kung 5 Rd., Hsing
Chuang City, Taipei Hsien,
Taiwan, R.O.C.

TEL: 886-2-22903300

FAX: 886-2-22983322

<http://www.soyo.com/>

Email: info@mail.soyo.com.tw

USA

SOYO INC.

41484 Christy Street, Fremont,
CA 94538, USA

TEL: 1-510-226-7696

FAX: 1-510-226-9218

<http://www.soyousa.com/>

<http://www.soyousa.com/kb>

Email : support@soyousa.com

GM

SOYO Deutschland GmbH

Gewerbepark 8a, 26209 Hatten,
Germany

TEL: 49-441-209100

FAX: 49-441-203442

<http://www.soyo.de/>

Email: sales@soyo.de