

**P4VMD+**  
**(VIA P4M266 VGA-ON-CHIP Chipset)**  
**With DDR-200/266 & PC-100/133 Memory**  
**For Pentium<sup>®</sup> 4 400MHz FSB PC System**  
**Main Board**

使用者手冊

(Ver.:1.0)

## 版權所有

親愛的使用者，謝謝您使用本公司出品之主機板。首先聲明本手冊擁有著作權，請勿盜印或非法使用。此使用者手冊版權屬於本公司所有，未經本公司許可不得任意複製拷貝或翻譯成其他型式或語言 or translated into any natural or computer language, in any form or by any means without prior written permission. This manual and the information contained here are protected by copyright. All rights reserved.

**Copyright 2002. All Rights Reserved.**

### Revision History

Revision	Date	Release Notes
1.0	Feb.-2002	First Official Release

### **Warning and disclaimer**

This manual is designed to provide information about the Pentium®4 main-board. Effort have been made to make this manual as accurate as possible, but no warranty or fitness is implied. All the information is provided on an 'as is' basis. The author and his corresponding publishing company shall have neither liability nor responsibility to any person or entity with respect to any loss or damages arising from the information contained in this manual or from the use of the system board that accompanies it.

Information contained in this manual is subject to change without notice. The manufacturer of the system board will not be held responsible for technical or editorial omissions made herein, nor for the incidental or consequential damages resulting from its furnishing, performance, functionality or use. Subsequent changes to this manual will be incorporated into the next edition. We welcome any suggestion regarding this manual or our computer products.

### **Trademarks**

- Intel® and Pentium® are registered trademarks of Intel® Corporation.
- IBM® is a registered trademark of International Business Machines Corporation.
- Microsoft® is a registered trademark of Microsoft® Corporation.
- PCI® is a registered trademark of PCI® Special Interest Groups.
- AWARD® is a registered trademark of Award Software Inc.

All other trademarks are the property of their respective owners.

---

## Table of Contents

<b>Chapter 1</b>	<b>Introduction.....</b>	<b>1</b>
1-1	Main Specifications.....	2
1-2	System Configuration.....	5
1-3	Notice of Hardware Installation.....	6
<b>Chapter 2</b>	<b>Installation.....</b>	<b>7</b>
2-1	Component Locations .....	7
2-2	Layout Reference.....	8
2-3	Jump Setting.....	9
2-3-1	Memory Selector .....	9
2-4	CPU Installation .....	10
2-4-1	CPU and System Cooling.....	13
2-5	Connectors.....	14
2-5-1	Front Panel.....	14
2-4-1	Back Panel Connectors.....	16
2-4-2	Power Supply Connector.....	18
2-4-3	Floppy Disk Connector.....	19
2-4-4	IDE1 and IDE2.....	20
2-4-5	Internal Audio Connecotrs.....	21
2-4-6	IR1: IrDA Connector.....	22
2-5	Memory.....	23
2-5-1	Memory Installation.....	24
<b>Chapter 3</b>	<b>Software Installation.....</b>	<b>25</b>
3-1	Notice of Driver Installation.....	25
3-2	How to Install Software Drivers.....	26

---

<b>Chapter 4</b>	<b>The BIOS.....</b>	<b>28</b>
4-1	Updating the BIOS.....	29
4-2	The CMOS Memory.....	30
4-3	The BIOS Setup Pages.....	32
4-3-1	Standard CMOS Setup.....	35
4-3-2	BIOS Features Setup.....	39
4-3-3	Chipset Features Setup.....	43
4-3-4	Integrated Peripherals.....	49
4-3-5	Power Management Setup.....	55
4-3-6	PNP/PCI Configuration Setup.....	60
4-3-7	PC Health Status.....	62
4-3-8	Frequency/Voltage Control.....	63
4-3-9	Passwords Setting.....	65
<b>Chapter 5</b>	<b>Appendix.....</b>	<b>67</b>
5-1	Memory Map.....	67
5-2	I/O Map.....	68
5-3	Time & DMA Channels Map.....	69
5-4	Interrupt Map.....	70
5-5	RTC & CMOS RAM Map.....	71
5-6	ISA I/O Address Map.....	72
<b>Chapter 6</b>	<b>Q &amp; A.....</b>	<b>74</b>

**Important Warnings:**



**WARNING:** NEVER run the processor without the heatsink properly and firmly attached. This will damage the processor within SECONDS. Also do NOT try to use Pentium Heatsinks, these will NOT fit and do NOT provide adequate cooling.



**WARNING:** Make sure your power supply can deliver the power your system needs. We recommend AT LEAST a 250W power supply. Even better, get a 300W power supply, especially when using many peripherals.

---

# Chapter 1 Introduction

Thank you for purchasing this high quality motherboard, we are confident that you will be able to use this motherboard to your full satisfaction. This manual is divided into 6 main sections, as described below:

## **Introduction**

The introduction contains information on the main specifications for this motherboard, the package contents and cautionary notes.

## **Hardware Installation**

The Hardware Installation section is the most important in the manual. It describes in detail how to set the motherboard up for operation. Read all information and follow all steps, especially if you are a new user.

## **Software Installation**

The software section describes the drivers that need be installed to make your OS operates properly. The drivers are provided on the driver CD.

## **BIOS Setup**

Information on how to enter the BIOS setup and change settings is given here. In addition all individual BIOS items are described. Although some BIOS setting information is given in the hardware installation section where appropriate, refer to the BIOS Setup Section for details.

## **Appendix**

Provides useful information

## **Q & A**

---

## 1-1 Main Specifications

- **PCB board size and form factor: 24cm x 24.5cm, M-ATX type.**

- **PCB layer: 4 layers**

- **Supported CPUs**

Can support the latest 400MHz system bus Socket-478 Intel P4 CPUs up to 2.2GHz or higher speed. Supports both 0.13μwillamette & 0.18μ morthwood process CPUs.

- **Chipset Northbridge (P4M266)**

The VIA™ VT8751 (VIA P4M266) system controller is a 400MHz System Bus. The DRAM controller supports DDR200/ DDR266 Double Data Rated (DDR) SDRAM and PC100/ PC133 Dual Inline Memory Module (DIMM) SDRAM; it complies with AGP 2.0 specifications for 4X, 2X AGP modes and PCI 2.2 bus interface with support for 2 PCI masters. It was designed especially to deliver enhance Intel® P4 processor system performance. Meanwhile it is integrated with S3 Savage-8 VGA core Logic on chip.

- **Chipset Southbridge (VT8233)**

The VT8233 PCI Super-I/O Integrated Peripheral Controller (PSIPC) support Ultra/DMA/100, which allows burst mode data transfer rates of up to 100MB/ sec; AC97 audio (using the on-board VIA VT1611A Audio Cadec); USB controller with root hub and four function ports.

- **Memory**

This motherboard comes equipped with two Double Data Rate (DDR) Memory Module sockets to support DDR 200/ 266MHz-compliant (128, 256MB, or 512MB) DDR Modules up to 2GB or with two Dual Inline Memory Module (DIMM) sockets to support PC-100/ PC-133MHz-compliant (64, 128, 256, or 512MB) DIMM Modules up to 1GB.



***You can use either SDRAM memory or DDR memory. Can't be installed two kinds of memory module at the same time.***

- **AGP (Accelerated Graphics Port)**

This motherboard comes with an AGP slot with support for AGP cards for high performance. The AGP 66MHz 4X mode is supported as well, further increasing system performance.



This mainboard provides AGP slot, meanwhile user can use on-chip VGA function without setting any jumper.

■ **PCI Expansion Slots**

With two 32-bit PCI (Rev. 2.2) expansion slots, which can support Bus Master PCI cards, such as LAN or Video-grabber cards (PCI supports up to 133MB/s maximum throughput), this motherboard is ready for the most demanding applications.

■ **AMR Slot (Optional)**

An Audio Modem Riser (AMR) slot also is supported, a very affordable audio and / or modem riser card can be used in combination with this slot.

■ **USB interface**

With support for up to 4 USB ver 1.1 ports, two on-board, this motherboard provides ample USB expansion room.

■ **IDE interface**

This motherboard comes with an onboard PCI Bus Master IDE controller with two connectors that support four ATA66/ 33 devices on two channels. Supports UDMA/100, UDMA/66, UDMA/33, PIO Modes 3 & 4 and Bus Master IDE DMA Mode 2, and Enhanced IDE devices, such as CD-R/ RW, DVD-ROM, CD-ROM, Tape Backup and LS-120 drives. An IDE-3/4 RAID function is optional.

■ **Super Multi-I/O**

This functionality is integrated into the southbridge of the chipset. It provides two high-speed UART compatible serial ports and one parallel port with EPP and ECP capabilities.

■ **Infrared (IrDA) Connector**

This functionality is also integrated into the southbridge of the chipset. The IrDA connector supports an optional IR remote control device for wireless interfacing with external peripherals, personal gadgets, or an optional remote controller.

■ **System BIOS**

This motherboard comes with a 2MB BIOS that provides CPU/ SDRAM frequency, boot block write protection, and HD/ SCSI/ CD/ Floppy boot selection. DMI is also supported through BIOS, which allows hardware to communicate within a standard protocol creating a higher level of compatibility.



---

- **LAN function**

This mainboard has optional 10/100M LAN function provided by southbridge VIA 8233 chipset & VIA VT6103 PHY chipset.

- **Special Function**

- A. **Over 300W P4 type power supply is needed, meanwhile over 250W PIII type power supply is acceptable but not guaranteed for proper function.**
- B. **AC-97 Sound Codec chip provides “ amplifier“ function.**

---

## 1-2 System Configurations

Below is the VIA P4M266 chipset based system configuration:

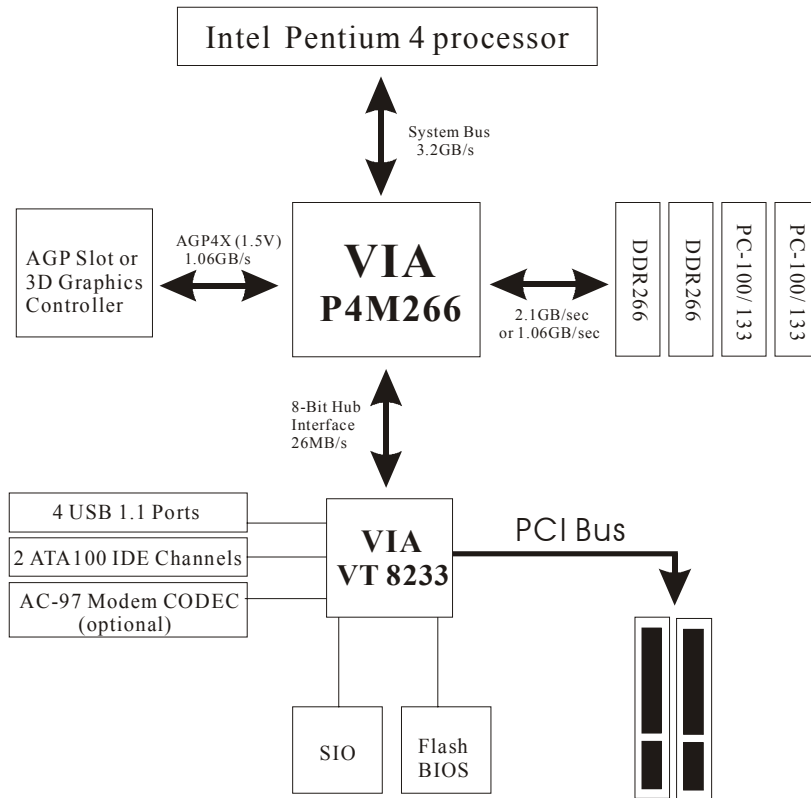

---

## 1-3 Notice of Hardware Installation

Before hardware installation, make sure you have checked the following things.

### A. Check the package

If any of these items is missing or damaged, contact the dealer from whom you purchase. Leave this main board in its original package until you are ready to install it. In the package, there are:

- This motherboard
- 1 Manual
- 1 Driver Installation CD-ROM
- 1 IDE ATA 66/100 Flat-Cable
- 1 Floppy Disk Drive Flat-Cable



### B. Make sure power is off.

During hardware installation, be sure that there is no power connected during this period.

### C. Avoid ESD (Electrical Static Discharge.)

While installing the main board, wear a grounded wristband or ankle strap to avoid ESD (Electrical Static Discharge).

---

## Chapter 2 Installation

### 2-1 Component Locations

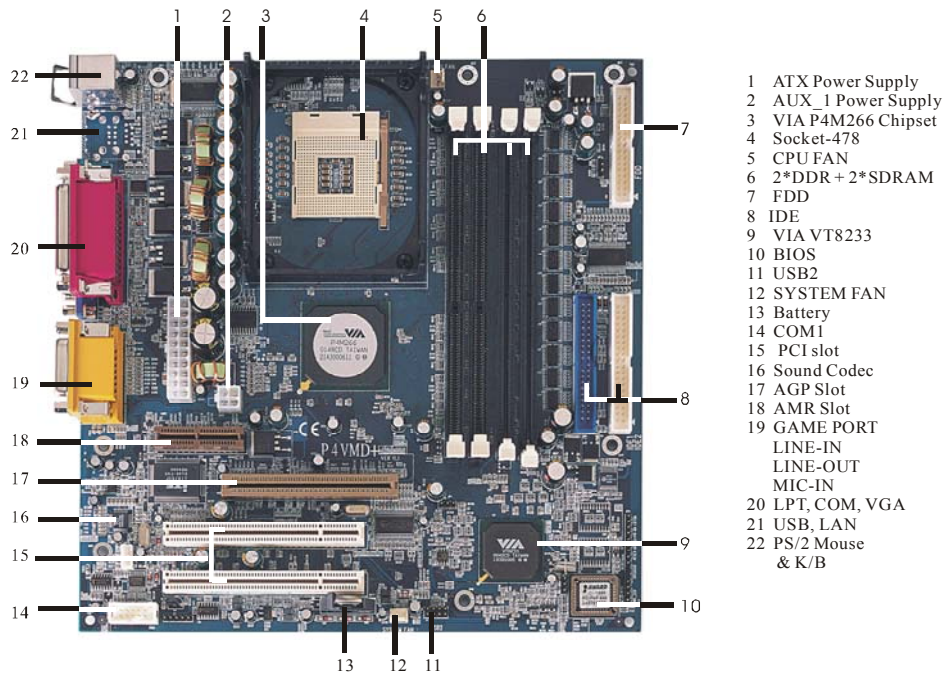

**There is no jumper setting for CPU or add-on cards installation, user is required to set JP2 & JP3 for memory type selection only.**

## 2-2 Layout Reference

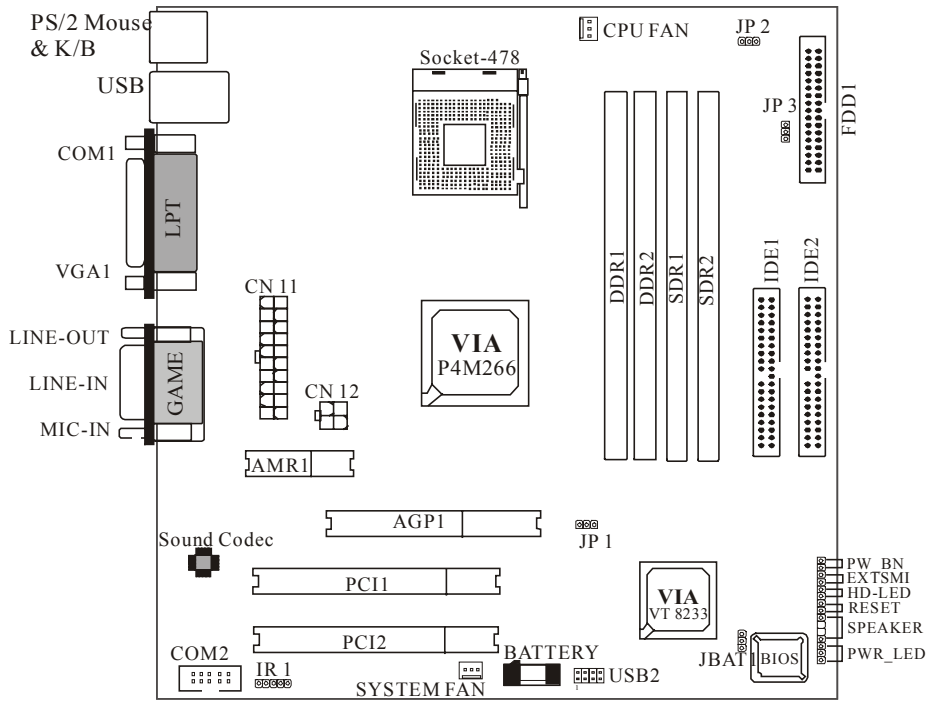

## 2-3 Jumper Setting

### 2-3-1 Memory Selector

JP2 and JP3 are 3-pin selector which provides user to select DDR memory or SDRAM memory. Please refer to the following picture:

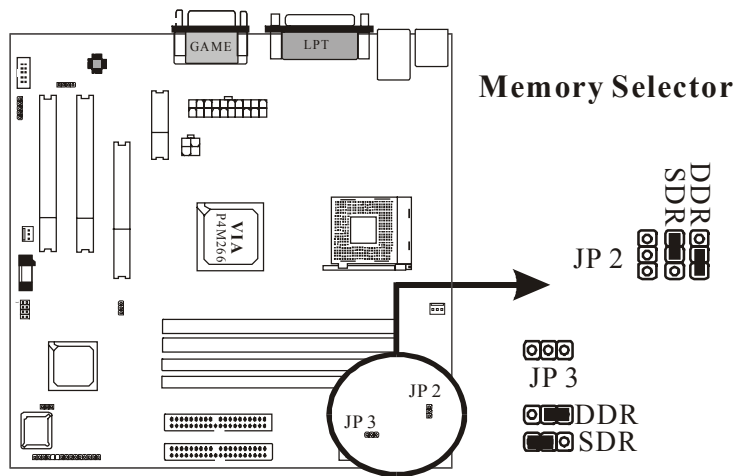

	JP2	JP3
SDRAM		
DDR		



*You can use either SDRAM memory or DDR memory. Can't be installed two kinds of memory module at the same ti*

---

## 2-4 CPU Installation

### Avoid Static Electricity

The Intel P4 processors and your motherboard contain sensitive electronic components that can be easily damaged by static electricity. We recommend that you leave the processor in its original packaging until you are ready to install it. You should only touch the edges of the processor, NEVER touch the processor pins to avoid static discharge.

First take a moment to inspect your CPU for obvious damage due to shipping or handling. Be sure that no noticeable damage exists before proceeding. You should have the following items:

- 1 Intel P4 processor.
- 1 good heatsink and fan assembly.

### Step 1

The following figure shows the processor socket. Note that the release lever on the right side of the socket is down and latched. This position is used to lock the processor in place. The lever must be raised to install the processor. To do this, first push the lever sideways to unlatch it, then raise it all the way up (approximately 90 degrees).



### Step 2

The processor pin array at the top two corners is angled and has no pins in the corners. Notice that at the top of the socket on the motherboard (near where it says "Socket 478") the corners also do not have positions for pins. The processor must be positioned so the pins match up properly. When you do that, the corner of processor that is cut off will be positioned next to the release pivot.

It should take no force to install the processor, this is a zero insertion force (ZIF) socket. If it takes any force you are doing something wrong. Check the pin alignment and also make sure the release lever is raised up completely.

---

After placing the CPU lower the release lever to lock the processor in place.



Now with the processor properly installed, you can proceed to install the heatsink. It is important to note that If you have never installed a heatsink on an Intel P4 processor before it may be difficult. We recommend you do a dry run a few times before doing the final installation. To allow you to do this read the following instructions. Do not remove the film on the thermally conductive compound until you are ready to do the final installation.



**WARNING:** *Never run the processor without the heatsink properly and firmly attached.*

### Step3

The picture below shows the bottom of the heatsink. Notice the step in the heatsink surface, this portion fits over the top of the socket, where the legend "Socket 478" is molded into the plastic. The heatsink must be mounted with this step above the top of the socket or the heatsink will not be touching the processor properly.



The next picture shows the removal of the plastic film from the thermally conductive compound. The thermal compound is a thin layer of material that increases the efficiency of the heatsink by filling microscopic surface voids in the processor or heatsink surface with a thermally conductive material. Please do not remove the plastic film until you have practiced installing the heatsink and mounting the clips on the socket. It can take a few tries to get used to doing this.





The following picture shows a side view of the heatsink with the retaining clip at the bottom of the heatsink. Make sure this retaining clip is at the bottom of the heatsink before trying to install it.



The non-moveable end of the heatsink retaining clip installed on the lug at the bottom of the processor socket. This end of the clip simply slides over the lug when you tilt the heatsink / fan assembly towards the lug.

Now lock the locking clip for the retaining strap over the lug at the other (pivot end) of the processor socket. This is an easy procedure after you do it a few times, but initially it will require you to use a finger on one hand to push the latch down and use your other hand to push the latch in. This is the part you need to practice to install the clip properly. When you are holding the heatsink, make sure you do apply pressure to the fan. You could damage it and cause thermal failure of the processor.



**WARNING:** Be careful not to scrape the motherboard during the mounting of the fan or else damage may occur to the motherboard.

Now connect the wire from the heatsink fan to the CPU FAN connector on the motherboard. This connector is keyed and can only be installed one way. If you use a heatsink assembly that has three cooling fans, connect one to CPU FAN and the other SYSTEM FAN. For more information on the FAN connectors, refer to the FAN connector section later in this section.

---

## 2-4-1 CPU and System Cooling

Any attempt to operate the Intel P4 Processor without a suitable cooling solution will result in permanent damage to the processor and potentially other components within the system.

### FAN Headers

Your motherboard allows the use of in all 2 FANs. Of these 2 FANs, 1 can be used by the CPU Heatsink assembly. The other FAN Headers allow connection of a Chassis Fan and a Power Supply FAN respectively. For a the location of the FAN connectors, refer to the following picture:

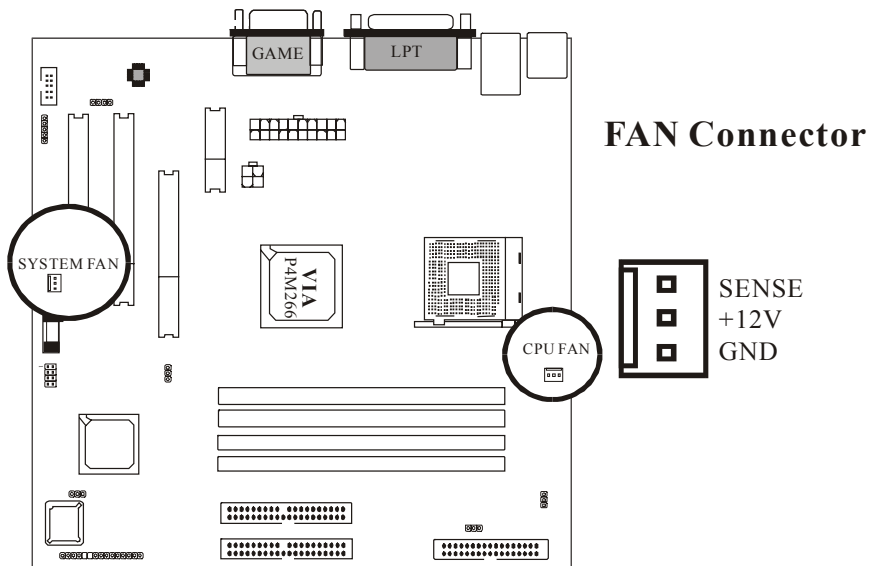

---

## 2-5 Connectors

There are many connectors on this main board. Refer to the following pages for details.

### 2-5-1 Front Panel

*Front panel* has connectors as “PWR\_LED,” “SPEAKER,” “RESET,” “HD\_LED,” “EXTSMI,” “PW-BN.” Please refer the details as below.

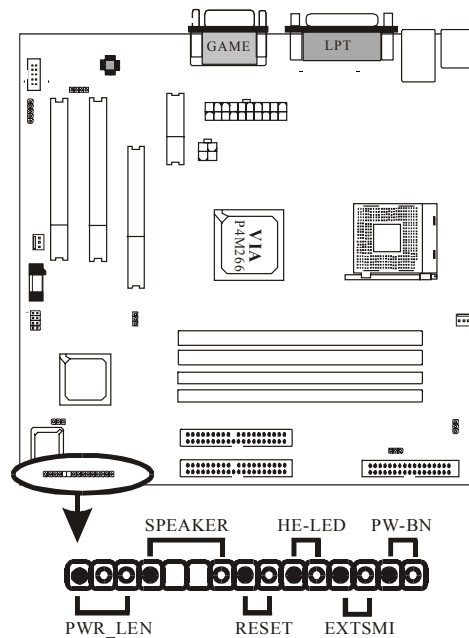

---

**PWR-LED** is a 3-pin connector. It is used to connect to the LED on the case front panel. The LED shows the status of the power.

**SPEAKER** is a 4-pin keyed Berg strip. This speaker connector is for the internal case speaker. This speaker will enable the BIOS to give spoken messages in case of boot up trouble. The BIOS beep codes also use this speaker. For Games and Music this speaker will not be used, but rather the back panel line-out connector.

**RESET connector** is a 2-pin keyed Berg strip, connected to the push button reset switch on the case front panel. Shorting both pin 1 & pin 2 can reset the system, which is similar to the power off and then on again.

**HD-LED** (Hard Disk activity LED connector) is a 2-pin keyed Berg strip. It is used to connect to front panel Hard Disk LED. This LED will light up whenever one of your IDE devices is being accessed.

#### **EXTSMI**

**PE-BN** with a 2-pin Berg strip on case front panel indicates the current power status of system. It is used to connect to the Power Button on the front panel of the case (if there is).

---

## 2-5-2 Back Panel Connectors

There are PS/2 keyboard/ mouse, USB, COM1, VGA1, LPT1, MIC, LINE-IN, LINE-OUT and GAME Ports on case back panel. Please refer to more details as below.

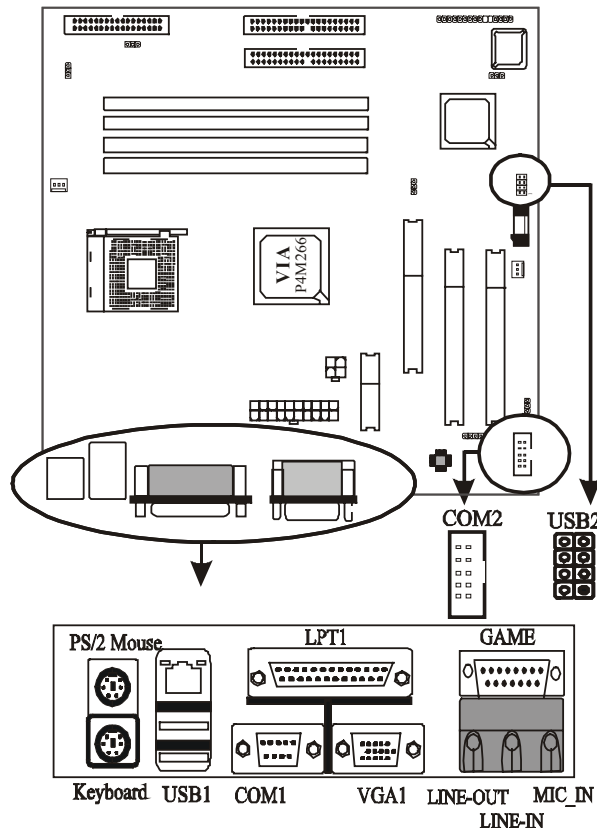

---

## **COM1/COM2**

*The onboard serial port 1 and port 2* are the 9-pin D-subminiature male connector **COM1 and COM2**. COM1 and COM2 can be disabled in BIOS setup. Please refer to Chapter 3 “Integrated Peripherals” for more information.

## **PS2 Keyboard/ Mouse**

*The Keyboard* can be plugged in in only one way. Please do not force the connector in, it may get damaged by use of excessive force. It is easy to make the mistake of reversing the PS/2 keyboard and mouse connectors. If your keyboard does not work, check this first. The keyboard must be inserted into the lower connector.

*The Mouse* can be plugged in in only one way, too. Please do not force the connector in, it may get damaged by use of excessive force.

## **LPT**

*The onboard parallel port* is a 25-pin female connector. It supports standard printer port, Enhanced Parallel Port (EPP), Extended Capabilities Port (ECP), Standard Parallel Port (SPP).

## **USB:USB (Universal Serial Bus) Connector**

*Universal Serial Bus connector*, marked as “USB,” is used to connect USB devices. There are 2 USB connectors on this main board.

## **Midi/Game Port & External Audio Connectors**

*Midi/Game port* has 15 pins connecting to the game joystick. External Audio connectors are “LINE-OUT, LINE-IN, MIC-IN ” for audio functions.

## **VGA Connectro**

**VGA connector** has 15 pins connecting to the monitor cable.

---

### 2-5-3 Power Supply Connector

This main board needs P4 power supply which contains ATX, AUX\_1 power connectors, **ATX power supply connector** has 20 pins, which is especially designed for ATX case. **AUX\_1 power supply connector** has 4 pins. The ATX power supply supports the function of the “**Soft Power On Momentary switch**” which connects the front panel switch to the 2-pin **SOFT-PWR** on the system board. While the power switch on the back of ATX power is turned on, the full power will not go into the system board until the front panel switch is momentarily pressed. Push the switch again to turn off the power to the system board.

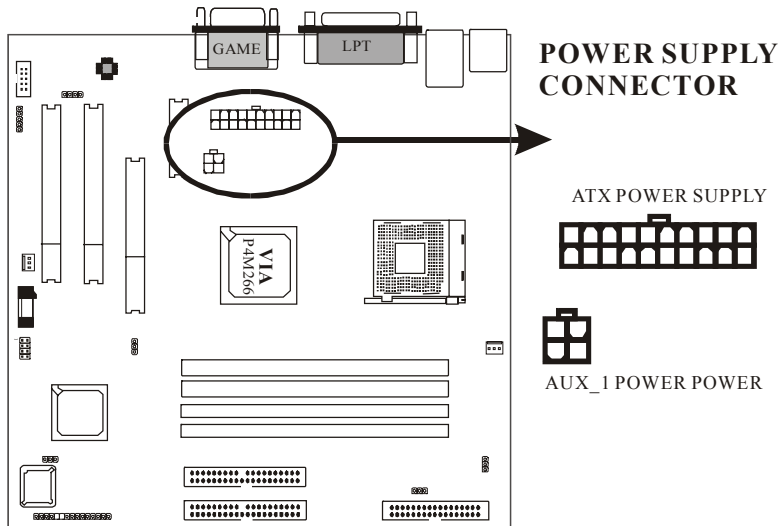

---

## 2-5-4 Floppy Disk Connector

**Floppy Disk Connector** has 34 pins and allows connection of a floppy drive. In all two floppy drives can be connected to the mother board, known as floppy A and B. The BIOS allows you to disable the floppy controller if you do not use any floppy driver, that will free an Interrupt. The BIOS also allows swapping of floppy A and B although this will not be useful to most users.

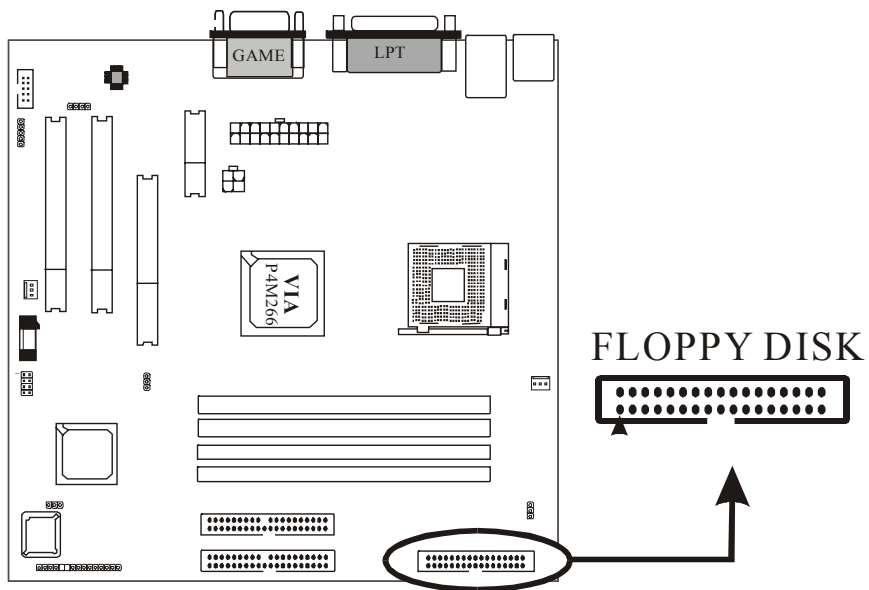



---

## 2-5-5 IDE1 and IDE2

The IDE connectors are used to connect IDE devices such as Harddisks and CD-ROM drives to the motherboard. Each connector constitutes an IDE channel, each channel accepts 2 IDE devices, one Master and one Slave. The IDE 1 connector is also known as the primary channel, IDE 2 is the secondary channel. Therefore the primary Master is the IDE device connected to IDE1 as Master, the primary Slave is the IDE device connected to IDE 1 as Slave. Jumpers on the IDE device determine Master and Slave settings. Your harddisk or CD-ROM should have a sticker with jumper settings. Make sure that you set these jumpers correct. Please use the following advice as reference:

- If you have only device connected to an IDE connector, always set it as Master.
- If you have one HDD and CD-ROM in your system, then connect the HDD to IDE1 as Master, and the CD-ROM to IDE 2 as Master
- If you have one Harddisk and one CD-ROM connected to the same IDE connector set the HDD to Master and the CD-RAM to Slave.

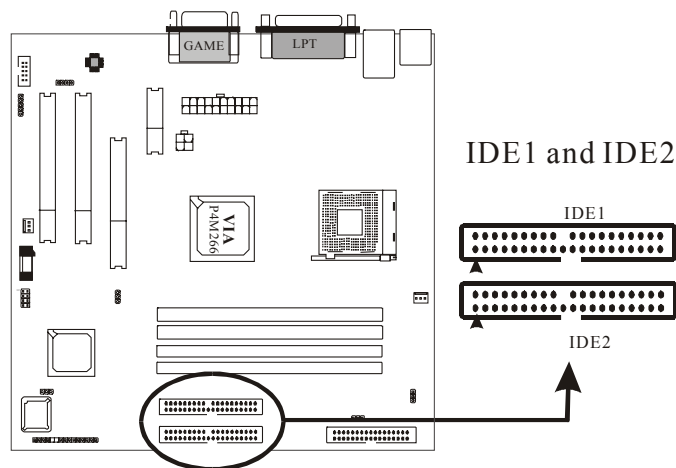

---

## 2-5-6 Internal Audio Connectors

Internal Audio Connectors is “CD\_IN” connectors”. It is a CD ROM external audio input signal to line-out (speaker) of the main board.

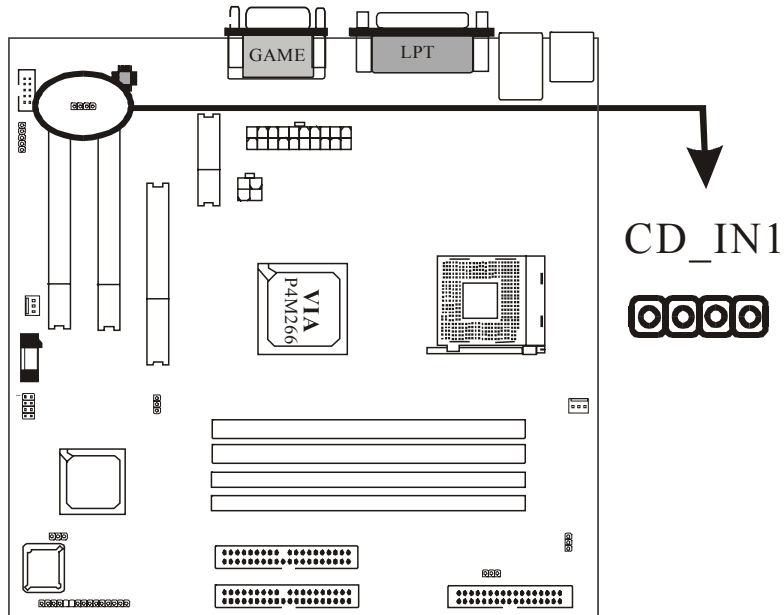

---

## 2-5-7 IR1: IrDA Connector

**IR connector** supports wireless infrared module. With this module and application software like Laplink, or Win95 Direct Cable Connection, user can transfer data to or from laptops, notebooks, PDA and printers. This connector supports HPSIR, ASKIR, and Fsat IR.

Attach Infrared module to IR connector. Be sure to put in the right direction during installation.

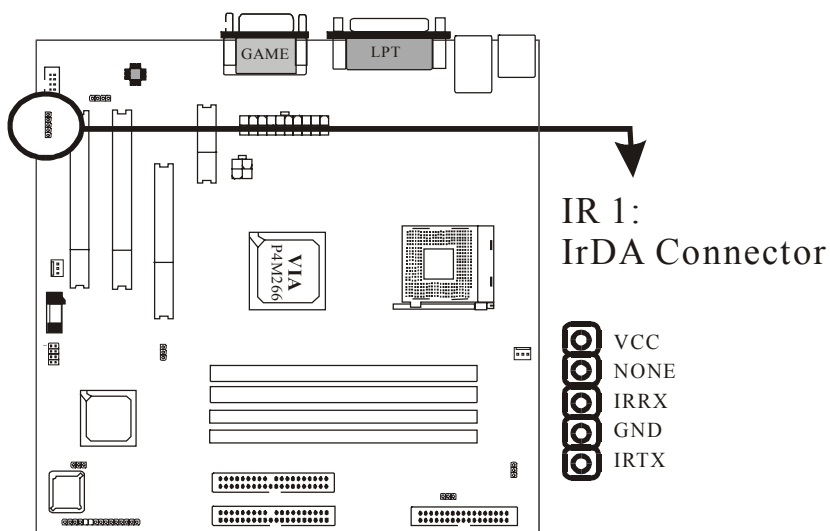

---

## 2-6 Memory

This motherboard can supports Double Data Rate (DDR) Memory Modules or Dual Inline Memory Modules (DIMMs). Two sockets are available for 2.5 Volt unbuttered DDR (Double Data Rate) and two sockets are available for 3.3Volt unbuttered SDRAM (Synchronous Dynamic Random Acces Memory). The DDR sizes that are supported are: 128, 256 or 512MB memory sizes between 128MB to 512MB can be formed this way. And the SDRAM sizes that are supported are 64, 128, 256, 512MB memory sizes between 64MB to 512MB. Refer to the picture below for the position of the DIMM slots:

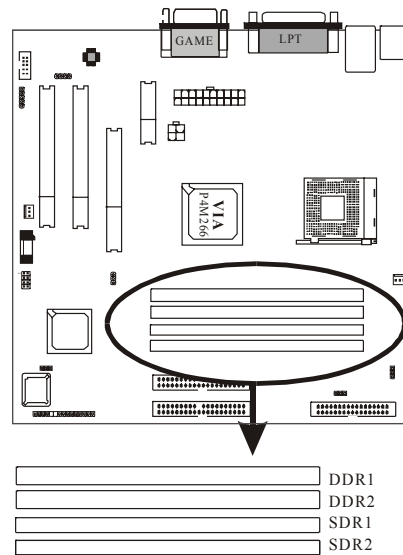

 ***Different types of memory can't be installed or combined to this board due to RAM memory voltage specifications. You can use either SDRAM memory or DDR memory. Not both !***

---

## 2-6-1 Memory Installation

The DIMM modules can be inserted in DIMM slots 1 to 4. 1 to 2 are DDR sockets and 3 to 4 are SDRAM sockets. Because of the notches in the DIMM module it can be inserted in only one way. Please refer to the picture below for information on how to insert the DIMM modules.

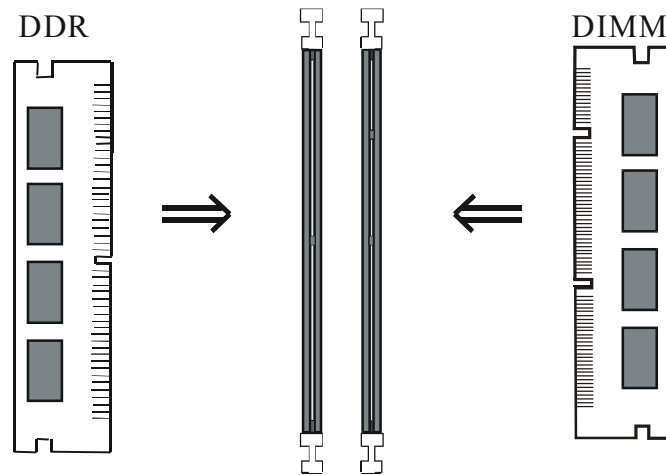

**WARNING:**

*Make sure that you unplug your power supply when adding or removing memory modules or other system components. Failure to do so may cause severe damage to both your motherboard and expansion cards*

---

## Chapter3 Software Install

### 3-1 Notice of CD Driver Installation

This CD contains below drivers. The user must read “Index” before installing required drivers. Index offers all the information on all the drivers.

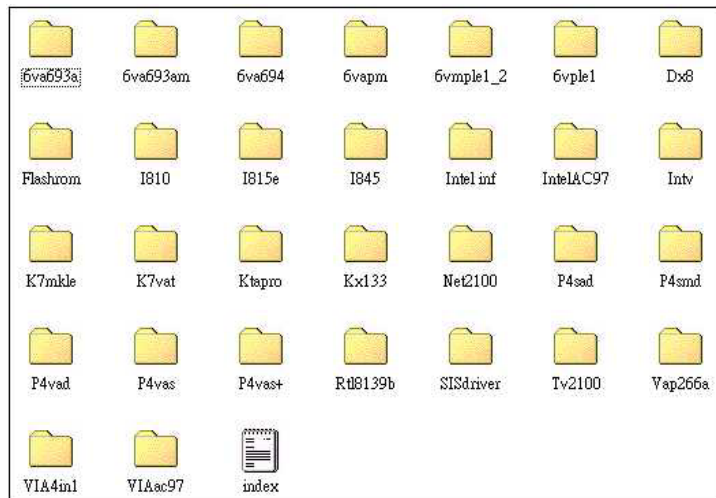

*CD driver is always updated with the latest version, so the actual CD content may be somewhat different from the above picture.*

1. **Main boards:** 6va693a, 6va693am, 6va694, 6vapm, 6vuple1\_2, 6vuple1, I810, I815e, I845, Intv, K7mkle, K7vat, Ktapro, Kx133, Net2100, P4sad, P4smd, P4vad, P4vas, P4vas+, Tv2100, Vap266a (**please select P4VAD directory for this main board**)
2. **DX8:** Windows DirectX8 driver.
3. **Flashrom:** BIOS flash upgrade utility .

---

## 3-2 How to Install Software Driver

### Installation Procedure:

#### 1. Install “Via 4 in 1” :

Select “VIA 4 in 1” directory from attached CD, then click “**setup**” to complete the installation; the “Via 4 in 1” drive provides O.S. Like windows 98/ ME to recognize VIA Chipset. Path root: \Via4in1\ Setup.exe

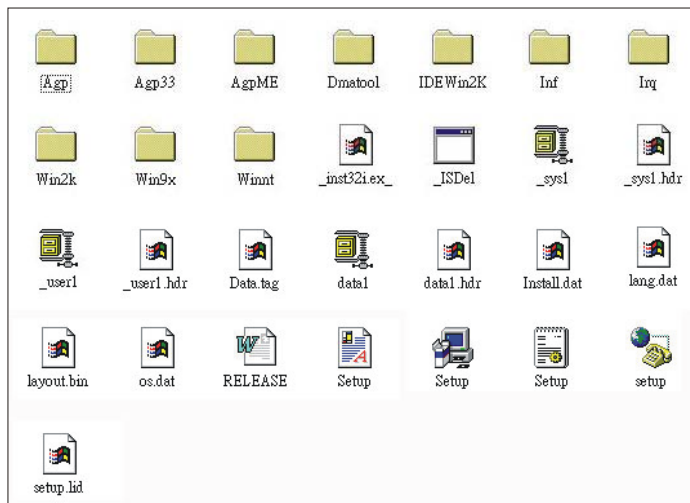

#### 2. Install sound drive:

Select “Viaac97” from attached CD, and selector the Vt8233 directory, then chick “**setup**” to complete the installation. This driver provides AC-97 Sound driver for O.S. Like windows 9X/ ME/ 2000 can detect by themselves. Path root: \VIAAC97\ Setup.exe

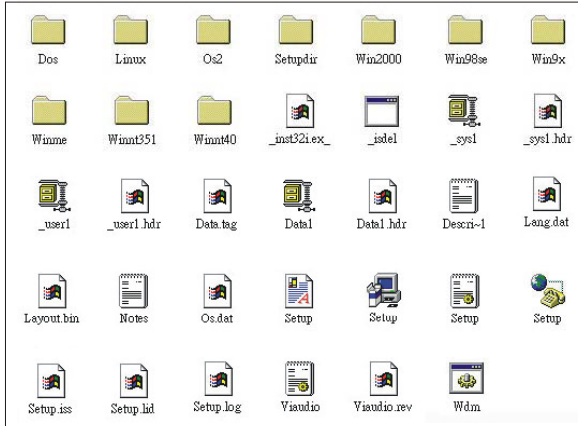

**3. If user wants to update BIOS, please choose “Flashrom” utility.**



---

## Chapter4 The BIOS

The BIOS is a piece of software (Basic Input Output System) that performs most low level tasks. When you start up your system, the BIOS is the first code that gets to run. The BIOS resides in a FLASH ROM, and the code in the FLASH ROM can be updated through a special utility called AWDFLASH. (Award Flash). This is generally not necessary, but in some cases updating the BIOS is necessary to support new devices that were not on the market at the time the motherboard was released. For the physical location of the BIOS FLASH ROM IC on your motherboard, refer to the picture below:

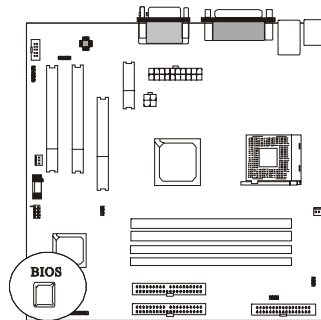

The BIOS IC is inserted in an IC socket, which means that it can be removed and exchanged for another IC if necessary.

### **Is updating my BIOS necessary?**

As a general rule if your system is functioning properly and you are not an experienced user, do not try to update the BIOS. Only if you have specific problems that a BIOS update may solve may it be advisable to update the BIOS.

The update process is pretty complex, and you should bear in mind that if updating the BIOS goes wrong you may render your system unbootable. Therefore, do not update unless you know what you are doing.

### **Finding the latest official BIOS revision**

For the latest official BIOS revision, please go to our website at [www.lucky-star.com.tw](http://www.lucky-star.com.tw). On the support page you can find the latest BIOS files for our motherboards.

---

## 4-1 Updating the BIOS

As said, this procedure is complicated, only update your BIOS when you experience

problems with your system. Because each BIOS release completely overwrites the previous version and there is no need to update to intermediate BIOS releases when updating the BIOS. Therefore always use the latest BIOS revision when doing a BIOS update. The BIOS update procedure is as follows:

- In order to flash update the BIOS, you will need 2 files:
  - The BIOS binary file (.bin file from the website)
  - AWDFLASH.EXE utility file. (This utility can be downloaded from our website)
- Create a directory on your C harddisk drive: and name it FLASH
- Put the BIOS .bin file and the AWDFLASH utility in the FLASH directory.  
**You may want to jot the BIOS .bin file name down on a piece of paper.**
- Restart the computer, press DEL to go into the BIOS, then please disable the following:
  - System BIOS Cacheable (in Advanced Chipset Features)
  - Video BIOS Shadow (in Advanced BIOS Features)Save the changes by selecting 'save and exit', and restart the computer.
- Press Ctrl + F5 just before Windows is starting up (right after the second BIOS screen) for a DOS boot, you will see the message "Windows is bypassing all your startup files". You end up at a DOS prompt.
- Now type `cd FLASH` to change to the newly created directory.
- Here type `AWDFLASH mybios.bin /py /cc /sn /cd`, where mybios.bin is the file name for the BIOS binary file you want your BIOS to upgrade to. Now the upgrading will begin.



**WARNING:**

*Do NOT in any way disturb the system during upgrading. If for any reason the system is stalled your system may not be able to boot again.*

- After the upgrading has ended press F1 to reset, press DEL to go into BIOS and make the following changes:
  - Load Setup Defaults.
  - Go into the Frequency/Voltage Control page to adjust your CPU speed and voltage (please make sure the CPU voltage matches your CPU specs, in case of doubts leave it to 'default').Save your settings and you are done.

---

## 4-2 The CMOS memory

The BIOS uses the CMOS memory to store all the settings that have been made through the BIOS Setup pages.

### Battery

The CMOS memory remembers all settings, even when the system is switched off, by use of a 3V Lithium battery. If this battery runs low CMOS is unable to keep its settings and you will need to replace the battery. The BIOS will give you an error message when it detects a low battery voltage. The error message 'CMOS checksum error' may also point to a low battery problem.

### Restoring default settings

You can load default values into the CMOS memory by selecting 'Load Optimized Defaults' in the BIOS Setup. If you need to force the CMOS settings to default without entering the BIOS Setup page you can use the JP6 jumper. For the location of the jumper and the battery, refer to the following picture:

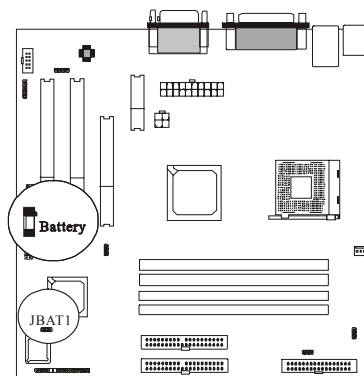



Normally JBAT1 will be in the 1-2 position, this will connect the battery to the southbridge of the chipset which contains the CMOS memory. If JBAT1 is temporarily set to 2-3 this will interrupt the battery electricity flow, and the CMOS memory will be erased, this will however only work if the power supply is not switched on. Now at the next reboot the BIOS will automatically load the CMOS default values.

---

Take the following steps to clear CMOS memory:

- Take the power cord from the power supply.
- Temporarily set JBAT1 to 2-3, and set it back to 1-2.
- Put the power cord back and restart the system, the default values will be loaded.

### CMOS Status

JBAT1	Retain CMOS settings	Clear CMOS Settings
CMOS		

The following part of this chapter will describe the individual BIOS Setup pages and all the items that can be adjusted to fine tune your system.

---

## 4-3 The BIOS Setup Pages

To enter the BIOS Setup pages, take the following steps:

- Start up the system.
- After memory counting has finished, press [DEL] to enter the BIOS Setup pages.

Now the following menu will appear:

<i>CMOS SETUP UTILITY Copyright © 1984 – 2001 Award Software</i>	
<i>▶ Standard CMOS Features</i>	<i>▶ Frequency/Voltage Control</i>
<i>▶ Advanced BIOS Features</i>	<i>Load Optimized Defaults</i>
<i>▶ Advanced Chipset Features</i>	<i>Set Supervisor Password</i>
<i>▶ Integrated Peripherals</i>	<i>Set User Password</i>
<i>▶ Power Management Setup</i>	<i>Save &amp; Exit Setup</i>
<i>▶ PnP/PCI Configurations</i>	<i>Exit Without Saving</i>
<i>▶ PC Health Status</i>	
<i>Esc : Quit      F9: Menu in BIOS</i>	<i>↑↓→← : Select Item</i>
<i>F10 : Save &amp; Exit Setup</i>	
<i>Time, Date, Hard Disk Type . . .</i>	

### Selecting items

To select items, use the following method:

- Use the arrow keys to move between items and select fields.
- Press [enter] to enter the selected submenu.

### Submenus

All items that start with a ▶ are submenus. Pressing [enter] when a submenu is selected will enter that submenu.

### Modifying selected items

The [Up]/[Down] keys can be used to modify values within the selected fields. Note that some fields also let you enter values directly.

---

## Hot Keys

Throughout the BIOS Setup Pages the hot keys will give you access to a group of commands. Refer to the following table for the hot keys and their function:

Key	Command	Description
F10	Save & Exit Setup	Saves the changes made and reboots the system.
[Esc]	Quit	Returns to the previous menu
F1	Help	General Help
F2	Help	Help for specific item
F5	Previous values	Restores the previous values. These are the values that the user started the current session with.
F7	Optimized Defaults	Loads all options with the Optimized Default values.

## Save & Exit Setup

When you select the [SAVE & EXIT SETUP] option from the Main Menu, all changes that you made will be saved to the CMOS memory and the setup utility will exit, rebooting your system.

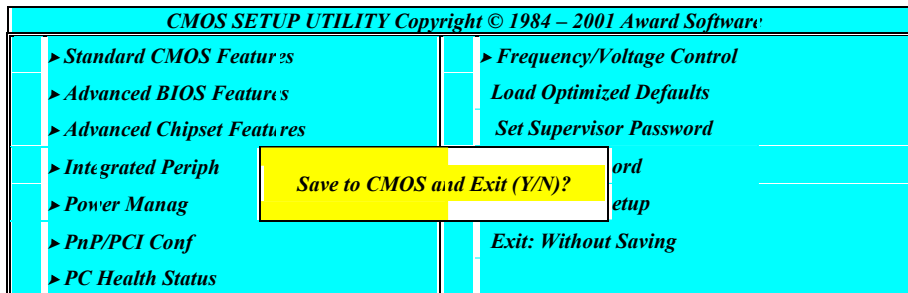

Pressing [Y] and [enter] will save the changes, pressing [N] and [enter] will keep the old settings.

---

### Exit Without Saving

Selecting 'Exit Without Saving' will exit Setup without saving changes to CMOS.

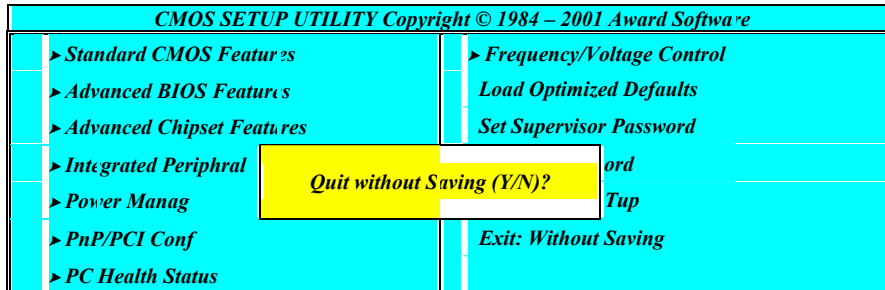

Pressing [Y] and [enter] will Exit without saving, pressing [N] and [enter] will not Exit.

## 4-3-1 Standard CMOS Setup

Select the [STANDARD CMOS SETUP] option from the Main Menu and press [Enter] key.

CMOS SETUP UTILITY Copyright © 1984 – 2001 Award Software		
Standard CMOS Features		
Date (mm:dd:yy)	Mon, Feb. 25 2002	Item Help
Time (hh:mm:ss)	11 : 51 : 58	
▶ IDE Primary Master	None	Menu Level ▶
▶ IDE Primary Slave	None	
▶ IDE Secondary Master	None	Change the day, month, year and Century
▶ IDE Secondary Slave	None	
Drive A	1.44M, 3.5 in.	
Drive B	None	
Video	EGA / VGA	
Halt On	All, But Keyboard	
Base Memory:	640K	
Extended Memory:	31744K	
Total Memory:	32768K	
↑ ↓ → ← : Move    Enter: Select    + / - / PU / PD: value    F10: save    ESC: Exit    F1: General Help F5: Previous Values    F6: Fail-Safe Defaults    F7: Optimized Defaults		

This screen allows you to change the basic CMOS Settings such as date and time, harddisk type etc. After you have made the changes you need to make press [ESC] to return to the main menu.

### Date and Time

	Default	Possible Settings	Notes
<b>Date</b>	Weekday, month, day, year	Type the current date. (weekday auto changes)	Using the P-Up / P-Dn keys to toggle is possible
<b>Time</b>	hh:mm:ss	Type the current time	24-hour clock for mat. (15:15:00 = 3:15:00)



## IDE Devices

When you select one of the IDE devices, a submenu will pop up. Refer to the picture below.

CMOS SETUP UTILITY Copyright © 1984 – 2001 Award Software		
IDE .xxx		
IDE HDD Auto Detection	Press Enter	Item Help
IDE Primary Master	Auto	Menu Level ▶▶
Access Mode	Auto	To auto-detect the HDD's size, head... on this channel
Capacity	0 MB	
Cylinder	0	
Head	0	
Precomp	0	
Landing Zone	0	
Sector	0	

This Menu is the same for all 4 IDE devices:

- Primary Master IDE 1 first device
- Primary Slave IDE 1 second device
- Secondary Master IDE 2 first device
- Secondary Slave IDE 2 second device

	Values	Meaning
IDE HDD Auto Detection	Press Enter	Pressing Enter will make the BIOS auto detect the IDE device on this channel. The result will be displayed below, starting with the 'capacity' item. (These items are read only)
	Auto	This will auto detect the device at each boot up.
IDE .xxx	Manual	This will use the setting set by the user. No auto detection at start up will take place.
	None	This setting means no device is present. This will prevent the BIOS from looking for a device and speed up booting.
	CHS	Selects the CHS access mode.
Access Mode	LBA	Logical Block Addressing, for HDD drives larger than 504MB (All modern HDDs)
	Large	For very large HDDs.
	Auto	The BIOS will automatically detect the best access mode.

---

### Drive A and Drive B

The Drive A / B items allow you select the type of device that you have attached to the Floppy (FDD1) connector on the motherboard. You can select between different floppy disk drive types by using the Page-Up and Page-Down keys. If you press [enter] while Drive A or B is selected the following menu will pop up that will allow to choose a device as well:

<i>Drive X</i>		
<i>None</i>	...	<input type="checkbox"/>
<i>360K, 5.25 in.</i>	...	<input type="checkbox"/>
<i>1.2M, 5.25 in.</i>	...	<input type="checkbox"/>
<i>720K, 3.5 in.</i>	...	<input type="checkbox"/>
<i>1.44M, 3.5 in.</i>	...	<input checked="" type="checkbox"/>
<i>2.88M, 3.5 in.</i>	...	<input type="checkbox"/>
<i>↑↓: Move Enter:Accept ESC: Abort</i>		

### Video

The Video item allows you to select a video mode. Since most modes are outdated we advise you to always select EGA/VGA. You can select between different video modes by using the Page-Up and Page-Down keys. If you press [enter] a menu pops up.

(Mono is for a monochrome screen that can only display one color)

<i>Video</i>		
<i>EGA/VGA</i>	...	<input checked="" type="checkbox"/>
<i>CGA 40</i>	...	<input type="checkbox"/>
<i>CGA 80</i>	...	<input type="checkbox"/>
<i>MONO</i>	...	<input type="checkbox"/>
<i>↑↓: Move Enter:Accept ESC: Abort</i>		

---

### **Halt On**

The BIOS will stop booting when an error is detected. You can set through this item what errors will stop the system booting. You can select between different error modes by using the Page-Up and Page-Down keys.

	<b>Values</b>	<b>Meaning</b>
	All Errors	Stop booting on all errors.
	No Errors	Always Boot, no matter what error is detected.
	ALL, BUT KEYBOARD	Stop booting on all errors, but not on a keyboard error.
<i>Halt On</i>	All, but diskette	Stop booting on all errors, but a diskette error.
	All, but disk/key	Stop booting on all errors, but keyboard and diskette errors.

## 4-3-2 BIOS Features Setup

Select the [Advanced BIOS Features] option from the Main Menu and press [Enter] key.

CMOS SETUP UTILITY Copyright © 1984 – 2001 Award Software Advanced BIOS Features		
		Item Help
Virus Warning	Disabled	
CPU L1 & L2 Cache	Enabled	
CPU L2 Cache ECC Checking	Enabled	Menu Level ▶
Quick Power On Self Test	Enabled	Allows you to choose the VIRUS warning
First Boot Device	Floppy	feature for IDE Hard Disk boot sector
Second Boot Device	HDD 0	protection. If this function is enabled and
Third Boot Device	CDROM	someone attempt to write data into this
Boot Other Device	Enabled	area, BIOS will show a warning message on
Swap Floppy Drive	Disabled	screen and clarm beep.
Boot Up Floppy Seek	Disabled	
Boot Up NumLock Status	On	
Typematic Rate Setting	Disabled	
X Typematic Rate (Chars/Sec)	6	
X Typematic Delay (Msec)	250	
Security Option	Setup	
OS Select For DRAM > 64 MB	Non-OS2	
Video BIOS Shadow	Enabled	
Small Logo (EPA) Show	Enabled	
↑↓ → ← : Move    Enter: Select    + / - /PU / PD: value    F10: save    ESC: Exit    F1: General Help F5 : Previous Values    F6: Fail-Safe Defaults    F7: Optimized Defaults		

---

### Virus protection

	Values	Meaning
<i>Virus Warning</i>	Enabled	The BIOS will give a beep and a warning whenever an attempt is made to write to the boot sector of the HDD.
	Disabled	The BIOS will allow write attempts to the boot sector

### CPU Cache settings

	Values	Meaning
<i>CPU L1 &amp; L2 Cache</i>	Disabled	
	Enabled	
<i>CPU L2 Cache ECC Checking</i>	Enabled	This will enable CPU Internal L2 cache of your CPU.
	Disabled	(Not recommended)

### Quick Power On Self Test

	Values	Meaning
<i>Quick Power On Self Test</i>	Enabled	The BIOS will execute test routines that test most parts of the motherboard during boot up.
	Disabled	The BIOS will skip the tests, speeding up the boot process. Errors will on the other hand not be detected.

### Floppy Drive Settings

	Values	Meaning
<i>Swap Floppy Drive</i>	Enabled	This will swap floppy A and B. Most systems not even have 2 floppy drives, so this item is irrelevant .
	Disabled	Floppy A and B are not swapped
<i>Boot-up Floppy Seek</i>	Enabled	The BIOS will test whether the floppy has 40 or 80 tracks during boot up. All new floppy drives are 80 tracks.
	Disabled	The BIOS will not test the amount of tracks.

### Boot Devices

The first to third boot device items allow you to select what device the system should boot from. If the BIOS fails to boot from the first boot device, it will attempt to boot from the second boot device, if that fails too, the third boot device is tried. If you set the *boot other device* item to enabled, the BIOS will try to boot from other devices if the first to third choices all fail. If you set this item to disabled, the BIOS will not boot if the first to third devices all fail to boot.

	Values	Meaning
<i>First ~ Third boot device</i>	Floppy	The system attempt to boot from diskette. (first boot device default)
	LS 120	The system will attempt to boot from an attached LS 120 drive. (Third boot device default)
	HDD 0	The system will attempt to boot from the first HDD. (Second boot device default)
	SCSI	The system will attempt to boot from the first device attached to the first SCSI interface.
	CD-ROM	The system will attempt to boot from the first CD-ROM found.
	HDD1	The system will attempt to boot from the second HDD.
	HDD2	The system will attempt to boot from the third HDD.
	HDD3	The system will attempt to boot from the fourth HDD.
	ZIP100	The system will attempt to boot from an attached ZIP 100 drive
	LAN	The system will attempt to boot over the network. You will require a LAN card with boot BIOS for this option to function.
Disabled	This disables booting from this device.	

### Keyboard Typematic Rate and Delay Settings

If you set the *typematic rate setting* item to disabled, the system will use the defaults of 6 and 250 for the rate and delay items. If you set it to enabled you can select the values yourself. Refer to the table below:

	Values	Meaning
<i>Typematic Rate</i>	6 ~ 30	This value sets the amount of time a character is repeated per second if it is kept down on the keyboard. Choose from the following values: 6, 8, 10, 12, 15, 20, 24, 30.
<i>Typematic Delay</i>	250 ~ 1000	This value sets the amount of time in ms before a character starts repeating after it was pressed on the keyboard. Choose from 250, 500, 750 and 1000 ms.

### Security Option

The security option item allows you to select when the password needs to be entered. Refer to the table below:

	Values	Meaning
<i>Security Option</i>	Setup	Password must be entered only when the user wants to enter the BIOS setup.
	System	The password must always be entered at boot.

---

### OS Select for DRAM > 64MB

	Values	Meaning
<i>OS select for DRAM &gt; 64MB</i>	Non-OS2	If your OS is not OS2, always select this setting.
	OS2	Select this setting only if your OS is OS2

### Shadow Option

This shadow options allow the BIOS to shadow (write to RAM) certain parts of the BIOS code. This will speed up running the code, since running from RAM is much faster than running from FLASH ROM.

	Values	Meaning
<i>Video BIOS Shadow</i>	Enabled	This will allow the BIOS to write the video BIOS to RAM. This will speed up execution and is the default setting.
	Disabled	No shadowing is allowed.

### Small Logo (EGA) Show

	Values	Meaning
<i>Small Logo (EPA) Show</i>	Disabled	This will not show the EPA logo in first screen.
	Enabled	Default.

---

### 4-3-3 Chipset Features Setup

Select the [Advanced BIOS Features] option from the Main Menu and press [Enter] key.

<i>CMOS SETUP UTILITY Copyright © 1984 – 2001 Award Software</i>		
<i>Advanced BIOS Features</i>		
▶ DRAM Clock/ Drive Control	Press Enter	Item Help
▶ AGP & P2P Bridge Control	Press Enter	
▶ CPU & PCI Bus Control	Press Enter	Menu Level ▶
Memory Hole	Disabled	
System BIOS Cacheable	Disabled	
Video RAM Cacheable	Disabled	
Delay Prior to Thermal	16 Min	
VGA Share Memory Size	32MB	
FB Address Conversion	Enabled	
FB Page Close Predication	Enabled	

↑↓→←: Move Enter: Select +/-/PU/PD: value F10: save ESC: Exit F1: General Help  
F5: Previous Values F6: Fail-Safe Defaults F7: Optimized Defaults



CMOS SETUP UTILITY Copyright © 1984 – 2001 Award Software DRAM Clock/ Drive Control		
Current FSB Frequency		Item Help
Current DRAM Frequency		Menu Level ▶
DRAM Clock	BY SPD	
DRAM Timing	BY SPD	
SDRAM CAS Latency	2	
Bank Interleave	Disabled	
Precharge to Active (Trp)	3T	
Active to Precharge (Tras)	6T	
Active to CMD (Trcd)	3T	
DRAM Burst Len	4	
CPU read DRAM Mode	Medium	
↑↓→←: Move Enter: Select +/- /PU / PD: value F10: save ESC: Exit F1: General Help F5 : Previous Values F6:Fail-Safe Defaults F7: Optimized Defaults		

### DRAM Control

	Values	Meaning
<b>DRAM Clock</b>	By SPD	
	100 MHz	If your DIMM modules are PC-100 compliant, select this setting.
	133 MHz	Only when your DIMM modules are PC-133 compliant can you use this setting. In case of instability always select 100MHz.
<b>DRAM Timing</b>	Manual	Setting the RAM timing by user.
	By SPD	Auto setting by SPD.
<b>SDRAM CAS Latency</b>	2	The SDRAM CAS latency is 2.
	2.5	The SDRAM CAS latency is 2.5.
<b>Bank Interleave</b>	Disabled	This is the safest setting (default).
	2 bank	This setting is faster than disabled.
	4 bank	This is fastest setting.
<b>DRAM Burst Len</b>	4	Set DRAM Burse to 4.
	8	Set DRAM Burse to 8.

### Precharge & Active (Trp)

	Values	Meaning
<i>Precharge to Active (Trp)</i>	2T	
	3T	
<i>Active to Precharge (Tras)</i>	5T	
	6T	
<i>Active to CMD (Trcd)</i>	2T	
	3T	

### CPU read DRAM Mode

	Values	Meaning
<i>CPU read DRAM Mode</i>	Slow	This setting for slow speed DRAM.
	Fast	This setting for fast speed DRAM.
	Medium	This setting for manual speed DRAM.

<b>CMOS SETUP UTILITY Copyright © 1984 – 2001 Award Software</b> AGP & P2P Bridge Control		
<i>AGP Aperture Size</i>	64M	<i>Item Help</i>
<i>AGP Mode</i>	4X	<i>Menu Level ▶</i>
<i>AGP Driving Control</i>	Auto	
<i>AGP Driving Value</i>	DA	
<i>AGP Fast Write</i>	Disabled	
<i>AGP Master 1 WS Write</i>	Disabled	
<i>AGP Master 1 WS Read</i>	Disabled	
↑↓→←: Move Enter: Select +/-/PU/PD: value F10: save ESC: Exit F1: General Help F5: Previous Values F6: Fail-Safe Defaults F7: Optimized Defaults		

### AGP Settings

	Values	Meaning
<i>AGP Aperture Size</i>	4-256M	This item allows setting of the main memory that is assigned to the AGP card. Normally about half or less of the total memory should be assigned. Choose from 4, 8, 16, 32, 64, 128 and 256MB, default is 64MB.
<i>AGP Mode</i>	4X	If your AGP card support 4X mode, selector this setting.
	2X	If your AGP card support 2X mode, selector this setting.
	1X	If your AGP card support 1X mode, selector this setting.

<b>AGP Driving Control</b>	Auto	The BIOS sets the value automatically.
	Manual	The AGP Driving Value item below can be used to set the value.
<b>AGP Driving Value</b>	00-FF	This value sets the timing of the signal that the video card driver uses to communicate over the AGP bus. The range is from 00-FF Hex (00-255 DEC).
<b>AGP Fast Write</b>	Disabled	
	Enabled	

### AGP Bus Timing Setting

	Values	Meaning
<b>AGP Master 1 WS Write</b>	Enabled	AGP Writes are executed with 1 wait state, enable only if your AGP card support this.
	Disabled	AGP Write take longer than 1 wait state, default setting.
<b>AGP Master 1 WS Read</b>	Enabled	AGP Reads are executed with 1 wait state, enable only if your AGP card supports this.
	Disabled	AGP Reads take longer than 1 wait state, default setting.

CMOS SETUP UTILITY Copyright © 1984 – 2001 Award Software CPU & PCI Bus Control		
CPU to PCI Write Buffer	Enabled	Item Help
PCI Master 0 WS Write	Enabled	Menu Level ▶
PCI Delay Transaction	Disabled	
↑↓→←: Move Enter: Select +/-/PU/PD: value F10: save ESC: Exit F1: General Help F5: Previous Values F6: Fail-Safe Defaults F7: Optimized Defaults		

### PCI Bus Timing Setting

	Values	Meaning
<b>CPU to PCI write Buffer</b>	Enabled	When enabled CPU writes to PCI are buffered, the CPU will not have to wait for the transaction to finish.
	Disabled	The CPU will have to wait for each PCI write to finish before a new write can be initiated.
<b>PCI Master 0 WS write</b>	Enabled	PCI Master Wait stat set to 0 sec.
	Disabled	PCI Master Wait stat do not set to 0 sec.
<b>PCI delay Transaction</b>	Enabled	The chipset has a write buffer that supports delayed transactions. Enable this item for PCI 2.1 compliance.

	Disabled	This will shut down use of the integrated buffer, no delayed transactions are allowed.
--	----------	--

### Memory Hole

Some old devices need a memory hole to be present between 15M and 16M. CPU Cycles matching the hole will be passed on to the PCI bus instead of accessing the memory.

Normally you can disable this setting, but if one of your devices needs it set it to enabled.

	Values	Meaning
<i>Memory Hole at 15M-16M</i>	Disabled	There is no memory hole.
	Enabled	A memory hole exists between 15 and 16MB.

### Cache Settings

The following settings are related to cacheability of video RAM and the system BIOS, change them only if you are an experienced user.

	Values	Meaning
<i>System BIOS Cacheable</i>	Enabled	This will enable caching of the system BIOS memory section. This means that BIOS code can run faster when called often.
	Disabled	This will not cache any BIOS code, meaning that BIOS code will have to be read from memory each time.
<i>Video RAM Cacheable</i>	Enabled	This will enable caching of Video memory, which speeds up video operations. This can only be done if the Video card does not access the video memory itself at the mean time.
	Disabled	No caching of Video data is done, meaning that Video data will have to be read from/ Written to memory each time.

### Delay Prior to Thermal

	Values	Meaning
<i>Delay Prior to Thermal</i>	4-32Min	

### VGA Share Memory Size

<i>VGA Share Memory Size</i>	Disabled	Selector this setting if you don't use OnChip VGA.
	4-32M	You can select the VGA memory size from 4/ 8/ 16/ 32MB.

### FB Setting

<i>FB Address</i>	Disabled	
-------------------	----------	--

---

<i>Conversion</i>	Enabled	
<i>FB Page Close</i>	Enabled	
<i>Predication</i>	Disabled	

## 4-3-4 Integrated Peripherals

Select the [Integrated Peripherals] option from the Main Menu and press [Enter] key.

<b>CMOS SETUP UTILITY Copyright © 1984 – 2001 Award Software</b>		
<b>Integrated Peripherals</b>		
▶ VIA OnChip IDE Device	Press Enter	Item Help
▶ VIA OnChip PCI Device	Press Enter	
AMR Control SW	Enabled	Menu Level ▶
▶ Super IO Device	Press Enter	
Init Display First	PCI Slot	
OnChip USB Control	All Enabled	
USB Keyboard Support	Disabled	
USB Mouse Support	Disabled	
IDE HDD Block Mode	Enabled	
↑↓ → ← : Move Enter: Select +/- / PU / PD: value F10: save ESC: Exit F1: General Help F5 : Previous Values F6: Fail-Safe Defaults F7: Optimized Defaults		

CMOS SETUP UTILITY Copyright © 1984 – 2001 Award Software VIA OnChip IDE Device		
OnChip IDE Channel0	Enabled	Item Help
OnChip IDE Channel1	Enabled	
IDE Prefetch Mode	Enabled	Menu Level ▶
Primary Master PIO	Auto	
Primary Slave PIO	Auto	
Secondary Master PIO	Auto	
Secondary Slave PIO	Auto	
Primary Master UDMA	Auto	
Primary Slave UDMA	Auto	
Secondary Master UDMA	Auto	
Secondary Slave UDMA	Auto	
↑↓→←: Move Enter: Select +/- PU / PD: value F10: save ESC: Exit F1: General Help F5 : Previous Values F6:Fail-Safe Defaults F7: Optimized Defaults		

### IDE Channel Settings

The following table explains IDE channel settings and what they mean:

	Values	Meaning
<b>OnChip IDE Channel0</b>	Enabled	Enables the use of the first (primary) IDE channel.
	Disabled	This will disable the use of the first (primary) IDE channel.
<b>OnChip IDE Channel1</b>	Enabled	Enables the use of the secondary IDE channel.
	Disabled	This will disable the use of the secondary IDE channel.
<b>IDE Prefetch Mode</b>	Enabled	This will set the IDE to preferable mode.
	Disabled	This will set the IDE to Manual mode.
<b>xxx PIO</b>	Auto	The BIOS will assign a PIO mode to this device automatically when appropriate
	Mode 0	Select a PIO Mode here. PIO mode 0 is slowest, PIO mode 4 is fastest, check your HDD to see what PIO mode it supports. If your IDE device supports UDMA mode, then it best to enable that mode since it is considerably faster than PIO mode. (Set to auto for auto-detection)
	Mode 1	
	Mode 2	
	Mode 3	
Mode 4		
<b>xxx - UDMA</b>	Auto	The BIOS will automatically use Ultra DMA Mode if the IDE device supports it.
	Disabled	This will disable the use of Ultra DMA for this device.

<b>IDE HDD Block Mode</b>	Enabled	Block mode allows faster transfer of data between the system and the HDD. Most modern HDDs support it.
	Disabled	Block Mode is not used.

<b>CMOS SETUP UTILITY Copyright © 1984 – 2001 Award Software VIA OnChip PCI Device</b>		
<i>VIA-3058 AC'97 Audio</i>	<i>Auto</i>	<i>Item Help</i>
<i>VIA-3068 MC'97Modem</i>	<i>Auto</i>	
<i>VIA-3043 On Chip LAN</i>	<i>Enabled</i>	<i>Menu Level ▶</i>
<i>OnChip LAN Rom</i>	<i>Disabled</i>	
↑↓ → ← : Move Enter: Select +/- / PU / PD: value F10: save ESC: Exit F1: General Help F5 : Previous Values F6:Fail-Safe Defaults F7: Optimized Defaults		

### AC97 Setting

	Values	Meaning
<b>VIA-3058 AC97 Audio</b>	Auto	This will allow use of a onboard AC97 sound codec.
	Disabled	If you do not need a onboard AC97 sound codec, set this item to disabled.
<b>VIA-3068 MC97 Modem</b>	Auto	This will allow use of a onboard MC97 modem codec.
	Disabled	If you do not need a onboard MC97 codec, set this item to disabled.

### LAN Setting

	Values	Meaning
<b>VIA-3043 OnChip LAN</b>	Enabled	This will allow use of an onboard LAN chipset.
	Disabled	If you do not need an onboard LAN chipset, set this item to disabled.
<b>OnChip LAN Boot Rom</b>	Enabled	Operation LAN Boot ROM when booting.
	Disabled	Don't using LAN Boot ROM when booting.

### AMR Control SW

	Values	Meaning
<b>AMR Control SW</b>	Enabled	
	Disabled	



CMOS SETUP UTILITY Copyright © 1984 – 2001 Award Software OnChip Super IO Device		
Onboard FDC Controller	Enabled	Item Help
Onboard Serial Port 1	3F8/IRQ4	
Onboard Serial Port 2	2F8/IRQ3	Menu Level ▶
UART Mode Select	Normal	
UR2 Duplex Mode	Half	
Onboard Parallel Port	378/IRQ7	
Parallel Port Mode	SPP	
ECP Mode Use DMA	3	
Game Port Address	201	
Midi Port Address	330	
Midi Port IR 2	10	
↑↓ → ← : Move Enter: Select + / - / PU / PD: value F10: save ESC: Exit F1: General Help F5 : Previous Values F6: Fail-Safe Defaults F7: Optimized Defaults		

### Floppy Drive

	Values	Meaning
<b>Onboard FDD Controller</b>	Enabled	This will allow use of a floppy drive.
	Disabled	If you do not need a floppy drive, set this item to disabled.

### COM ports (Serial Ports)

	Values	Meaning
<b>Onboard serial port 1 / 2</b>	Auto	The bios will automatically use serial ports.
	Disabled	If you do not need the serial port in question, set this item to disabled.
	3F8/IRQ4	Set an IO address and an IRQ to be used by serial ports.
	2F8/IRQ3	
	3E8/IRQ4	
2E8/IRQ3		

### IR Control

	Values	Meaning
<b>UART Mode Select</b>	Normal	
	IrDA	Allows use of the IR port in IrDA mode.
	ASKIR	Allows use of the IR port in ASKIR mode.
	SCR	Allows use of the IR port in SCR mode.

<b>UR2 Duplex Mode</b>	Half	Select if your IR device supports Half duplex only.
	Full	For IR devices that support full duplex.

### Paraller Port (Printer Port)

	Values	Meaning
<b>Onboard Parallel Port</b>	Disabled	Disables use of the parallel port.
	3BC/ IRQ7	Select and IO Address and an IRQ to be used by the parallel port.
	378/ IRQ7	
278/ IRQ5		
<b>Parallel Port Mode</b>	SPP	Enables use of SPP devices.
	EPP	Enables use of EPP devices.
	ECP	Enables use of EPP devices.
	ECP	Enables use of ECP + EPP devices.
<b>ECP mode use DMA</b>	1 or 3	Select either DMA channel 1 or 3 (This is only relevant if ECP was selected above). Default is channel 3.

### Game Port

	Values	Meaning
<b>Game Port</b>	201	Setting game port address at 201
	209	Setting game port address at 209.
	Disabled	Disabled game port.

### MIDI

	Values	Meaning
<b>Midi Port Address</b>	300	Set mpu401 port address at 300.
	330	Set mpu401 port address at 330.
	Disabled	Without midi port or none AC97 m/b
<b>Midi Port IRQ</b>	5	Set mpu-40 port IRQ address at 5.
	10	Set mpu-40 port IRQ address at 5.

### Display Initialization

	Values	Meaning
<b>Init Display First</b>	PCI Slot	The BIOS will first search for a VGA adapter on the PCI bus, if one is found it will be used as primary display.
	AGP	The onboard AGP is first scanned.

### USB Setting

---

	<b>Values</b>	<b>Meaning</b>
<i><b>OnChip USB Controller</b></i>	All Disabled	This will not allow use of the USB drives.
	All Enabled	This will allow use all of the USB drives.
	1 & 2 USB Port	This will allow use 1 & 2 of the USB drives.
	2 & 3 USB Port	This will allow use 2 & 3 of the USB drives.
	1 & 3 USB Port	This will allow use 1 & 3 of the USB drives.
	1 USB Port	This will allow use 1 of the USB drives.
	2 USB Port	This will allow use 2 of the USB drives.
	3 USB Port	This will allow use 3 of the USB drives.
<i><b>USB Keyboard Support</b></i>	Enabled	This will allow use of a USB keyboard.
	Disabled	If you do not need a USB keyboard, set this item to disabled.
<i><b>USB Mouse Support</b></i>	Enabled	This will allow use of a USB mouse.
	Disabled	If you do not need a USB mouse, set this item to disabled.

## 4-3-5 Power Management Setup

Select the [Power Management Setup] option from the Main Menu and press [Enter] key.

CMOS SETUP UTILITY Copyright © 1984 – 2001 Award Software		
Power Management Setup		
ACPI Function	Enabled	Item Help
ACPI Suspend Type	S1 (POS)	Menu Level ▶
Power Management Option	User Define	
HDD Power Down	Disable	
Suspend Mode	Disable	
Video Off Option	Suspend → Off	
Video Off Method	V/H SYN + Blank	
Modem Use IRQ	3	
Soft-Off by FWRBTN	Instant-Off	
Run BGABIOS if S3 Resume	Auto	
▶ IRQ/Event Activity Detect	Press Enter	

↑↓→←: Move Enter: Select PU/PD/+/-: value F10: save ESC: Exit F1: General Help  
 F5: Previous Values F6: Fail-Safe Defaults F7: Optimized Defaults

---

### ACPI Function

	Values	Meaning
<i>ACPI Function</i>	Enabled	Set power control function by ACPI.
	Disabled	Set power control function by APM.

### Power Management Option

	Values	Meaning
<i>Power Management Option</i>	User Define	The three items below can be set by the user.
	Min Saving	The three items below are set to: disabled, 1 hour, 1hour respectively.
	Max Saving	The three items below are set to : disabled, 1 min, 1min respectively.
<i>HDD Power Down</i>	Disabled	Will not poeer down the HDD.
	1 – 15Min	Will power down the HDD if it is idle for the amount of minutes selected here.
<i>Suspend Mode</i>	Disabled	The system will never enter suspend mode.
	1Min – 1Hour	Selecting a time will force the system into suspend mode after being idle for that time. Choose from the following time intervals: 1, 2, 4, 6, 8, 10, 20, 30, 40, min and 1 Hour.

### Video Options

	Values	Meaning
<i>Video Off Option</i>	Always On	The monitor will always be on, no matter what the state of the system.
	Suspend -> Off	The monitor will be turned of in suspend mode. The item below will specify what off method to use.
	MODEM Use IRQ	The monitor will be turned off in doze and suspend mode. The item below will specify what off method to use.
<i>Video Off Method</i>	Blank Screen	The screen will be blank (black) only.
	V/H sync + blank	The vertical and horizontal sync pulses will be stopped, and the screen will be blank.
	DPMS support	If your monitor supports DPMS, it can be switched off through that.

**Modem IRQ**

	Values	Meaning
<b>Modem Use IRQ</b>	NA	This disables the modem IRQ
	3 - 11	Select an IRQ line that will be assigned to your modem here. Choose from: 3 (default), 4, 5, 7, 9, 10, 11.

**Power Button**

	Values	Meaning
<b>Soft off by PWRBTN</b>	Instant-off	Switches the system off immediately when pressing the power button.
	Delay 4 Sec	This requires you to press the power button for at least 4 seconds before the system switches off.

**Run BGABIOS if S3 Resume**

	Values	Meaning
<b>Run BGABIOS if S3 Resume</b>		

<b>CMOS SETUP UTILITY Copyright © 1984 – 2001 Award Software</b>		
<b>Wake Up Events</b>		
	Hot Key	Item Help
PS2KB Wakeup Select	Disabled	
PS2KB Wakeup from S3/S4/S5	Disabled	
VGA	OFF	Menu Level ▶▶
LPT & COM	LPT / COM	
HDD & FDD	ON	
PCI Master	OFF	When Select Password. Please press ENTER key to change Password Max 8 numbers.
Modem Ring Resume	Disabled	
RTC Alarm resume	Disabled	
X Date (of Month)	0	
X Resume time (hh:mm:ss)	0 : 0 : 0	
IRQs Activity Monitoring	Press Enter	

Refer to the following table for more details:

	Values	Meaning
<b>PS2KB Wakeup Select</b>	Hot Key	When Select Password, Please press ENTER key to change Password Max 8 numbers.

	Disabled	Set the wake up on keyboard function to disabled.
<b>PS2KB Wakeup from S3/ S4/ S5</b>	Ctrl + F1 – Ctrl + F12	Set when kick Ctrl + F1 ~ Ctrl + F12 can wake up on keyboard.
	Power	When kick the power key will wake up on keyboard.
	Wake up by Any Key	When kick any key on keyboard will wake up on keyboard.
<b>VGA</b>	OFF	Will not allow the system to wake up on the VGA IRQ
	ON	When a VGA IRQ occurs the system will wake up.
<b>LPT &amp; COM</b>	None	Neither LPT or COM IRQs will wake the system up.
	LPT	A LPT (printer port) IRQ will wake up the system
	COM	A COM (serial port) IRQ will wake up the system
	LPT/COM	Both LPT and COM can wake up the system
<b>HDD &amp; FDD</b>	OFF	Will not allow the system to wake up on HDD / FDD IRQs
	ON	When a HDD / FDD IRQ occurs the system will wake up.
<b>PCI Master</b>	OFF	Will not allow the system to wake up on a IRQ from a PCI master.
	ON	The system will wake up on a PCI master IRQ.
<b>Modem Ring Resume</b>	Disabled	The system will not wake up on a modem ring signal.
	Enabled	When the modem detects a ring signal, the system will wake up.
<b>RTC Alarm Resume</b>	Disabled	The system will not wake up on a RTC Alarm.
	Enabled	When the time set in the two items below is reached, the RTC will generate an IRQ and the system will wake up.
<b>Date (of Month)</b>	0 - 31	Set the day of month for the system to wake up on.
<b>Resume time</b>	xx:xx:xx	Set the time (hh:mm:ss) for the system to wake up on.
<b>Primary INTR</b>	ON	You can select IRQs that allow the system to wake up in the IRQ Activity Monitoring item below.
	OFF	The IRQ Activity Monitoring item is disabled.

---

### IRQ Activity Monitoring

If you select ON for the Primary INTR item, pressing [Enter] on the IRQ Activity Monitoring item will show the following sub menu.

<i>CMOS SETUP UTILITY Copyright © 1984 – 2001 Award Software</i>		
<i>Wake Up Events</i>		
<i>Primary INTR</i>	<i>On</i>	<i>Item Help</i>
<i>IRQ3 (COM 2)</i>	<i>Disabled</i>	
<i>IRQ4 (COM 1)</i>	<i>Enabled</i>	<i>Menu Level &gt;&gt;&gt;</i>
<i>IRQ5 (LPT 2)</i>	<i>Enabled</i>	
<i>IRQ6 (Floppy Disk)</i>	<i>Enabled</i>	
<i>IRQ7 (LPT 1)</i>	<i>Enabled</i>	
<i>IRQ8 (RTC Alarm)</i>	<i>Disabled</i>	
<i>IRQ9 (IRQ2 Redirection)</i>	<i>Disabled</i>	
<i>IRQ10 (Reserved)</i>	<i>Disabled</i>	
<i>IRQ11 (Reserved)</i>	<i>Disabled</i>	
<i>IRQ12 (PS/2 Mouse)</i>	<i>Enabled</i>	
<i>IRQ13 (Coprocessor)</i>	<i>Enabled</i>	
<i>IRQ14 (HDL)</i>	<i>Enabled</i>	
<i>IRQ15 (Reserved)</i>	<i>Disabled</i>	



### 4-3-6 PnP / PCI Configurations

Select the [PnP / PCI Configurations] option from the Main Menu and press [Enter] key.

CMOS SETUP UTILITY Copyright © 1984 – 2001 Award Software PnP / PCI Configurations		
PNP OS Installed	No	Item Help
Reset Configuration Data	Disabled	
Resources Controlled by X IRQ Resources	Auto (ESCD) Press Enter	Menu Level ▶ Select Yes if you are using a Plug and Play capable operating System. Select No if you need the BIOS to configure non-boot devices.
PCI/VGA Palette snoop	Disabled	
Assign IRQ For VGA	Enabled	
Assign IRQ For USB	Enabled	
↑ ↓ → ← : Move Enter: Select +/- /PU / PD: value F10: save ESC: Exit F1: General Help F5 : Previous Values F6: Fail-Safe Defaults F7: Optimized Defaults		

#### PNP OS Installed

	Values	Meaning
PNP OS Installed	Yes	Select Yes if you are using a Plug and Play capable operating System.
	No	Select No if you need the BIOS to configure non-boot devices.

#### Reset Configuration Data

	Values	Meaning
Reset Configuration Data	Disabled	This will not reset the system configuration data (IRQs, DMAs) on reboot.
	Enabled	This will reset the configuration data. Remember to enable this item every time you make a change to your system (such as switching PCI cards etc).

---

### Resources Controlled by

	Values	Meaning
<b>Resources Controlled By</b>	Manual	The table will show the below items: “ <b>Reset Configuration Data, IRQ-3 assigned to, DMA-0 assigned to.</b> ” The user can adjust the shown items as required.
	Auto	The table will not show the above items, and the system will automatically assign the above setup.

### Resources

If you set the Resources Controlled by item to Auto (ESCD), the BIOS will manage all resources for you. If you set it to manual to two items below will allow you to assign the resources manually.

	Values	Meaning
<b>IRQ-x assigned to (x = 3 to 15)</b>	PCI/ISA PnP	This setting means the BIOS will assign the interrupt as needed. This means that it is not fixed to a device
	Legacy ISA	If you need to make sure that a certain interrupt is assigned to an ISA device, set that interrupt to legacy ISA.
<b>DMA-x assigned to (x = 0, 1, 3, 5, 6, 7)</b>	PCI/ISA PnP	This setting means the BIOS will assign the DMA Channel as needed, it is not fixed to a device
	Legacy ISA	If you need to make sure that a certain DMA channel is assigned to an ISA device, set that channel to legacy ISA.

### PCI / VGA Palette Snoop

	Values	Meaning
<b>PCI / VGA Palette Snoop</b>	Disabled	Default setting.
	Enabled	This will allow the system to look at the palette the VGA uses to display. Some applications speed up with this setting but it is mostly obsolete.

### Assign IRQs

	Values	Meaning
<b>Assign IRQ for VGA</b>	Enabled	This will assign an interrupt to your VGA card. Make sure to enable this item if your card needs one.
	Disabled	The BIOS will not assign an interrupt to the VGA card.
<b>Assign IRQ for USB</b>	Enabled	If you plan to make use of USB devices, set this item to enabled.
	Disabled	The BISO will not assign an interrupt to USB.

## 4-3-7 PC Health Status

Select the [PC Health Status] option from the Main Menu and press [Enter] key.

CMOS SETUP UTILITY Copyright © 1984 – 2001 Award Software PC Health Status		
Shutdown Temperature	Disabled	Item Help
Voltage 0		
Voltage 1		Menu Level ▶
Voltage 2		
Voltage 3		
Voltage 4		
Voltage 5		
Voltage 6		
Voltage 7		
Voltage Battery		
CPU Temperature		
Fan 1 Speed		
Fan 2 Speed		
Fan 3 Speed		
↑↓ → ← : Move Enter: Select +/- / PU / PD: value F10: save ESC: Exit F1: General Help F5 : Previous Values F6: Fail-Safe Defaults F7: Optimized Defaults		

### Shutdown Temperature

	Values	Meaning
Shutdown Temperature	Disabled	
	60°C / 140°F, 65°C / 149°F, 70°C / 158°F,	

---

## 4-3-8 Frequency/ Voltage Control

Select the [Frequency / Voltage Control] option from the Main Menu and press [Enter] key.

<i>CMOS SETUP UTILITY Copyright © 1984 – 2001 Award Software</i>		
<i>Frequency / Voltage Control</i>		
<i>CPU Clock Ratio</i>	<i>8X</i>	<i>Item Help</i>
<i>Auto Detect PCI/DIMM Clk</i>	<i>Disabled</i>	
<i>Spread Spectrum</i>	<i>Disabled</i>	<i>Menu Level ▶</i>
<i>CPU Host/PCI/3V66 Clock</i>	<i>Default</i>	
<i>↑↓→←: Move Enter: Select +/- / PU / PD: value F10: save ESC: Exit F1: General Help</i>		
<i>F5: Previous Values F6: Fail-Safe Defaults F7: Optimized Defaults</i>		

---

### CPU Clock Ratio

	Values	Meaning
<i>CPU Clock Ratio</i>	X8 ~ X50	This can setting the CPU ratio.

### Auto Detect PCI Clk

	Values	Meaning
<i>Auto Detec PCI/ DIMM Clk</i>	Enabled	If set to enabled the BIOS will detect the values for the PCI clock.
	Disabled	If disabled, the BIOS will use the values set on this page and on the Advanced Chipset Features page.

### Spread Spectrum

	Values	Meaning
<i>Spread Spectrum</i>	Disabled	
	+/-0.25%	
	-0.5%	
	+/-0.5%	
	+/-0.38%	

### CPU Clock

	Values	Meaning
<i>CPU Host/ PCI/ 3V66 Clock</i>	<i>Default</i>	
	100/66/33Mhz, 102/68/34Mhz, 105/70/35Mhz, 108/72/36Mhz, 111/74/37Mhz, 114/76/38Mhz, 117/78/39Mhz, 120/80/40Mhz, 123/82/41Mhz.	

---

## 4-3-9 Passwords

The BIOS Setup program allows you to specify passwords in the Main menu. The passwords control access to the BIOS during system startup. The passwords are not case sensitive. In other words, it makes no difference whether you enter a password using upper or lowercase letters. The BIOS Setup program allows you to specify two separate passwords:

- Supervisor password
- User password.

The function of the supervisor password depends on the setting for the Security Option item on the Advanced BIOS Features page. If set to System, the supervisor password must be given every time the system boots, if set to setup, the password must be given only when you want to enter the BIOS Setup.

The user password has the same functionality, with the only difference that anybody logging in with the user password may only change the user password when entering the BIOS Setup page. All other items in the BIOS Setup will be disabled (unchangeable).

When both passwords are disabled, anyone may access all BIOS Setup program functions.

### Setting the password

To set the Supervisor password, select the Set Supervisor Password item in the main BIOS Setup Menu. Now a dialog will pop up asking you to enter a password.

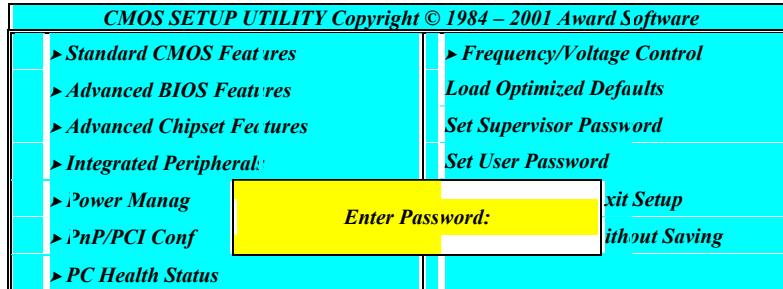

---

Now you can enter your password, after entering the password the menu will pop up again and will ask you to reconfirm the password. After entering and pressing [enter] the password will be stored to CMOS RAM and the password will be enabled.

### Disabling the password

To disable the password, simply press [enter] without entering any other letters or numbers. This will disable the password, the BIOS will tell you by displaying the following dialog:

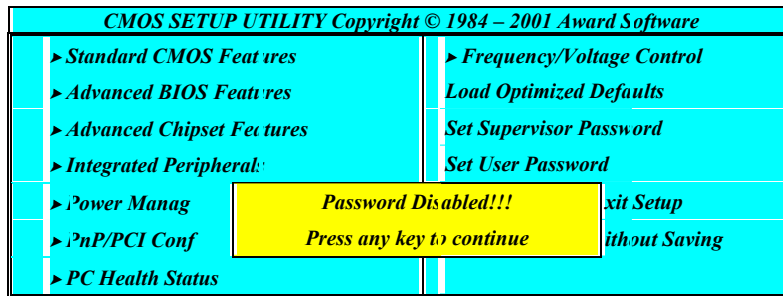

### Password Unknown

If you forgot the password, you can clear the password by erasing the CMOS RAM. The RAM data containing the password information is powered by the onboard button cell battery. Please refer to the CMOS RAM section earlier in this chapter. After clearing the CMOS memory, hold down <Delete> during bootup and enter BIOS setup to re-enter user preferences.

---

## Chapter 5 Appendix

### 5-1 Memory Map

Address range	Size	Description
00000-7FFFF	512K	Conventional memory
80000-9FBFF	127K	Extended conventional memory
9FC00-9FFFF	1K	Extended BIOS data area if PS/2 mouse is installed
A0000-C7FFF	160K	Available for hi DOS memory
C8000-DFFFF	96K	Available for hi DOS memory and adapter ROMs
E0000-EEFFF	60K	Available for UMB
EF000-EFFFF	4K	Video service routine for monochrome & CGA adapter
F0000-F7FFF	32K	BIOS CMOS setup utility
F8000-FCFFF	20K	BIOS runtime service routine (2)
FD000-FDFFF	4K	Plug and play ESCD data area
FE000-FFFFF	8K	BIOS runtime service routine (1)



---

## 5-2 I/O Map

000-01F	DMA controller (master)
020-021	Interrupt controller (master)
022-023	Chipset control registers. I/O ports
040-05F	Timer control registers
060-06F	Keyboard interface controller (8042)
070-07F	RTC ports & CMOS I/O ports
080-09F	DMA register
0A0-0BF	Interrupt controller (slave)
0C0-0DF	DMA controller (slave)
0F0-0FF	Math coprocessor
1F0-1FB	Hard disk controller
278-27F	Parallel port 2
2B0-2DF	Graphics adapter controller
2F8-2FF	Serial port 2
360-36F	Network ports
378-37F	Parallel port 1
3B0-3BF	Monochrome & parallel port adapter
3C0-3CF	EGA adapter
3D0-CDF	CGA adapter
3F0-3F7	Floppy disk controller
3F8-3FF	Serial port-1

---

## 5-3 Time & DMA Channels Map

### Time map:

Timer channel 0 system timer interrupt  
Timer channel 1 DRAM refresh request  
Timer channel 2 speaker tone generator

### DMA channels:

DMA channel 0 available  
DMA channel 1 onboard ECP (option)  
DMA channel 2 floppy disk (SMC chip)  
DMA channel 3 onboard ECP (default)  
DMA channel 4 cascade for DMA controller 1  
DMA channel 5 available  
DMA channel 6 available  
DMA channel 7 available

---

## 5-4 Interrupt Map

**NMI:** non-maskable interrupt

**IRQ(H/W):**

- 0 system timer interrupt from timer 0
- 1 keyboard output buffer full
- 2 cascade for IRQ 8-15
- 3 serial port2
- 4 serial port1
- 5 parallel port 2
- 6 floppy disk (SMC chip)
- 7 parallel port 1
- 8 RTC clock
- 9 available
- 10 available
- 11 available
- 12 PS/2 mouse
- 13 math coprocessor
- 14 onboard hard disk (IDE1) channel
- 15 onboard hard disk (IDE2) channel

---

## 5-5 RTC & CMOS RAM Map

RTC & CMOS :

00 seconds  
01 seconds alarm  
02 minutes  
03 minutes alarm  
04 hours  
05 hours alarm  
06 day of week  
07 day of month  
08 month  
09 year  
0a status register a  
0b status register b  
0c status register c  
0d status register d  
0e diagnostic status byte  
0f shutdown byte  
10 floppy disk drive type byte  
12 hard disk type byte  
13 reserve  
14 equipment type  
15 base memory low byte  
16 base memory high byte  
17 extension memory low byte  
18 extension memory high byte  
19-2d  
2e-2f  
30 Reserved for extension memory low byte  
31 reserved for extension memory high byte  
32 date century byte  
33 information flag  
34-3f reserve  
40-7f reserved for chipset setting data

---

## 5-6 ISA I/O Address Map

I/O Address (HEX)	I/O device
000 - 01F	DMA Controller 1, 8237A-5
020 - 03F	Interrupt Controller 1, 8259A
040 - 05F	System Timer, 8254-2
060 - 06F	8042 Keyboard Controller
070 - 07F	real-time Clock/CMOS and NMI Mask
080 - 09F	DMA Page Register, 74LS612
0A0 - 0BF	Interrupt Controller 2, 8259A
0C0 - 0DF	DMA Controller 2, 8237A-5
0F0 - 0FF	i486 Math Coprocessor
1F0 - 1F8	Fixed Disk Drive Adapter
200 - 207	Game I/O
20C - 20D	Reserved
21F	Reserved
278 - 27F	Parallel Printer Port 2
2B0 - 2DF	Alternate Enhanced Graphic Adapter
2E1	GPIB Adapter 0
2E2 - 2E3	Data Acquisition Adapter 0
2F8 - 2FF	Serial Port 2 (RS-232-C)
300 - 31F	Prototype Card
360 - 363	PC Network (Low Address)
364 - 367	Reserved
368 - 36B	PC Network (High Address)
36C - 36F	Reserved
378 - 37F	Parallel Printer Port 1
380 - 38F	SDLC, Bisynchronous 2
3B0 - 3BF	Monochrome Display and Printer Adapter

---

<b>I/O Address (HEX)</b>	<b>I/O device</b>
390 - 393	Cluster
3A0 - 3AF	Bisynchronous 1
3C0 - 3CF	Enhanced Graphics Adapter
3D0 - 3DF	Color/Graphics Monitor Adapter
3F0 - 3F7	Diskette Drive Controller
3F8 - 3FF	Serial Port 1 (RS-232-C)
6E2 - 6E3	Data Acquisition Adapter 1
790 - 793	Cluster Adapter 1
AE2 - AE3	Data Acquisition Adapter 2
B90 - B93	Cluster Adapter 2
EE2 - EE3	Data Acquisition Adapter 3
1390 - 1393	Cluster Adapter 3
22E1	GPIB Adapter 1
2390 - 2393	Cluster Adapter 4
42E1	GPIB Adapter 2
62E1	GPIB Adapter 3
82E1	GPIB Adapter 4
A2E1	GPIB Adapter 5
C2E1	GPIB Adapter 6
E2E1	GPIB Adapter 7

---

## Chapter 6 Q & A

### 6-1 Errors Messages During Power On Self Test

During **power on self test (post)**, BIOS will automatically detect the system devices. Below is the question that users most often meet. The user may press “**Esc**” key to skip the full memory test.

**1. Beep sound**

On power on, the system make beep sound to offer different messages. If the system is configured correctly, it prompts a short beep to show device configuration is done correctly. When VGA card and DIMM modules are not plugged well, the system makes longer and constant beep sounds.

**2. BIOS ROM checksum error**

It indicates the checksum of the BIOS code is not right and system will always halt on power on screen. Contact the dealer to exchange a new BIOS.

**3. CMOS battery fails**

It indicates the CMOS battery does not work. Contact the dealer to exchange a new battery.

**4. CMOS checksum error**

It indicates the CMOS checksum is incorrect. Load the default values in BIOS to solve this problem. This error may result from a weak BIOS, so exchange a new BIOS if necessary.

**5. Hard disk initialize**

**Please wait a moment...**

Some hard drives require more time to initialize.

---

**6. *Hard disk install failure***

The system can not find or initialize the hard drive controller or the drive. Check if the controller is set correctly. If no hard disk is installed, “**Hard drive selection**” must be set to “**none.**”

**7. *Keyboard error or no keyboard present***

This means the system can not initialize the keyboard. Check if the keyboard is plugged well and be sure no keys are pressed during power on self test.

**8. *Memory test fails***

There will be more information to specify the type and location of the memory error.

**9. *Primary master hard disk fail***

The BIOS find an error in the primary master hard disk drive.

**10. *Primary slave hard disk fail***

The BIOS finds an error in the primary slave hard disk drive.

**11. *Secondary master hard disk fail***

The BIOS finds an error in the secondary slave master hard disk drive.

**12. *Secondary slave hard disk fail***

The BIOS finds an error in the secondary slave IDE hard disk drive.