

P4A845D
(INTEL i845D Chipset, S-478)
With DDR 200/ 266 Memory
For Pentium[®] 4 400MHz FSB PC System
Main Board
User's Manual
(Ver.:1.0)

Copyright

Copyright©2001 by this company. No part of this document may be reproduced, transmitted, transcribed, stored in a retrievable system, or translated into any natural or computer language, in any form or by any means without prior written permission. This manual and the information contained here are protected by copyright. All rights reserved.

Copyright 2001. All Rights Reserved.

Revision History

Revision	Date	Release Notes
1.0	Dec.-2001	First Official Release

Warning and disclaimer

This manual is designed to provide information about the Pentium®4 main-board. Effort have been made to make this manual as accurate as possible, but no warranty or fitness is implied. All the information is provided on an 'as is' basis. The author and his corresponding publishing company shall have neither liability nor responsibility to any person or entity with respect to any loss or damages arising from the information contained in this manual or from the use of the system board that accompanies it.

Information contained in this manual is subject to change without notice. The manufacturer of the system board will not be held responsible for technical or editorial omissions made herein, nor for the incidental or consequential damages resulting from its furnishing, performance, functionality or use. Subsequent changes to this manual will be incorporated into the next edition. We welcome any suggestion regarding this manual or our computer products.

Trademarks

- Intel® and Pentium® are registered trademarks of Intel® Corporation.
- IBM® is a registered trademark of International Business Machines Corporation.
- Microsoft® is a registered trademark of Microsoft® Corporation.
- PCI® is a registered trademark of PCI® Special Interest Groups.
- AWARD® is a registered trademark of Award Software Inc.

All other trademarks are the property of their respective owners.

Table of Contents

Chapter 1	Introduction.....	1
1-1	Main Specifications.....	2
1-2	System Configuration.....	4
1-3	Notice of Hardware Installation.....	5
Chapter 2	Installation.....	6
2-1	Component Locations	6
2-2	Layout Reference.....	7
2-3	Jumper Setting.....	8
2-3-1	JP2/ JP7: USB Wake Up Function	8
2-3-2	JP3: Keyboard Wake Up Function.....	9
2-4	CPU Installation.....	10
2-4-1	CPU and System Cooling.....	13
2-5	Connectors.....	14
2-5-1	Front Panel.....	14
2-5-2	Back Panel Connectors.....	16
2-5-3	Power Supply Connector.....	18
2-5-4	Floppy Disk Connector.....	19
2-5-5	IDE1 and IDE2.....	20
2-5-6	Internal Audio Connecotrs.....	21
2-5-7	WOL1:WakeUp On LAN (Optional).....	22
2-6	Memory.....	23
2-6-1	Memory Installation.....	24
Chapter 3	Software Installation.....	25
3-1	Notice of Driver Installation.....	25
3-2	How to Install Software Drivers.....	26

Chapter 4	The BIOS.....	27
4-1	Updating the BIOS.....	28
4-2	The CMOS Memory.....	29
4-3	The BIOS Setup Pages.....	31
4-3-1	Standard CMOS Setup.....	34
4-3-2	BIOS Features Setup.....	38
4-3-3	Chipset Features Setup.....	42
4-3-4	Integrated Peripherals.....	45
4-3-5	Power Management Setup.....	50
4-3-6	PNP/PCI Configuration Setup.....	53
4-3-7	PC Health Status.....	55
4-3-8	Frequency/Voltage Control.....	56
4-3-9	Passwords Setting.....	57
Chapter 5	Appendix.....	59
5-1	Memory Map.....	59
5-2	I/O Map.....	60
5-3	Time & DMA Channels Map.....	61
5-4	Interrupt Map.....	62
5-5	RTC & CMOS RAM Map.....	63
5-6	ISA I/O Address Map.....	64
Chapter 6	Q & A.....	66

Important Warnings:



WARNING: NEVER run the processor without the heatsink properly and firmly attached. This will damage the processor within SECONDS. Also do NOT try to use Pentium Heatsinks, these will NOT fit and do NOT provide adequate cooling.



WARNING: Make sure your power supply can deliver the power your system needs. We recommend AT LEAST a 250W power supply. Even better, get a 300W power supply, especially when using many peripherals.

Chapter 1 Introduction

Thank you for purchasing this high quality motherboard, we are confident that you will be able to use this motherboard to your full satisfaction. This manual is divided into 6 main sections, as described below:

Introduction

The introduction contains information on the main specifications for this motherboard, the package contents and cautionary notes.

Hardware Installation

The Hardware Installation section is the most important in the manual. It describes in detail how to set the motherboard up for operation. Read all information and follow all steps, especially if you are a new user.

Software Installation

The software section describes the drivers that need be installed to make your OS operates properly. The drivers are provided on the driver CD.

BIOS Setup

Information on how to enter the BIOS setup and change settings is given here. In addition all individual BIOS items are described. Although some BIOS setting information is given in the hardware installation section where appropriate, refer to the BIOS Setup Section for details.

Appendix

Provides useful information

Q & A

1-1 Main Specifications

- **PCB board size and form factor: 24.0cm x 30.5cm, ATX type.**

- **PCB layer: 4 layers**

- **Supported CPUs**

Can support the latest 400MHz system bus Socket-478 Intel P4 CPUs up to 2GHz or higher speed!

- **Intel i845D Chipset (Called MCH)**

The Intel® i845D chipset consists of the following main components: Intel® Memory Controller Hub (MCH) and the Intel I/O Controller Hub 2 (ICH2). All these components are interconnected via and Intel proprietary interface called Hub Interface. The Hub Interface is designed into the Intel 845 Chipset to provide efficient communication between components.

Additional hardware platform features include AGP 4x mode, DDR200/ 266 System memory, Ultra ATA/100, and Universal Serial Bus (USB). The platform is also ACPI compliant and supports Full-on , Suspend to Disk, and Soft-off power management states.

- **Memory**

This motherboard comes equipped with two Double Data Rate (DDR) Memory Module sockets to support DDR 200MHz/ 266MHz-compliant (32, 64, 128, 256MB, or 512MB) DDR Modules up to 2GB.



Only supports DDR-200/ 266 memory.

- **AGP (Accelerated Graphics Port)**

Allows only AGP 2.0 including 4X AGP VGA cards. Do not install any graphics cards which have no support for AGP 4X into I845D based motherboards. Otherwise, the AGP slot of your motherboard will be irretrievably damaged because of the TOO HIGH VOLTAGE (AGP 2X - 3.3V, AGP 4X -1.5V)

- **PCI Expansion Slots**

With five 32-bit PCI (Rev. 2.2) expansion slots, which can support Bus Master PCI cards, such as LAN or Video-grabber cards (PCI supports up to 133MB/s maximum throughput), this motherboard is ready for the most demanding applications.

■ **CNR Slot**

A Communication Networking Riser (C.N.R.) slot can be fitted with CNR MODEM, or MODEM/ LAN 10/100M card.

■ **USB interface**

With support for up to 4 USB Ver. 1.1 ports, two on-board, this motherboard provides ample USB expansion room.

■ **IDE interface**

This motherboard comes with an onboard PCI Bus Master IDE controller with two connectors that support four ATA66/ 33 devices on two channels. Supports UDMA/66, UDMA/33, PIO Modes 3 & 4 and Bus Master IDE DMA Mode 2, and Enhanced IDE devices, such as CD-R/ RW, DVD-ROM, CD-ROM, Tape Backup and LS-120 drives. An IDE-3/4 RAID function is optional.

■ **Super Multi-I/O**

This functionality is integrated into the southbridge of the chipset. It provides two high-speed UART compatible serial ports and one parallel port with EPP and ECP capabilities.

■ **Infrared (IrDA) Connector**

This functionality is also integrated into the southbridge of the chipset. The IrDA connector supports an optional IR remote control device for wireless interfacing with external peripherals, personal gadgets, or an optional remote controller.

■ **System BIOS**

This motherboard comes with a 2MB BIOS that provides CPU/ SDRAM frequency, boot block write protection, and HD/ SCSI/ CD/ Floppy boot selection. DMI is also supported through BIOS, which allows hardware to communicate within a standard protocol creating a higher level of compatibility.

■ **Special Function**

- A. **Over 300W P4 type power supply is needed, meanwhile over 250W PIII type power supply is acceptable but not guaranteed for proper function.**
- B. **Provides CPU over-clocking up to 133MHz by BIOS setting but not guaranteed for this function. Vendor is not Responsible for any damage on CPU or main board due to the over-clocking failure (Jump cap to “2-3” of JP6 to reset BIOS if over-clocking fails).**
- C. **AC-97 Sound Codec chip provides “ amplifier“ function.**
- D. **Optional IDE 0/1 RAID function by using “PROMISE“ PDC 20265R chipset.**



Only 4X AGP is acceptable.

1-2 System Configurations

Below is the i845 chipset based system configuration:

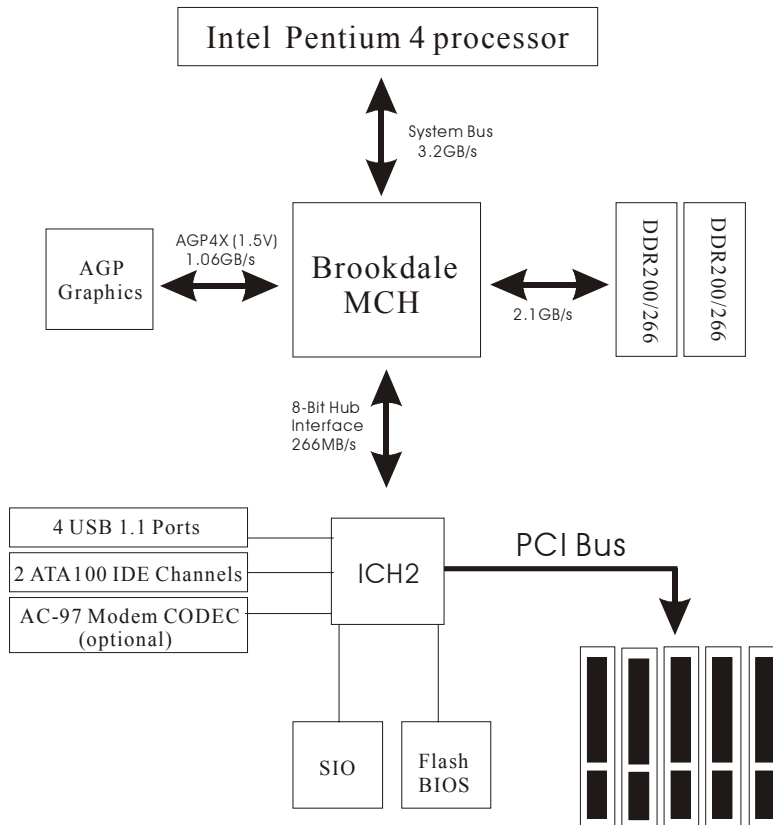

1-3 Notice of Hardware Installation

Before hardware installation, make sure you have checked the following things.

A. Check the package

If any of these items is missing or damaged, contact the dealer from whom you purchase. Leave this main board in its original package until you are ready to install it. In the package, there are:

➤ This motherboard



➤ 1 Manual



➤ 1 Driver Installation CD-ROM



➤ 1 IDE ATA 66/100 Flat-Cable



➤ 1 Floppy Disk Drive Flat-Cable



B. Make sure power is off.

During hardware installation, be sure that there is no power connected during this period.

C. Avoid ESD (Electrical Static Discharge.)

While installing the main board, wear a grounded wristband or ankle strap to avoid ESD (Electrical Static Discharge).

Chapter 2 Installation

2-1 Component Locations

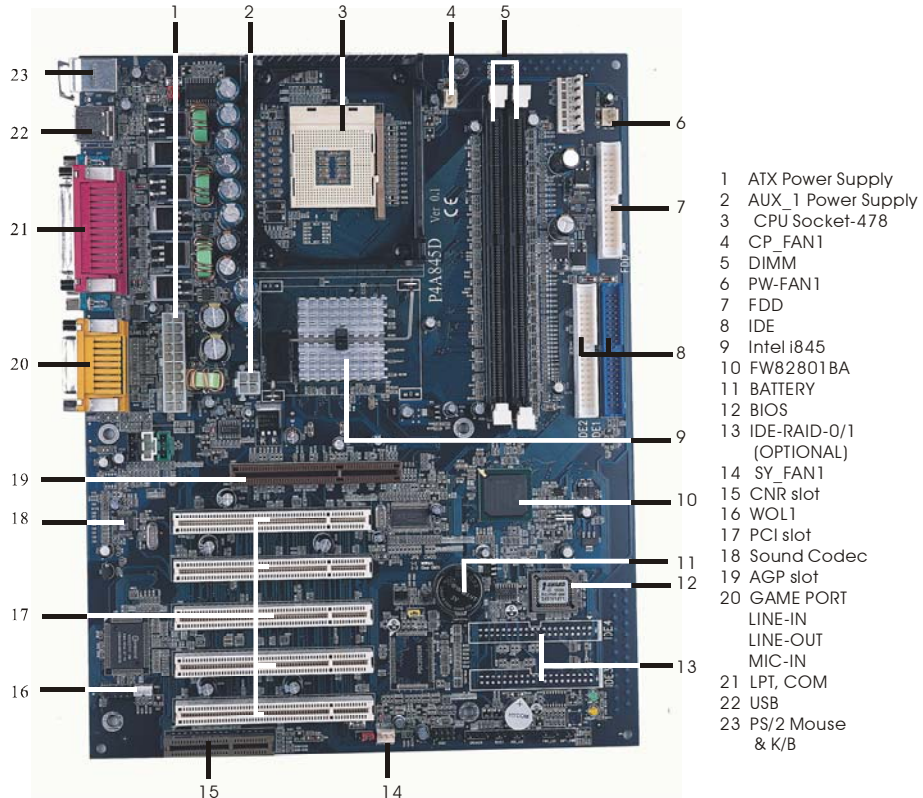

2-2 Layout Reference

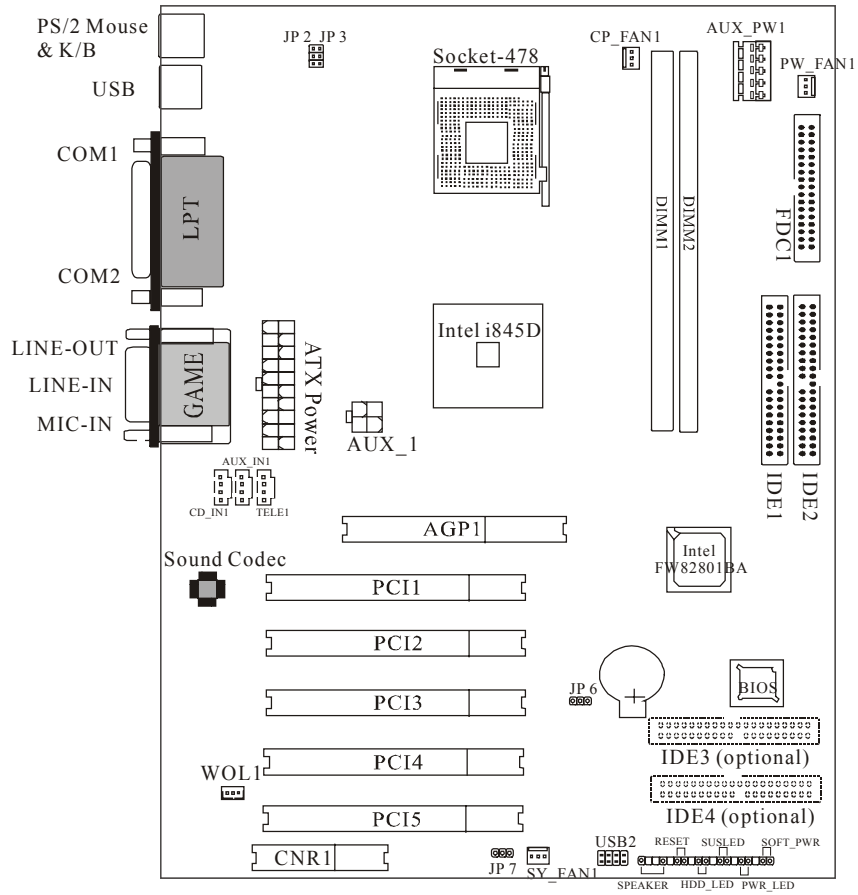

2-3 Jumper Setting

There is no Hardware jumper setting needed when install CPU, meanwhile user needs to set correct "CPU clock ration" under "Frequency/ Voltage Control" in the BIOS, e.g. the ratio for 1.5G CPU is "x15", 20G CPU is "x20"...(Please refer to page 58).

2-3-1 JP2/ JP7: USB Wake Up Function

JP2/ JP7 are 3-pin selector which provides USB wake up function. Set "1-2" to disable and set "2-3" to enable USB wake up function.

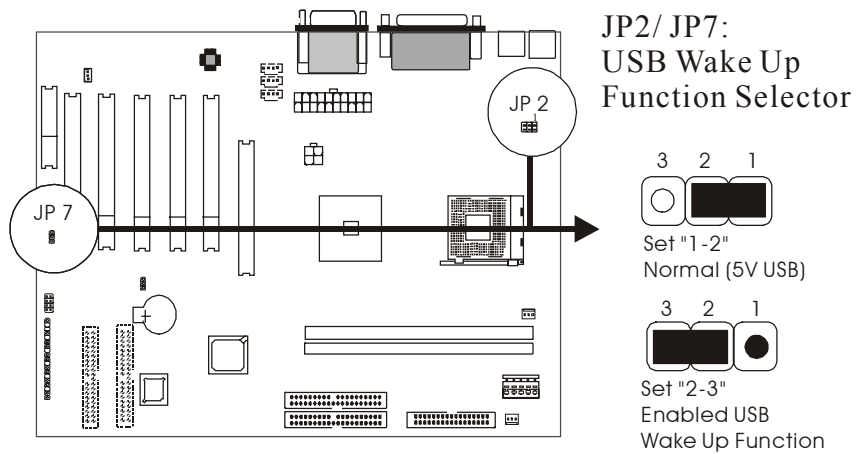

2-3-2 JP3: Keyboard Wake Up Function

JP3 is a 3-pin selector that provides keyboard wake up function. Set "1-2" to disable and set "2-3" to enable keyboard wake up function.

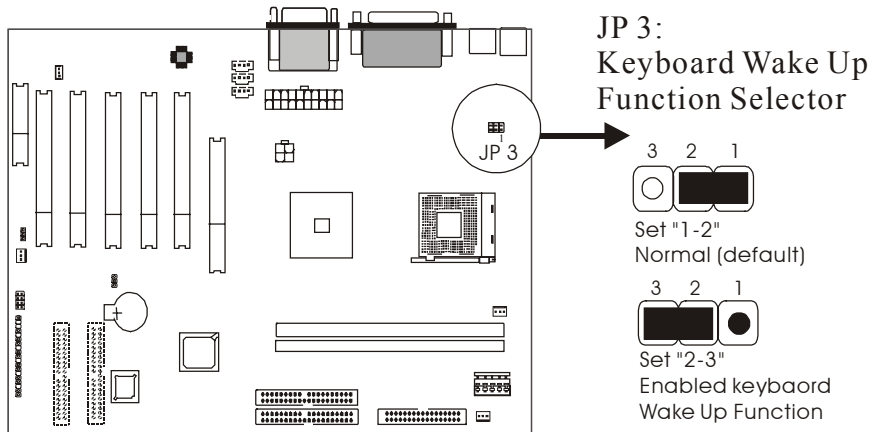

2-4 CPU Installation

The first step in the installation of your CPU is the insertion of the CPU into the 478 pins CPU socket. Please follow the steps as outlined below carefully to avoid damage to the CPU.

Avoid Static Electricity

The Intel P4 processors and your motherboard contain sensitive electronic components that can be easily damaged by static electricity. We recommend that you leave the processor in its original packaging until you are ready to install it. You should only touch the edges of the processor, NEVER touch the processor pins to avoid static discharge.

First take a moment to inspect your CPU for obvious damage due to shipping or handling. Be sure that no noticeable damage exists before proceeding. You should have the following items:

- 1 Intel P4 processor.
- 1 good heatsink and fan assembly.

Step 1

The following figure shows the processor socket. Note that the release lever on the right side of the socket is down and latched. This position is used to lock the processor in place. The lever must be raised to install the processor. To do this, first push the lever sideways to unlatch it, then raise it all the way up (approximately 90 degrees).



Step 2

The processor pin array at the top two corners is angled and has no pins in the corners. Notice that at the top of the socket on the motherboard (near where it says "Socket 478") the corners also do not have positions for pins. The processor must be positioned so the pins match up properly. When you do that, the corner of processor that is cut off will be positioned next to the release pivot.

It should take no force to install the processor, this is a zero insertion force (ZIF) socket. If it takes any force you are doing something wrong. Check the pin alignment and also make sure the release lever is raised up completely.

After placing the CPU lower the release lever to lock the processor in place.



Now with the processor properly installed, you can proceed to install the heatsink. It is important to note that if you have never installed a heatsink on an Intel PIII or Celeron processor before it may be difficult. We recommend you do a dry run a few times before doing the final installation. To allow you to do this read the following instructions. Do not remove the film on the thermally conductive compound until you are ready to do the final installation.



WARNING: Never run the processor without the heatsink properly and firmly attached.

Step3

The picture below shows the bottom of the heatsink. Notice the step in the heatsink surface, this portion fits over the top of the socket, where the legend "Socket 478" is molded into the plastic. The heatsink must be mounted with this step above the top of the socket or the heatsink will not be touching the processor properly.



The next picture shows the removal of the plastic film from the thermally conductive compound. The thermal compound is a thin layer of material that increases the efficiency of the heatsink by filling microscopic surface voids in the processor or heatsink surface with a thermally conductive material. Please do not remove the plastic film until you have practiced installing the heatsink and mounting the clips on the socket. It can take a few tries to get used to doing this.



The following picture shows a side view of the heatsink with the retaining clip at the bottom of the heatsink. Make sure this retaining clip is at the bottom of the heatsink before trying to install it.



The following picture shows the non-moveable end of the heatsink retaining clip installed on the lug at the bottom of the processor socket. This end of the clip simply slides over the lug when you tilt the heatsink / fan assembly towards the lug.

Now lock the locking clip for the retaining strap over the lug at the other (pivot end) of the processor socket. This is an easy procedure after you do it a few times, but initially it will require you to use a finger on one hand to push the latch down and use your other hand to push the latch in. This is the part you need to practice to install the clip properly. When you are holding the heatsink, make sure you do apply pressure to the fan. You could damage it and cause thermal failure of the processor.



WARNING: Be careful not to scrape the motherboard during the mounting of the fan or else damage may occur to the motherboard.

Now connect the wire from the heatsink fan to the CP_FAN1 connector on the motherboard. This connector is keyed and can only be installed one way. If you use a heatsink assembly that has two cooling fans, connect one to CP_FAN and the other PW_FAN1. For more information on the FAN connectors, refer to the FAN connector section later in this section.

2-4-1 CPU and System Cooling

Any attempt to operate the Intel P4 Processor without a suitable cooling solution will result in permanent damage to the processor and potentially other components within the system.

FAN Headers

Your motherboard allows the use of in all 3 FANs. Of these 3 FANs, 1 can be used by the CPU Heatsink assembly. The other 2 FAN Headers allow connection of a Chassis Fan and a Power Supply FAN respectively. For a the location of the FAN connectors, refer to the following picture:

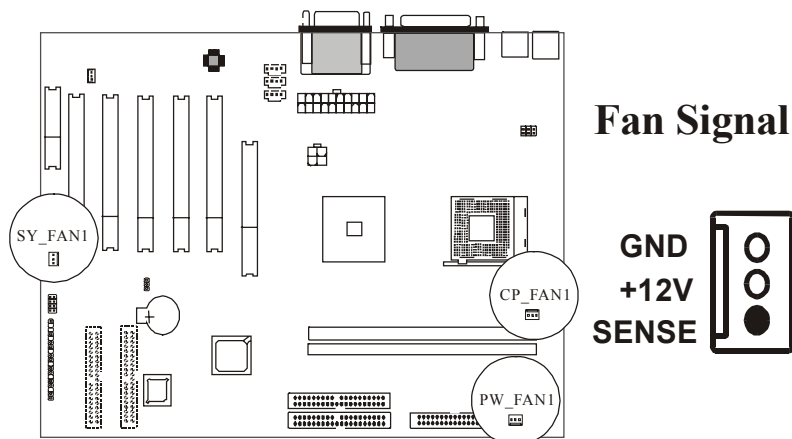

 **No jumper is needed for CPU installation. But need to set “CPU clock ration“ under Frequency/ Voltage Control in BIOS, e.g. 1.5G is “x15”, 1.7G is “x17”.....**

2-5 Connectors

There are many connectors on this main board. Refer to the following pages for details.

2-5-1 Front Panel

Front panel has connectors as “SPEAKER,” “RESET,” “HDD_LED,” “SUSLED,” “PWR_LED,” “SOFT-PWR.” Please refer the details as below.

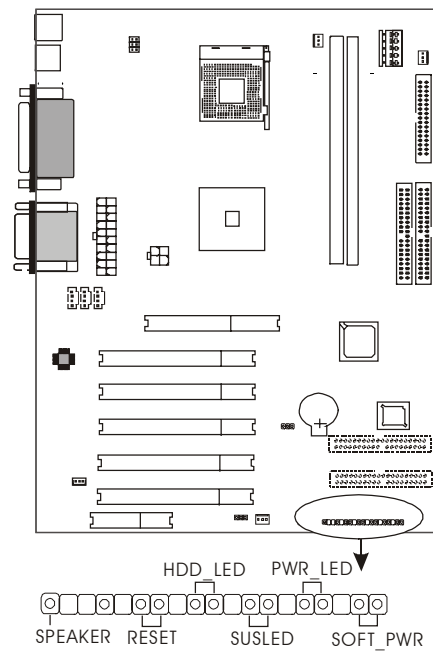

SPEAKER is a 4-pin keyed Berg strip. This speaker connector is for the internal case speaker. This speaker will enable the BIOS to give spoken messages in case of boot up trouble. The BIOS beep codes also use this speaker. For Games and Music this speaker will not be used, but rather the back panel line-out connector.

RESET connector is a 2-pin keyed Berg strip, connected to the push button reset switch on the case front panel. Shorting both pin 1 & pin 2 can reset the system, which is similar to the power off and then on again.

HDD-LED (Hard Disk activity LED connector) is a 2-pin keyed Berg strip. It is used to connect to front panel Hard Disk LED. This LED will light up whenever one of your IDE devices is being accessed.

PWR-LED is a 3-pin connector. It is used to connect to the LED on the case front panel. The LED shows the status of the power.

SOFT_PWR with a 2-pin Berg strip on case front panel indicates the current power status of system. It is used to connect to the Power Button on the front panel of the case (if there is).

2-5-2 Back Panel Connectors

There are PS/2 keyboard/ mouse, USB, COM1/2, LPT1, MIC, LINE-IN, LINE-OUT and GAME Ports on case back panel. Please refer to more details as below.

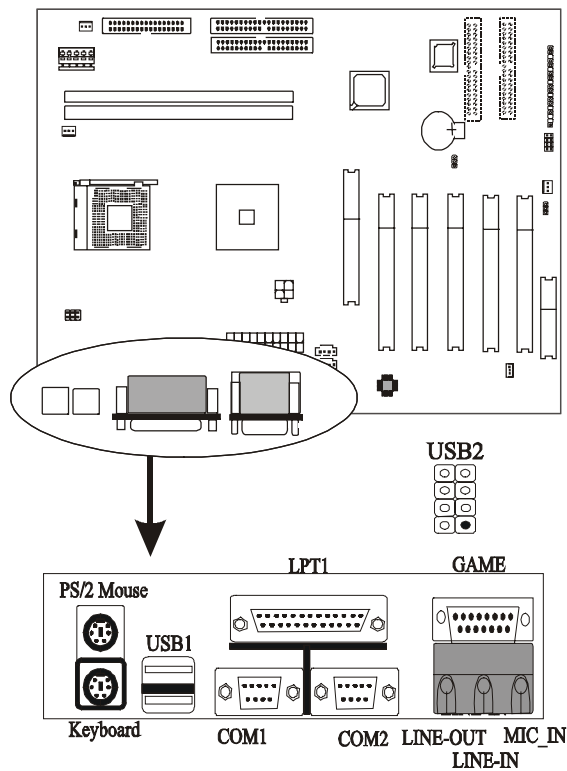

COM1/COM2

The onboard serial port 1 and port 2 are the 9-pin D-subminiature male connector **COM1 and COM2**. COM1 and COM2 can be disabled in BIOS setup. Please refer to Chapter 3 “Integrated Peripherals” for more information.

PS2 Keyboard/ Mouse

The Keyboard can be plugged in in only one way. Please do not force the connector in, it may get damaged by use of excessive force. It is easy to make the mistake of reversing the PS/2 keyboard and mouse connectors. If your keyboard does not work, check this first. The keyboard must be inserted into the lower connector.

The Mouse can be plugged in in only one way, too. Please do not force the connector in, it may get damaged by use of excessive force.

LPT

The onboard parallel port is a 25-pin female connector. It supports standard printer port, Enhanced Parallel Port (EPP), Extended Capabilities Port (ECP), Standard Parallel Port (SPP).

USB:USB (Universal Serial Bus) Connector

Universal Serial Bus connector, marked as “USB,” is used to connect USB devices. There are 2 USB connectors on this main board.

Midi/Game Port & External Audio Connectors

Midi/Game port has 15 pins connecting to the game joystick. External Audio connectors are “LINE-OUT, LINE-IN, MIC-IN ” for audio functions.

2-5-3 Power Supply Connector

This main board needs P4 power supply which contains ATX, AUX_1 & AUX_PW1 3 power connectors, *ATX power supply connector* has 20 pins, which is especially designed for ATX case. **AUX_1 power supply connector** has 4 pins. The ATX power supply supports the function of the “**Soft Power On Momentary switch**” which connects the front panel switch to the 2-pin **SOFT-PWR** on the system board. While the power switch on the back of ATX power is turned on, the full power will not go into the system board until the front panel switch is momentarily pressed. Push the switch again to turn off the power to the system board.

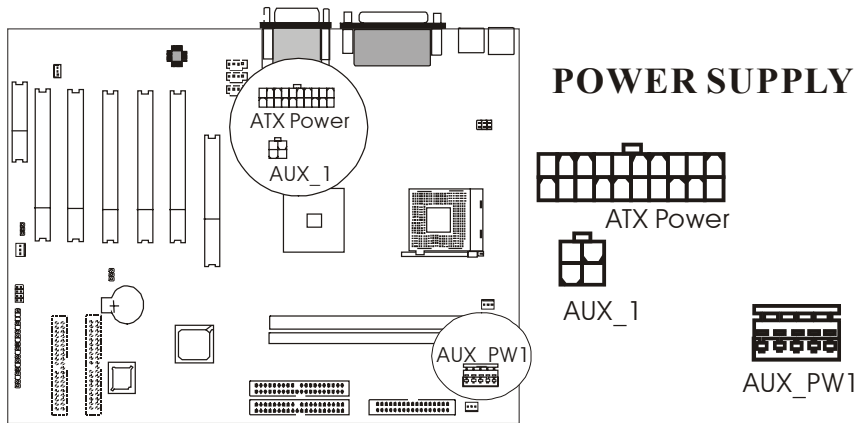

2-5-4 Floppy Disk Connector

Floppy Disk Connector has 34 pins and allows connection of a floppy drive. In all two floppy drives can be connected to the mother board, known as floppy A and B. The BIOS allows you to disable the floppy controller if you do not use any floppy driver, that will free an Interrupt. The BIOS also allows swapping of floppy A and B although this will not be useful to most users.

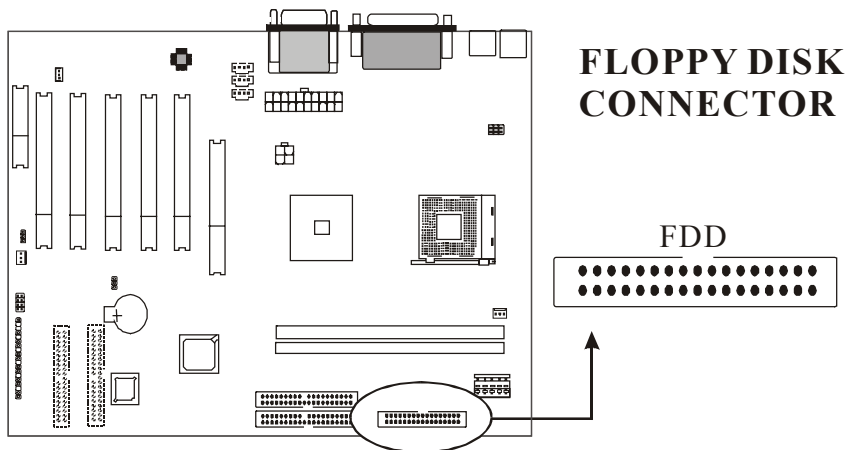

2-5-5 IDE1 and IDE2

The IDE connectors are used to connect IDE devices such as Harddisks and CD-ROM drives to the motherboard. Each connector constitutes an IDE channel, each channel accepts 2 IDE devices, one Master and one Slave. The IDE 1 connector is also known as the primary channel, IDE 2 is the secondary channel. Therefore the primary Master is the IDE device connected to IDE1 as Master, the primary Slave is the IDE device connected to IDE 1 as Slave. Jumpers on the IDE device determine Master and Slave settings. Your harddisk or CD-ROM should have a sticker with jumper settings. Make sure that you set these jumpers correct. Please use the following advice as reference:

- If you have only device connected to an IDE connector, always set it as Master.
- If you have one HDD and CD-ROM in your system, then connect the HDD to IDE1 as Master, and the CD-ROM to IDE 2 as Master
- If you have one Harddisk and one CD-ROM connected to the same IDE connector set the HDD to Master and the CD-RAM to Slave.

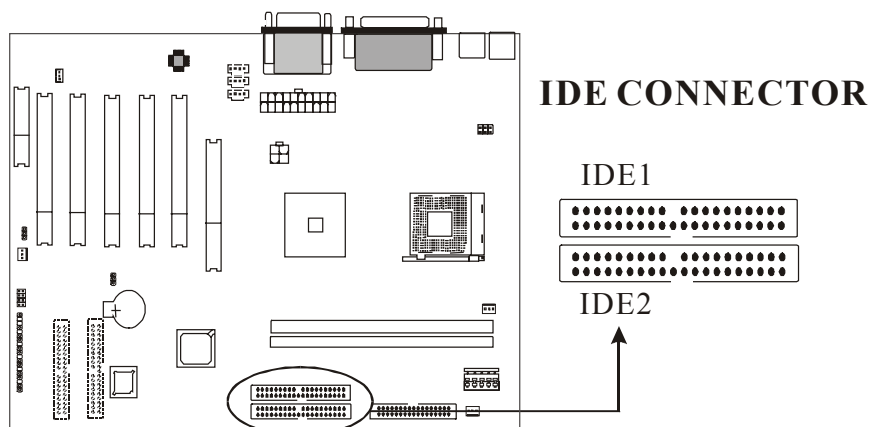

2-5-6 Internal Audio Connectors

Internal Audio Connectors is “CD_IN”, it is a CD ROM external audio input signal to line-out (speaker) of the main board.

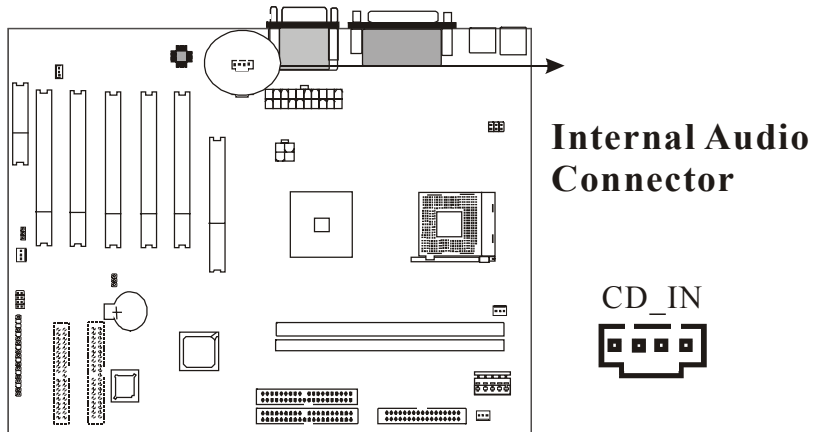

2-5-7 WOL1: Wake up on LAN (Optional)

Wake up on LAN marked as “WOL1,” is a 3-pin connector. To support this feature, a network card is required for the system and network management software must be installed, too.

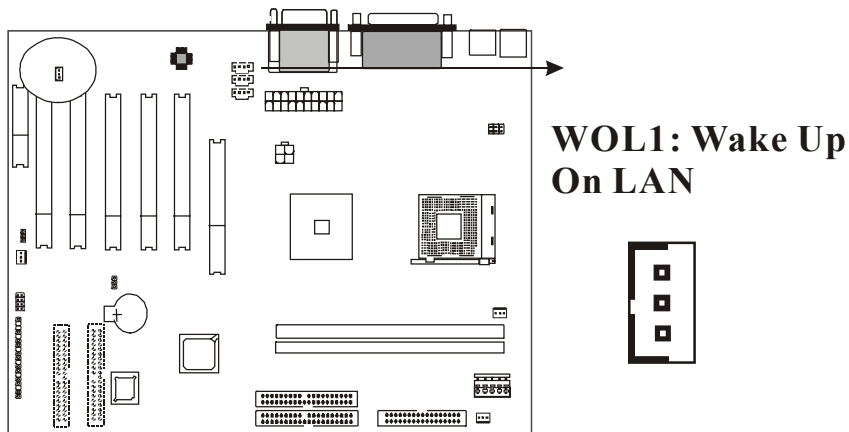

 **WOL1 (Wake up on LAN) function requirement:**
Power supply should be able to offer at least 1A current driving ability to the signal “5V trickle voltage.”

2-6 Memory

This motherboard supports only Dual Inline Memory Modules (DIMMs). Two sockets are available for 2.5 Volt unbuttered DDR (Double Data Rate). The sizes that are supported are: 32, 64, 128, 256, or 512MB memory sizes between 64MB to 512MB can be formed this way. Refer to the picture below for the position of the DIMM slots:

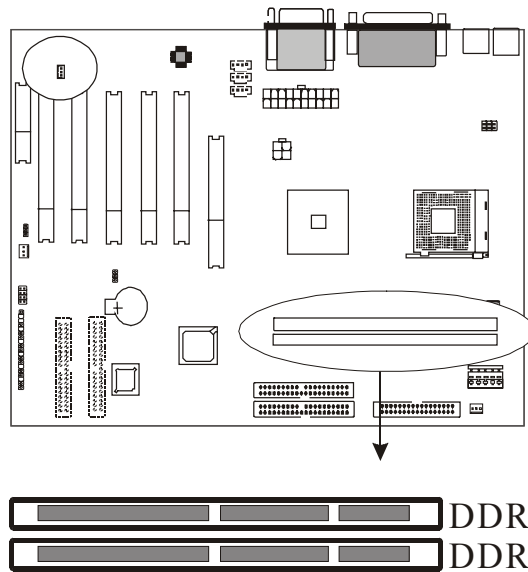

Memory speed is controlled through the BIOS, on the Advanced Chipset Features Setup page. you will find several items related to DDR speed. Refer to the BIOS section for more details.

 ***Only DDR (double data rate) memory is acceptable for this mainboard, PC-100/ 133 not acceptable.***



WARNING:

- DIMM modules that have more than 18 chips are not supported on this motherboard. (Due to signal integrity)
- If the system CPU bus operates at 100MHz/133MHz, use only PC200-/PC266-compliant DIMMs. (System won't boot otherwise)

2-6-1 Memory Installation

The DIMM modules can be inserted in DIMM slots 1 to 2. Because of the two notches in the DIMM module it can be inserted in only one way. Please refer to the picture below for information on how to insert the DIMM modules.

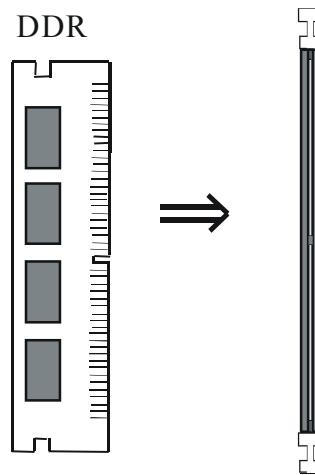

WARNING:

Make sure that you unplug your power supply when adding or removing memory modules or other system components. Failure to do so may cause severe damage to both your motherboard and expansion cards

Chapter3 Software Install

3-1 Notice of CD Driver Installation

This CD contains below drivers. The user must read “Index” before installing required drivers. Index offers all the information on all the drivers.

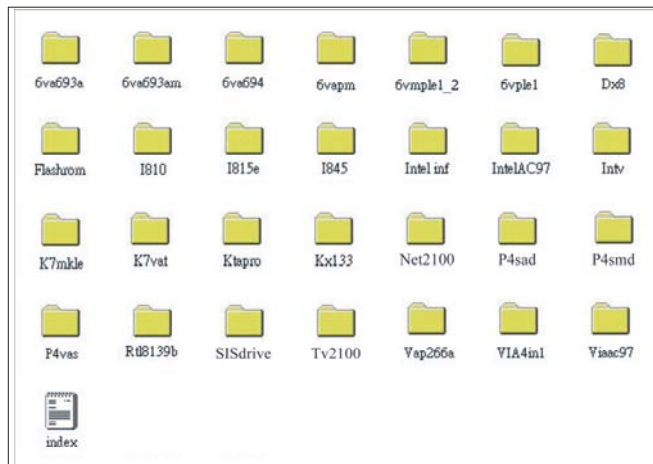

CD driver is always updated with the latest version, so the actual CD content may be somewhat different from the above picture.

1. **Main boards:** 6va693a, 6va693am, 6va694, 6vapm, 6vmp1e1_2, 6vple1, I810, I815e, I845, Intv, K7mkle, K7vat, Ktapro, Kx133, Net2100, P4sad, P4smd, P4vas, Tv2100, Vap266a (**please select I845 directory for this main board**)
2. **DX8:** Windows DirectX8 driver.
3. **Flashrom:** BIOS flash upgrade utility .

3-2 How to Install Software Driver

Installation Procedure:

1. Setup 1: Install 845 INF (Path: root: \ Intel inf\ Setup.exe)

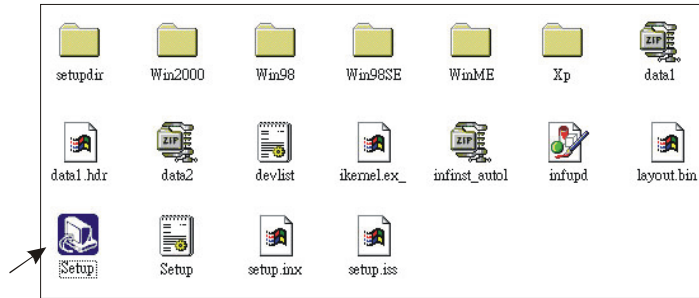

2. Setup3: Install Sound Driver

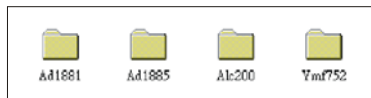

For Windows95: (Path: root: \ IntelAC97\ Alc\ Win95\ Setup.exe)

For Windows98: (Path: root: \ IntelAC97\ Alc\ Win98\ Setup.exe)

For Windows2000: (Path: root: \ IntelAC97\ Alc\ Win2000\ Setup.exe)

For WindowsNT: (Path: root: \ IntelAC97\ Alc\ Winnt\ Setup.exe)

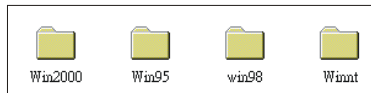

Chapter4 The BIOS

The BIOS is a piece of software (Basic Input Output System) that performs most low level tasks. When you start up your system, the BIOS is the first code that gets to run. The BIOS resides in a FLASH ROM, and the code in the FLASH ROM can be updated through a special utility called AWDFLASH. (Award Flash). This is generally not necessary, but in some cases updating the BIOS is necessary to support new devices that were not on the market at the time the motherboard was released. For the physical location of the BIOS FLASH ROM IC on your motherboard, refer to the picture below:

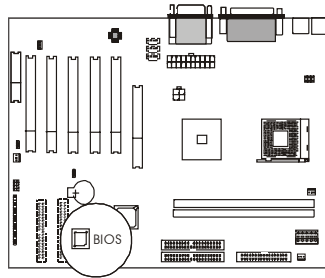

The BIOS IC is inserted in an IC socket, which means that it can be removed and exchanged for another IC if necessary.

Is updating my BIOS necessary?

As a general rule if your system is functioning properly and you are not an experienced user, do not try to update the BIOS. Only if you have specific problems that a BIOS update may solve may it be advisable to update the BIOS.

The update process is pretty complex, and you should bear in mind that if updating the BIOS goes wrong you may render your system unbootable. Therefore, do not update unless you know what you are doing.

Finding the latest official BIOS revision

For the latest official BIOS revision, please go to our website at www.lucky-star.com.tw. On the support page you can find the latest BIOS files for our motherboards.

4-1 Updating the BIOS

As said, this procedure is complicated, only update your BIOS when you experience

problems with your system. Because each BIOS release completely overwrites the previous version and there is no need to update to intermediate BIOS releases when updating the BIOS. Therefore always use the latest BIOS revision when doing a BIOS update. The BIOS update procedure is as follows:

- In order to flash update the BIOS, you will need 2 files:
 - The BIOS binary file (.bin file from the website)
 - AWDFLASH.EXE utility file. (This utility can be downloaded from our website)
- Create a directory on your C harddisk drive: and name it FLASH
- Put the BIOS .bin file and the AWDFLASH utility in the FLASH directory.
You may want to jot the BIOS .bin file name down on a piece of paper.
- Restart the computer, press DEL to go into the BIOS, then please disable the following:
 - System BIOS Cacheable (in Advanced Chipset Features)
 - Video BIOS Shadow (in Advanced BIOS Features)Save the changes by selecting 'save and exit', and restart the computer.
- Press Ctrl + F5 just before Windows is starting up (right after the second BIOS screen) for a DOS boot, you will see the message "Windows is bypassing all your startup files". You end up at a DOS prompt.
- Now type `cd FLASH` to change to the newly created directory.
- Here type `AWDFLASH mybios.bin /py /cc /sn /cd`, where mybios.bin is the file name for the BIOS binary file you want your BIOS to upgrade to. Now the upgrading will begin.



WARNING:

Do NOT in any way disturb the system during upgrading. If for any reason the system is stalled your system may not be able to boot again.

- After the upgrading has ended press F1 to reset, press DEL to go into BIOS and make the following changes:
 - Load Setup Defaults.
 - Go into the Frequency/Voltage Control page to adjust your CPU speed and voltage (please make sure the CPU voltage matches your CPU specs, in case of doubts leave it to 'default').Save your settings and you are done.

4-2 The CMOS memory

The BIOS uses the CMOS memory to store all the settings that have been made through the BIOS Setup pages.

Battery

The CMOS memory remembers all settings, even when the system is switched off, by use of a 3V Lithium battery. If this battery runs low CMOS is unable to keep its settings and you will need to replace the battery. The BIOS will give you an error message when it detects a low battery voltage. The error message 'CMOS checksum error' may also point to a low battery problem.

Restoring default settings

You can load default values into the CMOS memory by selecting 'Load Optimized Defaults' in the BIOS Setup. If you need to force the CMOS settings to default without entering the BIOS Setup page you can use the JP6 jumper. For the location of the jumper and the battery, refer to the following picture:

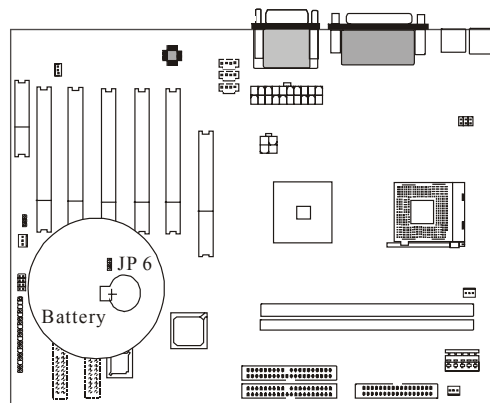



Normally JP6 will be in the 1-2 position, this will connect the battery to the southbridge of the chipset which contains the CMOS memory. If JP6 is temporarily set to 2-3 this will interrupt the battery electricity flow, and the CMOS memory will be erased, this will however only work if the power supply is not switched on. Now at the next reboot the BIOS will automatically load the CMOS default values.

Take the following steps to clear CMOS memory:

- Take the power cord from the power supply.
- Temporarily set JP6 to 2 – 3, and set it back to 1 – 2.
- Put the power cord back and restart the system, the default values will be loaded.

CMOS Status

JP6	Retain CMOS settings	Clear CMOS Settings
CMOS	 1 2 3	 1 2 3

The following part of this chapter will describe the individual BIOS Setup pages and all the items that can be adjusted to fine tune your system.

4-3 The BIOS Setup Pages

To enter the BIOS Setup pages, thke the following steps:

- Start up the system.
- After memory counting has finished, press [DEL] to enter the BIOS Setup pages.

Now the following menu will appear:

<i>CMOS SETUP UTILITY Copyright © 1984 – 2001 Award Software</i>	
<i>▶ Standard CMOS Features</i>	<i>▶ Frequency/Voltage Control</i>
<i>▶ Advanced BIOS Features</i>	<i>Load Optimized Defaults</i>
<i>▶ Advanced Chipset Features</i>	<i>Set Supervisor Password</i>
<i>▶ Integrated Peripheral:</i>	<i>Set User Password</i>
<i>▶ Power Management Setup</i>	<i>Save & Exit Setup</i>
<i>▶ PnP/PCI Configurations</i>	<i>Exit Without Saving</i>
<i>▶ PC Health Status</i>	
<i>Esc : Quit</i>	<i>F9: Menu in BIOS</i>
<i>F10 : Save & Exit Setup</i>	<i>↑↓→← : Select Item</i>
<i>Time, Date, Hard Disk Type . . .</i>	

Selecting items

To Select items, use the following method:

- Use the arrow keys to move between items and select fields.
- Press [enter] to enter the selected submenu.

Submenus

All items that start with a ▶ are submenus. Pressing [enter] when a submenu is selected will enter that submenu.

Modifying selected items

The [Up]/[Down] keys can be used to modify values within the selected fields. Note that some fields also let you enter values directly.

Hot Keys

Throughout the BIOS Setup Pages the hot keys will give you access to a group of commands. Refer to the following table for the hot keys and their function:

Key	Command	Description
F10	Save & Exit Setup	Saves the changes made and reboots the system.
[Esc]	Quit	Returns to the previous menu
F1	Help	General Help
F2	Help	Help for specific item
F5	Previous values	Restores the previous values. These are the values that the user started the current session with.
F7	Optimized Defaults	Loads all options with the Optimized Default values.

Save & Exit Setup

When you select the [SAVE & EXIT SETUP] option from the Main Menu, all changes that you made will be saved to the CMOS memory and the setup utility will exit, rebooting your system.

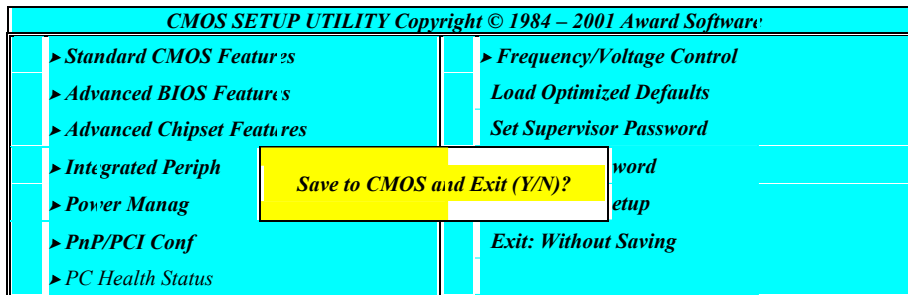

Pressing [Y] and [enter] will save the changes, pressing [N] and [enter] will keep the old settings.

Exit Without Saving

Selecting 'Exit Without Saving' will exit Setup without saving changes to CMOS.

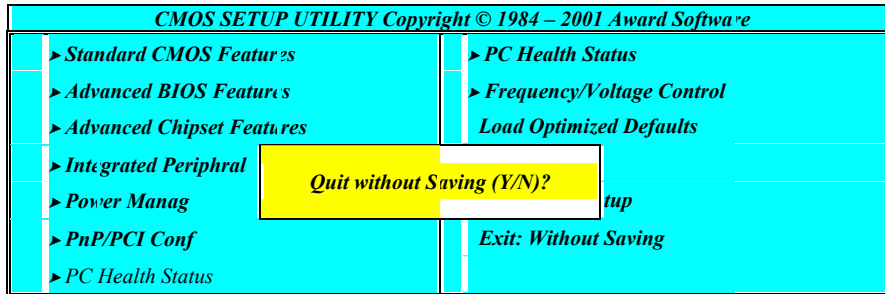

Pressing [Y] and [enter] will Exit without saving, pressing [N] and [enter] will not Exit.

4-3-1 Standard CMOS Setup

Select the [STANDARD CMOS SETUP] option from the Main Menu and press [Enter] key.

CMOS SETUP UTILITY Copyright © 1984 – 2001 Award Software		
Standard CMOS Features		
Date (mm:dd:yy)	Mon, Aug 18, 2001	Item Help
Time (hh:mm:ss)	11 : 51 : 58	
▶ IDE Primary Master	Press Enter None	Menu Level ▶
▶ IDE Primary Slave	Press Enter None	
▶ IDE Secondary Master	Press Enter None	Change the day, month, year and Century
▶ IDE Secondary Slave	Press Enter None	
Drive A	1.44M, 3.5 in.	
Drive B	None	
Video	EGA / VGA	
Halt On	All, But Keyboard	
Base Memory:	640K	
Extended Memory:	31744K	
Total Memory:	32768K	
↑ ↓ → ← : Move Enter: Select + / - / PU / PD: value F10: save ESC: Exit F1: General Help F5: Previous Values F6: Fail-Safe Defaults F7: Optimized Defaults		

This screen allows you to change the basic CMOS Settings such as date and time, harddisk type etc. After you have made the changes you need to make press [ESC] to return to the main menu.

Date and Time

	Default	Possible Settings	Notes
Date	Weekday, month, day, year	Type the current date. (weekday auto changes)	Using the P-Up / P-Dn keys to toggle is possible
Time	hh:mm:ss	Type the current time	24-hour clock for mat. (15:15:00 = 3:15:00)

IDE Devices

When you select one of the IDE devices, a submenu will pop up. Refer to the picture below.

<i>CMOS SETUP UTILITY Copyright © 1984 – 2001 Award Software</i>		
<i>IDE xxx</i>		
<i>IDE HDD Auto Detection</i>	<i>Press Enter</i>	<i>Item Help</i>
<i>IDE Primary Master</i>	<i>Auto</i>	<i>Menu Level >></i>
<i>Access Mode</i>	<i>Auto</i>	<i>To auto-detect the HDD's size, head... on this channel</i>
<i>Capacity</i>	<i>0 MB</i>	
<i>Cylinder</i>	<i>0</i>	
<i>Head</i>	<i>0</i>	
<i>Precomp</i>	<i>0</i>	
<i>Landing Zone</i>	<i>0</i>	
<i>Sector</i>	<i>0</i>	

This Menu is the same for all 4 IDE devices:

- Primary Master IDE 1 first device
- Primary Slave IDE 1 second device
- Secondary Master IDE 2 first device
- Secondary Slave IDE 2 second device

	Values	Meaning
<i>IDE HDD Auto Detection</i>	Press Enter	Pressing Enter will make the BIOS auto detect the IDE device on this channel. The result will be displayed below, starting with the 'capacity' item. (These items are read only)
<i>IDE xxx</i>	Auto	This will auto detect the device at each boot up.
	Manual	This will use the setting set by the user. No auto detection at start up will take place.
	None	This setting means no device is present. This will prevent the BIOS from looking for a device and speed up booting.
<i>Access Mode</i>	CHS	Selects the CHS access mode.
	LBA	Logical Block Addressing, for HDD drives larger than 504MB (All modern HDDs)
	Large	For very large HDDs.
	Auto	The BIOS will automatically detect the best access mode.

Drive A and Drive B

The Drive A / B items allow you select the type of device that you have attached to the Floppy (FDD1) connector on the motherboard. You can select between different floppy disk drive types by using the Page-Up and Page-Down keys. If you press [enter] while Drive A or B is selected the following menu will pop up that will allow to choose a device as well:

<i>Drive X</i>		
<i>None</i>	...	<input type="checkbox"/>
<i>360K, 5.25 in.</i>	...	<input type="checkbox"/>
<i>1.2M, 5.25 in.</i>	...	<input type="checkbox"/>
<i>720K, 3.5 in.</i>	...	<input type="checkbox"/>
<i>1.44M, 3.5 in.</i>	...	<input checked="" type="checkbox"/>
<i>2.88M, 3.5 in.</i>	...	<input type="checkbox"/>
<i>↑↓: Move Enter:Accept ESC: Abort</i>		

Video

The Video item allows you to select a video mode. Since most modes are outdated we advise you to always select EGA/VGA. You can select between different video modes by using the Page-Up and Page-Down keys. If you press [enter] a menu pops up.

(Mono is for a monochrome screen that can only display one color)

<i>Video</i>		
<i>EGA/VGA</i>	...	<input checked="" type="checkbox"/>
<i>CGA 40</i>	...	<input type="checkbox"/>
<i>CGA 80</i>	...	<input type="checkbox"/>
<i>MONO</i>	...	<input type="checkbox"/>
<i>↑↓: Move Enter:Accept ESC: Abort</i>		

Halt On

The BIOS will stop booting when an error is detected. You can set through this item what errors will stop the system booting. You can select between different error modes by using the Page-Up and Page-Down keys.

	Values	Meaning
	All Errors	Stop booting on all errors.
	No Errors	Always Boot, no matter what error is detected.
	ALL, BUT KEYBOARD	Stop booting on all errors, but not on a keyboard error.
<i>Halt On</i>	All, but diskette	Stop booting on all errors, but a diskette error.
	All, but disk/key	Stop booting on all errors, but keyboard and diskette errors.

4-3-2 BIOS Features Setup

Select the [Advanced BIOS Features] option from the Main Menu and press [Enter] key.

CMOS SETUP UTILITY Copyright © 1984 – 2001 Award Software Advanced BIOS Features		
		Item Help
Virus Warning	Disabled	
CPU L1 & L2 Cache	Enabled	
Quick Power On Self Test	Enabled	Menu Level ▶
First Boot Device	Floppy	Allows you to choose the VIRUS warning
Second Boot Device	HDD 0	feature for IDE Hard Disk boot sector
Third Boot Device	LS 120	protection. If this function is enabled and
Boot Other Device	Enabled	someone attempt to write data into this area,
Swap Floppy Drive	Disabled	BIOS will show a warning message on
Boot Up Floppy Seek	Disabled	screen and clarm beep.
Boot Up NumLock Status	On	
Gate A20 Option	Fast	
Typematic Rate Setting	Disabled	
X Typematic Rate (Chars/Sec)	6	
X Typematic Delay (Msec)	250	
Security Option	Setup	
OS Select For DRAM > 64 MB	Non-OS2	
Report No FDD For WIN 95	No	
Small Logo (EPA) Show	Enabled	
↑↓ → ← : Move Enter: Select + / - /PU / PD: value F10: save ESC: Exit F1: General Help F5 : Previous Values F6: Fail-Safe Defaults F7: Optimized Defaults		

Virus protection

	Values	Meaning
<i>Virus Warning</i>	Enabled	The BIOS will give a beep and a warning whenever an attempt is made to write to the boot sector of the HDD.
	Disabled	The BIOS will allow write attempts to the boot sector

CPU Cache settings

	Values	Meaning
<i>CPU L1 & L2 Cache</i>	Disabled	
	Enabled	

Quick Power On Self Test

	Values	Meaning
<i>Quick Power On Self Test</i>	Enabled	The BIOS will execute test routines that test most parts of the motherboard during boot up.
	Disabled	The BIOS will skip the tests, speeding up the boot process. Errors will on the other hand not be detected.

Floppy Drive Settings

	Values	Meaning
<i>Swap Floppy Drive</i>	Enabled	This will swap floppy A and B. Most systems not even have 2 floppy drives, so this item is irrelevant .
	Disabled	Floppy A and B are not swapped
<i>Boot-up Floppy Seek</i>	Enabled	The BIOS will test whether the floppy has 40 or 80 tracks during boot up. All new floppy drives are 80 tracks.
	Disabled	The BIOS will not test the amount of tracks.

Boot Devices

The first to third boot device items allow you to select what device the system should boot from. If the BIOS fails to boot from the first boot device, it will attempt to boot from the second boot device, if that fails too, the third boot device is tried. If you set the *boot other device* item to enabled, the BIOS will try to boot from other devices if the first to third choices all fail. If you set this item to disabled, the BIOS will not boot if the first to third devices all fail to boot.

	Values	Meaning
<i>First ~ Third boot device</i>	Floppy	The system attempt to boot from diskette. (first boot device default)
	LS 120	The system will attempt to boot from an attached LS 120 drive. (Third boot device default)
	HDD 0	The system will attempt to boot from the first HDD. (Second boot device default)
	SCSI	The system will attempt to boot from the first device attached to the first SCSI interface.
	CD-ROM	The system will attempt to boot from the first CD-ROM found.
	HDD1	The system will attempt to boot from the second HDD.
	HDD2	The system will attempt to boot from the third HDD.
	HDD3	The system will attempt to boot from the fourth HDD.
	ZIP100	The system will attempt to boot from an attached ZIP 100 drive
	LAN	The system will attempt to boot over the network. You will require a LAN card with boot BIOS for this option to function.
Disabled	This disables booting from this device.	

Keyboard Typematic Rate and Delay Settings

If you set the *typematic rate setting* item to disabled, the system will use the defaults of 6 and 250 for the rate and delay items. If you set it to enabled you can select the values yourself. Refer to the table below:

	Values	Meaning
<i>Typematic Rate</i>	6 ~ 30	This value sets the amount of time a character is repeated per second if it is kept down on the keyboard. Choose from the following values: 6, 8, 10, 12, 15, 20, 24, 30.
<i>Typematic Delay</i>	250 ~ 1000	This value sets the amount of time in ms before a character starts repeating after it was pressed on the keyboard. Choose from 250, 500, 750 and 1000 ms.

Security Option

The security option item allows you to select when the password needs to be entered. Refer to the table below:

	Values	Meaning
<i>Security Option</i>	Setup	Password must be entered only when the user wants to enter the BIOS setup.
	System	The password must always be entered at boot.

OS Select for DRAM > 64MB

	Values	Meaning
<i>OS select for DRAM > 64MB</i>	Non-OS2	If your OS is not OS2, always select this setting.
	OS2	Select this setting only if your OS is OS2

Report No FDD For WIN 95

	Values	Meaning
Report No FDD For WIN 95	Yes	
	No	

4-3-3 Chipset Features Setup

Select the [Advanced BIOS Features] option from the Main Menu and press [Enter] key.

<i>CMOS SETUP UTILITY Copyright © 1984 – 2001 Award Software</i>		
<i>Advanced BIOS Features</i>		
<i>DRAM Timing Selectable</i>		<i>Item Help</i>
<i>CAS Latency Time</i>	<i>1.5</i>	
<i>Active to Precharge Delay</i>	<i>7</i>	<i>Menu Level ▶</i>
<i>DRAM RAS# to CAS# Delay</i>	<i>3</i>	
<i>DRAM RAS# Precharge Time</i>	<i>3</i>	
<i>DRAM Data Integrity Mode</i>	<i>Non-ECC</i>	
<i>Memory Frequency For</i>		
<i>Dram Read Thermal Mgmt</i>	<i>Disabled</i>	
<i>System BIOS Cacheable</i>	<i>Enabled</i>	
<i>Video BIOS Cacheable</i>	<i>Disabled</i>	
<i>Video RAM Cacheable</i>	<i>Disabled</i>	
<i>Memory Hold At 15M-16M</i>	<i>Disabled</i>	
<i>Delayed Transaction</i>	<i>Enabled</i>	
<i>Delay Prior to Thermal</i>	<i>16Min</i>	
<i>AGP Aperture Size (MB)</i>	<i>64</i>	
<i>AGP Fast Write</i>	<i>Enabled</i>	
<i>Flash BIOS Use GPIO 23</i>	<i>Disabled</i>	
↑↓→←: Move Enter: Select +/- /PU / PD: value F10: save ESC: Exit F1: General Help F5: Previous Values F6: Fail-Safe Defaults F7: Optimized Defaults		

DRAM Timing

If the DRAM Timing by SPD item is set to Enabled, the three items below will automatically be set by the BIOS. To do this the BIOS will read information out of the SPD EPROM that is located on the DIMM module, this information will tell the BIOS how to best access the memory. If you set this item to disabled, you can set the memory access items yourself. A word of warning though, if you are not familiar with DRAM settings does NOT make any changes (for the sake of system stability). Refer to the table below for the meaning of the individual DRAM items:

	Values	Meaning
DRAM Timing Selectable	Normal	
	By SPD	
CAS Latency Time	1.5	
	2	
	2.5	
	3	
DRAM RAS# to CAS# Delay	2	These controls the DRAM page miss and row miss lead off timing.
	3	
DRAM RAS Precharge Time	2	SDRAM precharge time by RAS.
	3	
DRAM Data Integrity Mode	Non-ECC	
	ECC	

BIOS Cacheable

	Value	Meaning
System BIOS Cacheable	Enabled	Define whether system BIOS area cacheable or not.
	Disabled	
Video BIOS Cacheable	Enabled	To define whether video BIOS area cacheable or not.
	Disabled	

Memory Hole

Some old devices need a memory hole to be present between 15M and 16M. CPU Cycles matching the hole will be passed on to the PCI bus instead of accessing the memory. Normally you can disable this setting, but if one of your devices needs it set it to enabled.

	Values	Meaning
<i>Memory Hole at 15M-16M</i>	Disabled	There is no memory hole.
	Enabled	A memory hole exists between 15 and 16MB.

Delay Transaction

	Values	Meaning
Delay Transaction	Enabled	
	Disabled	

AGPAperture Size (MB)

	Values	Meaning
On-Chip Video Window Size	4, 8, 16, 32, 64, 128, 256	

4-3-4 Integrated Peripherals

Select the [Integrated Peripherals] option from the Main Menu and press [Enter] key.

<i>CMOS SETUP UTILITY Copyright © 1984 – 2001 Award Software</i>		
<i>Integrated Peripherals</i>		
<i>Onchip Primary PCI IDE</i>	<i>Enabled</i>	<i>Item Help</i>
<i>IDE Primary Master PIO</i>	<i>Auto</i>	
<i>IDE Primary Slave PIO</i>	<i>Auto</i>	
<i>IDE Primary Master UDMA</i>	<i>Auto</i>	
<i>IDE Primary Slave UDMA</i>	<i>Auto</i>	<i>Menu Level ▶</i>
<i>Onchip Secondary PCIIDE</i>	<i>Enabled</i>	
<i>IDE Secondary Master PIO</i>	<i>Auto</i>	
<i>IDE Secondary Slave PIO</i>	<i>Auto</i>	
<i>IDE Secondary Master UDMA</i>	<i>Auto</i>	
<i>IDE Secondary Slave UDMA</i>	<i>Auto</i>	
<i>USB Controller</i>	<i>Enabled</i>	
<i>USB Keyboard Support</i>	<i>Disabled</i>	
<i>USB Mouse Support</i>	<i>Disabled</i>	
<i>AC97 Audio</i>	<i>Auto</i>	
<i>AC97 Modem</i>	<i>Auto</i>	
<i>Init Display First</i>	<i>AGP</i>	
<i>Onboard Audio</i>	<i>Enabled</i>	
<i>IDE HDD Block Mode</i>	<i>Enabled</i>	
<i>POWER ON Function</i>	<i>BUTTON ONLY</i>	
<i>KB Power ON Password</i>	<i>Enter</i>	
<i>Hot Key Power ON</i>	<i>Ctrl-F1</i>	
<i>Onboard FDD Controller</i>	<i>Enabled</i>	
<i>Onboard Serial Port 1</i>	<i>Auto</i>	
<i>Onboard Serial Port 2</i>	<i>Auto</i>	
<i>UART Mode Select</i>	<i>Normal</i>	
<i>RxD, TxD Active</i>	<i>Hi, Lo</i>	
<i>IR Transmission Delay</i>	<i>Enabled</i>	
<i>UR2 Duplex Mode</i>	<i>Half</i>	
<i>Use IR Pins</i>	<i>IR-Rx2Tx2</i>	
<i>Onboard Parallel Port</i>	<i>378/IRQ7</i>	
<i>Parallel Port Mode</i>	<i>SPP</i>	
<i>EPP Mode Select</i>	<i>EPP1.7</i>	
<i>ECP Mode Select</i>	<i>3</i>	
<i>PWRON After PWR-Fail</i>	<i>Off</i>	
<i>Game Port Address</i>	<i>201</i>	
<i>Midi Port Address</i>	<i>330</i>	

Midi Port IR	10
↑↓→←: Move Enter: Select +/-/PU/PD: value F10: save ESC: Exit F1: General Help F5: Previous Values F6: Fail-Safe Defaults F7: Optimized Defaults	

The screen is not as long on your monitor. You can use the arrow keys to scroll up and down the page.

IDE Channel Settings

The following table explains IDE channel settings and what they mean:

	Values	Meaning
Onchip Primary PCI IDE	Enabled	Enables the use of the first (primary) IDE channel.
	Disabled	This will disable the use of the first (primary) IDE channel.
Onchip Secondary PCI IDE	Enabled	Enables the use of the secondary IDE channel.
	Disabled	This will disable the use of the secondary IDE channel.
xxx PIO	Auto	The BIOS will assign a PIO mode to this device automatically when appropriate
	Mode 0	Select a PIO Mode here. PIO mode 0 is slowest, PIO mode 4 is fastest, check your HDD to see what PIO mode it supports. If your IDE device supports UDMA mode, then it best to enable that mode since it is considerably faster than PIO mode. (Set to auto for auto-detection)
	Mode 1	
	Mode 2	
	Mode 3	
Mode 4		
xxx - UDMA	Auto	The BIOS will automatically use Ultra DMA Mode if the IDE device supports it.
	Disabled	This will disable the use of Ultra DMA for this device.
IDE HDD Block Mode	Enabled	Block mode allows faster transfer of data between the system and the HDD. Most modern HDDs support it.
	Disabled	Block Mode is not used.

USB Setting

	Values	Meaning
USB Controller	Enabled	This will allow use of a USB drive.
	Disabled	If you do not need a USB drive, set this item to disabled.
USB Keyboard Support	Enabled	This will allow use of a USB keyboard.
	Disabled	If you do not need a USB keyboard, set this item to disabled.
USB Mouse Support	Enabled	This will allow use of a USB mouse.
	Disabled	If you do not need a USB mouse, set this item to disabled.

Display Initialization

	Values	Meaning
<i>Inie Display First</i>	PCI Slot	The BIOS will first search for a VGA adapter on the PCI bus, if one is found it will be used as primary display.
	Onboard	The onboard AGP is first scanned.

Floppy Drive

	Values	Meaning
<i>Onboard FDD Controller</i>	Enabled	This will allow use of a floppy drive.
	Disabled	If you do not need a floppy drive, set this item to disabled.

AC97 Setting

	Values	Meaning
<i>AC97 Audio</i>	Enabled	This will allow use of a onboard AC97 sound codec.
	Disabled	If you do not need a onboard AC97 sound codec, set this item to disabled.
<i>AC97 Modem</i>	Enabled	
	Disabled	

Power On Function

	Values	Meaning
<i>Power On Function</i>	Any Key	Turn on power by click and key.
	Button Only	Only push power-on button.
	Keyboard 98	Click with multi-media keyboard power-on
	Password	Power-on after key-in password (Must key-in password first).
	Hot Key	Power-on by not key (must set hot-key first).
	Mouse Left	Power-on when mouse left key click
	Mouse Right	Power-on when mouse right key click.
<i>KB Power On Password</i>	Enter	
<i>Hot Key Power On</i>	Ctrl-F1~	
	Ctrl-F12	

COM ports (Serial Ports)

	Values	Meaning
<i>Onboard serial port 1 / 2</i>	Auto	The bios will automatically use serial ports.
	Disabled	If you do not need the serial port in question, set this item to disabled.
	3F8/IRQ4	Set an IO address and an IRQ to be used by serial ports.
	2F8/IRQ3	
	3E8/IRQ4	
2E8/IRQ3		

IR Control

	Values	Meaning
<i>UART Mode Select</i>	Normal	
	IrDA	Allows use of the IR port in IrDA mode.
	ASKIR	Allows use of the IR port in ASKIR mode.
	SCR	Allows use of the IR port in SCR mode.
<i>UR2 Duplex Mode</i>	Half	Select if your IR device supports Half duplex only.
	Full	For IR devices that support full duplex.

Parallel Port (Printer Port)

	Values	Meaning
<i>On board Parallel Port</i>	Disable	Disables use of the parallel port.
	3BC / IRQ7	Select an IO Address and an IRQ to be used by the parallel port.
	378 / IRQ7	
	278 / IRQ5	
<i>Parallel Port Mode</i>	SPP	Enables use of SPP devices.
	EPP	Enables use of EPP devices.
	ECP	Enables use of EPP devices.
	ECP + EPP	Enables use of ECP + EPP devices.
<i>ECP mode use DMA</i>	1 or 3	Select either DMA channel 1 or 3 (This is only relevant if ECP was selected above). Default is channel 3.

PWRON After PWR-Fail

	Values	Meaning
<i>PWRON After PWR-Fail</i>	Off	Default
	On	Power-on when power-fail
	Former-Sts	If before power-fail is power-on (off) then turn on (off) PC

MIDI

	Values	Meaning
<i>Midi Port Address</i>	300	Set mpu401 port address at 300.
	330	Set mpu401 port address at 330.
	Disabled	Without midi port or none AC97 m/b
<i>Midi Port IRQ</i>	5	Set mpu-40 port IRQ address at 5.
	10	Set mpu-40 port IRQ address at 5.

Game Port

	Values	Meaning
<i>Game Port</i>	201	Setting game port address at 201
	209	Setting game port address at 209.
	Disabled	Disabled game port.

4-3-5 Power Management Setup

Select the [Power Management Setup] option from the Main Menu and press [Enter] key.

CMOS SETUP UTILITY Copyright © 1984 – 2001 Award Software		
Power Management Setup		
ACPI Function	Enabled	Item Help
ACPI Suspend Type	S1 (POS)	Menu Level ▶
Power Management	User Define	
Video Off Method	DPMS	
Video Off In Suspend	Yes	
Suspend Type?	Stop Grati	
MODEM Use IRQ	3	
Suspend Mode	Disabled	
HDD Power Down	Disabled	
Soft-Off by FWRBTN	Instant-Off	
CPU THRM-Throttling	50.0%	
Power On by Ring	Enabled	
USB KB Wake-Up Form S3 (S4)	Disabled	
Resume by Alarm	Disabled	
X Date(Month) Alarm	0	
X Time(hh: mn: ss) Alarm	0 : 0 : 0	
** Reload Global Timer Events **		
Primary IDE 0	Disabled	
Primary IDE 1	Disabled	
Secondary IDE 0	Disabled	
Secondary IDE 1	Disabled	
FDD, COM, LPT Port	Disabled	
PCI IRQ[A-D]#	Disabled	
↑↓ → ← : Move Enter: Select PU / PD / + / - : value F10: save ESC: Exit F1: General Help F5 : Previous Values F6: Fail-Safe Defaults F7: Optimized Defaults		

The screen is not as long on your monitor. You can use the arrow keys to scroll up and down the page.

	Values	Meaning
<i>ACPI Function</i>	Enabled	
	Disabled	
<i>Power Management</i>	User Define	The three items below can be set by the user
	Min Saving	The three items below are set to: disabled, 1 hour, 1hour respectively.
	Max Saving	The three items below are set to: disabled, 1 min, 1min respectively.
<i>HDD Power Down</i>	1 – 15 Min	Will power down the HDD if it is idle for the amount of minutes selected here.
	Disabled	Will not power down the HDD.
<i>Suspend Mode</i>	1 Min to 1 Hour	Selecting a time will force the system into suspend mode after being idle for that time. Choose from the following time intervals: 1, 2, 4, 6, 8, 10, 20, 30, 40 min and 1 Hour
	Disabled	The system will never enter suspend mode.

Video Options

	Values	Meaning
<i>Video Off Method</i>	Blank Screen	The screen will be blank (black) only.
	V/H sync + blank	The vertical and horizontal sync pulses will be stopped, and the screen will be blank.
	DPMS support	If your monitor supports DPMS, it can be switched off through that.
<i>Video Off In Suspend</i>	Yes	
	No	
Suspend Type	Stop Grant	
	PwrOn Suspend	

Modem IRQ

	Values	Meaning
<i>Modem Use IRQ</i>	NA	This disables the modem IRQ
	3 - 11	Select an IRQ line that will be assigned to your modem here. Choose from: 3 (default), 4, 5, 7, 9, 10, 11.

Power Button

	Values	Meaning
<i>Soft off by power button</i>	Instant-off	Switches the system off immediately when pressing the power button.
	Delay 4 Sec	This requires you to press the power button for at least 4 seconds before the system switches off.

Wake Events

	Values	Meaning
<i>Wake-Up By PCI Card</i>	Enabled	Allow the system to wake up on a PCI card IRQ.
	Disabled	Will not allow the system to wake up on a IRQ form a PCI card.

Resume By Alarm

	Values	Meaning
<i>Resume By Alarm</i>	Enabled	You can set the date and time on RTC (real-time clock) alarm awaken a system which has been powered down.
	Disabled	Disabled this function.

Date Setting

	Values	Meaning
<i>Date (of Month) Alarm/ Time (HH:MM:SS)</i>		You can set the date (of month) and timer (hh:mm:ss), any event occurring will awaken a system which has been powered down.

IDE

	Values	Meaning
<i>Primary (Secondary) IDE 0/1</i>	Enabled	Enabled monitor Primary (Secondary) IDE 0/1 for Green event/
	Disablec	Disabled this function.

FDD, COM, LPT Port

	Values	Meaning
<i>FDD, COM, LPT Port</i>	Enabled	
	Disabled	

Wake Events

	Values	Meaning
<i>PCI PIRO</i>	Enabled	

{A-D}#	Disabled
--------	----------

4-3-6 PnP / PCI Configurations

Select the [PnP / PCI Configurations] option from the Main Menu and press [Enter] key.

CMOS SETUP UTILITY Copyright © 1984 – 2001 Award Software PnP / PCI Configurations		
Reset Configuration Data	Disabled	Item Help
Resources Controlled by	Auto (ESCD)	Menu Level ▶
X IRQ Resources	Press Enter	
PCI/VGA Palette snoop	Disabled	Default is Disabled. Select Enabled to reset Extended System Configuration Data ESCD> When you exit Setup if you have installed a new add-on and the system reconfiguration has Cause such a serious conflict that the OS cannot boot
↑↓→←: Move Enter: Select +/-/PU/PD: value F10: save ESC: Exit F1: General Help F5: Previous Values F6: Fail-Safe Defaults F7: Optimized Defaults		

Reset Configuration Data

	Values	Meaning
Reset Configuration Data	Disabled	This will not reset the system configuration data (IRQs, DMAs) on reboot.
	Enabled	This will reset the configuration data. Remember to enable this item every time you make a change to your system (such as switching PCI cards etc).

Resources Controlled by

	Values	Meaning
Resources Controlled By	Manual	The table will show the below items: “Reset Configuration Data, IRQ-3 assigned to, DMA-0 assigned to.” The user can adjust the shown items as required.
	Auto	The table will not show the above items, and the system will automatically assign the above setup.

Resources

If you set the Resources Controlled by item to Auto (ESCD), the BIOS will manage all resources for you. If you set it to manual to two items below will allow you to assign the resources manually.

	Values	Meaning
<i>IRQ-x</i> <i>assigned to</i> <i>(x = 3 to 15)</i>	PCI/ISA PnP	This setting means the BIOS will assign the interrupt as needed. This means that it is not fixed to a device
	Legacy ISA	If you need to make sure that a certain interrupt is assigned to an ISA device, set that interrupt to legacy ISA.
<i>DMA-x</i> <i>assigned to</i> <i>(x = 0, 1, 3,</i> <i>5, 6, 7)</i>	PCI/ISA PnP	This setting means the BIOS will assign the DMA Channel as needed, it is not fixed to a device
	Legacy ISA	If you need to make sure that a certain DMA channel is assigned to an ISA device, set that channel to legacy ISA.

PCI / VGA Palette Snoop

	Values	Meaning
<i>PCI / VGA</i> <i>Palette</i> <i>Snoop</i>	Disabled	Default setting.
	Enabled	This will allow the system to look at the palette the VGA uses to display. Some applications speed up with this setting but it is mostly obsolete.

4-3-7 PC Health Status

Select the [PC Health Status] option from the Main Menu and press [Enter] key.

CMOS SETUP UTILITY Copyright © 1984 – 2001 Award Software PC Health Status		
CPU Warning Temperature	Disabled	Item Help
Current System Temp.		
Current CPU1 Temperature		
Current CPUFAN1 Speed		Menu Level ▶
Current CPUFAN2 Speed		
Current CPUFAN3 Speed		
CPU (V)		
+ 3V		
+ 5V		
+ 12V		
- 12V		
- 5v		
VBAT (V)		
5VSB (V)		
Shutdown Temperature	Disabled	
↑ ↓ → ← : Move Enter: Select +/- / PU / PD: value F10: save ESC: Exit F1: General Help F5 : Previous Values F6:Fail-Safe Defaults F7: Optimized Defaults		

CPU Warning Temperature

	Values	Meaning
CPU Warning Temperature	Disabled	
	50°C/ 122°F, 53°C/ 127°F, 56°C/ 133°F, 60°C/ 140°F, 63°C/ 145°F, 66°C/ 151°F, 70°C/ 158°F,	

	Values	Meaning
Shutdown Temperature	Disabled	
	60°C/ 140°F, 65°C/ 149°F, 70°C/ 158°F, 75°C/ 167°F,	

4-3-8 Frequency/ Voltage Control

Select the [Frequency / Voltage Control] option from the Main Menu and press [Enter] key.

CMOS SETUP UTILITY Copyright © 1984 – 2001 Award Software Frequency / Voltage Control		
CPU Clock Ratio	12X	Item Help
Auto Detect PCI Clk	Enabled	
Spread Spectrum	Disabled	Menu Level ▶
CPU Clock	Default	
↑↓→←: Move Enter: Select +/- / PU / PD: value F10: save ESC: Exit F1: General Help F5 : Previous Values F6:Fail-Safe Defaults F7: Optimized Defaults		

CPU Clock Ratio

	Values	Meaning
CPU Clock Ratio	X8 ~ X23	

Auto Detect PCI Clk

	Values	Meaning
Auto Detect DIMM/ PCI Clk	Enabled	If set to enabled the BIOS will detect the values for the PCI clock.
	Disabled	If disabled, the BIOS will use the values set on this page and on the Advanced Chipset Features page.

Spread Spectrum

	Values	Meaning
Spread Spectrum	0.25%	
	0.50%	
	Disabled	

CPU Clock

	Values	Meaning
CPU Clock	Min = 100 Max = 132	

4-3-9 Passwords

The BIOS Setup program allows you to specify passwords in the Main menu. The passwords control access to the BIOS during system startup. The passwords are not case sensitive. In other words, it makes no difference whether you enter a password using upper or lowercase letters. The BIOS Setup program allows you to specify two separate passwords:

- Supervisor password
- User password.

The function of the supervisor password depends on the setting for the Security Option item on the Advanced BIOS Features page. If set to System, the supervisor password must be given every time the system boots, if set to setup, the password must be given only when you want to enter the BIOS Setup.

The user password has the same functionality, with the only difference that anybody logging in with the user password may only change the user password when entering the BIOS Setup page. All other items in the BIOS Setup will be disabled (unchangeable).

When both passwords are disabled, anyone may access all BIOS Setup program functions.

Setting the password

To set the Supervisor password, select the Set Supervisor Password item in the main BIOS Setup Menu. Now a dialog will pop up asking you to enter a password.

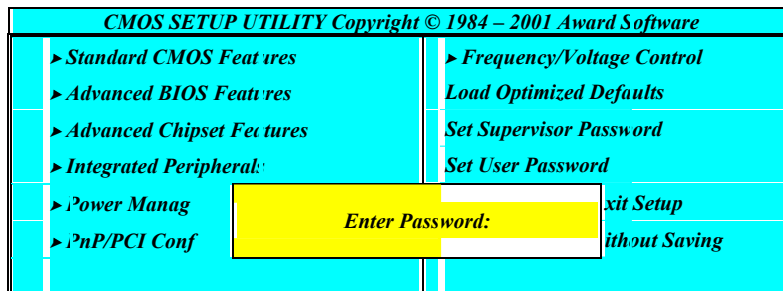

Now you can enter your password, after entering the password the menu will pop up again and will ask you to reconfirm the password. After entering and pressing [enter] the password will be stored to CMOS RAM and the password will be enabled.

Disabling the password

To disable the password, simply press [enter] without entering any other letters or numbers. This will disable the password, the BIOS will tell you by displaying the following dialog:

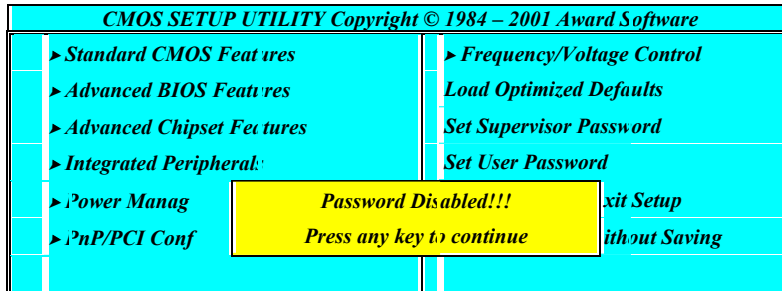

Password Unknown

If you forgot the password, you can clear the password by erasing the CMOS RAM. The RAM data containing the password information is powered by the onboard button cell battery. Please refer to the CMOS RAM section earlier in this chapter. After clearing the CMOS memory, hold down <Delete> during bootup and enter BIOS setup to re-enter user preferences.

Chapter 5 Appendix

5-1 Memory Map

Address range	Size	Description
00000-7FFFF	512K	Conventional memory
80000-9FBFF	127K	Extended conventional memory
9FC00-9FFFF	1K	Extended BIOS data area if PS/2 mouse is installed
A0000-C7FFF	160K	Available for hi DOS memory
C8000-DFFFF	96K	Available for hi DOS memory and adapter ROMs
E0000-EEFFF	60K	Available for UMB
EF000-EFFFF	4K	Video service routine for monochrome & CGA adapter
F0000-F7FFF	32K	BIOS CMOS setup utility
F8000-FCFFF	20K	BIOS runtime service routine (2)
FD000-FDFFF	4K	Plug and play ESCD data area
FE000-FFFFF	8K	BIOS runtime service routine (1)

5-2 I/O Map

000-01F	DMA controller (master)
020-021	Interrupt controller (master)
022-023	Chipset control registers. I/O ports
040-05F	Timer control registers
060-06F	Keyboard interface controller (8042)
070-07F	RTC ports & CMOS I/O ports
080-09F	DMA register
0A0-0BF	Interrupt controller (slave)
0C0-0DF	DMA controller (slave)
0F0-0FF	Math coprocessor
1F0-1FB	Hard disk controller
278-27F	Parallel port 2
2B0-2DF	Graphics adapter controller
2F8-2FF	Serial port 2
360-36F	Network ports
378-37F	Parallel port 1
3B0-3BF	Monochrome & parallel port adapter
3C0-3CF	EGA adapter
3D0-3DF	CGA adapter
3F0-3F7	Floppy disk controller
3F8-3FF	Serial port-1

5-3 Time & DMA Channels Map

Time map:

Timer channel 0 system timer interrupt
Timer channel 1 DRAM refresh request
Timer channel 2 speaker tone generator

DMA channels:

DMA channel 0 available
DMA channel 1 onboard ECP (option)
DMA channel 2 floppy disk (SMC chip)
DMA channel 3 onboard ECP (default)
DMA channel 4 cascade for DMA controller 1
DMA channel 5 available
DMA channel 6 available
DMA channel 7 available

5-4 Interrupt Map

NMI: non-maskable interrupt

IRQ(H/W):

- 0 system timer interrupt from timer 0
- 1 keyboard output buffer full
- 2 cascade for IRQ 8-15
- 3 serial port2
- 4 serial port1
- 5 parallel port 2
- 6 floppy disk (SMC chip)
- 7 parallel port 1
- 8 RTC clock
- 9 available
- 10 available
- 11 available
- 12 PS/2 mouse
- 13 math coprocessor
- 14 onboard hard disk (IDE1) channel
- 15 onboard hard disk (IDE2) channel

5-5 RTC & CMOS RAM Map

RTC & CMOS :

00 seconds
01 seconds alarm
02 minutes
03 minutes alarm
04 hours
05 hours alarm
06 day of week
07 day of month
08 month
09 year
0a status register a
0b status register b
0c status register c
0d status register d
0e diagnostic status byte
0f shutdown byte
10 floppy disk drive type byte
12 hard disk type byte
13 reserve
14 equipment type
15 base memory low byte
16 base memory high byte
17 extension memory low byte
18 extension memory high byte
19-2d
2e-2f
30 Reserved for extension memory low byte
31 reserved for extension memory high byte
32 date century byte
33 information flag
34-3f reserve
40-7f reserved for chipset setting data

5-6 ISA I/O Address Map

I/O Address (HEX)	I/O device
000 - 01F	DMA Controller 1, 8237A-5
020 - 03F	Interrupt Controller 1, 8259A
040 - 05F	System Timer, 8254-2
060 - 06F	8042 Keyboard Controller
070 - 07F	real-time Clock/CMOS and NMI Mask
080 - 09F	DMA Page Register, 74LS612
0A0 - 0BF	Interrupt Controller 2, 8259A
0C0 - 0DF	DMA Controller 2, 8237A-5
0F0 - 0FF	i486 Math Coprocessor
1F0 - 1F8	Fixed Disk Drive Adapter
200 - 207	Game I/O
20C - 20D	Reserved
21F	Reserved
278 - 27F	Parallel Printer Port 2
2B0 - 2DF	Alternate Enhanced Graphic Adapter
2E1	GPIB Adapter 0
2E2 - 2E3	Data Acquisition Adapter 0
2F8 - 2FF	Serial Port 2 (RS-232-C)
300 - 31F	Prototype Card
360 - 363	PC Network (Low Address)
364 - 367	Reserved
368 - 36B	PC Network (High Address)
36C - 36F	Reserved
378 - 37F	Parallel Printer Port 1
380 - 38F	SDLC, Bisynchronous 2
3B0 - 3BF	Monochrome Display and Printer Adapter

I/O Address (HEX)	I/O device
390 - 393	Cluster
3A0 - 3AF	Bisynchronous 1
3C0 - 3CF	Enhanced Graphics Adapter
3D0 - 3DF	Color/Graphics Monitor Adapter
3F0 - 3F7	Diskette Drive Controller
3F8 - 3FF	Serial Port 1 (RS-232-C)
6E2 - 6E3	Data Acquisition Adapter 1
790 - 793	Cluster Adapter 1
AE2 - AE3	Data Acquisition Adapter 2
B90 - B93	Cluster Adapter 2
EE2 - EE3	Data Acquisition Adapter 3
1390 - 1393	Cluster Adapter 3
22E1	GPIB Adapter 1
2390 - 2393	Cluster Adapter 4
42E1	GPIB Adapter 2
62E1	GPIB Adapter 3
82E1	GPIB Adapter 4
A2E1	GPIB Adapter 5
C2E1	GPIB Adapter 6
E2E1	GPIB Adapter 7

Chapter 6 Q & A

6-1 Errors Messages During Power On Self Test

During **power on self test (post)**, BIOS will automatically detect the system devices. Below is the question that users most often meet. The user may press “**Esc**” key to skip the full memory test.

1. Beep sound

On power on, the system make beep sound to offer different messages. If the system is configured correctly, it prompts a short beep to show device configuration is done correctly. When VGA card and DIMM modules are not plugged well, the system makes longer and constant beep sounds.

2. BIOS ROM checksum error

It indicates the checksum of the BIOS code is not right and system will always halt on power on screen. Contact the dealer to exchange a new BIOS.

3. CMOS battery fails

It indicates the CMOS battery does not work. Contact the dealer to exchange a new battery.

4. CMOS checksum error

It indicates the CMOS checksum is incorrect. Load the default values in BIOS to solve this problem. This error may result from a weak BIOS, so exchange a new BIOS if necessary.

5. Hard disk initialize

Please wait a moment...

Some hard drives require more time to initialize.

6. *Hard disk install failure*

The system can not find or initialize the hard drive controller or the drive. Check if the controller is set correctly. If no hard disk is installed, “**Hard drive selection**” must be set to “**none.**”

7. *Keyboard error or no keyboard present*

This means the system can not initialize the keyboard. Check if the keyboard is plugged well and be sure no keys are pressed during power on self test.

8. *Memory test fails*

There will be more information to specify the type and location of the memory error.

9. *Primary master hard disk fail*

The BIOS find an error in the primary master hard disk drive.

10. *Primary slave hard disk fail*

The BIOS finds an error in the primary slave hard disk drive.

11. *Secondary master hard disk fail*

The BIOS finds an error in the secondary slave master hard disk drive.

12. *Secondary slave hard disk fail*

The BIOS finds an error in the secondary slave IDE hard disk drive.