

i810 Chipset
MicroATX Form Factor
Main Board
User's Manual

Copyright

Copyright ©1999 by this company. No part of this document may be reproduced, transmitted, transcribed, stored in a retrieval system, or translated into any language or computer language, in any form or by any means without prior written permission. This manual and the information contained herein are protected by copyright. All rights reserved.

Manual version: 1.0
Ref. No: 3053177
Published in 1999

Warning and disclaimer

This manual is designed to provide information about the Pentium® II (Socket370) main board. Each effort has been made to make this manual as accurate as possible, but no warranty or fitness is implied. All the information is provided on an 'as is' basis. The author and his corresponding publishing company shall have neither liability nor responsibility to any person or entity with respect to any loss or damages arising from the information contained in this manual or from the use of the system board that accompanies it.

Information contained in this manual is subject to change without notice. The manufacturer of the system board will not be held responsible for technical or editorial omissions made herein, nor for the incidental or consequential damages resulting from its furnishing, performance, functionality or use. Subsequent changes to this manual will be incorporated into the next edition. We welcome any suggestion regarding this manual or our computer products.

Trademarks

- **Intel® and Pentium® are registered trademarks of Intel® Corporation.**
- **IBM® is a registered trademark of International Business Machines Corporation.**
- **Microsoft is a registered trademark of Microsoft® Corporation.**
- **PCI is a registered trademark of PCI Special Interest Groups.**
- **AWARD® is a registered trademark of Award Software Inc.**

All other trademarks are the property of their respective owners.

Table of contents

■	Chapter 1 Introduction.....	1
1-1	Overview.....	1
1-2	Specifications.....	3
1-3	Limitation.....	5
1-4	Notice of Hardware Installation.....	6
1-5	Notice of CD Driver Installation.....	7
1-6	Software Driver Installation.....	8
■	Chapter 2 Installation.....	10
2-1	Layout Reference.....	10
2-2	Jumper Setting.....	11
2-2-1	Jumper Setting Table.....	11
2-2-2	S1 : CPU Frequency Selector.....	12
2-2-3	JP9 : CPU Host BusFrequency Selector.....	13
2-2-4	JP10 : CMOS status.....	14
2-2-5	JP15: Audio Function Selector.....	15
2-3	Connectors	16
2-3-1	Front Panel.....	16
2-3-2	Back Panel.....	18
	COM 1/COM2.....	19
	LPT Parallel Port	19
	USB1.....	19
	Midi/Game Port & External Audio Connectors.....	19
2-3-3	ATX Power Supply Connector.....	20
2-3-4	CPU Fan Connectors.....	21
2-3-5	I.R. Connector.....	22
2-3-6	Floppy Disk Connector.....	23
2-3-7	IDE1 & IDE2.....	24
2-3-8	JP3: SB-Link Connector.....	25

2-3-9	J1/JP4: TV-OUT Function & NTSC/PAL Connector.....	26
2-3-10	JP1 : CD-in.....	27
2-4	DIMM Installation.....	28
■	Chapter 3 BIOS Setup.....	29
3-1	Award BIOS CMOS Setup.....	29
3-1-1	Standard CMOS Setup.....	30
3-1-2	Advanced BIOS Features	36
3-1-3	Chipset Features Setup.....	40
3-1-4	Integrated Peripherals.....	43
3-1-5	Power Management Setup.....	47
3-1-6	PNP/PCI Configuration Setup.....	49
3-1-7	Frequency/Voltage Control.....	51
3-1-8	PC Health Status.....	52
3-1-9	Supervisor/User Password.....	53
3-1-10	Load Fail-Safe Defaults.....	56
3-1-11	Load Optimized Defaults.....	57
3-1-12	Save and Exit Setup.....	58
3-1-13	Quit Without Saving.....	59
■	Chapter 4 Appendix.....	60
4-1	Memory Map.....	60
4-2	I/O Map.....	61
4-3	Time & DMA Channels Map.....	62
4-4	Interrupt Map.....	63
4-5	RTC & CMOS RAM Map.....	64
4-6	Award BIOS Hard Disk Type.....	65
4-7	ISA I/O Address Map.....	67
■	Chapter 5 Q & A.....	69
5-1	Error Messages During Power on Self Test.....	69

Chapter 1 Introduction

1-1 Overview

The main board utilized Intel's latest i810 chipset which is integrated with new architects such as integrated graphic, sound, ULTRA DMA-66(optional), USB & AMR is designed to fit INTEL PPGA type Socket-370 CPUs.

Intel's i810 is a cost-effective but high performance chipset which has integrated graphics controller(i752) with a 24 Bit 230MHz RAMDAC & software MPEG2 DECODE. It supports UMA (unified memory architect) mode up to 64MB with main memory or 4MB 3D texture memory(or called display cache) that can accelerate its 3D graphics performance. The on board AD1881 AC-97 CODEC chip provides perfect 3D sound function.

The main board also implements ITE I/O LPC controller utilizing with fully Plug and Play devices and keyboard password setup. It supports 2.88 MB Floppy, Dual 16550 compatible (with 16 bytes FIFO, up to 460K baud rate) serial Port, ECP (Enhanced Capabilities Port), EPP (Enhanced Parallel Port) parallel port, SPP(Standard Parallel Port), Infrared IrDA (HPSIR), and Amplitude Shift Keyed IR. (ASKIR) port and hardware monitor functions too.

The main board contains 3*PCI & 1*ISA (optional) for highest performance I/O add-on adapter cards. The main board supports three Bus Mastering Slots for high-performance I/O add-on cards. It supports Matrix Independent PCI routing for optimal multiple PCI adapter operations and is PCI2.2 specification compliant. 133MB/s data transfer rate can be compared to 33MB/s on EISA bus, or 8MB/s on ISA bus. It support back to back sequential CPU to PCI Memory writes to PCI Burst Write for full PCI throughput. The new AMR Slot is designed to fit low cost A(Audio) M(Modem) R(Riser) or MR card.

The main board has 2 dual in-line memory modules (DIMM) which can be installed with PC-100 SDRAM memory. The memory subsystem supports up to 512 MB SDRAM of non-buffered 3.3V using standard 168-pin DIMM sockets.

The main board is strengthened with Power Management Wake up Event such as **“Modem ring on”** which are the new inventions to enable PCs to be turned on over the network or modem. These are also key benefits in PC operation, asset management, new system setup and power conservation.

In addition to the above hardware features, this main board is DIP switch design which allows user to set CPU frequency through BIOS. With this design, the disadvantages of setting hardware CPU jumpers are improved to a better and easier procedure through BIOS.

In conclusion, the system chipset and design make the main board a high performance, cost-effective, and energy efficient main board which meets a variety of price/performance levels. The main board is an ideal platform for the increasing requirements of today’s and future’s desktop applications.

1-2 Specifications

- **Chipset:** There are 4 sets of i810 listed as below:

Type	810-L	810	810-DC100	810-DC-133
North	GMCH0	GMCH0	GMCH	GMCH-E
South	ICH0	ICH	ICH	ICH
FSB	100MHz	100MHz	100MHz	133MHz
Display Cache	NO	NO	Yes, 100MHz	Yes, 100MHz
ATA	ATA33	ATA66	ATA66	ATA66
PCI REQ/GNT	4	6	6	6

- **CPU :** can take current 66MHz FSB Celeron-A CPU or later 100MHz version.
- **Memory :** accepts 2 * DIMM in PC-100 specification memory
- **VGA :** On chip 3D graphics function with shared (i810L & i810) or 4MB (i810DC -100/133) 3D texture memory (or called display cache)
- **Sound :** Provides sound function with AD1881 AC-97 3D sound CODEC.
- **Expansion Slot :** 1x ISA slots(optional), 3x PCI slots, 1 x AMR(used for AMR card or MR card)
- **IDE :** support ULTRA DMA-33(i810L) or 66(i810, i810DC-100/133) mode
- **PCB Board size :** 24.40cm x 22.0cm, Micro ATX form factor
- **Optional Items:**
 - TV-out (Chrontal CH7007 chip is needed)
 - ISA Slot (ITE-8888 chip is needed)



tion : System needs PC-100 memory & over 1 Ampere current power supply for this main board

- **Other features**

- Modem ring on
- Windows 95/98 power off
- Keyboard wake-up
- Mouse wake-up
- DMI, ACPI supported BIOS

1-3 Limitation

There are some limitations on i810 chipset shown as below:

1. Hardware:

- * Must use PC-100 specification DIMM
- * Must use over 1 Ampere current (I) power supply.
- * PCI3 slot is limited as “Slave” mode only; it can not take “Master“ mode add-on cards like SCSI....
- * Incompatible with all S3 series PCI VGA cards; using on-board VGA function is recommended!

2. Software (Driver or BIOS):

- * Suspend to RAM (STR) function is not ready.
- * Windows 95 & 98 don't provide driver (utilities) for i810 chipset. User needs to install driver carefully before using this board(Refer to 1-6 i810 driver and utility installation)
- * If user needs to run “Final Reality” 3D test program, please copy “MSVCRT.DLL” hidden file from attached CD to one formatted floppy diskette and then copy it to hard disk driver path as C:\windows\system to update “MSVCRT.DLL” file. [CD → Floppy Diskette → HDD]

1-4 Notice of Hardware Installation

Before installing the main board hardware, note the following things.

A. Check the package

If any of the below items is missing or damaged, contact the dealer from whom you purchase. Leave this main board in its original package until you are ready to install it. In the package, there are:

- the main board
- manual
- cables
- driver & utility / CD

B. Make sure power is off.

During hardware installation, be sure there is no power connected at this period.

C. Avoid ESD (Electrical Static Discharge)

While working with this main board, always wear a grounded wristband or ankle strap to avoid ESD (Electrical Static Discharge).

1-5 Notice of CD Driver Installation

This CD contains the following drivers. The user must read “Index” (HTML format) before installing required drivers. Index offers all the information on all the drivers.

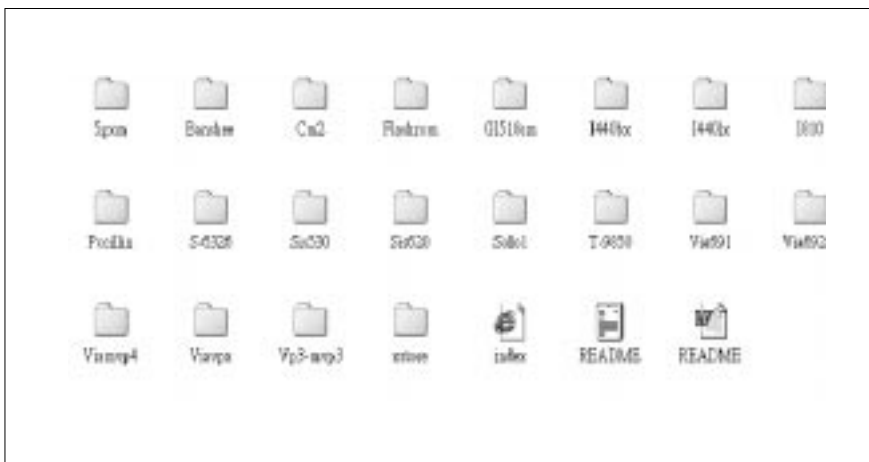

CD driver is always updated with the latest version, and the actual CD content may have some differences with the above picture.

1. **Main boards:** i440ZX, i440BX, i440EX, i440LX, i430TX, VIA® VPX, i810 VP3, SIS® 620- based main boards
2. **Sound:** ESS-solo-1 sound driver
3. **Hardware monitoring :** CPU voltage/temperature and fan speed detection software
4. **Pccillin :** anti-virus protection software

1-6 Software Driver Installation

Unlike i440BX or i440LX, Windows-95 or Windows-98 still hasn't drivers for i810 chipset, **USER NEEDS TO INSTALL DRIVERS VERY CAREFULLY OR SYSTEM WILL HANG UP UNEXPECTEDLY!**

Load drivers from attached CD & find sub-directories under i810 directory as:

INTELINE..... (Setup driver for i810 chipset)
INF -- |
INFINSTV1.0(Setup driver for i810 chipset)
VGAPV10..... (VGA Driver)
DX61.....(DIRECTx61 Driver)
AD1881..... (Drivers for sound function)

User needs to install drivers

INTELINE → **INFINSTV1.0** → **VGAPV10** → **DX61** → **AD1881** as below

1. FOR WINDOWS 95:

- (1) Install Intel INFV1.0 file:
 - A. Install Window 95 OSR2 V2.0 or higher version firstly.
 - B. Install "USBSUPP" driver.
 - C. Load attached CD & find "INF" directory. Then find sub-directory named "Intel INF V1.0" & execute "Setup" file, during the selection procedure, to select: "Windows-95 with USB supplement "for OSR2 or higher version, if not, select : "Windows-95 without USB supplement" don't select "Windows-98".
- (2) Install InfinstV1.0 file
 - A. Back to find InfinstV1.0 sub-directory and execute "Setup", just answer Questions to complete it & restart system again(to update it to Win-95)

(3) VGA Driver Installation :

- A. Find directory VGAPV10 and Win9X sub-directory then execute SETUP and RESTART system.
- B. Find DX61 and execute DIRECTx61, then RESTART system to complete VGA drivers installation.

(4) Audio Driver Installation

- A. Find “AD1881 DRI” sub-directory, then find Win-95 sub-directory, then find “DRIVER 0040” execute “SETUP” & restart system.

2. FOR WINDOWS 98:

The installation procedures are similar to Windows 95, below are the differences :

- A. No need to install “USBSUPP” driver.
- B. When installing INTELINF & execute SETUP, select “Window-98”.
- C. When installing VGA and sound driver, select Win98 instead of Win95.



ons : When install Windows 95/98. Don't change the default directory path called "windows" or Sound chip AD1881 can't find correct path that causes user cannot complete installation.

Chapter 2 Installation

2-1 Layout Reference

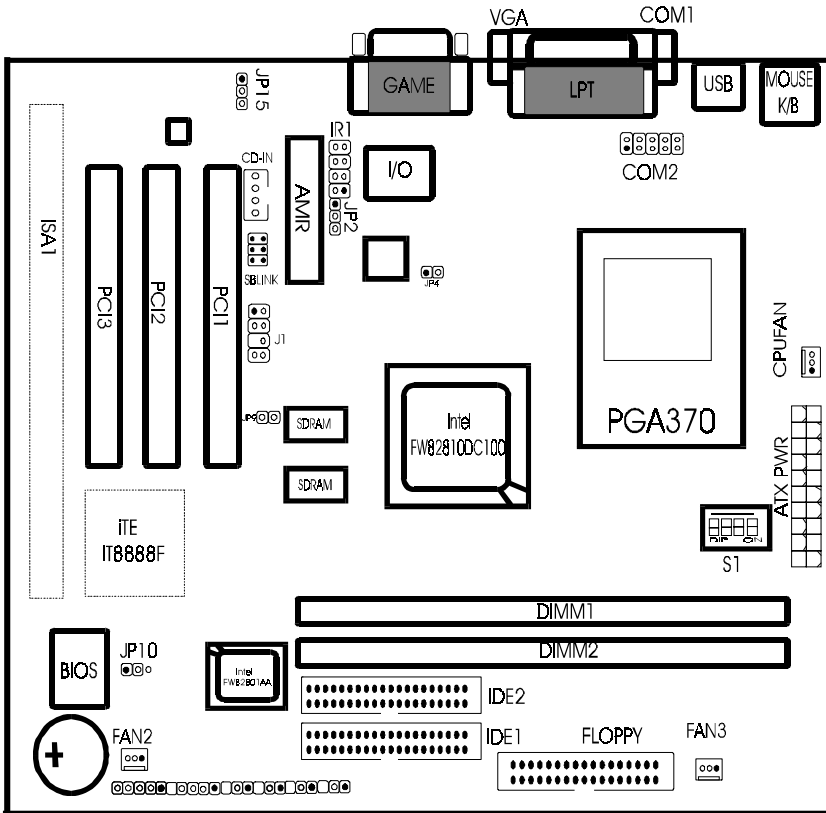

2-2 Jumper Setting

There are 4 jumpers on this main board. Different setups have different functions. The following pages will tell how to set the jumpers under different circumstances.

2-2-1 Jumper Setting Table

CPU Speed	FSB Speed	S1				JP9
		1	2	3	4	
		ON	ON	OFF	OFF	ON
Celeron 300A	66MHz	ON	ON	OFF	OFF	ON
Celeron 333	66MHz	ON	ON	OFF	OFF	ON
Celeron 366	66MHz	ON	ON	OFF	OFF	ON
Celeron 400	66MHz	ON	ON	OFF	OFF	ON
Celeron 433	66MHz	ON	ON	OFF	OFF	ON
Celeron 466	66MHz	ON	ON	OFF	OFF	ON



*standard Celeron-A CPU is 2.2V of Vcore & 66MHz of front side bus speed.
manufacturer shall have neither liability nor responsibility to any person or
entity with respect to any loss or damages arising by user's over-clocking or over-voltage.*

2-2-2 S1 : CPU Frequency Selector

S1 is a 4-pin DIP switch. Select the right frequency according to your CPU, and see details as below.

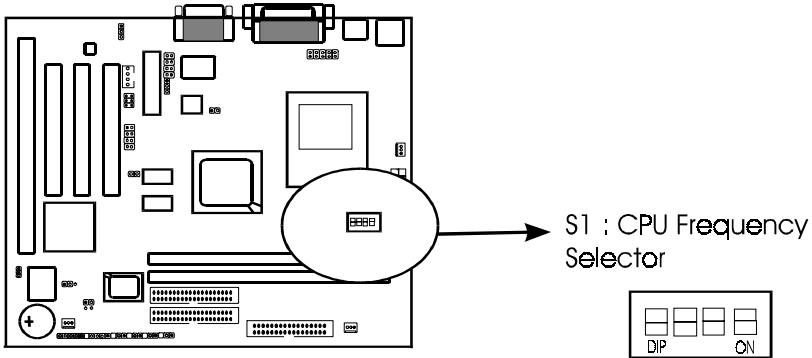

CPU FSB FREQ.	S1			
	1	2	3	4
66 MHz	ON	ON	OFF	OFF
75 MHz	OFF	OFF	ON	ON
83 MHz	OFF	OFF	ON	OFF
90 MHz	OFF	OFF	OFF	ON
95 MHz	OFF	OFF	OFF	OFF
100MHz	ON	ON	ON	ON

2-2-3 JP9 : CPU Host Bus Frequency Selector

JP9 is a 2-pin selector. Select the right frequency according to your CPU, and see details as below.

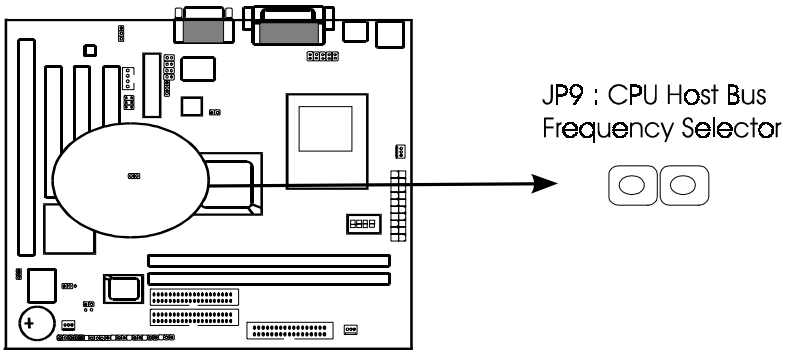

	100MHz	66MHz ~ 95MHz
JP9	OFF	ON



*standard Celeron-A CPU is 2.2V of Vcore & 66MHz of front side bus speed.
manufacturer shall have neither liability nor responsibility to any person or
entity with respect to any loss or damages arising by user's over-clocking or over-voltage.*

2-2-4 JP10 - CMOS status

JP10, a 3-pin connector is to clear CMOS if password is forgotten. Below is the details to clear CMOS.

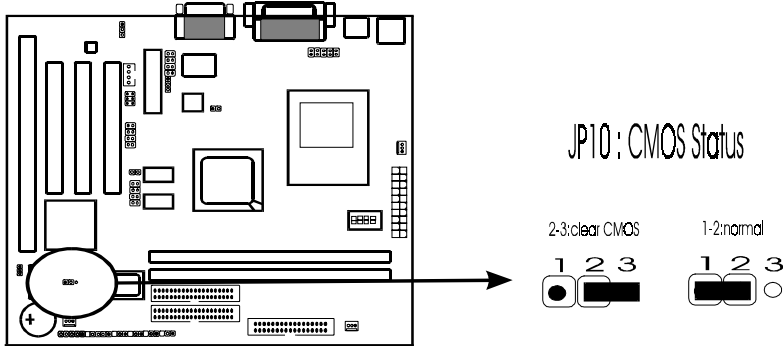

Procedure to clear CMOS:

- Step 1: Shut down the system and disconnect the power supply from AC power.
 - Step 2: Pull out the power supply cable from the power connector.
 - Step 3: Short the CMOS jumper by putting jumper cap on Pin 2-3 for a few seconds.
 - Step 4: Return the cap to pin 1-2 at normal setup.
 - Step 5: Link the power cable to the connector & connect AC power to power supply.
 - Step 6: Turn on system power.
- If you'd like to set password, press "Del" Key during system boot up to enter CMOS setup and establish a new password.
- : .

2-2-5 JP15: Audio Function Selector

JP15 is a 3-pin jumper to enable/disable on-board Audio function. Set “2-3” to use on-board sound if AC97 CODEC IC is existed, set “1-2” to disable on board audio function & allow AMR card or any PCI/ISA sound card installed on slots. The default is on-board audio.

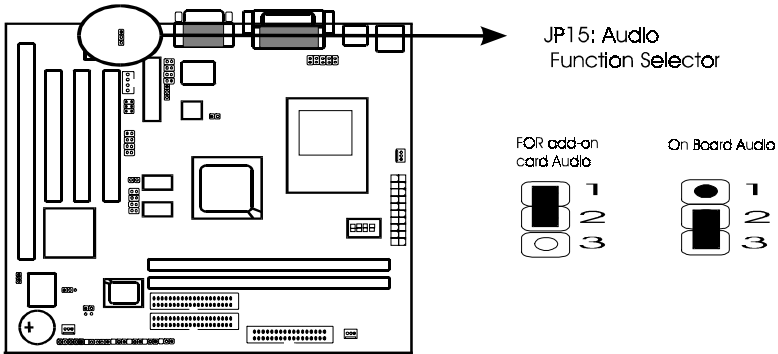

2-3 Connectors

There are many connectors on this main board. Refer to the following pages for details.

2-3-1 Front Panel Connectors

Front panel has connectors such as “PW-LED,” “KEYLOCK,” “SPEAKER,” “RESET,” “HDD-LED,” “TB-LED,” ”SOFT-PWR.” Please refer to the following further information.

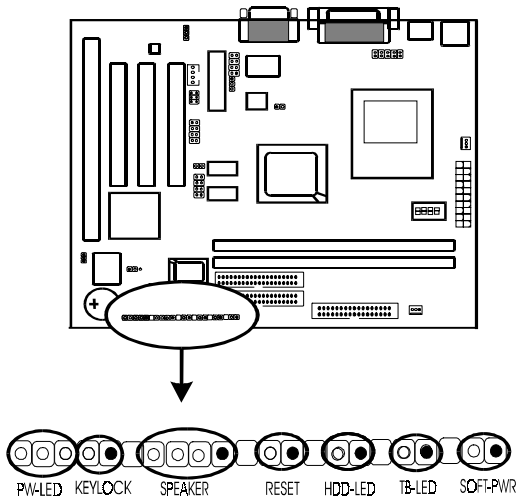

PW-LED is a 3-pin connector. It is used to connect to the LED on the case front panel. The LED shows the status of the power.

KEYLOCK is a 2-pin connector. It is used to connect the key lock on the case front panel (if there is). Keyboard may be disconnected with the system through this function. Set to “on” to disconnect the connector with the system and “off” for normal status. Keylock using with JP2 connector.

SPEAKER is a 4-pin keyed Berg strip. It is used to connect to the case speaker to the main board for sound purpose.

RESET is a 2-pin keyed Berg strip, connected to the push button reset switch on the case’s front panel. Shorting both pin 1 & pin 2 can reset the system, which is similar to the power off and then on again.

HDD-LED (Hard Disk activity LED connector) is a 2-pin keyed Berg strip. It is used to connect to front panel Hard Disk LED.

TB-LED is a 2-pin Berg strip on case front panel indicates the current speed status of system.

SOFT-PWR is ATX Soft-PWR with a 2 pins. SOFT-PWR is for ATX power supply only.

2-3-2 Back Panel Connectors

Back Panel Connectors are GAME Port, MIC, LINE-IN, LINE-OUT, COM1/COM2, LPT, USB, PS/2 keyboard, and PS/2 mouse on case back panel. Refer to below details.

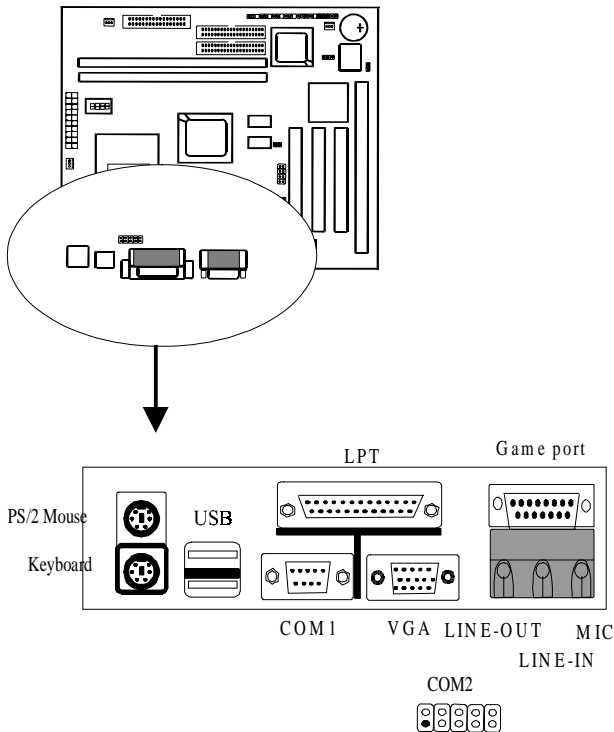

COM1 & COM2

The onboard serial port 1 and port 2 are the 9-pin D-subminiature male connector COM1 and COM2. COM1 and COM2 can be disabled in BIOS setup. Please refer to Chapter 3 “Integrated Peripherals” for more information.

KBD/PS2 MOUSE

The onboard PS/2 keyboard and mouse connectors are 6-pin Mini-Din connectors.

LPT

The onboard parallel port is a 25-pin female connector. It supports standard printer port, Enhanced Parallel Port (EPP), Extended Capabilities Port (ECP), Standard Parallel Port (SPP).

USB: USB (Universal Serial Bus) Connector

Universal Serial Bus connector, marked as “USB,” is used to connect USB devices. There are 2 USB connectors on this main board.

Midi/Game Port & External Audio Connectors

Midi/Game port has 15 pins connecting to the game joystick. External Audio connectors are “LINE-OUT, LINE-IN, MIC-IN” for audio functions.

2-3-3 ATX Power Supply Connector

ATX power connector has 20 pins, which is designed for ATX case especially. The ATX power supply supports the function of the “**Soft Power On Momentary switch**” which connects on the front panel switch to the 2-pin **SOFT-PWR** on the system board. While the power switch on the back of ATX power is turned on, the full power will not go into the system board until the front panel switch is momentarily pressed. Push the switch again to turn off the power to the system board.

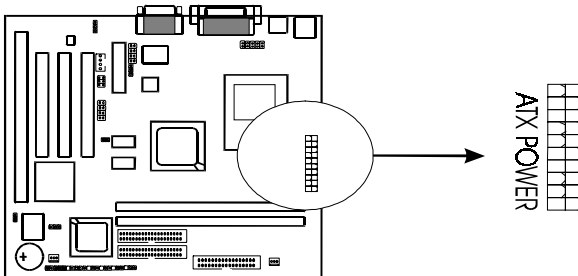

To support i810 chipset, we suggest that Pin 17 signal 5VSB on ATX Power supply should be able to offer at least 750 mA driving ability.

2-3-4 CPU Fan Connectors

There are 3 fan connectors on this system board, and it is marked as “CPUFAN”. Each fan connector has three pins.

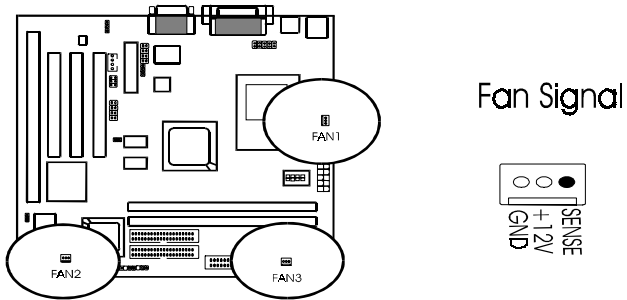

2-3-5 I.R. : IrDA Connector

IR connector supports wireless infrared module. With this module and application software like Laplink, or Win95 Direct Cable Connection, user can transfer data to or from laptops, notebooks, PDA and printers. This connector supports **HPSIR**, **ASKIR**, and **Fast IR**.

Attach Infrared module to IR connector. Be sure to put in the right orientation during attachment.

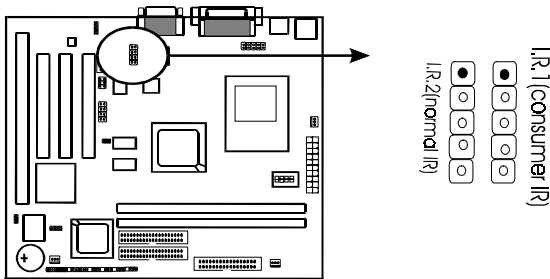

	IR2(normal IR)	IR1(consumer IR)
1	VCC	VCC
2		
3	IRRX	CIRRX
4	IRTX	CIRTX
5	GND	GND

2-3-6 Floppy Disk Connector

Floppy Disk connector has 34 pins and is used to attach the floppy drive cable.

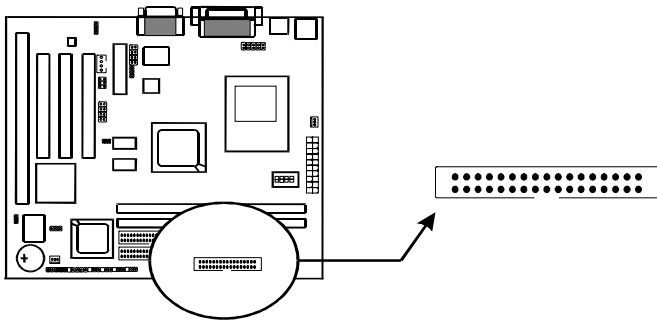

2-3-7 IDE1 & IDE2

IDE1 and IDE2 are 39 – pin IDE connectors (Ultra 66). **IDE1** is primary channel, and **IDE2** is secondary channel. Each channel supports 2 IDE devices, and 4 devices in total for this main board.

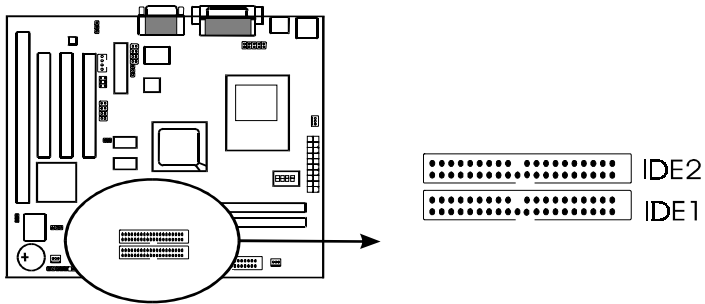

2-3-8 JP3 SB-Link Connector(Optional)

SB-LINK is used to attach any “PC/PCI” standard sound card like Creative AWE64D or Yamaha XG...for compatibility under DOS mode.

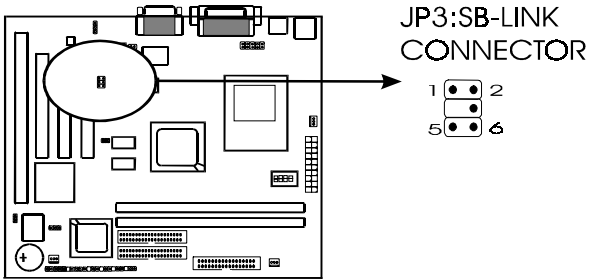

2-3-9 J1/JP4 : TV-OUT Function & NTSC/PAL Connector (optional)

J1 is a 7-pin connector providing TV-OUT function. JP4 is a 2-pin connector providing to connect NTSC/PAL.(optional item)

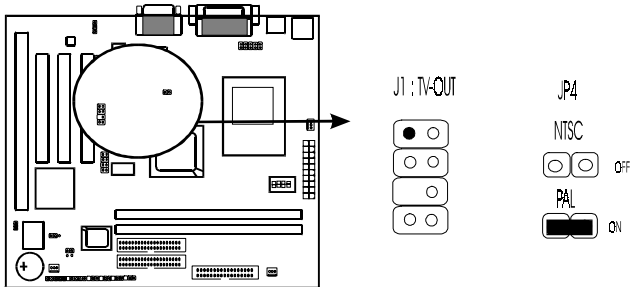

2-3-10 JP1: CD-in

JP1 is a CD ROM external audio input signal to line-out (speaker) of the main board.

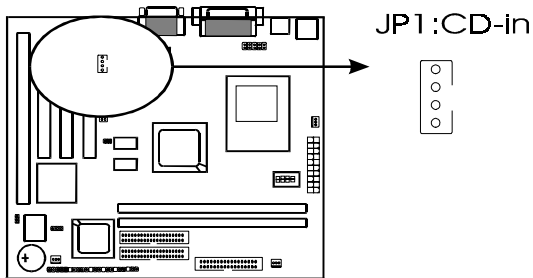

2-4 DIMM Installation

Please make sure DIMM is 3.3V DIMM. Either DIMM1 or DIMM2 supports 8 MB, 16 MB, 32 MB, 64 MB, and 128MB. Maximum memory for **SDRAM is up to 512 MB**. The user may insert DIMM modules in either DIMM1, or DIMM2.

Insert the module as shown. Due to different number of pins on either side of the breaks, the module will only fit in the orientation as shown. SDRAM DIMM modules have different pin contacts on each side and therefore have a higher pin density.

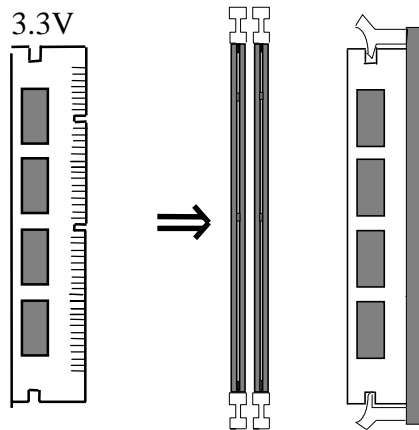

 RAM memory supports PC-100 DIMM or above.

Chapter 3 BIOS Setup

3-1 Award® BIOS CMOS Setup

CMOS Setup Utility - Copyright (C) 1984-1999

Standard CMOS Feature	Frequency/Voltage Control
Advanced BIOS Feature	Load Fail-Safe Defaults
Advanced Chipset Feature	Load Optimized Defaults
Integrated Peripherals	Set Supervisor Password
Power Management Setup	Set User Password
PnP/PCI Configurations	Save & Exit Setup
PC Health Status	Exit Without Saving
Esc : Quit	↑ ↓ ← → : Select Item
F10 : Save & Exit Setup	
Time, Date, Hard Disk Type	

The menu displays all the major selection items and allow user to select any of the shown item. The selection is made by moving cursor (press any direction key) to the item and press <Enter> key. An on-line help message is displayed at the bottom of the screen as cursor is moving to various items which provides user better understanding of each function. When a selection is made, the menu of selected item will appear. So the user can modify associated configuration parameters.

3-1-1 Standard CMOS Setup

Standard CMOS Features		Item Help
Date:	Mon, Feb 8	
1999		
Time:	16:19:20	
➤ IDE Primary Master	2557 MB	Menu Level ➤
➤ IDE Primary Slave	None	Change the day, month,
➤ IDE Secondary Master	None	year and century
➤ IDE Secondary Slave	None	
Drive A	1.44M, 3.5 in.	
Drive B	None	
Video	EGA/VGA	
Halt On	All Errors	
Based Memory	640K	
Extended Memory	64512K	
Total Memory	65536K	
↑↓←→Move Enter: Select +/-/PU/PD: Value F10:Save ESC: Exit F1:General Help F5:Previous Values F6:Fail-safe defaults F7:Optimized Defaults		

The "Standard CMOS Setup" allows user to configure system setting such as **current date** and **time**, **type of hard disk drive** installed in the system, **floppy drive type**, and the type of **display monitor**. Memory size is auto detected by the BIOS and displayed for your reference. When a field is highlighted (direction keys to move cursor and <Enter> key to select). The entries in the field will be changed by pressing <PageDown> or <PageUp> key or user can enter new data directly from the keyboard.

CMOS Setup Utility – Copyright © 1984 – 1999 Award Software
IDE Primary Master

IDE HDD Auto-Detection	Press Enter	Item Help
IDE Primary Master	Auto	
Capacity	8455MB	Menu Level
Access Mode	Auto	To auto-detect the HDD's size, headon this channel.
Cylinder	16383	
Head	16	
Precomp	0	
Landing Zone	16382	
Sector	63	
↑↓←→Move Enter: Select +/-/PU/PD: Value F10:Save ESC: Exit F1:General Help F5:Previous Values F6:Fail-safe defaults F7:Optimized Defaults		

Hard Disk Configurations

1.IDE HDD Auto-Detection : press this item to Auto detect the HDD type.

2.IDE Primary Master : select "AUTO" to detect the mode type automatically. Select "NORMAL" users have to redefine the following 4-8 items according to HDD. "NONE" means this item disabled.

3.ACCESS MODE : select "AUTO" to detect the mode type automatically. If your hard disk supports the **LBA** mode, select "**LBA**" or "**LARGE**". However, if your hard disk cylinder is more than 1024 and does not support the LBA function, you have to set at "**LARGE.**" Select "**NORMAL**" if your hard disk supporting cylinder is below 1024.

4. CYLS : the cylinder number of the hard disk.

5. HEAD : the read/write head number of hard disk. The range is from "**1**" to "**16**".

6.PRECOMP: the cylinder number at which the disk drive changes the write timing.

7.LANDZ : the cylinder number that the disk drive heads (read/write) are seated when the disk drive is parked.

8.SECTOR : the sector number of each track defined on the hard disk. The range is from "**1**" to "**64**".



Note1: if hard disk primary master/slave and secondary master/slave were set to "**auto**", the hard disk size and model will be auto detected on display during POST.



Note2: "**halt on**" is to determine when to halt the system by the BIOS if error occurred during POST.

The Award® BIOS supports 3 HDD modes: **NORMAL, LBA & LARGE.**

1. Normal mode

Generic access mode in which neither the BIOS nor the IDE controller will make any transformations during accessing.

The maximum number of cylinders, head & sectors for normal mode are **1024, 16 & 63.**

No. Cylinder	(1024)
X No. Head	(16)
X No. Sector	(63)
<u>X No. Per Sector</u>	<u>(512)</u>
	528 MB

If user set this HDD to normal mode, the maximum accessible HDD size will be 528 MB even though its physical size may be greater than that!

2. LBA (Logical Block Addressing) Mode

A new HDD accessing method to overcome the 528 MB bottleneck. The number of cylinders, heads & sectors shown in setup may not be the number physically contained in the HDD. During HDD accessing, the IDE controller will transform the logical address described by sector, head & cylinder into its own physical address inside the HDD.

The maximum HDD size supported by LBA mode is 8.4 GB which is obtained by the following formula:

$$\begin{array}{r} \text{No. Cylinder} \quad (1024) \\ \text{X No. Head} \quad (255) \\ \text{X No. Sector} \quad (63) \\ \hline \text{X No. Bytes Per Sector} \quad (512) \\ \hline 8.4 \text{ GB} \end{array}$$

3. Large Mode

Extended HDD access mode supported by Award® software. Some IDE HDDs contain more than 1024 cylinder without LBA support (in some cases, users do not want LBA). The Award® BIOS provides another alternative to support these kinds of large mode:

<u>Cyls.</u>	<u>Head</u>	<u>Sector</u>	<u>Mode</u>
1120	16	59	NORMAL
560	32	59	LARGE

BIOS tricks DOS (or other OS) that the number of cylinders is less than 1024 by dividing it by 2. At the same time, the number of heads is multiplied by 2. A reverse transformation process will be made inside int 12h in order to access the right HDD address the right HDD address!

4. Maximum HDD Size:

$$\begin{array}{r} \text{No. Cylinder} \quad (1024) \\ \text{X No. Head} \quad (32) \\ \text{X No. Sector} \quad (63) \\ \hline \text{X No. Bytes Per Sector} \quad (512) \\ \hline 1 \text{ GB} \end{array}$$



To support LBA or large mode of HDDs, there must be some softwares involved. All these softwares are located in the Award® HDD service routine (int 13h). It may be failed to access a HDD with LBA (large) mode selected if you are running under an operating system which replaces the whole int 13h. Unix operating systems do not support either LBA or large and must utility the standard mode. Unix can support drives larger than 528MB.

3-1-2 Advanced BIOS Features

Menu below shows all of the manufacturer's default values of this main board. Move the cursor by pressing <PageDown>/- or <PageUp>/+ key to modify the parameters, pressing [F1] key to display help message of the selected item. This setup program also provide 2 convenient ways to load the default parameter data from BIOS [F6] and [F7] area if shown data is corrupted. This provides the system a capability to recover from any possible error.

CMOS Setup Utility – Copyright © 1984 – 1999 Award Software Advanced BIOS Features

Virus Warning	Disabled	Item Help
CPU Internal Cache	Enabled	
External Cache	Enabled	
CPU L2 Cache ECC Checking	Enabled	
Quick Power On Self Test	Enabled	
First Boot device	Floppy	
Second Boot device	HDD-0	
Third Boot device	Floppy	
Boot other device	Enabled	
Swap Floppy Drive	Disabled	
Boot Up Floppy Seek	Disabled	
Boot Up NumLock Status	Off	
Gate A20 Option	Normal	
Typematic Rate Setting	Disabled	
Typematic Rate (Chars/Sec)	6	
Typematic Delay (Msec)	250	
Security Option	Setup	
OS Select For DRAM > 64MB	Non-OS2	
Report NO FDD For Win 95	No	
Menu Level >		
Allows you to choose the VIRUS warning feature for IDE Hard Disk boot sector protection. If this function is enabled and someone attempt to write data into this area, BIOS will show a warning message on screen and alarm beep		
↑↓←→Move Enter: Select +/-/PU/PD: Value F10:Save ESC: Exit F1:General Help F5:Previous Values F6:Fail-safe defaults F7:Optimized Defaults		

Virus Warning

:Enabled (default)

:Disabled

CPU Internal Cache

Enabled : enable L1 cache(default)

Disabled: disable L1 cache

External Cache

Enabled (default): enable L2 cache

Disabled: disable L2 cache

CPU L2 Cache ECC Checking

Enabled (default): enable L2 cache ECC checking

Disabled: disable L2 cache ECC checking

Quick Power On Self Test

This category speeds up power on self test.

Enabled (default) : BIOS will shorten or skip some check items.

Disabled: normal speed

First Boot Device

This category determines which drive the system searches first. System will search in turn for floppy disk drive; second is hard disk drive, and finally Floppy drive. Default value is “**FLOPPY**”. Options are as below:

FLOPPY; LS/ZIP; HDD-0; SCSI; CDROM; HDD-1; HDD-2; HDD-3; LAN;

Disable

Second Boot Device

This category determines which drive the system searches first. System will search in turn for floppy disk drive; second is hard disk drive, and finally Floppy drive. Default value is “**HDD-0**”. Options are as below:

FLOPPY; LS/ZIP; HDD-0; SCSI; CDROM; HDD-1; HDD-2; HDD-3; LAN;

Disable

Third Boot Device

This category determines which drive the system searches first. System will search in turn for floppy disk drive; second is hard disk drive, and finally Floppy drive. Default value is “**LS/ZIP**”. Options are as below:

FLOPPY; LS/ZIP; HDD-0; SCSI; CDROM; HDD-1; HDD-2; HDD-3; LAN; Disable

Swap Floppy Drive

Enabled: floppy A&B will be swapped.

Disabled(default): floppy A&B will be not swapped.

Boot Up Floppy Seek

BIOS will determine if the floppy disk drive is 40 or 80 tracks. 360k type is 40 tracks while 720K/ 1.2M and 1.44M are all 80 tracks. Default value is **enabled**.

Boot Up Numlock Status

:On

:Off(default)

Gate A20 Speed

:Normal (default)

:Fast

Typematic Rate Setting

This determines the typematic rate.

Enabled: enable typematic rate and typematic delay programming.

Disabled (default) : disable typematic rate and typematic delay programming. The system BIOS will use default value of this 2 items and the default is controlled by keyboard.

Typematic Rate(Chars/Sec)

6 : 6 Characters Per Second (default)

8 : 8 Characters Per Second

10 :10 Characters Per Second

12 : 12 Characters Per Second

-
- 15 : 15 Characters Per Second
 - 20 : 20 Characters Per Second
 - 24 : 24 Characters Per Second
 - 30 : 30 Characters Per Second

Typematic Delay (Msec)

This is the interval between the first and second character displayed.

- 250** : 250 msec (default)
- 500** : 500 msec
- 750** : 750 msec
- 1000** : 1000 msec

Security Option

Item	Function	Note
Setup (default)	Security protection in CMOS setup menu	After setting password in BIOS CMOS “ Supervisor Password ” or User Password, ” it protects BIOS CMOS setup.
System	Security protection in system boot-up & BIOS setup	This function secures the system under system boot-up and BIOS setup after setting password.

OS Select For DRAM > 64MB

This option is especially set for OS2 operating system. Set “**Non-OS2**” for RAM memory over 64MB and set “**Non-OS2**” for other operating systems like Windows® 95/98 or NT.

- :Non-OS2 (default)**
- :OS2**

3-1-3 Chipset Features Setup

CMOS Setup Utility – Copyright © 1984 – 1999 Award Software
Advanced Chipset Features

SDRAM CAS Latency Time	3	Item Help
SDRAM Cycle Time Tras/Trc	6/8	
SDRAM RAS-to-CAS Delay	3	Menu Level ➤
SDRAM RAS Precharge Time	3	
System BIOS Cacheable	Enabled	
Video BIOS Cacheable	Enabled	
Memory Hole At 15M-16M	Disabled	
Delay Transaction	Disabled	
On-Chip Video Window Size	64MB	
Local Memory Frequency	100 MHz	
* Onboard Display Cache Setting *		
CAS# Latency	3	
Paging Mode Control	Close	
RAS-to-CAS Override	by CAS # LT	
RAS# Timing	Slow	
RAS# Precharge Timing	Slow	
↑↓←→Move Enter: Select +/-/PU/PD: Value F10:Save ESC: Exit F1:General Help F5:Previous Values F6:Fail-safe defaults F7:Optimized Defaults		

SDRAM RAS to CAS delay

This controls the DRAM page miss and row miss leadoff timing.

: 2

: 3 (default)

SDRAM RAS Precharge Time

SDRAM precharge time by RAS.

: 2

: 3 (default)

System BIOS cacheable

define whether system BIOS area cacheable or not.

:Enabled (default)

:Disabled

Video BIOS cacheable: to define whether video BIOS area cacheable or not.

:Enabled (default)

:Disabled

Memory Hole at 15M-16M: this field enable a memory hole in main memory space. CPU cycles matching an enabled hold are passed on to PCI note that a selected can not be changed while the L2 cache is enabled.

:Enabled

:Disabled (default)

Delay Transaction

:Enabled

:Disabled(default)

Onboard Display Cache Setting

CAS# Latency

:3(default)

:2

Paging Mode Control

:Close(default)

:Open

RAS-to-CAS Override

:by CAS # LT(default)

:Override(2)

RAS# Timing

:Slow(default)

:Fast

RAS# Precharge Timing

:Slow(default)

:Fast

3-1-4 Integrated Peripherals

CMOS Setup Utility – Copyright © 1984 – 1999 Award Software
Integrated Peripherals

OnChip Primary PCI IDE	Enabled	Item Help
OnChip Secondary PCI IDE	Enabled	
IDE Primary Master PIO	Auto	Menu Level ➤
IDE Primary Slave PIO	Auto	If your IDE hard drive supports
IDE Secondary Master PIO	Auto	block mode select Enabled for
IDE Secondary Slave PIO	Auto	automatic detection of the optimal
IDE Primary Master UDMA	Auto	number of block read/write per
IDE Primary Slave UDMA	Auto	sector the drive can support
IDE Secondary Master UDMA	Auto	
IDE Secondary Slave UDMA	Auto	
USB Controller	Enabled	
USB Keyboard Support	Disabled	
Init Display First	PCI Slot	
AC97 Audio	Enabled	
AC97 Modem	Disabled	
IDE HDD Block Mode	Enabled	
Onboard FDC Controller	Enabled	
Onboard Serial Port 1	3F8/IRQ4	
Onboard Serial Port 2	2F8/IRQ3	
↑↓←→ Move Enter: Select +/-PU/PD: Value F10:Save ESC: Exit F1:General Help F5:Previous Values F6:Fail-safe defaults F7:Optimized Defaults		

OnChip Primary PCI IDE

:Enabled(default)

:Disabled

OnChip Secondary PCI IDE

:Enabled(default)

:Disabled

IDE Primary Master PIO

This feature detects your primary master hard disk device.

:Auto (default)

:Mode 0,1,2,3,4

IDE Primary Slave PIO

This feature detects your primary master hard disk device.

:Auto (default)

:Mode 0,1,2,3,4

IDE Secondary Master PIO

This feature detects your secondary master hard disk device.

:Auto (default)

:Mode 0,1,2,3,4

IDE Secondary Slave PIO

This feature detects your secondary master hard disk device.

:Auto (default)

:Mode 0,1,2,3,4

IDE Primary Master UDMA

:Auto(default)

:Disabled

IDE Primary Slave UDMA

:Auto(default)

:Disabled

IDE Secondary Master UDMA

:Auto(default)

:Disabled

IDE Secondary Slave UDMA

:Auto(default)

:Disabled

USB Controller

:Enabled(default)

:Disabled

USB Keyboard support

:Enabled

:Disabled(default)

Init Display First

:PCI Slot(default)

:On board

AC97 Audio

:Enabled(default)

:Disabled

AC97 Modem

:Enabled

:Disabled(default)

IDE HDD Block Mode

:Enabled(default)

:Disabled

Onboard FDC Controller

: Enabled (default)

: Disabled

Onboard Serial Port 1

: 3F8/IRQ4

: 2F8/IRQ3

: 3E8/IRQ4

: 2E8/IRQ3(default)

: Auto

: Disabled

On-Board Serial Port 2

: 3F8/IRQ4

: 2F8/IRQ3(default)

: 3E8/IRQ4
: 2E8/IRQ3
: Auto
: Disabled

UART Mode Select

: Normal
: SCR
: IrDA
: ASKIR

Onboard Parallel Port

: Disabled
: 3BC/IRQ7
: 378/IRQ7(default)
: 278/IRQ5

PWRON After PWR-Fail

: Off
: On
: Former-Sts

Game Port Address

: Disabled
: 201(default)
: 209

Midi Port Address

: Disabled
: 330(default)
: 300

Midi Port IRQ

: 10
: 5

3-1-5 Power Management Setup

CMOS Setup Utility – Copyright © 1984 – 1999 Award Software
Power Management Setup

ACPI Suspend Type	S1(POS)	Item Help
Power Management	User Define	
Video Off Method	DPMS	Menu Level →
Video Off In Suspend	YES	
Suspend Type	Stop Grant	
Suspend Mode	Disabled	
HDD Power Down	Disabled	
Soft-Off by PWRBTN	Delay 4 Sec	
Resume by Alarm	Date(of Month)	
Alarm		
Time(hh:mm:ss) Alarm		
** Reload Global Timer Events **		
Primary IDE 0	Disabled	
Primary IDE 1	Disabled	
Secondary IDE 0	Disabled	
Secondary IDE 1	Disabled	
FDD, COM, LPT Port	Disabled	
PCI PIRQ [A-D]#	Disabled	
↑↓←→Move Enter: Select +/-/PU/PD: Value F10:Save ESC: Exit F1:General Help F5:Previous Values F6:Fail-safe defaults F7:Optimized Defaults		

Power Management

:User Define(default)--users can configure their own power management

:Min Saving

:Max Saving

Video Off Method

:DPMS(default)

:Blank Screen

:V/H Sync+Blank

Video Off In Suspend

: Yes (default)

: No

MODEM Use IRQ

:3 (default)

:4, 5, 7, 9, 10, 11, NA

HDD Power Down

:Disabled(default), 1 min --- 15 min

Suspend mode

:Disabled(default), 1min --- 2 min, 4 min, 8 min, 12 min, 20 min, 30 min, 40 min,
1 Hour

3-1-6 PNP / PCI Configuration Setup

CMOS Setup Utility – Copyright © 1984-1999 Award Software
PnP/PCI Configurations

PnP OS Installed	No	Item Help
Reset Configuration Data	Disabled	-----
Resources Controlled By	Auto(ESCD)	Menu Level ➤
➤ IRQ Resources	Press Enter	Default is Disabled. Select
➤ DMA Resources	Press Enter	Enabled to reset Extended
➤ Memory Resources	Press Enter	System Configuration Data(ESCD)
PCI/VGA Palette Snoop	Disabled	when you exit Setup if you have
		installed a new add-on and the
		system reconfiguration has
		caused such a serious conflict
		that the OS cannot boot
↑↓←→Move Enter: Select +/-/PU/PD: Value F10:Save ESC: Exit F1:General Help F5:Previous Values F6:Fail-safe defaults F7:Optimized Defaults		

PnP OS Installed

:No(default)

OS will not recognize PnP devices.

:Yes

OS will arrange the setup of PnP devices.

Reset Configuration Data

:Disabled(default)

:Enabled--- to reset “**Extended System Configuration Data(ESCD)** when you exit setup if you have installed a new add-on card and the system reconfiguration has caused such a serious conflict that the operating system can not boot up.

Resources Controlled By

:Manual

The table will show the below items: “**Reset Configuration Data, IRQ-3 assigned to, DMA-0 assigned to.**” The user can adjust the shown items as required.

:Auto(default)

The table will not show the above items, and the system will automatically assign the above setup.

PCI/VGA Palette Snoop

:Disabled(default)

:Enabled

3-1-7 Frequency/Voltage Control

CMOS Setup Utility – Copyright © 1984-1999 Award Software
Frequency/Voltage Control

Auto Detect DIMM/PCI CIK	Enabled	Item Help
Spread Spectrum	Disabled	-----
CPU Host/PCI Clock	Default	Menu Level ➤
CPU Ratio	x 3	
↑↓←→Move Enter: Select +/-/PU/PD: Value F10:Save ESC: Exit F1:General Help F5:Previous Values F6:Fail-safe defaults F7:Optimized Defaults		

Auto Detect DIMM/PCI CIK

: Enabled(default)

: Disabled

Spread Spectrum

: Enabled

: Disabled(default)



selection is reserved for manufacturers to pass CE test only not available for users.

3-1-8 PC Health Status

CMOS Setup Utility – Copyright © 1984-1999 Award Software
PC Health Status

Voltage 0	1.984 V	Item Help
Voltage 1	1.792 V	-----
Voltage 2	3.376 V	Menu Level ➤
Voltage 3	4.972 V	
Voltage 4	11.840V	
Voltage 5	(□)10.881V	
Voltage 6	(□)4.906V	
Voltage 7	4.892V	
Voltage Battery	3.344V	
CPU Temperature	44°C	
Fan 1 Speed	5273RPM	
Fan 2 Speed	0 RPM	
Fan 3 Speed	0 RPM	
↑↓←→Move Enter: Select +/-PU/PD: Value F10:Save ESC: Exit F1:General Help F5:Previous Values F6:Fail-safe defaults F7:Optimized Defaults		

Current CPU Temperature, Current CPU Fan1 speed/CPU Fan2 speed/Current Vin3(V)/Vin1(V)/VIN(2)/Vdd(V):

System will automatically detect the above items and show the status.



Time, Date, Hard Disk Type

Step 2: Confirm Password
Typing the password again and pressing <Enter> .

CMOS Setup Utility - Copyright (C) 1984-1999

Standard CMOS Feature	Load Fail-Safe Defaults
Advanced BIOS Feature	Load Optimized Defaults
Advanced Chipset Feature	<u>Set Supervisor Password</u>
Integrated Periph	ssword
Power Managem	CONFIRM PASSWORD: Setup
PnP/PCI Configurations	Exit Without Saving
Frequency/Voltage Control	
PC Health Status	
Esc : Quit ↑ ↓ ← → : Select Item	
F10 : Save & Exit Setup	
Time, Date, Hard Disk Type	



If you forget password, please clear CMOS.
(refer to jumper RTC1)

Step 3: Set “Security Option” in “BIOS Features Setup”

After setting password, enter “Security Option” in “BIOS Features Setup.” There are 2 options “Setup” & “System.” “Setup” will only secure CMOS setup through password. “System” is to secure PC system and password is required during system boot-up in addition to CMOS setup.



2. How to Disable “Supervisor Password” & “User Password”

Step 1: Go to CMOS Setup Menu (need to key in password first)

Step 2: Enter “Supervisor Password” or “User Password”

After enter, it shows “Enter Password.” Press the <Enter> key instead of entering a new password when "ENTER PASSWORD" appears. It will inform “PASSWORD DISABLED PRESS ANY KEY TO CONTINUE.” Thus, press any key as instructed to disable the password.

CMOS Setup Utility - Copyright (C) 1984-1999

Standard CMOS Feature	Frequency/Voltage Control
Advanced BIOS Feature	Load Fail-Safe Defaults
Advanced Chipset Feature	Load Optimized Defaults
Integrated P	<u>PASSWORD DISABLED !!!</u> <u>PRESS ANY KEY TO CONTINUE</u>
Power Manag	
PnP/PCI Configurations	Save & Exit Setup
PC Health Status	Exit Without Saving
Esc : Quit	↑↓←→ : Select Item
F10 : Save & Exit Setup	
Time, Date, Hard Disk Type	

3-1-10 Load Fail-Safe Defaults

CMOS Setup Utility - Copyright (C) 1984-1999

Standard CMOS Feature	Frequency/Voltage Control
Advanced BIOS Feature	Load Fail-Safe Defaults
Advanced Chipset Feature	Load Optimized Defaults
Integrated Peripherals	Set User Password
Power Management	Save & Exit Setup
PnP/PCI Configurations	Exit Without Saving
PC Health Status	
Esc : Quit ↑ ↓ ← → : Select Item	
F10 : Save & Exit Setup	
Time, Date, Hard Disk Type	

"Load Fail-Safe Defaults" loads optimized settings which are stored in the BIOS ROM. The auto-configured settings only affect **"BIOS Features Setup"** and **"Chipset Features Setup"** screens. There is no effect on the standard CMOS setup. To use this feature, highlight it on the main screen and press the <Enter> key. A line will appear on screen asking if you want to load the setup default values. Press the <Y> key and then press the <Enter> key. The setup defaults will then load. Press <N> if you don't want to

3-1-11 Load Optimized Defaults

CMOS Setup Utility - Copyright (C) 1984-1999

Standard CMOS Feature	Frequency/Voltage Control
Advanced BIOS Feature	Load Fail-Safe Defaults
Advanced Chipset Feature	Load Optimized Defaults
Integrated Peripherals	Set User Password
Power Management	Save & Exit Setup
PnP/PCI Configurations	Exit Without Saving
PC Health Status	
Esc : Quit	↑↓←→ : Select Item
F10 : Save & Exit Setup	
Time, Date, Hard Disk Type	

"**Load Optimized Defaults**" loads optimized settings which are stored in the BIOS ROM. The auto-configured settings only affect “**BIOS Features Setup**” and “**Chipset Features Setup**” screens. There is no effect on the standard CMOS setup. To use this feature, highlight it on the main screen and press the **<Enter>** key. A line will appear on screen asking if you want to load the setup default values. Press the **<Y>** key and then press the **<Enter>** key. The setup defaults will then load. Press **<N>** if you don't want to

Chapter 4 Appendix

4-1 Memory Map

Address range	Size	Description
00000-7FFFF	512K	Conventional memory
80000-9FBFF	127K	Extended conventional memory
9FC00-9FFFF	1K	Extended BIOS data area if PS/2 mouse is installed
A0000-C7FFF	160K	Available for hi DOS memory
C8000-DFFFF	96K	Available for hi DOS memory and adapter ROMs
E0000-EEFFF	60K	Available for UMB
EF000-EFFFF	4K	Video service routine for monochrome & CGA adapter
F0000-F7FFF	32K	BIOS CMOS setup utility
F8000-FCFFF	20K	BIOS runtime service routine (2)
FD000-FDFFF	4K	Plug and play escd data area
FE000-FFFFF	8K	BIOS runtime service routine (1)

4-2 I/O Map

000-01F	DMA controller (master)
020-021	Interrupt controller (master)
022-023	Chipset control registers. I/O ports
040-05F	Timer control registers
060-06F	Keyboard interface controller (8042)
070-07F	RTC ports & CMOS I/O ports
080-09F	DMA register
0A0-0BF	Interrupt controller (slave)
0C0-0DF	DMA controller (slave)
0F0-0FF	Math coprocessor
1F0-1FB	Hard disk controller
278-27F	Parallel port 2
2B0-2DF	Graphics adapter controller
2F8-2FF	Serial port 2
360-36F	Network ports
378-37F	Parallel port 1
3B0-3BF	Monochrome & parallel port adapter
3C0-3CF	EGA adapter
3D0-CDF	CGA adapter
3F0-3F7	Floppy disk controller
3F8-3FF	Serial port-1

4-3 Time & DMA Channels Map

Time map:

- Timer channel 0 system timer interrupt
- Timer channel 1 DRAM refresh request
- Timer channel 2 speaker tone generator

Dma channels:

- DMA channel 0 available
- DMA channel 1 onboard ECP (option)
- DMA channel 2 floppy disk (ITE chip)
- DMA channel 3 onboard ECP (default)
- DMA channel 4 cascade for DMA controller 1
- DMA channel 5 available
- DMA channel 6 available
- DMA channel 7 available

4-4 Interrupt Map

A. NMI: non-maskable interrupt

B. IRQ(H/W):

- 0 system timer interrupt from timer 0
- 1. 1 keyboard output buffer full
- 2. cascade for IRQ 8-15
- 3. serial port2
- 4. serial port1
- 5. parallel port 2
- 6. floppy disk (ITE chip)
- 7. parallel port 1
- 8. RTC clock
- 9. available
- 10. available
- 11. available
- 12. PS/2 mouse
- 13. math coprocessor
- 14. onboard hard disk (IDE1) channel
- 15. onboard hard disk (IDE2) channel

4-5 RTC & CMOS RAM Map

00	Seconds
01	Seconds Alarm
02	Minutes
03	Minutes Alarm
04	Hours
05	Hours Alarm
06	Day of Week
07	Day of Month
08	Month
09	Year
0A	Status Register A
0B	Status Register B
0C	Status Register C
0D	Status Register D
0E	Diagnostic Status Byte
0F	Shutdown Byte
10	Floppy Disk Type Drive Type Byte
12	Hard Disk Type Byte
13	Reserved
14	Equipment Type
15	Base Memory Low Byte
16	Base Memory High Byte
17	Extension Memory Low Byte
18	Extension Memory High Byte
19-2D	
2E-2F	
30	Reserved for Extension Memory Low Byte
31	Reserved for Extension Memory High Byte
33	Information Flag
34-3F	Reserved
40-7F	Reserved for Chipset Setting Data

4-6 Award BIOS Hard Disk Type

Type	Cylinder	Heads	Write Pre-comp	Landing Zone	Sectors	Size
1	306	4	128	305	17	10MB
2	615	4	300	615	17	21MB
3	615	6	300	615	17	32MB
4	940	8	512	940	17	65MB
5	940	6	512	940	17	49MB
6	615	4	65535	615	17	21MB
7	462	8	256	511	17	32MB
8	733	5	65535	733	17	31MB
9	900	15	65535	901	17	117MB
10	820	3	65535	820	17	21MB
11	855	5	65535	855	17	37MB
12	855	7	65535	855	17	52MB
13	306	8	128	319	17	21MB
14	733	7	65535	733	17	44MB
16	612	4	0	663	17	21MB
17	977	5	300	977	17	42MB
18	977	7	65535	977	17	59MB
19	1024	7	512	1023	17	62MB
20	733	5	300	732	17	31MB
21	733	7	300	732	17	44MB
22	733	5	300	733	17	31MB
23	306	4	0	336	17	10MB
24	977	5	0	925	17	42MB
25	1024	9	65535	925	17	80MB
26	1224	7	65535	754	17	74MB

Type	Cylinder	Heads	Write Pre-comp	Landing Zone	Sectors	Size
27	1224	11	65535	754	17	117MB
28	1224	15	65535	699	17	159MB
29	1024	8	65535	823	17	71MB
30	1024	11	65535	1023	17	98MB
31	918	11	65535	1023	17	87MB
32	925	9	65535	926	17	72MB
33	1024	10	65535	1023	17	89MB
34	1024	12	65535	1023	17	106MB
35	1024	13	65535	1023	17	115MB
36	1024	14	65535	1023	17	124MB
37	1024	2	65535	1023	17	17MB
38	1024	16	65535	1023	17	142MB
39	918	15	65535	1023	17	119MB
40	820	6	65535	820	17	42MB
41	1024	5	65535	1023	17	44MB
42	1024	8	65535	1023	17	68MB
43	809	6	65535	852	17	42MB
44	809	9	65535	852	17	64MB
45	776	8	65535	775	17	104MB
46	AUTO	0	0	0	0	
47	USER'S	TYPE				

4-7 ISA I/O Address Map

I/O Address (HEX)	I/O device
000 - 01F	DMA Controller 1, 8237A-5
020 - 03F	Interrupt Controller 1, 8259A
040 - 05F	System Timer, 8254-2
060 - 06F	8042 Keyboard Controller
070 - 07F	real-time Clock/CMOS and NMI Mask
080 - 09F	DMA Page Register, 74LS612
0A0 - 0BF	Interrupt Controller 2, 8259A
0C0 - 0DF	DMA Controller 2, 8237A-5
0F0 - 0FF	i486 Math Coprocessor
1F0 - 1F8	Fixed Disk Drive Adapter
200 - 207	Game I/O
20C - 20D	Reserved
21F	Reserved
278 - 27F	Parallel Printer Port 2
2B0 - 2DF	Alternate Enhanced Graphic Adapter
2E1	GPIB Adapter 0
2E2 - 2E3	Data Acquisition Adapter 0
2F8 - 2FF	Serial Port 2 (RS-232-C)
300 - 31F	Prototype Card
360 - 363	PC Network (Low Address)

I/O Address (HEX)	I/O device
364 - 367	Reserved
368 - 36B	PC Network (High Address)
36C - 36F	Reserved
378 - 37F	Parallel Printer Port 1

I/O Address (HEX)	I/O device
380 - 38F	SDLC, Bisynchronous 2
390 - 393	Cluster
3A0 - 3AF	Bisynchronous 1
3B0 - 3BF	Monochrome Display and Printer Adapter
3C0 - 3CF	Enhanced Graphics Adapter
3D0 - 3DF	Color/Graphics Monitor Adapter
3F0 - 3F7	Diskette Drive Controller
3F8 - 3FF	Serial Port 1 (RS-232-C)
6E2 - 6E3	Data Acquisition Adapter 1
790 - 793	Cluster Adapter 1
AE2 - AE3	Data Acquisition Adapter 2
B90 - B93	Cluster Adapter 2
EE2 - EE3	Data Acquisition Adapter 3
1390 - 1393	Cluster Adapter 3
22E1	GPIB Adapter 1
2390 - 2393	Cluster Adapter 4
42E1	GPIB Adapter 2
62E1	GPIB Adapter 3
82E1	GPIB Adapter 4
A2E1	GPIB Adapter 5
C2E1	GPIB Adapter 6
E2E1	GPIB Adapter 7

Chapter 5 Q & A

5-1 Error Messages During Power on Self Test

During **power on self test (post)**, BIOS will automatically detect the system devices. Below are the questions that users may always meet. The user may press “**Esc**” key to skip the full memory test.

1. Beep sound

On power on, the system make beep sound to offer different messages. If the system is configured correctly, it prompts a short beep to show correct devices configuration is done correctly. When VGA card and DIMM modules are not plugged well, the system makes longer and constant beep sounds.

2. BIOS ROM checksum error

It indicates the checksum of the BIOS code is not right and system will always halt on power on screen. Contact the dealer to exchange a new BIOS.

3. CMOS battery fails

It indicates the CMOS battery does not work. Contact the dealer to exchange a new battery.

4. *CMOS checksum error*

It indicates the CMOS checksum is incorrect. Load the default values in BIOS to solve this problem. This error may result from a weak BIOS, so replace a new BIOS if necessary.

5. *Hard disk initialize*

Please wait a moment...

Some hard drives require more time to initialize.

6. *Hard disk install failure*

The system can not find or initialize the hard drive controller or the drive. Check if the controller is set correctly. If no hard disk is installed, “**Hard drive selection**” must be set to “**none.**”

7. *Keyboard error or no keyboard present*

This means the system can not initialize the keyboard. Check if the keyboard is plugged well and be sure no keys are pressed during POST.

8. *Keyboard is lock out- Unlock the key*

When this message comes out, check if there is anything mis-placed on the keyboard. Be sure nothing touches the keys.

9. *Memory test fails*

There will be more information to specify the type and location of the memory error.

10 *Primary master hard disk fail*

The BIOS find an error in the primary master hard disk drive.

11 *Primary slave hard disk fail*

The BIOS finds an error in the primary slave hard disk drive.

12 *Secondary master hard disk fail*

The BIOS finds an error in the secondary slave master hard disk drive.

13 *Secondary slave hard disk fail*

The BIOS finds an error in the secondary slave IDE hard disk drive.