

# 865 Dynasty

---

## **MAINBOARD**

### **MANUAL**

**P4-865PE MAX**

**P4-865PE Pro**

**P4-865P Ultra**

DOC No.: M03201

Rev. :A1

Date : 5, 2003

Part No. : 25-11241-01

## Table of Contents

### Chapter 1 Overview

Package Checklist .....	1-2
P4-865PE MAX	
P4-865PE Pro	
P4-865P Ultra .....	1-3
Main Features .....	1-4
FIC Unique Innovation for Users (NOVUS) - Enhanced Mainboard Features and System Support .....	1-6

### Chapter 2 Installation Procedures

1). Set System Jumpers .....	2-2
Clear CMOS .....	2-2
2). Install Memory Modules .....	2-3
3). Install the CPU .....	2-4
Connect ATX Power .....	2-5
4). Install Expansion Cards .....	2-6
5). Connect Devices .....	2-8
Floppy Diskette Drive Connector .....	2-8
IDE Device Connectors .....	2-8
Fan Connectors .....	2-9
Power Connectors .....	2-9
Front Panel Block, Power LED, IR, and Speaker Connector	2-10
Serial ATA Connectors .....	2-11
CD Audio-In Connector .....	2-12
1394 Connectors (optional) .....	2-12
PS/2 Keyboard and Mouse Connector .....	2-13
RJ45 LAN Connector .....	2-13
Serial Port Connectors .....	2-14
Printer Connector .....	2-14
Audio I/O Jacks .....	2-15
Front Audio Connector .....	2-15
5.1 Audio Channel Feature .....	2-16
Universal Serial Bus Connectors .....	2-17

**Chapter 3 BIOS Setup**

CMOS Setup Utility .....	3-1
Standard CMOS Setup .....	3-2
Advanced BIOS Features .....	3-4
Advanced Chipset Features .....	3-8
Integrated Peripherals .....	3-10
Power Management Setup .....	3-13
PnP/PCI Configurations .....	3-17
PC Health Status .....	3-18
Frequency/Voltage Control .....	3-19
Load Fail-Safe Defaults .....	3-20
Load Optimized Defaults .....	3-20
Supervisor/User Password .....	3-20
Save and Exit Setup .....	3-22
Exit without Saving .....	3-22

## Overview

The new ATX, 478-pin 1stMainboard® supports a full range of the latest generation Intel® Pentium® 4 processors. The leading edge Intel® chipset was designed for coworking with Pentium® 4 (up to 3.06 GHz) in the 478-pin package based on the VRM 10.0 spec and 400/533/800 MHz (865P supports 400/533 MHz ; 865PE supports all three). Built using the leading edge technology the Intel Pentium® 4 processors provide a significant performance over previous Pentium® III processors. Four DDR 266/333/400 (865P supports DDR 266/333; 865PE supports all three) SDRAM sockets allow for up to 4 GB memory capacity. Support for the Ultra DMA/100 protocol and its high-speed interface further ensures that data transfer speeds are improved, especially for long sequential transfers required by audio/visual applications.

The board features onboard audio and LAN function; also, the serial ATA feature replaces the standard parallel ATA physical storage interface and allows future enhancements to the computing platform. It completely software compatible with parallel ATA, requiring no modification to your operating system. The onboard serial ATA feature includes RAID function (depends on South Bridge) to provide you with a more efficient storage backup. For more detail, please read the help file in the 1st Utilities CD.

The 1stMainboard comes with a versatile range of I/O features such as 2 serial ports, 2 serial ATA ports, 1 parallel port, 1 LAN, 2 optional IEEE 1394, 1 PS/2 mouse and keyboard connector, 8 USB ports, 5.1 audio channel, 1 media connector (front audio, Line-in, Line-out and Mic-in). In addition, the board is equipped with 2 dual channel enhanced PCI bus master IDE connectors. Ample expansion is available through 5 PCI and 1 AGP to meet the requirement for enjoying the P4 CPU benefits in internet applications, video/3D graphics performance, and so forth.

Other key features are Remote On/Off, Auto Power Failure Recovery, integrated temperature monitoring and system fan control. Included also is 1st Utilities CD with enhanced drivers and a few bundled software solutions.

## Package Checklist

If you discover any item below was damaged or lost, please contact your vendor.

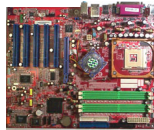

**Mainboard**



**Floppy Drive Cable**



**80-Pin IDE Ribbon Cable**



**USB Cable**



**SATA Power Cable (top)  
SATA Data Cable (bottom)  
(optional)**



**EZ Guide**



**Manual**



**Drivers**



**I/O Shielding**



**A73 Audio Bracket with Cable  
(optional)**



**1394 Bracket with Cable  
(optional)**



**NOTE: Ist Utilities** CD that contains patch files, onboard video/audio chip drivers, related online help and other useful information can be found in your mainboard package.

*Please install it right after your Windows operating system installation is done.* Place your Ist Utility in the drive, an operating menu will appear in your monitor. Please select *Auto Installation*. It will automatically detect which software tools (patch files, drivers) that the mainboard needs. Press **OK** button to go through the whole installation procedure in a very straight forward and easy way. It also provides you with a custom way to select wanted patch files and software drivers that for onboard chips use. **The top menu of Ist Utilities lists all the functions that allowed by this board.**

**P4-865PE MAX**  
**P4-865PE Pro**  
**P4-865P Ultra**

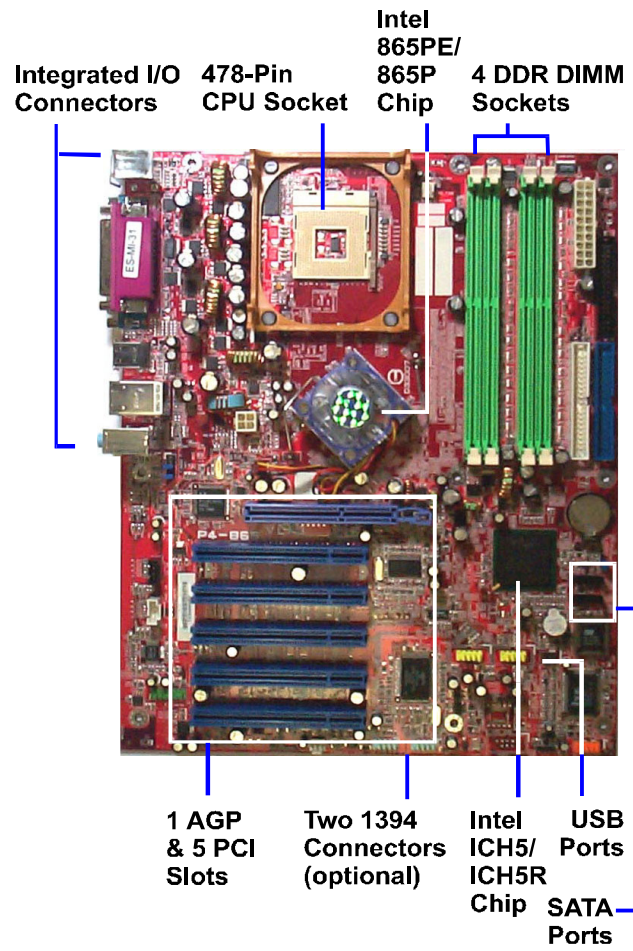

## Main Features

### ■ CPU

Celeron 1.4G to 2.4GHz and up\* (865PE / 865P supports FSB 400)  
2.0 to 2.8GHz and up\* (FSB 533) (865PE / 865P supports FSB 533)  
3.06GHz and up\* (FSB 800) (only 865PE supports FSB 800)  
(\*: not tested yet)

### ■ Chipset

North Bridge: *Intel® 865PE/865P*  
South Bridge: *Intel® ICH5/ICH5R*

### ■ Memory

support 184-pin DDR 266/333/400 MHz  
(865PE/865P supports DDR266/333; only 865PE supports DDR400)  
memory size totally up to 4 GBs

### ■ Expansion Slots

AGP Slot : support 3.0 4X/8X (0.8/1.5V);  
5 PCI Slots

### ■ IDE Connections

2 IDE connectors - PIO mode, Ultra DMA 66/100  
up to 4 devices

### ■ SATA Connections

2 ports controlled by embeded ICH5/ICH5R® SATA function  
level 0/1 RAID functions (only ICH5R supports RAID)

### ■ Audio Features

Realtek ALC650 controller  
AC97 2.2 compliant  
LINE\_IN, LINE\_OUT, MICROPHONE\_IN Jack  
5.1 audio channel  
A73 audio bracket with cable (*optional*)  
front audio pinheaders

- **I/O Ports**
  - 2 IDE connectors -  
PIO, Bus Master, Ultra DMA 66/100  
up to 4 devices
  - 2 serial ports COM1 and COM2
  - 1 parallel port
  - PS/2 mouse and PS/2 keyboard
  - 8 USB 1.1/2.0 ports
  
- **LAN**
  - RTL8100BL® 10/100 Ethernet
  
- **IEEE 1394 Ports** *(optional)*
  - Agere FW323
  - 2 ports
  - 1 bracket with cable
  
- **Mounting Holes**
  - 9 holes
  
- **Mainboard Size**
  - 12 x 9.6 (unit: inch)



## **FIC Unique Innovation for Users (NOVUS) - Enhanced Mainboard Features and System Support**

- LogoGenie

A user friendly GUI supporting Windows 95/98SE (not Windows 2000/NT/ME/XP), LogoGenie allows you to customize, create or select a Logo which will be displayed when the system is booting.



**NOTE:**

Please read Page 3-7 for detail information.

- BIOS Guardian

BIOS Guardian effectively acts as a fire-wall against viruses that can attack the BIOS while the system is running and by default is enabled.



**WARNING:**

BIOS Guardian must be disabled before reflash BIOS.



**NOTE:**

Please read Page 3-7 for detail information.

- Easy Key

Instead of completing the multi-layered BIOS setup process these 3 Easy Key functions provide direct access to Sub-Menu when completing BIOS settings adjustments.

Easy-Keys are as follows:

**Ctrl + c:** To enter clock settings menu.

**Ctrl + p:** To load Performance Default settings and restart.

**Ctrl + f:** To load Fail-Safe Default settings and restart.

## Installation Procedures

The mainboard has several user-adjustable jumpers on the board that allow you to configure your system to suit your requirements. This chapter contains information on the various jumper settings on your mainboard.

To set up your computer, you must complete the following steps:

- Step 1 - Set system jumpers
- Step 2 - Install memory modules
- Step 3 - Install the Central Processing Unit (CPU)
- Step 4 - Install expansion cards
- Step 5 - Connect ribbon cables, cabinet wires, and power supply
- Step 6 - Set up BIOS software
- Step 7 - Install supporting software tools



**WARNING:** Excessive torque may damage the mainboard. When using an electric screwdriver on the mainboard, make sure that the torque is set to the allowable range of 5.0 ~ 8.0kg/cm.

Mainboard components contain very delicate Integrated Circuit (IC) chips. To prevent static electricity from harming any of the sensitive components, you should follow the following precautions whenever working on the computer:

1. Unplug the computer when working on the inside.
2. Hold components by the edges and try not to touch the IC chips, leads, or circuitry.
3. Wear an anti-static wrist strap which fits around the wrist.
4. Place components on a grounded anti-static pad or on the bag that came with the component whenever the components are separated from the system.

## 1). Set System Jumpers

### *Clear CMOS*

The CMOS RAM is powered by the onboard button cell battery. To clear the RTC data:

- (1) Turn off your computer;
- (2) open the system case, disconnect the ATX power cable;
- (3) place the jumper cap onto the pinpair 2-3 at least 6 seconds to enable CMOS clearance;
- (4) place the jumper cap onto the pinpair 1-2 to disable the effect of CMOS clearance;
- (5) connect the ATX power cable; close the system case;
- (6) turn on your computer until *CMOS checksum error* appears;
- (7) hold down the *Delete* key when boots;
- (8) enter the BIOS Setup to re-enter user preferences.

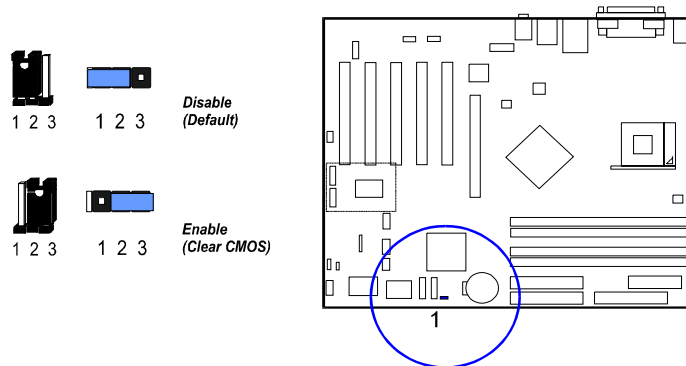

**NOTE:** Users are not encouraged to change the jumper/switch settings not listed in this manual. Changing the settings improperly may adversely affect system performance.

## 2). Install Memory Modules

1. Locate DDR DIMM sockets on the mainboard.

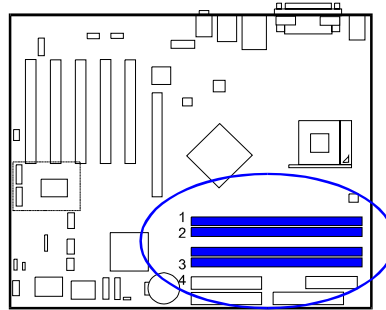
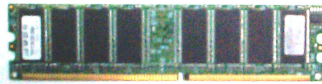

2. Install DDR DIMM straight down into the socket 1 using both hands, then socket 2, and so forth.

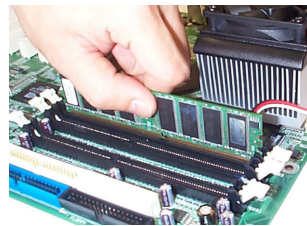

3. The clip on both ends of the socket will close up to hold the DDR DIMM in place when the DDR DIMM reaches the socket bottom.

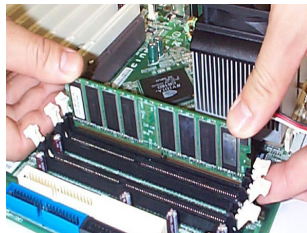

**NOTE:**

1. To enable dual channel, it must be same density (128/256MB, etc.); same technology (128/256Mb, etc.); same bus width (x8, x16); both single- (or dual-) sided; installed on symmetrical memory slots.

2. If your system uses an 800MHz CPU with DDR333 memory, the memory interface of the chipset will runs at 320MHz.

Press the clips with both hands to remove the DIMM.

### 3). Install the CPU

The mainboard has built-in Switching Voltage Regulator to support CPU Vcore autodetection. That is, It has the ability to detect and recognize the CPU voltage, clock, ratio and enables users to set up the CPU frequency from the BIOS Setup Screen. Users can adjust the frequency through *Frequency / Voltage Control* of the BIOS Setup Screen.

**Chapter 2**  
**Installation**  
**Procedures**

The procedures below shows you how to install your CPU and its fan and heatsink. First of all, locate the CPU socket on this mainboard.

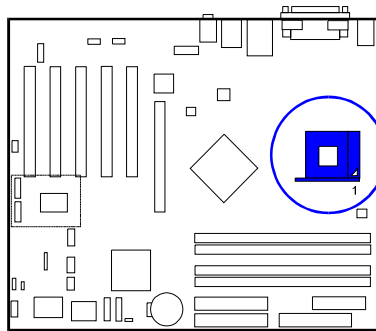

1. Swing the lever upward to 90 degree.
2. Install the CPU and make sure the the pin 1 orientation by aligning the socket corner marking with the socket corner closest to the lever tip. Do not insert the CPU by force. Make sure the processor is fully inserted into the socket on all sides.

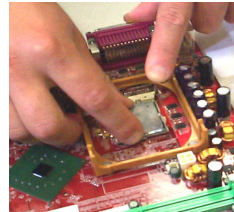

Apply some thermal materials, such as paste or tape, on the CPU top; and install a fan with heatsink that approved by CPU manufacturer to avoid CPU damage. For detail information, please refer to the CPU manufacturer website.

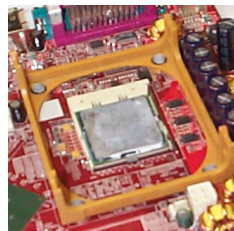

Affix the CPU by pressing the lever downward and locking it beside the socket.

3. Place the fan with heatsink on the CPU top and press down two plastic clips to hook up with the holes on the retention module on two sides.

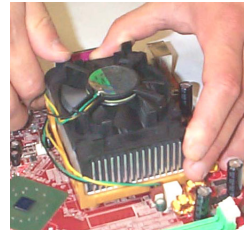

4. Press down the white bar on each clip to fasten the fan set on the retention module.

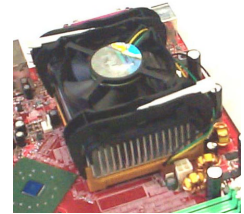

Chapter 2  
Installation  
Procedures

### Connect ATX Power

The 20-hole power plug (top right) is connected to the ATX power 20-pin pinheaders. The 4-hole 12V power plug (bottom right) is inserted in the ATX\_12V power connector.

The plug from the power supply will only insert in one orientation because of the different hole sizes. Find the proper orientation and push down firmly making sure that the pins are aligned.

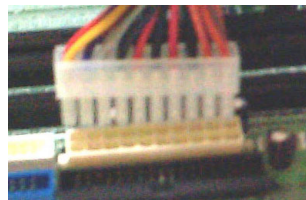
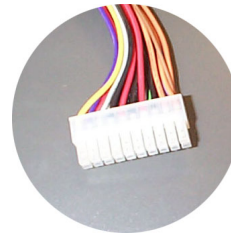

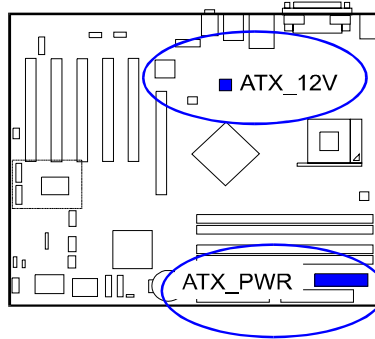

**NOTE:** Users The CPU installing procedures should be:

1. Insert the CPU (with its fansink and retention module) on the socket.
  2. Connect the 4-pin plug of the power supply
  3. Connect the 20-pin plug of the power supply.
- To remove the processor, please do it in reverse order.

## 4). Install Expansion Cards

This section describes how to connect an expansion card to one of your system expansion slots.

Expansion cards are printed circuit boards that, when connected to the mainboard, increase the capabilities of your system.

For example, expansion cards can provide video and sound capabilities. The mainboard features one AGP and five PCI bus expansion slots.



**CAUTION:**

1. Make sure to unplug the power supply when adding or removing expansion cards or other system components. Failure to do so may cause severe damage to both the mainboard and expansion cards.
2. Always observe static electricity precautions.
3. Please read Handling Precautions at the start of this manual.

1. Select an available expansion slot.

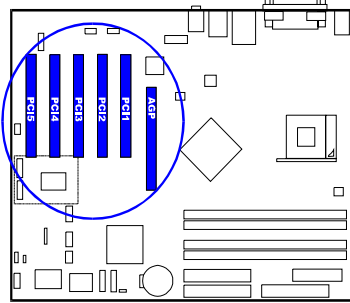

2. Remove the corresponding slot cover from the computer chassis. Unscrew the mounting screw that secures the slot cover and pull the slot cover out from the computer chassis. Keep the slot cover mounting screw nearby.

3. Push the card firmly into the slot. Push down on one end of the expansion card, then the other. Use this rocking motion until the card is firmly seated inside the expansion slot. Secure the card with the screw removed in Step 2.

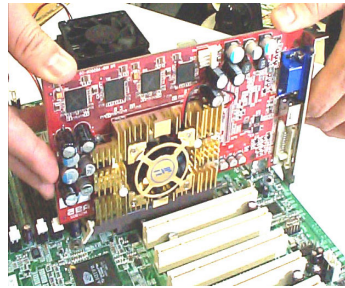



## 5). Connect Devices

### *Floppy Diskette Drive Connector*

This connector provides the connection with your floppy disk drive.

Insert the floppy ribbon cable (below) onto the floppy connector.

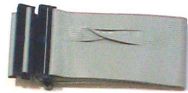

The colored stripe (indicated by the arrow head, right) of the ribbon cable must be the same side with the Pin 1.

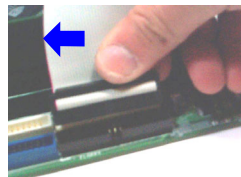
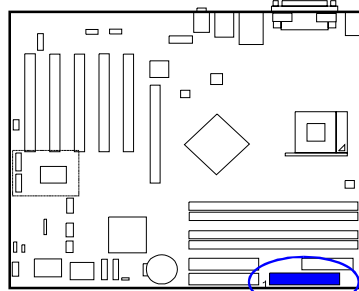

### *IDE Device Connectors*

The two connectors, IDE1 (PRIMARY) and IDE2 (SECONDARY), are used for your IDE hard disk drives, CD drives, LS-120 drives, or IDE ZIP drives.

Insert the floppy ribbon cable (below) onto the floppy connector.



The colored stripe (indicated by the arrow head, right) of the ribbon cable must be the same side with the Pin 1.

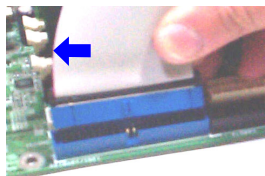
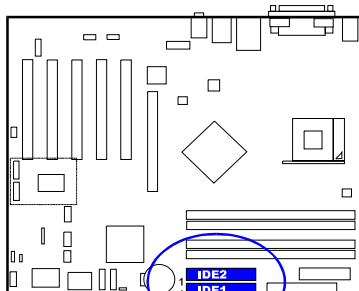

### Fan Connectors

The two connectors, CPU\_FAN, SYS\_FAN are linked to the CPU fan, case fan, respectively. CHIP\_FAN can be used with North Bridge chip fan.

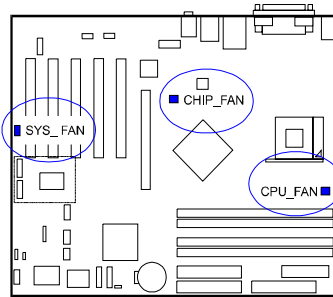
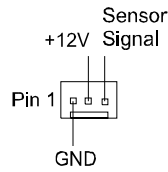

**Chapter 2  
Installation  
Procedures**

### Power Connectors

The 20-pin male block connector is connected to the ATX power supply. The 4-pin male block connector is for the ATX\_12V power use. All two connectors are linked with your ATX power supply. The plug from the power supply will only insert in one orientation because of the different hole sizes. Find the proper orientation and push down firmly making sure that the pins are aligned.

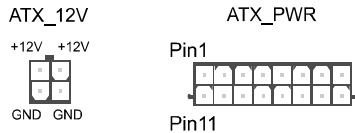

PIN	DEFINITION	PIN	DEFINITION
1	+3.3V	11	+3.3V
2	+3.3V	12	-12V
3	GND	13	GND
4	+5V	14	PS_ON
5	GND	15	GND
6	+5V	16	GND
7	GND	17	GND
8	PWR_GOOD	18	-5V
9	5V_SB	19	+5V
10	+12V	20	+5V

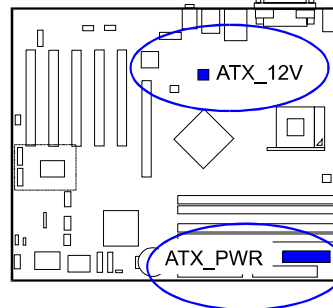

### Front Panel Block, Power LED, IR, and Speaker Connector

This block connector includes the connectors for linking with Power LED (3-pin), HDD LED, power button, power/sleep/message waiting button, reset button on the front panel of the system case. Please identify polarities of plug wires for the case speaker and LEDs. Please ask vendor about this information when you buy them and install the system by yourself. The plug wires (below) polarities of these buttons will not affect the function.

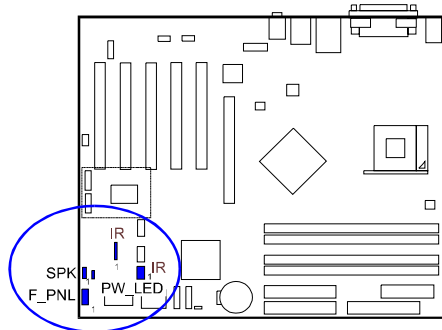

**F\_PNL**  
(Intel spec.)

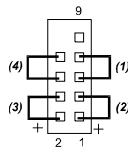

**IR**  
(Intel spec.)

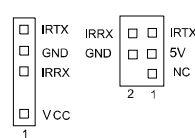

**SPK**  
(Speaker)



**PW\_LED**  
(Power LED, 2/3 pins)

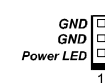

**NOTE:** Users that want to use IR port must adjust BIOS feature **UART Mode Select** to set COM2 at some IR mode upon your IR device.

**(1) Reset Switch** is connected to the reset button. Push this switch to reboot the system instead of turning the power button off and on.

**(2) HDD LED** is connected to the IDE device indicator. This LED will blink when the hard disk drives are activated.

#### **(3) Power (Single and Dual) /Sleep LED**

Please refer to the tables below for the representations of LED states.

There is another 3-Pin Power LED connector on board for some cases that with a 3-pin plug.

**Single-Color (2, 3 Pins)**

LED	Meaning	State
Off	Off	S4/S5
On	Full On	S0
Flash	Sleep	S1/S3

**Dual-Color**

LED	Meaning	State
Off	Off	S4/S5
Green	Full On	S0
Other Colors	Sleep	S1/S3

**(4) Power Button** is connected with power button. Push this switch allows the system to be turned on and off rather than using the power supply button.

**IR** is a pinheader that is used for linking with your ID device to allow transmission of data to another system that also supports the IR feature.

**Speaker** is connected with the case speaker.

**Chapter 2  
Installation  
Procedures**

**Serial ATA Connectors**

The 2 SATA connectors (SATA1/2) are controlled by Intel ICH5/ICH5R® provide you with the connections to serial ATA devices that conform to the Serial ATA specification. Serial ATA supports all ATA and ATAPI devices. The connectors allows two RAID hard disks for RAID (level 0/1) functions if ICH5R onboard. The figures below left are two SATA cables (the top one is for power; the next one is for data). The data cable pin assignments of SATA connector.

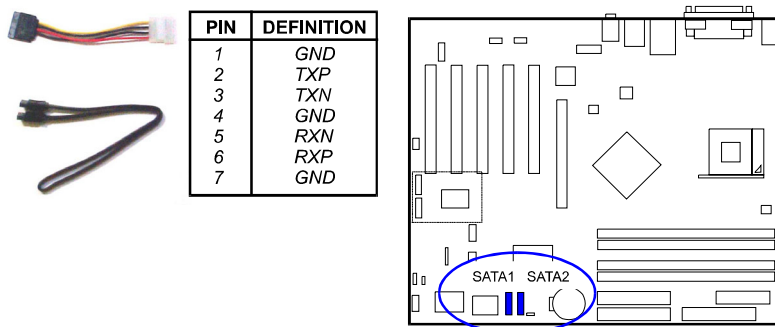

**NOTE:** Please read page 3-12 for more detail about the usage of SATA feature.

### CD Audio-In Connectors

The connectors, CD\_IN and AUX\_IN, are for CD-ROM drive audio analog input use.

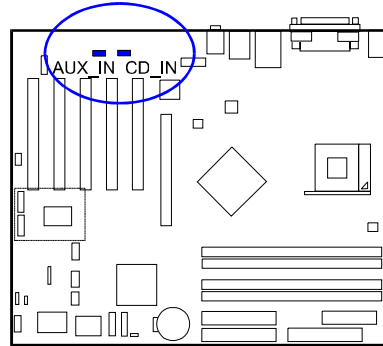
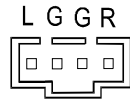

### 1394 Connectors (optional)

The 2 optional 1394 pinheaders on the board provides you with two connections with the peripherals which own 1394 connectors by an optional bracket with cable (see the figure below). The pin definitions of the 1394 pinheaders are listed below also.

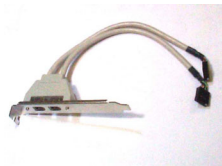

PIN	DEFINITION
1	TA1+
2	TA1-
3	GND
4	GND
5	TB1+
6	TB1-
7	VCC
8	VCC
9	GND
10	NC

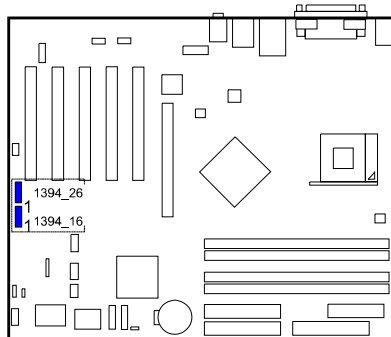

### ***PS/2 Keyboard and Mouse Connector***

These two 6-pin female (PS/2 keyboard is purple color and PS/2 mouse is green color) connectors are used for your PS/2 keyboard and PS/2 mouse.

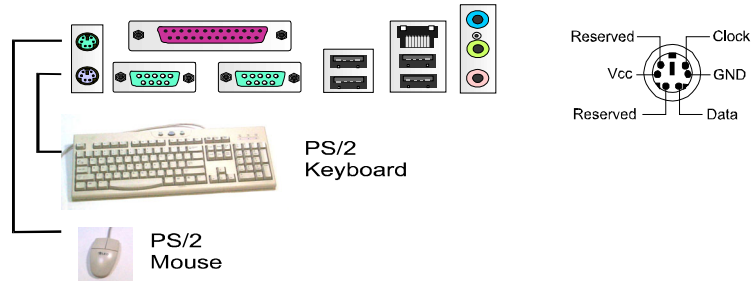

**Chapter 2  
Installation  
Procedures**

### ***RJ45 LAN Connector***

The LAN (RJ45 port) jack is used for the LAN cable plug.

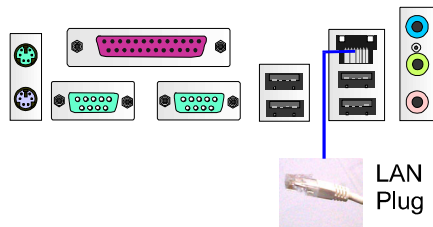

### Serial Port Connectors

COM1/2 (9-pin D-sub male connector with teal color) allow you to connect with your devices that use serial ports, such as a serial mouse or an external modem.

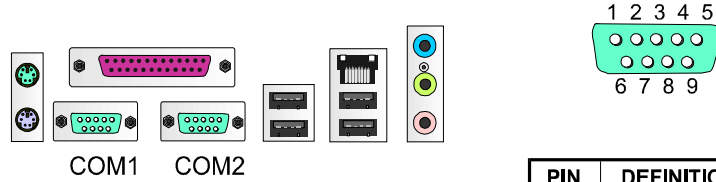

PIN	DEFINITION
1	DCD
2	SIN
3	SOUT
4	DTR
5	GND
6	DSR
7	RTS
8	CTS
9	RI

### Printer Connector

This 25-pin D-Sub female burgundy-colored connector is attached to your printer.

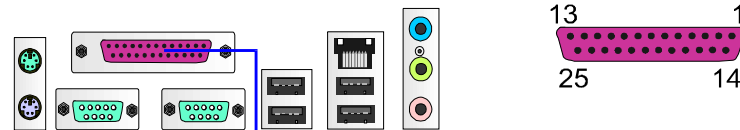

Printer

PIN	DEFINITION
1	STROBE
2 - 9	DATA 0 - 7
10	ACK#
11	BUSY
12	PE
13	SELECT
14	AUTO FEED#
15	ERR#
16	INIT#
17	SLIN#
18-25	GND

### Audio I/O Jacks

LINE\_OUT (lime) can be connected to headphones or preferably powered speakers. LINE\_IN (light blue) allows tape players or other audio sources to be recorded by your computer or played through the LINE\_OUT. MIC\_IN (pink) allows microphones to be connected for audio input.

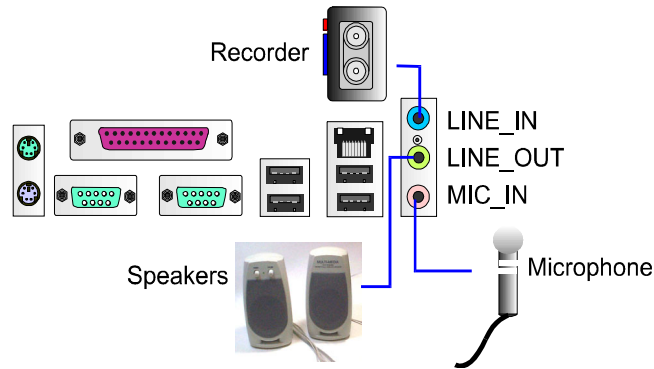

Chapter 2  
Installation  
Procedures

### Front Audio Connector

The mainboard has a front panel audio F\_AUDIO connector (Intel spec.). It allows users to attach the audio device via front panel (instead of rear panel) by a ribbon cable that in some cases. Its pin definitions are resented below.

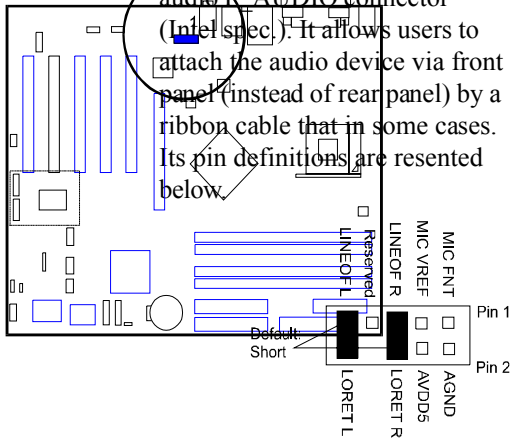

**NOTE:** If you do not use F\_AUDIO, please keep the pinpair 5-6, 9-10 short as default; also, when the front headphone is plugged in, the rear audio output will be disabled.



### 5.1 Audio Channel Feature

The 5\_1\_AUDIO sound feature are offered via the pinheaders with an optional A73 bracket with ribbon cable. The pinheaders pin assignments are shown below left.

**Chapter 2  
Installation  
Procedures**

PIN	DEFINITION
1	Front Out R
2	Rear Out R
3	Front Out L
4	Rear Out L
5	Center Out
6	Bass Out
7	AGND
8	
9	VCC
10	SPDIF Optical In
11	SPDIF Out
12	+12V
13	GND
14	SPDIF Coaxial In

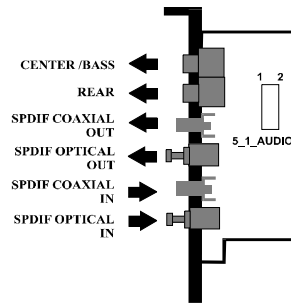
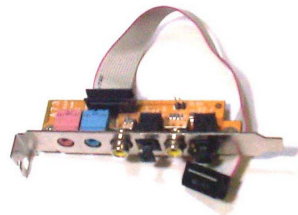
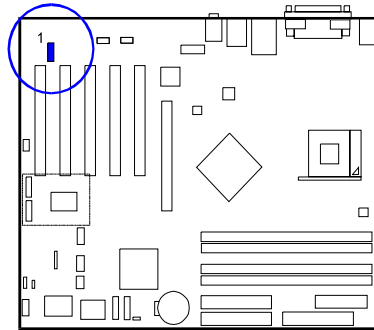

When use the daughter board, plug in the LINE\_OUT jack for the front speaker audio output (right and left).

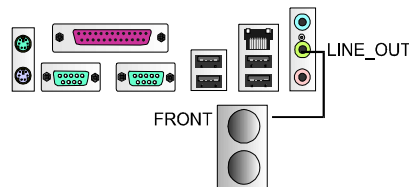

**NOTE:** If you do not have A73 bracket, the LINE\_IN, LINE\_OUT, MICROPHONE jacks can be used the 5.1-channel audio output with its software tool.

### Universal Serial Bus Connectors

The mainbaord have eight USB ports; four USB black jacks that integrated on the edge of the board, the other four USB ports on the board. They allows uses to attach with USB devices either from rear or front panels. The USB cable that comes with your mainboard is used to connecting between the USB pinheaders and rear panel. (See the photo below).

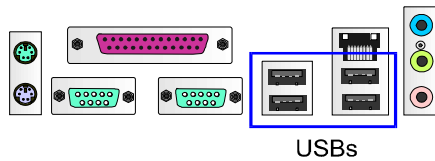

USBs

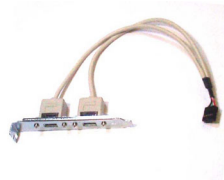

The figure below is the pin assignments of the USB4/5 and USB6/7.

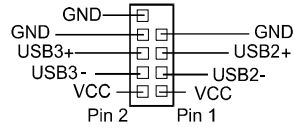
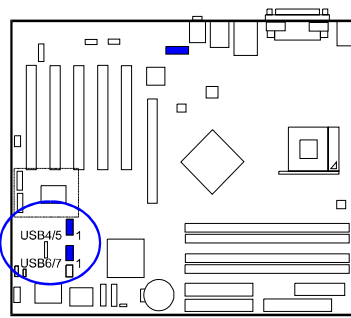

USB  
(Intel Spec.)

Chapter 2  
Installation  
Procedures

**This Page Left Blank for Note**

**Chapter 2  
Installation  
Procedures**

## BIOS Setup

The mainboard comes with the chip that Award BIOS that contains the ROM Setup information of your system. (This chip serves as an interface between the processor and the rest of the mainboard components.) This section explains the information contained in the Setup program and tells you how to modify the settings according to your system configuration.

### CMOS Setup Utility

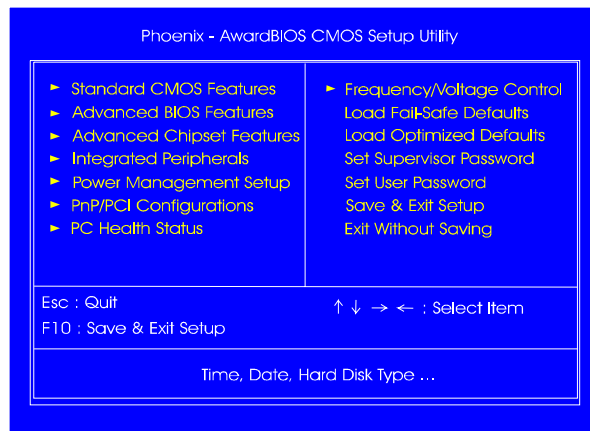

The Setup utility program allows updates to the mainboard configuration settings. The BIOS setup values will be saved in the CMOS. It is executed when the user changes system configuration; user changes system backup battery; or the system detects a configuration error and asks the user to run the Setup program. Use the arrow keys to select and press **Enter** to run the selected program.

## Standard CMOS Setup

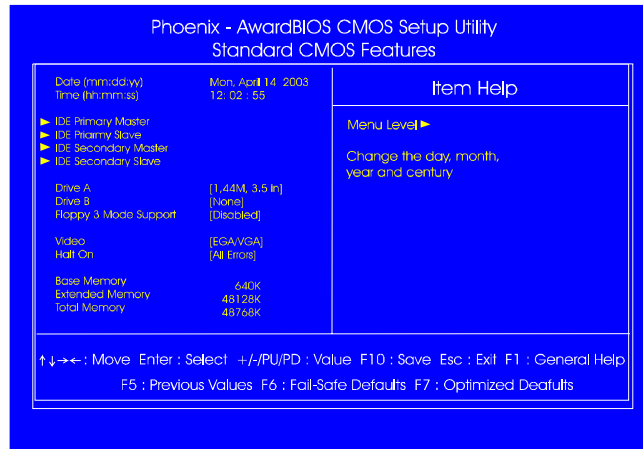

### Chapter 3 BIOS Setup

The Standard CMOS Setup screen is displayed above. Each item may have one or more option settings. The system BIOS automatically detects memory size, thus no changes are necessary. Use the arrow keys to highlight the item and then use **PgUp** or **PgDn** keys to select the value you want in each item.

#### Date

To set the date, highlight the *Date* field and then press **Page Up/Page Down** or **+/-** keys to set the current date. Follow the month, day and year format.

#### Time

To set the time, highlight the *Time* field and then press **Page Up/Page Down** or **+/-** keys to set the current time. Follow the hour, minute, and second format.

### Hard Disks

This field records the specifications for all non-SCSI hard drives installed in the system. The onboard PCI IDE connectors provide Primary and Secondary channels for connecting up to four IDE hard disks or other IDE devices. Each channel can support up to two hard disks, the first of which is the *Master* and the second is the *Slave*.

#### Hard Disk Configurations

<b>Capacity:</b>	The hard disk size. The unit is Bytes.
<b>Cylinder:</b>	The cylinder number of the hard disk.
<b>Head:</b>	The read/write head number of hard disk.
<b>Precomp:</b>	The cylinder number at which the disk drive changes the write current.
<b>Landing Zone:</b>	The cylinder number that the disk drive heads (read/write) are seated when the disk drive is parked.
<b>Sector:</b>	The sector number of each track defined on the hard disk.

### Drive A / Drive B

This field records the types of floppy drives installed in the system. To enter the configuration value for a particular drive, highlight its corresponding field and then select the drive type using the **left-** or **right-arrow** key.

### Floppy 3 Mode Support

This is a Japanese standard floppy type drive. The standard stores 1.2MB in a 3.5 inch diskette.

### Video

Set this field to the type of video display card installed in the system.

### Halt On

This field determines which types of errors will cause the system to halt.

## Advanced BIOS Features

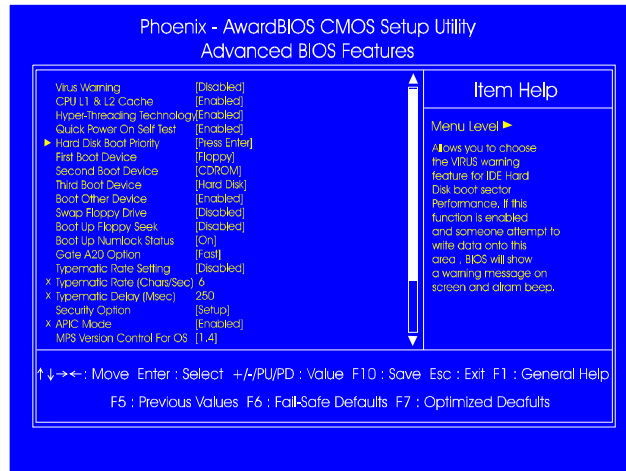

### Chapter 3 BIOS Setup

#### Virus Warning

This feature starts the virus scan tool to detect if boot virus in boot sector of the first hard disk drive when booting up. The options are: Enabled, Disabled.

#### CPU L1 & L2 Cache

When enabled, improves the system performance. Disable this item when testing or trouble-shooting. The options are: Enabled, Disabled.

#### Hyper-Threading Technology

When enabled, it performs as Hyper-Threading tech. does if the CPU support it. The options are: Enabled, Disabled.

#### Quick Power On Self Test

When enabled, allows the BIOS to bypass the extensive memory test. The options are: Enabled, Disabled.

#### Hard Disk Boot Priority

This feature will auto detect all hard disks of bootable device on the system. It also allows users to select hard disk device booting priority.

**First/Second/Third Boot Device**

This feature allows user to select the boot device priority. The options are: Floppy, LS120, Hard Disk, CDROM, ZIP100, USB-FDD, USB-ZIP, USB-CDROM, USB-HDD, LAN, Disabled.

**Boot Other Device**

This feature allows user to select the boot device priority. The options are: Enabled, Disabled.

**Swap Floppy Drive**

Allows you to switch the order in which the operating system accesses the floppy drives during boot up. Full Screen LOGO Show  
It decides whether or not the full screen logo is shown during system booting up. The options are: Enabled, Disabled.

**Boot Up Floppy Seek**

When enabled, assigns the BIOS to perform floppy diskette drive tests by issuing the time-consuming seek commands. The options are: Enabled, Disabled.

**Boot Up Numlock Status**

When set to On, allows the BIOS to automatically enable the Num Lock Function when the system boots up. The options are: On, Off.

**Gate A20 Option**

When set at Fast, allows a faster access response under Protected mode. The options are: Fast, Normal.

**Typematic Rate Setting**

The term typematic means that when a keyboard key is held down, the character is repeatedly entered until the key is released. The options are: Disabled, Enabled.

**Typematic Rate (Chars/Sec)**

This feature is available only if the above item, Typematic Rate Setting, is set at Enabled. Sets the rate of a character repeat when the key is held down. The options are: 6, 8, 10, 12, 15, 20, 24, 30.



#### Typematic Delay (Msec)

This feature is available only if the item, Typematic Rate Setting, is set at Enabled. Sets the delay time before a character is repeated. The options are: 250, 500, 750, 1000 millisecond.

#### Security Option

Allows to set the security level of the system. The options: Setup, System.

#### APIC Mode

Allows you to decide if the system enters the APIC (Advanced Programmable Interrupt Controller) mode or not for more IRQs can be released. The options are: Enabled, Disabled.

#### MPS Version Control For OS

When two CPUs onboard (not this board) this feature allows you to select MPS (Multi-Processor Spec.) version control for OS when logo test executes. The options are: 1.1, 1.4.

#### OS Select For DRAM > 64MB

If your operating system (OS) is OS/2, select the option OS2. Otherwise, stay with the default setting Non-OS2. The options are: Non-OS2, OS2.

#### HDD S.M.A.R.T. Capability

S.M.A.R.T. stands for Self-Monitoring and Analysis Reporting Technology which allows your hard disk drive to report any read/write errors and issues a warning with LDCM installed. The options: Disabled, Enabled.

#### Report No FDD For WIN 95

When the field under the Standard CMOS Setup Menu for Drive A and/or Drive B is set at None, users must set this field is set at Yes for it to function properly. Otherwise, set at No, even if field for Drive A and/or Drive B is set at None, system will still detect and recognize of a floppy drive(s). The options are: Yes, No.

#### BIOS Guardian

It allows the system to prevent computer viruses. Users will need to disable it to update BIOS. The options are: Enabled, Disabled.



**NOTE:** Please disable this BIOS feature about BIOS Guardian before you start to reflash BIOS.

#### **BIOS Guardian and Reflash BIOS**

BIOS Guardian by default is enabled, thus effectively acts as a fire-wall against viruses that can attack the BIOS while the system is running. It must be disabled before reflash BIOS.

The steps below show you how to off and on BIOS Guardian when reflash BIOS:

1. Press **Del** key while booting. Go to *CMOS Setup Utility* menu.
2. Go to *Advanced BIOS Features* submenu.
3. Set the feature *BIOS Guardian* at Disabled.
4. Save the setting and exit. The system restarts.
5. POST screen holds. A message about BIOS Guardian shows.
6. Press Space bar.
7. Reflash BIOS. Restart the system after complete it.
8. POST screen holds. A message about BIOS Guardian shows.
9. Press **G** key. The feature BIOS Guardian will be enabled again.

#### **Full Screen LOGO Show**

It decides whether or not the full screen logo is shown during system booting up. The options are: Enabled, Disabled.



#### **NOTE:**

1. LogoGenie supports Award BIOS only.
2. If you create a Logo file (.bmp) by LogoGenie, the file size must be 640 x 464 x 256 colors.

To enable this utility, please proceed as follows:

1. Insert software CD. Select LogoGenie from the Menu and follow the installation instructions.
2. After LogoGenie has been installed, go to Windows Start Box. In Programs Menu, select LogoGenie, then select LogoGenie.
3. Press F1 to read Help file to understand how to use this software if it is new to you.

## Advanced Chipset Features

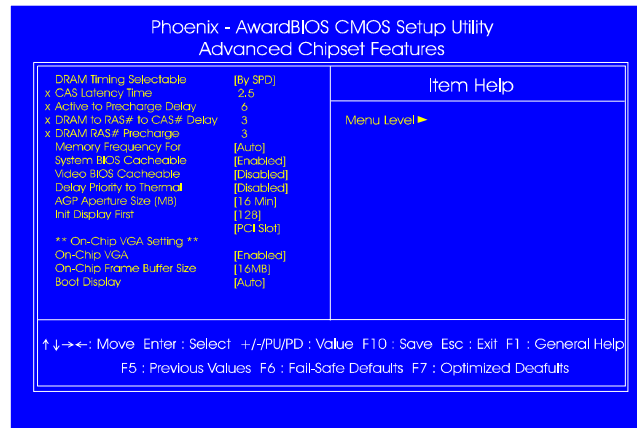

### DRAM Timing Selectable

This feature allows user to select the way to set DRAM timing. The options are: Manual, By SPD.

### CAS Latency Time

This feature allows user to select the CAS latency time, when any SDRAM DIMM installed. The options are: 2, 2.5, 3.

### Active to Precharge Delay

This feature allows user to set Active to Precharge Delay, if any SDRAM installed. The options are: 8, 7, 6, 5.

### DRAM RAS# to CAS# Delay

The feature allows user to set the delay time that from the DRAM RAS# active to CAS#. The options are: 4, 3, 2.

### DRAM RAS# Precharge

The feature allows user to set the DRAM RAS# Precharge Time. The options are: 4, 3, 2.

### Memory Frequency For

This feature allows users to set the memory frequency. The options are: Auto, (the rest depend on the core chip).

---

#### System BIOS Cacheable

Setting at Enabled will allow the caching of the BIOS ROM F0000H-FFFFFH, resulting in better system performance. It may cause system error when some program try to access the memory area.

The options are: Disabled, Enabled.

#### Video BIOS Cacheable

Setting at Enabled will allow the caching of the video BIOS ROM at C0000H-C7FFFH, resulting in better video performance. It may cause system error when some program try to access the memory area.

The options are: Disabled, Enabled.

#### Delay Prior to Thermal

It allows user to select the Delay Prior to Thermal.

The options are: 4 Min, 8 Min, 16 Min, 32 Min.

#### AGP Graphics Aperature Size (MB)

It allows user to select the main memory frame size of AGP use.

The options are: 4, 8, 16, 32, 64, 128, 256.

#### Init Display First

When you install an AGP VGA card and a PCI VGA card on the board, this feature allows you to select the first initiation of the monitor display from which card. The options are: PCI Slot, AGP.

### **\*\* On-Chip VGA Setting \*\*\* (depends on the core chip)**

#### On-Chip VGA Setting

This feature allows users to disable the onchip VGA feature.

The options are: Enabled, Disabled.

#### On-Chip Frame Buffer Size

This feature allows users to select the onchip frame buffer size.

The options are: 1MB, 8MB, 16MB, 32MB.

#### Boot Display

This feature allows users to decide which monitor appears boot screen if there are more than one type of monitor.

The options are: Auto, CRT, TV, EFP.

## Integrated Peripherals

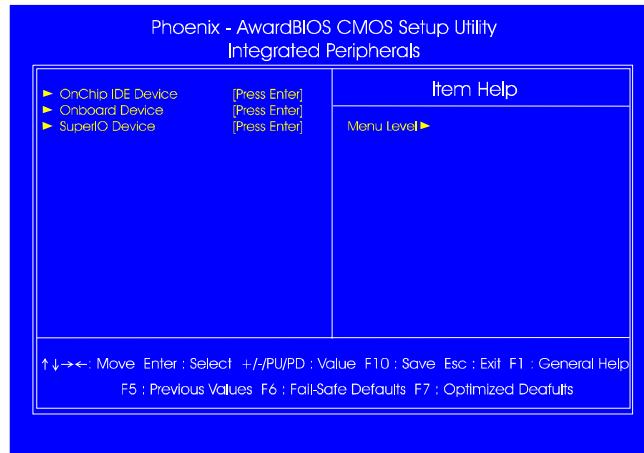

**Chapter 3**  
**BIOS Setup**

### OnChip IDE Device

#### IDE HDD Block Mode

When enabled, the system executes read/write requests to hard disk in block mode. The options are: Enabled, Disabled.

#### On-Chip Primary PCI IDE

When enabled, it allows you to use the onboard primary PCI IDE. The options are: Enabled, Disabled.

#### IDE Primary Master/Slave PIO

Allows an automatic or a manual configuration of the PCI primary IDE hard drive (master/slave) mode. The options are: Auto, Mode 0, Mode 1, Mode 2, Mode 3, Mode 4.

#### IDE Primary Master/Slave UDMA

Allows an automatic configuration of the PCI primary IDE hard drive (master/slave) mode if Ultra DMA is supported both on the motherboard and the hard disk. The options are: Auto, Disabled.

#### On-Chip Secondary PCI IDE

When enabled, it allows you to use the onboard secondary PCI IDE. The options are: Enabled, Disabled.

**IDE Secondary Master/Slave PIO**

Allows an automatic or a manual configuration of the PCI secondary IDE hard drive (master/slave) mode. The options are: Auto, Mode 0, Mode 1, Mode 2, Mode 3, Mode 4.

**IDE Secondary Master/Slave UDMA**

Allows an automatic configuration of the PCI secondary IDE hard drive (master/slave) mode if Ultra DMA is supported both on the motherboard and the hard disk. The options are: Auto, Disabled.

**Onboard Device****USB Controller**

Disable this option if you are not using the onboard USB 1.1 and USB 2.0 feature. The options are: Disabled, Enabled.

**USB 2.0 Controller**

Disable this option if you are not using the onboard USB 2.0 feature (USB 1.1 not effected). The options are: Disabled, Enabled.

**USB Legacy KB**

When set at Auto, the BIOS will detect if USB keyboard is installed automatically. The options are: Auto, Disabled, Enabled.

**AC97 Audio**

This feature auto detects if you use a card that with a CODEC to enable or disable the AC97 audio function. The options are: Auto, Disabled.

**Onboard 1394 Controller**

This feature allows you to disable the onboard 1394 feature.  
The options are: Enabled, Disabled.

**Onboard Lan Controller**

This feature allows users to enable or disable the onboard Lan controller.  
The options are: Enabled, Disabled.

**Onboard Lan Boot ROM**

This feature allows users to enable or disable the onboard Lan boot ROM to boot system. The options are: Enabled, Disabled.

### \*\*\* On-Chip Serial ATA Setting \*\*\*

#### Onboard Serial ATA

This feature allows users to disable the optional onboard SATA chip.  
The options are: Enabled, Disabled.

#### SATA Mode (depends on the core chip)

This feature allows users to select SATA specifications that embedded functions in South Bridge. The options are: IDE, RAID.

#### On-Chip Serial ATA (depends on the core chip)

This feature allows users to select the SATA function modes (that embedded in South Bridge). Setting at *Disabled* will disable SATA controller. Set at *Auto* will allow the BIOS to arrange it. Setting *Combined Mode* will make PATA and SATA combined. Max. of 2 IDE drives in each channel (primary master/slave; secondary master/slave). *Enhanced Mode* allows max. of 6 IDE drives supported. *SATA Only* will make SATA operates in legacy mode. The options are: Disabled, Auto, Combined Mode, Enhanced Mode, SATA Only.

#### Serial ATA Port0/1 Mode

This feature allows users to select the SATA port 0/1 modes.  
The options are: SATA0 master, SATA1 master.

### SuperIO Device

#### Onboard FDC Controller

When enabled, the floppy diskette drive (FDD) controller is activated.  
The options are: Enabled, Disabled.

#### Onboard Serial Port 1/2

If the serial port 1/2 uses the onboard I/O controller, you can modify your serial port parameters. If an I/O card needs to be installed, COM3 and COM4 may be needed. The options are: Disabled, 3F8/IRQ4, 2F8/IRQ3, 3E8/IRQ4, 2E8/IRQ3.

#### UART Mode Select

Allows you to select the IR modes if the serial port 2 is used as an IR port. Set at Standard, if you use COM2 as the serial port as the serial port, instead as an IR port. The options are: Normal, IrDA, ASKIR, SCR.

### UR2 Duplex Mode

Allows you to select the IR modes.  
The options are: Full, Half.

### Onboard Parallel Port

Allows you to select from a given set of parameters if the parallel port uses the onboard I/O controller.  
The options are: Disabled, 378/IRQ7, 278/IRQ5, 3BC/IRQ7.

### Parallel Port Mode

Allows you to connect with an advanced printer via the port mode it supports. The options are: SPP, ECP, EPP, EPP+ECP.

### E C P Mode Use D M A

This feature allows you to select Direct Memory Access (DMA) channel.  
The options are: 1, 3.

## Power Management Setup

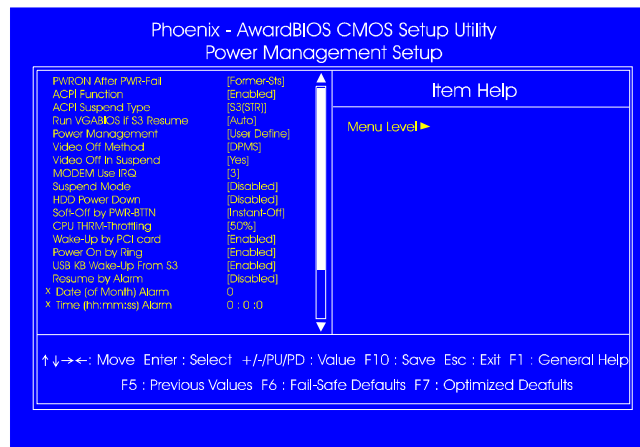

### P W R O N After P W R - F a i l

When the system is shut down owing to the power failure, the system will not be back to power on by itself. This feature allows you to set the system back to which power status of the system when the system power is resumed. The options are: Former, On, Off.



#### ACPI Function

This item allows you to disable the ACPI function.  
The options are: Enabled, Disabled.

#### ACPI Suspend Type

This item allows you to select suspend mode when the system in ACPI mode. The options are: S1 (POS), S3 (PTR), S1&S3.

#### Run VGABIOS if S3 Resume

This feature allows you to decide the way if VGA BIOS should be called when the system resumes from S3 state if the above feature is set at S3 (PTR) or S1&S3. The options are Auto, Yes, No.

#### Power Management

This item allows you to adjust the power management features.  
Select User Define for configuring your own power management features.  
Min Saving initiates all predefined timers in their minimum values. Max Saving, on the other hand, initiates maximum values.  
The options are: User Define, Min Saving, Max Saving.

#### Video Off Method

The option *Blank Screen* allows the BIOS to blank off screen display by turning off the red-green-blue signals. The option *V/H SYNC+Blank* allows the BIOS to blank off screen display by turning off the V-Sync and H-Sync signals sent from add-on VGA card. The option *DPMS* allows the BIOS to blank off screen display by your add-on VGA card which supports DPMS (Display Power Management Signaling function).  
The options are: Blank Screen, V/H SYNC+Blank, DPMS.

#### Video Off In Suspend

The option allows you to select VGA status when the system goes to suspend mode. The options are: No, Yes.

#### MODEM Use IRQ

This feature allows you to select the IRQ# to meet your modem IRQ#.  
The options are: NA, 3, 4, 5, 7, 9, 10, 11.

#### Suspend Mode

When disabled, the system will not enter Suspend mode. The specified time option defines the idle time the system takes before it enters Suspend mode. The options are: Disable, 1, 2, 4, 8, 10, 20, 30, 40 Min, 1 Hour.

#### HDD Power Down

The option lets the BIOS turn the HDD motor off when system is in Suspend mode. Selecting 1 Min..15 Min allows you define the HDD idle time before the HDD enters the Power Saving Mode.

The options 1 Min..15 Min will not work concurrently. When HDD is in the Power Saving Mode, any access to the HDD will wake the HDD up.

The options are: Disabled, 1 Min..15 Min.

#### Soft-Off by PWR-BT\*IN

The selection Delay 4 Sec. will allow the system shut down after 4 seconds after the power button is pressed. The selection Instant-Off will allow the system shut down immediately once the power button is pressed.

The settings are: Instant-Off, Delay 4 Sec.

#### CPU THRM-Throttling

When thermal override condition occur, this item allows users to determine the duty cycle of the throttling.

The options are: 87.5%, 75.0%, 62.5, 50.0%, 37.5%, 25.0%, 12.5%.

#### Wake-Up by PCI card

When set at Enabled, any PCI-PM event awakes the system from a PCI-PM controlled state. The options are Disabled, Enabled.

#### Power On by Ring

An incoming call via modem awakes the system from its soft-off mode.

The options are Disabled, Enabled.

#### Wake Up On LAN

When set at Enabled, an input signal comes from the other client/server on the LAN awakes the system from a soft off state if connected over LAN.

The options are Disabled, Enabled.

#### Resume by Alarm

This feature allows you to set the when the system being turned on from the system power-off status. The options are: Enabled, Disabled.

**Date (of Month) Alarm**

This feature allows you to set the day of the alarm starts when the RTC Alarm Resume From Soft Off is set to be Enabled. The options are: 0, 1..31.

**Time (hh:mm:ss) Alarm**

If an ATX power supply is installed and when RTC Alarm Resume is Enabled, this feature allows you to set the time of the alarm starts when the RTC Alarm Resume From Soft Off is set to be Enabled. The options are: hh (*hour*) - 0, 1, 2,..., 23; mm (*minute*) - 0, 1, 2,...,59; ss (*second*) - 0, 1, 2,...,59.

**\*\* Reload Global Timer Events \*\***

**Primary IDE 0**

When the primary master HDD is working, the system timer will be reloaded and the system will not be into the suspend mode.  
The options are: Disabled, Enabled.

**Primary IDE 1**

When the primary slave HDD is working, the system timer will be reloaded and the system will not be into the suspend mode.  
The options are: Disabled, Enabled.

**Secondary IDE 0**

When the secondary master HDD is working, the system timer will be reloaded and the system will not be into the suspend mode.  
The options are: Disabled, Enabled.

**Secondary IDE 1**

When the secondar slave HDD is working, the system timer will be reloaded and the system will not be into the suspend mode.  
The options are: Disabled, Enabled.

**FDD, COM, LPT Port**

When FDD, COM, or LPT is working, the system timer will be reloaded and the system will not be into the suspend mode.  
The options are: Disabled, Enabled.

**PCI PIRQ[A-D] #**

When the PCI PIRQ[A-D]# has been alerted, the system timer will be reloaded and the system will not be into the suspend mode.  
The options are: Disabled, Enabled.

## PnP/PCI Configurations

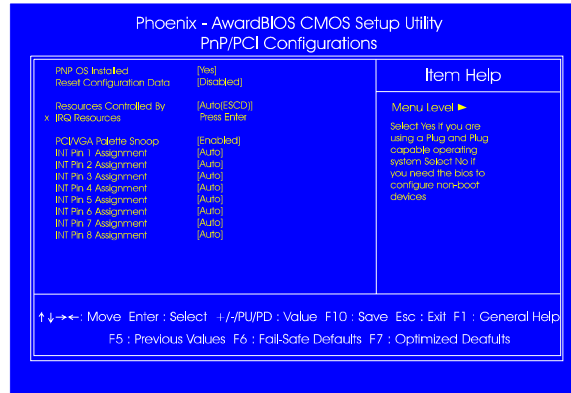

### PNP OS Installed

If your operating system is a Plug-and-Play one, such as Windows NT, Windows 95, select Yes. The options are: No, Yes.

### Reset Configuration Data

Enabling it to reset the system Extended System Configuration Data (ESCD) when you exit Setup if you have installed a new add-on card and the system reconfiguration has caused such a serious conflict that the operating system can not boot. The options are: Disabled, Enabled.

### Resources Controlled By

If set at Auto, the BIOS arranges all system resources. If there exists conflict, select Manual. The options are: Auto (ESCD), Manual.

If the manual options, after the feature **IRQ Resources** being pressed, of **IRQ- Assigned To** are: PCI Device, Reserved. When resources were controlled manually, assign each system interrupt a type, depending on each device type to use the interrupt.

### PCI/VGA Palette Snoop

Set this feature to be enabled if any ISA adapter card installed in the system requires the VGA palette snoop function.

The options are: Disabled, Enabled.

[INT Pin 1/2/3/4/5/6/7/8 Assignment](#)

This feature allows you to assign the PCI IRQ numbers for PCI slots. Selecting the default, Auto, allows the PCI controller to automatically allocate the IRQ numbers. The options are: Auto, 3, 4, 5, 7, 9, 10, 11, 12, 14, 15.

## PC Health Status

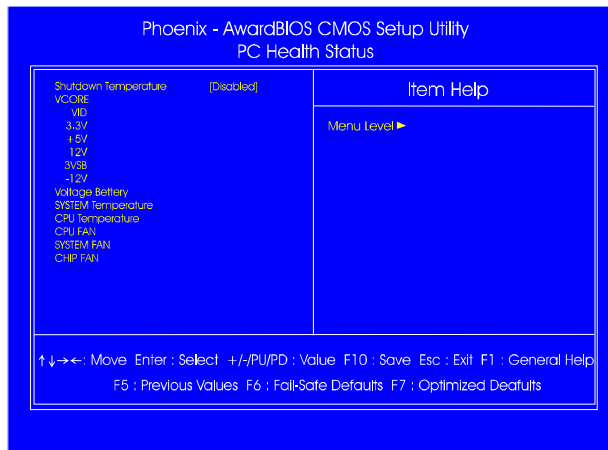

### Shutdown Temperature

This feature helps to shutdown the system when the system temperature is as high as the selected temperature to prevent from the overheat problem. The option list presents all the temperatures that supported by the board and Disabled.

[VCORE](#) / [VID](#) / [3.3V](#) / [+5V](#) / [12V](#) / [3VSB](#) / [-12V](#) / [Voltage Battery](#) / [SYSTEM Temperature](#) / [CPU Temperature](#) / [CPU FAN](#) / [SYSTEM FAN](#) / [CHIP FAN](#)

These items allow end users and technicians to monitor data provided by the BIOS on this mainboard. It is not user-configurable.

## Frequency/Voltage Control

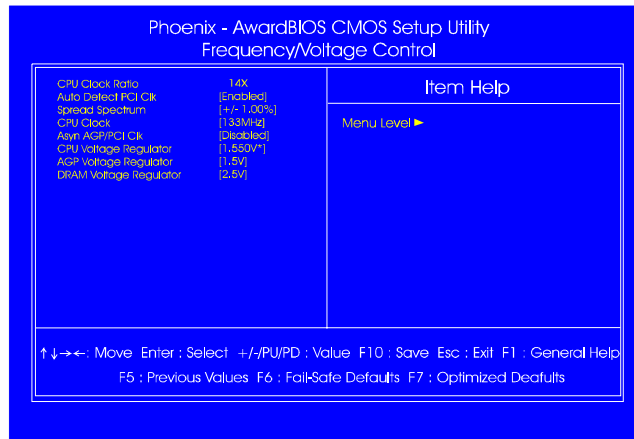

### CPU Clock Ratio

This item allows users to set the wanted CPU clock ratio.

### Auto Detect PCI Clk

When enabled, BIOS will detect the PCI slot slot. If no any device in, BIOS will auto disable its clock. The options are: Enabled, Disabled.

### Spread Spectrum

This feature allows users to select the range of spread spectrum. The options are: Disabled, +/- 0.35%, +/- 0.50%, +/- 0.75%, +/- 1.00 %.

### CPU Clock

This feature allows you to set the CPU clock frequency. The default setting is detected on your CPU clock automatically. If you set a unappropriate option which leads to a booting problem, keep pressing the Insert key until the display appears will solve it.

### Asyne AGP/PCI CLK

This feature allows you to select the combination of asynchronous AGP / PCI clock. The options are: Disabled, 66/33 MHz, 73/36 MHz, 80/40 MHz.

#### CPU Voltage Regulator

This item allows you to set the CPU Vcore voltage.  
Options: 1.450V to 1.625 V in 0.025V increments. We recommend that you leave this at the default value (with \* mark).

#### AGP Voltage Regulator

This item allows you to set the AGP slot voltage.  
Options: 1.5V to 1.8V in 0.1V increments.  
We recommend that you leave this at the default value.

#### DIMM Voltage Regulator

This item allows you to set the DIMM slot voltage.  
Options: 2.5V, 2.6V, 2.7V, 2.8V.  
We recommend that you leave this at the default value.

## Load Fail-Safe Defaults

This submenu is selected to diagnose the problem after the computer boots, if the computer will not boot. These settings do not give optimal performance.

## Load Optimized Defaults

This submenu is selected for default settings which provide the best system performance.

## Supervisor/User Password

To enable the Supervisor/User passwords, select the item from the Standard CMOS Setup. You will be prompted to create your own password. Type your password up to eight characters and press Enter. You will be asked to confirm the password. Type the password again and press Enter. To disable password, press Enter twice when you are prompted to enter a password. A message appears, confirming the password is disabled.

Under the BIOS Feature Setup, if *Setup* is selected under the Security Option field and the Supervisor/User Password is enabled, you will be prompted password every time you try to enter the CMOS Setup Utility. If *System* is selected and the Supervisor/User Password is enabled, you will be requested to enter the Password every time when you reboot the system or enter the CMOS Setup utility.

## Save and Exit Setup

After you have made changes under Setup, press Esc to return to the main menu. Move cursor to Save and Exit Setup or press F10 and then press Y to change the CMOS Setup. If you did not change anything, press Esc again or move cursor to Exit Without Saving and press Y to retain the Setup settings. The following message will appear at the center of the screen to allow you to save data to CMOS and exit the setup utility: **SAVE to CMOS and EXIT (Y/N)?**

## Exit without Saving

If you select this feature, the following message will appear at the center of the screen to allow you to exit the setup utility without saving CMOS modifications: **Quit Without Saving (Y/N)?**



**This Page Left Blank for Note**

**Chapter 3**  
**BIOS Setup**