

Installation Procedures

The mainboard has several user-adjustable jumpers on the board that allow you to configure your system to suit your requirements. This chapter contains information on the various jumper settings on your mainboard.

To set up your computer, you must complete the following steps:

- Step 1 - Set system jumpers
- Step 2 - Install memory modules
- Step 3 - Install the Central Processing Unit (CPU)
- Step 4 - Install expansion cards
- Step 5 - Connect ribbon cables, cabinet wires, and power supply
- Step 6 - Set up BIOS software
- Step 7 - Install supporting software tools



WARNING: Excessive torque may damage the mainboard. When using an electric screwdriver on the mainboard, make sure that the torque is set to the allowable range of 5.0 ~ 8.0kg/cm.

Mainboard components contain very delicate Integrated Circuit (IC) chips. To prevent static electricity from harming any of the sensitive components, you should follow the following precautions whenever working on the computer:

1. Unplug the computer when working on the inside.
2. Hold components by the edges and try not to touch the IC chips, leads, or circuitry.
3. Wear an anti-static wrist strap which fits around the wrist.
4. Place components on a grounded anti-static pad or on the bag that came with the component whenever the components are separated from the system.

1). Set System Jumpers

Clear CMOS

The CMOS RAM is powered by the onboard button cell battery. To clear the RTC data:

- (1) Turn off your computer;
- (2) open the system case, disconnect the ATX power cable;
- (3) place the jumper cap onto the pinpair 2-3 at least 6 seconds to enable CMOS clearance;
- (4) place the jumper cap onto the pinpair 1-2 to disable the effect of CMOS clearance;
- (5) connect the ATX power cable; close the system case;
- (6) turn on your computer until *CMOS checksum error* appears;
- (7) hold down the *Delete* key when boots;
- (8) enter the BIOS Setup to re-enter user preferences.

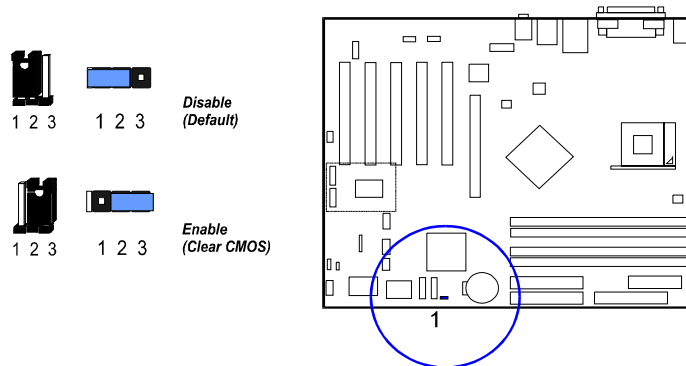

NOTE: Users are not encouraged to change the jumper/switch settings not listed in this manual. Changing the settings improperly may adversely affect system performance.

2). Install Memory Modules

1. Locate DDR DIMM sockets on the mainboard.

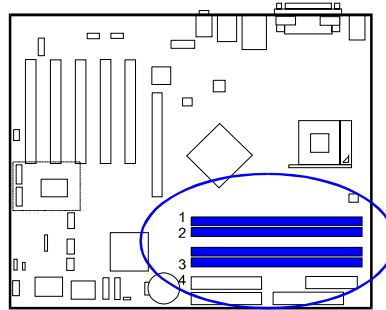
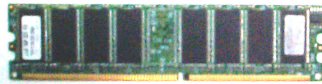

2. Install DDR DIMM straight down into the socket 1 using both hands, then socket 2, and so forth.

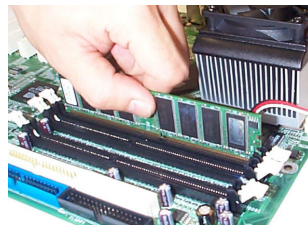

3. The clip on both ends of the socket will close up to hold the DDR DIMM in place when the DDR DIMM reaches the socket bottom.

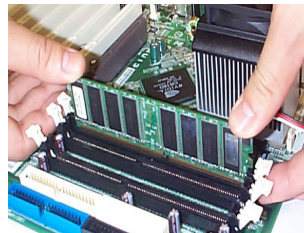

NOTE:

1. To enable dual channel, it must be same density (128/256MB, etc.); same technology (128/256Mb, etc.); same bus width (x8, x16); both single- (or dual-) sided; installed on symmetrical memory slots.

2. If your system uses an 800MHz CPU with DDR333 memory, the memory interface of the chipset will runs at 320MHz.

Press the clips with both hands to remove the DIMM.

3). Install the CPU

The mainboard has built-in Switching Voltage Regulator to support CPU Vcore autodetection. That is, It has the ability to detect and recognize the CPU voltage, clock, ratio and enables users to set up the CPU frequency from the BIOS Setup Screen. Users can adjust the frequency through *Frequency / Voltage Control* of the BIOS Setup Screen.

Chapter 2
Installation
Procedures

The procedures below shows you how to install your CPU and its fan and heatsink. First of all, locate the CPU socket on this mainboard.

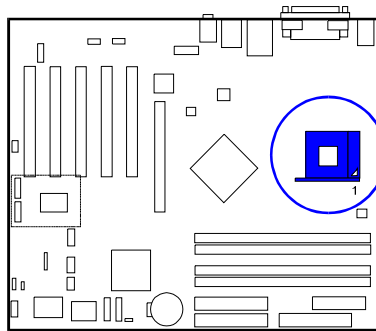

1. Swing the lever upward to 90 degree.
2. Install the CPU and make sure the the pin 1 orientation by aligning the socket corner marking with the socket corner closest to the lever tip. Do not insert the CPU by force. Make sure the processor is fully inserted into the socket on all sides.

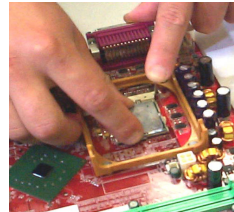

Apply some thermal materials, such as paste or tape, on the CPU top; and install a fan with heatsink that approved by CPU manufacturer to avoid CPU damage. For detail information, please refer to the CPU manufacturer website.

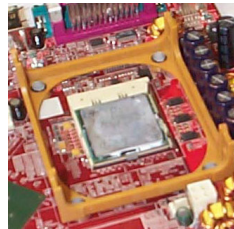

Affix the CPU by pressing the lever downward and locking it beside the socket.

3. Place the fan with heatsink on the CPU top and press down two plastic clips to hook up with the holes on the retention module on two sides.

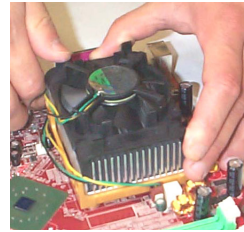

4. Press down the white bar on each clip to fasten the fan set on the retention module.

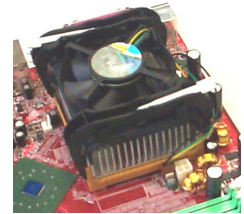

Chapter 2
Installation
Procedures

Connect ATX Power

The 20-hole power plug (top right) is connected to the ATX power 20-pin pinheaders. The 4-hole 12V power plug (bottom right) is inserted in the ATX_12V power connector.

The plug from the power supply will only insert in one orientation because of the different hole sizes. Find the proper orientation and push down firmly making sure that the pins are aligned.

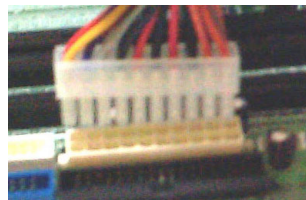
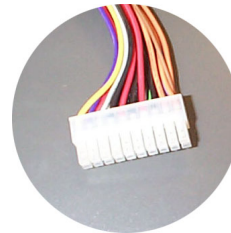

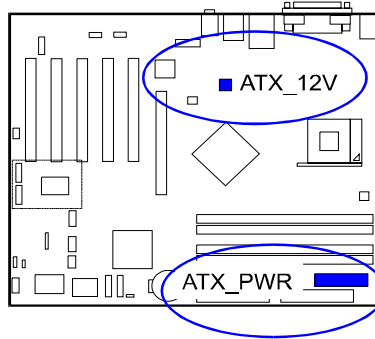

NOTE: Users The CPU installing procedures should be:

1. Insert the CPU (with its fansink and retention module) on the socket.
 2. Connect the 4-pin plug of the power supply
 3. Connect the 20-pin plug of the power supply.
- To remove the processor, please do it in reverse order.

4). Install Expansion Cards

This section describes how to connect an expansion card to one of your system expansion slots.

Expansion cards are printed circuit boards that, when connected to the mainboard, increase the capabilities of your system.

For example, expansion cards can provide video and sound capabilities. The mainboard features one AGP and five PCI bus expansion slots.



CAUTION:

1. Make sure to unplug the power supply when adding or removing expansion cards or other system components. Failure to do so may cause severe damage to both the mainboard and expansion cards.
2. Always observe static electricity precautions.
3. Please read Handling Precautions at the start of this manual.

1. Select an available expansion slot.

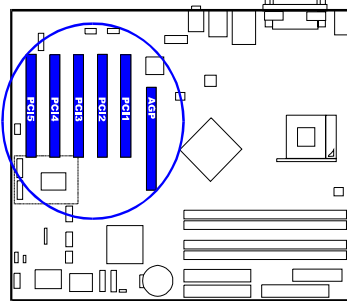

2. Remove the corresponding slot cover from the computer chassis. Unscrew the mounting screw that secures the slot cover and pull the slot cover out from the computer chassis. Keep the slot cover mounting screw nearby.

3. Push the card firmly into the slot. Push down on one end of the expansion card, then the other. Use this rocking motion until the card is firmly seated inside the expansion slot. Secure the card with the screw removed in Step 2.

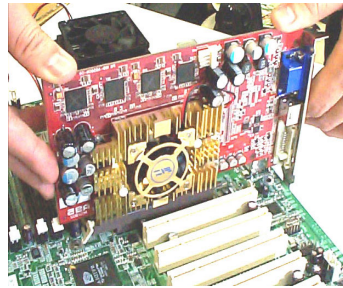

5). Connect Devices

Floppy Diskette Drive Connector

This connector provides the connection with your floppy disk drive.

Insert the floppy ribbon cable (below) onto the floppy connector.

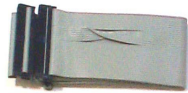

The colored stripe (indicated by the arrow head, right) of the ribbon cable must be the same side with the Pin 1.

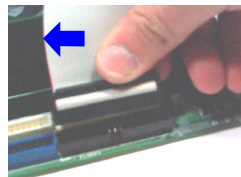
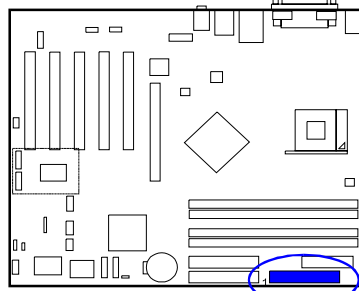

IDE Device Connectors

The two connectors, IDE1 (PRIMARY) and IDE2 (SECONDARY), are used for your IDE hard disk drives, CD drives, LS-120 drives, or IDE ZIP drives.

Insert the floppy ribbon cable (below) onto the floppy connector.



The colored stripe (indicated by the arrow head, right) of the ribbon cable must be the same side with the Pin 1.

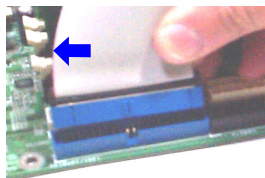
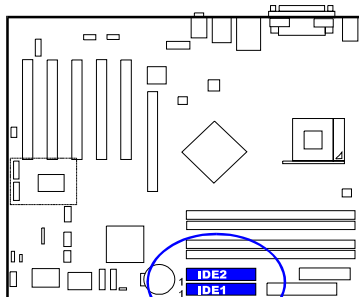

Fan Connectors

The two connectors, CPU_FAN, SYS_FAN are linked to the CPU fan, case fan, respectively. CHIP_FAN can be used with North Bridge chip fan.

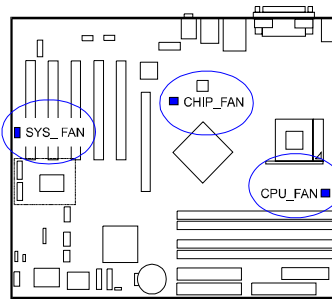
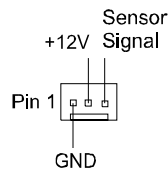

**Chapter 2
Installation
Procedures**

Power Connectors

The 20-pin male block connector is connected to the ATX power supply. The 4-pin male block connector is for the ATX_12V power use. All two connectors are linked with your ATX power supply. The plug from the power supply will only insert in one orientation because of the different hole sizes. Find the proper orientation and push down firmly making sure that the pins are aligned.

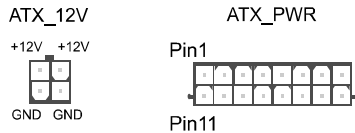

PIN	DEFINITION	PIN	DEFINITION
1	+3.3V	11	+3.3V
2	+3.3V	12	-12V
3	GND	13	GND
4	+5V	14	PS_ON
5	GND	15	GND
6	+5V	16	GND
7	GND	17	GND
8	PWR_GOOD	18	-5V
9	5V_SB	19	+5V
10	+12V	20	+5V

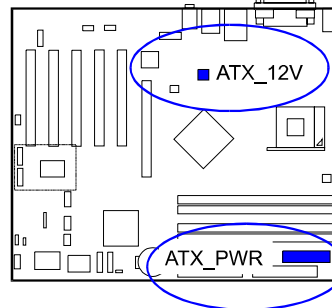

Front Panel Block, Power LED, IR, and Speaker Connector

This block connector includes the connectors for linking with Power LED (3-pin), HDD LED, power button, power/sleep/message waiting button, reset button on the front panel of the system case. Please identify polarities of plug wires for the case speaker and LEDs. Please ask vendor about this information when you buy them and install the system by yourself. The plug wires (below) polarities of these buttons will not affect the function.

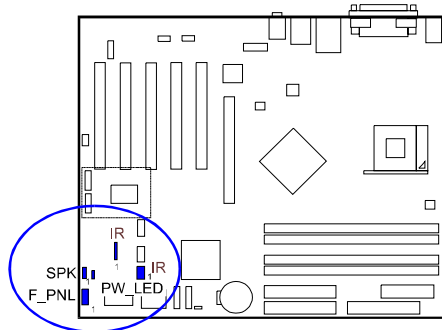

F_PNL
(Intel spec.)

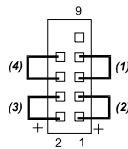

IR
(Intel spec.)

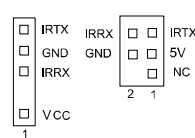

SPK
(Speaker)



PW_LED
(Power LED, 2/3 pins)

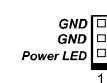

NOTE: Users that want to use IR port must adjust BIOS feature **UART Mode Select** to set COM2 at some IR mode upon your IR device.

(1) Reset Switch is connected to the reset button. Push this switch to reboot the system instead of turning the power button off and on.

(2) HDD LED is connected to the IDE device indicator. This LED will blink when the hard disk drives are activated.

(3) Power (Single and Dual) /Sleep LED

Please refer to the tables below for the representations of LED states. There is another 3-Pin Power LED connector on board for some cases that with a 3-pin plug.

Single-Color (2, 3 Pins)

LED	Meaning	State
Off	Off	S4/S5
On	Full On	S0
Flash	Sleep	S1/S3

Dual-Color

LED	Meaning	State
Off	Off	S4/S5
Green	Full On	S0
Other Colors	Sleep	S1/S3

(4) Power Button is connected with power button. Push this switch allows the system to be turned on and off rather than using the power supply button.

IR is a pinheader that is used for linking with your ID device to allow transmission of data to another system that also supports the IR feature.

Speaker is connected with the case speaker.

**Chapter 2
Installation
Procedures**

Serial ATA Connectors

The 2 SATA connectors (SATA1/2) are controlled by Intel ICH5/ICH5R® provide you with the connections to serial ATA devices that conform to the Serial ATA specification. Serial ATA supports all ATA and ATAPI devices. The connectors allows two RAID hard disks for RAID (level 0/1) functions if ICH5R onboard. The figures below left are two SATA cables (the top one is for power; the next one is for data). The data cable pin assignments of SATA connector.

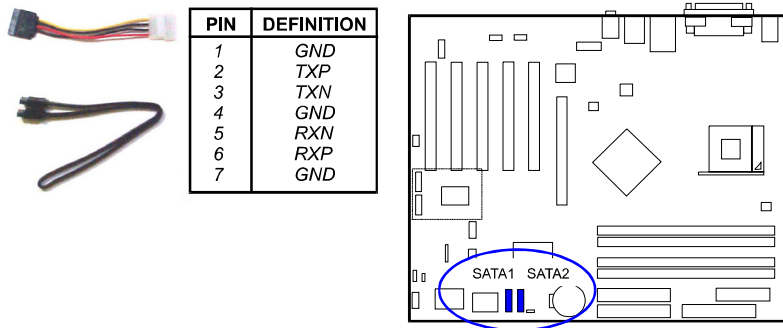

NOTE: Please read page 3-12 for more detail about the usage of SATA feature.

CD Audio-In Connectors

The connectors, CD_IN and AUX_IN, are for CD-ROM drive audio analog input use.

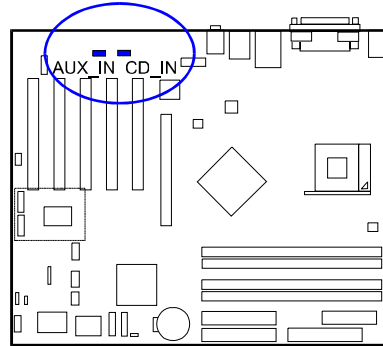
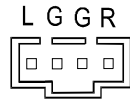

1394 Connectors (optional)

The 2 optional 1394 pinheaders on the board provides you with two connections with the peripherals which own 1394 connectors by an optional bracket with cable (see the figure below). The pin definitions of the 1394 pinheaders are listed below also.

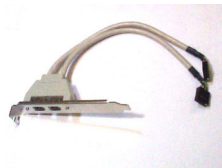

PIN	DEFINITION
1	TA1+
2	TA1-
3	GND
4	GND
5	TB1+
6	TB1-
7	VCC
8	VCC
9	GND
10	NC

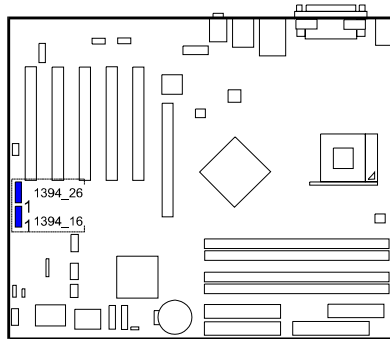

PS/2 Keyboard and Mouse Connector

These two 6-pin female (PS/2 keyboard is purple color and PS/2 mouse is green color) connectors are used for your PS/2 keyboard and PS/2 mouse.

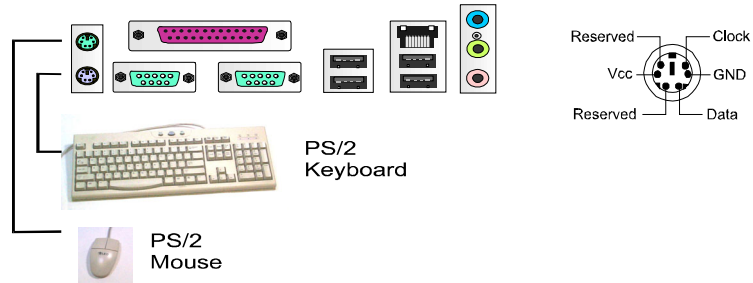

**Chapter 2
Installation
Procedures**

RJ45 LAN Connector

The LAN (RJ45 port) jack is used for the LAN cable plug.

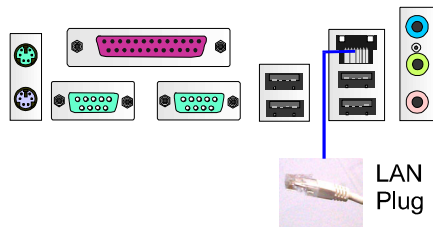

Serial Port Connectors

COM1/2 (9-pin D-sub male connector with teal color) allow you to connect with your devices that use serial ports, such as a serial mouse or an external modem.

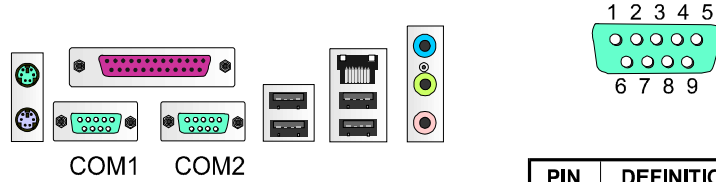

PIN	DEFINITION
1	DCD
2	SIN
3	SOUT
4	DTR
5	GND
6	DSR
7	RTS
8	CTS
9	RI

Printer Connector

This 25-pin D-Sub female burgundy-colored connector is attached to your printer.

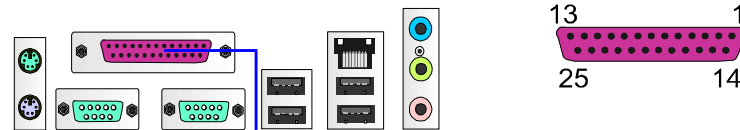

Printer

PIN	DEFINITION
1	STROBE
2 - 9	DATA 0 - 7
10	ACK#
11	BUSY
12	PE
13	SELECT
14	AUTO FEED#
15	ERR#
16	INIT#
17	SLIN#
18-25	GND

Audio I/O Jacks

LINE_OUT (lime) can be connected to headphones or preferably powered speakers. LINE_IN (light blue) allows tape players or other audio sources to be recorded by your computer or played through the LINE_OUT. MIC_IN (pink) allows microphones to be connected for audio input.

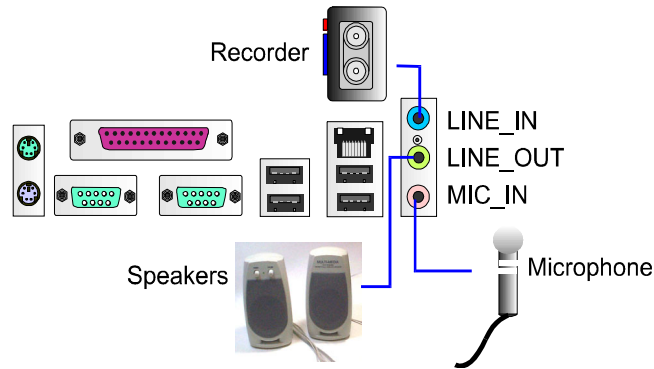

Chapter 2
Installation
Procedures

Front Audio Connector

The mainboard has a front panel audio F_AUDIO connector (Intel spec.). It allows users to attach the audio device via front panel (instead of rear panel) by a ribbon cable that in some cases. Its pin definitions are resented below.

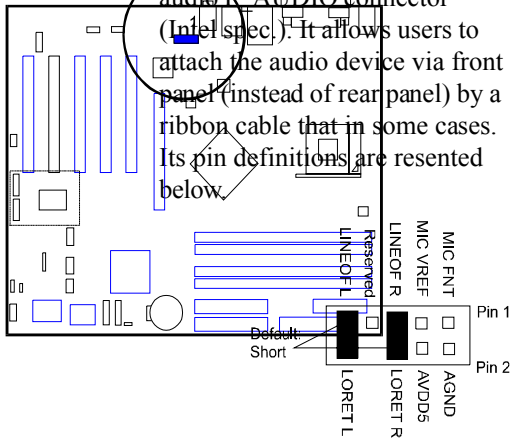

NOTE: If you do not use F_AUDIO, please keep the pinpair 5-6, 9-10 short as default; also, when the front headphone is plugged in, the rear audio output will be disabled.

5.1 Audio Channel Feature

The 5_1_AUDIO sound feature are offered via the pinheaders with an optional A73 bracket with ribbon cable. The pinheaders pin assignments are shown below left.

Chapter 2
Installation
Procedures

PIN	DEFINITION
1	Front Out R
2	Rear Out R
3	Front Out L
4	Rear Out L
5	Center Out
6	Bass Out
7	AGND
8	
9	VCC
10	SPDIF Optical In
11	SPDIF Out
12	+12V
13	GND
14	SPDIF Coaxial In

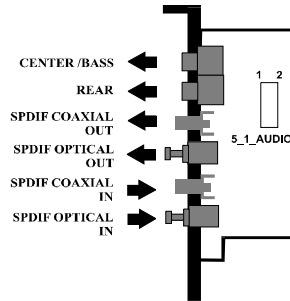
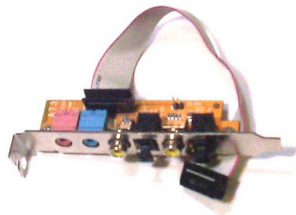
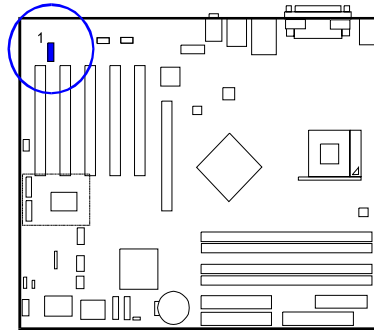

When use the daughter board, plug in the LINE_OUT jack for the front speaker audio output (right and left).

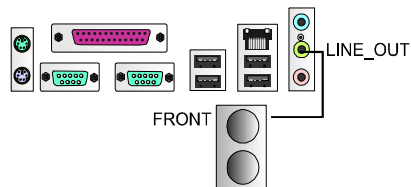

NOTE: If you do not have A73 bracket, the LINE_IN, LINE_OUT, MICROPHONE jacks can be used the 5.1-channel audio output with its software tool.

Universal Serial Bus Connectors

The mainboard have eight USB ports; four USB black jacks that integrated on the edge of the board, the other four USB ports on the board. They allows uses to attach with USB devices either from rear or front panels. The USB cable that comes with your mainboard is used to connecting between the USB pinheaders and rear panel. (See the photo below).

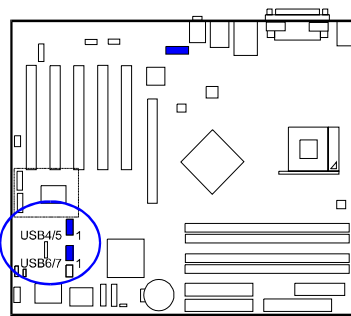
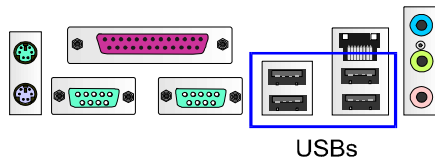

The figure below is the pin assignments of the USB4/5 and USB6/7.

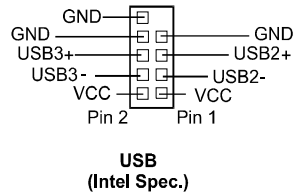

**Chapter 2
Installation
Procedures**

This Page Left Blank for Note

**Chapter 2
Installation
Procedures**