

Veriton 3600 series

User's guide

Copyright © 2003 Acer Incorporated
All Rights Reserved.

Veriton 3600 series
User's guide

Original issue date: April 2003

Changes may be made periodically to the information in this publication without obligation to notify any person of such revision or changes. Such changes will be incorporated in new editions of this manual or supplementary documents and publications. This company makes no representations or warranties, either expressed or implied, with respect to the contents hereof and specifically disclaims the implied warranties of merchantability or fitness for a particular purpose.

Record the model number, serial number, purchase date, and place of purchase information in the space provided below. The serial number and model number are recorded on the label affixed to your computer. All correspondence concerning your unit should include the serial number, model number, and purchase information.

No part of this publication may be reproduced, stored in a retrieval system, or transmitted, in any form or by any means, electronic, mechanical, photocopy, recording, or otherwise, without the prior written permission of Acer Incorporated.

Model Number : _____

Serial Number: _____

Purchase Date: _____

Place of Purchase: _____

Acer and the Acer Logo are registered trademarks of Acer Inc. Other company's product names or trademarks are used herein for identification purposes only and belong to their respective companies.

1 First things first	1
System specifications	4
Package contents	6
Accessing the user's guide	7
2 System tour	9
Features	12
Performance	12
Multimedia	12
Connectivity	12
Front panel	14
Rear panel - VT3600D	16
Rear panel - VT3600G	18
Keyboard	20
Programmable keys	21
Internet/Suspend keys	22
Multimedia keys	23
Volume control/Mute knob	24
Lock keys	25
Cursor keys	26
Windows keys	27
Function keys	28
Palm rest	28
Optical drive	29
Hard disk	31
3 Setting up your computer	33
Arranging a comfortable work area	36
Adjusting your chair	36
Positioning your PC	36
Positioning your monitor	39
Positioning your keyboard	39
Positioning your mouse	40
Connecting peripherals	41
Connecting your mouse	41
Connecting your keyboard	43
Connecting a monitor	45
Connecting the power cable	46
Turning on your computer	47
Turning off your computer	48
Connecting options	49
Connecting your printer	49
Connecting the modem (optional)	50

Connecting to the network	51
Connecting multimedia devices	52
Connecting USB devices	55
4 Upgrading your computer	57
Installation precautions	60
ESD precautions	60
Preinstallation instructions	60
Post-installation instructions	61
Opening your computer	62
To remove the computer cover	62
To replace the computer cover	63
Internal components	64
System boards	65
Mainboard layout	65
Audio board	69
Upgrading your computer	70
Installing additional memory	70
Replacing the hard disk	72
Installing an expansion card	76
5 System utilities	79
Acrobat Reader	83
Acer LANScope (optional)	84
Norton AntiVirus	85
NTI CD-Maker (for models with CD-RW)	87
PowerDVD (for models with DVD)	89
BIOS utility	90
Reinstalling programs	91
Recovering your system	92
Using Backup (Windows XP only)	96
Disk Defragmenter (Windows XP only)	97
6 Frequently asked questions	99
Appendix A: Notices	105
FCC notice	106
Important safety instructions	107
Laser compliance statement	108
Lithium battery statement	109
Macrovision® statement	109
Year 2000 compliance statement	109

Appendix B: Taking care of your computer	111
Important tips	112
Cleaning and servicing	112
Asking for technical assistance	113
Index	115

1 First things first

This chapter describes the system specifications and the contents of your computer package.

System specifications

Component	Specification
Processor	<ul style="list-style-type: none"> • Intel Pentium®4 1.8 - 3.6 GHz • Intel Celeron® 2.0 - 2.6 GHz
System memory	Four SDRAM slots support a maximum of 4 GB dual-channel DDR memory
Chipset	<ul style="list-style-type: none"> • Intel MCH 865G • Intel MCH 865PE
Graphics	<p>Intel MCH 865G on-die VGA card supporting:</p> <ul style="list-style-type: none"> • DVMT technology • Dual View • 1 optional VGA port on rear <p>Intel MCH 865PE supporting:</p> <ul style="list-style-type: none"> • Add-on VGA card
Audio	AC97 Codec
LAN	Broadcom 5705 supporting 10/100/1000 MB connectivity
IDE	40 pin parallel ATA IDE slot
FDD	1.44 MB 3.5 inch floppy drive
PS2	<ul style="list-style-type: none"> • PS2 keyboard port • PS2 mouse port
USB	Six external USB 2.0 ports
Serial port	One serial port
Printer port	One parallel printer port
Debug	One 4 LED port
Thermal	Dynamic fan speed control

Component	Specification
Security	<ul style="list-style-type: none"> • Chassis lock (Kensington compatible) • Chassis intrusion alarm
Chassis	Three models: H80, H40, H34A
Wake system	Wake on LAN Wake on modem Mouse/keyboard
HDD	<ul style="list-style-type: none"> • 5400 RPM: 40 - 100 GB • 7200 RPM: 40 GB, 80 GB, 120 GB
Optical Drive	CD-ROM, CD-RW, DVD-ROM, or DVD/CD-RW combo
Operating system	<ul style="list-style-type: none"> • Windows 2000 • Windows XP Home • Windows XP Professional • Novell • SCO Unix • Red Hat Linux
Dimensions	<ul style="list-style-type: none"> • Mini-Tower 424(H) /200(W) /414(D) • Desktop 135(H) /380(W) /420(D) • Small Form Factor 95(H) /324(W) /399(D)
Weight	<ul style="list-style-type: none"> • Mini-Tower 8.5 kg • Desktop 6.5 kg • Small Form Factor 5.3 kg
Thermal overrides	<ul style="list-style-type: none"> • System temp >90°C - functions suspended until system temp is below 90°C • CPU temp >110°C - functions suspended until CPU temp is below 110°C • CPU temp >120°C - system auto-shutdown

Package contents

Before you unpack your computer, make sure that you have enough space to set up your computer.

Carefully unpack the carton and remove the contents. If any of the following items are missing or damaged, contact your dealer immediately:

- Veriton 3600 series
- Items contained in the accessory box
 - Foot stands
 - USB or PS/2 keyboard
 - USB or PS/2 mouse
 - Power cable
- User's guide and installation poster
- Other user documentation and third-party software

Accessing the user's guide

This user's guide is also available on your computer as an Adobe Acrobat PDF file.

To access the user's guide (for Windows XP)

- 1 On the Windows XP taskbar, click on the Start button then select Help and Support Center.
- 2 On the Help and Support Center home page, double-click the Veriton 3600 series Online icon.

To access the user's guide (for Windows 2000)

- 1 Double-click on the Veriton 3600 series Online icon on your Windows desktop.

2 System tour

This chapter discusses the features and components of your computer.

Features

Here are just a few of your computer's many features:

Performance

- Intel Pentium® 4 supporting FSB up to 800 MHz
or
- Intel Celeron® CPU supporting FSB up to 400 MHz
- Intel Hyperthreading Technology supported on 3.06 GHz and higher Intel Pentium® 4 systems
- Intel 865G/865PE ICH5 chipset
- DDR-SDRAM 400/333/266, 4 DIMM slots, Expandable to 4GB dual-channel memory
- Power management function
- 3.5-inch floppy drive
- CD-ROM, CD-RW, DVD-ROM, or DVD/CD-RW combo drive
- High-capacity, Enhanced-IDE hard disk
- Supports USB 2.0 high-performance peripherals

Multimedia

- 3-D quality audio system via onboard audio controller
- Audio-in/Line-in, Audio-out/Line-out, Headphone-out, and Microphone-in interfaces



.....

Note: The system has two microphone-in jacks (front and rear). However, you can not use both of them at the same time. By default, your system enables the microphone-in jack in front and disables the one at the back.

Connectivity





- Two PS/2 interfaces for mouse and keyboard
- One serial port
- One parallel port



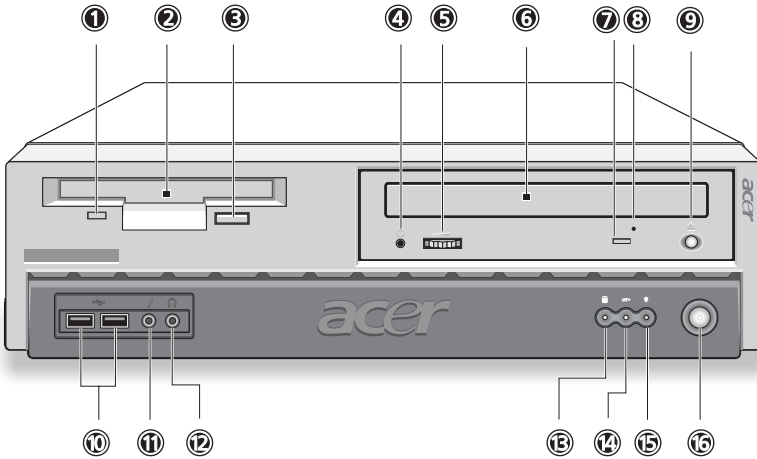



- One VGA port
- Eight Universal Serial Bus (USB) 2.0 ports (two internal, two on the front and four on the rear panel)
- High-speed fax/data PCI modem (optional)
- Broadcom 5705 10/100/1000Base-T Gigabit LAN support with remote wake-up function

Front panel

Your computer's front panel consists of the following:



Label	Icon	Component
1		Floppy drive light-emitting diode (LED)
2		3.5-inch floppy drive
3		Floppy drive eject button
4		CD-ROM/DVD-ROM/CD-RW Headphone/Earphone port
5		Volume control
6		CD-ROM/DVD-ROM/CD-RW tray
7		CD-ROM/DVD-ROM/CD-RW LED
8		CD-ROM/DVD-ROM/CD-RW emergency eject slot
9		Stop/Eject button
10		USB ports

Label	Icon	Component
11		Microphone-in jack (front) <small>see note</small>
12		Headphone-out port
13		Hard disk activity LED
14		LAN activity LED
15		Power LED
16		Power button









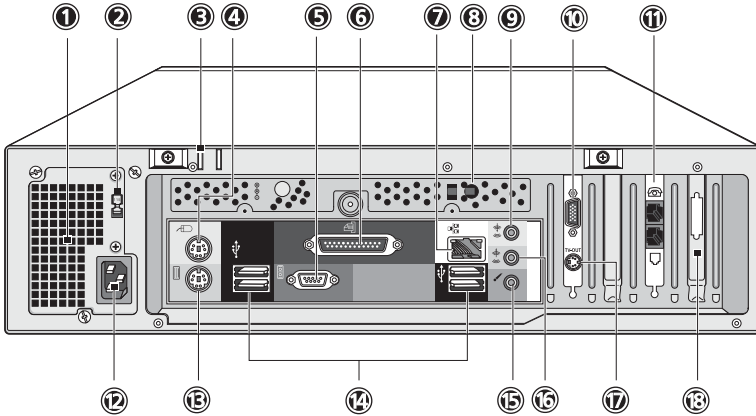



Note: The system has two microphone-in jacks (front and rear). However, you can not use both of them at the same time. By default, your system enables the microphone-in jack in front and disables the one at the back.

Rear panel - VT3600D

Your computer's rear panel consists of the following:



Label	Icon	Color	Component
1			Power supply
2			Voltage selector switch
3			Keyhole
4		Green	PS/2 mouse port
5		Teal or Turquoise	Serial port
6		Burgundy	Parallel/Printer port
7		White	Network port
8			One Touch Recovery button (Optional)





Label	Icon	Color	Component
9		Light blue	Audio-in/Line-in jack
10			Monitor port (PCI expansion card)
11			Telephone/Handset line port
12			Power cord socket
13		Purple	PS/2 keyboard port
14		Black	USB ports
15		Pink	Microphone-in jack (rear)
16		Lime	Audio-out/Line-out jack
17			S-Video out jack
18			Expansion slots



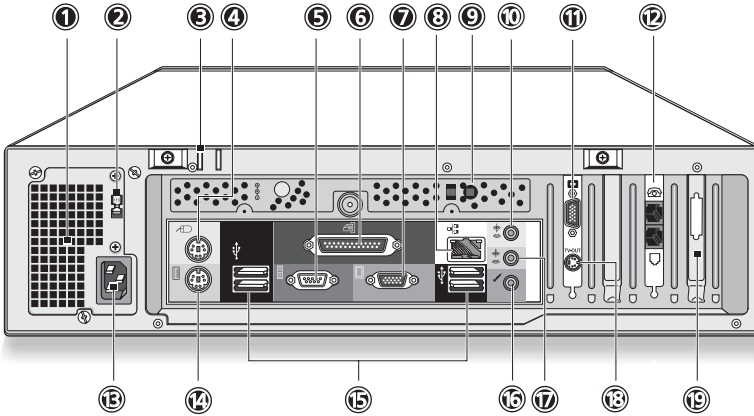



For information on how to connect the peripherals, see “Connecting peripherals” on page 41 and “Connecting options” on page 49.

Rear panel - VT3600G

Your computer's rear panel consists of the following:



Label	Icon	Color	Component
1			Power supply
2			Voltage selector switch
3			Keyhole
4		Green	PS/2 mouse port
5		Teal or Turquoise	Serial port
6		Burgundy	Parallel/Printer port
7		Blue	Monitor port (On-die VGA)
8		White	Network port

Label	Icon	Color	Component
9			One Touch Recovery button (Optional)
10		Light blue	Audio-in/Line-in jack
11			Monitor port (PCI expansion card)
12			Telephone/Handset line port
13			Power cord socket
14		Purple	PS/2 keyboard port
15		Black	USB ports
16		Pink	Microphone-in jack (rear)
17		Lime	Audio-out/Line-out jack
18			S-Video out jack
19			Expansion slots

For information on how to connect the peripherals, see “Connecting peripherals” on page 41 and “Connecting options” on page 49.

Keyboard

The keyboard that came with your computer has full-sized keys that include separate cursor keys, two Windows keys, and twelve function keys.

For information on how to connect your USB keyboard, please see “Connecting peripherals” on page 41.

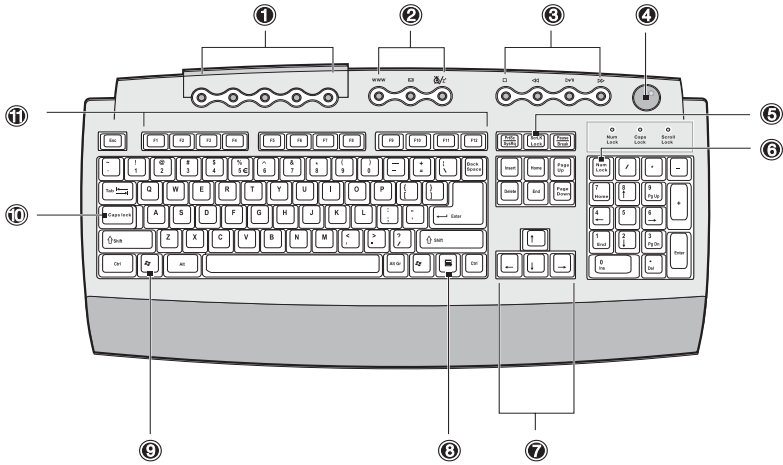

No.	Description
1	Programmable keys
2	Internet/Suspend keys
3	Multimedia keys
4	Volume control/Mute knob
5	Scroll lock key
6	Num lock key
7	Cursor keys
8	Application key

No.	Description
9	Windows logo key
10	Caps lock
11	Function keys

Programmable keys

The programmable keys help you directly access a URL (Web site) or launch any program, files, or application in your system. The fifth key is set to launch the Windows Media Player. If you want to configure the settings of each key, right click on the Magic Keyboard icon located on the desktop.

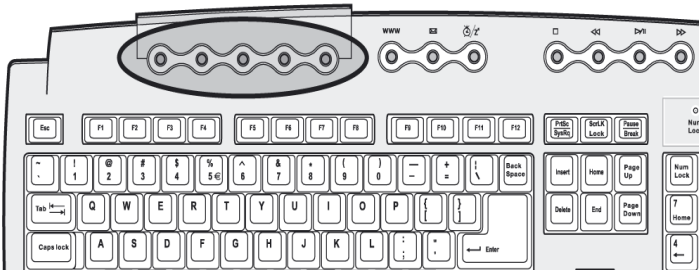

Internet/Suspend keys

The Internet/Suspend keys consist of three buttons:

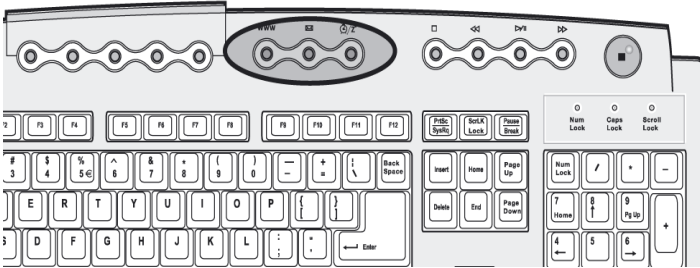

Icon	Key	Description
	Email	Launches your email application.
WWW	Web browser	Launches your current default browser.
Z	Suspend	Press this button to put system to sleep.

Multimedia keys

Allow you to conveniently play, pause, stop, step forward, or step back a song or movie using your keyboard.

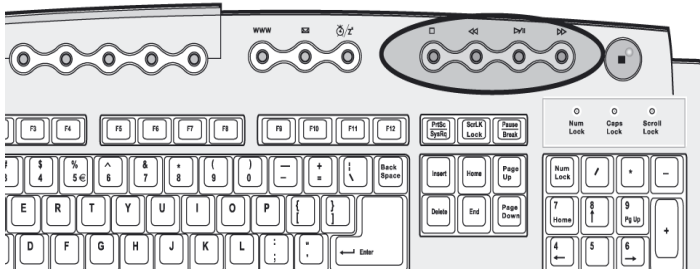

Icon	Key	Description
▶▶ /	Play/Pause	Press to start playing the audio track or video file. Press again to pause.
■	Stop	Press to stop playing the audio track or video file.
▶▶▶	Forward	Press to skip forward to the next track or video file and start playing.
◀◀◀	Backward	Press to skip backward to the previous track or video file and start playing.

Volume control/Mute knob



The volume control/mute knob controls the speaker volume. Turn it clockwise or counterclockwise to adjust the volume. Press it to toggle between mute and sound.

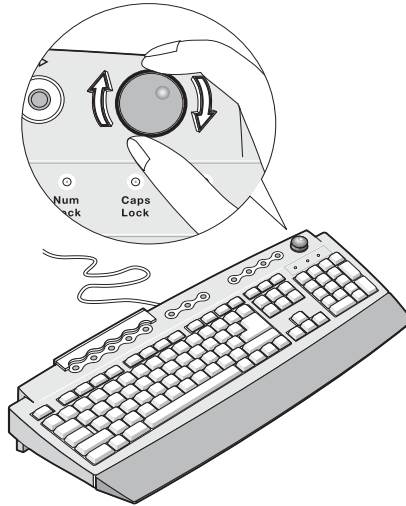

Lock keys

The keyboard has three lock keys which you can toggle on and off to switch between two functions.

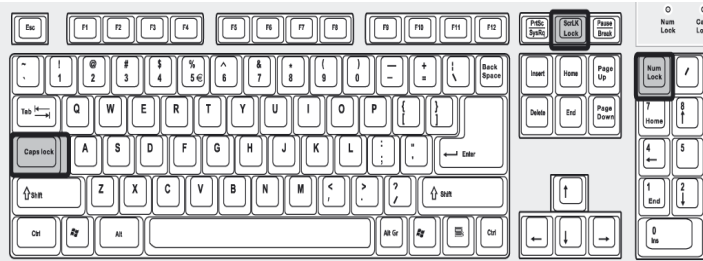

Lock key	Description
Caps Lock	When activated, all alphabetic characters typed appear in uppercase (same function as pressing Shift + <letter>).
Num Lock	When activated, the keypad is set to numeric mode; i.e., the keys function as a calculator (complete with arithmetic operators such as +, -, * and /).
Scroll Lock	When activated, the screen moves one line up or down when you press the up arrow or down arrow respectively. Take note that Scroll Lock may not work with some applications.

Cursor keys

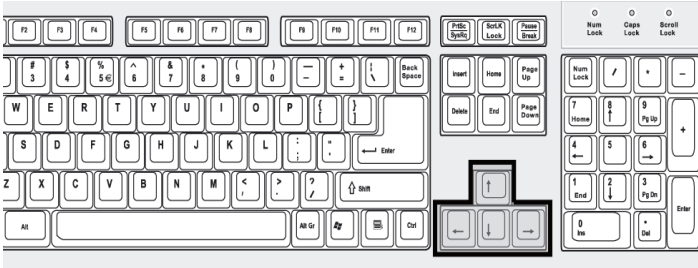

The cursor keys, also called the arrow keys, let you move the cursor around the screen. They serve the same function as the arrow keys on the numeric keypad when the Num Lock is toggled off.

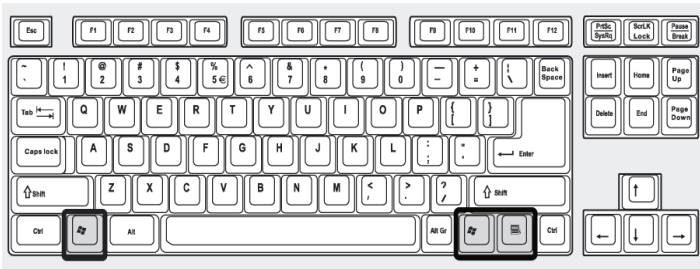

Windows keys

The keyboard has two keys that perform Windows-specific functions.



Key	Description
<p>Windows logo key</p> 	<p>Start button. Combinations with this key perform special functions, such as:</p> <ul style="list-style-type: none"> • Windows + Tab: Activate the next Taskbar button • Windows + E: Explore My Computer • Windows + F: Find Document • Windows + M: Minimize All • Shift + Windows + M: Undo Minimize All • Windows + R: Display the Run dialog box
<p>Application key</p> 	<p>Opens the applications context menu (same function as clicking the right button of the mouse).</p>

Function keys

The function keys, F1 - F12, let you perform specific functions, depending on the application that uses them.

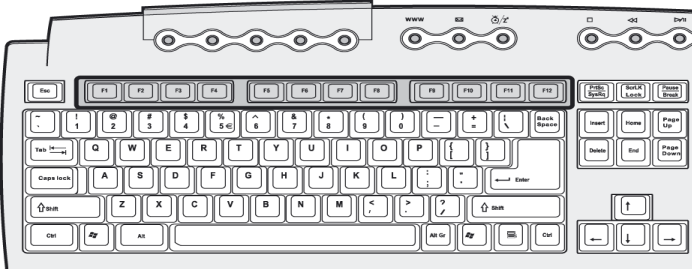

Palm rest

The detachable palm rest provides you a comfortable place to rest your hands while typing.

Optical drive

Your computer may come with a CD-ROM, DVD-ROM or a combo DVD/CD-RW drive. This drive is located on the front panel of your computer. The CD-ROM drive allows you to play different types of compact discs (CDs). The DVD-ROM drive allows you to play not only old CD-ROMs, CD-I discs, and video CDs, but digital video discs (DVDs) as well. DVD or DVD-ROM is a type of disc media that holds a minimum of 4.7-GB (gigabytes), enough for a full-length movie. The CD-RW drive allows you to record or burn CD-RW (recordable and rewritable) discs.

CDs and DVDs, like diskettes, are also compact, lightweight, and easy to carry around. However, they are more delicate than diskettes and must be handled with extra care.

To insert a CD or DVD into your computer's CD-ROM or DVD drive:

- 1 Gently push the Eject button located on the front panel.

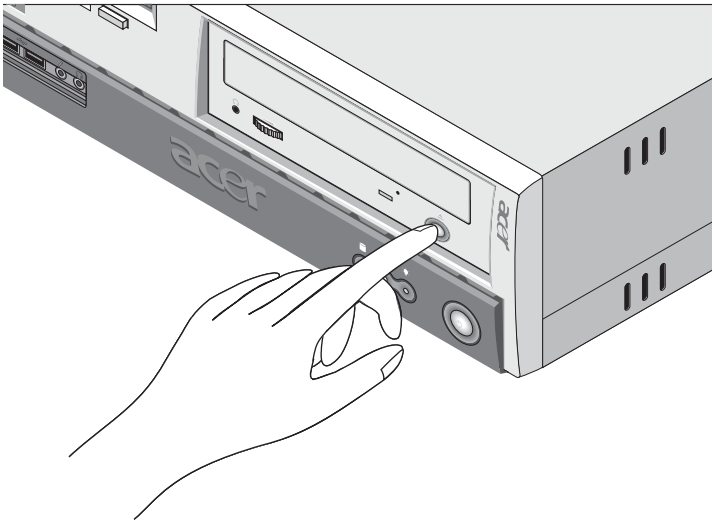

- 2 When the disc tray slides open, place the CD or DVD gently on the tray. Make sure that the label or title side of the disc is facing upward. When holding a disc, hold it by the edges to avoid leaving smudges or fingerprints.

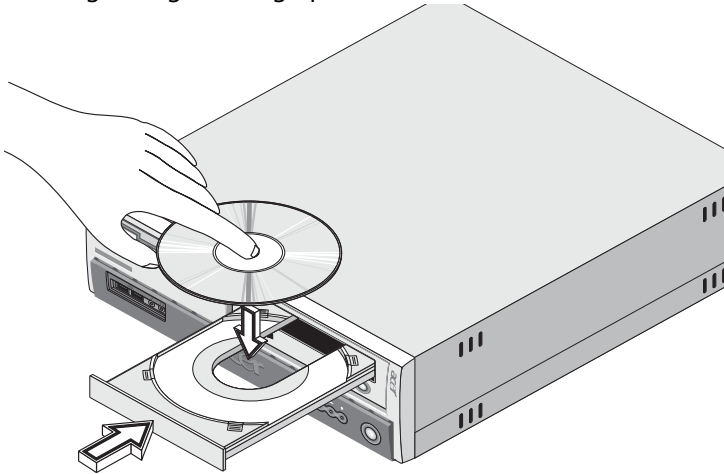

- 3 Push the Eject button again to close the tray.

To take care of your CDs and DVDs:

- Keep your discs in a disk case when not in use to avoid scratches or other damage. Any kind of dirt or damage can affect the data on the disc, impair the disc lens reader on the CD or DVD drive, or stop the computer from successfully reading the disc.
- When handling discs, always hold them by the edges to avoid smudges or fingerprints.
- When cleaning discs, use a clean, dust-free cloth and wipe in a straight line from the center to the edge. Do not wipe in a circular motion.
- Clean your CD or DVD drive periodically. You may refer to the Cleaning kit for instructions. Cleaning kits can be purchased in any computer or electronics shop.

Hard disk

Your computer is preinstalled with a high-capacity Enhanced-IDE (E-IDE) hard disk.

Refer to “Replacing the hard disk” on page 72 for instructions on how to upgrade or replace your hard disk

3 Setting up your computer

This chapter contains step-by-step instructions on how to set up your computer and connect additional peripherals.

Arranging a comfortable work area

Working safely begins with the arrangement of your work space and the proper use of equipment. For this reason, it is very important to take time and think about how you are going to arrange your work area.

Here are some points to consider:

Adjusting your chair

Having the right kind of chair does not necessarily mean that you'll be properly supported. It is necessary to adjust your chair to fit your body. Proper body posture will make you more comfortable and productive.

- Avoid tilting your chair. If you have a chair that tilts, lock the tilt knobs so that your chair will not tilt forward or backward while you are using your computer.
- Adjust your chair height in such a way that you can sit on it with your thighs parallel to the floor and your feet resting flat on the floor.
- Rest your body on the chair back. Your torso works harder to maintain balance if you do not rest your body on the chair back.

Positioning your PC

You may position your computer in two ways:

- Tower-like/vertical position
- Regular desktop position

To position your PC in a tower or vertical position:

- 1 Install the foot stands.
Press the notch on both sides of the foot stands (a).

- 2 Attach the foot stands to the slots on the housing frame (b) as shown in the figure below:

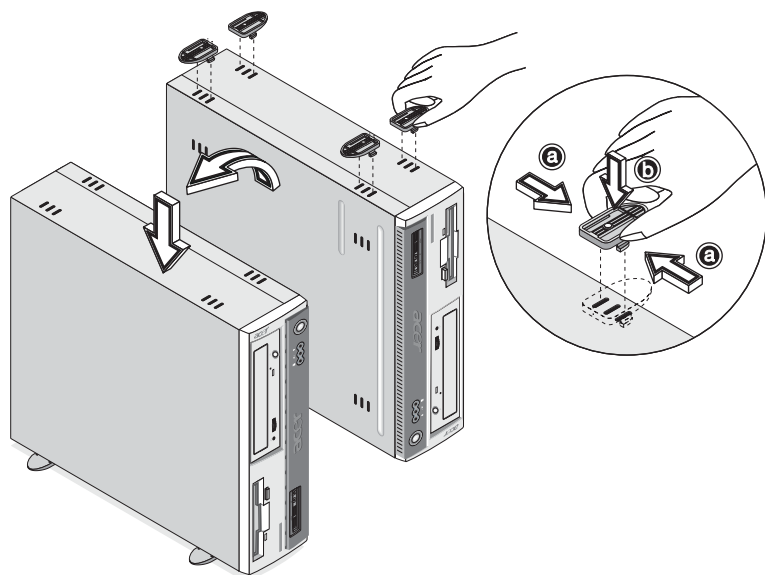

To position your PC in a desktop or horizontal position:

- 1 Attach the foot stands as shown in the figure that follows.

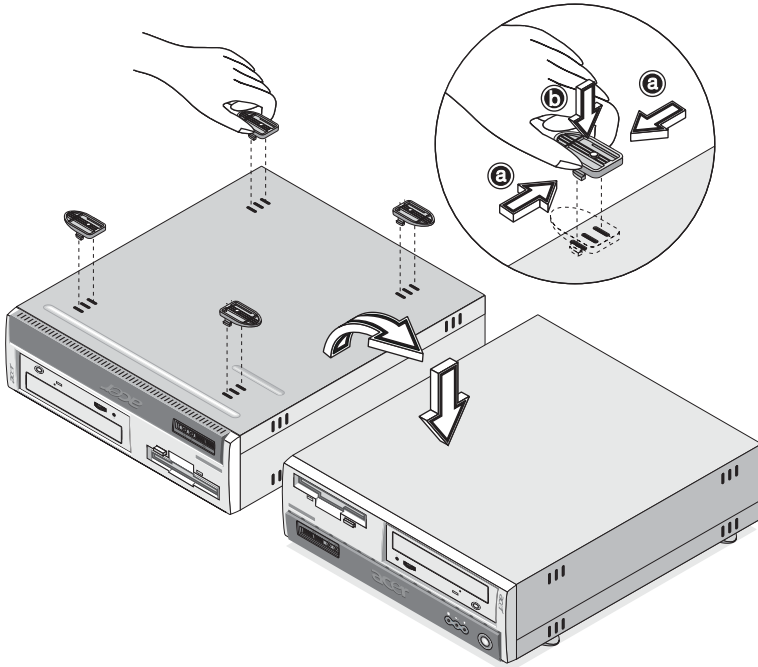

- 2 Place your computer in the desired location.

Take note of the following when selecting a location for your computer:

- Do not put your computer near any equipment that might cause electromagnetic or radio frequency interference such as radio transmitters, televisions, copy machines, or heating and air-conditioning equipment.
- Avoid dusty areas and extremes of temperature and humidity.
- You may place your computer beside your desk or under your table, as long as it does not block the space that you need for working and moving.

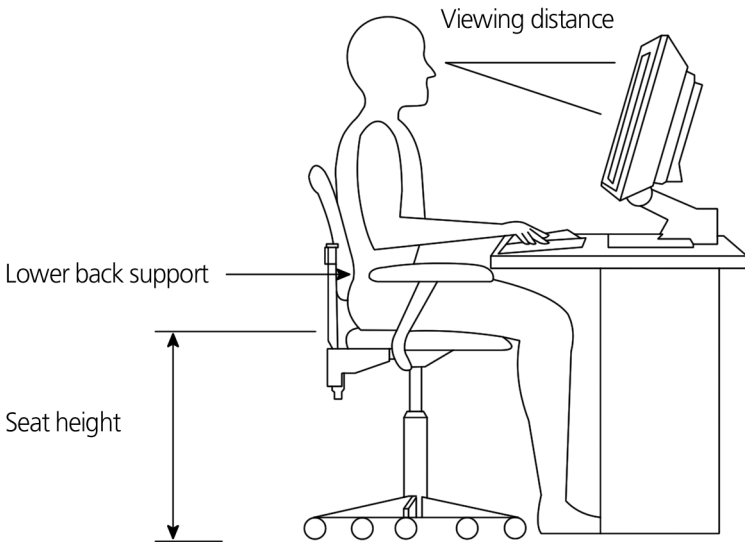

Positioning your monitor

Place your monitor at a comfortable viewing distance, usually 50 to 60 centimeters away. Adjust the display in such a way that the top of the screen is at or slightly below eye level.

Positioning your keyboard

The location of the keyboard is a very important factor to your posture. Placing it too far away will make your body lean forward forcing you to sit in an unnatural position. Placing it too high will add tension to your shoulder muscles.

- The keyboard should be placed just above your lap. Adjust the keyboard height by flipping the folding stands located under the keyboard.
- Keep your lower arms parallel to the floor as you type. Your upper arms and shoulders should be relaxed. Then try typing with a light touch. If you feel any shoulder or neck strain, stop for a while and check your posture.
- Position your keyboard in front of your monitor. Putting your

keyboard beside your monitor will make you turn your head while you type which could add tension to your neck muscles that may later result in neck strain.

Positioning your mouse

- The mouse should be placed on the same surface as your keyboard so that you can reach it with ease.
- Adjust its position to allow enough space for movement without making you stretch or lean over.
- Use your arm to move the mouse. Do not rest your wrist on the table when moving the mouse.

Connecting peripherals

Setting up your computer is easy. For the most part, you only have four things to connect: the mouse, the keyboard, the monitor, and the power cable.



Note: The peripherals shown in the connections below are for your reference only. Actual device models may vary in select countries.

Connecting your mouse

USB mouse

Plug your USB mouse cable into any of the USB ports  (black) located on the front and rear panels of your computer.

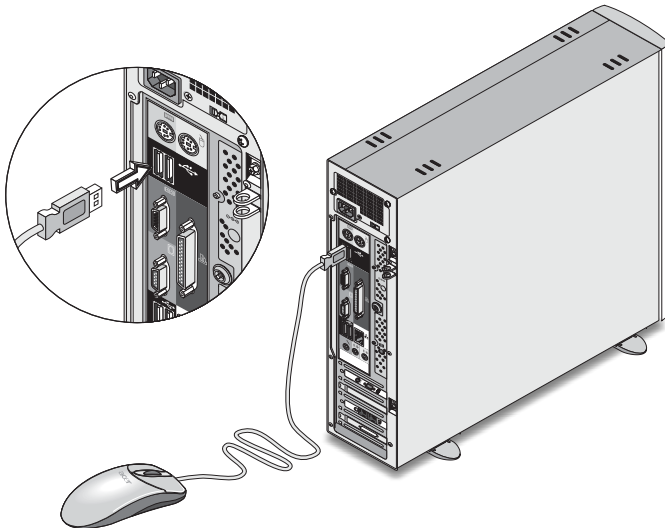

PS/2 mouse

Plug the PS/2 mouse cable into the PS/2 mouse port  (green port) located on the rear panel of your computer.

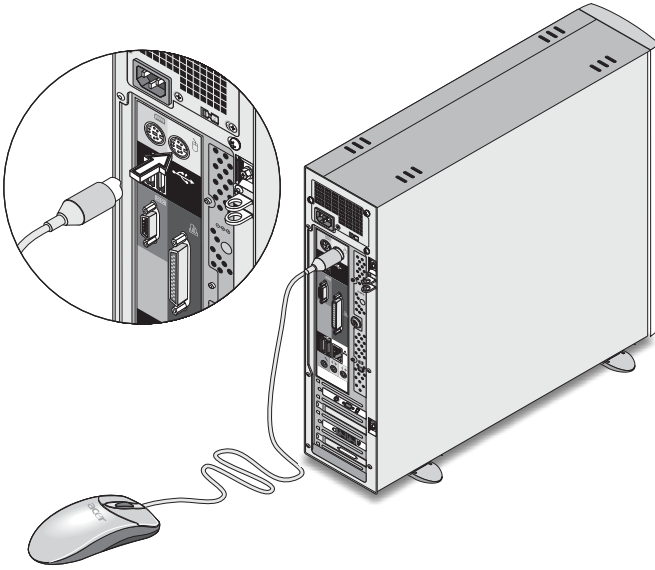

Connecting your keyboard

USB keyboard

Plug your USB keyboard cable into any of the USB ports (black port) located on the front and rear panel of your computer.

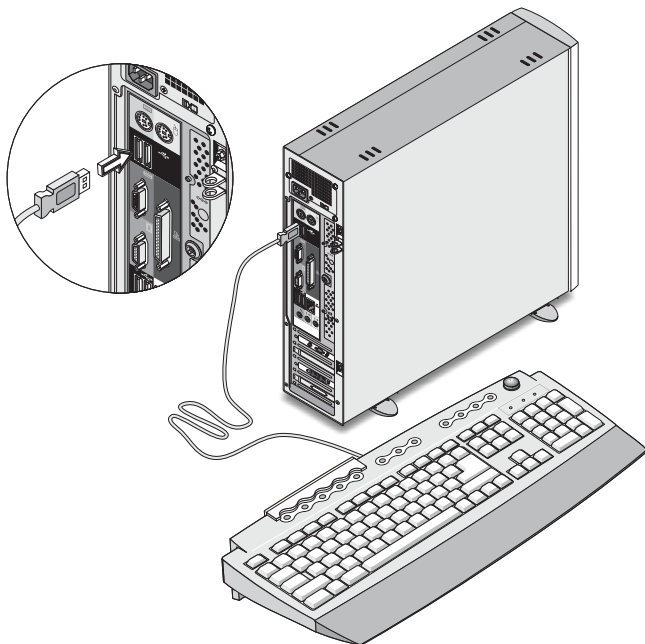

PS/2 keyboard

Plug your PS/2 keyboard cable into the PS/2 keyboard port  (purple port) located on the rear panel of your computer.

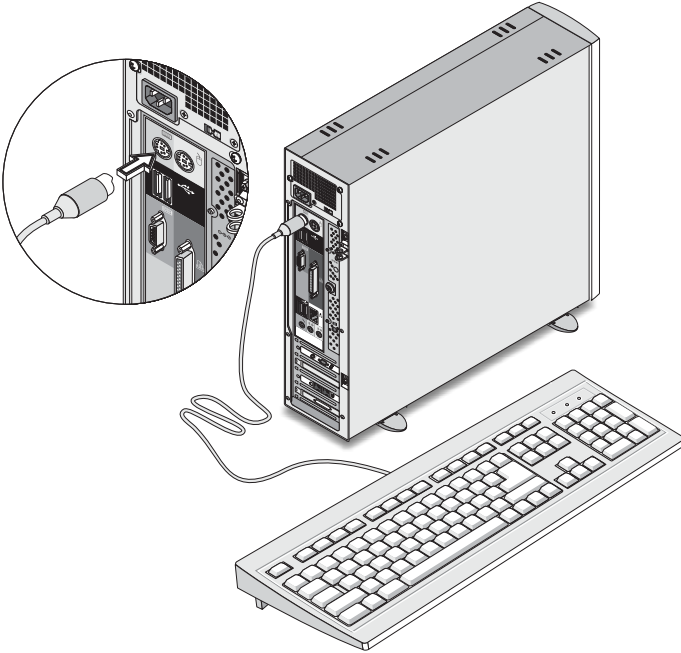

Connecting a monitor

The location of your monitor port depends on which Veriton 3600 models you have. Refer to “Rear panel - VT3600D” on page 16 or “Rear panel - VT3600G” on page 18 to locate your monitor port(s).

To connect a monitor, simply plug the monitor cable into the monitor port  (blue port) located on the rear panel of your computer.



.....
Note: Refer to the monitor manual for additional instructions and information on adjusting your monitors settings.

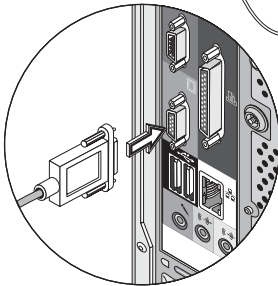
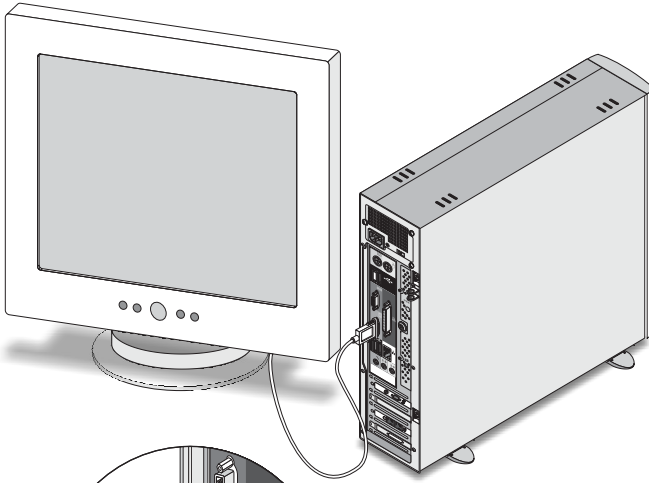

.....
Note: The image above shows the Veriton 3600G. Refer to pages 16 and/or 18 for the location of your monitor port(s).

Connecting the power cable



Caution! Before you proceed, check the voltage range in your area. Make sure that it matches your computer's voltage setting. If they don't match, set your computer's voltage selector switch to the voltage range applicable to your area.

Set the voltage selector switch to the voltage range applicable to your area (a). Plug the power cable into the power cable socket located on the rear panel of your computer (b). Then plug the other end of the power cable into a power outlet.

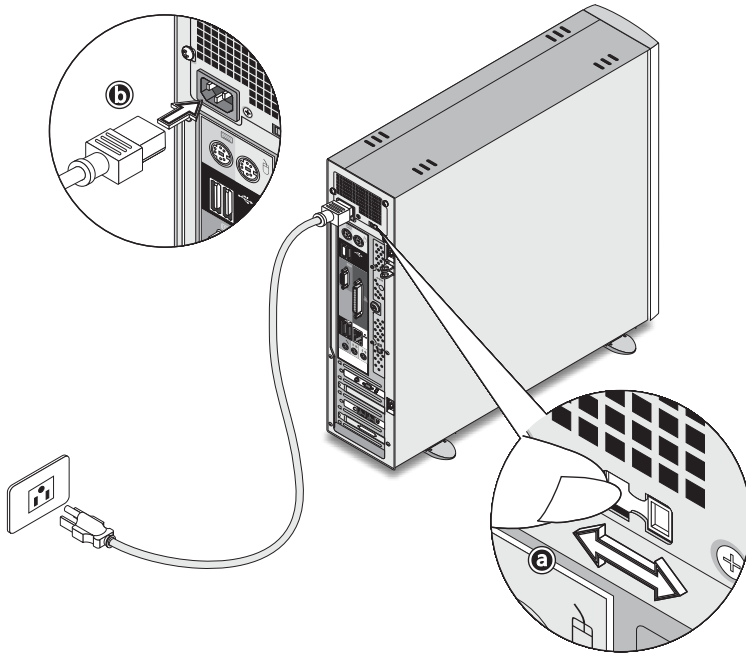

Turning on your computer

After connecting the necessary peripherals and plugging in the power cable, you are now ready to turn the computer on and get to work.

To turn on your computer:

- 1 Turn on all peripherals connected to your computer such as the monitor, printer, fax, speakers, etc.
- 2 On the front panel of your computer, press the Power button.

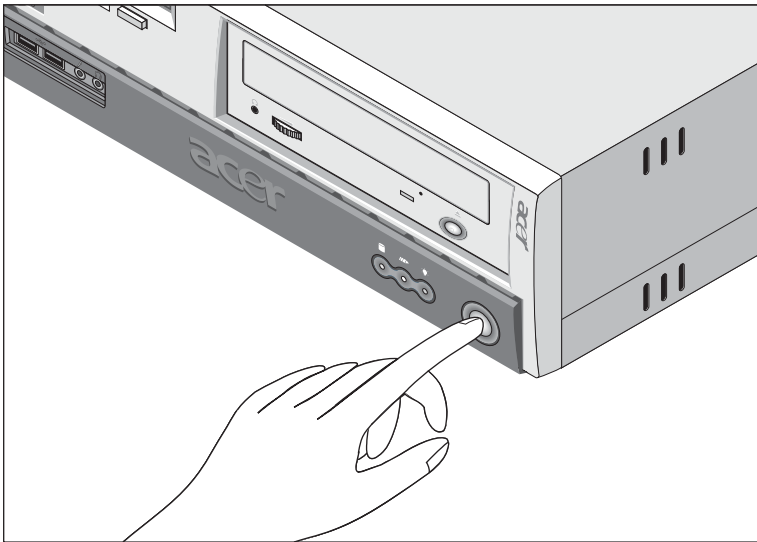

Important: Make sure that the power cable is properly plugged into an electrical outlet. If you are using a power strip or an AVR (Auto-Voltage Regulator), make sure that it is plugged in and turned on.

Turning off your computer

To turn off your computer, follow the steps below.

For Windows XP:

- 1 On the Windows XP taskbar, click on the Start button, and click Turn Off Computer; then click Turn Off.
- 2 Turn off all peripherals connected to your computer.

For Windows 2000:

- 1 On the Windows 2000 taskbar, click on the Start button, highlight Shut Down, select Shut down from the drop down window then click on OK.
- 2 Turn off all peripherals connected to your computer.

If you cannot shut down your computer normally, press the power button for at least four seconds. Quickly pressing the button may put the computer in Suspend mode only.

Connecting options

Connecting your printer

Your computer supports parallel, serial and USB printers.

To connect a parallel printer, plug the printer cable into the parallel port  (burgundy port) located on the rear panel of your computer.



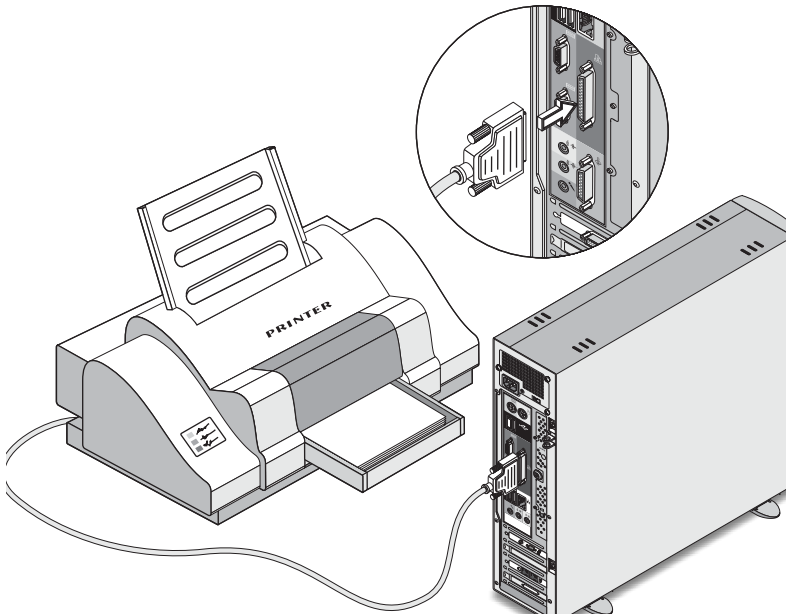

.....
Note: The printer shown below is for your reference only. Actual device model may vary in select countries.



.....
Note: If you are using a serial printer, connect the printer cable into the serial port located on the rear panel of your computer. In the same manner, connect a USB printer by plugging the printer cable into any of the USB ports located on the front or rear panels.

Connecting the modem (optional)

Set up your modem connection by plugging the telephone line  and handset line  into their corresponding ports on the rear panel of your computer.

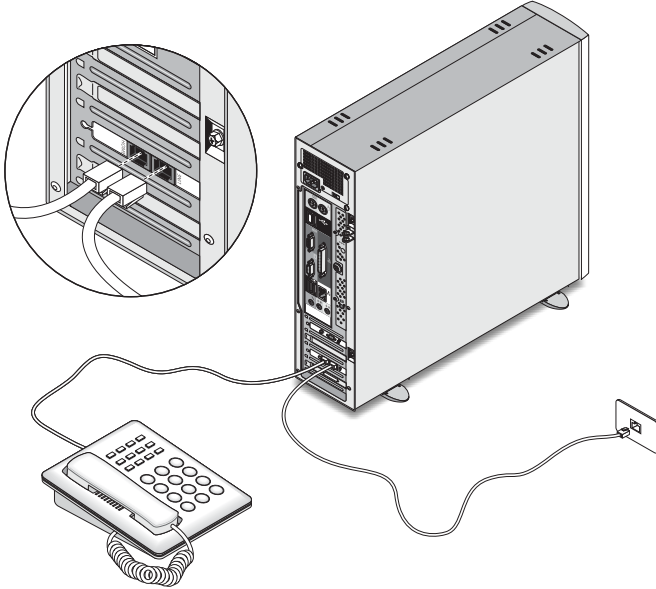

Connecting to the network

You can connect your computer to a Local Area Network (LAN) using a network cable. To do so, simply plug the network cable into the network port  (white port) on the rear panel of your computer.

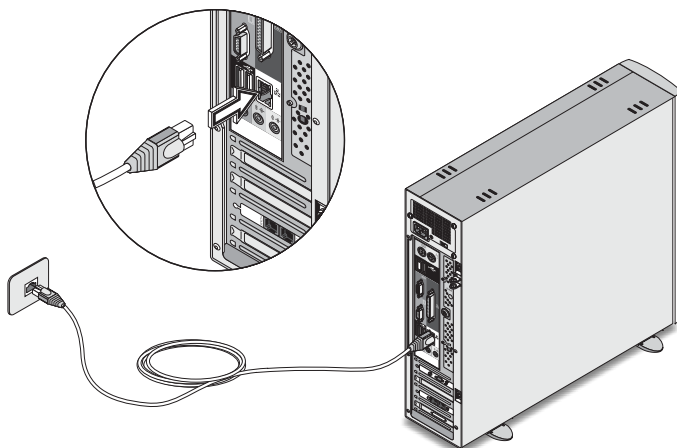

Note: Consult your network system administrator or operating system manual for information on how to configure your network setup.

Connecting multimedia devices

You can connect multimedia devices such as microphone, earphone or headphone, external speakers, and audio line-in device. These devices will allow you to take advantage of your computer's multimedia features.



.....

Note: The multimedia devices shown below are for your reference only. Actual device models may vary in select countries.

Plug the devices in as follows:



.....

Note: For information on how to configure multimedia devices, consult the documentation that came with each device.

- microphone: connects to the microphone-in jack  (pink port) located on the front and rear panel of your computer



.....

Note: The system has two microphone-in jacks (front and rear). However, you can not use both of them at the same time. By default, your system enables the microphone-in jack in front and disables the one at the back.

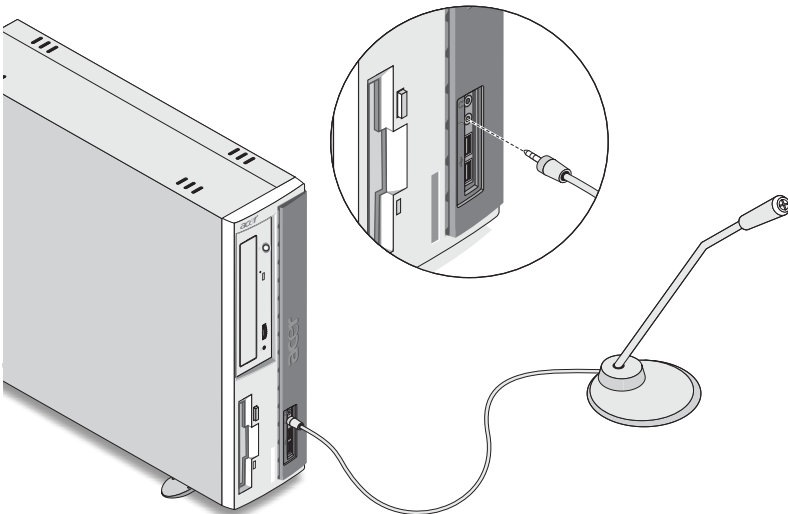

- earphones, headphones: connect to the Headphone-out port (lime port) located on the front panel of your computer 



.....

Note: To adjust the volume of the headphones, click on the Volume icon located on the taskbar at the bottom of your screen. When the Volume control pops up, drag the Volume control lever to the desired level. You can also use the Volume control button on the keyboard.

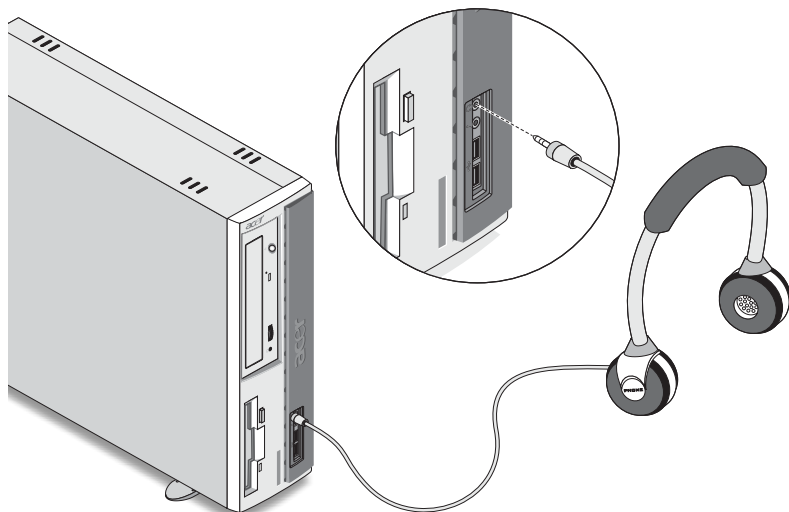

- external speakers: connect to the Audio-out/Line-out jack (lime jack) on the rear panel of your computer

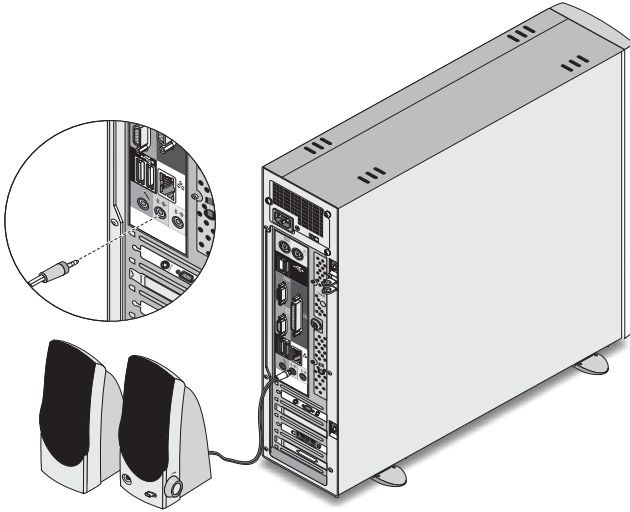

- audio line-in device: connect to the Audio-in/Line-in jack (light blue jack) located on the rear panel of your computer

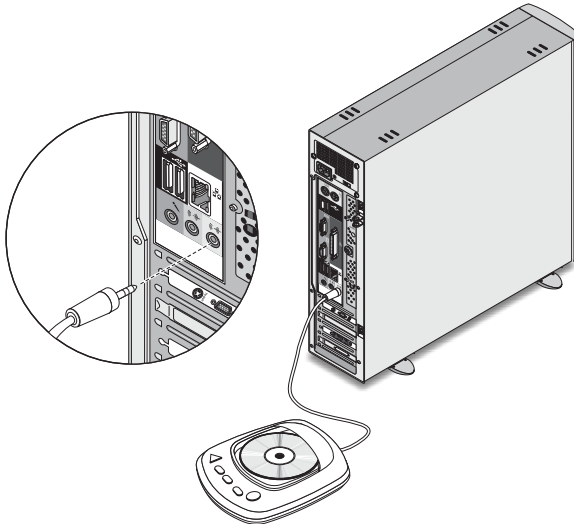

Connecting USB devices

Universal Serial Bus (USB) is a serial bus design that is capable of cascading peripherals such as a digital camera, keyboard, mouse, joystick, scanner, printer and modem. With USB, complex cable connections can be eliminated.

Your computer comes with six USB ports: two on the front and another four on the rear panel. These ports support USB 2.0 high-performance external devices such as webcams and digital still cameras. They also allow you to connect additional USB devices to your computer without using up its system resources.

To connect a USB device, simply plug the device cable into any of the USB ports  (black port).



.....
Note: The USB devices shown below are for your reference only. Actual device models may vary in select countries.

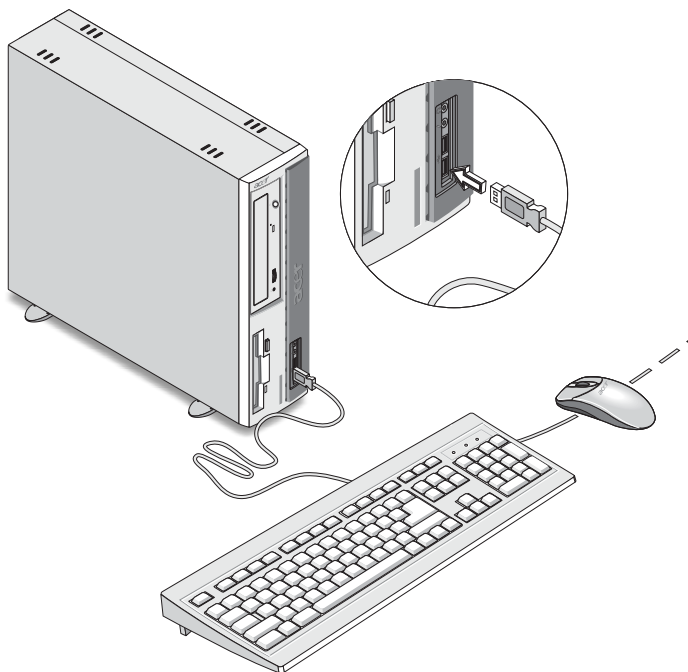

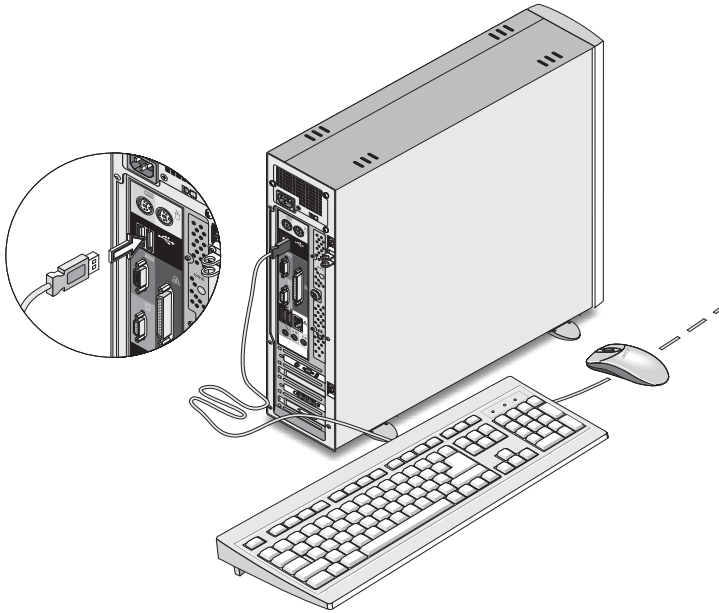

Note: Some USB devices have a built-in USB port which allows you to connect or daisy-chain more USB devices.

4 Upgrading your computer

This chapter contains instructions on how to upgrade your computer and basic information about your system boards that you will find helpful when performing the upgrade process.

Installation precautions

Before you install any computer component, we recommend that you read the following sections. These sections contain important ESD precautions along with preinstallation and post-installation instructions.

ESD precautions

Electrostatic discharge (ESD) can damage your processor, disk drives, expansion boards, and other components. Always observe the following precautions before you install a computer component:

- 1 Do not remove a component from its protective packaging until you are ready to install it.
- 2 Wear a wrist grounding strap and attach it to a metal part of the computer before handling components. If a wrist strap is not available, maintain contact with the computer throughout any procedure requiring ESD protection.

Preinstallation instructions

Always observe the following before you install any component:

- 1 Turn off your computer and all the peripherals connected to it before opening it. Then unplug all cables from the power outlets.
- 2 Open your computer according to the instructions on page 62.
- 3 Follow the ESD precautions described above before handling a computer component.
- 4 Remove any expansion boards or peripherals that block access to the DIMM sockets or component connector.
- 5 See the following sections for specific instructions on the component you wish to install.



.....
Warning! Not turning off the computer properly before you start installing the components may cause serious damage.

Do not attempt the procedures described in the following sections unless you are a qualified service technician.

Post-installation instructions

Observe the following after installing a computer component:

- 1 See to it that the components are installed according to the step-by-step instructions in their respective sections.
- 2 Replace any expansion boards or peripherals that you removed earlier.
- 3 Replace the computer cover.
- 4 Connect the necessary cables and turn on your computer.

Opening your computer



Caution: Before you proceed, make sure that you have turned off your computer and all peripherals connected to it. Read the "Preinstallation instructions" on page 60.

You need to open your computer before you can install additional components. See the following section for instructions.

To remove the computer cover

- 1 Turn off your computer and unplug all cables.
- 2 Place your computer on a flat, steady surface. If your computer is in the vertical position, remove the foot stands and place your computer in the regular desktop position.
- 3 Remove the two screws from the rear panel using a screwdriver (a) and set the screws aside.

Hold the sides of the cover with both hands.

Slide it back about an inch (b) and then gently lift it upward to detach it (c).

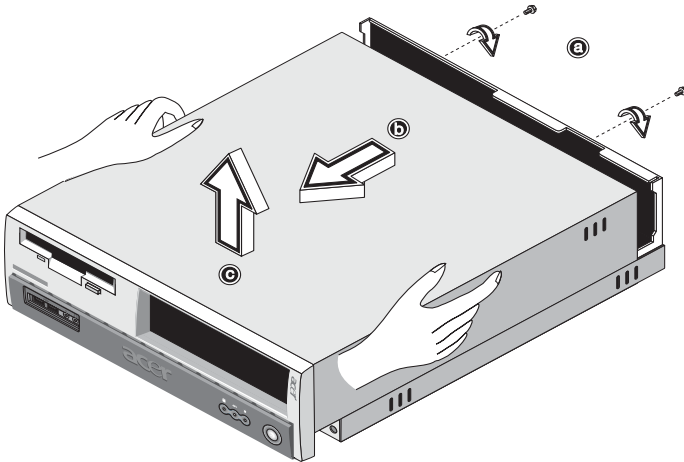

To replace the computer cover

- 1 Align the cover's hinges to the housing frame (a); then gently push it in to slide it back into place (b).

Secure the cover with two screws you removed earlier (c,d).

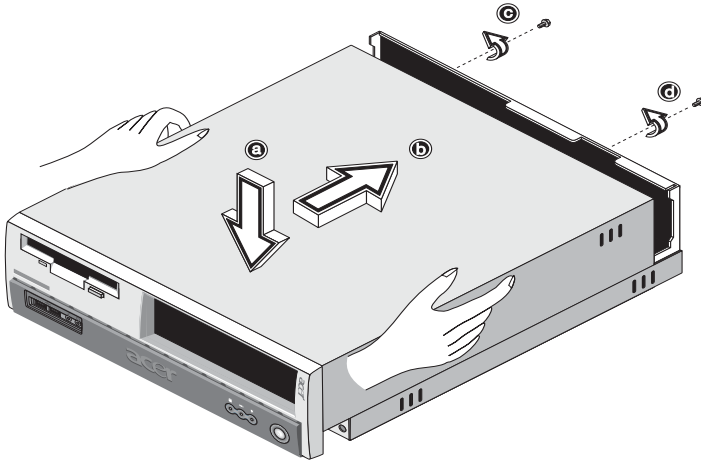

Internal components

The figure below shows what your computer looks like once you remove the cover:

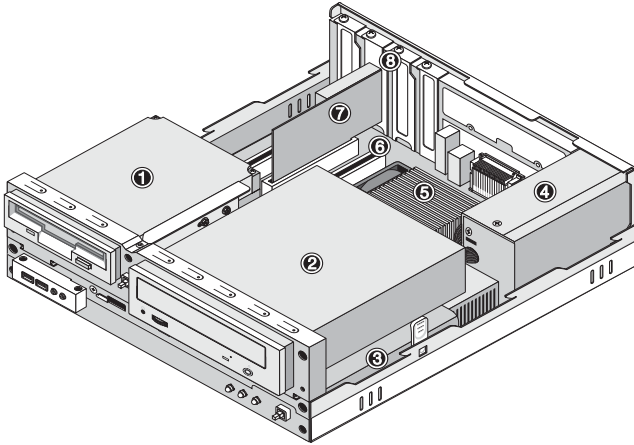

Number	Component
1	3.5-inch floppy drive
2	Optical drive
3	Drive frame
4	Power supply
5	Mainboard <small>see note</small>
6	VGA card
7	Modem card
8	Expansion slot



Note: The mainboard model shown in the figure above may not be exactly the same with the one found in your computer.

System boards

Mainboard layout

The mainboard becomes accessible once you open your computer. Refer to the section below for the corresponding mainboard layout of your Veriton 3600 series computer model.

Veriton 3600G mainboard layout

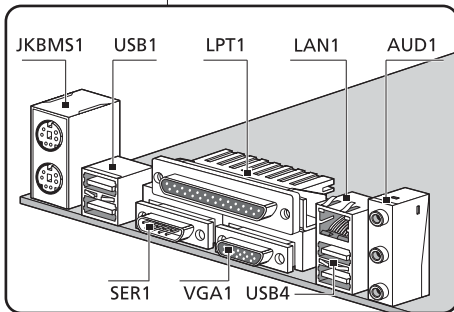
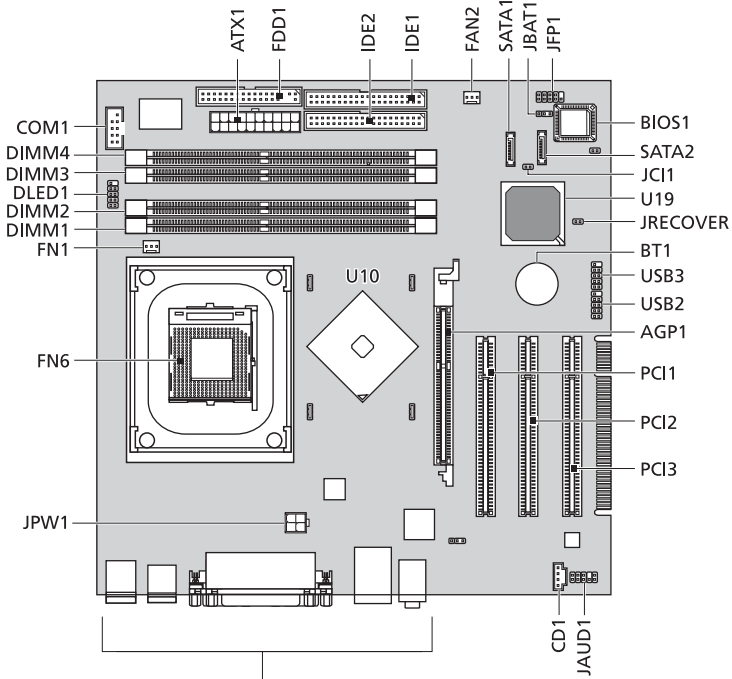

Label	Component
AGP1	AGP slot (VT3600G only) <i>see note</i>
AUD1	Line-in (top), line-out (middle), and rear microphone-in (bottom) ports
ATX1	Power connector
BIOS1	BIOS chipset
BT1	Battery
CD1	CD-in connector
COM1	Serial connector
DLED1	D-Bracket (LANScope) connector
DIMM1 DIMM2 DIMM3 DIMM4	DIMM sockets 1-4
FN1	3-pin CPU fan connector
FN6	CPU ZIF socket
FAN2	3-pin system fan connector
FDD1	FDD connector
IDE1	IDE 1 connector
IDE2	IDE 2 connector
JAUD1	Audio FPIO connector
JBAT1	1-2 Normal 2-3 Clear CMOS
JCI1	Intrusion connector

Label	Component
JFP1	HDD LED, Power LED connector Power button and Reset switch controller
JKBMS1	PS/2 mouse (upper) and keyboard (lower) ports
JPW1	Power connector (12V power)
JRECOVER	One Touch Recovery button connector
LPT1	Parallel/Printer port
PCI1 to PCI3	PCI slots 1 to 3
SATA1 SATA2	Serial HDD connectors
SER1	Serial port
U10	Northbridge
U19	Southbridge
USB1	USB ports
USB2	Front USB 2.0 connector or Unused
USB3	Front USB 2.0 connector or Unused
USB4	USB ports
VGA1	Monitor port (VT3600G only)



Note: For the location of the AGP slot on the Veriton 3600 mainboard, see page 65.

Audio board

The audio board that came with your computer should look like the figure that follows.

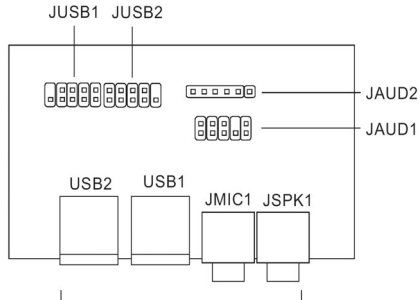

Label	Description
JUSB1	USB Connector - connects to the JUSB1 of the mainboard
JUSB2	USB Connector - unused
USB1	USB port
USB2	USB port
JAUD1	Standard audio connector - connects to the JAUD1 of the mainboard
JAUD2	Standard audio connector - unused
JMIC1	Microphone-in jack
JSPK1	Audio out port



Note: The system has two microphone-in jacks (front and rear). However, you can not use both of them at the same time. By default, your system enables the microphone-in jack in front and disables the one at the back.

Upgrading your computer

Certain components of your computer are upgradeable such as the memory, the hard disk, the CPU and the expansion cards. You need to observe the “Installation precautions” on page 60 when installing or removing a computer component. However, for safety purposes, we do not recommend that you perform these upgrades yourself. If you want to replace or upgrade any of these components, contact your dealer or a qualified service technician for assistance.



.....

Note: The mainboard model shown in the following figures may not be exactly the same with the one found in your computer.

Installing additional memory

The four 184-pin sockets on the mainboard support Double Data Rate (DDR) Synchronous Dynamic Random Access Memory (SDRAM)-type DIMMs. You may install 128-MB, 256-MB, 512-MB or 1-GB DIMMs for a maximum memory capacity of 4 GB.

The DDR DIMMs should work under 2.5 volts. You can install PC2100/DDR266, PC2700/DDR333, or PC3200/DDR400 modules in the DDR DIMM sockets. Contact your dealer for qualified DIMM vendors.

Each DDR DIMM socket is independent from the other. This independence allows you to install DDR DIMMs with different capacities to form different configurations.

To remove a DDR DIMM



.....

Note: The DDR DIMM has only one notch located on the center of the module.

- 1 Remove the computer cover (see page 62).
- 2 Locate the DDR DIMM socket on the mainboard.

- 3 Press the holding clips on both sides of the DDR DIMM socket outward to release the DDR DIMM (1,2). Gently pull the DDR DIMM out of the socket (3).

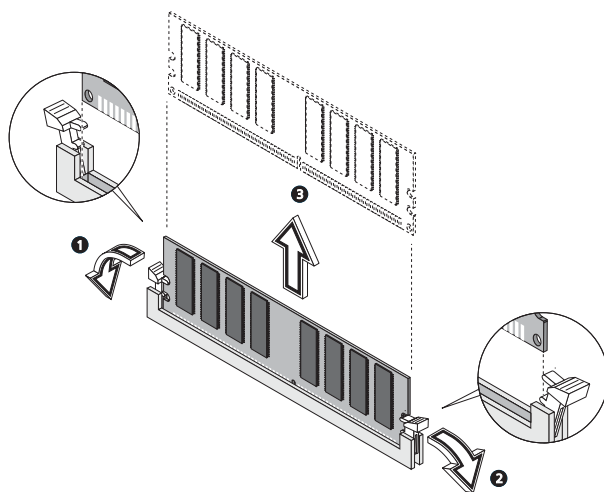

To install a DDR DIMM

- 1 Locate the DDR DIMM socket on the mainboard.

- Align the DDR DIMM with the socket (1). Press the DDR DIMM into the socket until the clips lock onto the DDR DIMM (2,3).

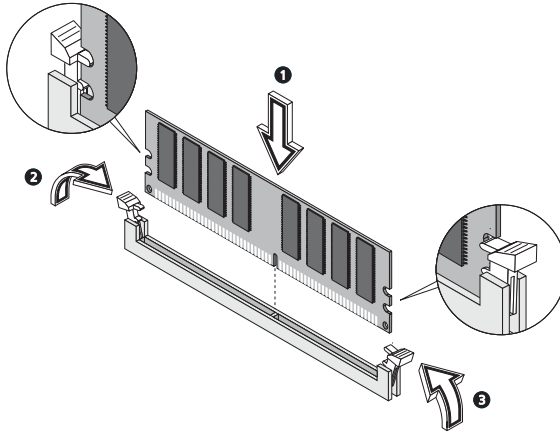

Note: The DDR DIMM sockets are slotted to ensure proper installation. If you insert a DDR DIMM but it does not fit easily into the socket, you may have inserted it incorrectly. Turn the DDR DIMM around and try to insert it again.

To reconfigure your computer

Your computer automatically detects the amount of memory installed. Run the BIOS utility to view the new value for total system memory and make a note of it.

Replacing the hard disk

Follow these steps to replace your computer's hard disk:

- Remove the computer cover (see page 62).
- Detach all cables connected to the CD or DVD drive and the 3.5-inch floppy drive.

- 3 Press the tabs (a) and (b) on both sides of the drive frame to release it from the housing.

Rotate the drive frame to a 90-degree angle (c); then pull out (d), and remove the drive frame (e).

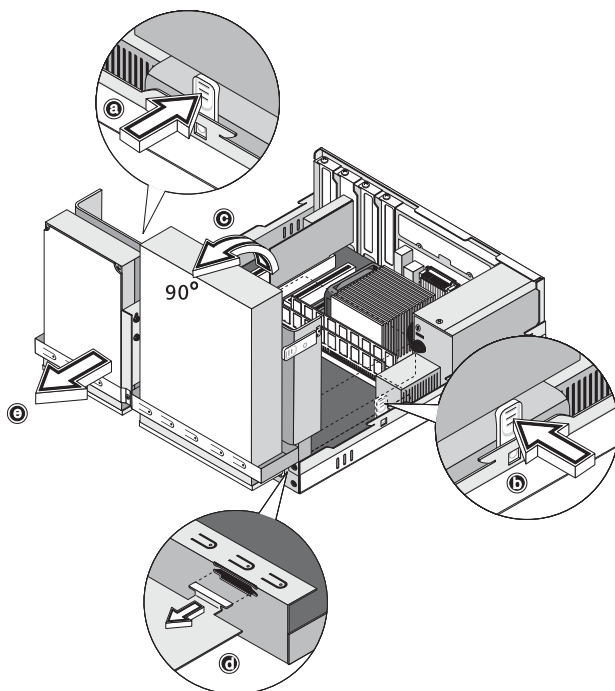

- 4 Detach hard disk cable (a) and power cable (b) from the hard disk. Then, remove the screw that holds the hard disk to the housing (c). Set the screw aside.

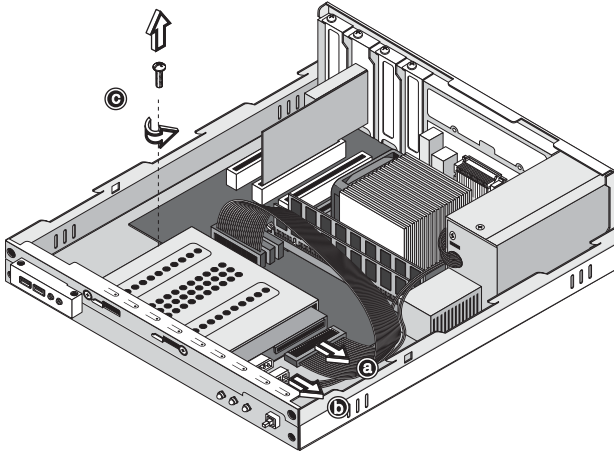

- 5 Slide the hard disk frame to the right (d); then gently move it inward (e) and pull it up to detach it (f).

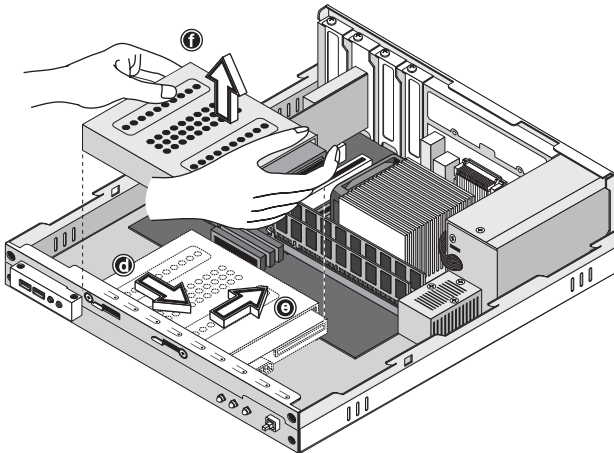

- 6 Install the new hard disk into the housing (a,b,c,d,e). Secure it with the screw you removed earlier (f) and connect the power and hard disk cables to the new hard disk (g,h).

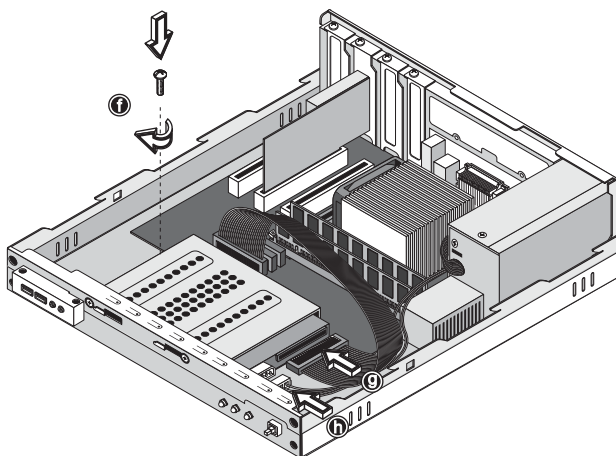
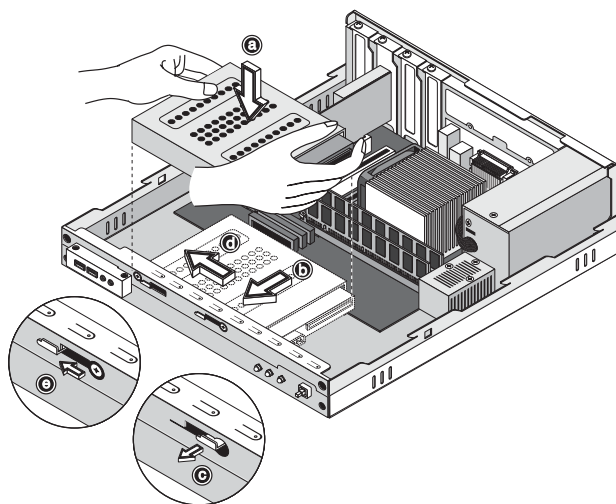

- 7 Reinstall the drive frame into the housing (i,j). Make sure the tabs on both sides snap into place.

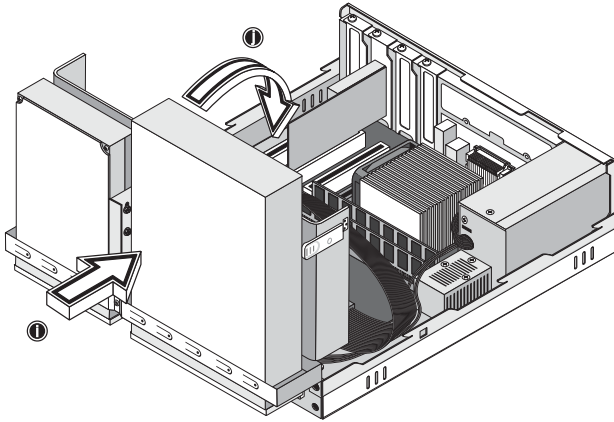

- 8 Reattach the CD or DVD drive and the floppy drive cables.



.....

Note: Make sure that the other ends of the disk drive cables are securely connected to their corresponding connectors on the mainboard.

- 9 Replace the computer cover (see page 63).

Installing an expansion card

To install an expansion card:



.....

Caution: Your system accepts low profile PCI cards only.

- 1 Remove the computer cover (see page 62).
- 2 Locate an empty PCI slot on the mainboard.
- 3 Remove the screw that holds the bracket to the computer. Save the screw.

- 4 Pull out the bracket on the housing opposite the selected empty slot.

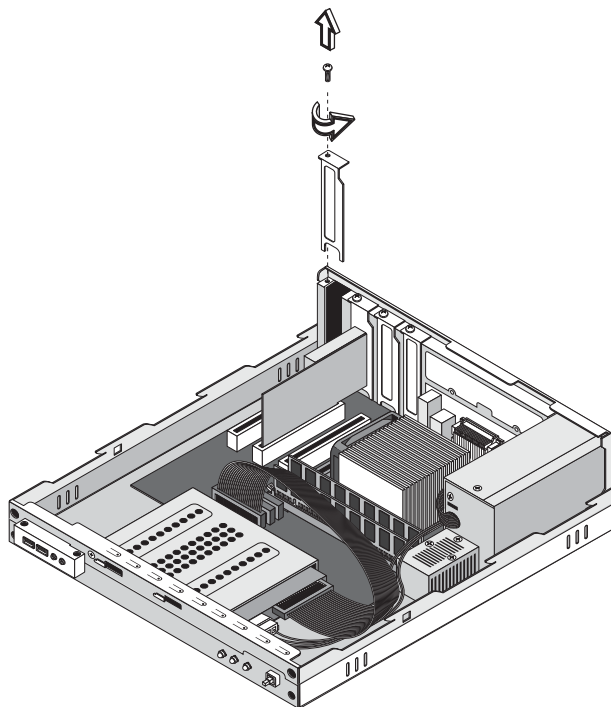

- 5 Remove the expansion card from its protective packaging.
- 6 Align the card with the empty bracket and then insert it into the slot. Make sure that the card is properly seated.

- 7 Secure the card to your computer with the screw you removed earlier.

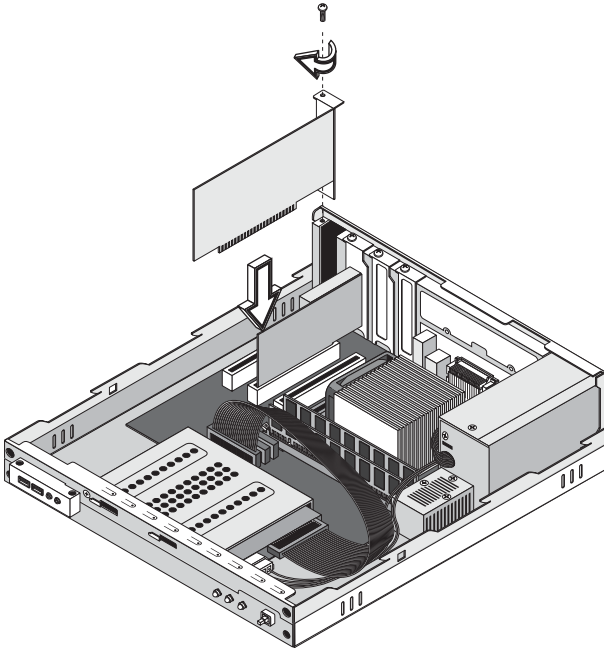

- 8 Replace the computer cover (see page 63).

When you turn on the computer, BIOS (Basic Input/Output System) automatically detects and assigns resources to the newly-installed devices.

5 System utilities

This chapter describes the applications that are preinstalled on your computer.

Depending on the hardware and optional features installed in your computer, your system came bundled with several program utilities designed to streamline your computer's operations. These utilities may include any of the following:

- Acrobat® Reader™
- Acer LANScope Client Manager (optional)
- Norton AntiVirus
- NTI CD-Maker
- PowerDVD
- BIOS utility
- Acer One-Touch Recovery (System restore utility)

If your computer is configured with Microsoft Windows XP the following utilities can be used to monitor and maintain system health.

- Backup
- Disk Defragmenter

All of the applications that came with your computer are very easy to use. However, if you need more help and information, you may refer to the online help documentation provided in each software application.

Acrobat Reader

Acrobat Reader is a software that lets you view, navigate, browse and print Adobe Portable Document Format (PDF) files on all major computer platforms.



To read a PDF document you can:

- Simply double click on any file with an icon like that shown above.
or
- 1 On the windows taskbar, click on the Start button, highlight Programs, and select Acrobat Reader.
- 2 Once the program is running, select Open from the File menu.
- 3 Select the file you wish to view in the Open file browser and click the Open button.

For more information about Acrobat Reader, you may refer to the Acrobat Reader Help menu.

Acer LANScope (optional)

Acer LANScope allows desktop management via the Web, standard network, or dial-up connections. It is compatible with the leading management specifications, such as Wired for Management 2.0, Desktop Management Interface (DMI) v2.0, and others.

Your computer may be bundled with a LANScope installation CD. To install LANScope:

- 1 Insert the LANScope installation CD into the optical drive.



.....
Caution! Make sure that the LANScope installation CD is properly inserted into the optical drive. Improper insertion may damage both the CD and the drive.

Refer to page 27 for instructions on how to insert a CD into your computer's optical drive.

- 2 Follow all onscreen instructions until installation is completed.

For more information on how to use the LANScope, you may refer to the LANScope Help menu.



.....
Note: Acer LANScope currently supports Windows 98, Windows Me, Windows 2000 and Windows XP platforms.

Norton AntiVirus

Norton AntiVirus is an anti-virus software which finds and repairs infected files, protects against viruses to keep your computer data safe and secure. It also scans incoming email attachments for viruses. It provides useful virus detection and repair facilities.

How do I check for viruses using Norton AntiVirus?

A full system scan scans all files on your computer. To perform a system scan:

- 1 Start Norton AntiVirus
 - Double click on the Norton AntiVirus Icon on the desktop
 - or
 - Click on the Start menu in the Windows taskbar, highlight Programs, and select Norton AntiVirus.
- 2 In the Norton AntiVirus main window, click Scan for Viruses.

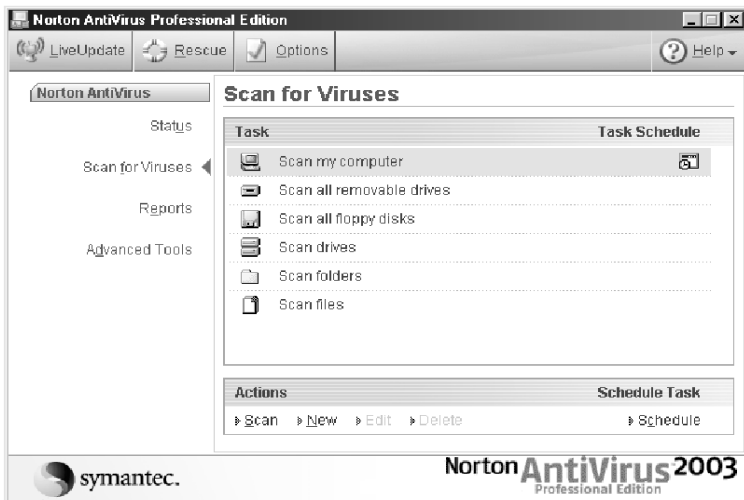

- 3 In the Scan for Viruses pane, click Scan My Computer.
- 4 Under Actions, click Scan.

When the scan is complete, a scan summary appears.

- 5 When you are done reviewing the summary, click Finished.

You can schedule customized virus scans that run unattended on specific dates and times or at periodic intervals. If you are using the computer when the scheduled scan begins, it runs in the background so that you do not have to stop working.

For more information about Norton AntiVirus, including setting up custom scans and scheduling scans, refer to the Norton AntiVirus Help menu.

NTI CD-Maker (for models with CD-RW)

The NTI CD-Maker is a CD-Recording software which allows you to create and copy audio, data and videos to CD-R or CD-RW discs.

To copy an audio or data disc:

- 1 Click the Quick Burning icon  on the desktop.
- 2 Insert the CD you would like to copy into the source drive and a blank disc into the target drive.
- 3 Choose the source and target drives from the pull-down lists.

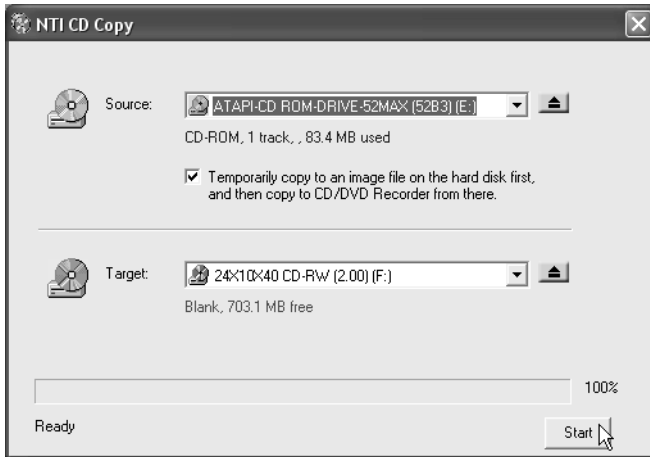

- 4 Click the Start button to begin copying.

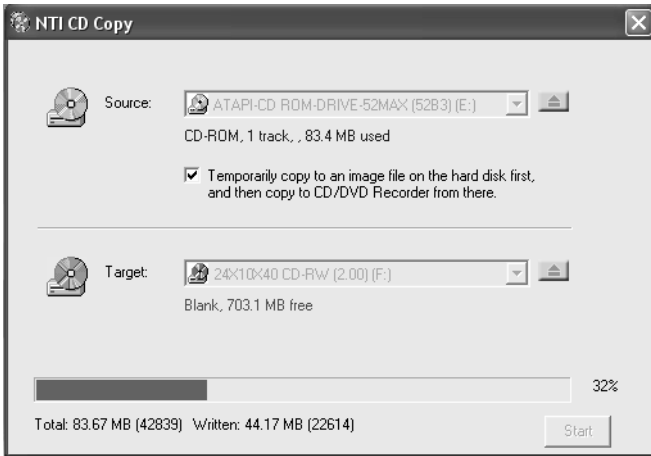

For more information about NTI CD-Maker and its other features, refer to the NTI CD-Maker Help menu.

PowerDVD (for models with DVD)

PowerDVD is a high-quality, pure software DVD player which brings high-quality movies and karaoke to your multimedia PC. You can play back high resolution DVD titles or MPEG-2 files with MPEG-2 video and Dolby Digital (AC-3) audio. PowerDVD provides a complete set of commands for navigation and advanced features such as multi-angle switching, multi-language and multi-subtitle selection, and parental control. It also has the i-Power Internet Enabling feature, which links to online DVD resources via the Power DVD Desktop Portal Page.

How do I open PowerDVD and watch a DVD?

In most cases, when you insert a DVD into your computer's optical drive, PowerDVD will automatically open a viewer window and the control panel and begin playing.



If PowerDVD does not open automatically:

- 1 Click the Start button in the taskbar.
- 2 Highlight All Programs
- 3 Click the Cyberlink PowerDVD tab
- 4 Select PowerDVD

When PowerDVD opens simply press the play button  to begin playback.

For more information about Cyberlink PowerDVD and its other features, refer to the PowerDVD Help menu.

BIOS utility

The BIOS utility is a hardware configuration program built into your computer's Basic Input/Output System (BIOS). Since most computers are already properly configured and optimized, there is no need to run this utility. However, if you encounter configuration problems and get the "Run Setup" message, you will need to run this utility.



.....
Note: Before you run BIOS, make sure that you have saved all open files. The computer reboots immediately after you exit Setup.

To run the BIOS utility, press the **Del** key on your keyboard during computer boot up.

Reinstalling programs

If you uninstall one of the preinstalled programs and want to reinstall it, do the following:

- 1 Make sure that the system is turned on.
- 2 Insert the System CD into the CD or DVD drive.
- 3 Select the application that you want to reinstall.
- 4 Follow all onscreen instructions until you finish the installation.

Recovering your system

If your operating system files are lost or damaged, the recovery process will restore your system's original factory default settings. Your Acer Veriton series computer includes a One Touch Recovery button, a feature that makes restoring your system quick and easy.

One Touch Recovery works from a hidden 2 GB partition on your hard drive that contains all the information required to restore your system.

There are two ways to initiate recovery. If your computer is not equipped with the (optional) One Touch Recover button, you can press Alt + F10 after the BIOS finishes running the Power On Self Test (POST).



.....

Warning: Initiating the recovery operation while the operating system is running will result in abnormal shutdown and may make your current OS unstable or unusable.

After the POST runs, you have only 1.5 seconds to press Alt + F10. Follow all onscreen instructions.

You can also follow the steps below:

- 1 Locate the (optional) One touch recovery button. See the image on page 14.

- 2 Press the button. After a moment the following screen will appear on your display.

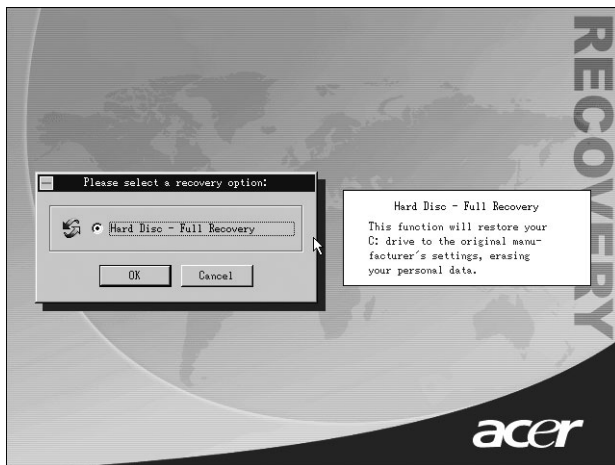

- 3 Click OK. You will be prompted again to continue.



- 4 Click OK again.



- 5 After 15 seconds the system will reboot and initiate the restore operation.

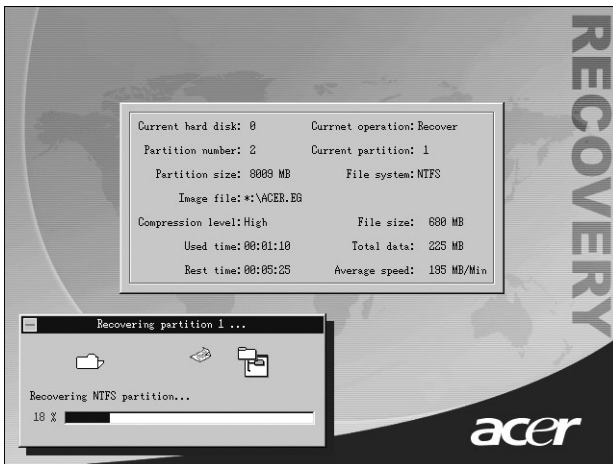

- 6 After the recovery operation finishes the system will reboot again. You will be required to go through the setup process again.



Caution! Running the Recovery operation will erase all files previously saved in your computer so make sure to back up your important files before starting the recovery process.

If you attempt to restore your system using the One Touch feature, and the system DOES NOT respond, contact your local vendor or authorised Acer representative immediately.

Using Backup (Windows XP only)

The Backup utility creates copies of information on your hard disk. In the event that the original data on your hard disk is erased or overwritten, or becomes inaccessible because of a hard disk malfunction, you can use the copy to restore your lost or damaged data.

How do I back up files from my hard drive?

To run the Backup utility:

- 1 Click the Start button in the taskbar.
- 2 Highlight All Programs
- 3 Click Accessories
- 4 Select System Tools
- 5 Click Backup

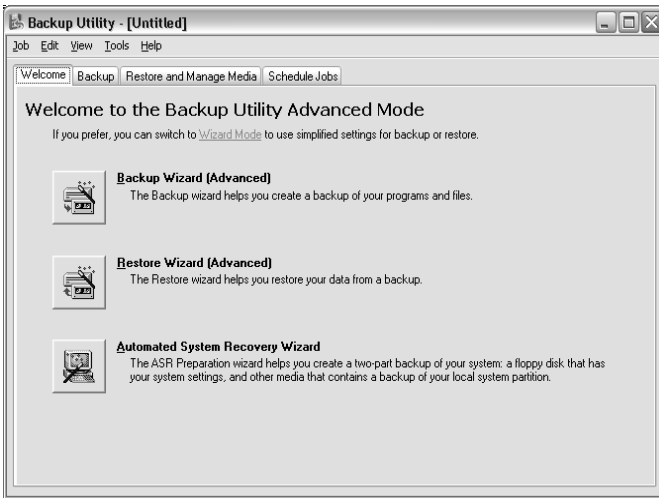

When Backup starts, follow the onscreen instructions to set up your backup profile and schedule.

For more information about Backup, refer to Windows XP help.

Disk Defragmenter (Windows XP only)

The disk defragmentation utility consolidates files and folders on your computer's hard disk. This allows your computer to access files and folders and save new data more efficiently. By consolidating your files and folders, the defragmenter also consolidates the volume's free space, making it less likely that new files will be fragmented.

How do I defragment my hard drive?

To run the Disk Defragmenter:

- 1 Click the Start button in the taskbar.
- 2 Highlight All Programs
- 3 Click Accessories
- 4 Select System Tools
- 5 Click Disk Defragmenter

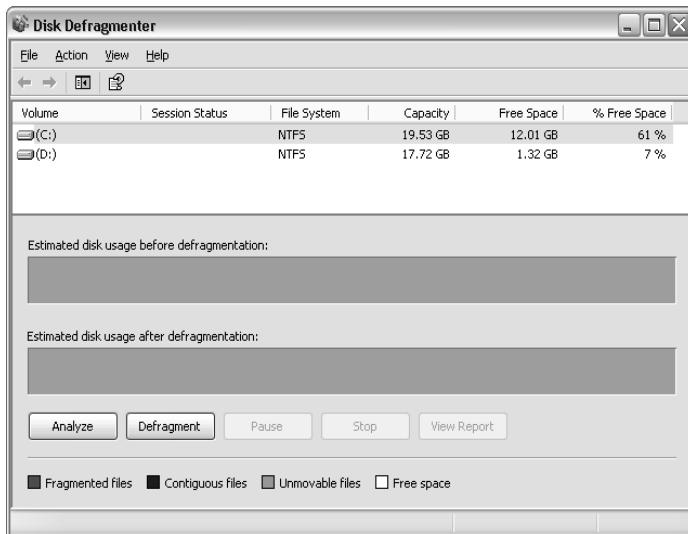

When Disk Defragmenter opens, select a drive/volume and click Analyze. The system will quickly examine the volume and determine whether it needs to be defragmented or not.

For more information about Disk Defragmenter, refer to Windows XP help.

6 Frequently asked questions

This chapter tells you what to do in case your computer is not working properly. However, if a more serious problem arises, contact your dealer or the technical support center (www.acersupport.com) for assistance.

The following questions are possible situations that may arise during the use of your computer and each is followed by easy answers and solutions to the situation.

Q: I pressed the power switch but the system did not boot up.

A: Check the LED located beside the power switch.

If the LED is not lit, no power is being applied to the system. Do any of the following:

- Check if the voltage selector switch located on the rear panel of the computer is set to the correct voltage.
- Check if you plugged the power cable properly into an electrical outlet.
- If you are using a power strip or AVR, make sure that it is plugged in and turned on.

If the LED is lit, check the following:

- Is a nonbootable (nonsystem) diskette in the floppy drive? If yes, remove or replace it with a system diskette and press **Ctrl + Alt + Del** to restart your computer.
- The operating system files may be damaged or missing. Insert the startup disk you created during Windows setup into the floppy drive and press **Ctrl + Alt + Del** to restart your computer. This will automatically diagnose your system and make necessary fixes. However, if the diagnostic utility still reports a problem, then you may have to perform the recovery process to restore your system to its original default factory settings.



.....
Note: For more information about recovering your system, refer to page 92.

Q: Nothing appears on the screen.

A: Your computer's power management function automatically blanks the screen to save power. Just press any key to turn the display back on.

If pressing a key does not work, contact your dealer or the technical support center for assistance.

Q: The printer does not work.

A: Do the following:

- Make sure that the printer is connected to a power outlet and that it is turned on.
- Make sure that the printer cable is connected securely to the system's parallel port and the corresponding port on the printer. See "Connecting your printer" on page 49 for information on how to connect the printer to your computer.
- For additional information concerning the printer, refer to the printer's documentation.

Q: No sound comes out from the computer.

A: Check the following:

- The volume may be muted. Look for the Volume icon on the taskbar. If it is crossed-out, click on the icon and deselect the **Mute** option. You can also press the volume control/mute knob on your USB keyboard to toggle from mute to sound on.
- If headphones, earphones, or external speakers are connected to the line-out jack of your computer, the internal or built-in speakers are automatically turned off.

Q: System cannot read diskette, hard disk, CD or DVD information.

A: Check the following:

- Make sure that you are using the correct type of disc. See page 29.
- Make sure the CD or DVD is inserted into the drive correctly.
- Check if the CD or DVD is clean and not scratched.
- Check your drive by using a good (i.e., undamaged) disc. If your drive can not read the information on the good disc there may be a problem with the drive. Contact your dealer or technical support center for assistance.

Q: System cannot write data on the hard disk or CD-R/CD-RW.

A: Check the following:

- Make sure the diskette or hard disk is not write-protected. Refer to the Optical drive section on page 29.
- Make sure that you are using the correct type of disc or diskette. Refer to the Optical drive section on page 29.

Appendix A: Notices

FCC notice

This device has been tested and found to comply with the limits for a Class B digital device pursuant to Part 15 of the FCC Rules. These limits are designed to provide reasonable protection against harmful interference in a residential installation. This device generates, uses, and can radiate radio frequency energy and, if not installed and used in accordance with the instructions, may cause harmful interference to radio communications.

However, there is no guarantee that interference will not occur in a particular installation. If this device does cause harmful interference to radio or television reception, which can be determined by turning the device off and on, the user is encouraged to try to correct the interference by one or more of the following measures:

- Reorient or relocate the receiving antenna
- Increase the separation between the device and receiver
- Connect the device into an outlet on a circuit different from that to which the receiver is connected
- Consult the dealer or an experienced radio/television technician for help

Notice: Shielded cables

All connections to other computing devices must be made using shielded cables to maintain compliance with FCC regulations.

Notice: Peripheral devices

Only peripherals (input/output devices, terminals, printers, etc.) certified to comply with the Class B limits may be attached to this equipment. Operation with noncertified peripherals is likely to result in interference to radio and TV reception.



.....
Caution: Changes or modifications not expressly approved by the manufacturer could void the user's authority, which is granted by the Federal Communications Commission, to operate this computer.

Use conditions

This part complies with Part 15 of the FCC Rules. Operation is subject to the following two conditions: (1) this device may not cause harmful interference, and (2) this device must accept any interference received, including interference that may cause undesired operation.

Notice: Canadian users

This Class B digital apparatus meets all requirements of the Canadian Interference-Causing Equipment Regulations.

Remarque à l'intention des utilisateurs canadiens

Cet appareil numérique de la classe B respecte toutes les exigences du Règlement sur le matériel brouilleur du Canada.

Important safety instructions

Read these instructions carefully. Save these instructions for future reference.

- 1 Follow all warnings and instructions marked on the product.
- 2 Unplug this product from the wall outlet before cleaning. Do not use liquid cleaners or aerosol cleaners. Use a damp cloth for cleaning.
- 3 Do not use this product near water.
- 4 Do not place this product on an unstable cart, stand, or table. The product may fall, causing serious damage to the product.
- 5 Slots and openings in the housing and the back or bottom are provided for ventilation; to ensure reliable operation of the product and to protect it from overheating, these openings must not be blocked or covered. The openings should never be blocked by placing the product on a bed, sofa, rug, or other similar surface. This product should never be placed near or over a radiator or heat register, or in a built-in installation unless proper ventilation is provided.
- 6 This product should be operated from the type of power indicated on the marking label. If you are not sure of the type of power available, consult your dealer or local power company.
- 7 Do not allow anything to rest on the power cord. Do not locate this product where persons will walk on the cord.
- 8 If an extension cord is used with this product, make sure that the total ampere rating of the equipment plugged into the extension cord does not exceed the extension cord ampere rating. Also, make sure that the total rating of all products plugged into the wall outlet does not exceed the fuse rating.
- 9 Never push objects of any kind into this product through cabinet slots as they may touch dangerous voltage points or short out parts that could

- result in a fire or electric shock. Never spill liquid of any kind on the product.
- 10 Do not attempt to service this product yourself, as opening or removing covers may expose you to dangerous voltage points or other risks. Refer all servicing to qualified service personnel.
 - 11 Unplug this product from the wall outlet and refer servicing to qualified service personnel under the following conditions:
 - a. When the power cord or plug is damaged or frayed
 - b. If liquid has been spilled into the product
 - c. If the product has been exposed to rain or water
 - d. If the product does not operate normally when the operating instructions are followed. Adjust only those controls that are covered by the operating instructions since improper adjustment of other controls may result in damage and will often require extensive work by a qualified technician to restore the product to normal condition.
 - e. If the product has been dropped or the cabinet has been damaged
 - f. If the product exhibits a distinct change in performance, indicating a need for service.
 - 12 Replace the battery with the same type as the product's battery we recommend. Use of another battery may present a risk of fire or explosion. Refer battery replacement to a qualified serviceman.
 - 13 **Warning!** Batteries may explode if not handled properly. Do not disassemble or dispose of them in fire. Keep them away from children and dispose of used batteries promptly.
 - 14 Use only the proper type of power supply cord set (provided in your accessories box) for this unit. It should be a detachable type: UL listed/CSA certified, type SVT, rated 7A 125V minimum, VDE approved or its equivalent. Maximum length is 15 feet (4.6 meters).

Laser compliance statement

The CD or DVD drive in this computer is a laser product. The CD or DVD drive's classification label (shown below) is located on the drive.

CLASS 1 LASER PRODUCT

CAUTION: INVISIBLE LASER RADIATION WHEN OPEN. AVOID EXPOSURE TO BEAM.

Lithium battery statement

CAUTION

Danger of explosion if battery is incorrectly replaced. Replace only with the same or equivalent type recommended by the manufacturer. Discard used batteries according to the manufacturer's instructions.

Macrovision® statement

This product incorporates copyright protection technology that is protected by method claims of certain U.S. patents and other intellectual property rights owned by Macrovision Corporation and other rights owners. Use of this copyright protection technology must be authorized by Macrovision Corporation, and is intended for home and other limited viewing uses only unless otherwise authorized by Macrovision Corporation. Reverse engineering or disassembly is prohibited.

Year 2000 compliance statement

The Veriton 3600 series computer carries the "Hardware NSTL Tested Year 2000 Compliant" logo, which certifies that this model has been tested by NSTL using the YMark2000 test, and has been found to meet NSTL's standards for Year 2000 hardware compliance.



Appendix B:
Taking care
of your
computer

Please read the important instructions listed in this section. Following these instructions will help you maximize the durability of your computer.

Important tips

- Do not expose the computer to direct sunlight. Do not place it near sources of heat, such as a radiator.
- Do not expose the computer to temperatures below 0°C (32°F), or above 50°C (122°F).
- Do not subject the computer to magnetic fields.
- Do not expose the computer to rain or moisture.
- Do not spill water on the computer.
- Do not subject the computer to heavy shock or vibration.
- Do not expose the computer to dust and dirt.
- Never place the system on uneven surfaces.
- Do not step on the power cord or place heavy objects on top of it. Carefully route the power cord and any cables away from personal traffic.
- When unplugging the power cord, do not pull on the cord itself but pull on the plug.
- The total ampere rating of the equipment plugged in should not exceed the ampere rating of the cord if you are using an extension cord. Also, the total current rating of all equipment plugged into a single wall outlet should not exceed the fuse rating.
- Check the documentation that came with your software programs to see if you can select other combinations of resolution and color. These adjustments could make viewing the screen more comfortable.

Cleaning and servicing

To clean your computer and keyboard

- 1 Turn off the computer and unplug the power cord.

- 2 Use a soft cloth moistened with water and gently wipe the exterior of the computer and the keyboard. Do not use liquid or aerosol cleaners.

To clean your pointing device

To clean a regular mouse (with rubber ball)

- 1 Open the circular cover underneath the mouse.
- 2 Take out the rubber ball and wipe it with a soft, damp cloth.
- 3 Put the ball back and close the cover.

To clean an optical mouse

For users of an optical mouse, refer to the documentation that came with your mouse for maintenance instructions.

To clean your monitor

Make sure that you keep your screen clean. For cleaning instructions, refer to the documentation that came with your monitor.

When to contact a service technician

- If you dropped and damaged the computer
- If liquid has been spilled into the computer
- If the computer is not operating normally
- If a computer problem persists even after you have checked and done the troubleshooting tips discussed in the “Frequently-asked questions” section on page 99.
- If your problem is not listed in the “Frequently-asked questions” section on page 99.
- If you want to replace or upgrade any of your computer’s internal components

Asking for technical assistance

For technical assistance, contact your local dealer or distributor. You may also access the Web site (www.acersupport.com) for information on how and where to contact the service centers available in your area.

Index

A

- accessing the user's guide 7
- applications 82

B

- BIOS utility 90

C

- computer maintenance 112
 - cleaning 112
 - servicing 112
- connecting options
 - multimedia devices 52
 - audio line-in device 54
 - earphones/headphones 53
 - external speakers 52
 - joystick 52
 - microphone 52
 - network 49, 51
 - printer 49
 - USB devices 55

D

- disk drives
 - CD-ROM/DVD-ROM/CD-RW drive
 - inserting CDs/DVDs 29
 - taking care CDs/DVDs 30
 - hard disk 31

F

- features 12
 - connectivity 12
 - multimedia 12
 - performance 12
- frequently asked questions 102
 - blank screen 103
 - no audio 103
 - no sound 103
 - printer not working 103
 - system did not boot up 102
- Frequently-asked questions
 - system cannot read disk 104
 - system cannot write to disk 104
- front panel 14

I

- internal components 64
- internet/suspend key
 - email 22
 - suspend 22
 - web browser 22

K

- keyboard 20
 - application key 27
 - caps lock 21
 - cursor keys 20
 - function keys 21
 - internet/suspend keys 20
 - multimedia keys 20
 - num lock key 20
 - programmable keys 20
 - scroll lock key 20
 - volume control/mute knob 20
 - Windows logo key 21

L

- lock keys
 - caps lock 25
 - num lock 25
 - scroll lock 25

M

- mainboard
 - Veriton 3600 66
- multimedia key
 - forward 23
 - play/pause 23
 - stop 23

N

- NTI 87

P

- PowerDVD 89

R

- rear panel 16, 18
- recovering your system 92
- remove computer cover 62

S

- setting up computer 36, 41
 - area 36
 - chair 36

- connecting peripherals
 - external monitor 45
 - power cable 46
 - USB keyboard 43
 - USB mouse 41
- keyboard 39
- monitor 39
- mouse 40
- software 82
- system boards 65
 - audio board 69
 - mainboard 65, 66
- system utilities
 - Acrobat Reader 83
 - NTI CD-Maker 87, 89
 - PowerDVD 89
 - reinstalling programs 91

T

- turning off computer 48
 - software shutdown 48

- suspend mode 48
- turning on computer 47
 - power button 47

U

- upgrade
 - add memory 70
 - install DDR DIMM 71
 - reconfigure computer 72
 - remove DDR DIMM 70
 - computer 65, 70
 - installation precautions 60
 - ESD 60
 - post-installation 61
 - preinstallation 60
 - open computer 62
 - remove computer cover 62
 - replace top cover 63
 - replace components 65
 - memory 70