

Veriton 5800/6800/7800 Series

User's Guide

Copyright © 2005. Acer Incorporated.
All Rights Reserved.

Veriton 5800/6800/7800 Series User's Guide
Original Issue: March 2005

Changes may be made periodically to the information in this publication without obligation to notify any person of such revisions or changes. Such changes will be incorporated in new editions of this manual or supplementary documents and publications. This company makes no representations or warranties, either expressed or implied, with respect to the contents hereof and specifically disclaims the implied warranties of merchantability or fitness for a particular purpose.

Record the model number, serial number, purchase date, and place of purchase information in the space provided below. The serial number and model number are recorded on the label affixed to your computer. All correspondence concerning your unit should include the serial number, model number, and purchase information.

No part of this publication may be reproduced, stored in a retrieval system, or transmitted, in any form or by any means, electronically, mechanically, by photocopy, recording, or otherwise, without the prior written permission of Acer Incorporated.

Veriton 5800/6800/7800 Series Desktop Computer

Model number: _____

Serial number: _____

Purchase date: _____

Place of purchase: _____

Acer and the Acer logo are registered trademarks of Acer Incorporated. Other companies' product names or trademarks are used herein for identification purposes only and belong to their respective companies.

Contents

1 First things first	1
Specifications	3
Package contents	5
Accessing the User's Guide	5
2 System tour	7
Features	9
Performance	9
Multimedia	9
Connectivity	9
Front panel	10
Rear panel	12
Keyboard	15
Internet/Email/Search keys	16
Multimedia keys	16
Volume control / Mute keys	17
Lock keys	17
Cursor keys	18
Windows keys	18
Function keys	19
Palm rest	19
Optical drive	20
Taking care of your CDs and DVDs	22
Hard disk	22
3 Setting up your computer	23
Arranging a comfortable work area	25
Adjusting your chair	25
Positioning your PC	25
Positioning your monitor	26
Positioning your keyboard	26
Positioning your mouse	26
Connecting peripherals	27
Connecting your mouse and keyboard	27
USB interface	27
PS/2 interface	27
Connecting a monitor	28
Connecting the power cable	29

Turning on your computer	30
Turning off your computer	30
Connecting options	31
Connecting your printer	31
Connecting the modem (optional)	32
Connecting to the network	32
Connecting multimedia devices	33
Connecting USB devices	35
4 Upgrading your computer	37
Installation precautions	39
ESD precautions	39
Preinstallation instructions	39
Post-installation instructions	40
Opening your Veriton 5800	41
To remove the computer cover	41
To replace the computer cover	41
Opening your Veriton 6800/7800	42
To remove the side panel	42
To replace the side panel	43
System boards	44
Mainboard layout	44
Upgrading your computer	46
Installing additional memory	46
To remove a DDR2 DIMM	46
To install a DDR2 DIMM	47
To reconfigure your computer	48
Replacing Veriton 5800's hard disk	48
Installing an expansion card	49
Replacing Veriton 6800/7800's hard disk	50
Installing an expansion card	51
5 System utilities	53
Adobe Reader	55
LANDesk System Manager	56
Norton AntiVirus	57
How do I check for viruses?	57

NTI CD&DVD-Maker (for models with CD or DVD Burner)	58
PowerDVD (for models with DVD)	59
How do I open and watch a DVD?	59
BIOS utility	60
Reinstalling programs	60
Recovering your system	60
Acer eManager	64
Acer eLock	65
Acer eSettings	66
Acer eRecovery	67
Using backup (Windows XP only)	68
How do I back up files from my hard drive?	68
Disk defragmenter (Windows XP only)	69
How do I defragment my hard drive?	69
6 Frequently asked questions	71
Frequently asked questions	73
Appendix A: Notices	75
ENERGY STAR guidelines compliance	76
FCC notice	76
Notice: Canadian users	77
Declaration of Conformity for EU countries	77
Modem notices	77
Notice for USA	77
TBR 21	78
Notice for Australia	78
Important safety instructions	78
Macrovision copyright protection notice	80
Lithium battery statement	80
Laser compliance statement	81
Federal Communications Commission	
Declaration of Conformity	82
Declaration of Conformity for CE marking	83
Appendix B: Taking care of your computer	85
Important tips	86

Cleaning and servicing	86
To clean your computer and keyboard	86
To clean your pointing device	87
To clean your monitor	87
When to contact a service technician	87
Asking for technical assistance	87
Index	89

1 First things first

This chapter describes the system specifications and contents of your computer package.

Specifications

Operating system	Microsoft® Windows® XP Professional Microsoft® Windows® XP Home Edition
Platform	Intel® Celeron® with 533 MHz FSB Intel® Pentium® 4 with 800/1066 MHz FSB
Chipset	Intel® 945G Express
System memory	Supporting up to 4 GB of DDR2 667 RAM Dual channels supported on four DIMMs
Drives	Veriton 5800: <ul style="list-style-type: none"> • Two external 5.25" drive bays • Three 3.5" drive bays (two internal, one external) Veriton 6800: <ul style="list-style-type: none"> • Four external 5.25" drive bays • Six 3.5" drive bays (four internal, two external) Veriton 7800: <ul style="list-style-type: none"> • Four external 5.25" drive bays • Five 3.5" drive bays (four internal, one external)
Network interface	Marvell® 88E8052 with gigabit Ethernet Optional PCI modem
I/O interface	Two PS/2 ports 9-pin serial port 25-pin parallel port Eight USB 2.0 ports Ethernet (RJ-45) port VGA port Six audio jacks
I/O expansion	Two PCI slots PCI Express™ X1 slot
Graphics	Integrated graphics with DVMT 3.0 PCI Express™ X16 slot

Audio	Realtek ALC880 with embedded Intel® HDA CODEC
Keyboard	PS/2 or USB multimedia keyboard
Monitor	Choice of Acer CRT or LCD monitors
Security	Acer eLock Lock pad and intrusion alert
Housing	Veriton 5800 Series: 370 (H) x 130.2 (W) x 435 (D) mm Veriton 6800 Series: 360 (H) x 180 (W) x 420 (D) mm Veriton 7800 Series: 438.5 (H) x 186 (W) x 475 (D) mm
Management software	LANDesk® System Manager Norton AntiVirus™ Acer Desktop eManager
Industry standards	PC2001 SMBIOS (DMI) 2.3.1 PCI 2.3 WFM 2.0 ACPI 2.0 Microsoft® OnNow ENERGY STAR MacroVision
Power supply	300 W
Certification	FCC, CE, C-tick, BSMI, VCCI, CCC, cUL, UL, Nemko, GS (TUV), ENERGY STAR



Note: The specifications listed above are for reference only. The exact configuration of your PC depends on the model purchased.

Package contents

Before you unpack your computer, make sure that you have enough space to set up your computer.

Carefully unpack the carton and remove the contents. If any of the following items are missing or damaged, contact your dealer immediately:

- Veriton series
- Items contained in the accessory box
 - USB or PS/2 keyboard
 - USB or PS/2 mouse
- User's Guide and installation poster
- Other user documentation and third-party software

Accessing the User's Guide

This User's Guide is also available on your computer as an Adobe Acrobat PDF file.

To access the User's Guide (for Windows XP)

- 1 On the Windows XP taskbar, click on the **start** button then select **Help and Support**.
- 2 On the Help and Support Center home page, double-click the Veriton Series Online icon.

2 System tour

This chapter discusses the features and components of your computer.

Features

Here are just a few of your computer's many features:

Performance

- Intel® Celeron® supporting FSB up to 533 MHz, or Intel® Pentium® 4 supporting FSB (front side bus) up to 800/1066 MHz
- Intel® 945G Express chipset
- DDR2-SDRAM 667, 4 DIMM slots, expandable to 4 GB dual-channel memory
- Power management function
- CD-ROM, CD-RW, DVD-ROM, DVD/CD-RW combo, DVD-Dual or DVD-Super multi drive
- High-capacity, Enhanced-IDE hard disk

Multimedia

- Intel® high-definition audio
- Supporting up to 7.1 surround sound, audio codec support for 192 KHz quality, multiple streams.
- 3D quality audio system via onboard audio controller
- Audio-in/line-in, audio-out/line-out, headphone-out and microphone-in interfaces

Connectivity

- Two PS/2 interfaces for mouse and keyboard
- One serial port (optional 2nd serial port connection)
- One parallel port
- One VGA port
- Eight Universal Serial Bus (USB) 2.0 ports (four on the front; four on the rear panel)
- High-speed V.92, 56K fax/modem (manufacturing option)
- Gigabit Ethernet LAN support with remote wake-up function

Front panel

Your computer's front panel consists of the following:

Veriton 5800

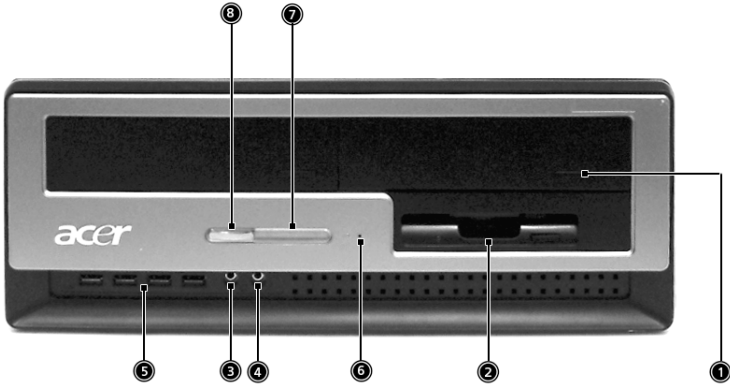

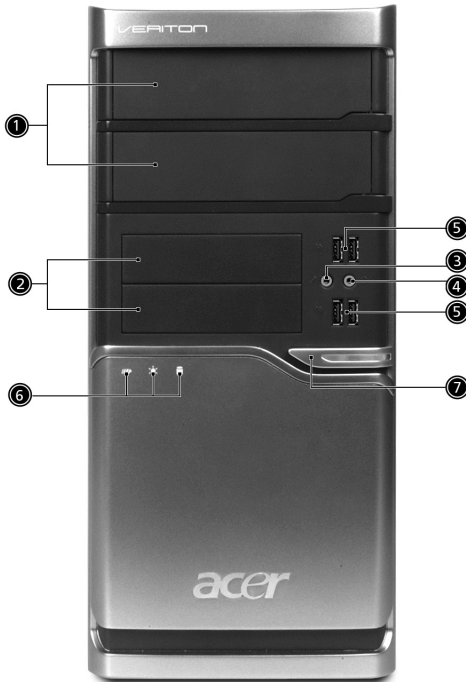

Veriton 6800

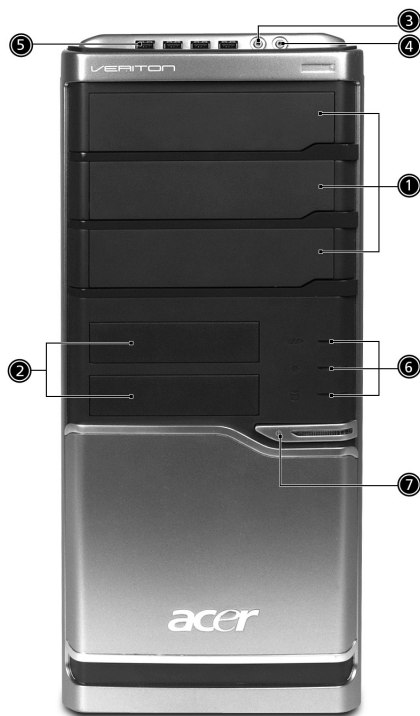

Veriton 7800



Icon	Component	Veriton 5800	Veriton 6800/7800
	5.25-inch drive bay(s)	1	1
	3.5-inch floppy drive	2	2
	Microphone-in jack (front)	3	3
	Speaker-out/line-out port	4	4
	USB ports	5	5
	OneButton Recovery hole	6	
	Indicators	7	6
	Power button	8	7

Rear panel

Your computer's rear panel consists of the following:

Veriton 5800

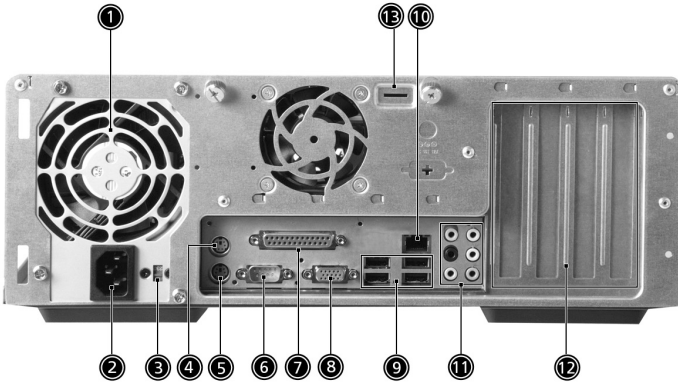



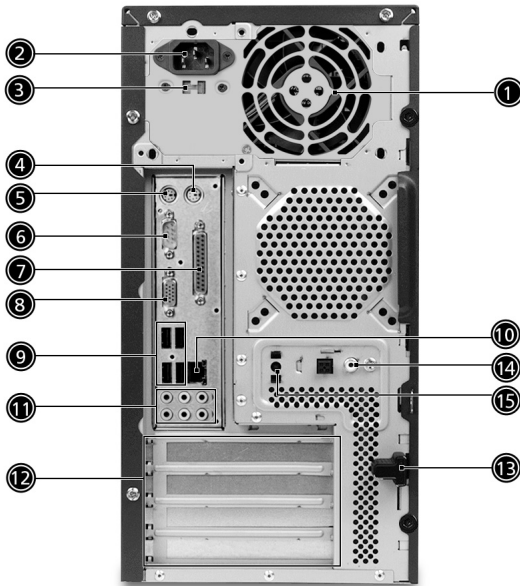

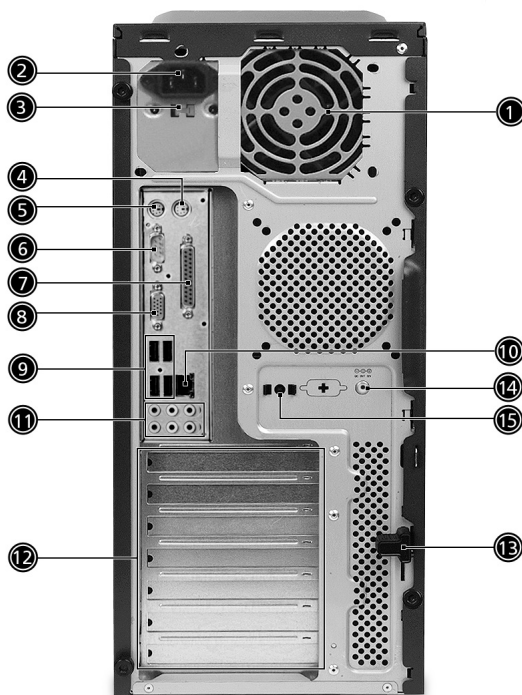

Veriton 6800





Veriton 7800



Icon	Component	Veriton 5800/6800/7800
	Power supply	1
	Power cord socket	2
	Voltage selector switch	3
	PS/2 mouse port	4
	PS/2 keyboard port	5
	Serial port	6
	Parallel/Printer port	7
	CRT/LCD monitor port	8
	USB ports	9
	Network port	10

Icon	Component	Veriton 5800/6800/7800
	Audio jack	11
	Expansion slots	12
	Chassis lock pad	13

Audio jacks function table

Color/Use	Headphone	1.1 CH	3.1 CH	5.1 CH	7.1 CH
Blue 	Line-in	Line-in	Line-in	Line-in	Line-in
Green 	Headphone	Line-out	Front	Front	Front
Pink 	Mic-in	Mic-in	Mic-in	Mic-in	Mic-in
Orange	Center & woofer	Center & woofer	Center & woofer	Center & woofer	Center & woofer
Black	Rear	Rear	Rear	Rear	Rear
Gray	Side	Side	Side	Side	Side



.....

Note: See **"Connecting peripherals"** on page 27 and **"Connecting options"** on page 31 for more information.

Keyboard

The keyboard has full-sized keys that include separate cursor keys, two Windows keys, four multimedia keys, and 12 function keys.

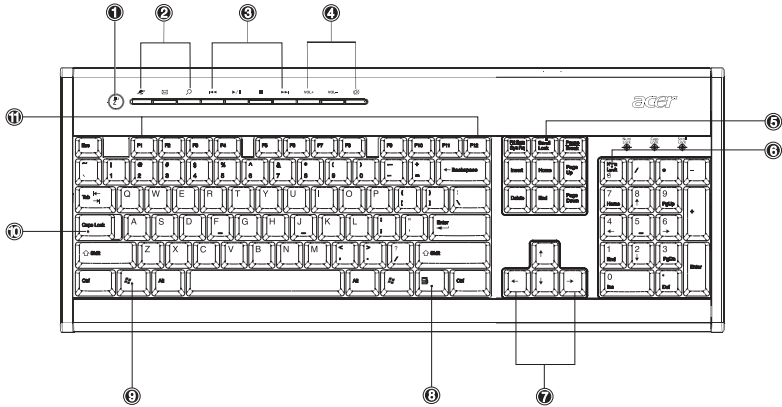

For information on how to connect your keyboard, see **"Connecting your mouse and keyboard"** on page 27.

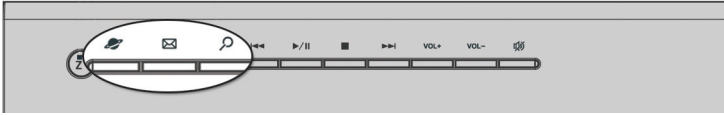

No.	Description	No.	Description
1	Sleep button	2	Internet/Email/Search keys
3	Multimedia keys	4	Volume control / Mute keys
5	Scroll lock key	6	Num lock key
7	Cursor keys	8	Application key
9	Windows logo key	10	Caps lock key
11	Function keys		

Internet/Email/Search keys





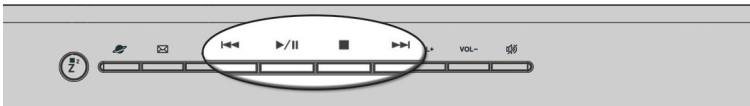

Icon	Key	Description
	Web browser	Launches your current default browser.
	Email	Launches your email application.
	Search	Opens a search window.

Multimedia keys

Allow you to conveniently play, pause, stop, advance or rewind a song or movie using your keyboard.



Icon	Key	Description
	Backward	Press to skip backward to the previous track or video file.
	Play/Pause	Press to start playing the audio track or video file. Press again to pause.
	Stop	Press to stop playing the audio track or video file.
	Forward	Press to skip forward to the next track or video file.

Volume control / Mute keys

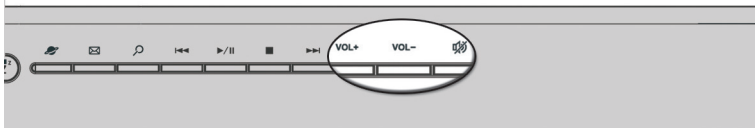

Icon	Key	Description
VOL+	Volume up	Press to increase audio volume.
VOL-	Volume down	Press to decrease audio volume.
	Mute	Toggle sound on/off.

Lock keys

The keyboard has three lock keys which you can toggle on and off to switch between functions.

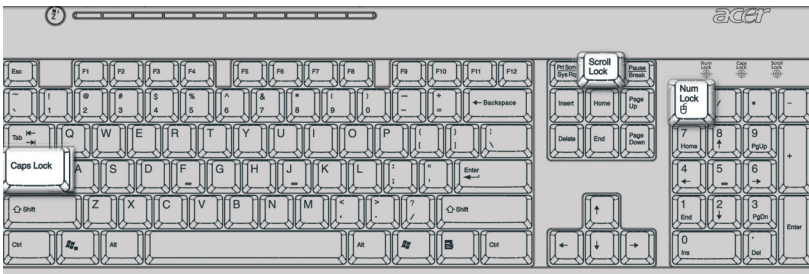

Lock key	Description
Scroll Lock	When activated, the screen moves one line up or down when you press the up arrow or down arrow, respectively.
Num Lock	When activated, the keypad is set to numeric mode, i.e., the keys function as a calculator (complete with arithmetic operators such as +, -, * and /).
Caps Lock	When activated, all alphabetic characters typed appear in uppercase (same function as pressing Shift + <letter>).



Note: Scroll Lock may not work with some applications.

Cursor keys



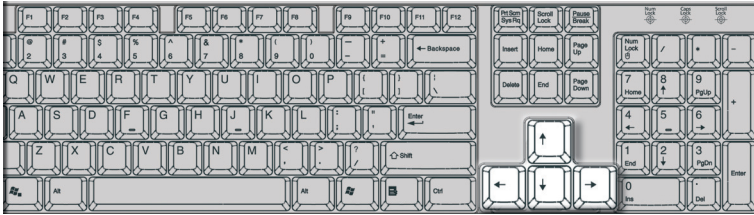





The cursor keys, also called the arrow keys, let you move the cursor around the screen. They serve the same function as the arrow keys on the numeric keypad when the Num Lock is toggled off.



Windows keys

The keyboard has two keys that perform Windows-specific functions.



Key	Description
Windows key 	<p>Pressed alone, this key has the same effect as clicking on the Windows Start button; it launches the Start menu. It can also be used with other keys to provide a variety of functions:</p> <ul style="list-style-type: none"> <  > + <Tab> Activates the next Taskbar button. <  > + <E> Opens the My Computer window. <  > + <F1> Opens Help and Support. <  > + <F> Opens the Find: All Files dialog box. <  > + <R> Opens the Run dialog box. <  > + <M> Minimizes all windows. <Shift> + <  > + <M> Undoes the minimize all windows action.
Application key 	<p>This key has the same effect as clicking the right mouse button; it opens the application's context menu.</p>

Function keys

The function keys, F1 - F12, let you perform specific functions, depending on the application that uses them.

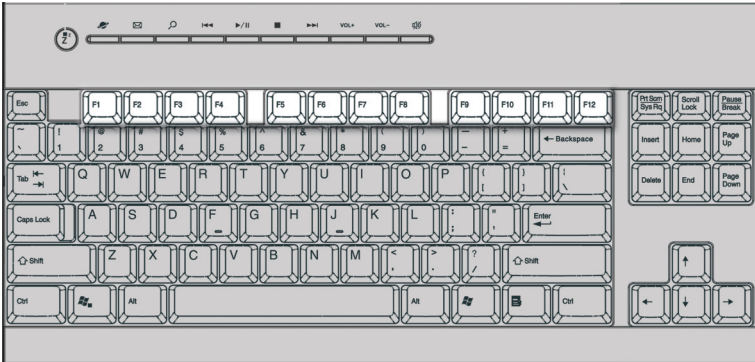

Palm rest

The detachable palm rest provides you with a comfortable place to rest your hands while typing.

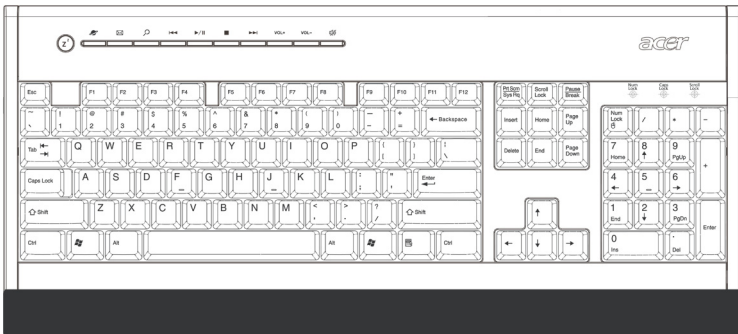

Optical drive

Your computer may come with a CD-ROM, DVD-ROM, DVD/CD-RW combo, DVD-Dual or DVD-Super multi drive. This drive is located on the front panel of your computer. The CD drive allows you to play different types of compact disks (CDs). The DVD drive allows you to play not only old CD-ROMs, CD-I disks, and video CDs, but digital video disks (DVDs) as well. DVD-ROM is a type of disk media with enough storage space for a full-length movie. The CD-RW, DVD-Dual and DVD-super multi drive allow you to record or burn recordable and rewritable disks.

CDs and DVDs, like diskettes, are also compact, lightweight and easy to carry around. However, they are more delicate than diskettes and must be handled with extra care.

To insert a CD or DVD into your computer's CD or DVD drive:

1. Gently push the Eject button located on the front panel.

Veriton 5800



Veriton 6800/7800



2. When the disk tray slides open, place the CD or DVD gently on the tray. Make sure that the label or title side of the disk is facing upward. When holding a disk, hold it by the edges to avoid leaving smudges or fingerprints.

Veriton 5800



Veriton 6800/7800



3. Push the tray and it will close automatically.

Taking care of your CDs and DVDs

- Keep your disk in its case when not in use to avoid scratches or other damage. Any kind of dirt or damage can affect the data on the disk, impair the disk lens reader on the CD or DVD drive, or stop the computer from successfully reading the disk.
- When handling disks, always hold them by the edges to avoid smudges or fingerprints.
- When cleaning disks, use a clean, dust-free cloth and wipe in a straight line from the center to the edge. Do not wipe in a circular motion.
- Clean your CD or DVD drive periodically. You may refer to the Cleaning Kit for instructions. Cleaning kits can be purchased in any computer or electronics shop.

Hard disk

Your computer is pre-installed with a high-capacity Enhanced-IDE (E-IDE) hard disk.

For instructions on how to upgrade or replace your hard disk, see:

"Replacing Veriton 5800's hard disk" on page 48.

"Replacing Veriton 6800/7800's hard disk" on page 50.

3 Setting up your computer

This chapter contains step-by-step instructions on how to set up your computer and connect additional peripherals.

Arranging a comfortable work area

Working safely and comfortably begins with the arrangement of your work space and the proper use of equipment. For this reason, it is very important to take time and think about how you are going to arrange your work area. Refer to the diagram on the following page as you set up your system.

Here are some points to consider:

Adjusting your chair

Having the right kind of chair does not necessarily mean you'll be properly supported. It is necessary to adjust your chair to fit your body. Proper body posture will make you more comfortable and productive.

- Avoid tilting your chair. If you have a chair that tilts, lock the tilt knobs so that your chair will not tilt forward or backward while you are using your computer.
- Adjust your chair height in such a way that you can sit on it with your thighs parallel to the floor and your feet resting flat on the floor.
- Rest your body on the chair back. Your torso works harder to maintain balance if you do not rest your body on the chair back.

Positioning your PC

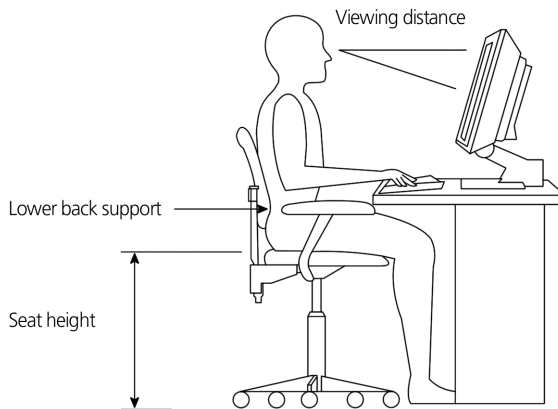

Take note of the following when selecting a location for your computer:

- Do not put your computer near any equipment that might cause electromagnetic or radio frequency interference, such as radio transmitters, televisions, copy machines or heating and air-conditioning equipment.
- Avoid dusty areas and extremes of temperature and humidity.
- You may place your computer beside your desk or under your table, as long as it does not block the space you need for working and moving.

Positioning your monitor

Place your monitor at a comfortable viewing distance, usually 50 to 60 cm away. Adjust the display in such a way that the top of the screen is at or slightly below eye level.

Positioning your keyboard

The location of the keyboard is a very important factor to your posture. Placing it too far away will make your body lean forward, forcing you to sit in an unnatural position. Placing it too high will add tension to your shoulder muscles.

- The keyboard should be placed just above your lap. Adjust the keyboard height by flipping the folding stands located under the keyboard.
- Keep your lower arms parallel to the floor as you type. Your upper arms and shoulders should be relaxed. Then try typing with a light touch. If you feel any shoulder or neck strain, stop for a while and check your posture.
- Position your keyboard in front of your monitor. Putting your keyboard beside your monitor will make you turn your head while you type which could add tension to your neck muscles.

Positioning your mouse

- The mouse should be placed on the same surface as your keyboard so that you can reach it with ease.
- Adjust its position to allow enough space for movement without making you stretch or lean over.
- Use your arm to move the mouse. Do not rest your wrist on the table when moving the mouse.

Connecting peripherals

Setting up your computer is easy. For the most part, you only have four things to connect: the mouse, the keyboard, the monitor, and the power cable.



.....

Note: The peripherals shown in the connections below are for your reference only. Actual device models may vary in select countries.

Connecting your mouse and keyboard

USB interface

Plug your USB mouse or keyboard cable into any of the USB ports  located on the front and rear panels of your computer.

PS/2 interface

Plug the PS/2 mouse and keyboard cable into the PS/2 keyboard port (purple port) and mouse port (green port) located on the rear panel of your computer.



Connecting a monitor

To connect a monitor, simply plug the monitor cable into the monitor port (blue port) located on the rear panel of your computer .



Note: When a VGA card is added to the PCI-E slot, the monitor should be connected to the add-on card and the on-board VGA will be disabled.

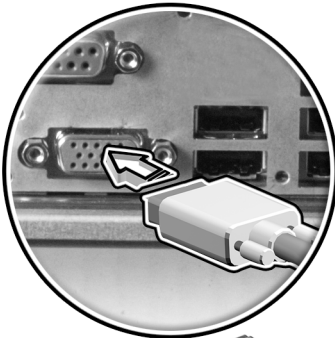
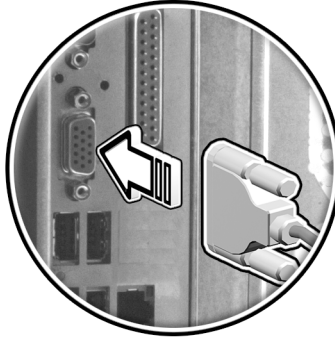

Note: Refer to the monitor manual for additional instructions and information.

Connecting the power cable



Caution: Before you proceed, check the voltage range in your area. Make sure that it matches your computer's voltage setting. If they don't match, change your computer's voltage setting according to your area's voltage range.

Set the voltage selector switch to the voltage range applicable to your area (a). Plug the power cable into the power cable socket located on the rear panel of your computer (b). Then plug the other end of the power cable into a power outlet (c).

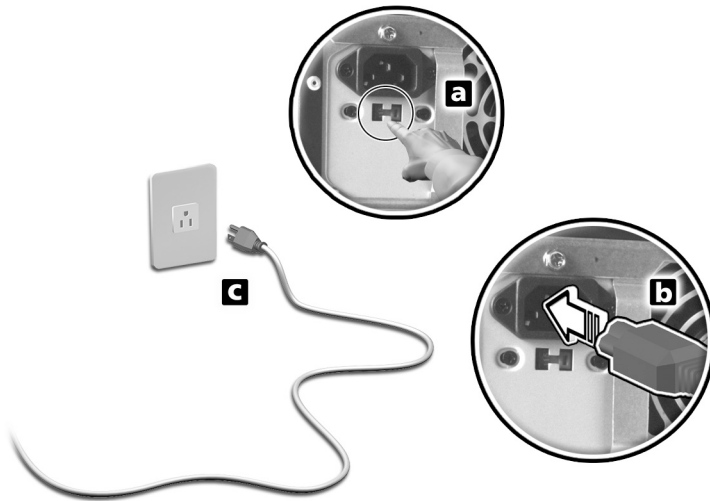

Turning on your computer

After connecting the necessary peripherals and plugging in the power cable, you are now ready to turn the computer on and get to work.

To turn on your computer:

- 1 Turn on all peripherals connected to your computer, such as the monitor, printer, fax, speakers, etc.
- 2 On the front panel of your computer, press the Power button.



Important: Make sure that the power cable is properly plugged into an electrical outlet. If you are using a power strip or an AVR (Auto-Voltage Regulator), make sure that it is plugged in and turned on.

Turning off your computer

To turn off your computer, follow the steps below.

For Windows XP:

- 1 On the Windows XP taskbar, click on the Start button, and click Turn Off Computer, then click Turn Off.
- 2 Turn off all peripherals connected to your computer.

If you cannot shut down your computer normally, press and hold the power button for at least four seconds. Quickly pressing the button may put the computer in suspend mode only.

Connecting options

Connecting your printer

Your computer supports parallel, serial and USB printers.

To connect a parallel printer, plug the printer cable into the parallel port (burgundy port) located on the rear panel of your computer. 



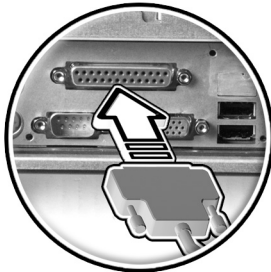

.....
Note: The printer shown below is for your reference only. Actual device model may vary by country.



.....
Note: If you are using a serial printer, connect the printer cable into the serial port located on the rear panel of your computer. In the same manner, connect a USB printer by plugging the printer cable into any of the USB ports located on the front and rear panel.

Connecting the modem (optional)

Set up your modem connection by plugging the telephone line  and handset line  into their corresponding ports on the rear panel of your computer.

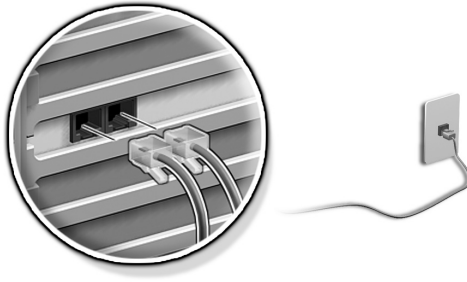

Connecting to the network

You can connect your computer to a Local Area Network (LAN) using a network cable. To do so, simply plug the network cable into the network port  on the rear panel of your computer.

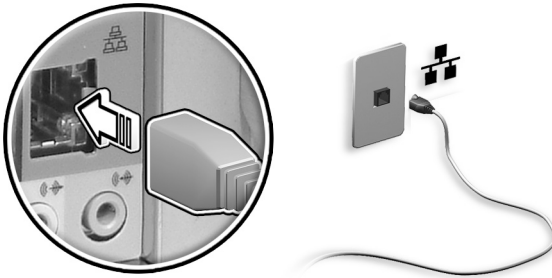

Note: Consult your network system administrator or operating system manual for information on how to configure your network setup.

Connecting multimedia devices

You can connect multimedia devices such as microphones, earphones or headphones, external speakers and audio line-in devices. These devices will let you take advantage of your computer's multimedia features.



.....

Note: The multimedia devices shown below are for reference only. Actual device models may vary in select countries.

Plug the devices in as follows:

- Microphone: Connects to the Microphone-in jack  (pink jack) located on the front and rear panel of your computer.

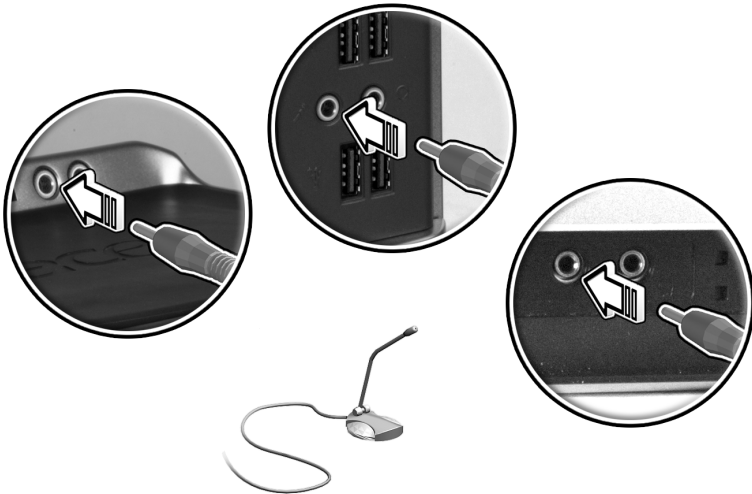

.....

Note: For information on how to configure multimedia devices, consult the documentation that came with each device.

- Earphones, headphones: Connect to the headphone-out jack  (lime jack) located on the front panel of your computer.



Note: To adjust the headphones volume, use the volume control buttons on the keyboard. You can also adjust the volume by using the volume icon on the taskbar at the bottom of your screen.

- External speakers: Connect to the audio-out/line-out jack  (lime jack) located on the rear panel of your computer.

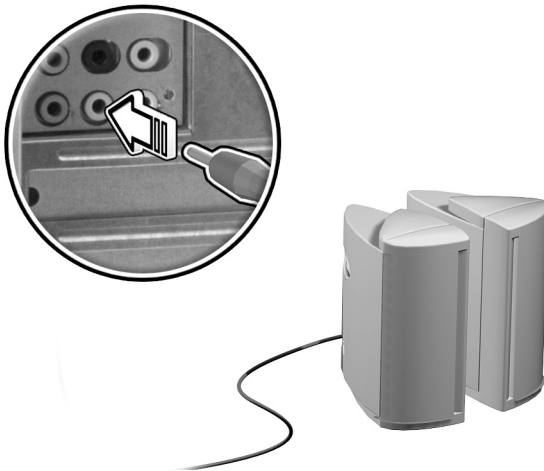

- Audio line-in device: Connects to the audio-in/line-in jack  (light blue jack) located on the rear panel of your computer

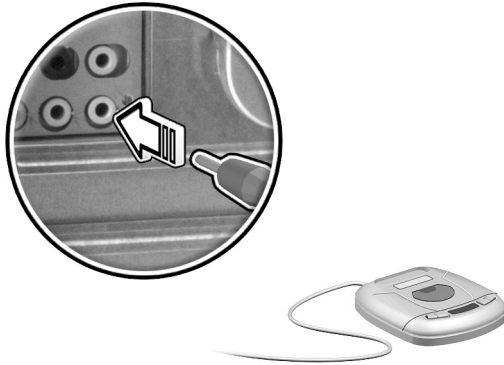

Connecting USB devices

Universal Serial Bus (USB) is a serial bus design capable of cascading peripherals such as a digital camera, keyboard, mouse, joystick, scanner, printer and modem. With USB, complex cable connections can be eliminated.

Your computer comes with eight external USB ports: four on the front and four on the rear panel. These ports support USB 2.0 high-performance external devices such as webcams and digital still cameras. They also allow you to connect additional USB devices to your computer without using up its resources.

To connect a USB device, simply plug the device cable into any of the USB ports  (black) located on the front and rear panels of your computer.

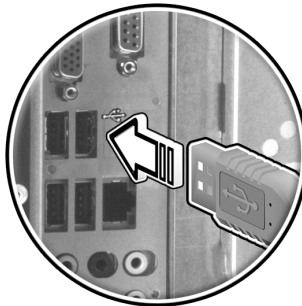



.....

Note: The USB devices shown below are for reference only. Actual device models may vary by geographic region.

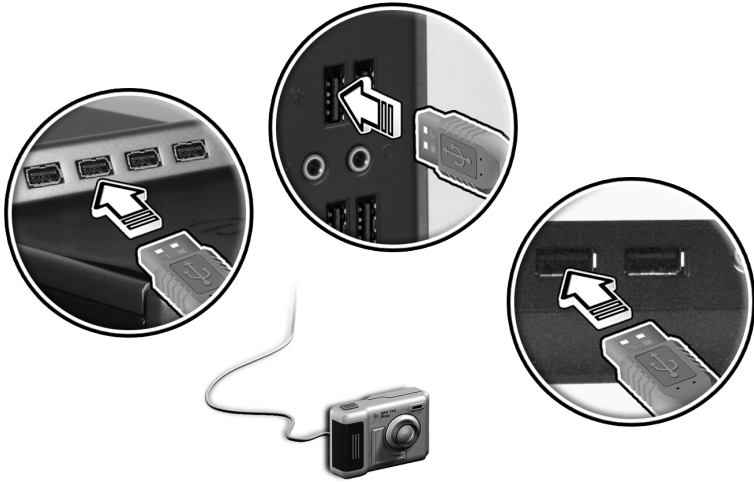

.....

Note: Some USB devices have a built-in USB port which permits you to connect more USB devices.

4 Upgrading your computer

This chapter contains instructions on how to upgrade your computer, and basic information about your system boards that you will find helpful when performing the upgrade process.

Installation precautions

Before you install any computer component, we recommend that you read the following sections. These sections contain important ESD precautions along with preinstallation and post-installation instructions.

ESD precautions

Electrostatic discharge (ESD) can damage your processor, disk drives, expansion boards, and other components. Always observe the following precautions before you install a computer component:

- 1 Do not remove a component from its protective packaging until you are ready to install it.
- 2 Wear a wrist grounding strap and attach it to a metal part of the computer before handling components. If a wrist strap is not available, maintain contact with the computer throughout any procedure requiring ESD protection.

Preinstallation instructions

Always observe the following before you install any component:

- 1 Turn off your computer and all the peripherals connected to it before opening it. Then unplug all cables from the power outlets.
- 2 Open your computer according to the instructions on page 39.
- 3 Follow the ESD precautions described above before handling a computer component.
- 4 Remove any expansion boards or peripherals that block access to the DIMM sockets or component connectors.
- 5 See the following sections for specific instructions on the component you wish to install.



.....

Warning! Not turning off the computer properly before you start installing the components may cause serious damage. Do not attempt the procedures described in the following sections unless you are a qualified service technician.

Post-installation instructions

Observe the following after installing a computer component:

- 1 See to it that the components are installed according to the step-by-step instructions in their respective sections.
- 2 Replace any expansion boards or peripherals that you removed earlier.
- 3 Replace the side panels.
- 4 Connect the necessary cables and turn on your computer.

Opening your Veriton 5800



.....

Caution! Before you proceed, make sure that you have turned off your computer and all peripherals connected to it. Read the **"Preinstallation instructions"** on page 39.

You need to open your computer before you can install additional components. See the following section for instructions:

To remove the computer cover

- 1 Turn off your computer and unplug all cables.
- 2 Place your computer on a flat, steady surface.
- 3 Turn the thumbscrews counterclockwise with your fingers to release the cover.
 - a Hold the cover with both hands.
 - b Slide it back about an inch and then gently lift it upward to detach it.



To replace the computer cover

- 1 Align the cover to the housing frame and then push it in to slide it back into place.
- 2 Secure the cover with the thumbscrews you released earlier.

Opening your Veriton 6800/7800



.....

Caution! Before you proceed, make sure that you have turned off your computer and all peripherals connected to it. Read the **"Preinstallation instructions" on page 39.**

You need to open your computer before you can install additional components. See the following section for instructions:

To remove the side panel

- 1 Turn off your computer and unplug all cables.
- 2 Place your computer on a flat, steady surface.
- 3 Turn the screws counterclockwise with your fingers to release the cover.
- 4 Hold right panel (from rear view) with both hands. Slide it back about an inch and then gently pull it outward to detach it.

Veriton 6800



Veriton 7800



To replace the side panel

- 1 Align the side panel's hinges to the housing frame and then push it in to slide it back into place.
- 2 Secure the side panels with the two screws.

System boards

Mainboard layout

The mainboard becomes accessible once you open your computer. Refer to the section below for the corresponding mainboard layout of your Veriton series computer model.

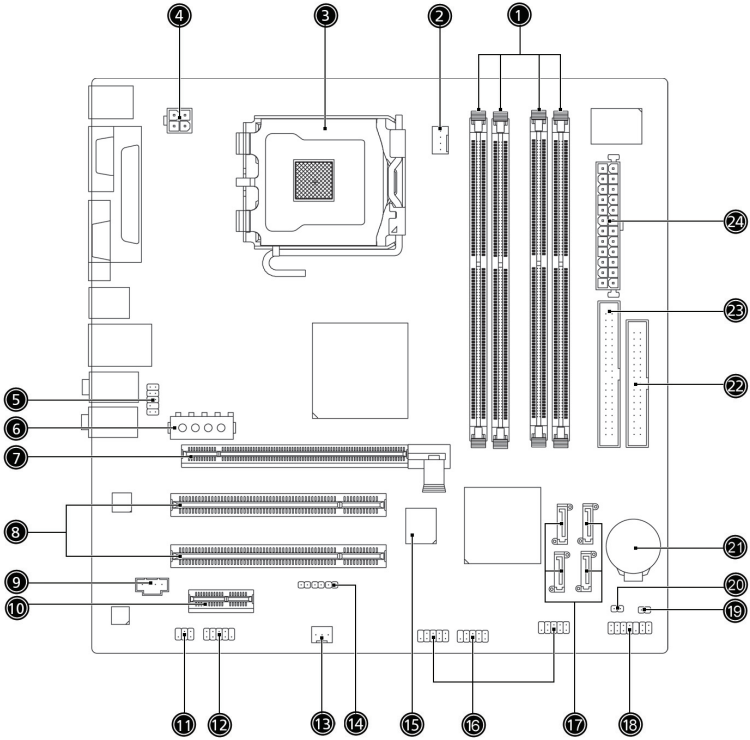

No.	Component	No.	Component
1	4 Memory slots	2	CPU fan connector
3	CPU socket	4	ATX 12V power connector
5	Front panel audio connector	6	Alternate power connector
7	PCI Express X16 connector	8	2 PCI conventional bus connectors
9	CD in	10	PCI Express connector
11	S/PDIF output connector	12	External COM port connector
13	System fan connector	14	OneButton Recovery connector
15	BIOS	16	Front panel USB connector
17	4 Serial ATA IDE connectors	18	Front panel connector
19	Chassis intrusion connector	20	Clear CMOS jumper 1-2 Normal (default), 2-3 Clear CMOS
21	Lithium battery	22	Diskette drive connector
23	Parallel ATA IDE connector	24	Main power connector

Upgrading your computer

Certain components of your computer are upgradeable, such as the memory, the hard disk, the CPU and the expansion cards. You need to observe the **"Installation precautions" on page 39** when installing or removing a computer component. However, for safety purposes, we do not recommend that you perform these upgrades yourself. If you want to replace or upgrade any of these components, contact your dealer or a qualified service technician for assistance.



.....

Note: The mainboard model shown in the following figures may not be exactly the same as the one found in your computer.

Installing additional memory

The four 240-pin sockets on the mainboard support Double Data Rate 2 (DDR2) Synchronous Dynamic Random Access Memory (SDRAM)-type DIMMs. You may install 128 MB, 256 MB, 512 MB or 1 GB DIMMs for a maximum memory capacity of 4 GB.

The DDR2 DIMMs should work under 1.8 volts. You can install PC2 3200/DDR2 400, or PC2 4300/DDR2 533 modules in the DDR2 DIMM sockets. Contact your dealer for qualified DIMM vendors.

Each DDR2 DIMM socket is independent from the other. This independence allows you to install DDR2 DIMMs with different capacities to form different configurations.

To remove a DDR2 DIMM



.....

Note: The DDR2 DIMM has only one notch located on the center of the module.

- 1 Remove the side panel.
- 2 Locate the DDR2 DIMM socket on the mainboard.

- 3 Press the holding clips on both sides of the DDR2 DIMM socket outward to release the DDR2 DIMM (a). Gently pull the DDR2 DIMM out of the socket (b).

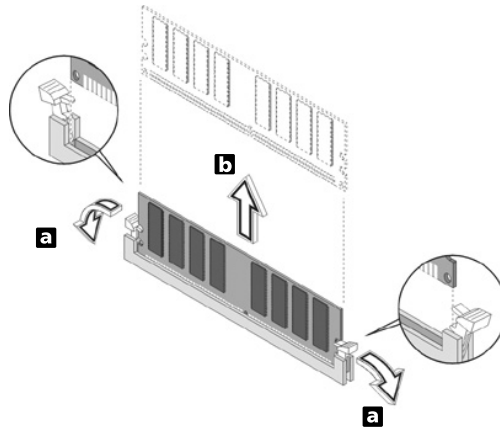

To install a DDR2 DIMM

- 1 Locate the DDR2 DIMM socket on the mainboard.
- 2 Align the DDR2 DIMM with the socket (a). Press the DDR2 DIMM into the socket until the clips lock onto the DDR2 DIMM (b).

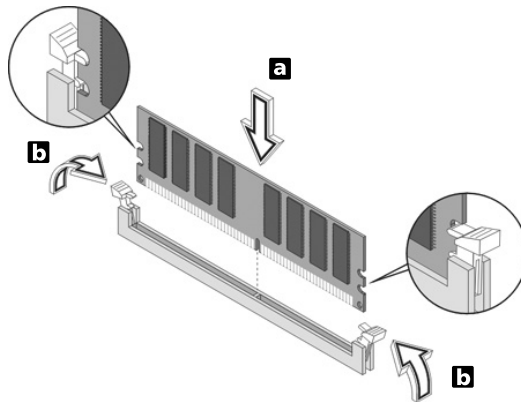

Note: The DDR2 DIMM sockets are slotted to ensure proper installation. If you insert a DDR2 DIMM but it does not fit easily into the socket, turn the DDR2 DIMM around and try to insert it again.

To reconfigure your computer

Your computer automatically detects the amount of memory installed. Run the BIOS utility to view the new value for total system memory and make a note of it.

Replacing Veriton 5800's hard disk

Follow these steps to replace your computer's hard disk:

- 1 Remove the computer cover.
- 2 Detach all cables connected to the hard disk and pull the hard disk out.
- 3 Remove the drive rails that hold the hard disk to the disk frame and detach the hard disk. Set the drive rails aside.
- 4 Insert the new hard disk into the frame and secure it with drive rails.
- 5 Reattach all cables to the new hard disk.



Note: Make sure that the other ends of the disk cables are securely connected to their corresponding connectors on the mainboard.

- 6 Reinstall the metal bracket frame to the housing.
- 7 Replace the computer cover.

Installing an expansion card

To install an expansion card:

- 1 Remove the computer cover.
- 2 Locate an empty PCI-E or PCI slot on the mainboard.
- 3 Remove the bracket lock that holds the bracket to the computer. Save the lock.

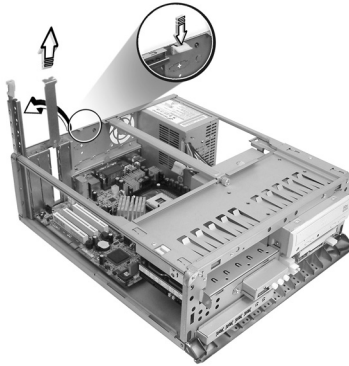

- 4 Pull out the bracket on the housing opposite the selected empty slot.
- 5 Remove the expansion card from its protective packaging.
- 6 Align the card in the empty bracket and then insert it into the slot. Make sure that the card is properly seated.
- 7 Secure the card to your computer with the bracket lock you removed earlier.

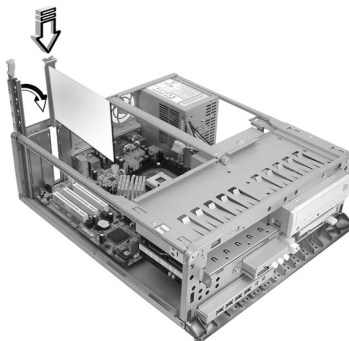

- 8 Replace the computer cover.

When you turn on the computer, BIOS automatically detects and assigns resources to the newly installed devices.

Replacing Veriton 6800/7800's hard disk

Follow these steps to replace your computer's hard disk:

- 1 Remove the side panel.
- 2 Detach the power and hard disk cables from the hard disk (a). Detach the hard disk from the drive frame (b).

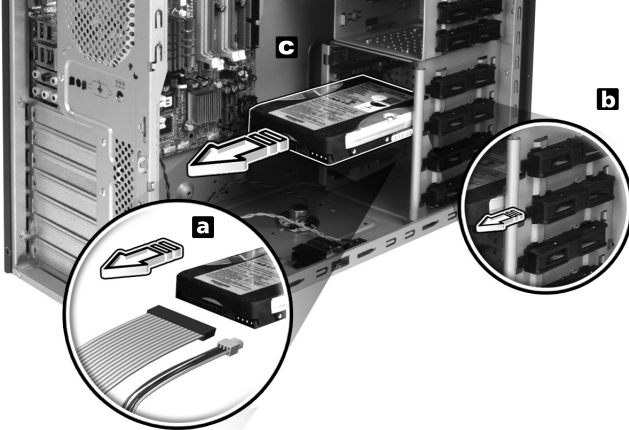

- 3 Insert the new hard disk into the frame (a). Connect the power and hard disk cables to the new hard disk (b).

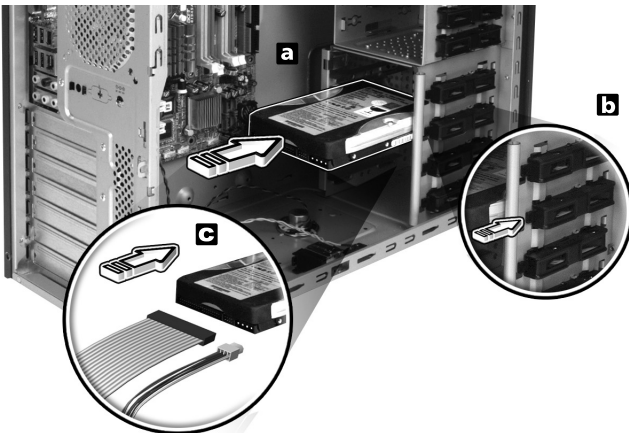

Note: Make sure that the other ends of the disk cables are securely connected to their corresponding connectors on the mainboard.

- 4 Replace the side panel. See "To replace the side panel" on page 43.

Installing an expansion card

To install an expansion card:

- 1 Remove the side panel (see page 42).
- 2 Locate an empty PCI-E or PCI slot on the mainboard.
- 3 Remove the lock that holds the bracket to the computer.
- 4 Pull out the bracket on the housing opposite the selected empty slot.
- 5 Remove the expansion card from its protective packaging.
- 6 Align the card with the empty bracket and then insert it into the slot. Make sure that the card is properly seated.
- 7 Secure the card to your computer with the bracket lock you removed earlier.
- 8 Replace the side panel. See **"To replace the side panel" on page 43.**

When you turn on the computer, BIOS (Basic Input/Output System) automatically detects and assigns resources to the newly installed devices.

5 System utilities

This chapter describes applications that are preinstalled on your computer.

Depending on the hardware and optional features installed in your computer, your system came bundled with several program utilities designed to streamline your computer's operations. These utilities may include any of the following:

- Adobe Reader
- LANDesk System Manager
- Norton AntiVirus
- NTI CD-Maker
- PowerDVD
- BIOS utility
- Acer eManager

If your computer is configured with Microsoft Windows XP, the following utilities can be used to monitor and maintain system health:

- Backup
- Disk Defragmenter

All of the applications that came with your computer are very easy to use. However, if you need more help or information, you may refer to the online help documentation provided in each software application.

Adobe Reader

Adobe Reader is software that lets you view, navigate, browse and print Adobe Portable Document Format (PDF) files on all major computer platforms.



To read a PDF document  you can:

- Simply double click on any file with an icon like that shown above.
- or
- 1 On the windows taskbar, click on the Start button, highlight Programs, and select Adobe Reader.
 - 2 Once the program is running, select Open from the File menu.
 - 3 Select the file you wish to view in the Open file browser and click the Open button.

For more information about Adobe Reader, you may refer to the Adobe Reader Help menu.

LANDesk System Manager

LANDesk System Manager allows desktop management via the Web, standard network or dial-up connections. It is compatible with leading management specifications, such as Wired for Management 2.0, Desktop Management Interface (DMI) v2.0 and others.

Your computer may be bundled with a LANDesk System Manager installation CD. To install LANDesk System Manager:

- 1 Insert the LANDesk System Manager installation CD into the optical drive.



Caution! Make sure that the LANDesk System Manager installation CD is properly inserted into the optical drive. Improper insertion may damage both the CD and the drive. See "**Optical drive**" on page 20 for more instructions.

- 2 Follow all onscreen instructions until installation is completed.

For more information on how to use the LANDesk System Manager, you may refer to the LANDesk System Manager Help menu.



Note: LANDesk System Manager currently supports Windows 2000 and Windows XP platforms.

Norton AntiVirus

Norton AntiVirus is an anti-virus software that finds and repairs infected files, and protects against viruses to keep your computer data safe and secure.

How do I check for viruses?

A Full System Scan scans all files on your computer. To perform a system scan:

- 1 Start Norton AntiVirus.

Double click on the Norton AntiVirus Icon on the desktop or click on the Start menu in the Windows taskbar, highlight Programs, and select Norton AntiVirus.

- 2 In the Norton AntiVirus main window, click Scan for Viruses.

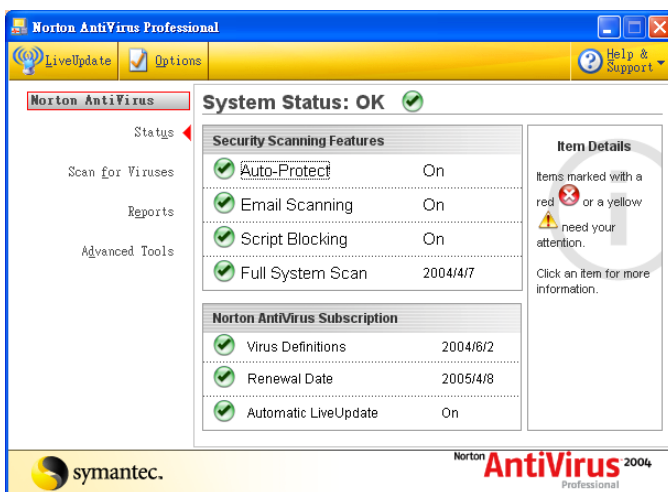

- 3 In the Scan for Viruses panel, click Scan My Computer.
- 4 Under Actions, click Scan.
- 5 When the scan is complete, a scan summary appears. Click Finished.

You can schedule customized virus scans that run unattended on specific dates and times or at periodic intervals. If you are using the computer when the scheduled scan begins, it runs in the background so that you do not have to stop working.

For more information refer to the Norton AntiVirus Help menu.

NTI CD&DVD-Maker (for models with CD or DVD Burner)

The NTI CD&DVD-Maker is optical disk-recording software that allows you to create and copy audio, data and videos to recordable or rewritable optical disks.

To copy an audio or data disk:

- 1 Click the Quick Burning icon  on the desktop.
- 2 Insert the CD you would like to copy into the source drive and a blank disk into the target drive.
- 3 Choose the source and target drives from the pull-down lists.

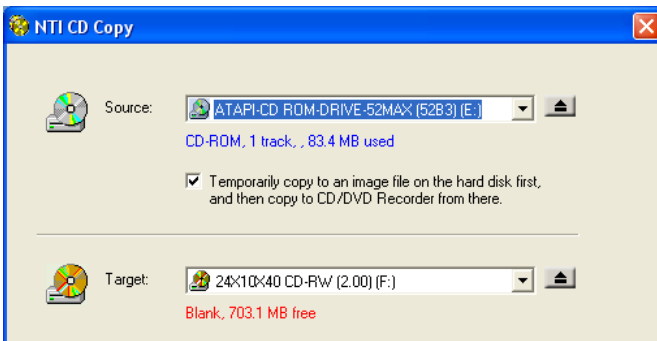

- 4 Click the Start button to begin copying.

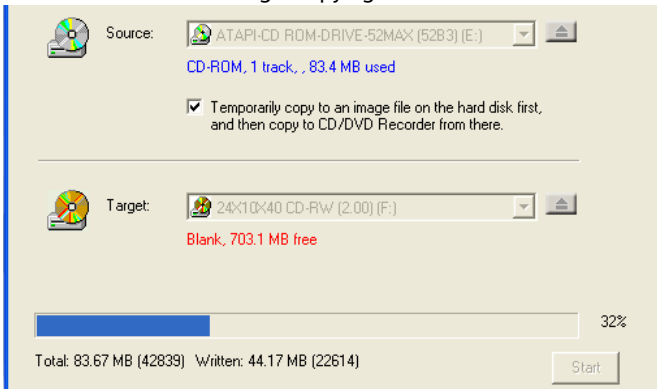

For more information about NTI CD&DVD-Maker and its other features, refer to the NTI CD&DVD-Maker Help menu.

PowerDVD (for models with DVD)

PowerDVD is a high-quality, pure software DVD player that brings high-quality movies and karaoke to your multimedia PC. You can play back high-resolution DVD titles or MPEG-2 files with MPEG-2 video and Dolby Digital (AC-3) audio. PowerDVD provides a complete set of commands for navigation and advanced features such as multi-angle switching, multi-language and multi-subtitle selection, and parental control. It also has the i-Power Internet Enabling feature, which links to online DVD resources via the Power DVD Desktop Portal Page.

How do I open and watch a DVD?

In most cases, when you insert a DVD into your computer's optical drive, PowerDVD will automatically open a viewer window and the control panel and begin playing.



If PowerDVD does not open automatically:

- 1 Click the Start button in the taskbar.
- 2 Highlight All Programs.
- 3 Click the Cyberlink PowerDVD tab.
- 4 Select PowerDVD.

When PowerDVD opens, simply press the play button  to begin playback.

For more information about Cyberlink PowerDVD and its other features, refer to the PowerDVD Help menu.

BIOS utility

The BIOS utility is a hardware configuration program built into your computer's Basic Input/Output System (BIOS). Since most computers are already properly configured and optimized, there is no need to run this utility. However, if you encounter configuration problems and get the "Run Setup" message, you will need to run this utility.



.....

Note: Before you run BIOS, make sure that you have saved all open files. The computer reboots immediately after you exit Setup.

To run the BIOS utility, press the **Del** key on your keyboard during computer boot up.

Reinstalling programs

If you uninstall one of the preinstalled programs and want to reinstall it, do the following:

- 1 Make sure that the system is turned on.
- 2 Insert the System CD into the CD or DVD drive.
- 3 Select the application that you want to reinstall.
- 4 Follow all onscreen instructions until you finish the installation.

Recovering your system

If your operating system files are lost or damaged, the recovery process will restore your system's original factory default settings or last system backup. Your Acer Veriton series computer includes an OBR (OneButton Recovery) button, a feature that makes restoring your system quick and easy.

OBR works from a hidden partition on your hard drive that contains all the information required to restore your system.

There are two modes to recover your system. One is from the system's original settings and another is from system backup.



.....

Warning: Initiating the recovery operation while the operating system is running will result in abnormal shutdown and may make your current OS unstable or unusable.

You can also follow the steps below:

- 1 Locate the OBR button. See **"Front panel"** on page 10.
- 2 Press the button. After a moment, one of the following screens will appear on your display. Please type in your password.

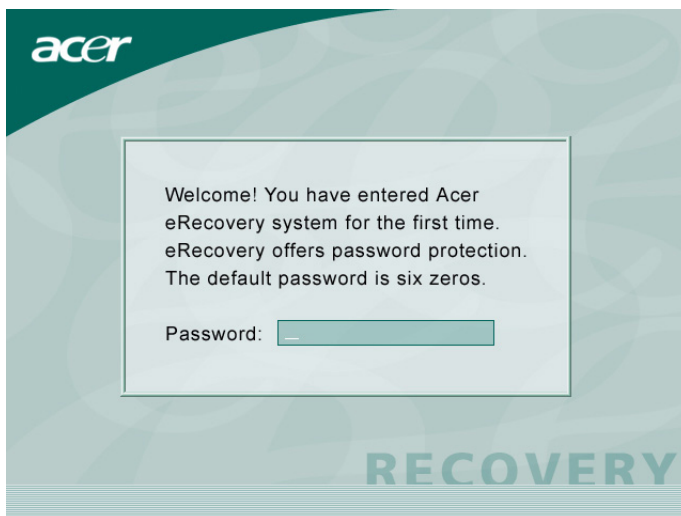

- 3 Select "System Recovery."



4 Select "Factory Default Image."

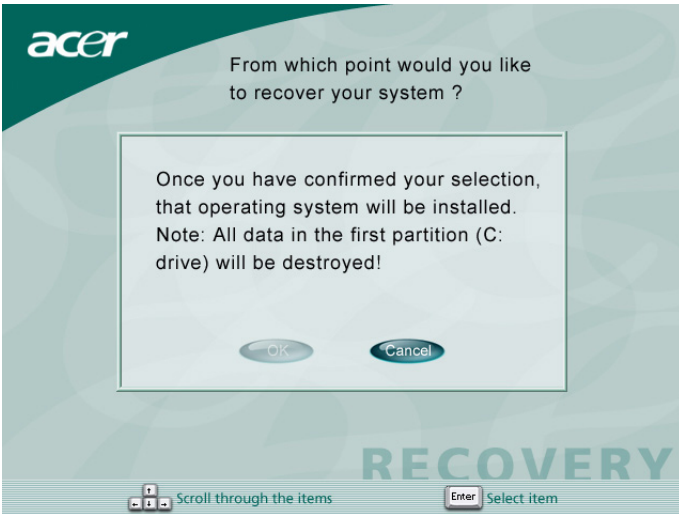
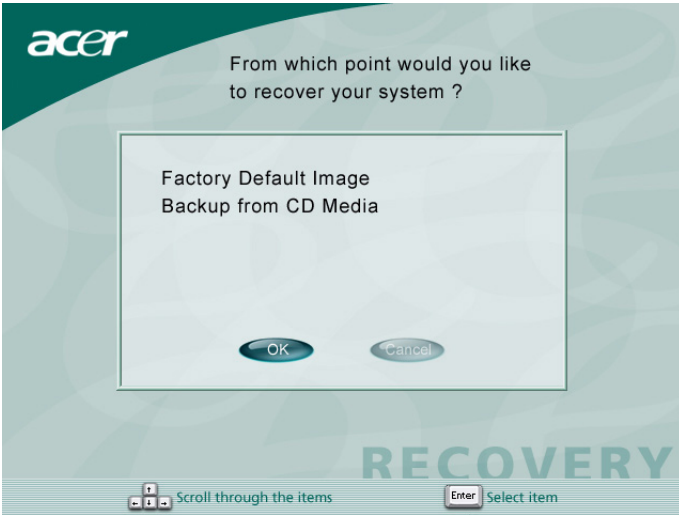

- 5 You should see the following screen:

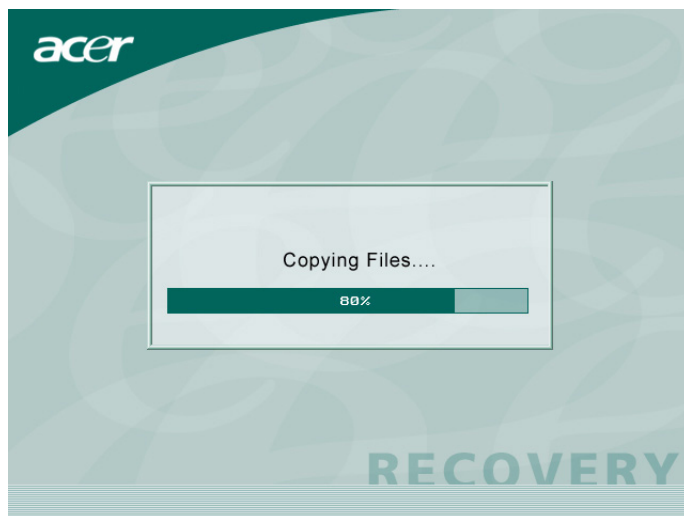
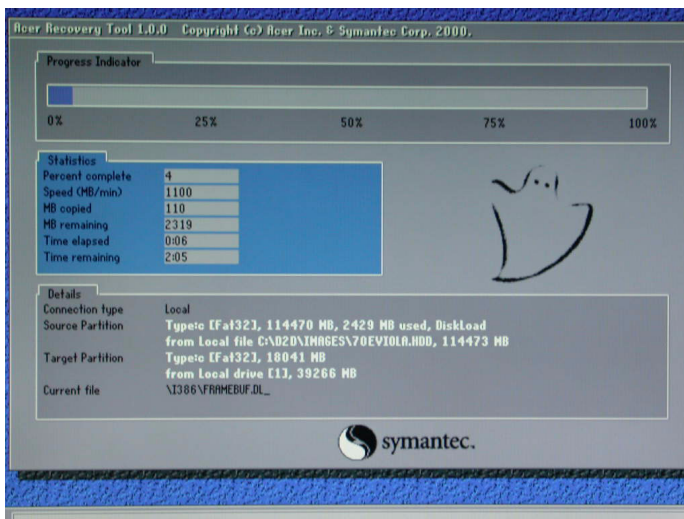

Caution! Running the recovery operation will erase all files previously saved on your computer so make sure to back up your important files before starting the recovery process.



Note: This feature occupies 2 GB in a hidden partition on your hard drive.

- 6 If you attempt to restore your system using the OneButton Recovery feature, and the system DOES NOT respond, contact your local vendor or authorised Acer representative immediately.

Acer eManager

Acer eManager is a simple and easy-to-use portal for managing your new Acer desktop computer. eManager includes:

- Acer eLock — Ensures your data security.
- Acer eSettings — Makes managing system settings and security easy.
- Acer eRecovery — Creates backups and recovers system configurations reliably.



Acer eLock

Acer eLock is a security utility that is included within Acer eManager and made specifically for Acer desktop computers. This utility allows you to lock up your USB data, optical and floppy drives to ensure that data can't be stolen while your computer is unattended.

- USB Data Devices — Includes USB disk drives, USB pen drives, USB flash drives, USB MP3 drives and any other USB drives that would create a Z: directory when plugged into the system.
- Optical Drives — Includes any kind of CD-ROM or DVD-ROM drives.
- Floppy Disk Drives — 3.5-inch disks only.

To activate Acer eLock, a password must be set first. Once set, you may apply locks to any of the three kinds of devices. The lock will immediately be set without any reboot necessary.

If the password you set is empty, eLock will reset back to the initial status with all locks removed.



Note: If you lose your password, there is no method to reset password except by reformatting your computer or taking your PC to an Acer service center. Be sure to remember or write down your password.



Acer eSettings

Acer eSettings is a system utility that is included within Acer eManager and made specifically for Acer desktop computers. This utility allows you to inspect hardware specifications and to monitor the system health status. Furthermore, Acer eSettings contains several internal functions that are made to optimize your Windows operating system, allowing your computer to run faster, smoother and better.

Acer eSettings also:

- Provides a simple graphical user interface letting you navigate through the program effortlessly.
- Displays general system status and advanced monitoring for power users.
- Logs when a hardware component has been removed or replaced.
- Allows you to instantly optimize memory by freeing up memory resources.
- Permits you to migrate personal settings.
- Keeps a history log of all alerts that were previously issued.



Acer eRecovery

Acer eRecovery is a powerful utility that does away with the need for recovery disks to be provided by the manufacturer. The Acer eRecovery utility occupies space in a hidden partition on your system's HDD and allows you to perform backup/restore operations and to burn backup images to CD or DVD, depending on system configuration.

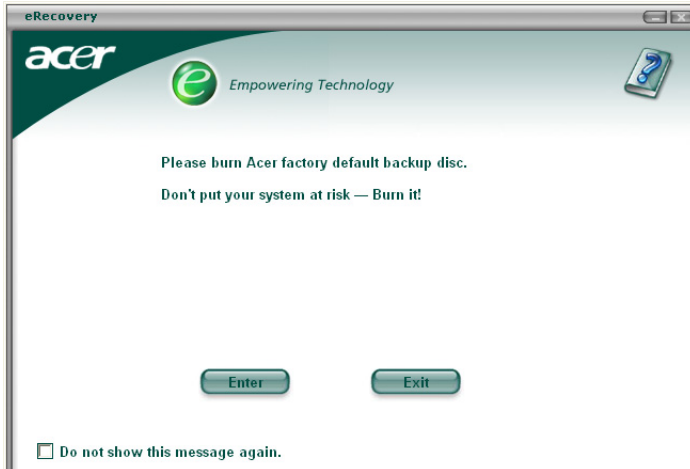

For more information, see Acer eManager's online help file.

Using backup (Windows XP only)

The Backup utility creates copies of information on your hard disk. In the event that the original data on your hard disk is erased or overwritten, or becomes inaccessible because of a hard disk malfunction, you can use the copy to restore your lost or damaged data.

How do I back up files from my hard drive?

To run the Backup utility:

- 1 Click the Start button in the taskbar.
- 2 Highlight All Programs
- 3 Click Accessories
- 4 Select System Tools
- 5 Click Backup

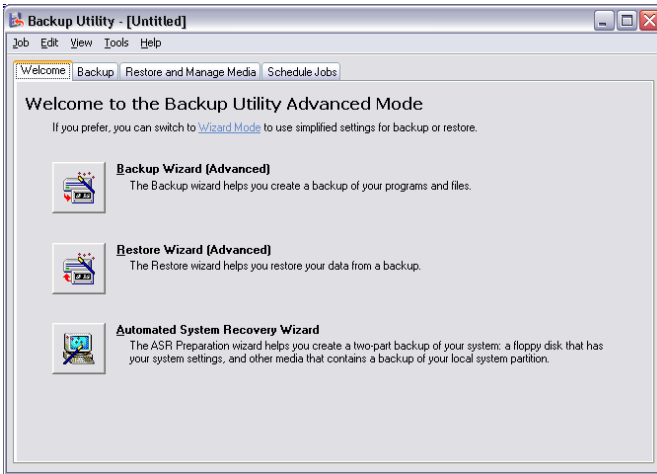

When Backup starts, follow the onscreen instructions to set up your backup profile and schedule.

For more information about Backup, refer to Windows XP help.

Disk defragmenter (Windows XP only)

The disk defragmentation utility consolidates files and folders on your computer's hard disk. This allows your computer to access files and folders and save new data more efficiently. By consolidating your files and folders, the defragmenter also consolidates the volume's free space, making it less likely that new files will be fragmented.

How do I defragment my hard drive?

To run the Disk Defragmenter:

- 1 Click the Start button in the taskbar.
- 2 Highlight All Programs
- 3 Click Accessories
- 4 Select System Tools
- 5 Click Disk Defragmenter

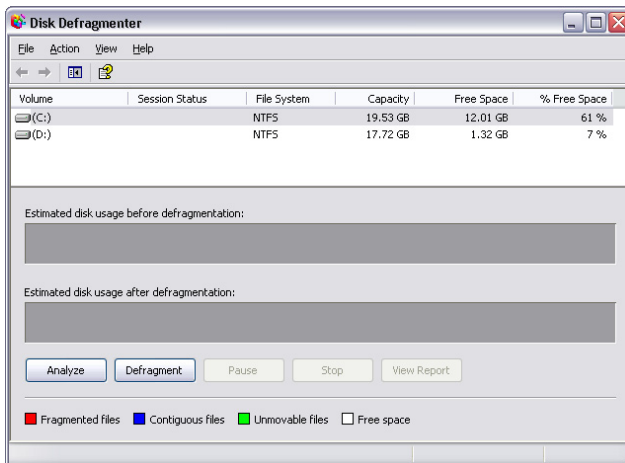

When Disk Defragmenter opens, select a drive/volume and click Analyze. The system will quickly examine the volume and determine whether or not it needs to be defragmented.

For more information about Disk Defragmenter, refer to Windows XP help.

6 Frequently asked questions

This chapter tells you what to do in case your computer is not working properly. However, if a more serious problem arises, contact your dealer or the technical support center (www.acersupport.com) for assistance.

Frequently asked questions

The following questions indicate possible situations that may arise during the use of your computer and each is followed by easy answers and solutions.

I pressed the power switch but the system did not boot up.

Check the LED located above the power switch.

If the LED is not lit, no power is being applied to the system. Try the following:

- Check if the voltage selector switch located on the rear panel of the computer is set to the correct voltage.
- Check if you properly plugged the power cable into an electrical outlet.
- If you are using a power strip or AVR, make sure it is plugged in and turned on.

If the LED is lit, check the following:

- Is a nonbootable (nonsystem) diskette in the floppy drive? If yes, remove or replace it with a system diskette and press **<Ctrl> + <Alt> + ** to restart your computer.
- The operating system files may be damaged or missing. Insert the startup disk you created during Windows setup into the floppy drive and press **<Ctrl> + <Alt> + ** to restart your computer. This will automatically diagnose your system and make necessary fixes. However, if the diagnostic utility still reports a problem, then you may have to perform the recovery process to restore your system to its original default factory settings.



.....

Note: For more information about recovering your system, see "**Acer eRecovery**" on page 67.

Nothing appears on the screen.

Your computer's power management function automatically blanks the screen to save power. Just press any key to turn the display back on.

If pressing a key does not work, you can restart your computer. If restarting your computer does not work, contact your dealer or technical support center for assistance.

The printer does not work.

Do the following:

- Make sure the printer is connected to a power outlet and that it is turned on.
- Make sure the printer cable is connected securely to the system's parallel or USB port and the corresponding port on the printer. See "**Connecting your printer**" on page 31 for more information.
- For additional information concerning the printer, refer to the printer's documentation.

No sound comes out from the computer.

Check the following:

- The volume may be muted. Look for the Volume icon on the taskbar. If it is crossed-out, click on the icon and deselect the **Mute** option. You can also press the volume control/mute knob on your USB keyboard to toggle from mute to sound on.
- If headphones, earphones or external speakers are connected to the line-out jack of your computer, the internal or built-in speakers are automatically turned off.

System cannot read diskette, hard disk, CD or DVD information.

Check the following:

- Make sure you are using the correct type of disk.
- Make sure the CD or DVD is inserted into the drive correctly.
- Check if the CD or DVD is clean and unscratched.
- Check your drive by using a good (undamaged) disk. If your drive can not read the information on the good disk there may be a problem with the drive. Contact your dealer or technical support center for assistance.

System cannot write data on the hard disk or CD-R/CD-RW.

Check the following:

- Make sure the diskette or hard disk is not write-protected.
- Make sure you are using the correct type of disk or diskette.

Appendix A: Notices

ENERGY STAR guidelines compliance

As an ENERGY STAR partner, Acer Inc. has determined that this product meets the ENERGY STAR guidelines for energy efficiency.

FCC notice

This device has been tested and found to comply with the limits for a Class B digital device pursuant to Part 15 of the FCC rules. These limits are designed to provide reasonable protection against harmful interference in a residential installation. This device generates, uses, and can radiate radio frequency energy and, if not installed and used in accordance with the instructions, may cause harmful interference to radio communications.

However, there is no guarantee that interference will not occur in a particular installation. If this device does cause harmful interference to radio or television reception, which can be determined by turning the device off and on, the user is encouraged to try to correct the interference by one or more of the following measures:

- Reorient or relocate the receiving antenna.
- Increase the separation between the device and receiver.
- Connect the device into an outlet on a circuit different from that to which the receiver is connected.
- Consult the dealer or an experienced radio/television technician for help.

Notice: Shielded cables

All connections to other computing devices must be made using shielded cables to maintain compliance with FCC regulations.

Notice: Peripheral devices

Only peripherals (input/output devices, terminals, printers, etc.) certified to comply with the Class B limits may be attached to this equipment. Operation with non-certified peripherals is likely to result in interference to radio and TV reception.

Caution

Changes or modifications not expressly approved by the manufacturer could void the user's authority, which is granted by the Federal Communications Commission, to operate this computer.

Operation conditions

This device complies with Part 15 of the FCC Rules. Operation is subject to the following two conditions: (1) this device may not cause harmful interference, and (2) this device must accept any interference received, including interference that may cause undesired operation.

Notice: Canadian users

This Class B digital apparatus complies with Canadian ICES-003.

Remarque à l'intention des utilisateurs canadiens

Cet appareil numérique de la classe B est conforme à la norme NMB-003 du Canada.

Declaration of Conformity for EU countries

Acer hereby declares that this personal PC series is in compliance with the essential requirements and other relevant provisions of Directive 1999/5/EC.

Modem notices

Notice for USA

This equipment complies with Part 68 of the FCC rules. Located on the modem is a label that contains, among other information, the FCC Registration Number and Ringer Equivalence Number (REN) for this equipment. Upon request, you must provide this information to your telephone company.

If your telephone equipment causes harm to the telephone network, the telephone company may discontinue your service temporarily. If possible, they will notify you in advance. But, if advance notice is not practical, you will be notified as soon as possible. You will also be informed of your right to file a complaint with the FCC.

Your telephone company may make changes in its facilities, equipment, operations, or procedures that could affect the proper functioning of your equipment. If they do, you will be notified in advance to give you an opportunity to maintain uninterrupted telephone service.

If this equipment should fail to operate properly, disconnect the equipment from the phone line to determine if it is causing the problem. If the problem is with the equipment, discontinue use and contact your dealer or vendor.



Caution: To reduce the risk of fire, use only No. 26 AWG or larger UL Listed or CSA Certified Telecommunication Line Cord.

TBR 21

This equipment has been approved [Council Decision 98/482/EC — "TBR 21"] for single terminal connection to the Public Switched Telephone Network (PSTN). However, due to differences between the individual PSTNs provided in different countries, the approval does not, of itself, give an unconditional assurance of successful operation on every PSTN termination point. In the event of problems, you should contact your equipment supplier in the first instance.

Notice for Australia

For safety reasons, only connect headsets with a telecommunications compliance label. This includes customer equipment previously labelled permitted or certified.

Important safety instructions

Read these instructions carefully. Save them for future reference.

- 1 Follow all warnings and instructions marked on the product.
- 2 Unplug this product from the wall outlet before cleaning. Do not use liquid cleaners or aerosol cleaners. Use a water-moistened cloth for cleaning.
- 3 Do not use this product near water.
- 4 Do not place this product on an unstable cart, stand or table. If the product falls, it could be seriously damaged.
- 5 Slots and openings are provided for ventilation; to ensure reliable operation of the product and to protect it from overheating. These openings must not be blocked or covered. The openings should never be blocked by placing the product on a bed, sofa, rug or other similar surface. This product should never be placed near or over a radiator or heat register, or in a built-in installation unless proper ventilation is provided.
- 6 This product should be operated from the type of power indicated on the marking label. If you are not sure of the type of power available, consult your dealer or local power company.
- 7 Do not allow anything to rest on the power cord. Do not locate this product where people will walk on the cord.

- 8 If an extension cord is used with this product, make sure that the total ampere rating of the equipment plugged into the extension cord does not exceed the extension cord ampere rating. Also, make sure that the total rating of all products plugged into the wall outlet does not exceed the fuse rating.
- 9 Never push objects of any kind into this product through cabinet slots as they may touch dangerous voltage points or short-out parts that could result in a fire or electric shock. Never spill liquid of any kind onto or into the product.
- 10 Do not attempt to service this product yourself, as opening or removing covers may expose you to dangerous voltage points or other risks. Refer all servicing to qualified service personnel.
- 11 Unplug this product from the wall outlet and refer servicing to qualified service personnel under the following conditions:
 - a When the power cord or plug is damaged or frayed.
 - b If liquid has been spilled onto the product.
 - c If the product has been exposed to rain or water.
 - d If the product does not operate normally when the operating instructions are followed. Adjust only those controls that are covered by the operating instructions, since improper adjustment of other controls may result in damage and will often require extensive work by a qualified technician to restore the product to normal condition.
 - e If the product has been dropped or the case has been damaged.
 - f If the product exhibits a distinct change in performance, indicating a need for service.
- 12 Use only the proper type of power supply cord set (provided in your accessories box) for this unit. It should be a detachable type: UL listed/CSA certified, type SPT-2, rated 7A 125V minimum, VDE approved or its equivalent. Maximum length is 15 feet (4.6 meters).
- 13 Always disconnect all telephone lines from the wall outlet before servicing or disassembling this equipment.
- 14 Avoid using a telephone line (other than the cordless type) during an electrical storm. There may be a remote risk of electric shock from lightning.

Macrovision copyright protection notice

This product incorporates copyright protection technology that is protected by U.S. patents and other intellectual property rights. Use of this copyright protection technology must be authorized by Macrovision, and is intended for home and other limited viewing uses only unless otherwise authorized by Macrovision. Reverse engineering or disassembly is prohibited.

U.S. Patent Nos. 4,631,603; 4,819,098; 4,907,093; 5,315,448; and 6,516,132.

Lithium battery statement

CAUTION

Danger of explosion if battery is incorrectly replaced. Replace only with the same or equivalent type recommended by the manufacturer. Dispose of used batteries according to local regulations. Recycle if possible.

ADVARSEL!

Lithiumbatteri - Eksplosionsfare ved fejlagtig håndtering. Udskiftning må kun ske med batteri af samme fabrikat og type. Léver det brugte batteri tilbage til leverandøren.

ADVARSEL

Eksplosjonsfare ved feilaktig skifte av batteri. Benytt samme batteritype eller en tilsvarende type anbefalt av apparatfabrikanten. Brukte batterier kasseres i henhold til fabrikantens instruksjoner.

VARNING

Explosionsfara vid felaktigt batteribyte. Använd samma batterityp eller en ekvivalent typ som rekommenderas av apparattillverkaren. Kassera använt batteri enligt fabrikantens instruktion.

VAROITUS

Päristo voi räjähtää, jos se on virheellisesti asennettu. Vaihda paristo ainoastaan laitevalmistajan suosittelemaan tyyppiin. Hävitä käytetty paristo valmistajan ohjeiden mukaisesti.

VORSICHT!

Explosionsgefahr bei unsachgemäßen Austausch der Batterie Ersatz nur durch denselben oder einem vom Hersteller empfohlenem ähnlichen Typ. Entsorgung gebrauchter Batterien nach Angaben des Herstellers.

Laser compliance statement

The CD or DVD drive used with this computer is a laser product. The CD or DVD drive's classification label content (shown below) is located on the drive.

CLASS 1 LASER PRODUCT

CAUTION: INVISIBLE LASER RADIATION WHEN OPEN. AVOID EXPOSURE TO BEAM.

APPAREIL A LASER DE CLASSE 1 PRODUIT

LASERATTENTION: RADIATION DU FAISCEAU LASER INVISIBLE EN CAS D'OUVERTURE. EVITER TOUTE EXPOSITION AUX RAYONS.

LUOKAN 1 LASERLAITE LASER KLASSE 1

VORSICHT: UNSICHTBARE LASERSTRAHLUNG, WENN ABDECKUNG GEÖFFNET NICHT DEM STRAHL AUSSETZEN

PRODUCTO LÁSER DE LA CLASE I

ADVERTENCIA: RADIACIÓN LÁSER INVISIBLE AL SER ABIERTO. EVITE EXPONERSE A LOS RAYOS.

ADVARSEL: LASERSTRÅLING VED ÅBNING SE IKKE IND I STRÅLEN.

VARO! LAVATTAESSA OLET ALTTINA LASERSÄTEILYLLE.

WARNING: LASERSTRÅLNING NÅR DENNA DEL ÅR ÖPPNAD ÅLÅ TUIJOTA SÄTEESEENSTIRRA EJ IN I STRÅLEN

WARNING: LASERSTRÅLNING NAR DENNA DEL ÅR ÖPPNADSTIRRA EJ IN I STRÅLEN

ADVARSEL: LASERSTRÅLING NAR DEKSEL ÅPNESSTIRR IKKE INN I STRÅLEN

Federal Communications Commission Declaration of Conformity

This device complies with Part 15 of the FCC Rules. Operation is subject to the following two conditions: (1) This device may not cause harmful interference, and (2) This device must accept any interference received, including interference that may cause undesired operation.

The following local manufacturer/importer is responsible for this declaration:

Product name:	Personal computer
Model:	Veriton 5800/6800/7800
Name of responsible party:	Acer America Corporation
Address of responsible party:	2641 Orchard Parkway San Jose, CA 95134 USA
Contact person:	Mr. Young Kim
Tel:	408-922-2909
Fax:	408-922-2606

Declaration of Conformity for CE marking

Name of manufacturer: Acer Inc.
 Address of manufacturer: 8F, 88, Sec. 1, Hsin Tai Wu Rd.
 Hsichih, Taipei Hsien 221
 Taiwan, ROC
 Declares that product: Personal computer
 Model: Veriton 5800/6800/7800

Conforms to the EMC Directive 89/336/EEC as attested by conformity with the following harmonised standards:

EN55022:1994 /A2: 1997: Limits and Methods of Measurement of Radio Interference characteristics of Information Technology Equipment

EN55024: 1998/A1: 2001: Information technology equipment — Immunity characteristics — Limits and methods of measurement including:

EN61000-4-2: 1995/A1: 1998/A2: 2001	EN61000-4-6: 1996/A1: 2001
EN61000-4-3: 1996/A1: 1998	EN61000-4-8: 1993/A1: 2001
EN61000-4-4: 1995/A2: 2001	EN61000-4-11: 1994/A1: 2001
EN61000-4-5: 1995/A1: 2001	

EN61000-3-2: 2000: Limits for harmonics current emissions

EN61000-3-3: 1995/A1: 2001: Limits for voltage fluctuations and flicker in low-voltage supply systems

Conforms to the Low Voltage Directive 73/23/EEC as attested by conformity with the following harmonised standard:

EN60950: 2000: Safety of Information Technology Equipment Including electrical business equipment. This equipment has been approved to Council Decision 98/482/EC (CTR21) for pan-European single terminal connection to the Public Switched Telephone Network (PSTN).

We, Acer Inc., hereby declare that the equipment bearing the trade name and model number specified above was tested conforming to the applicable Rules under the most accurate measurement standards possible, and that all the necessary steps have been taken and are in force to assure that production units of the same equipment will continue to comply with the requirements.

Easy Lai
 Easy Lai, Director
 Qualification Center
 Product Assurance

03/15/2005
 Date

Appendix B:

Taking care of your computer

Please read the important instructions listed in this section. Following these instructions will help you maximize the durability of your computer.

Important tips

- Do not expose the computer to direct sunlight. Do not place it near sources of heat, such as a radiator.
- Do not expose the computer to temperatures below 0 °C (32 °F), or above 40 °C (104 °F).
- Do not subject the computer to magnetic fields.
- Do not expose the computer to rain or moisture.
- Do not spill water on the computer.
- Do not subject the computer to heavy shock or vibration.
- Do not expose the computer to dust or dirt.
- Never place the system on uneven surfaces.
- Do not step on the power cord or place heavy objects on top of it. Carefully route the power cord and any cables away from foot traffic.
- When unplugging the power cord, do not pull on the cord itself instead pull on the plug.
- The total ampere rating of the equipment plugged in should not exceed the ampere rating of the cord if you are using an extension cord. Also, the total current rating of all equipment plugged into a single wall outlet should not exceed the fuse rating.
- Check the documentation that came with your software programs to see if you can select other combinations of resolution and color. These adjustments could make viewing the screen more comfortable.

Cleaning and servicing

To clean your computer and keyboard

- 1 Turn off the computer and unplug the power cord.
- 2 Use a soft cloth moistened with water and gently wipe the exterior of the computer and the keyboard. Do not use liquid or aerosol cleaners.

To clean your pointing device

To clean a regular mouse (with rubber ball)

- 1 Open the circular cover underneath the mouse.
- 2 Take out the rubber ball and wipe it with a soft, water-moistened cloth.
- 3 Put the ball back and close the cover.

To clean an optical mouse

For users of an optical mouse, refer to the documentation that came with your mouse for maintenance instructions.

To clean your monitor

Make sure that you keep your screen clean. For cleaning instructions, refer to the documentation that came with your monitor.

When to contact a service technician

- If you dropped and damaged the computer.
- If liquid has been spilled onto the computer.
- If the computer is not operating normally.
- If a computer problem persists even after you have checked and done the troubleshooting tips discussed in the **"Frequently asked questions" on page 73.**
- If your problem is not listed in the **"Frequently asked questions" on page 73.**
- If you want to replace or upgrade any of your computer's internal components.

Asking for technical assistance

For technical assistance, contact your local dealer or distributor. You may also access the Web site (www.acersupport.com) for information on how and where to contact the service centers available in your area.

Index

- A
 - accessing the online User's Guide 5
 - applications 55
- B
 - BIOS utility 60
- C
 - computer cover
 - remove 41
 - replace 41
 - computer maintenance 86
 - cleaning 86
 - servicing 86
 - connecting options
 - multimedia devices 33
 - audio line-in device 35
 - earphones/headphones 34
 - external speakers 33
 - microphone 33
 - network 31, 32
 - printer 31
 - serial mouse 32
 - USB devices 35
- D
 - disk drives
 - CD-ROM/DVD-ROM/CD-RW drive
 - inserting CDs/DVDs 20
 - taking care CDs/DVDs 22
 - hard disk 22
- F
 - features 9
 - connectivity 9
 - multimedia 9
 - performance 9
 - Frequently-asked questions 73
 - blank screen 73
 - no audio 74
 - no sound 74
 - printer not working 74
 - system cannot read disk 74
 - system cannot write to disk 74
 - system did not boot up 73
- front panel 10
- I
 - internet/suspend key
 - email 16
 - suspend 16
 - web browser 16
- K
 - keyboard 15
- L
 - lock keys
 - Caps Lock 17
 - Num Lock 17
 - Scroll Lock 17
- M
 - mainboard
 - Veriton mainboard 44
 - multimedia key
 - forward 16
 - play/pause 16
 - stop 16
- N
 - NTI 58
- P
 - PowerDVD 59
- R
 - rear panel 12
 - recovering your system 60
 - remove the side panel 42
- S
 - safety
 - CD-ROM 81
 - FCC notice 76
 - general instructions 78
 - modem notices 77
 - setting up computer 25, 27
 - area 25
 - chair 25
 - connecting peripherals
 - external monitor 28
 - power cable 29
 - keyboard 26
 - monitor 26

- mouse 26
- software 55
 - Norton AntiVirus 57
- system boards 44
 - mainboard 44
- system utilities
 - Acrobat Reader 55
 - Norton AntiVirus 57
 - NTI CD-Maker 58
 - PowerDVD 59
 - reinstalling programs 60

T

- turning off computer 30
 - software shutdown 30
 - suspend mode 30
- turning on computer 30
 - power button 30

U

- upgrade
 - add memory 46
 - install DDR DIMM 47
 - reconfigure computer 48
 - computer 46
 - install an expansion card 49
 - installation precautions
 - post-installation 40
 - open computer
 - reinstall side panel 43
 - replace components
 - memory 46

V

- Veriton mainboard layout 44