



Your Reliable Partner

NI8 SLI

*Intel Pentium 4 System Board
Socket 775*

User's Manual

Copyright and Warranty Notice

The information in this document is subject to change without notice and does not represent a commitment on part of the vendor, who assumes no liability or responsibility for any errors that may appear in this manual.

No warranty or representation, either expressed or implied, is made with respect to the quality, accuracy or fitness for any particular part of this document. In no event shall the manufacturer be liable for direct, indirect, special, incidental or consequential damages arising from any defect or error in this manual or product.

Product names appearing in this manual are for identification purpose only and trademarks and product names or brand names appearing in this document are the property of their respective owners.

This document contains materials protected under International Copyright Laws. All rights reserved. No part of this manual may be reproduced, transmitted or transcribed without the expressed written permission of the manufacturer and authors of this manual.

If you do not properly set the motherboard settings, causing the motherboard to malfunction or fail, we cannot guarantee any responsibility.

Table of Contents

Chapter 1. Introduction	1-1
1-1. Features & Specifications	1-1
1-2. Layout Diagram	1-3
Chapter 2. Hardware Setup	2-1
2-1. Install The Motherboard.....	2-1
2-2. Install CPU, Heatsink and Fan Assembly	2-2
2-3. Install System Memory	2-4
2-4. Install two Graphics Cards with NVIDIA SLI Technology	2-6
2-5. Connectors, Headers and Switches	2-9
(1). ATX Power Input Connectors	2-9
(2). FAN Power Connectors.....	2-10
(3). CMOS Memory Clearing Header.....	2-11
(4). Wake-up Header.....	2-12
(5). AudioMAX Slot.....	2-13
(6). Front Panel Switches & Indicators Headers	2-15
(7). Additional USB Port Headers	2-16
(8). GURU Clock Connection Header	2-17
(9). Floppy and IDE Disk Drive Connectors	2-18
(10). POST Code Display	2-19
(11). Serial ATA Connectors	2-20
(12). PCI Express x16 Slot	2-20
(13). PCI Express x1 Slots.....	2-21
(14). SLI Switchboard Slot.....	2-21
(15). Back Panel Connectors	2-22
Chapter 3. BIOS Setup	3-1
3-1. μ Guru™ Utility	3-2
3-2. Standard CMOS Features.....	3-12
3-3. Advanced BIOS Features.....	3-15
3-4. Advanced Chipset Features.....	3-18
3-5. Integrated Peripherals	3-19
3-6. Power Management Setup.....	3-23
3-7. PnP/PCI Configurations.....	3-26
3-8. Load Fail-Safe Defaults	3-28
3-9. Load Optimized Defaults	3-28
3-10. Set Password	3-28

3-11.	Save & Exit Setup	3-28
3-12.	Exit Without Saving.....	3-28
<i>Appendix A.</i>	<i>Install nVidia nForce Chipset Driver.....</i>	<i>A-1</i>
<i>Appendix B.</i>	<i>Install Realtek Audio Driver.....</i>	<i>B-1</i>
<i>Appendix C.</i>	<i>Install Silicon Image 3132 SATA Driver.....</i>	<i>C-1</i>
<i>Appendix D.</i>	<i>Install Silicon Image 3132 RAID Driver.....</i>	<i>D-1</i>
<i>Appendix E.</i>	<i>Install USB 2.0 Driver</i>	<i>E-1</i>
<i>Appendix F.</i>	<i>Install uGuru Utility</i>	<i>F-1</i>
<i>Appendix G.</i>	<i>Generate NV RAID Floppy Disk</i>	<i>G-1</i>
<i>Appendix H.</i>	<i>Generate SIL3132 RAID Floppy Disk.....</i>	<i>H-1</i>
<i>Appendix I.</i>	<i>POST Code Definition</i>	<i>I-1</i>
<i>Appendix J.</i>	<i>Troubleshooting (Need Assistance?).....</i>	<i>J-1</i>
<i>Appendix K.</i>	<i>How to Get Technical Support</i>	<i>K-1</i>

Chapter 1. Introduction

1-1. Features & Specifications

1. CPU

- Designed for Intel® Pentium 4 LGA775 processor with 1066/800 MHz FSB
- Supports Intel® Hyper-Threading / XD-bit / EM64T Technology
- Enhanced Intel® SpeedStep Technology

2. Chipset

- NVIDIA C19/MCP-04
- NVIDIA Gigabit Ethernet with NVIDIA Firewall
- Supports NV SATA 3G RAID

3. NVIDIA SLI Technology

- Two PCI-Express x16 slots support NVIDA Scalable Link Interface

4. Memory

- Four 240-pin DIMM slots (Un-buffered Non-ECC DIMM)
- Supports dual channel DDR2 667 (Max. 8GB)

5. ABIT Engineered

- ABIT uGuru™ Technology
- ABIT Q-OTES™ Technology
- ABIT AudioMAX™ Technology
- ABIT CPU ThermalGuard™ Technology

6. NV SATA RAID

- Serial ATA 3Gbps data transfer rate
- Supports SATA RAID 0/1/0+1

7. 2nd SATA RAID

- Serial ATA 3Gbps by Sil 3132 PCIE controller
- Supports SATA RAID 0/1 NCQ

8. NV GbE LAN

- NVIDIA Gigabit Ethernet
- NVIDIA Secure Networking Engine

9. NV Firewall

- Native NVIDIA Firewall

10. Audio

- High quality 7.1 channel AudioMAX Card.

- Supports auto jack sensing and optical S/PDIF In/Out

11. Internal I/O Connectors

- 2x PCI Express x16 slots
- 2x PCI Express x1 slots
- 2x PCI slots
- 1x AudioMAX slot
- 1x Floppy port supports up to 2.88MB
- 2x Ultra DMA 133/100/66/33 connectors
- 6x SATA connectors
- 3x USB headers

12. Back Panel I/O

- ABIT Silent-OTES™ Technology
- 1x PS/2 keyboard, 1x PS/2 mouse
- 4x USB connectors
- 1x RJ-45 LAN connector

13. Miscellaneous

- ATX form factor (305mm x 245mm)

*** Specifications and information contained herein are subject to change without notice.**

1-2. Layout Diagram

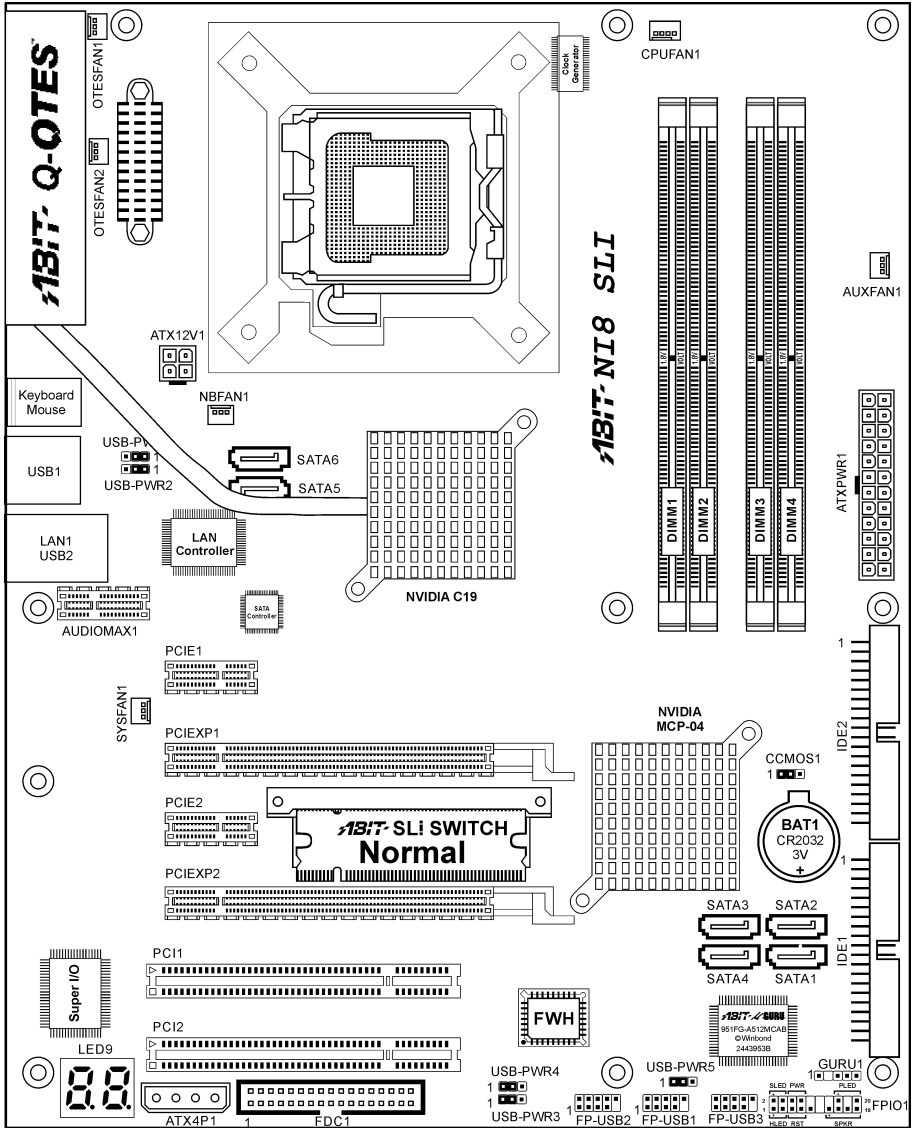



Chapter 2. Hardware Setup

Before installation: Turn off the power supply switch (fully turn off the +5V standby power), or disconnect the power cord before installing or unplugging any connectors or add-on cards. Failing to do so may cause the motherboard components or add-on cards to malfunction or become damaged.

2-1. Install The Motherboard

Most computer chassis have a base with many mounting holes to allow the motherboard to be securely attached, and at the same time, prevent the system from short circuits. There are two ways to attach the motherboard to the chassis base:

1. use studs, or
2. use spacers

In principle, the best way to attach the board is to use studs. Only if you are unable to do this should you attach the board with spacers. Line up the holes on the board with the mounting holes on the chassis. If the holes line up and there are screw holes, you can attach the board with studs. If the holes line up and there are only slots, you can only attach with spacers. Take the tip of the spacers and insert them into the slots. After doing this to all the slots, you can slide the board into position aligned with slots. After the board has been positioned, check to make sure everything is OK before putting the chassis back on.

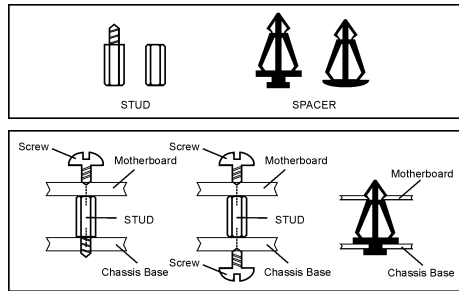

ATTENTION: To prevent shorting the PCB circuit, please REMOVE the metal studs or spacers if they are already fastened on the chassis base and are without mounting-holes on the motherboard to align with.

2-2. Install CPU, Heatsink and Fan Assembly

In order to protect the contact pins, please pay attention to these notices:

1. A maximum 20 cycles of CPU installation is recommended.
2. Never touch the contact pins with fingers or any object.
3. Always put on the cap when the CPU is not in use.

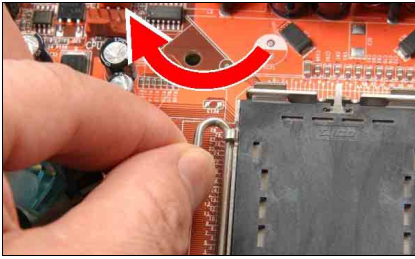

1. Place the board so as to let the lever hook of the socket is on your left side. Use your left thumb and forefinger to hold the lever hook, pull it away from the retention tab.



2. Rotate the lever to fully open position.

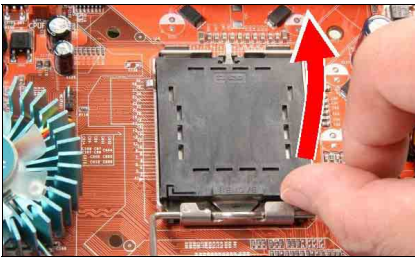

3. Use your right thumb on the bottom-right side of the load plate and lift it up to fully open position.

NOTE: Intel® 2.8G Dual Core CPU is not supported by NVIDIA nForce4 SLI Intel Edition processors.

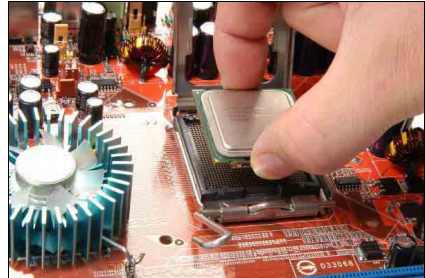

4. Use your right thumb and forefinger to grasp the CPU package. Be sure to grasp on the edge of the substrate, and face the Pin-1 indicator toward the bottom-left side. Aim at the socket and place the CPU package vertical down into the socket.

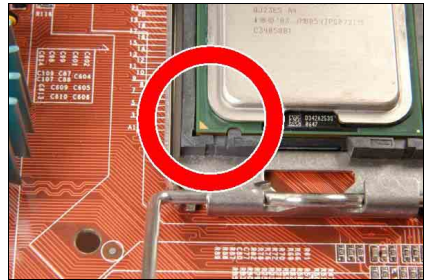

5. Visually inspect if the CPU is seated well into the socket. The alignment key must be located in the notch of package.

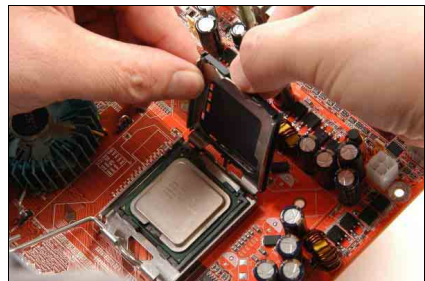

6. Use your left hand to hold the load plate, and use your right thumb to peel the cap off.

The cap plays an important role in protecting contact pins. In order to prevent bent pin, PUT ON the cap after operation or testing.



7. Lower the plate onto the CPU package. Engage the load lever while gently pressing down the load plate.



8. Secure the lever with the hook under retention tab.



9. Place the heatsink and fan assembly onto the socket. Align the four fasteners toward the four mounting holes on the motherboard.

For detailed information on how to install your heatsink and fan assembly, please refer to the instruction manual came packed with the heatsink and fan assembly you bought



10. Press each of the four fasteners down into the mounting holes.

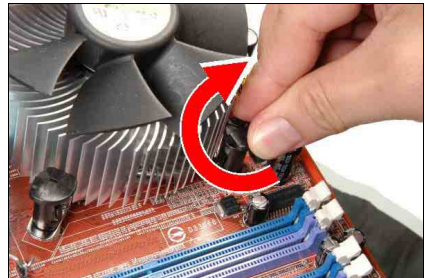

11. Rotate the fastener clock-wise to lock the heatsink and fan assembly into position.

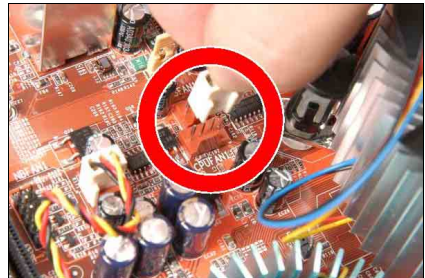

12. Attach the four-pin power plug from the heatsink and fan assembly to the CPU FAN connector.

2-3. Install System Memory

This motherboard provides four 240-pin DIMM slots for Single/Dual Channel DDR2 667 memory modules with memory expansion size up to 8GB.

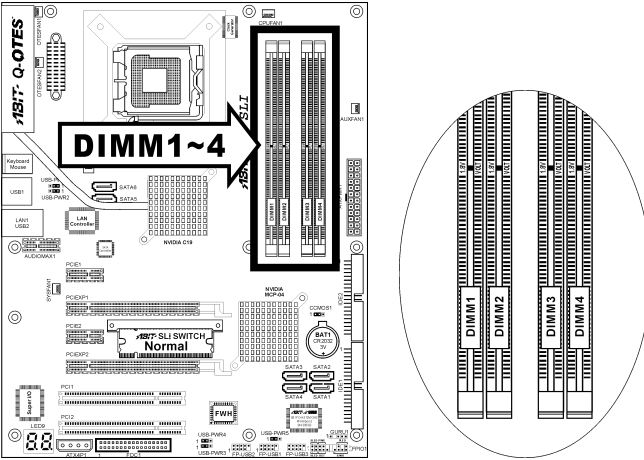

- To reach the optimum performance in dual-channel configurations, install identical DDR2 DIMM pairs for each channel.
- Install DIMMs with the same CAS latency. To reach the optimum compatibility, obtain memory modules from the same vendor.
- Due to chipset resource allocation, the system may detect less than 4GB of system memory in the installation of four 1GB DDR2 memory modules.
- Due to chipset limitation, 128MB DIMM modules or double-sided x16 memory chips are not supported.

There are several methods of different DDR2 configurations depending on how the DIMMs are populated on each system memory channel:

- **[Single Channel]**: only one channel is populated.

Method	Channel A		Channel B	
	DIMM1	DIMM2	DIMM3	DIMM4
1	512MB	-	-	-
2	-	512MB	-	-
3	-	-	512MB	-
4	-	-	-	512MB
5	512MB	512MB	-	-
6	-	-	512MB	512MB

- **[Dual Channel Asymmetric]:** both channels are populated, but each channel has a different amount of total memory. (Channel A \neq Channel B)

Method	Channel A		Channel B	
	DIMM1	DIMM2	DIMM3	DIMM4
1	512MB	-	256MB	-
2	-	256MB	-	512MB
3	512MB	-	-	256MB
4	-	256MB	512MB	-
5	256MB	256MB	256MB	-
6	256MB	256MB	-	256MB
7	256MB	-	256MB	256MB
8	-	256MB	256MB	256MB
9	256MB	256MB	512MB	512MB
10	256MB	256MB	256MB	512MB

- **[Dual Channel Symmetric]:** both channels are populated where each channel has the same amount of total memory. (Channel A = Channel B)

Method	Channel A		Channel B	
	DIMM1	DIMM2	DIMM3	DIMM4
1	512MB	-	512MB	-
2	-	512MB	-	512MB
3	512MB	-	-	512MB
4	-	512MB	512MB	-
5	256MB	256MB	512MB	-
6	256MB	256MB	-	512MB
7	512MB	-	256MB	256MB
8	-	512MB	256MB	256MB
9	512MB	256MB	512MB	256MB
10	256MB	512MB	256MB	512MB

Power off the computer and unplug the AC power cord before installing or removing memory modules.

1. Locate the DIMM slot on the board.
2. Hold two edges of the DIMM module carefully, keep away of touching its connectors.
3. Align the notch key on the module with the rib on the slot.
4. Firmly press the module into the slots until the ejector tabs on both sides of the slot automatically snaps into the mounting notch. Do not force the DIMM module in with extra force as the DIMM module only fit in one direction.
5. To remove the DIMM modules, push the two ejector tabs on the slot outward simultaneously, and then pull out the DIMM module.

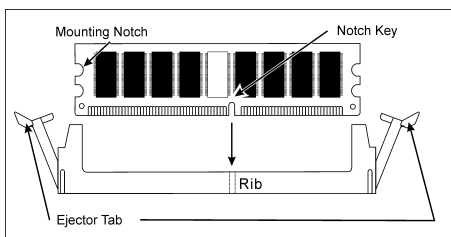

ATTENTION: Static electricity can damage the electronic components of the computer or optional boards. Before starting these procedures, ensure that you are discharged of static electricity by touching a grounded metal object briefly.

2-4. Install two Graphics Cards with NVIDIA SLI Technology

This motherboard supports the NVIDIA SLI (Scalable-Link-Interface) technology, allowing the operation of two identical (the same model from the same manufacturer) PCI Express x16 graphics cards.

NOTE: The NVIDIA SLI technology currently supports the Windows XP operating system only.

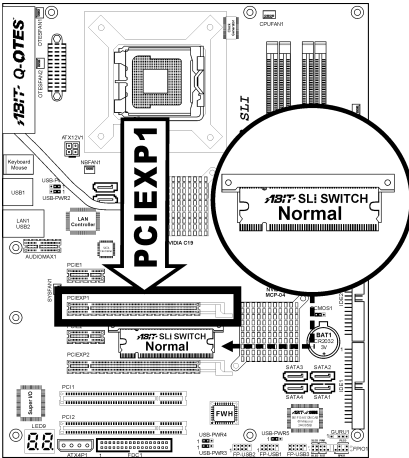

Normal Mode: Leave the SLI Switch to its default Normal mode and insert the graphics card into PCIEXP1 slot. The PCIEXP2 slot functions as a PCIe x1 slot under this mode.

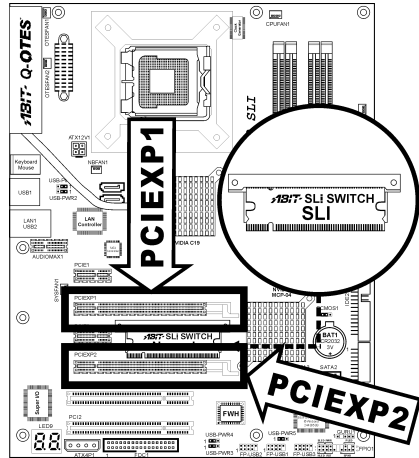

SLI Mode: Switch the SLI Switch to SLI Mode and insert the SLI-ready graphics cards into PCIEXP1 and PCIEXP2 slots.

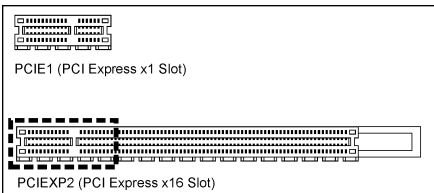

NOTE: When PCIEXP2 slot functions as a PCIe x1 slot under **Normal mode**, insert the PCIe x1 card into the marked area of PCIEXP2 slot.

This motherboard is factory pre-installed with an ABIT SLI switchboard. By the default “Normal” mode, this motherboard is set for one single graphics card operation. To operate two graphics cards on this motherboard, you will have to set the switchboard to “SLI” mode in advance.

- Prepare two identical NVIDIA certified, SLI-ready PCI Express x16 graphics cards.
- Make sure the graphics card driver supports the NVIDIA SLI technology. Download the latest driver form NVIDIA website (www.nvidia.com).
- Make sure your power supply unit is sufficient to provide the minimum power required.

Please follow the instructions below to set the system to SLI mode and install your graphics cards.

NOTE: Please handle the switchboard with caution. Watch out for the sharp edges.

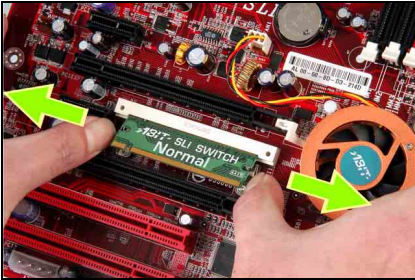

1. Simultaneously push the two retention clips at both ends outward to release the switchboard. Carefully pull the switchboard out of the slot.

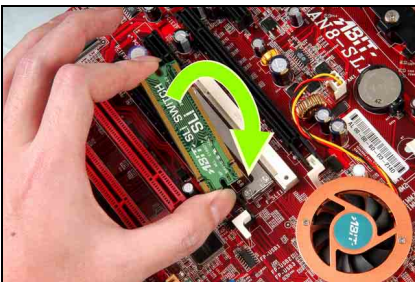

2. Flip the switchboard over to the side labeled “SLI”. Carefully insert the switchboard into the slot.

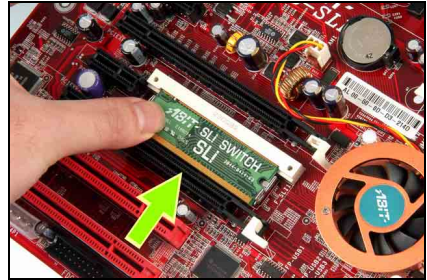

3. Slightly push down the switchboard until the retention clip snap into places. Make sure the switchboard is completely inserted into the slot.

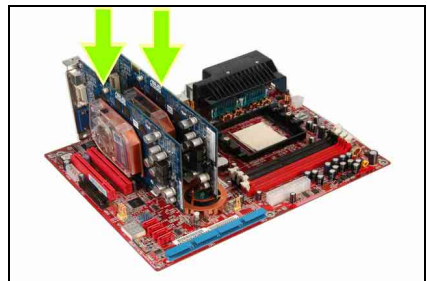

4. Insert the two graphics cards into PCIEXP1 and PCIEXP2 slots on the motherboard.



5. There are goldfingers on your SLI Graphics Cards reserved for the SLI Bridge Connector.

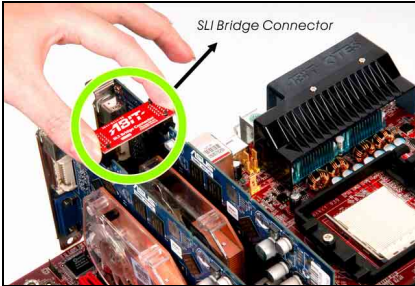

6. Insert the SLI Bridge Connector into the SLI goldfingers on each graphics card.

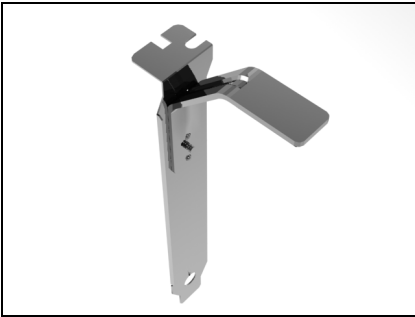

7. The SLI bracket included in the package is used for supporting the SLI bridge connector and the two SLI graphics cards.

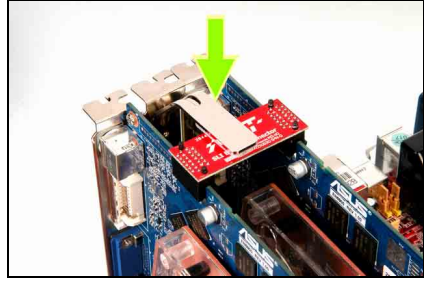

8. Insert the SLI bracket into the bracket slot between the graphics cards. Secure the SLI bracket and the graphics cards to the chassis with screws.

NOTE: The OTES SLIstream that packed in the package is optional. Please refer to the Quick Installation Guide of the OTES SLIstream if you wish to install it.

IMPORTANT: Please disable the following items in BIOS setup while running under SLI mode: All the “**FanEQ controls**” (CPU, NB, SYS, OTES and AUX FanEQ Control). The system may be unstable without doing so. Detail information about these items will be described in “**Chapter 3. BIOS Setup**”.

2-5. Connectors, Headers and Switches

Here we will show you all of the connectors, headers and switches, and how to connect them. Please read the entire section for necessary information before attempting to finish all the hardware installation inside the computer chassis. A complete enlarged layout diagram is shown in Chapter 1 for all the position of connectors and headers on the board that you may refer to.

WARNING: Always power off the computer and unplug the AC power cord before adding or removing any peripheral or component. Failing to do so may cause severe damage to your motherboard and/or peripherals. Plug in the AC power cord only after you have carefully checked everything.

(1). ATX Power Input Connectors

This motherboard provides two power connectors to connect ATX12V power supplier.

NOTE: This 24-pin power connector “ATXPWR1” is compliant to the former 20-pin type. Pay attention to the orientation when doing so (Pin-11, 12, 23, and 24 should be left un-connected).

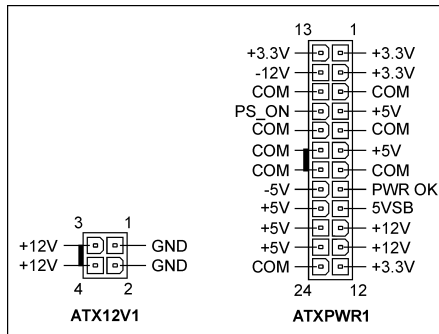
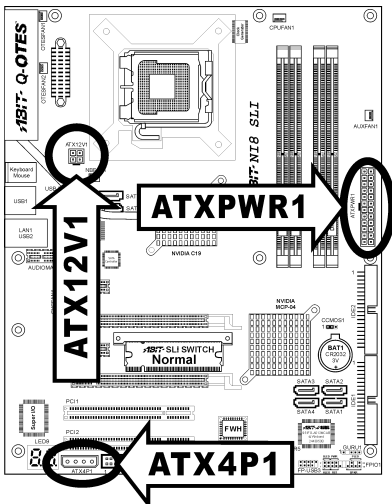

NOTE: For a heavily loaded system, a power supply that provides a minimum of 350W and 20A on the +5VDC rail is recommended. To support wake-up features, 2A on the +5VSB rail is required.

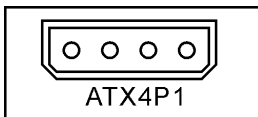

The auxiliary 12V power connector [ATX4P1] provides an additional power source for devices added on PCI Express slots. It is highly recommended to attach 12V power from the power supplier for the best system stability.

(2). FAN Power Connectors

These connectors each provide power to the cooling fans installed in your system.

- **CPUFAN1:** CPU Fan Power Connector
- **NBFAN1:** Chipset Fan Power Connector
- **SYSFAN1:** System Fan Power Connector
- **AUXFAN1:** Auxiliary Fan Power Connector
- **OTESFAN1~2:** OTES Fan Power Connector

WARNING: These fan connectors are not jumpers. DO NOT place jumper caps on these connectors.

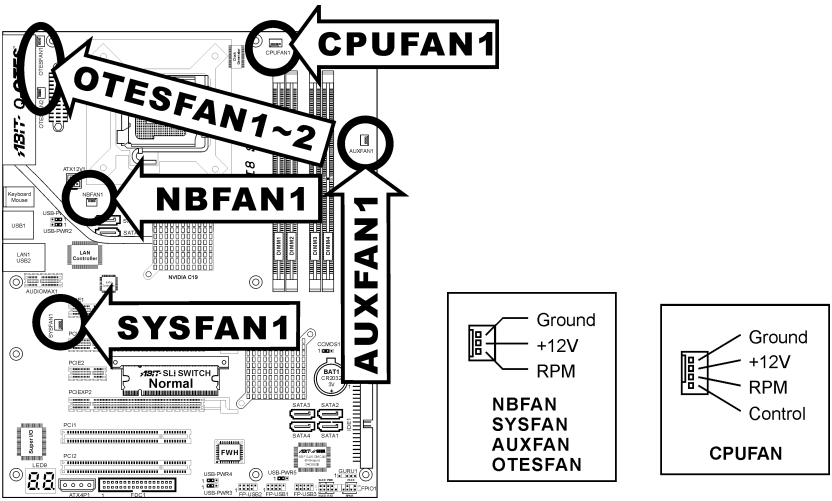

(3). CMOS Memory Clearing Header

This header uses a jumper cap to clear the CMOS memory.

- **Pin 1-2 shorted (default):** Normal operation.
- **Pin 2-3 shorted:** Clear CMOS memory.

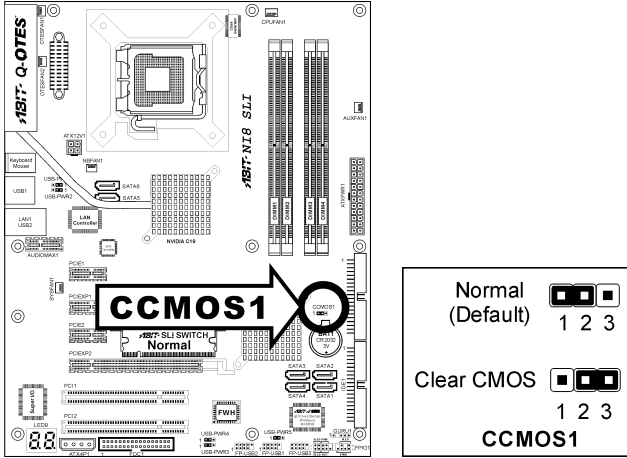

WARNING: Turn the power off first (including the +5V standby power) before clearing the CMOS memory. Failing to do so may cause your system to work abnormally or malfunction.

(4). **Wake-up Header**

These headers use a jumper cap to enable/disable the wake-up function.

- **USB-PWR1:**
Pin 1-2 shorted (default): Disable wake-up function support at USB port.
Pin 2-3 shorted: Enable wake-up function support at USB port
- **USB-PWR2:**
Pin 1-2 shorted (default): Disable wake-up function support at USB port.
Pin 2-3 shorted: Enable wake-up function support at USB port
- **USB-PWR3:**
Pin 1-2 shorted (default): Disable wake-up function support at USB port.
Pin 2-3 shorted: Enable wake-up function support at USB port
- **USB-PWR4:**
Pin 1-2 shorted (default): Disable wake-up function support at USB port.
Pin 2-3 shorted: Enable wake-up function support at USB port
- **USB-PWR5:**
Pin 1-2 shorted (default): Disable wake-up function support at USB port.
Pin 2-3 shorted: Enable wake-up function support at USB port

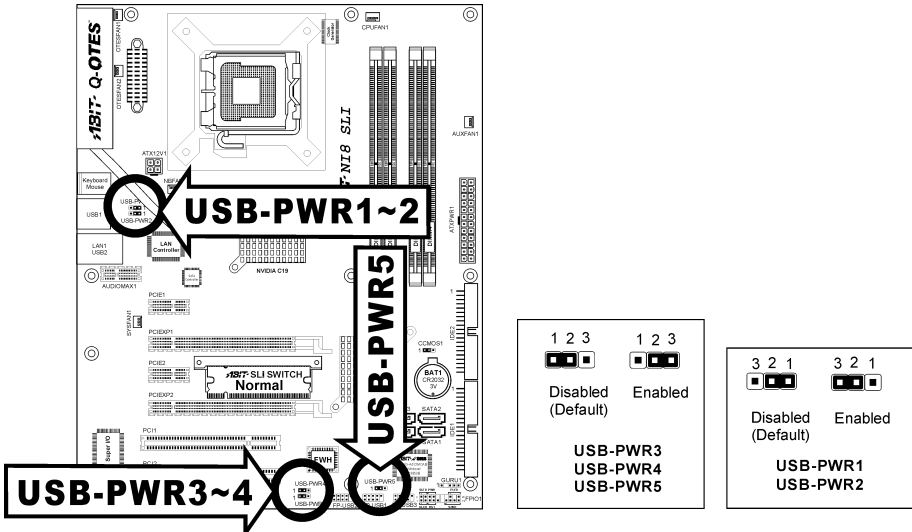

(5). **AudioMAX Slot**

The slot “AUDIOMAX1” provides the audio input/output connection at back panel through an audio daughter-card.

NOTE: Install this daughter-card at slot “AUDIOMAX1”.

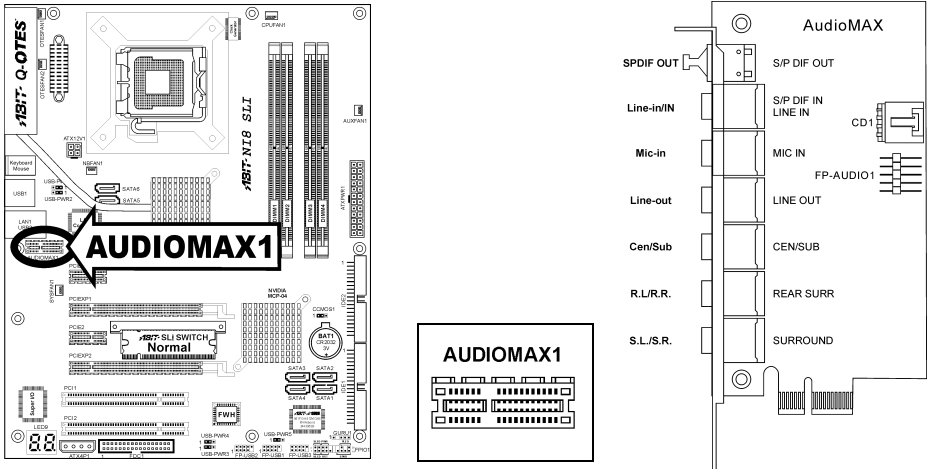

- **S/PDIF Out:** This connector provides an S/PDIF-Out connection through optical fiber to digital multimedia devices.
- **S/PDIF In:** This connector provides an S/PDIF-In connection through optical fiber to digital multimedia devices.
- **Line-In:** Connects to the line out from external audio sources.
- **Mic-In:** Connects to the plug from external microphone.
- **Line-Out:** Connects to the front left and front right channel in the 7.1-channel or regular 2-channel audio system.
- **Cen/Sub:** Connects to the center and subwoofer channel in the 7.1 channel audio system.
- **R.L./R.R. (Rear Left / Rear Right):** Connects to the rear left and rear right channel in the 7.1 channel audio system.
- **S.L./S.R. (Surround Left / Surround Right):** Connects to the surround left and surround right channel in the 7.1 channel audio system.

S/PDIF Connection:

Along with the motherboard package you can find an audio daughter-card for S/PDIF connection.

- **S/PDIF Input Connection:**

1. Plug the end with 3.5mm adapter into the [JK1] jack on this daughter-card. (This jack is used for either optical or line input.)
2. Remove the rubber protection-cap at the other end. Plug it into the [Digital-Out] (SPDIF-Out) jack on your digital multimedia device.

- **S/PDIF Output Connection:**

1. Pull out the 3.5mm adapter at one end. Keep this adapter with its protection-cap covered in save place. Plug the rest of this end into the [SPDIF-O] jack on this daughter-card.
2. Remove the rubber protection-cap at the other end. Plug it into the [Digital-In] (SPDIF-In) jack on your digital multimedia device.

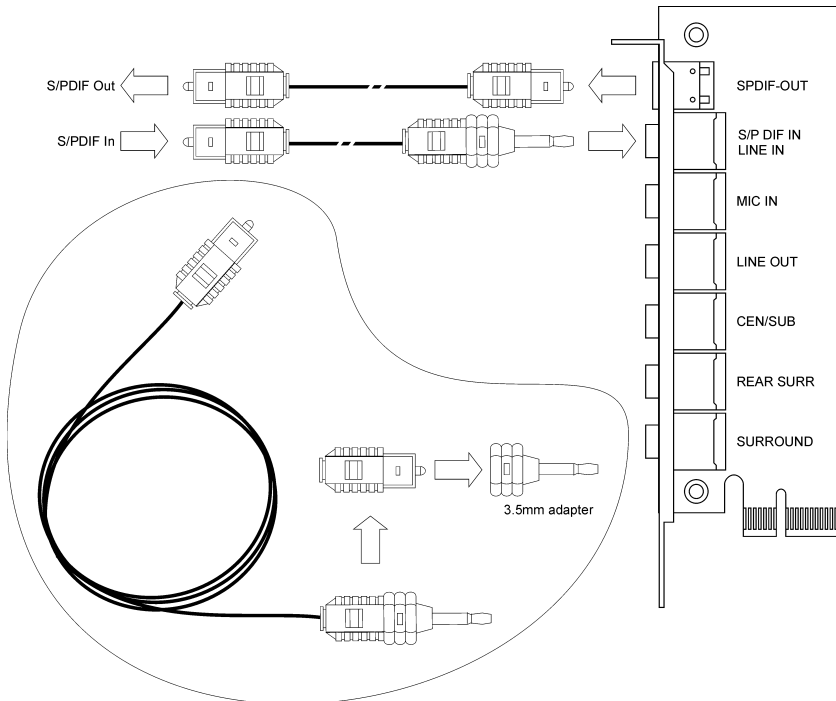

(6). Front Panel Switches & Indicators Headers

This header is used for connecting switches and LED indicators on the chassis front panel.

Watch the power LED pin position and orientation. The mark “+” align to the pin in the figure below stands for positive polarity for the LED connection. Please pay attention to connect these headers. A wrong orientation will only cause the LED not lighting, but a wrong connection of the switches could cause system malfunction.

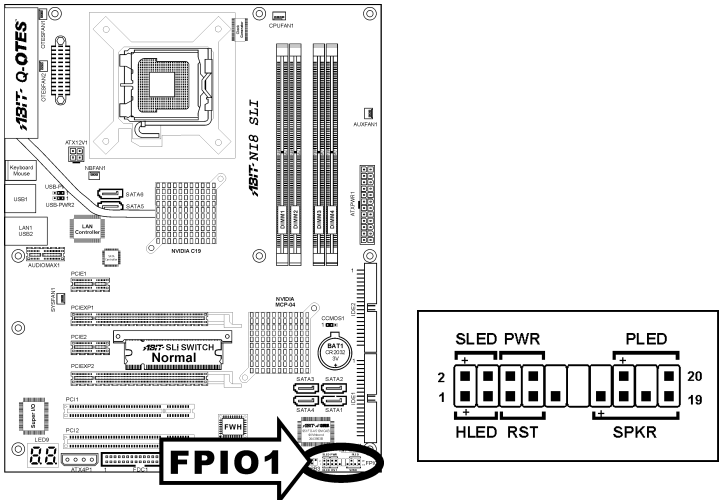

- **HLED (Pin 1, 3):**
Connects to the HDD LED cable of chassis front panel.
- **RST (Pin 5, 7):**
Connects to the Reset Switch cable of chassis front panel.
- **SPKR (Pin 13, 15, 17, 19):**
Connects to the System Speaker cable of chassis.
- **SLED (Pin 2, 4):**
Connects to the Suspend LED cable (if there is one) of chassis front panel.
- **PWR (Pin 6, 8):**
Connects to the Power Switch cable of chassis front panel.
- **PLED (Pin 16, 18, 20):**
Connects to the Power LED cable of chassis front panel.

(7). Additional USB Port Headers

These headers each provide 3 additional USB 2.0 ports connection through an USB cable designed for USB 2.0 specifications.

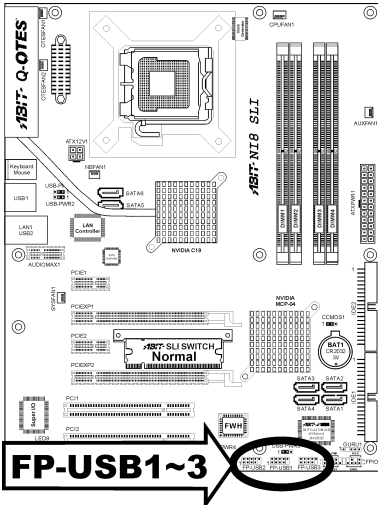

<p>FP-USB1 FP-USB2 FP-USB3</p>	Pin	Pin Assignment	Pin	Pin Assignment
	1	VCC	2	VCC
	3	Data0 -	4	Data1 -
	5	Data0 +	6	Data1 +
	7	Ground	8	Ground
	9	NC	10	NC

(9). Floppy and IDE Disk Drive Connectors

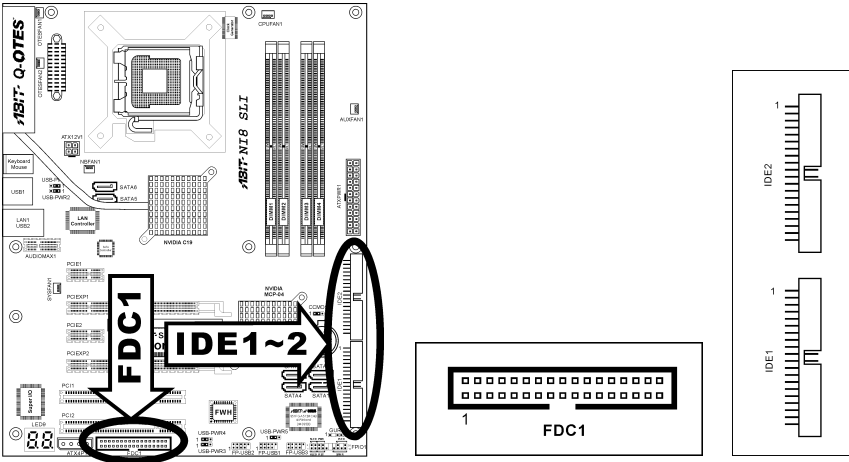

The FDC1 connector connects up to two floppy drives with a 34-wire, 2-connector floppy cable. Connect the single end at the longer length of ribbon cable to the FDC1 on the board, the two connectors on the other end to the floppy disk drives connector. Generally you need only one floppy disk drive in your system.

NOTE: The red line on the ribbon cable must be aligned with pin-1 on both the FDC1 port and the floppy connector.

Each of the IDE port connects up to two IDE drives at Ultra ATA/100 mode by one 40-pin, 80-conductor, and 3-conductor Ultra ATA/66 ribbon cables.

Connect the single end (blue connector) at the longer length of ribbon cable to the IDE port of this board, the other two ends (gray and black connector) at the shorter length of the ribbon cable to the connectors of your hard drives.

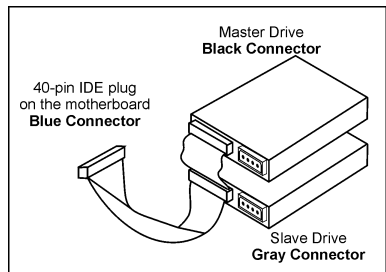

NOTE: Make sure to configure the “Master” and “Slave” relation before connecting two drives by one single ribbon cable. The red line on the ribbon cable must be aligned with pin-1 on both the IDE port and the hard-drive connector.

(10). POST Code Display

This is an LED device to display the “POST” Code, the acronym of **Power On Self Test**. The computer will execute the POST action whenever you power on the computer. The POST process is controlled by the BIOS. It is used to detect the status of the computer’s main components and peripherals. Each POST Code corresponds to different checkpoints that are also defined by the BIOS in advance. For example, “memory presence test” is an important checkpoint and its POST Code is “C1”. When the BIOS execute any POST item, it will write the corresponding POST Code into the address 80h. If the POST passes, the BIOS will process the next POST item and write the next POST Code into the address 80h. If the POST fails, we can check the POST Code in address 80h to find out where the problem lies.

This LED device also displays the “POST” Code of AC2005, an “uGuru” chipset developed exclusively by ABIT computer.

NOTE: The decimal point lights up when executing the AC2005 POST action.

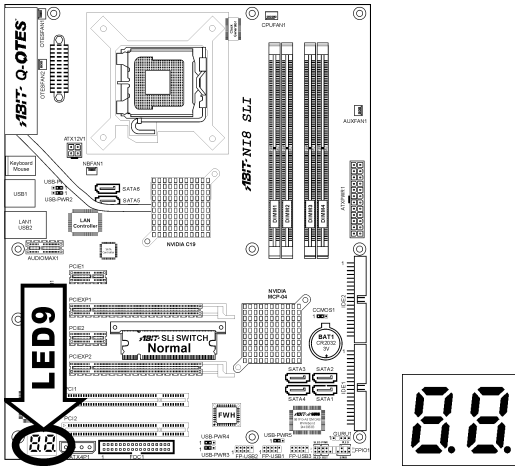

See Appendix for both AWARD and AC2005 POST Code definition.

(11). Serial ATA Connectors

These connectors are provided to attach one Serial ATA device at each channel via Serial ATA cable.

This motherboard provides RAID 0, RAID 1 and RAID 0+1 configuration for Serial ATA hard drives through the NVIDIA MCP-04 chipset. For SATA5 and SATA6 provided through the Silicon Image 3132 SATA chipset, you may configure a disk array by the Sil3132 SATA/RAID Driver option ROM utility.

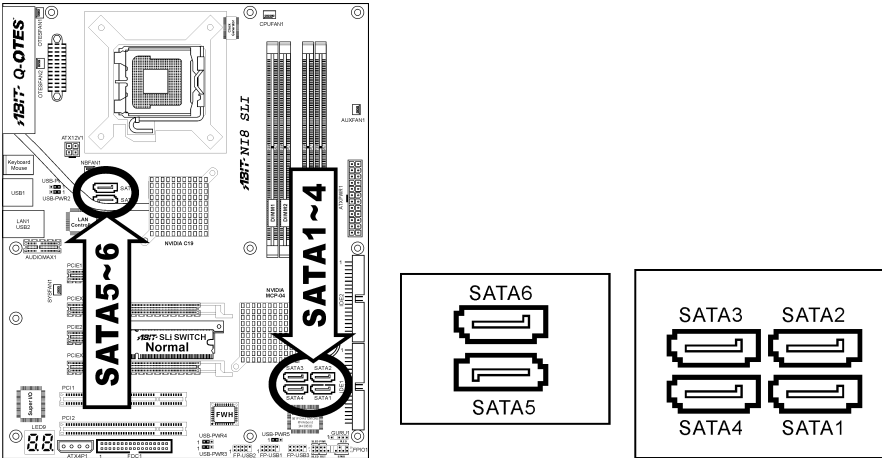

(12). PCI Express x16 Slot

This slot is used to attach the next generation of graphics architecture.

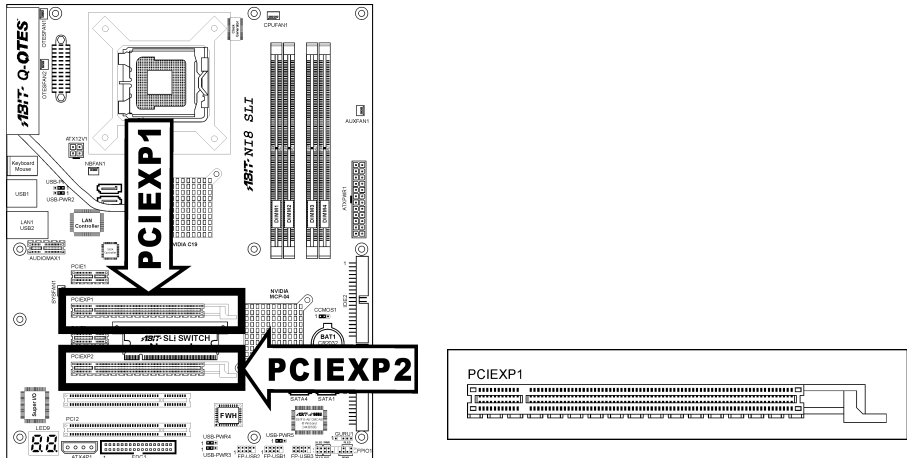

(13). PCI Express x1 Slots

These slots are used to attach the next generation of I/O architecture.

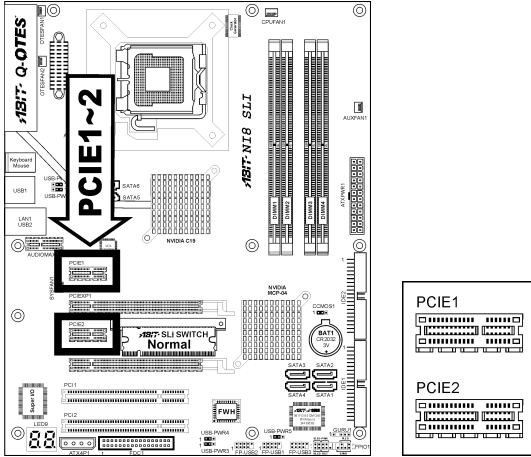

(14). SLI Switchboard Slot

This slot and the pre-installed ABIT SLI Switch set the graphic mode to either Normal or SLI mode.

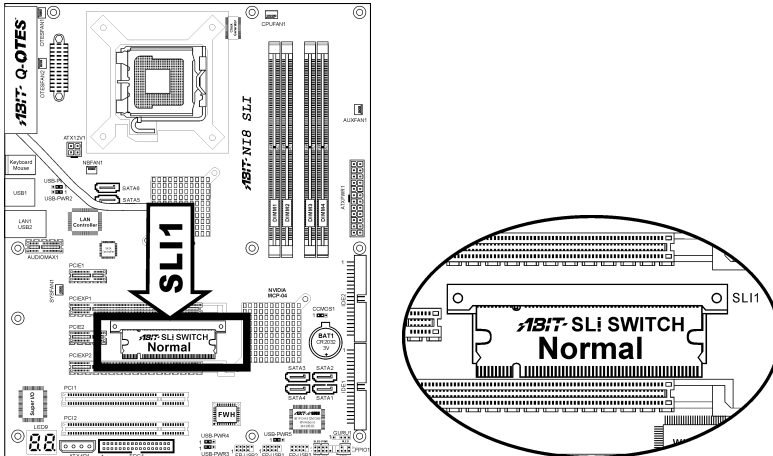

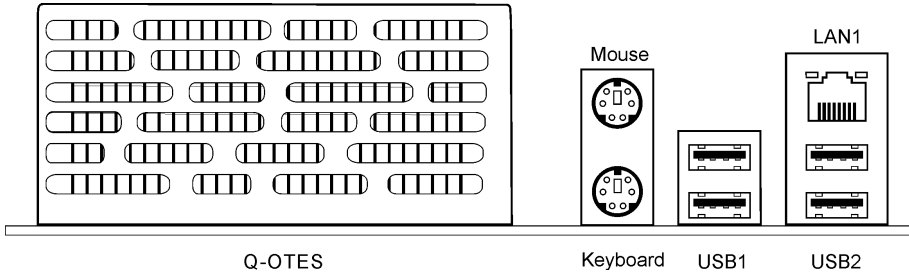
(15). Back Panel Connectors

- **Mouse:** Connects to PS/2 mouse.
- **Keyboard:** Connects to PS/2 keyboard.
- **LAN1:** Connects to Local Area Network
- **USB1/USB2:** Connects to USB devices such as scanner, digital speakers, monitor, mouse, keyboard, hub, digital camera, joystick etc.

Chapter 3. BIOS Setup

This motherboard provides a programmable EEPROM that you can update the BIOS utility. The BIOS (Basic Input/Output System) is a program that deals with the basic level of communication between processor and peripherals. Use the BIOS Setup program only when installing motherboard, reconfiguring system, or prompted to “Run Setup”. This chapter explains the Setup Utility of BIOS utility.

After powering up the system, the BIOS message appears on the screen, the memory count begins, and then the following message appears on the screen:

PRESS DEL TO ENTER SETUP

If this message disappears before you respond, restart the system by pressing <Ctrl> + <Alt> + keys, or by pressing the Reset button on computer chassis. Only when it failed by these two methods can you restart the system by powering it off and then back on.

After pressing key, the main menu screen appears.

Phoenix - AwardBIOS CMOS Setup Utility	
<ul style="list-style-type: none"> ▶ µGuru Utility ▶ Standard CMOS Features ▶ Advanced BIOS Features ▶ Advanced Chipset Features ▶ Integrated Peripherals ▶ Power Management Setup 	<ul style="list-style-type: none"> ▶ PnP/PCI Configurations Load Fail-Safe Defaults Load Optimized Defaults Set Password Save & Exit Setup Exit Without Saving
Esc : Quit F10 : Save & Exit Setup F6 : Save PROFILE to BIOS	↑ ↓ → ← : Select Item (C19-W83627-6A61EALAC-00) F7 :Load PROFILE from BIOS
OC Guru & ABIT EQ	

NOTE: In order to increase system stability and performance, our engineering staffs are constantly improving the BIOS menu. *The BIOS setup screens and descriptions illustrated in this manual are for your reference only, and may not completely match with what you see on your screen.*

3-1. μ Guru™ Utility

There are two setup menus in this μ Guru utility. You may switch between these two by clicking the left or right arrow key on keyboard:

OC Guru:

μGuru Utility V0.09	
OC Guru	ABIT EQ
Brand Name: Genuine Intel(R) CPU 2.80 Ghz Frequency: 2800MHz	Item Help
Estimated New CPU Clock 2800 MHz CPU Operating Speed Auto Detect	
X - Multiplier Factor	
X - External Clock Auto	
- Current External Clock	
- Target External Clock	
X - MEM Clock Auto	
- Current MEM Clock	
- Target MEM Clock	
X - PCIE Clock	
Voltages Control Auto Detect	
X - CPU Core Voltage 1.350V	
X - DDR SDRAM Voltage 2.60V	
Power Cycle Statistics Press Enter	
↑ ↓ :Move Enter:Select +/-/PU/PD:Value F8: On The Fly F10:Save ESC:Exit	

Brand Name:

This item displays the CPU model name installed on this motherboard.

Frequency:

This item displays the processor speed of the CPU installed on this motherboard.

Estimated New CPU Clock:

This item displays an estimated CPU processor speed.

CPU Operating Speed:

This item displays the CPU operating speed according to the type and speed of your CPU. You can also select the [User Define] option to enter the manual option.

User Define:

WARNING: The wrong settings of the multiplier and external clock in certain circumstances may cause CPU damage. Setting the working frequency higher than the PCI chipset or processor specs, may cause abnormal memory module functioning, system hangs, hard disk drive data lose, abnormal functioning of the VGA card, or abnormal functioning with other add-on cards. Using non-specification settings for your CPU is not the intention of this explanation. These should be used for engineering testing, not for normal applications.

There will be no guaranty for the settings beyond specification, any damage of any component on this motherboard or peripherals result therein is not our responsibility.

*** Multiplier Factor:**

This item displays the multiplier factor for the CPU you installed.

*** External Clock:**

This item selects the external clock frequency. Due to the specification limit of the CPU you installed, the speed you set over its standard bus speed is supported, but not guaranteed.

*** MEM Clock**

This item selects the MEM clock frequency.

*** PCIE Clock**

This item selects the PCIE clock frequency.

Voltages Control:

This option allows you to switch between the default and user-defined voltages. Leave this setting to default unless the current voltage setting cannot be detected or is not correct. The option “**User Define**” enables you to select the following voltages manually.

*** CPU Core Voltage:**

This item selects the CPU core voltage.

*** DDR SDRAM Voltage:**

This item selects the voltage for DRAM slot.

Power Cycle Statistics:

Click <Enter> key to enter its submenu:

uGuru Utility V0.09		
OC Guru	ABIT EQ	
Power Cycle Statistics		Item Help
PC Up Time	0 Hours	
PC Up Time Total	71 Hours	
PC Power Cycles	77 Cycles	
PC Reset Button Cycles	45 Cycles	
AC Power On Total Time	76 Hours	
AC Power Cycles	40 Cycles	
↑ ↓ :Move Enter:Select +/-/PU/PD:Value F8: On The Fly F10:Save ESC:Exit		

These items display the power cycle statistics for each element.

ABIT EQ:

Click right-arrow <=> key to switch from OC Guru setup menu to ABIT EQ setup menu:

uGuru Utility V0.09		
OC Guru	ABIT EQ	
		Item Help
ABIT EQ Beep Control	Enabled	
Temperature Monitoring	Press Enter	
Voltage Monitoring	Press Enter	
Fan Speed Monitoring	Press Enter	
FanEQ Control	Press Enter	
↑ ↓ :Move Enter:Select +/-/PU/PD:Value F10:Save ESC:Exit		

ABIT EQ Beep Control:

This item allows you to enable or disable ABIT EQ Beep Control function.

Temperature Monitoring:

Click <Enter> key to enter its submenu:

uGuru Utility V0.09					
OC Guru	ABIT EQ				
	Temperature Monitoring				
	Reading	Shutdown Enable	Shutdown Temp.	Beep Enable	Beep Temp.
(*)CPU Temperature	51°C/123°F	(*)	85°/185°F	(*)	75°C/167°F
(*)SYS Temperature	33°C/99°F	()	65°/149°F	(*)	55°C/131°F
(*)PWM Temperature	43°C/109°F	()	90°/194°F	(*)	88°C/176°F

↑ ↓ :Move Enter:Select +/-/PU/PD:Value F10:Save ESC:Exit

CPU Temperature/System Temperature/PWM Temperature:

These items display the temperature of CPU, System, and Power Module.

*** Shutdown Enable:**

Use <Space> key to enable system shutdown function. If the CPU/System/PWM’s temperature exceeds the shutdown temperature limit, the system would shutdown automatically.

*** Shutdown Temp.:**

This items sets the temperature that would shutdown the system automatically in order to prevent system overheats.

*** Beep Enable:**

Use <Space> key to enable warning beeps function. Once the system has detected that the CPU/System/PWM’s temperature exceeded the beep temperature limit, warning beeps will sound.

*** Beep Temp.:**

This item selects the warning temperature limit.

NOTE: The shutdown temperature must be set above the warning temperature.

Voltage Monitoring:

Click <Enter> key to enter its submenu:

uGuru Utility V0.09					
OC Guru	ABIT EQ	Voltage Monitoring			
	Reading	Shutdown Beep		High	Low
		Enable	Enable	Limit	Limit
(*)CPU Core Voltage	1.550V	(*)	(*)	1.89V	1.00V
(*)DDR Voltage	2.70V	()	(*)	2.90V	2.10V
(*)DDR VTT Voltage	1.35V	()	(*)	1.55V	1.05V
(*)CPU VTT 1.2V Voltage	1.22V	()	(*)	1.45V	0.95V
(*)NB 1.4V Voltage	1.45V	()	(*)	1.70V	1.10V
(*)SB 1.5V Voltage	1.55V	()	(*)	1.80V	0.20V
(*)ATX +12V(24-Pin Connector)	11.77V	()	(*)	3.00V	9.60V
(*)ATX +12V(4-Pin Connector)	11.71V	()	(*)	14.40V	9.60V
(*)ATX +5V	5.03V	()	(*)	6.00V	4.00V
(*)ATX +3.3V	3.39V	()	(*)	3.95V	2.65V
(*)ATX 5VSB	5.06V	()	(*)	6.00V	4.00V

↑ ↓ :Move Enter:Select +/-/PU/PD:Value F10:Save ESC:Exit

All Voltages:

These items display the voltage of each element.

* Shutdown Enable:

Use <Space> key to enable system shutdown function. If the voltage of corresponding element is higher/lower than the high/low limit, the system would automatically shutdown.

* Beep Enable:

Use <Space> key to enable warning beeps function. If the voltage of corresponding element is higher/lower than the high/low limit, warning beeps will sound.

* High/Low Limit:

These items set the high and low voltage limit.

NOTE: The value of high limit must be set above the one of low limit.

Fan Speed Monitoring:

Click <Enter> key to enter its submenu:

uGuru Utility V0.09				
OC Guru	ABIT EQ			
Fan Speed Monitoring				
	Reading	Shutdown Enable	Beep Enable	Low Limit
(*)CPU FAN Speed	4020 RPM	(*)	(*)	1200 RPM
(*)NB FAN Speed	N/A	()	()	1200 RPM
()SYS FAN Speed	N/A	()	()	1200 RPM
(*)AUX1 FAN Speed	N/A	()	()	1200 RPM
(*)OTES1 FAN Speed	N/A	()	()	1200 RPM
(*)OTES2 FAN Speed	N/A	()	()	1200 RPM

↑ ↓ :Move Enter:Select +/-/PU/PD:Value F10:Save ESC:Exit

CPU/NB/SYS/AUX/OTES FAN Speed:

These items display the speed of the fans connected to CPU, NB, SYS, AUX and OTES FAN headers.

*** Shutdown Enable:**

Use <Space> key to enable system shutdown function. Once the system has detected that the fan speed is lower than the low limit value, system will shutdown automatically.

*** Beep Enable:**

Use <Space> key to enable warning beeps function. If the fan speed is lower than the low limit value, warning beeps will sound.

*** Low Limit:**

These items set the low limit of fan speed.

NOTE: Only the fans with 3-pin plugs provide the speed monitoring function.

☛ FanEQ Control:

Click <Enter> key to enter its submenu:

μGuru Utility V0.09		
OC Guru	ABIT EQ	
	FanEQ Control	
CPU FanEQ Control	Press Enter	Item Help
NB FanEQ Control	Press Enter	
SYS FanEQ Control	Press Enter	
AUX FanEQ Control	Press Enter	
OTES FanEQ Control	Press Enter	
↑ ↓ :Move Enter:Select +/-/PU/PD:Value		F10:Save ESC:Exit

Click <Enter> key to enter its submenu:

μGuru Utility V0.09		
OC Guru	ABIT EQ	
	CPU FanEQ Control	
CPU FanEQ Control	Enabled	Item Help
-Reference Temperature	CPU Temperature	
-Control Temperature High	65°C/149°F	
-Control Temperature Low	35°C/95°F	
-Fan PWM Duty Cycle High	100%	
-Fan PWM Duty Cycle Low	30%	
↑ ↓ :Move Enter:Select +/-/PU/PD:Value		F10:Save ESC:Exit

CPU FanEQ Control:

When set to [Enabled], these items control the CPU fan speed by the following setting combinations.

NOTE: Please disable the CPU FanEQ control item while running under SLI mode.

*** Reference Temperature:**

This item selects the reference point for taking temperature among the available options of CPU, SYS, and PWM Temperature, but there is only one "CPU Temperature" item to choose for the "CPU FanEQ Control".

*** Control Temperature High/Low:**

These items set the high and low temperature limit that you want to do the fan speed control.

*** Fan PWM Duty Cycle High/Low:**

These items set the high and low limit of PWM duty cycle that you want to provide the fan with.

NOTE: The value of high limit must be set above the one of low limit.

Click <Enter> key to enter its submenu:

uGuru Utility V0.09		
OC Guru	ABIT EQ	
	NB FanEQ Control	
NB FanEQ Control	Enabled	Item Help
-Reference Temperature	SYS Temperature	
-Control Temperature High	65°C/149°F	
-Control Temperature Low	35°C/95°F	
-DC Fan Voltage High	12.0V	
-DC Fan Voltage Low	8.0V	
↑ ↓ :Move Enter :Select +/-/PU/PD:Value		F10:Save ESC:Exit

Click <Enter> key to enter its submenu:

µGuru Utility V0.09		
OC Guru	ABIT EQ	
	SYS FanEQ Control	
SYS FanEQ Control	Enabled	Item Help
-Reference Temperature	SYS Temperature	
-Control Temperature High	65°C/149°F	
-Control Temperature Low	35°C/95°F	
-DC Fan Voltage High	12.0V	
-DC Fan Voltage Low	8.0V	
↑ ↓ :Move Enter:Select +/-/PU/PD:Value		F10:Save ESC:Exit

Click <Enter> key to enter its submenu:

µGuru Utility V0.09		
OC Guru	ABIT EQ	
	AUX FanEQ Control	
AUX1 FanEQ Control	Enabled	Item Help
-Reference Temperature	SYS Temperature	
-Control Temperature High	65°C/149°F	
-Control Temperature Low	35°C/95°F	
-DC Fan Voltage High	12.0V	
-DC Fan Voltage Low	8.0V	
↑ ↓ :Move Enter:Select +/-/PU/PD:Value		F10:Save ESC:Exit

Click <Enter> key to enter its submenu:

uGuru Utility V0.09		
OC Guru	ABIT EQ	
	OTES FanEQ Control	
OTES1 FanEQ Control	Enabled	Item Help
-Reference Temperature	SYS Temperature	
-Control Temperature High	45°C/113°F	
-Control Temperature Low	35°C/95°F	
-DC Fan Voltage High	12.0V	
-DC Fan Voltage Low	6.0V	
OTES2 FanEQ Control	Enabled	
-Reference Temperature	SYS Temperature	
-Control Temperature High	45°C/113°F	
-Control Temperature Low	35°C/95°F	
-DC Fan Voltage High	12.0V	
-DC Fan Voltage Low	6.0V	

↑ ↓ :Move Enter:Select +/-/PU/PD:Value F10:Save ESC:Exit

NB/SYS/AUX/OTES FanEQ Control:

When set to [Enabled], these items control the NB/SYS/AUX/OTES fan speed by the following setting combinations.

NOTE: Please disable all the FanEQ control items (NB, SYS, OTES and AUX FanEQ Control) while running under SLI mode.

*** Reference Temperature:**

This item selects the reference point for taking temperature among the available options of CPU, SYS, and PWM Temperature, but there is only one “CPU Temperature” item to choose for the “CPU FanEQ Control”.

*** Control Temperature High/Low:**

These items set the high and low temperature limit that you want to do the fan speed control.

*** DC Fan Voltage High/Low:**

These items set the high and low voltage limit that you want to provide the fan with.

NOTE: The value of high limit must be set above the one of low limit.

3-2. Standard CMOS Features

This section contains the basic configuration parameters of the BIOS. These parameters include date, hour, VGA card, FDD, and HDD settings.

Phoenix - AwardBIOS CMOS Setup Utility		
Standard CMOS Features		
		Item Help
Date (mm:dd:yy)	Mon. Jun 6 2005	
Time (hh:mm:ss)	12 : 34 : 56	
▶ IDE Channel 0 Master	None	
▶ IDE Channel 0 Slave	None	
▶ IDE Channel 1 Master	None	
▶ IDE Channel 1 Slave	None	
▶ IDE Channel 2 Master	None	
▶ IDE Channel 3 Master	None	
▶ IDE Channel 4 Master	None	
▶ IDE Channel 5 Master	None	
Drive A	1.44M, 3.5 in.	
Halt On	All, But keyboard	
Base Memory	640K	
Extended Memory	1046520K	
Total Memory	1047552K	
↑ ↓ : Move Enter : Select +/- /PU/PD : Value F10 : Save ESC : Exit F1 : General Help F5 : Previous Values F6 : Fail-Safe Defaults F7 : Optimized Defaults		

Date (mm:dd:yy):

This item sets the date you specify (usually the current date) in the format of [Month], [Date], and [Year].

Time (hh:mm:ss):

This item sets the time you specify (usually the current time) in the format of [Hour], [Minute], and [Second].

☛ IDE Channel 0 Master/Slave, IDE Channel 1 Master/Slave, IDE Channel 2 Master/Slave, IDE Channel 3 Master/Slave:

Click <Enter> key to enter its submenu:

Phoenix - AwardBIOS CMOS Setup Utility		
IDE Channel 0 Master		
IDE HDD Auto-Detection	Press Enter	Item Help
IDE Channel 0 Master	Auto	
Access Mode	Auto	
Capacity	0 MB	
Cylinder	0	
Head	0	
Precomp	0	
Landing Zone	0	
Sector	0	

↑ ↓ : Move Enter : Select +/- /PU/PD : Value F10 : Save ESC : Exit F1 : General Help
 F5 : Previous Values F6 : Fail-Safe Defaults F7 : Optimized Defaults

IDE HDD Auto-Detection:

This item allows you to detect the parameters of IDE drives by pressing <Enter> key. The parameters will be shown on the screen automatically.

IDE Channel 0 Master/Slave, IDE Channel 1 Master/Slave, Extended IDE Drive:

When set to [Auto], the BIOS will automatically check what kind of IDE drive you are using. If you want to define your own drive by yourself, set it to [Manual] and make sure you fully understand the meaning of the parameters. Please refer to the instruction manual provided by the device's manufacturer to get the setting right.

Access Mode:

This item selects the mode to access your IDE devices. Leave this item to its default [Auto] setting to detect the access mode of your HDD automatically.

Capacity:

This item displays the approximate capacity of the disk drive. Usually the size is slightly greater than the size of a formatted disk given by a disk-checking program.

Cylinder:

This item configures the numbers of cylinders.

Head:

This item configures the numbers of read/write heads.

Precomp:

This item displays the number of cylinders at which to change the write timing.

Landing Zone:

This item displays the number of cylinders specified as the landing zone for the read/write heads.

Sector:

This item configures the numbers of sectors per track.

↶ Back to Standard CMOS Features Setup Menu:

Drive A:

This item sets the type of floppy drives (usually only Drive A) installed.

Halt On:

This item determines whether the system stops if an error is detected during system boot-up.

[All Errors]: The system-boot will stop whenever the BIOS detect a non-fatal error.

[No Errors]: The system-boot will not stop for any error detected.

[All, But Keyboard]: The system-boot will stop for all errors except a keyboard error.

[All, But Diskette]: The system-boot will stop for all errors except a diskette error.

[All, But Disk/Key]: The system-boot will stop for all errors except a diskette or keyboard error.

Base Memory:

This item displays the amount of base memory installed in the system. The value of the base memory is typically 640K for system with 640K or more memory size installed on the motherboard.

Extended Memory:

This item displays the amount of extended memory detected during system boot-up.

Total Memory:

This item displays the total memory available in the system.

3-3. Advanced BIOS Features

Phoenix - AwardBIOS CMOS Setup Utility Advanced BIOS Features		
		Item Help
▶ CPU Feature	Press Enter	
Hyper-Threading Technology	Enabled	
Quick Power On Self Test	Enabled	
▶ Hard Disk Boot Priority	Press Enter	
First Boot Device	Removable	
Second Boot Device	CD-ROM	
Third Boot Device	Hard Disk	
Boot Other Device	Enabled	
Boot Up Floppy Seek	Disabled	
Boot Up NumLock Status	On	
Security Option	Setup	
MPS Version Control For OS	1.4	
Delay For HDD (Secs)	0	
Full Screen Logo Show	Disabled	
↑ ↓ : Move Enter : Select +/- /PU/PD : Value F10 : Save ESC : Exit F1 : General Help F5 : Previous Values F6 : Fail-Safe Defaults F7 : Optimized Defaults		

↳ CPU Feature:

Click <Enter> key to enter its submenu:

Phoenix - AwardBIOS CMOS Setup Utility CPU Feature		
		Item Help
Thermal Management	Thermal Monitor1	
Limit CPUID MaxVal	Disabled	
C1E Function	Enabled	
Execute Disable Bit	Enabled	
↑ ↓ : Move Enter : Select +/- /PU/PD : Value F10 : Save ESC : Exit F1 : General Help F5 : Previous Values F6 : Fail-Safe Defaults F7 : Optimized Defaults		

Thermal Management

This item selects the type of thermal monitoring.

Limit CPUID MaxVal

When set to [Enabled], this item limits the CPUID maximum value to 3, which is usually required for older OS like Windows NT4.0.

Leave this item to its default [Disabled] settings for OS like Windows XP.

C1E Function

This item appears only for certain processors with the C1E (Enhanced Halt State) Function. When set to [Enabled], the processor will further reduce the total power consumption.

Execute Disable Bit

This item appears only for certain processors with the Execute Disable Bit (XD bit) feature. When set to [Enabled], this item allows the processor to prevent data pages from being used by malicious software to execute code and provide memory protection.

 **Back to Advanced BIOS Features Setup Menu:**

Hyper-Threading Technology

This item is used to enable the functionality of the processor with Hyper-Threading Technology and will appear only when using such processor.

The Hyper-Threading Technology helps your PC work more efficiently by maximizing processor resources and enabling a single processor to run two separate threads of software simultaneously, bringing forth greater performance and system responsiveness when running multiple applications at once.

Quick Power On Self Test:

When set to [Enabled], this item speeds up the Power On Self Test (POST) after powering on the system. The BIOS shorten or skip some check during the POST.

Hard Disk Boot Priority:

This item selects the hard disks booting priority. By pressing <Enter> key, you can enter its submenu where the hard disks detected can be selected for the booting sequence to boot up system.

This item functions only when there is the option of [Hard Disk] in any one of the First/Second/Third Boot Device items.

First Boot Device / Second Boot Device / Third Boot Device / Boot Other Device:

Select the drive to boot first, second and third in the [First Boot Device], [Second Boot Device], and [Third Boot Device] items respectively. The BIOS will boot the operating system according to the sequence of the drive selected. Set [Boot Other Device] to [Enabled] if you wish to boot from another device other than these three items.

NOTE: To enable the onboard LAN Boot function, the item "LAN Boot ROM" in the " OnChip PCI Device" menu must be set to [Enable], and then the drive "Nvidia Boot Age" in this "Boot Device" menu must be selected.

Boot Up Floppy Seek:

When set to [Enabled], the BIOS will check whether the floppy disk drive is installed or not.

Boot Up NumLock Status:

This item determines the default state of the numeric keypad at system booting up.

[On]: The numeric keypad functions as number keys.

[Off]: The numeric keypad functions as arrow keys.

Security Option:

This item determines when the system will prompt for password - every time the system boots or only when enters the BIOS setup.

[Setup]: The password is required only when accessing the BIOS Setup.

[System]: The password is required each time the computer boots up.

NOTE: Don't forget your password. If you forget the password, you will have to open the computer case and clear all information in the CMOS before you can start up the system. But by doing this, you will have to reset all previously set options.

MPS Version Control For OS:

This item specifies which version of MPS (Multi-Processor Specification) this motherboard will use. Leave this item to its default setting.

Delay For HDD (Secs):

This item allows the BIOS to support some old or special IDE devices by prolonging this delay time. A larger value will give more delay time to the device for which to initialize and to prepare for activation.

Full Screen LOGO Show:

This item determines to show the full screen logo when booting.

3-4. Advanced Chipset Features

Phoenix - AwardBIOS CMOS Setup Utility Advanced Chipset Features		
Memory Timings	Optimal	Item Help
Current CAS-RCD-RP-RAS-RC	4-4-4-11-15 (1T)	
Target CAS-RCD-RP-RAS-RC	4-4-4-11-15 (1T)	
X T (LAS)	Auto	
X T (RCD)	Auto	
X T (RP)	Auto	
X T (RAS)	Auto	
X T (RC)	Auto	
X Addressing Mode	Auto	
SLI Broadcast Aperture	Auto	
LDT Frequency	4X	
↑ ↓ : Move Enter : Select +/- /PU/PD : Value F10 : Save ESC : Exit F1 : General Help F5 : Previous Values F6 : Fail-Safe Defaults F7 : Optimized Defaults		

Memory Timings

Two options are available: Optimal → Expert. The default setting is *Optimal*. Choose *Optimal* for better memory compatibility; choose *Expert* for user-define.

SLI Broadcast Aperture

This item allows you to enable or disable the SLI Broadcast Aperture function.

LDT Frequency

Six options are available: 1X → 2X → 3X → 4X → 5X → 3.5X. The default setting is 4X.

3-5. Integrated Peripherals

Phoenix - AwardBIOS CMOS Setup Utility		
Integrated Peripherals		
		Item Help
▶ OnChip IDE Device	Press Enter	
▶ OnChip PCI Device	Press Enter	
▶ OnBoard PCI Device	Press Enter	
Onboard FDC Controller	Enabled	

↑ ↓ :Move Enter:Select +/-/PU/PD:Value F10:Save ESC:Exit F1:General Help
 F5: Previous Values F6: Fail-Safe Defaults F7: Optimized Defaults

📁 OnChip IDE Device:

Click <Enter> key to enter its submenu:

Phoenix - AwardBIOS CMOS Setup Utility		
Onchip IDE Device		
		Item Help
RAID Config	Press Enter	
OnChip IDE-1 Controller	Enabled	
OnChip IDE-2 Controller	Enabled	
IDE Bus Master	Enabled	
Serial-ATA 1/2	Enabled	
Serial-ATA 3/4	Enabled	

↑ ↓ :Move Enter:Select +/-/PU/PD:Value F10:Save ESC:Exit F1:General Help
 F5: Previous Values F6: Fail-Safe Defaults F7: Optimized Defaults

RAID Config:

Click <Enter> key to enter its submenu:

Phoenix - AwardBIOS CMOS Setup Utility		
RAID Config		
		Item Help
- RAID Enable	Enabled	
X - IDE1 Master RAID	Disabled	
X - IDE1 Slave RAID	Disabled	
X - IDE2 Master RAID	Disabled	
X - IDE2 Slave RAID	Disabled	
X - Serial-ATA 1 RAID	Disabled	
X - Serial-ATA 2 RAID	Disabled	
X - Serial-ATA 3 RAID	Disabled	
X - Serial-ATA 4 RAID	Disabled	

↑ ↓ : Move Enter : Select +/- /PU/PD : Value F10 : Save ESC : Exit F1 : General Help
 F5 : Previous Values F6 : Fail-Safe Defaults F7 : Optimized Defaults

RAID Enable:

This item allows you to enable or disable the IDE RAID function.

*** IDE1/2 Master/Slave RAID, Serial-ATA 1/2 RAID:**

Select the disks that you want to use as RAID disks.

OnChip IDE-1 Controller:

This item selects whether to enable or disable the IDE-1 controller.

OnChip IDE-2 Controller:

This item selects whether to enable or disable the IDE-2 controller.

IDE Bus Master:

This option enables or disables the IDE bus mastering capability under the DOS environment.

Serial ATA 1/2

Select the disks that you want to use as RAID disks.

Serial ATA 3/4

Select the disks that you want to use as RAID disks.

OnChip PCI Device:

Click <Enter> key to enter its submenu:

Phoenix - AwardBIOS CMOS Setup Utility		
OnChip PCI Device		
Item	Value	Item Help
OnChip USB	V1.1+V2.0	
- USB Keyboard Support Via	OS	
OnChip Audio Controller	Auto	
OnChip Lan Controller	Auto	
LAN Boot ROM	Enabled	

↑ ↓ : Move Enter : Select +/- /PU/PD : Value F10 : Save ESC : Exit F1 : General Help
 F5 : Previous Values F6 : Fail-Safe Defaults F7 : Optimized Defaults

OnChip USB:

This option enables or disables the USB controller.

*** USB Keyboard Support Via:**

This item allows you to select [BIOS] for using USB keyboard in DOS environment, or [OS] in OS environment.

OnChip Audio Controller:

This option enables or disables the audio controller.

OnChip Lan Controller:

This option enables or disables the lan controller.

LAN Boot ROM

This item allows you to use the boot ROM (instead of a disk drive) to boot-up the system and access the local area network directly.

OnBoard PCI Device:

Click <Enter> key to enter its submenu:

Phoenix - AwardBIOS CMOS Setup Utility		
OnBoard PCI Device		
OnBoard SATA Controller	Enabled	Item Help
- SATA Mode	IDE	
↑ ↓ : Move Enter : Select +/- / PU / PD : Value F10 : Save ESC : Exit F1 : General Help F5 : Previous Values F6 : Fail-Safe Defaults F7 : Optimized Defaults		

OnBoard SATA Controller

This option enables or disables the SATA controller.

* SATA Mode

This item determines the mode for SATA.

[IDE]: The onboard SATA served as IDE Mode.

[RAID]: The onboard SATA served as RAID Mode.

Back to Integrated Peripherals Setup Menu:

Onboard FDC Controller:

Two options are available: Enabled and Disabled. The default setting is *Enabled*. You can enable or disable the onboard FDC controller.

:

3-6. Power Management Setup

Phoenix - AwardBIOS CMOS Setup Utility Power Management Setup		
ACPI Suspend Type	S3(Suspend-to-RAM	Item Help
Resume by USB From S3	Disabled	
Power Button Function	Instant-Off	
Wake-Up by PME# of PCI	Disabled	
Resume by Ring	Disabled	
Power-On by Alarm	Disabled	
X - Date of Month Alarm	0	
X - Time (hh:mm:ss) Alarm	0 : 0 : 0	
POWER ON Function	BUTTON ONLY	
X - KB Power ON Password	Enter	
X - Hot Key Power ON	Ctrl-F1	
Restore on AC Power Loss	Power Off	
↑ ↓ : Move Enter: Select +/-/PU/PD: Value F10: Save ESC: Exit F1: General Help F5: Previous Values F6: Fail-Safe Defaults F7: Optimized Defaults		

ACPI Suspend Type:

This item selects the type of Suspend mode.

[S1(PowerOn-Suspend)]: Enables the Power On Suspend function.

[S3(Suspend-To-RAM)]: Enables the Suspend to RAM function.

Resume by USB From S3:

When set to [Enabled], this item allows you to use a USB device to wake up a system that is in the S3 (STR - Suspend To RAM) state. This item can be configured only if the item “ACPI Suspend Type” is set to [S3(STR)].

NOTE: To enable this “Resume by USB From S3” function, the wake-up header of [USB-PWR1], [USB-PWR2], [USB-PWR3], [USB-PWR4] and [USB-PWR5] must be set to [Enabled] position. Please refer to the configuration of “Wake-up Header” in section 2-4, chapter 2.

Power Button Function:

This item selects the method of powering off your system:

[Delay 4 Sec.]: Pushing the power button for more than 4 seconds will power off the system. This will prevent the system from powering off in case you accidentally hit or pushed the power button.

[Instant-Off]: Pressing and then releasing the power button at once will immediately power off the system.

WakeUp by PME# of PCI:

When set to [Enabled], access to the onboard LAN or a PCI card such as a modem or LAN card will cause the system to wake up. The PCI card must support the wake up function.

Resume by Ring:

Two options are available: Disabled or Enabled. The default setting is *Disabled*. When set to *Enabled*, any event affecting from Modem Ring will awaken a system that has powered down.

Power-On by Alarm:

When set to [Enabled], you can set the date and time you would like the Soft-Off PC to power-on in the “**Date (of Month) Alarm**” and “**Time (hh:mm:ss) Alarm**” items. However, if the system is being accessed by incoming calls or the network (Resume On Ring/LAN) prior to the date and time set in these items, the system will give priority to the incoming calls or network instead.

*** Date (of Month) Alarm**

[0]: This option power-on the system everyday according to the time set in the “Time (hh:mm:ss) Alarm” item.

[1-31]: This option selects a date you would like the system to power-on. The system will power-on on the date set, and the time set in the “Time (hh:mm:ss) Alarm” item.

*** Time (hh:mm:ss) Alarm**

This item sets the time you would like the system to power-on.

Power ON Function

This item selects the way you want your system to power on.

[**Password**]: Use a password to power on the system, select this option then press <Enter>. Enter your password. You can enter up to 5 characters. Type in exactly the same password to confirm, and then press <Enter>.

[**Hot KEY**]: Use any of the function keys between <F1> to <F12> to power on the system.

[**Mouse Left**]: Double click the mouse left button to power on the system.

[**Mouse Right**]: Double click the mouse right button to power on the system.

[**Any KEY**]: Use any keyboard keys to power on the system.

[**BUTTON Only**]: Use only the power button to power on the system.

[**Keyboard 98**]: Use the power-on button on the “Keyboard 98” compatible keyboard to power on the system.

NOTE: To enable this “Power On” function, the wake-up header of [USB-PWR1], [USB-PWR2], [USB-PWR3], [USB-PWR4] and [USB-PWR5] must be set to [Enabled] position. Please refer to the configuration of “Wake-up Header” in section 2-4, chapter 2.

NOTE: The mouse wake up function can only be used with the PS/2 mouse, not with the COM port or USB type. Some PS/2 mice cannot wake up the system because of compatible problems. If the specs of your keyboard are too old, it may fail to power on.

*** KB Power ON Password:**

This item sets the password required in order to power on your computer.

NOTE: Do not forget your password, or you will have to clear the CMOS and reset all parameters in order to utilize this function again.

*** Hot Key Power ON:**

This item powers on the system by pressing <Ctrl> key plus one of each function key (<F1> ~ <F12>) simultaneously.

Restore On AC Power Loss:

This item selects the system action after an AC power failure.

[Power Off]: When power returns after an AC power failure, the system's power remains off. You must press the Power button to power-on the system.

[Power On]: When power returns after an AC power failure, the system's power will be powered on automatically.

[Last State]: When power returns after an AC power failure, the system will return to the state where you left off before power failure occurs. If the system's power is off when AC power failure occurs, it will remain off when power returns. If the system's power is on when AC power failure occurs, the system will power-on when power returns.

3-7. PnP/PCI Configurations

Phoenix - AwardBIOS CMOS Setup Utility PnP/PCI Configurations		
Init Display First	PCI Slot	Item Help
Resources Controlled By	Auto (ESCD)	
x IRQ Resources	Press Enter	
PCI/VGA Pallette Snoop	Disbaled	
** PCI Express relative items **		
Maximum Payload Size	4096	
↑ ↓ : Move Enter : Select +/- / PU / PD : Value F10 : Save ESC : Exit F1 : General Help F5 : Previous Values F6 : Fail-Safe Defaults F7 : Optimized Defaults		

Init Display First

This item selects which display slot to be initialized first when the system boots.

[PCI Slot]: When the system boots, it will first initialize PCI.

[PCIEx]: When the system boots, it will first initialize PCIE.

Resources Controlled By:

This item configures all of the boot and Plug-and-Play compatible devices.

[Auto(ESCD)]: The system will automatically detect the settings.

[Manual]: Choose the specific IRQ resources in the "IRQ Resources" menu.

*** IRQ Resources:**

Click <Enter> key to enter its submenu:

This item sets each system interrupt to either [PCI Device] or [Reserved].

Phoenix - AwardBIOS CMOS Setup Utility	
PnP/PCI Configurations	
IRQ-4 assigned to	PCI Device
IRQ-5 assigned to	PCI Device
IRQ-7 assigned to	PCI Device
IRQ-10 assigned to	PCI Device
IRQ-11 assigned to	PCI Device
IRQ-12 assigned to	PCI Device
↑ ↓ : Move Enter: Select +/- /PU/PD: Value F10: Save ESC: Exit F1: General Help F5: Previous Values F6: Fail-Safe Defaults F7: Optimized Defaults	

PCI/VGA Palette Snoop:

This item determines whether the MPEG ISA/VESA VGA cards can work with PCI/VGA or not.

[Enabled]: MPEG ISA/VESA VGA cards work with PCI/VGA.

[Disabled]: MPEG ISA/VESA VGA cards do not work with PCI/VGA.

Maximum Payload Size

This item sets the maximum TLP payload size for the PCI Express devices.

3-8. Load Fail-Safe Defaults

This option loads the BIOS default values for the most stable, minimal-performance system operations.

3-9. Load Optimized Defaults

This option loads the BIOS default values that are factory settings for optimal-performance system operations.

3-10. Set Password

This option protects the BIOS configuration or restricts access to the computer itself.

3-11. Save & Exit Setup

This option saves your selections and exits the BIOS setup menu.

3-12. Exit Without Saving

This option exits the BIOS setup menu without saving any changes.

Appendix A. Install nVidia nForce Chipset Driver

NOTE: Please install this NVIDIA nForce Chipset driver first after having installed the Windows operating system. The drivers packed in the “Driver & Utility CD” are available for Windows 2000 and Windows XP only.

The installation procedures and screen shots in this section are based on Windows XP operating system. For those of other OS, please follow its on-screen instructions.

Insert the Driver & Utility CD into CD-ROM drive. It should execute the installation program automatically. If not, double-click the execution file at the main directory of this CD to enter the installation menu.

After entering the installation menu, move your cursor to [Drivers] tab. Click [nVidia nForce Chipset Driver]. The following screen appears.

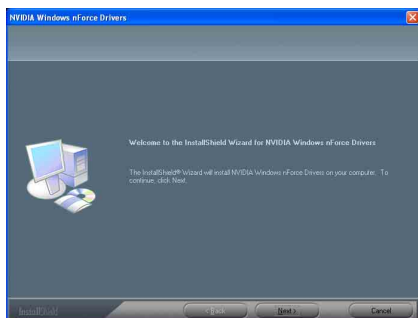

1. Click [Next].

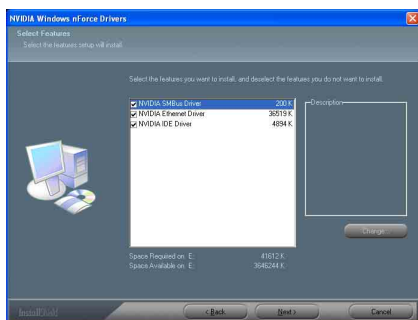

2. Click [Next].

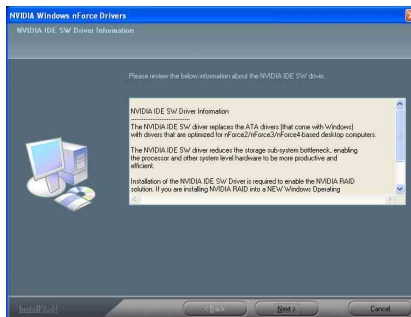

3. Click [Next].

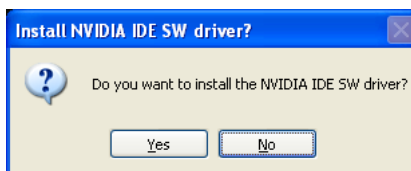

4. Click [Yes].

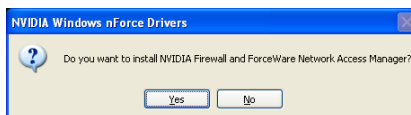

5. Click [Yes].

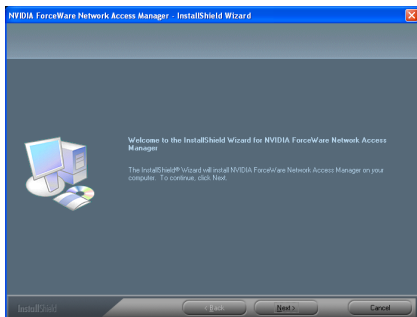

6. Click [Next].

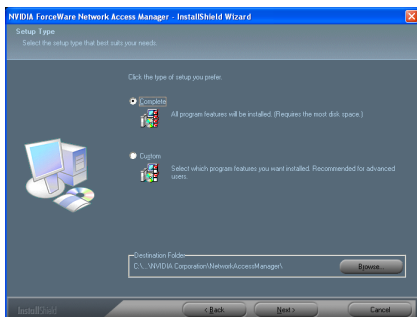

7. Click [Next].

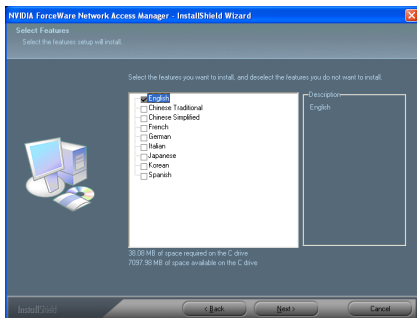

8. Click [Next].

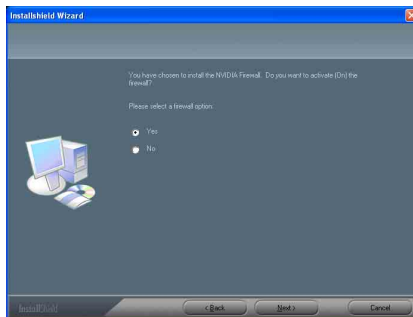

9. Click [Next].

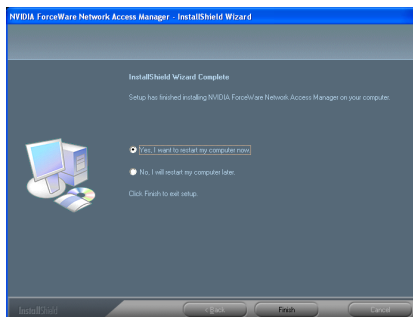

10. Choose [Yes, I want to restart my computer now.], and click [Finish] to complete setup.

Appendix B. Install Realtek Audio Driver

The installation procedures and screen shots in this section are based on Windows XP operating system. For those of other OS, please follow its on-screen instruction.

Insert the Driver & Utility CD into CD-ROM drive, it should execute the installation program automatically. If not, double-click the execution file at the main directory of this CD to enter the installation menu.

After entering the installation menu, move your cursor to [Drivers] tab. Click [Realtek Audio Driver]. The following screen appears.

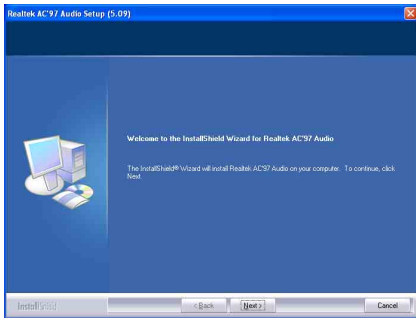

1. Click [Next].

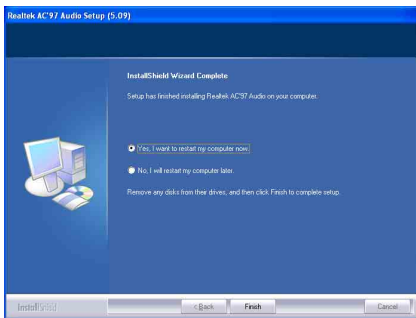

2. Choose [Yes, I want to restart my computer now.], and click [Finish] to complete setup.

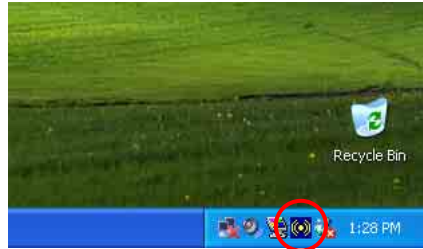

3. After the system restarted, a shortcut icon appears at the right corner of Windows task bar.



4. Double click the icon and the [AUDIO EQ] control panel will appear.

NOTE: Click the [SPDIF] tab on the top of the control panel, and the page allows you to control the settings for the Digital Audio input and output. There are four S/PDIF-Out options provided.



- **[No Output]**

S/PDIF-Out function is disabled and there will be no output signals.

- **[Output digital only]**

The output signal will be transferred from the real-time played digital audio format (ex: mp3, wav) only.

- **[Output digital and analog]**

The signal will be output via the digital audio signal and the analog signal from any audio connectors (ex: CD-in) simultaneously.

Enable [Real-time S/PDIF-In Monitor] option under this mode, the signals from S/PDIF-In will be real-time transmitted with other signals.

- **[S/PDIF-In to S/PDIF-Out pass through mode]**

The pass through mode allows the incoming signal from S/PDIF-In port transmitted directly to S/PDIF-Out port.

Appendix C. Install Silicon Image 3132 SATA Driver

The installation procedures and screen shots in this section are based on Windows XP operating system. For those of other OS, please follow its on-screen instructions.

Insert the Driver & Utility CD into CD-ROM drive. It should execute the installation program automatically. If not, double-click the execution file at the main directory of this CD to enter the installation menu.

After entering the installation menu, move your cursor to [Drivers] tab. Click [Silicon Image 3132 SATA Driver]. The following screen appears.

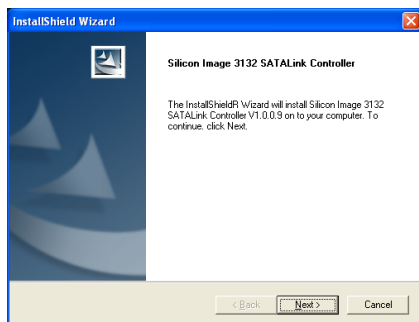

1. Click [Next].

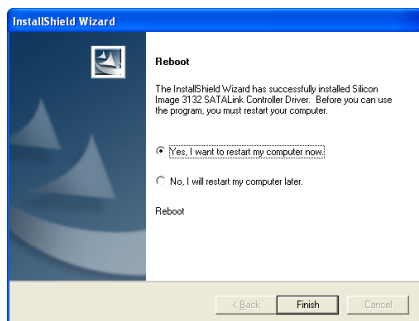

2. Choose [Yes, I want to restart my computer now.], and click [Finish] to complete setup.



Appendix D. Install Silicon Image 3132 RAID Driver

The installation procedures and screen shots in this section are based on Windows XP operating system. For those of other OS, please follow its on-screen instructions.

Insert the Driver & Utility CD into CD-ROM drive. It should execute the installation program automatically. If not, double-click the execution file at the main directory of this CD to enter the installation menu.

After entering the installation menu, move your cursor to [Drivers] tab. Click [Silicon Image 3132 RAID Driver]. The following screen appears.

NOTE: To install this program, you have to enable the item “RAID” first in the BIOS menu of “SATA Mode”.

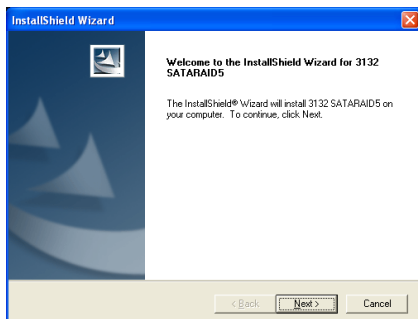

1. Click [Next].

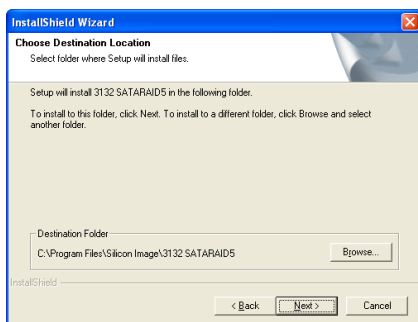

2. Click [Next].

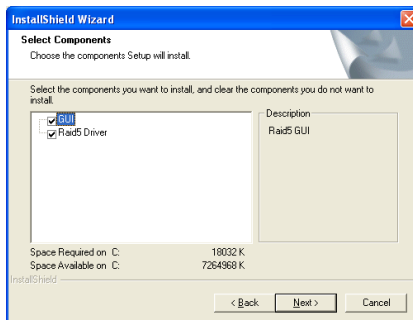

3. Click [Next].

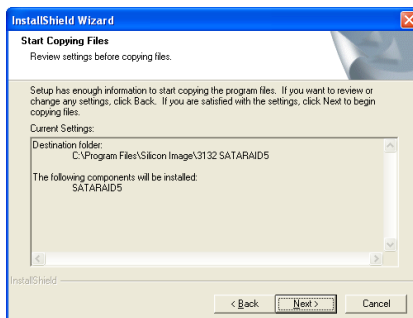

4. Click [Next].

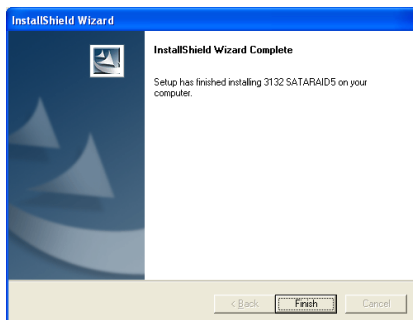

5. Click [Finish].

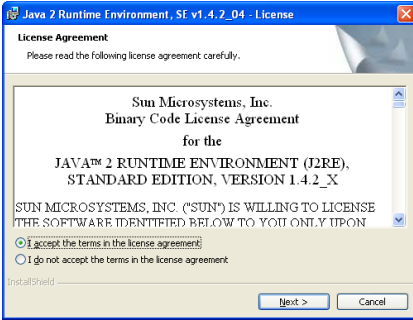

6. Check the item "I accept the license agreement". Click [Next] to go on next step.

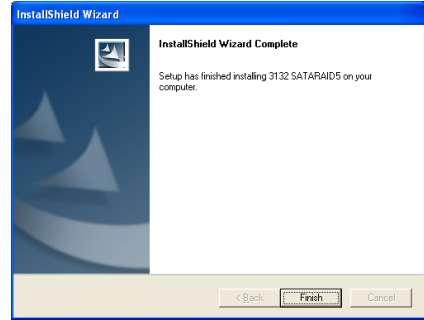

9. Click [Finish].

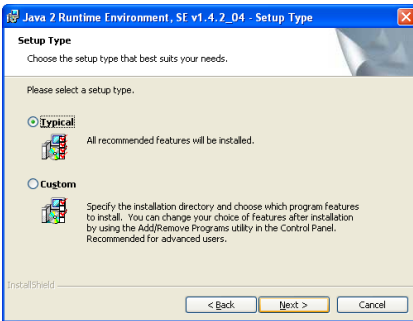

7. Click [Next].

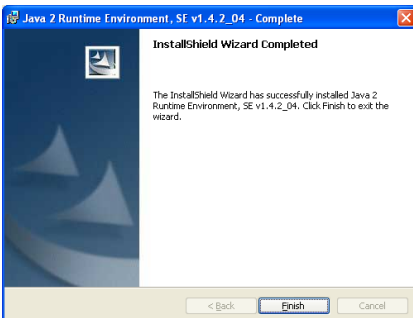

8. Click [Finish].

Appendix E. Install USB 2.0 Driver

NOTE: To install the USB 2.0 Driver for Windows XP / Windows 2000, you have to download the latest SP1 (service pack 1) / SP4 (service pack 4) or later version first from Microsoft's web site.



Appendix F. Install uGuru Utility

The installation procedures and screen shots in this section are based on Windows XP operating system. For those of other OS, please follow its on-screen instruction.

Insert the Driver & Utility CD into CD-ROM drive, it should execute the installation program automatically. If not, double-click the execution file at the main directory of this CD to enter the installation menu.

After entering the installation menu, move your cursor to [Abit Utility] tab. Click [uGuru Utility]. The following screen appears.

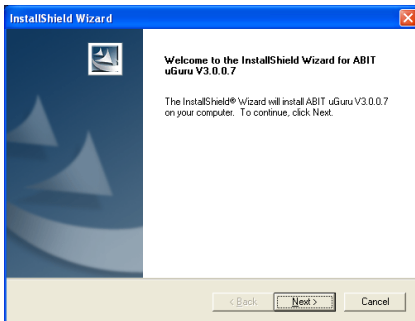

1. Click [Next].

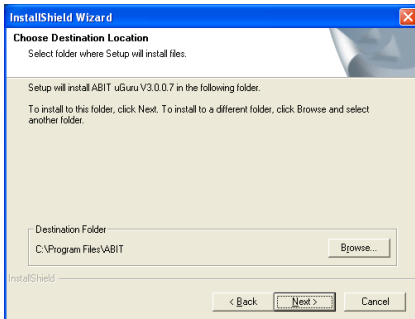

2. Click [Next].

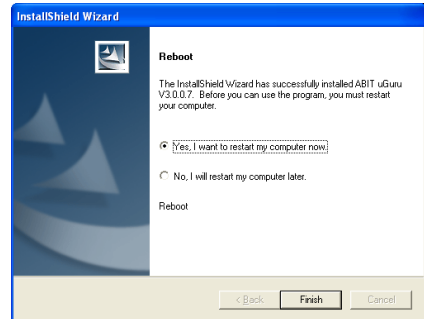

3. Choose [Yes, I want to restart my computer now.], and click [Finish] to complete setup.



Appendix G. Generate NVRAid Floppy Disk

NOTE: If you lost or damaged the SATA Driver Disk that came with the package, use the NVRAid Floppy Disk to create another one.

The installation procedures and screen shots in this section are based on Windows XP operating system. For those of other OS, please follow its on-screen instruction.

Insert the Driver & Utility CD into CD-ROM drive, it should execute the installation program automatically. If not, double-click the execution file at the main directory of this CD to enter the installation menu.

After entering the installation menu, move your cursor to [Abit Utility] tab. Click [Generate NVRAid Floppy Disk]. The following screen appears.

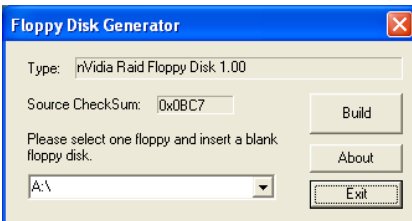

1. Insert one blank floppy disk to the selected floppy drive and click [Build].

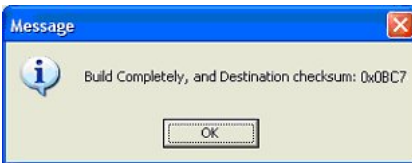

2. Click [OK] to finish building the SATA Raid Driver Disk.



Appendix H. Generate SIL3132Raid Floppy Disk

NOTE: If you lost or damaged the SATA Driver Disk that came with the package, use the SIL3132Raid Floppy Disk to create another one.

The installation procedures and screen shots in this section are based on Windows XP operating system. For those of other OS, please follow its on-screen instruction.

Insert the Driver & Utility CD into CD-ROM drive, it should execute the installation program automatically. If not, double-click the execution file at the main directory of this CD to enter the installation menu.

After entering the installation menu, move your cursor to [Abit Utility] tab. Click [Generate SIL3132Raid Floppy Disk]. The following screen appears.

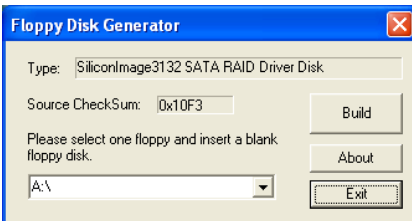

1. Insert one blank floppy disk to the selected floppy drive and click [Build].

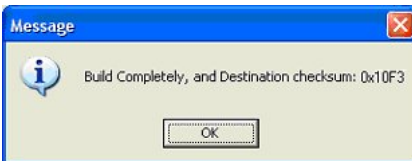

2. Click [OK] to finish building the SATA Raid Driver Disk.



Appendix I. POST Code Definition

AWARD POST Code Definitions

POST (hex)	Description
CF	Test CMOS R/W functionality
C0	Early chipset initialization: -Disable shadow RAM -Disable L2 cache (socket 7 or below) -Program basic chipset registers
C1	Detect memory -Auto-detection of DRAM size, type and ECC -Auto-detection of L2 cache (socket 7 or below)
C3	Expand compressed BIOS code to DRAM
C5	Call chipset hook to copy BIOS back to E000 & F000 shadow RAM
01	Expand the Xgroup codes locating in physical address 1000:0
03	Initial Superio_Early_Init switch
05	1. Blank out screen 2. Clear CMOS error flag
07	1. Clear 8042 interface 2. Initialize 8042 self-test
08	1. Test special keyboard controller for Winbond 977 series Super I/O chips 2. Enable keyboard interface
0A	1. Disable PS/2 mouse interface (optional) 2. Auto detect ports for keyboard & mouse followed by a port & interface swap (optional) 3. Reset keyboard for Winbond 977 series Super I/O chips
0E	Test F000h segment shadow to see whether it is R/W-able or not. If test fails, keep beeping the speaker
10	Auto detect flash type to load appropriate flash R/W codes into the run time area in F000 for ESCD & DMI support
12	Use walking 1's algorithm to check out interface in CMOS circuitry. Also set real-time clock power status, and then check for override
14	Program chipset default values into chipset. Chipset default values are MODBINable by OEM customers
16	Initial onboard clock generator if Early_Init_Onboard_Generator is defined. See also POST 26.
18	Detect CPU information including brand, SMI type (Cyrix or Intel) and CPU level (586 or 686)
1B	Initial interrupts vector table. If no special specified, all H/W interrupts are directed to SPURIOUS_INT_HDLR & S/W interrupts to SPURIOUS_soft_HDLR.
1D	Initial EARLY_PM_INIT switch

1F	Load keyboard matrix (notebook platform)
21	HPM initialization (notebook platform)
23	<ol style="list-style-type: none"> 1. Check validity of RTC value: e.g. a value of 5Ah is an invalid value for RTC minute. 2. Load CMOS settings into BIOS stack. If CMOS checksum fails, use default value instead.
24	Prepare BIOS resource map for PCI & PnP use. If ESCD is valid, take into consideration of the ESCD's legacy information.
25	<p>Early PCI Initialization:</p> <ul style="list-style-type: none"> -Enumerate PCI bus number. -Assign memory & I/O resource -Search for a valid VGA device & VGA BIOS, and put it into C000:0
26	<ol style="list-style-type: none"> 1. If Early_Init_Onboard_Generator is not defined Onboard clock generator initialization. Disable respective clock resource to empty PCI & DIMM slots. 2. Init onboard PWM 3. Init onboard H/W monitor devices
27	Initialize INT 09 buffer
29	<ol style="list-style-type: none"> 1. Program CPU internal MTRR (P6 & PII) for 0-640K memory address. 2. Initialize the APIC for Pentium class CPU. 3. Program early chipset according to CMOS setup. Example: onboard IDE controller. 4. Measure CPU speed.
2B	Invoke Video BIOS
2D	<ol style="list-style-type: none"> 1. Initialize double-byte language font (Optional) 2. Put information on screen display, including Award title, CPU type, CPU speed, full screen logo.
33	Reset keyboard if Early_Reset_KB is defined e.g. Winbond 977 series Super I/O chips. See also POST 63.
35	Test DMA Channel 0
37	Test DMA Channel 1.
39	Test DMA page registers.
3C	Test 8254
3E	Test 8259 interrupt mask bits for channel 1
40	Test 8259 interrupt mask bits for channel 2
43	Test 8259 functionality
47	Initialize EISA slot
49	<ol style="list-style-type: none"> 1. Calculate total memory by testing the last double word of each 64K page 2. Program writes allocation for AMD K5 CPU
4E	<ol style="list-style-type: none"> 1. Program MTRR of M1 CPU 2. Initialize L2 cache for P6 class CPU & program CPU with proper cacheable range 3. Initialize the APIC for P6 class CPU 4. On MP platform, adjust the cacheable range to smaller one in case the cacheable ranges between each CPU are not identical
50	Initialize USB
52	Test all memory (clear all extended memory to 0)
53	Clear password according to H/W jumper (Optional)

55	Display number of processors (multi-processor platform)
57	Display PnP logo Early ISA PnP initialization -Assign CSN to every ISA PnP device
59	Initialize the combined Trend Anti-Virus code
5B	(Optional Feature) Show message for entering AWDFLASH.EXE from FDD (optional)
5D	1. Initialize Init_Onboard_Super_IO 2. Initialize Init_Onboard_AUDIO
60	Okay to enter Setup utility; i.e. not until this POST stage can users enter the CMOS setup utility
63	Reset keyboard if Early_Reset_KB is not defined
65	Initialize PS/2 Mouse
67	Prepare memory size information for function call: INT 15h ax=E820h
69	Turn on L2 cache
6B	Program chipset registers according to items described in Setup & Auto-configuration table
6D	1. Assign resources to all ISA PnP devices 2. Auto assign ports to onboard COM ports if the corresponding item in Setup is set to "AUTO"
6F	1. Initialize floppy controller 2. Set up floppy related fields in 40:hardware
75	Detect & install all IDE devices: HDD, LS120, ZIP, CDROM ...
76	(Optional Feature) Enter AWDFLASH.EXE if: -AWDFLASH is found in floppy drive -ALT+F2 is pressed
77	Detect serial ports & parallel ports.
7A	Detect & install co-processor
7C	Init HDD write protect
7F	Switch back to text mode if full screen logo is supported -If errors occur, report errors & wait for keys -If no errors occur or F1 key is pressed to continue: Clear EPA or customization logo
E8POST.ASM starts	
82	1. Call chipset power management hook 2. Recover the text font used by EPA logo (not for full screen logo) 3. If password is set, ask for password
83	Save all data in stack back to CMOS
84	Initialize ISA PnP boot devices
85	1. USB final Initialization 2. Switch screen back to text mode
87	NET PC: Build SYSID Structure
89	1. Assign IRQs to PCI devices 2. Set up ACPI table at top of the memory.

8B	<ol style="list-style-type: none"> 1. Invoke all ISA adapter ROMs 2. Invoke all PCI ROMs (except VGA)
8D	<ol style="list-style-type: none"> 1. Enable/Disable Parity Check according to CMOS setup 2. APM Initialization
8F	Clear noise of IRQs
93	Read HDD boot sector information for Trend Anti-Virus code
94	<ol style="list-style-type: none"> 1. Enable L2 cache 2. Program Daylight Saving 3. Program boot up speed 4. Chipset final initialization. 5. Power management final initialization 6. Clear screen & display summary table 7. Program K6 write allocation 8. Program P6 class write combining
95	Update keyboard LED & typematic rate
96	<ol style="list-style-type: none"> 1. Build MP table 2. Build & update ESCD 3. Set CMOS century to 20h or 19h 4. Load CMOS time into DOS timer tick 5. Build MSIRQ routing table
FF	Boot attempt (INT 19h)

AC2005 POST Code Definition:

POST (hex)	Description
Power On Sequence	
8.1.	Start power on sequence
8.2.	Enable ATX power supply
8.3.	ATX power supply ready
8.4.	DDR voltage ready
8.5.	Setup PWM for CPU core voltage
8.6.	Assert PWM for CPU core voltage
8.7.	Check CPU core voltage
8.8.	CPU core voltage ready
8.9.	Initial clock generator IC
8.A.	North Bridge chipset voltage ready
8.B.	AGP voltage ready
8.C.	3VDUAL voltage ready
8.D.	VDDA 2.5V voltage ready
8.D.	GMCHVTT voltage ready
8.E.	Check CPU fan speed
8.F.	Assert all power ready
9.0.	Complete μ Guru initial process AWARD BIOS take over booting job
Power Off Sequence	
9.1.	Start power off sequence
9.2.	De-Assert all power
9.3.	Se-Assert power on
9.4.	De-Assert LDT Bus power
9.5.	De-Assert PWM for CPU core voltage
9.6.	De-Assert CPU core voltage
9.7.	Check CPU core voltage
9.8.	De-Assert ATX power supply
9.9.	Complete power off sequence
Others	
F.0.	Button reset
F.1.	SoftMenu reset
F.2.	Power on sequence timeout
F.3.	Power off sequence timeout

NOTE: The decimal point lights up when executing the AC2005 POST action.



Appendix J. Troubleshooting (Need Assistance?)

Q & A:

Q: Do I need to clear the CMOS before I use a new motherboard to assemble my new computer system?

A: Yes, we highly recommend that you clear the CMOS before installing a new motherboard. Please move the CMOS jumper from its default 1-2 position to 2-3 for a few seconds, and then back. When you boot up your system for the first time, follow the instructions in the user's manual to load the optimized defaults.

Q: If my system hangs when I update the BIOS or set the wrong CPU parameters, what should I do?

A: Whenever you update the BIOS or if the system hangs due to wrong CPU parameters setting, always clear CMOS jumper before booting up again.

Q: Why does the system fail to boot up again right after a mechanical power-off?

A: Please keep a 30-second interval between each mechanical power On/Off.

Q: Why does the system fail to boot up and nothing displays on the screen after I did some overclocking or non-standard settings inside the BIOS? Is the motherboard dead? Do I need to return it to where I bought from or go through an RMA process?

A: It should not cause hardware or permanent damage to motherboard when BIOS settings were changed from default to over-clocking or non-standard status.

We suggest the following three troubleshooting methods to discharge CMOS data, recover the hardware default status, and then making the motherboard work again. There is no need to bother returning the motherboard to where you bought it from or go through an RMA process.

Step 1. Switch off the power supply unit and then switch it on again after one minute. If there is no power switch on the power supply unit, disconnect its power cord for one minute and then reconnect.

Press and hold the <Insert> key on the keyboard, and press the power-on button to boot up system. If it works, release the <Insert> key and hit key to enter the BIOS setup page to apply the correct settings.

If the situation remains the same, repeat the procedures in Step 1 for three times, or try Step 2.

Step 2. Switch off the power supply unit or disconnect the power cord. Open the chassis cover. Locate the CCMOS jumper near the button battery. Change the jumper position from default 1-2 to 2-3 for one minute to discharge the CMOS data, and then put it back to default 1-2 position.

Close the chassis and switch on the power supply unit or plug in the power cord. Press the power-on button to boot up system. If it works, hit key to enter the BIOS setup page to do the correct settings.

If the situation remains the same, try Step 3.

Step 3. The same procedure as Step 2, but while discharging the CMOS data, pull out the ATX power connectors from motherboard and remove the button battery during CMOS discharge.

Q: How can I get a quick response to my request for technical support?

A: Be sure to follow the guidelines as stated in the “Technical Support Form” section of this manual.

If you have a problem during operation, in order to help our technical support personnel quickly determine the problem with your motherboard and give you the answers you need, eliminate any peripheral that is not related to the problem, and indicate it on the form. Fax this form to your dealer or to the company where you bought the hardware in order to receive prompt technical support. (You can refer to the examples given below)

Example 1:

With a system including: motherboard (with CPU, DRAM...) HDD, CD-ROM, FDD, VGA CARD, MPEG CARD, SCSI CARD, SOUND CARD, etc. If you cannot boot up after the system is assembled, check the key components of the system using the procedure described below. First remove all interface cards except the VGA card and try to reboot.

If you still cannot boot up: Try installing another brand/model VGA card and see if the system will start. If it still does not start, note the VGA card model, motherboard model, Bios identification number, and CPU on the technical support form (refer to main instructions), and describe the problem in the space provided.

If you can boot up: Insert the interface cards you have removed back into the system one by one, and try to start the system each time you insert a card until the system will not start. Keep the VGA card and the interface card that caused the problem inserted on the motherboard, remove any other cards or peripheral, and start again. If you still cannot start, note the information related to both cards in the add-on Card space provided, and don't forget to indicate the motherboard model, version, BIOS identification number, CPU (refer to main instructions), and give a description of the problem.

Example 2:

With a system including the motherboard (with CPU, DRAM...) HDD, CD-ROM, FDD, VGA CARD, LAN CARD, MPEG CARD, SCSI CARD, SOUND CARD, after assembly and after having installed the sound card driver, when you restart the system, it resets automatically when it runs the sound card Driver,. This problem may be due to the sound card driver. During the Starting DOS... procedure, press SHIFT (BY-PASS) key, to skip CONFIG.SYS and AUTOEXEC.BAT; edit CONFIG.SYS with a text editor, and in line that loads the sound card driver, add a remark REM, in order to disable the sound card driver. See the example below.

```
CONFIG.SYS:
DEVICE=C:\DOS\HIMEM.SYS
DEVICE=C:\DOS\EMM386.EXE HIGHSCAN
DOS=HIGH, UMB
FILES=40
BUFFERS=36
REM DEVICEHIGH=C:\PLUGPLAY\DWCFGMG.SYS
LASTDRIVE=Z
```

Restart the system. If the system starts and does not reset, you can be sure that the problem is due to the sound card driver. Write down the sound card model, motherboard model, BIOS identification number on the technical support file (refer to main instructions), and describe the problem in the space provided.

We will show you how to fill the “Technical Support Form”.

Main instructions:

To fill in this “**Technical Support Form**”, refer to the step-by-step instructions given below:

- 1* **MODEL:** Note the model number given in your user’s manual.
Example: N18 SLI
- 2* **Motherboard model number (REV):** Note the motherboard model number labeled on the motherboard as “REV:*.**”.
Example: REV: 1.01

- 3* **BIOS ID and Part Number:** See the on screen message.

- 4. **DRIVER REV:** Note the driver version number indicated on the DEVICE DRIVER disk (if any) as “Release *.*”. For example:

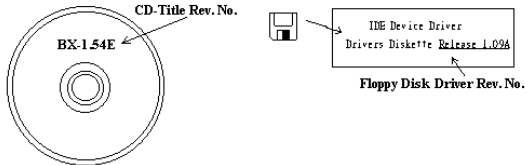

- 5* **OS/APPLICATION:** Indicate the operating system and applications you are running on the system.
Example: MS-DOS® 6.22, Windows® 98 SE, Windows® 2000, etc....

- 6* **CPU:** Indicate the brand and the speed (MHz) of your CPU.
Example:(A) In the “Brand” space, write “Intel”; in the “Specifications” space, write “Pentium® 4 1.9GHz”.

- 7. **HDD:** Indicate the brand and specifications of your HDD(s); specify if the HDD is using IDE1 or IDE2. If you know the disk capacity, indicate it and check (“✓”) “”; in case you give no indication, we will consider that your HDD is “IDE1” Master.
Example: In the “HDD” space, check the box; in the Brand space, write “Seagate”; in the Specifications space, write “ST31621A (1.6GB)”.

- 8. **CD-ROM Drive:** Indicate the brand and specifications of your CD-ROM drive. Specify if it uses IDE1 or IDE2 , and check (“✓”) “”; in case you give no indication, we will consider that your CD-ROM is “IDE2” Master.
Example: In the “CD-ROM drive” space, check the box, in the Brand space, write “Mitsumi”, in the Specifications space, write “FX-400D”.

- 9. **System Memory (DDR SDRAM):** Indicate the brand and specifications (DDR DIMM) of your system memory. Such as Density, Description, Module Components, Module Part Number, CAS Latency, and Speed (MHz).

For example: In the Brand space, write “**Micron**”; in the Specifications space, write: **Density:** 128MB, **Description:** SS 16 Megx72 2.5V ECC Gold, **Module Components:** (9) 16 Megx 8, **Module Part Number:** MT9VDDT1672AG, **CAS Latency:** 2, **Speed (MHz):** 200 MHz.

Please give us the detailed information of your DDR SDRAM module; it will help us to simulate the problems you met.

- 10. **ADD-ON CARD:** Indicate which add-on cards you are *absolutely sure* are related to the problem. If you cannot identify the problem’s origin, indicate all the add-on cards inserted into your system.

NOTE: Items between the “*” are absolutely necessary.

Appendix K. How to Get Technical Support

(From our website) <http://www.abit.com.tw>

(In North America) <http://www.abit-usa.com>

(In Europe) <http://www.abit.nl>

Thank you for choosing ABIT products. ABIT sells all our products through distributors, resellers and system integrators; we have no direct sales to end-users. Before sending email for tech support please check with your resellers or integrators if you need any services, they are the ones who sold you your system and they should know best as to what can be done, how they serve you is a good reference for future purchases.

We appreciate every customer and would like to provide the best service to you. Providing fast service to our customers is our top priority. However we receive many phone calls and a huge amount of email from all over the world. At the present time it is impossible for us to respond to every single inquiry.

We have done many compatibility tests and reliability tests to make sure our products have the best quality and compatibility. In case you need service or technical support, please understand the constraints that we have and **always check with the reseller who sold the product to you first.**

To expedite service, we recommend that you follow the procedures outlined below before contacting us. With your help, we can meet our commitment to provide the best service to the greatest number of ABIT customers:

- 1. Check the Manual.** It sounds simple but we have taken a lot of care in making a well-written and thorough manual. It is full of information that doesn't only pertain to motherboards. The CD-ROM included with your board will have the manual as well as drivers. If you don't have either one, go to our Program Download area of the website or our FTP server.
- 2. Download latest BIOS, software or drivers.** Please go to our Program Download area on our website to check to see if you have the latest BIOS. They are developed over periods of time to fix bugs or incompatibilities. **Also please make sure you have the latest drivers from your peripheral card makers!**
- 3. Check the ABIT Technical Terms Guide and FAQ on our website.** We are trying to expand and make the FAQs more helpful and information rich. Let us know if you have any suggestions. For hot topics, check out our HOT FAQ!

4. **Internet Newsgroups.** These are a great source of information and many people there can offer help. ABIT's Internet News group, alt.comp.periphs.mainboard.abit, is an ideal forum for the public to exchange information and discuss experiences they have had with ABIT products. Many times you will see that your question has already been asked before. This is a public Internet news group and it is reserved for free discussions. Here is a list of some of the more popular ones:

alt.comp.periphs.mainboard.abit
comp.sys.ibm.pc.hardware.chips
alt.comp.hardware.overclocking
alt.comp.hardware.homebuilt
alt.comp.hardware.pc-homebuilt

5. **Ask your reseller.** Your ABIT authorized distributor should be able to provide the fastest solution to your technical problem. We sell our products through distributors who sell to resellers and stores. Your reseller should be very familiar with your system configuration and should be able to solve your problem much more efficiently than we could. After all, your reseller regards you as an important customer who may purchase more products and who can urge your friends to buy from him or her as well. They integrated and sold the system to you. They should know best what your system configuration is and your problem. They should have reasonable return or refund policies. How they serve you is also a good reference for your next purchase.
6. **Contacting ABIT.** If you feel that you need to contact ABIT directly you can send email to the ABIT technical support department. First, please contact the support team for the branch office closest to you. They will be more familiar with local conditions and will have better insight as to which resellers offer what products and services. Due to the huge number of emails coming in every day and other reasons, such as the time required for problem reproduction, we will not be able to reply to every email. Please understand that we are selling through distribution channels and while we don't have the resources to serve every end-user, we will do our best to help every customer. Please also remember that for many of our technical support team English is a second language. You will have a better chance of getting a helpful answer if your question can be quickly understood. Be sure to use very, simple, concise language that clearly states the problem, avoid rambling or flowery language, and always list your system components and operating system. Here is the contact information for our branch offices:

**North America and
South America****ABIT Computer (U.S.A.) Corporation**2901 Bayview Drive,
Fremont CA, 94538, U.S.A.

Tel: 1-510-623-0500

Fax: 1-510-623-1092

Sales: sales@abit-usa.comLatin America Sales: ventas@abit-usa.comMarketing: marketing@abit-usa.comWeb Site: <http://www.abit-usa.com>RMA Center: <http://rma.abit-usa.com>

UK and Ireland**ABIT Computer (U.K.) Corporation Ltd.**Unit 3, 24-26 Boulton Road, Stevenage,
Herts SG1 4QX, UK

Tel: 44-1438-228888

Fax: 44-1438-226333

E-mail: sales@abitcomputer.co.uk

**Germany and Benelux (Belgium,
Netherlands, Luxembourg),
France, Italy, Spain, Portugal,
Greece, Denmark, Norway,
Sweden, Finland, and
Switzerland****AMOR Computer B.V. (ABIT's European Office)**Jan van Riebeeckweg 15, 5928LG, Venlo,
The Netherlands

Tel: 31-77-3204428

Fax: 31-77-3204420

Sales: sales@abit.nlWeb Site: <http://www.abit.nl>

**Austria, Czech, Romania,
Bulgaria, Slovakia, Croatia,
Bosnia, Serbia, and Macedonia****Asguard Computer Ges.m.b.H**Schmalbachstrasse 5,
A-2201 Gerasdorf / Wien, Austria

Tel: 43-1-7346709

Fax: 43-1-7346713

E-mail: asguard@asguard.at

Shanghai**ABIT Computer (Shanghai) Co. Ltd.**

Tel: 86-21-6235-1829

Fax: 86-21-6235-1832

Web Site: <http://www.abit.com.cn>

Russia and CIS**ABIT Computer (Russia) Co. Ltd.**Sales: sales@abit.ruInfo: info@abit.ruWeb Site: <http://www.abit.ru>

Poland **ABIT Computer (Poland) Co. Ltd.**
Przedstawicielstwo w Polsce ul. Wita Stwosza 28,
50-149 Wrocław
Tel: 48 71 780 78 65 / 66
Fax: 48 71 372 30 87

Japan Web Site: <http://www.abit4u.jp>

Taiwan Head Office **ABIT Computer Corporation**
*(Serving all other territories
not listed above.
Taiwan is 8+ GMT time,
and may have different holiday
calendar from yours.)*
No. 323, Yang Guang St.,
Neihu, Taipei, 114, Taiwan
Tel: 886-2-8751-8888
Fax: 886-2-8751-3382
Sales: sales@abit.com.tw
Marketing: market@abit.com.tw
Web Site: <http://www.abit.com.tw>

7. **RMA Service.** If your system has been working but it just stopped, but you have not installed any new software or hardware recently, it is likely that you have a defective component. Please contact the reseller from whom you bought the product. You should be able to get RMA service there.
8. **Reporting Compatibility Problems to ABIT.** Because of tremendous number of email messages we receive every day, we are forced to give greater weight to certain types of messages than to others. For this reason, any compatibility problem that is reported to us, giving detailed system configuration information and error symptoms will receive the highest priority. For the other questions, we regret that we may not be able to reply directly. But your questions may be posted to the Internet news group in order that a larger number of users can have the benefit of the information. Please check the news group from time to time.

Thank You

ABIT Computer Corporation

<http://www.abit.com.tw>