



Your Reliable Partner

IC7-G

Socket 478 System Board User's Manual

Copyright and Warranty Notice

The information in this document is subject to change without notice and does not represent a commitment on part of the vendor, who assumes no liability or responsibility for any errors that may appear in this manual.

No warranty or representation, either expressed or implied, is made with respect to the quality, accuracy or fitness for any particular part of this document. In no event shall the manufacturer be liable for direct, indirect, special, incidental or consequential damages arising from any defect or error in this manual or product.

Product names appearing in this manual are for identification purpose only and trademarks and product names or brand names appearing in this document are the property of their respective owners.

This document contains materials protected under International Copyright Laws. All rights reserved. No part of this manual may be reproduced, transmitted or transcribed without the expressed written permission of the manufacturer and authors of this manual.

If you do not properly set the motherboard settings, causing the motherboard to malfunction or fail, we cannot guarantee any responsibility.

Table Of Contents

| | |
|---|------------|
| IC7-G 快速安裝指引 | 1 |
| IC7-G のクイックインストールガイド | 3 |
| IC7-G Schnellinstallationsanleitung | 5 |
| IC7-G Guide d'Installation Rapide | 7 |
| Краткое руководство по установке IC7-G | 9 |
| Guida all'installazione veloce Scheda madre IC7-G..... | 11 |
| | |
| Chapter 1. Introduction | 1-1 |
| 1-1. Features & Specifications | 1-1 |
| 1-2. Layout Diagram | 1-3 |
| | |
| Chapter 2. Hardware Setup..... | 2-1 |
| 2-1. Install The Motherboard..... | 2-1 |
| 2-2. Install Pentium® 4 CPU and Heatsink Supporting-Base..... | 2-2 |
| 2-3. Install System Memory | 2-3 |
| 2-4. Connectors, Headers and Switches | 2-5 |
| (1). ATX Power Input Connectors [ATXPWR1, ATX12V1] | 2-5 |
| (2). FAN Connectors [CPUFAN1, NBFAN1, SYSFAN1, AUXFAN1, AUXFAN2] | 2-6 |
| (3). CMOS Memory Clearing Header [CCMOS1] | 2-7 |
| (4). Wake-up Header [PS2-PWR1, USB-PWR1, USB-PWR2] | 2-8 |
| (5). Front Panel Switches & Indicators Headers [FPIO1] | 2-9 |
| (6). Infrared Device Header [FPIO2] | 2-10 |
| (7). Additional USB Port Headers [FP-USB1, FP-USB2] | 2-11 |
| (8). Additional IEEE1394 Port Header [FP-1394-1, FP-1394-2]..... | 2-12 |
| (9). Front Panel Audio Connection Header [FP-AUDIO1]..... | 2-13 |
| (10). System Management Bus Headers [SMB1] | 2-14 |
| (11). Internal Audio Connectors [CD1, AUX1] | 2-14 |
| (12). Accelerated Graphics Port Slot [AGP1] | 2-15 |
| (13). Floppy Disk Drive Connector [FDC1] | 2-16 |
| (14). IDE Connectors [IDE1, IDE2]..... | 2-17 |
| (15). Serial ATA Connectors [SATA1~SATA4]..... | 2-18 |
| (16). Status Indicators [D1, D2] | 2-19 |
| (17). Back Panel Connectors [Mouse, Keyboard, LPT1, COM1, OPT-IN1, OPT-OUT1, AUDIO1, AUDIO2, IEEE1394/USB1, LAN/USB2] | 2-20 |

| | |
|---|------------|
| Chapter 3. BIOS Setup | 3-1 |
| 3-1. SoftMenu Setup..... | 3-2 |
| 3-2. Standard CMOS Features..... | 3-4 |
| 3-3. Advanced BIOS Features..... | 3-7 |
| 3-4. Advanced Chipset Features..... | 3-10 |
| 3-5. Integrated Peripherals | 3-12 |
| 3-6. Power Management Setup | 3-17 |
| 3-7. PnP/PCI Configurations..... | 3-20 |
| 3-8. PC Health Status | 3-22 |
| 3-9. Load Fail-Safe Defaults | 3-23 |
| 3-10. Load Optimized Defaults | 3-23 |
| 3-11. Set Password | 3-23 |
| 3-12. Save & Exit Setup..... | 3-23 |
| 3-13. Exit Without Saving..... | 3-23 |
| <i>Appendix A. Install Intel Chipset Software Utility</i> | <i>A-1</i> |
| <i>Appendix B. Install Intel Application Accelerator</i> | <i>B-1</i> |
| <i>Appendix C. Install Audio Driver</i> | <i>C-1</i> |
| <i>Appendix D. Install LAN Driver</i> | <i>D-1</i> |
| <i>Appendix E. Install Silicon Serial ATA RAID Driver</i> | <i>E-1</i> |
| <i>Appendix F. BIOS Update Guide</i> | <i>F-1</i> |
| <i>Appendix G. Hardware Monitoring (The Winbond Hardware Doctor Utility) ..</i> | <i>G-1</i> |
| <i>Appendix H. Installation Guide for Suspend to RAM</i> | <i>H-1</i> |
| <i>Appendix I. Troubleshooting (Need Assistance?)</i> | <i>I-1</i> |
| <i>Appendix J. How to Get Technical Support</i> | <i>J-1</i> |

IC7-G 快速安裝指引

如您要瞭解此主機板更詳細的資訊，請參閱我們的完整版使用手冊，裡面會有詳盡的說明。此快速安裝手冊是給有經驗的系統組裝者使用，如果這是您第一次嘗試來組裝您的電腦系統，我們建議您先去閱讀完整版的使用手冊，或是詢問技術人員來幫助您組裝您的電腦系統。（完整版的使用手冊已包覆在隨本主機板所附的驅動程式與應用光碟之中。）

處理器的安裝

本主機板提供零出力 (Zero Insertion Force, ZIF) 式 Socket 478，以方便安裝 Intel® Pentium® 4 CPU。您所購買的 CPU 應已配備一組散熱套件及散熱片，如果沒有，請購買專為 Pentium® 4 Socket 478 設計的散熱套件及散熱片。

1. 請找出 Socket 478 的位置，然後將散熱套件支座固定在主機板上。

注意：若果您使用專為 Pentium® 4 設計的底座，請注意底座上的金屬螺絲或墊片（若已安裝的話）。請確定金屬螺絲或墊片不會碰到印刷電路板上的電線或零件。

2. 請將 CPU 插座桿拉出至插座旁，然後將插座桿以 90 度角向上拉。請以正確的方向插入 CPU，因此如果遇到阻礙時，切勿勉強用力。最後壓住 CPU，並且門上插座桿。
3. 請將散熱裝置的正面向著 CPU 放入，直至完全蓋住 CPU 為止。
4. 將散熱裝置的支罩蓋在散熱裝置上。請確定支罩的每邊四個鎖扣都已鎖入鎖孔。
5. 將支罩兩側的固定夾往下壓，以夾緊支座。壓固定夾時，請注意壓按的方向。
6. 現在散熱支罩及支座應該已互相緊扣，而散熱裝置亦已裝妥在支罩內。

注意：請記得設定正確的處理器外頻和倍頻數值。

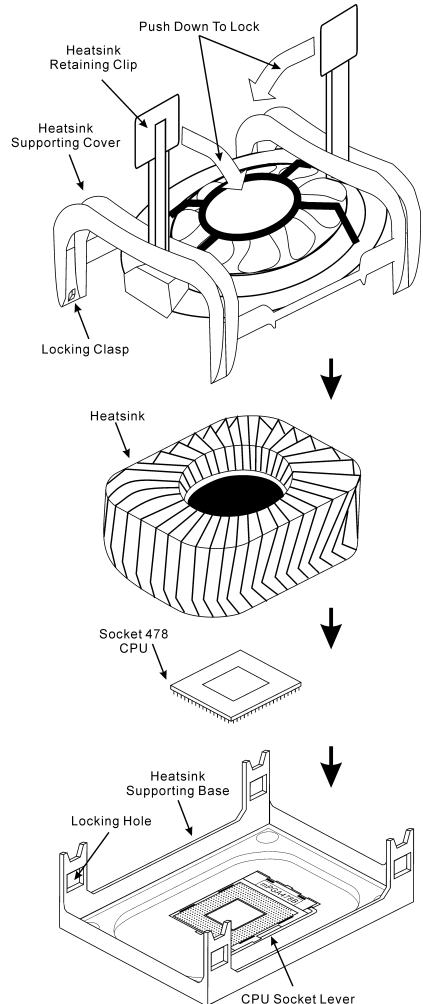

將主機板安裝到機殼上

當您將處理器安裝到主機板上之後，您就可以開始將主機板固定到電腦機殼裡去。首先；請您先將主機板固定到電腦機殼。大多數的電腦機殼底座都有許多的固定孔位，請將主機板上的固定孔位與機殼底座上的固定孔位對準。如果孔能對準並且有螺絲孔，就表示可使用銅柱來固定主機板。另外；您可以使用塑膠墊片來讓螺絲與主機板的 PCB 表層隔離（絕緣）。

安裝系統記憶體

本主機板提供 4 組 184 腳的 DDR DIMM 插座可供記憶體擴充。

將 DDR DIMM 記憶體模組插入 DIMM 插槽。請注意記憶體模組的楔子是如何對應到 DIMM 插槽上的卡榫之上。此種設計可確保 DDR DIMM 記憶體模組僅能由一個方向插到 DIMM 插槽之上。當您將 DDR DIMM 記憶體模組完全插入 DIMM 插槽時，模組退出（固定）夾應該會將 DDR DIMM 記憶體模組自兩側卡緊並緊緊地固定住記憶體模組。請依 DIMM1~DIMM4 插槽的順序來安裝記憶體模組。

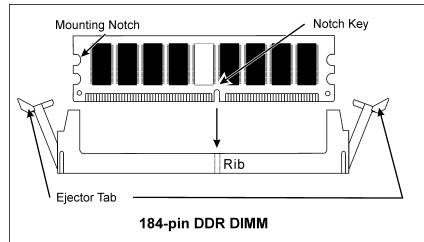

最後，您必需將所有必需的裝置纜線連接到主機板上相關的連接頭或是連接器上面，以完成您系統的硬體安裝動作。

連接器、連接頭以及附加卡的安裝

在任何一部電腦機殼的裡面，都必需連接一些纜線與插頭。這些纜線與插頭通常都是一對一的連接至主機板的連接埠上，您必需注意任何一條纜線的連接方向。如果可能的話，請一併注意連接埠第一根針腳的位置。您將會安裝一些特殊功能的附加卡到主機板上，像是 SCSI 卡或是 AGP 顯示卡等等。當您將它們安裝到主機板上適當的插槽之後，請以螺絲將這些附加卡與機殼背板牢牢地固定好，避免有鬆動的情況發生。

如您想要瞭解相關且更為詳細的資訊，請參閱我們的完整版使用手冊，裡面會有詳盡的說明。

將電源供應器的電源線連接頭與主機板上的 ATX 電源接頭連接起來

請將電源供應器的 ATX 電源接頭確實地壓入主機板上的 ATX 電源接頭，並確定連接妥當。

BIOS 的設定

當您將所有的硬體安裝完畢以後，就可以開啓電腦的電源並進入 BIOS 的選項。如您想要瞭解相關且更為詳細的資訊，請參閱我們的完整版使用手冊，裡面會有詳盡的說明。

IC7-G のクイックインストールガイド

このマザーボードの詳細については、ユーザーズマニュアルの完全版を参照してください。このクイックインストールガイドは、経験あるシステム構築者向けに書かれました。今回初めてコンピュータシステムをセットアップする方は、まず完全版のマニュアルをお読みになるか、専門技術者に連絡してコンピュータシステムのセットアップを行うようお勧めします。（完全なユーザーズマニュアルはこのマザーボードに付属するドライブとユーティリティ CD を検索して入手できます。）

プロセッサの取り付け

このマザーボードは ZIF (ゼロインサージョンフォース) Socket 478 を提供して Intel® Pentium® 4 CPU をインストールします。お買い上げになった CPU には、ヒートシンクと冷却ファンのキットが付属しています。付属していない場合、Pentium® 4 Socket 478 向けに特別に設計されたキットをお求めください。

1. Socket 478 を設置します。ヒートシンクをマザーボード上のサポート台に固定してください。

注意: Pentium® 4 向けに特別に設計されたシャーシをお使いの場合、金属スタッドやスペーサがすでにインストールされている場合、それらの場所に注意してください。金属スタッドやスペーサがプリント基板線や PCB の部品に触れないように気をつけてください。

2. CPU のソケットレバーをソケットから横方向に引いて、90 度以上に持ち上げます。CPU を正しい方向に挿入します。CPU を挿入する際、余分な力を入れないでください。1 方向にだけ適合します。CPU を下に押しながら、ソケットレバーをクローズします。
3. ヒートシンクの面が CPU を完全に覆うまで、CPU の上に下ろします。
4. ヒートシンクのサポートカバーをヒートシンクに置きます。サポートカバーの各面の 4 本の留め金がすべて固定穴に届いていることを確認してください。
5. サポートカバーの両側の支持クリップを下に押し、サポート台と共に固定します。クリップを下に押しときに方向に注意してください。
6. ヒートシンクのサポートカバーと台は、ヒートシンクの内側でお互いにしっかりと固定されている必要があります。

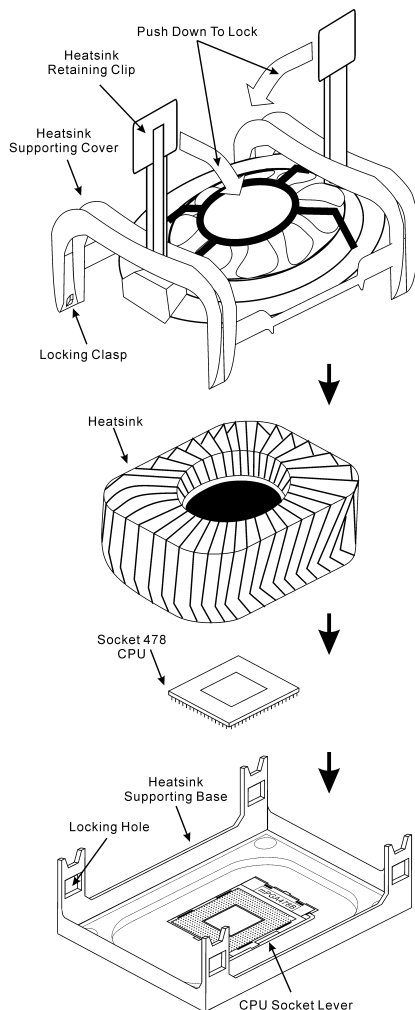

注意： プロセッサに対して、正しいバス周波数とマルチプルに設定することを忘れないでください。

マザーボードをシャーシに取り付ける

マザーボードにプロセッサを取り付けた後、シャーシにマザーボードを固定することができるようになります。まず、シャーシにマザーボードを固定する必要があります。ほとんどのコンピュータシャーシには、多くの取り付け穴の付いた台が付属しており、それを使用することでマザーボードをしっかりと取り付けたり、同時にショートを避けることができます。シャーシに付属する飾りボタンかスペーサーを使用してマザーボードを固定します。

システムメモリの取り付け

このマザーボードでは、4つの184ピンDDR DIMMスロットメモリ拡張を提供します。

DDR DIMM を図に示すように拡張スロットに差し込みます。モジュールがソケットにどのように固定されているか注意してください。これにより、DDR DIMM モジュールに差し込む方法が1つしかないことを確認できます。DDR DIMM モジュールをDDR DIMM ソケットにしっかりと押し込み、モジュールがDDR DIMM ソケットに完全に差し込まれていることを確認します。

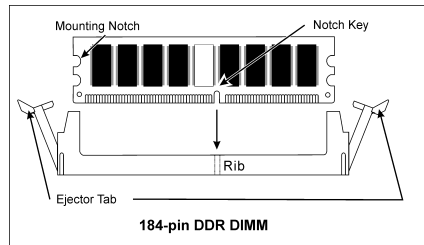

これらのモジュールに対して、DIMM1 からDIMM4 まで順に差し込むようにお勧めします。

次に、すべての必要なデバイスケ이블をマザーボードの関連ヘッダとコネクタに接続して、システムのハードウェア取付けを終了する必要があります。

コネクタ、ヘッダ、スイッチおよびアダプタ

コンピュータのケース内部には、複数のケーブルやプラグを接続できます。これらのケーブルやプラグは、通常マザーボードにあるコネクタに1つずつ接続されます。ケーブルの接続方向には十分な注意を払い、また必要に応じ、コネクタの第1ピンの位置にも注目する必要があります。SCSI アダプタ、AGP アダプタのような特殊なニーズ向けには、それに対応したアダプタを取り付けてください。アダプタをマザーボードのスロットに取り付けいたら、ネジでシャーシの背面パネルに固定してください。

詳細については、ユーザーズマニュアルの完全版を参照してください。

電源コネクタを ATX 電源コネクタに差し込む

電源装置から出ている電源ブロックコネクタをこの ATX 電源に接続します。コネクタが十分奥まで装着されていることをご確認ください。

BIOS のセットアップ

ハードウェアの取り付けが完了したら、コンピュータの電源をオンにし、BIOS Setup アイテムに移動して、プロセッサのパラメータをセットアップします。詳細については、ユーザーズマニュアルの完全版を参照してください。

IC7-G Schnellinstallationsanleitung

Beziehen Sie sich bitte für detaillierte Informationen über diese Hauptplatine auf die vollständige Version des Benutzerbuchs. Diese Schnellinstallationsanleitung ist für erfahrene Systemaufbauer gedacht. Ist es Ihr erster Versuch ein Computersystem aufzubauen, dann empfehlen wir Ihnen zuerst das vollständige Benutzerhandbuch zu lesen oder einen Techniker zum Aufbauen des Systems zu Hilfe zu holen. (Ein komplettes Handbuch finden Sie auf der CD mit den Treibern und Hilfsprogrammen, die diesem Motherboard beiliegt.)

Installieren des Prozessors

Dieses Motherboard verfügt über einen ZIF (Zero Insertion Force) Socket 478 zur Installation eines Intel® Pentium® 4 CPU. Ihre CPU sollte über ein Kühlblech und einen Lüfter verfügen. Wenn dies nicht der Fall ist, kaufen Sie bitte diese Teile speziell für den Pentium® 4 Socket 478.

1. Finden Sie den Socket 478. Bringen Sie die Basis des Kühlblechs am Motherboard an.

Achtung: Wenn Sie ein speziell für den Pentium® 4 entworfenes Gehäuse verwenden, achten Sie bitte auf die Lage der Metallbolzen oder Abstandhalter, falls diese schon im Gehäuse angebracht sind. Achten Sie darauf, diese Metallbolzen bzw. Abstandhalter nicht in Kontakt mit den gedruckten Schaltkreisen oder Teile auf dem PCB kommen zu lassen.

2. Ziehen Sie den CPU-Sockelhebel seitlich vom Sockel weg und dann nach im 90°-Winkel nach oben. Setzen Sie die CPU in der korrekten Ausrichtung ein. Wenden Sie beim Einsetzen der CPU keine Gewalt an; sie passt nur in eine Richtung in den Sockel. Schließen Sie den Sockelhebel wieder, während Sie die CPU nach unten gedrückt halten.
3. Setzen Sie das Kühlblech mit der Vorderseite nach unten auf die CPU, bis es die CPU komplett abdeckt.
4. Setzen Sie die Kühlblechabdeckung auf das Kühlblech. Achten Sie darauf, dass die vier Verschlüsse auf jeder Seite der Kühlblechabdeckung völlig in den Verschlusslöchern sitzen.
5. Drücken Sie die Halteklammern an beiden Seiten der Halteklammern, bis sie mit der Basis verriegelt sind. Achten Sie beim Herunterdrücken der Klammern auf die Richtung.

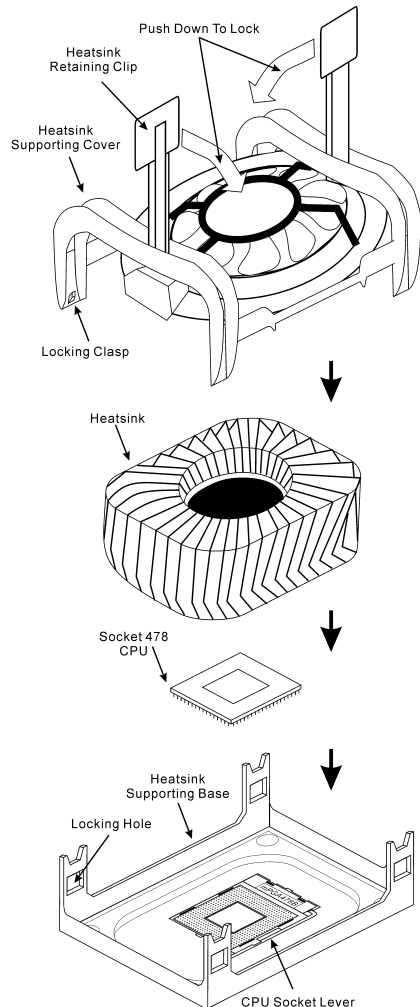

6. Kühlblechabdeckung und –basis sollten nun fest miteinander das Kühlblech umschließen.

Achtung: Vergessen Sie nicht, die korrekte Busfrequenz und Multiplikator für Ihren Prozessor einzustellen.

Installieren der Hauptplatine im Gehäuse

Nach der Installation des Prozessors können Sie anfangen die Hauptplatine im Computergehäuse zu befestigen. Die meisten Gehäuse haben eine Bodenplatte, auf der sich eine Reihe von Befestigungslöcher befinden, mit deren Hilfe Sie die Hauptplatine sicher verankern können und zugleich Kurzschlüsse verhindern. Verwenden Sie entweder die Dübeln oder die Abstandhalter, um die Hauptplatine auf der Bodenplatte des Gehäuses zu befestigen.

Installieren des Arbeitsspeichers

Diese Hauptplatine bietet 4 184-polige DDR DIMM-Steckplätze an.

Stecken Sie das DDR DIMM-Modul in den Speichersteckplatz ein, wie in der Abbildung dargestellt. Achten Sie darauf, wie die Kerbe des Moduls in den Steckplatz passt. So ist sichergestellt, dass das DDR DIMM-Modul nur in eine Richtung in den Steckplatz eingesteckt werden kann. Drücken Sie das DDR DIMM-Modul fest in den DDR DIMM-Steckplatz, bis es komplett und fest darin sitzt.

Für solche Module, empfehlen wir Ihnen die Bestückung von DIMM1 zu DIMM4 (in dieser Reihenfolge).

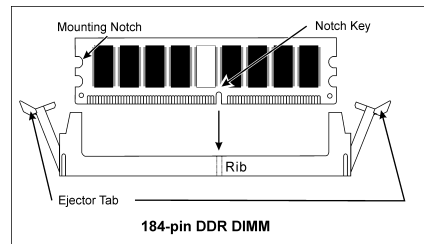

Danach müssen Sie alle nötigen Geräte Kabel mit den entsprechenden Sockeln und Anschlüssen auf der Hauptplatine verbinden, um die Hardwareinstallation Ihres Systems zu vervollständigen.

Anschlüsse, Sockel, Schalter und Adapter

Im Inneren des Gehäuses findet man in jedem Computer viele Kabel und Stecker, die angeschlossen werden müssen. Diese Kabel und Stecker werden normalerweise einzeln mit den Anschlüssen auf der Hauptplatine verbunden. Sie müssen genau auf die Anschlussorientierung der Kabel achten und, wenn vorhanden, sich die Position des ersten Pols des Anschlusses merken. Wenn Sie Adapter wie z.B. SCSI-Adapter, AGP-Adapter usw. installieren, befestigen Sie bitte die Adapter immer mit Hilfe der Schrauben auf die Rückseite des Computergehäuses.

Für detaillierte Informationen beziehen Sie sich bitte auf das vollständige Benutzerhandbuch.

Verbinden der Netzstecker mit dem ATX-Anschluss

Denken Sie daran, den Anschluss des ATX-Netzteils fest in das Ende mit dem ATX-Anschluss zu drücken, um eine feste Verbindung zu garantieren.

BIOS-Setup

Schalten Sie nach der vervollständigten Hardwareinstallation den Computer ein und gehen zur Option im BIOS, um die Prozessorparameter einzustellen. Für detaillierte Informationen beziehen Sie sich bitte auf das vollständige Benutzerhandbuch.

IC7-G Guide d'Installation Rapide

Pour des informations relatives à cette carte mère plus détaillées, veuillez vous référer à notre version complète du manuel utilisateur. Ce guide d'installation rapide est créé pour les assembleurs système expérimentés. S'il s'agit de votre premier essai pour installer un ordinateur, nous vous suggérons de lire d'abord le manuel en version complète ou de demander l'aide d'un technicien pour vous aider à configurer le système ordinateur. (Un manuel de l'utilisateur complet est disponible en naviguant dans le CD des pilotes et utilitaires fournis avec la carte mère.)

Installer le Processeur

Cette carte mère fournit un support ZIF (Zero Insertion Force) Socket 478 permettant d'installer le Microprocesseur Intel® Pentium® 4. Le microprocesseur que vous achetez doit être muni d'un système de refroidissement avec dissipateur thermique et ventilateur. Dans le cas contraire, veuillez en acheter un, conçu spécialement pour les microprocesseurs Pentium® 4 Socket 478.

1. Placez le Socket 478. Fixez la base support du dissipateur thermique sur la carte mère.

Attention: Si vous utilisez un châssis conçu spécialement pour Pentium® 4, veuillez faire attention à l'emplacement des clous ou spacers métalliques si ceux-ci sont déjà installés sur le châssis. Faites attention de ne pas laisser les talons (studs) ou entretoises (spacers) métalliques en contact avec des fils ou des parties de circuit imprimé se trouvant sur le PCB.

2. Tirez de côté le levier de l'emplacement du CPU et tirez-le vers le haut à 90 degrés. Insérez le Microprocesseur en respectant une bonne orientation. Ne pas utiliser une force excessive en insérant le CPU; il s'installe uniquement dans une position. Fermez le levier d'emplacement en maintenant le Microprocesseur en place.
3. Mettez le dissipateur thermique face au microprocesseur jusqu'à ce qu'il le couvre complètement.
4. Mettez le couvercle support du dissipateur thermique sur le dissipateur thermique. Assurez-vous que les quatre verrous situés sur chaque côté du couvercle support vont bien dans les trous de verrouillage.
5. Poussez les attaches de maintenance se trouvant de chaque côté du couvercle support pour le rendre solidaire de la base support. Faites à la direction en poussant les attaches.

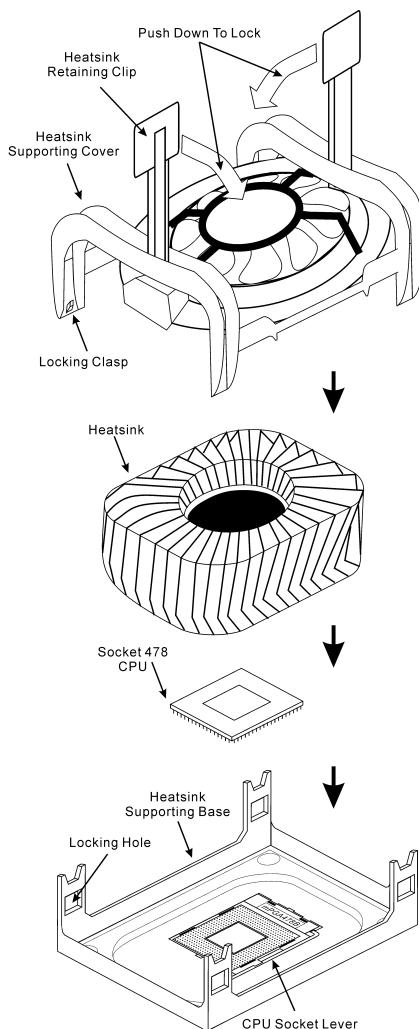

6. Le couvercle support et la base du dissipateur thermique doivent maintenant être fermement fixés l'un à l'autre fermement avec le dissipateur thermique à l'intérieur.

Attention: N'oubliez pas de régler une fréquence de Bus et un coefficient multiplicateur corrects pour votre processeur.

Installer la Carte Mre dans le Châssis

Une fois que vous aurez installé le processeur sur la carte mère, vous pourrez commencer à fixer la carte mère sur le châssis. Tout d'abord, vous avez besoin de fixer la carte mère sur le châssis. La plupart des châssis d'ordinateur possèdent une base sur laquelle il y a nombreux trous de montage permettant à la carte mère d'être fixée fermement, et en même temps d'éviter les court-circuits. Utilisez les talons ou les entretoises fixés sur le châssis pour fixer la carte mère.

Installer la Mémoire Système

Cette carte mère dispose de 4 emplacements DIMM DDR 184-broches pour les extensions mémoire.

Insérez le module DDR DIMM dans l'emplacement d'extension comme illustré dans le schéma. Notez comment le module est verrouillé dans l'emplacement. Ceci assure qu'il n'y qu'une manière d'insérer le module DDR DIMM. Pressez fermement le module DDR DIMM dans l'emplacement DDR DIMM; assurez-vous que le module est installé complètement dans l'emplacement DDR DIMM. Pour ces modules, nous vous suggérons de remplir de DIMM1 à DIMM4 en respectant l'ordre.

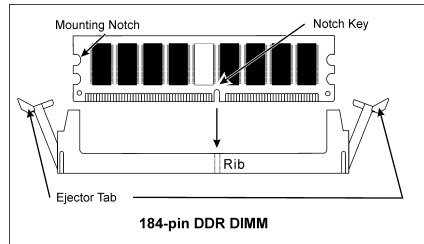

Ensuite, vous aurez à connecter les câbles de tous les périphériques nécessaires dans les socles de connexion et connecteurs correspondants se trouvant sur la carte mère pour terminer l'installation matérielle de votre système.

Connecteurs, Socles de connexion, Interrupteurs et Adaptateurs

A l'intérieur du boîtier de n'importe quel ordinateur il y a plusieurs câbles et prises qui doivent être connectés. Ces câbles et prises sont habituellement connectés les uns après les autres aux connecteurs situés sur la carte mère. Vous avez besoin de faire attention au sens de connexion des câbles et, s'il y a lieu, remarquez la position de la première broche du connecteur. Vous installerez certains adaptateurs pour des besoins spéciaux, tels adaptateurs SCSI, adaptateurs AGP, etc. Lorsque vous les installez dans les emplacements situés sur la carte mère, veuillez les fixer sur le panneau arrière du châssis à l'aide des vis.

Pour les informations détaillées, veuillez vous référer au manuel utilisateur en version complète.

Brancher les connecteurs d'alimentation dans les connecteurs ATX

Souvenez-vous que vous devez pousser le connecteur de votre alimentation fermement dans le connecteur ATX pour assurer une bonne connexion.

Configuration du BIOS

Une fois le matériel installé complètement, démarrez l'ordinateur et allez sur l'item dans le BIOS pour configurer les paramètres du processeur. Pour les informations détaillées, veuillez vous référer à la version complète du manuel utilisateur.

Краткое руководство по установке IC7-G

Более подробные сведения о материнской плате приведены в руководстве пользователя. Краткое руководство по установке предназначено для опытных специалистов. Если вы собираете компьютер впервые, ознакомьтесь сперва с руководством пользователя или попросите техника помочь в настройке компьютерной системы.

Установка процессора

На этой системной плате используется гнездо ZIP (с нулевым усилием установки) типа 'Socket 478' для процессора Intel® Pentium® 4. В комплект приобретаемого процессора должны входить радиатор и вентилятор. В противном случае следует приобрести радиатор и вентилятор, предназначенные для процессора Pentium® 4 с разъемом 'Socket 478'.

1. Найдите на плате гнездо 'Socket 478'. Зафиксируйте крепежное основание радиатора на системной плате.

Внимание: При использовании корпуса специально предназначенного для Pentium® 4 обратитесь внимание на расположение металлических вставок или распорок, если они уже установлены в корпус. Не допускайте контакта металлических вставок или распорок с проводниками или деталями печатной платы.

2. Сместите рычаг гнезда процессора в сторону от гнезда, а затем поверните его вверх на 90 градусов. Вставьте процессор, ориентируя его надлежащим образом. Устанавливая процессор, не прикладывайте чрезмерных усилий. Его установка возможна только в одном положении. Прижав процессор сверху, опустите рычаг гнезда.
3. Поместите радиатор плоской стороной на процессор так, чтобы процессор был полностью закрыт.
4. Поместите прижимную крышку радиатора на радиатор. Все четыре фиксатора по обеим сторонам прижимной крышки должны находиться на уровне крепежных отверстий.
5. Прижмите вниз фиксирующие зажимы по обеим сторонам прижимной крышки до их фиксации в крепежном основании. Следите за направлением, в котором Вы прижимаете зажимы.

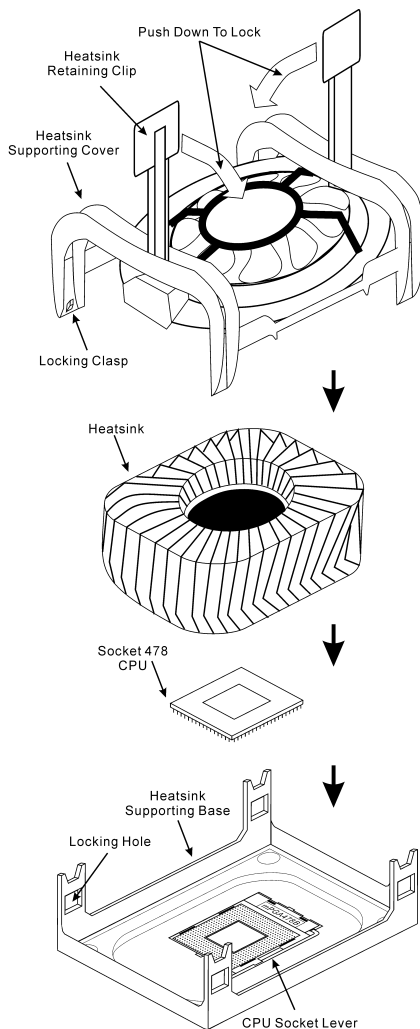

6. Крышка и основание должны быть надежно скреплены, фиксируя радиатор.

Внимание: Не забудьте установить для процессора надлежащую частоту шины и множитель.

Установка материнской платы в корпус

После установки процессора на материнскую плату можно начинать установку материнской платы в корпус. Большая часть корпусов оборудована основанием, в котором проделаны монтажные отверстия, которые позволяют надежно закрепить материнскую плату и предотвратить короткие замыкания. Для крепления материнской платы к основанию используются винты и прокладки.

Установка модулей памяти

На плате имеется 4 184-контактных гнезда расширения DDR DIMM для памяти.

Установите модуль памяти DDR DIMM в гнездо расширения, как показано на рисунке. Обратите внимание, что модуль фиксируется в гнезде. Таким образом, гарантируется единственно возможный способ установки модуля DDR DIMM. Вставьте модуль DDR DIMM в гнездо DDR DIMM; и убедитесь, что модуль надежно установлен в гнездо DDR DIMM. Для этих модулей мы рекомендуем устанавливать память начиная с DIMM1 и далее по DIMM4.

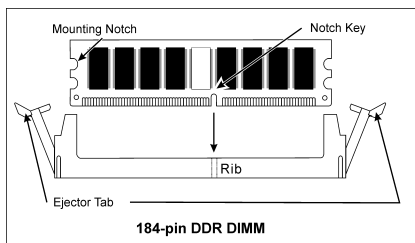

Подключите все необходимые кабели для подключения устройств к соответствующим разъемам на материнской плате, чтобы завершить установку аппаратуры вашей системы.

Разъемы, переключатели и адаптеры

Внутри корпуса компьютера необходимо расположены несколько кабелей и вилок, которые необходимо подключить. Обычно эти кабели подключаются к разъемам, расположенным на материнской плате. При подключении любого кабеля необходимо обращать внимание на расположение первого контакта разъема. Для особых целей могут потребоваться специальные адаптеры, например, адаптер SCSI, адаптер AGP и т.п.. При установке адаптеров в гнезда материнской платы закрепите их на задней панели с помощью винтов.

За более подробной информацией обращайтесь к полному руководству пользователя.

Подключение кабелей питания к разъемам ATX

Обратите внимание, разъем блока питания ATX необходимо вставить в разъем ATX до упора, чтобы обеспечить надежное соединение.

Настройка BIOS

По окончании установки аппаратуры включите питание и перейдите в меню BIOS Setup, чтобы настроить параметры процессора. За более подробной информацией обращайтесь к руководству пользователя.

Guida all'installazione veloce Scheda madre IC7-G

Per maggiori e dettagliate informazioni su questa scheda madre si prega di fare riferimento alla versione integrale del Manuale utente. Questa guida all'installazione veloce è intesa per costruttori esperti di sistemi. Se questa è la prima volta che si cerca di installare un sistema, si consiglia di leggere, innanzi tutto, la versione integrale del manuale oppure di chiedere aiuto ad un tecnico per l'installazione.

Installazione del processore

Questa scheda madre fornisce una presa "Socket 478" ZIF (Zero Insertion Force – forza d'inserimento zero) per installare il processore Intel® Pentium® 4. Il processore acquistato dovrebbe essere fornito di dispersore di calore e ventolina per il raffreddamento. In caso contrario acquistare un dispersore di calore specifico per la presa Socket 478 Pentium®.

1. Localizzare la presa Socket 478. Fissare la base di supporto dispersore di calore sulla scheda madre.

Attenzione: Se si impiega un telaio progettato specificatamente per il processore Pentium® 4, prestare attenzione all'ubicazione delle borchie in metallo o degli spaziatori, nel caso in cui siano già installati sul telaio. Assicurarsi di non permettere alle borchie in metallo od agli spaziatori di entrare in contatto con il cavo o con le parti del circuito stampato.

2. Tirare di lato la leva della presa del processore allontanandola dalla presa; poi sollevarla di 90 gradi. Inserire il processore con il corretto orientamento. Non sforzare per inserire il processore poiché si adatta solamente in un dato orientamento. Chiudere la leva della presa mentre si trattiene il processore.
3. Mettere il dispersore di calore a faccia in giù sul processore finché lo copre completamente.
4. Mettere il coperchio di supporto del dispersore di calore sul dispersore di calore. Assicurarsi che tutti e quattro i fermagli, su ciascun lato del coperchio di supporto, si inseriscano nei fori di bloccaggio.
5. Spingere verso il basso i fermagli di bloccaggio su ciascun lato del coperchio di supporto in modo da fissarlo alla base di supporto. Prestare attenzione alla direzione in cui si spingono i fermagli.

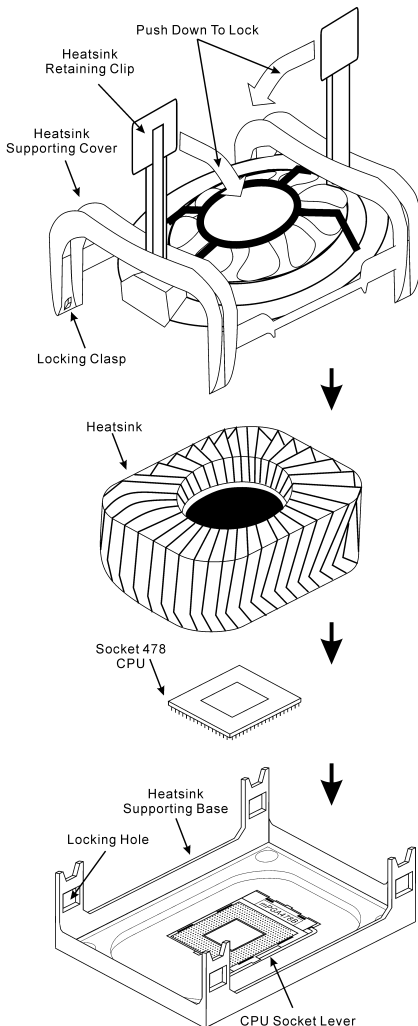

6. Il coperchio di supporto e la base del dissipatore di calore dovrebbero ora essere fissate saldamente l'una all'altra, contenendo al loro interno il dissipatore di calore.

Attenzione: Non dimenticare di impostare la corretta frequenza BUS e multiplier per il processore.

Installazione della scheda madre sul telaio

Dopo avere installato il processore sulla scheda madre si può iniziare a fissare la scheda madre sul telaio. Innanzi tutto è necessario fissare la scheda madre al telaio. La maggior parte dei telai ha una base sulla quale sono presenti diversi fori di montaggio che permettono di fissare in modo accurato la scheda madre e, allo stesso tempo, di prevenire corto circuiti. Impiegare le borchie o gli spaziatori attaccati al telaio per fissare la scheda madre.

Installazione della memoria di sistema

Questa scheda madre fornisce 4 slot d'espansione di memoria DDR DIMM da 184 pin.

Inserire il modulo DDR DIMM nello slot d'espansione come mostrato nell'illustrazione- Notare come il modulo è imperniato nella presa. Ciò assicura che ci sia un unico modo per collegare il modulo DDR DIMM. Premere con fermezza il modulo DDR DIMM nello slot DDR DIMM, assicurandosi che il modulo sia inserito completamente nello slot DDR DIMM. Per questi moduli si suggerisce di inserire con ordine i chip elettronici da DIMM1 a DIMM4.

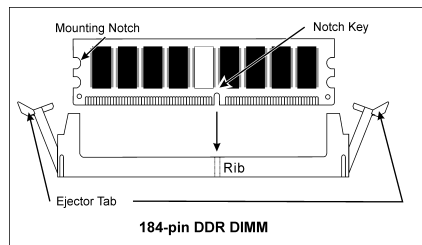

Per completare l'installazione dell'hardware del sistema, bisogna collegare tutti i cavi delle attrezzature necessarie ai relativi collettori e connettori sulla scheda madre.

Connettori, collettori, interruttori ed adattatori

All'interno della copertura di ogni computer ci sono diversi cavi e prese che devono essere collegati. Questi cavi e prese sono solitamente collegati uno ad uno ai connettori situati sulla scheda madre. È necessario prestare particolare attenzione a qualunque orientamento del collegamento che possono avere i cavi e, se necessario, notare la posizione del primo pin del connettore. Si installeranno alcuni adattatori per particolari necessità quali l'adattatore SCSI, AGP, eccetera. Quando si installano gli adattatori sugli slot della scheda madre, si ricorda di fissarli con le viti anche sul pannello posteriore del telaio.

Per informazioni dettagliate si prega di fare riferimento alla versione integrale del Manuale utente.

Collegamento dei connettori d'alimentazione ai connettori ATX

Ricordarsi che è necessario spingere con fermezza fino in fondo il connettore della sorgente d'alimentazione ATX al connettore ATX, assicurando così un buon collegamento.

Impostazione BIOS

Quando l'hardware è stato installato completamente, accendere il computer ed andare alla voce BIOS per impostare i parametri del processore. Per informazioni dettagliate si prega di fare riferimento alla versione integrale del Manuale utente.

Chapter 1. Introduction

1-1. Features & Specifications

1. CPU

- Supports Intel Pentium 4 Socket 478 processor with 800/533/400MHz System Data Bus
- Supports Intel Hyper-Threading Technology

2. Chipset

- Intel 82875P (MCH) + 82801EB (ICH5R)
- Supports dual channel DDR 400 with ECC function and “Performance Acceleration Technology (PAT)”
- Supports Hi-Speed Universal Serial Bus (USB 2.0)
- Supports Ultra ATA/100/66/33 mode

3. Memory

- 4x 184-pin DIMM sockets
- Supports 4 DIMM Single/Dual Channel DDR 400 (Max. 4GB)
- Supports configurable ECC function

4. AGP

- Accelerated Graphics Port connector supports AGP 8X/4X Interface (0.8V/1.5V)

5. LAN

- Onboard Intel CSA Gigabit LAN

6. Dual Serial ATA RAID

- 2 channels of Serial ATA 150MB/s data transfer rate with RAID function (0) via ICH5R South Bridge
- 2 channels of Serial ATA 150MB/s data transfer rate with RAID function (0/1) via Silicon Image PCI Chip

7. Media XP (Optional)

- Supports card reader function for Memory Stick, Secure Digital and Type I/II CompactFlash
- Supports Wireless Remote Control and S/PDIF Out / Mic In / Headphone Out / USB 2.0 / IEEE 1394

8. USB 2.0

- 8x USB 2.0 ports support 480 Mb/s data transfer rate

9. IEEE 1394

- Supports IEEE 1394a at 400/200/100 Mb/s data transfer rate

10. Audio

- Onboard RealTek ALC650 6-Channel AC 97 CODEC
- Professional digital audio interface supports 24-bit S/PDIF Input/Output

11. System BIOS

- SoftMenu™ Technology to set CPU parameters
- Supports Plug-and-Play (PNP)
- Supports Advanced Configuration Power Interface (ACPI)
- Supports Desktop Management Interface (DMI)
- Write-Protect Anti-Virus function by AWARD BIOS

12. Internal I/O Connectors

- 1x AGP slot
- 5x PCI slots
- 1x Floppy port supports up to 2.88MB
- 2x Ultra ATA/100/66/33 connectors
- 4x Serial ATA 150 connectors
- 2x USB 2.0 headers
- 2x IEEE 1394a headers
- 1x CD-IN, 1x AUX-IN header
- 1x IrDA header

13. Back Panel I/O

- 1x PS/2 Keyboard, 1x PS/2 mouse
- 1x Serial port connectors, 1x Parallel port connector
- 1x S/PDIF In connector
- 1x S/PDIF Out connector
- AUDIO1 connector (Rear-Left / Rear-Right, Center/Subwoofer)
- AUDIO2 connector (Mic-In, Line-In, Front-Left/Front-Right)
- 2x USB 2.0, 1x IEEE 1394 Connector
- 2x USB 2.0, 1x RJ-45 LAN Connector

14. Miscellaneous

- ATX form factor
 - Hardware Monitoring – including Fan Speed, Voltages, CPU and system temperature
 - Supports Wake Up by LAN, Modem Ring, RTC Alarm, Keyboard and Mouse Power On
 - Supports STR (Suspend to RAM)
- * **Supports Wake On LAN, Modem, but your ATX power supply 5V standby power must be able to provide at least a 720mA current capacity. Otherwise, the functions may not work normally.**
- * **This motherboard supports the standard bus speeds of 100/66/33MHz that are used by specific PCI, processor and chipset specifications. Exceeding these standard bus speeds is not guaranteed due to the specific component specifications.**
- * **The Serial ATA controller only supports Ultra DMA/ATA100 or higher hard drive. Do not use hard drives under this specification, or it won't work.**
- * **Specifications and information contained herein are subject to change without notice.**



Chapter 2. Hardware Setup

Before the Installation: Turn off the power supply switch (fully turn off the +5V standby power), or disconnect the power cord before installing or unplugging any connectors or add-on cards. Failing to do so may cause the motherboard components or add-on cards to malfunction or damaged.

2-1. Install The Motherboard

Most computer chassis have a base with many mounting holes to allow motherboard to be securely attached on and at the same time, prevented from short circuits. There are two ways to attach the motherboard to the chassis base:

- 1. use with studs
- 2. or use with spacers

In principle, the best way to attach the board is to use with studs. Only if you are unable to do this should you attach the board with spacers. Line up the holes on the board with the mounting holes on the chassis. If the holes line up and there are only slots, you can attach the board with studs. If the holes line up and there are only slots, you can only attach with spacers. Take the tip of the spacers and insert them into the slots. After doing this to all the slots, you can slide the board into position aligned with slots. After the board has been positioned, check to make sure everything is OK before putting the chassis back on.

ATTENTION: To prevent shorting the PCB circuit, please REMOVE the metal studs or spacers if they are already fastened on the chassis base and are without mounting-holes on the motherboard to align with.

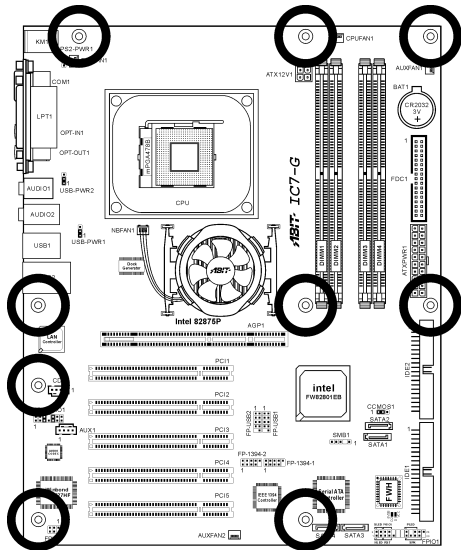
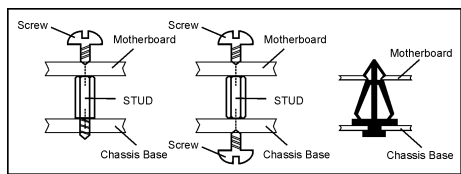

2-2. Install Pentium® 4 CPU and Heatsink Supporting-Base

This motherboard provides a ZIF (Zero Insertion Force) Socket 478 to install Intel® Pentium® 4 CPU. The CPU you bought should have a kit of heatsink and cooling fan along with. If that's not the case, buy one specially designed for Pentium® 4 Socket 478.

1. Locate the Socket 478. Fasten the heatsink supporting-base onto the motherboard.

ATTENTION: If you are using chassis specially designed for Pentium® 4, please pay attention to the location of metal studs or spacers if they are already installed on the chassis. Be careful not let the metal studs or spacers contact the printed circuit wire or parts on the PCB.

2. Pull the CPU socket lever sideways away from the socket and then upwards to 90 degree. Insert the CPU with the correct orientation. Do not use extra force to insert CPU; it only fit in one orientation. Closing down the socket lever while holding down the CPU.
3. Put the heatsink faces down onto the CPU until it completely covers the CPU.
4. Put the heatsink supporting-cover onto the heatsink. Make sure all the four locking clasp reach in the locking holes.
5. Push down the retaining clip at both sides of the supporting cover to lock up together with the supporting base. Watch out the direction for pushing down the clip.
6. The heatsink supporting cover and base should now firmly locking up with each other with the heatsink inside.

ATTENTION: Do not forget to set the correct bus frequency and multiple for your processor.

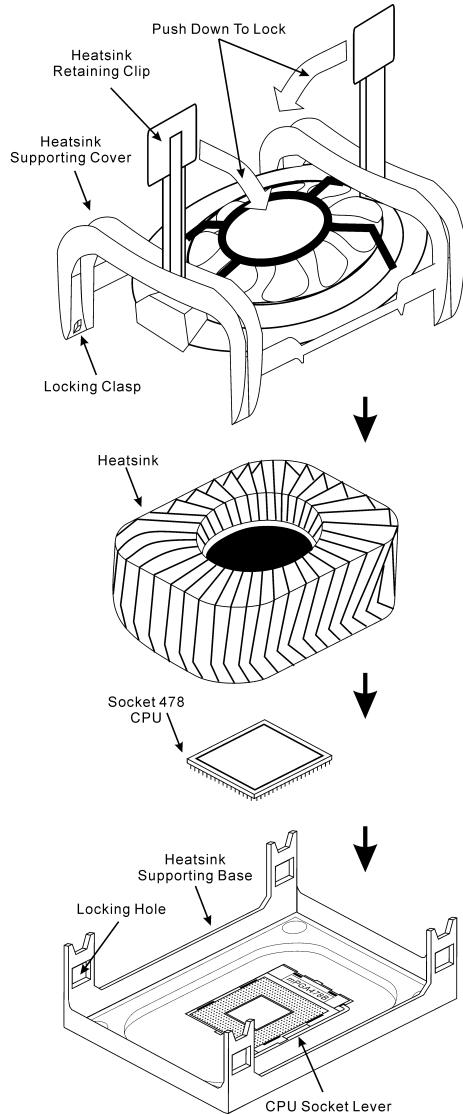

2-3. Install System Memory

This motherboard provides four 184-pin DDR DIMM slots for Single/Dual Channel DDR 400 memory modules with memory expansion size up to 4GB.

To reach the performance of Dual Channel DDR, the following rules must be obeyed:

- **When installing TWO DIMM modules:** Install DIMM modules of the same type and size for slots [DIMM1]+[DIMM3] or slots [DIMM2]+[DIMM4].
- **When installing FOUR DIMM modules:** Install DIMM modules of the same type and size for slots [DIMM1]+[DIMM3], and slots [DIMM2]+[DIMM4].

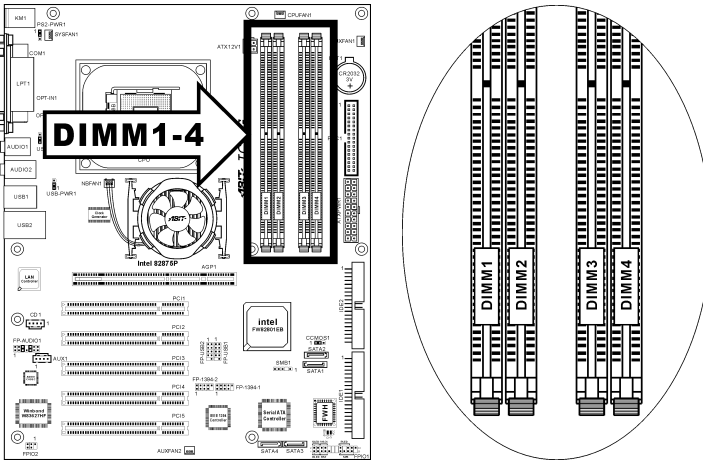

Table 2-1. Valid Memory Configurations

| Bank | Memory Module | Total Memory |
|----------------------------|----------------------|--------------|
| Bank 0, 1 (DIMM1) | 128, 256, 512MB, 1GB | 128MB ~ 1GB |
| Bank 2, 3 (DIMM2) | 128, 256, 512MB, 1GB | 128MB ~ 1GB |
| Bank 4, 5 (DIMM3) | 128, 256, 512MB, 1GB | 128MB ~ 1GB |
| Bank 6, 7 (DIMM4) | 128, 256, 512MB, 1GB | 128MB ~ 1GB |
| Total System Memory | | 128MB ~ 4GB |

NOTE: No hardware or BIOS setup required after adding or removing memory modules.

Power off the computer and unplug the AC power cord before installing or removing memory modules.

1. Locate the DIMM slot on the board.
2. Hold two edges of the DIMM module carefully, keep away of touching its connectors.
3. Align the notch key on the module with the rib on the slot.
4. Firmly press the module into the slots until the ejector tabs at both sides of the slot automatically snaps into the mounting notch. Do not force the DIMM module in with extra force as the DIMM module only fit in one direction.

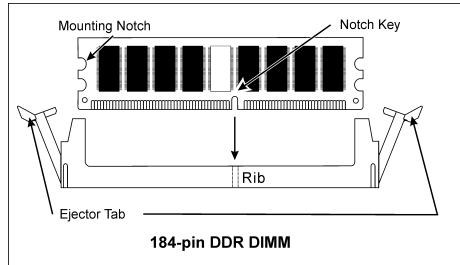

5. To remove the DIMM modules, push the two ejector tabs on the slot outward simultaneously, and then pull out the DIMM module.

ATTENTION: Static electricity can damage the electronic components of the computer or optional boards. Before starting these procedures, ensure that you are discharged of static electricity by touching a grounded metal object briefly.

2-4. Connectors, Headers and Switches

Here we will show you all of the connectors, headers and switches, and how to connect them. Please read the entire section for necessary information before attempting to finish all the hardware installation inside the computer chassis. A complete enlarged layout diagram is shown in Chapter 1 for all the position of connectors and headers on the board that you may refer to.

WARNING: Always power off the computer and unplug the AC power cord before adding or removing any peripheral or component. Failing to do so may cause severe damage to your motherboard and/or peripherals. Plug in the AC power cord only after you have carefully checked everything.

(1). ATX Power Input Connectors [ATXPWR1, ATX12V1]

The Pentium 4 requires a power supplier different from the regular one. It's a newly designed ATX12V power with 300W, 20A +5VDC capacity at least for heavily loaded system, and 720mA +5VSB at least for supporting Wake-On-LAN feature.

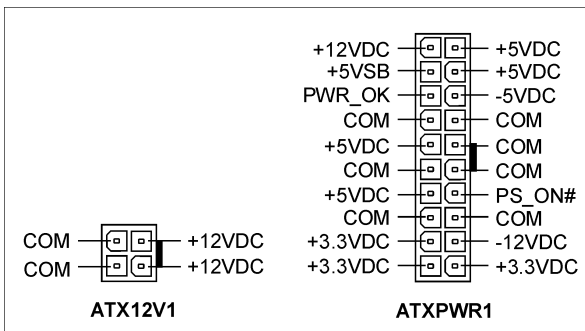
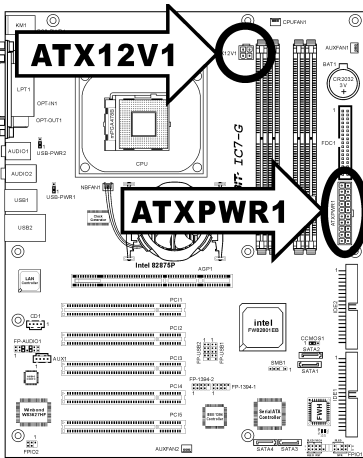

(2). FAN Connectors [CPUFAN1, NBFAN1, SYSFAN1, AUXFAN1, AUXFAN2]

These 3-pin connectors each provide power to the cooling fans installed in your system.

The CPU must be kept cool by using a powerful fan with heatsink. The system is capable of monitoring the speed of the CPU fan.

- **CPUFAN1:** CPU Fan
- **NBFAN1:** Chipset Fan
- **SYSFAN1:** System Fan
- **AUXFAN1, AUXFAN2:** Auxiliary Fan (No monitoring support in BIOS menu)

WARNING: These fan connectors are not jumpers. DO NOT place jumper caps on these connectors.

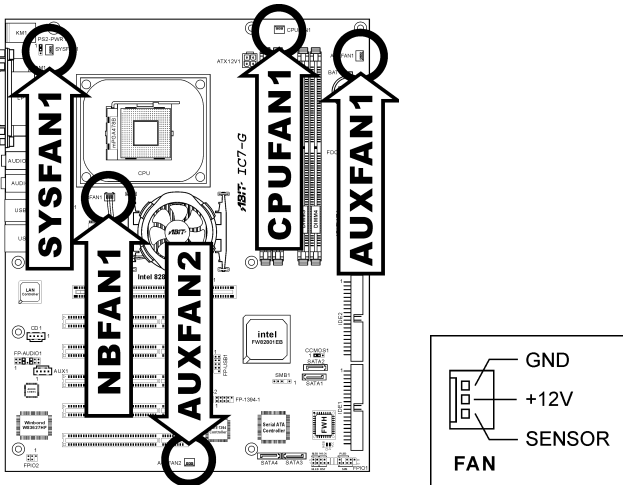

(3). CMOS Memory Clearing Header [CCMOS1]

This header uses a jumper cap to clear the CMOS memory.

- **Pin 1-2 shorted (default):** Normal operation.
- **Pin 2-3 shorted:** Clear CMOS memory.

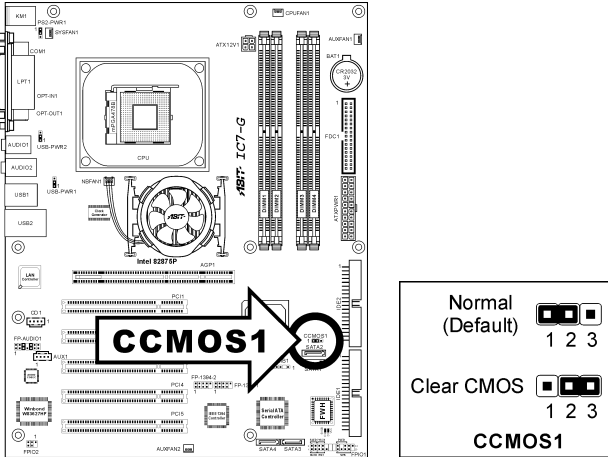

WARNING: Turn the power off first (including the +5V standby power) before clearing the CMOS memory. Failing to do so may cause your system to work abnormally or malfunction.

(4). Wake-up Header [PS2-PWR1, USB-PWR1, USB-PWR2]

These headers use a jumper cap to enable/disable the wake-up function.

- **PS2-PWR1:**
 Pin 1-2 shorted (default): Disable wake-up function support at Keyboard/Mouse port.
 Pin 2-3 shorted: Enable wake-up function support at Keyboard/Mouse port
- **USB-PWR1:**
 Pin 1-2 shorted (default): Disable wake-up function support at USB1 port.
 Pin 2-3 shorted: Enable wake-up function support at USB1 port.
- **USB-PWR2:**
 Pin 1-2 shorted (default): Disable wake-up function support at USB2 port.
 Pin 2-3 shorted: Enable wake-up function support at USB2 port

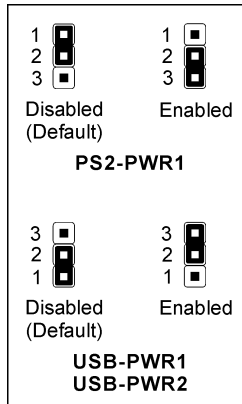
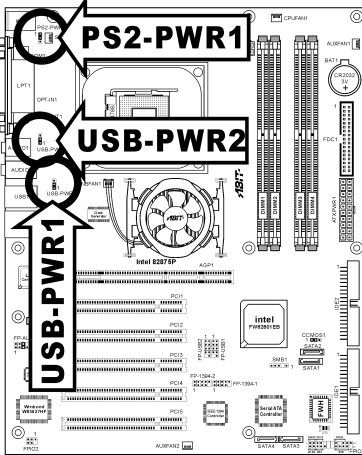

(5). Front Panel Switches & Indicators Headers [FPIO1]

This header is used for connecting switches and LED indicators on the chassis front panel.

Watch the power LED pin position and orientation. The mark “+” align to the pin in the figure below stands for positive polarity for the LED connection. Please pay attention to connect these headers. A wrong orientation will only cause the LED not lighting, but a wrong connection of the switches could cause system malfunction.

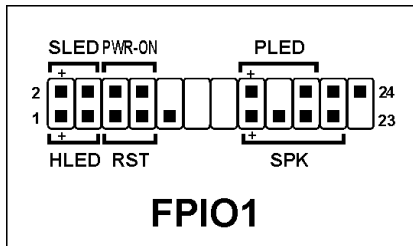
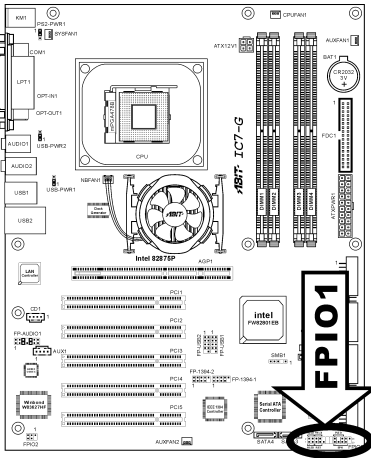

- **HLED (Pin 1, 3):**
Connects to the HDD LED cable of chassis front panel.
- **RST (Pin 5, 7):**
Connects to the Reset Switch cable of chassis front panel.
- **SPK (Pin 15, 17, 19, 21):**
Connects to the System Speaker cable of chassis.
- **SLED (Pin 2, 4):**
Connects to the Suspend LED cable (if there is one) of chassis front panel.
- **PWR-ON (Pin 6, 8):**
Connects to the Power Switch cable of chassis front panel.
- **PLED (Pin 16, 18, 20):**
Connects to the Power LED cable of chassis front panel.

(6). Infrared Device Header [FPIO2]

This header connects to an optional IR device attached to chassis. This motherboard supports standard IR transfer rates.

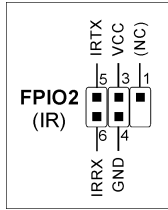
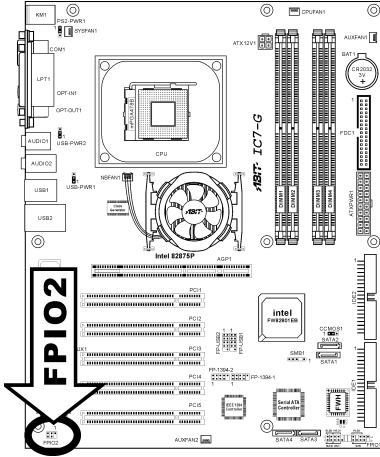

(7). Additional USB Port Headers [FP-USB1, FP-USB2]

These headers each provide 2 additional USB 2.0 ports connection through an USB cable designed for USB 2.0 specifications.

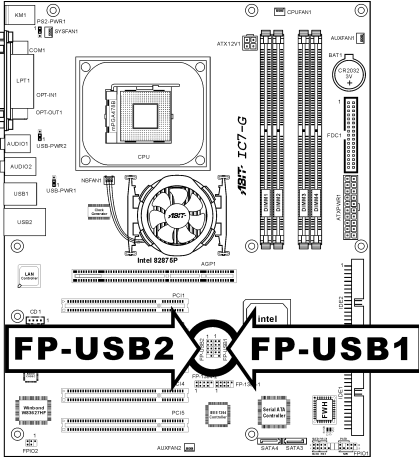

| <p>FP-USB1 FP-USB2</p> | Pin | Pin Assignment | Pin | Pin Assignment |
|--|-----|----------------|-----|----------------|
| | 1 | VCC | 2 | VCC |
| | 3 | Data0 - | 4 | Data1 - |
| | 5 | Data0 + | 6 | Data1 + |
| | 7 | Ground | 8 | Ground |
| | 9 | NC | 10 | NC |

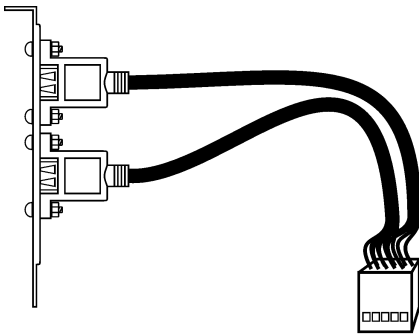

USB Header

(8). Additional IEEE1394 Port Header [FP-1394-1, FP-1394-2]

These headers each provide one additional IEEE1394 port connection through an extension cable and bracket.

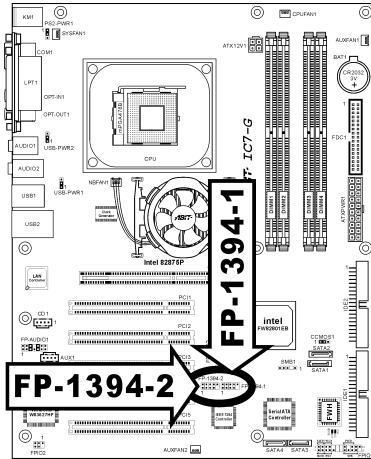

| Pin | Pin Assignment | Pin | Pin Assignment |
|-----|----------------|-----|----------------|
| 1 | TPA0 + | 2 | TPA0 - |
| 3 | GND | 4 | GND |
| 5 | TPB0 + | 6 | TPB0 - |
| 7 | +12V | 8 | +12V |
| 9 | NC | 10 | GND |

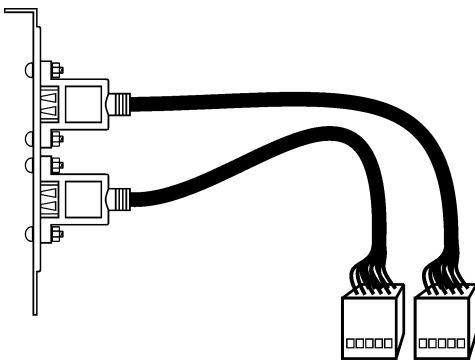

IEEE1394 Header

(9). Front Panel Audio Connection Header [FP-AUDIO1]

This header provides the connection to audio connector at front panel.

- To use the audio connector at front panel, remove all the jumpers on this header, and then connect to front panel by the extension cable provided with the chassis.
- To use the audio connector at rear panel, disconnect the extension cable, attach the jumpers back at pin 5-6, and pin 9-10 (default setting).

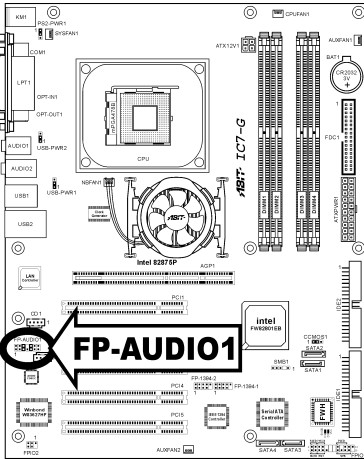

| Pin | Pin Assignment | Pin | Pin Assignment |
|-----|---------------------------|-----|----------------------------------|
| 1 | Audio Mic. | 2 | Ground |
| 3 | Audio Mic. Bias | 4 | VCC |
| 5 | Speaker Out Right Channel | 6 | Speaker Out Right Channel Return |
| 7 | X | 8 | NC |
| 9 | Speaker Out Left Channel | 10 | Speaker Out Left Channel Return |
| 11 | Ground | 12 | S/PDIF In |
| 13 | VCC | 14 | S/PDIF Out |

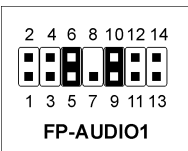

(10). System Management Bus Headers [SMB1]

This header is reserved for system management bus (SM bus). The SM bus is a specific implementation of an I²C bus. I²C is a multi-master bus, which means that multiple chips can be connected to the same bus and each one can act as a master by initiating a data transfer. If more than one master simultaneously tries to control the bus, an arbitration procedure decides which master gets priority.

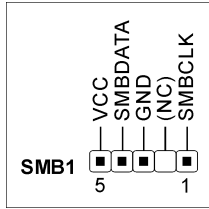
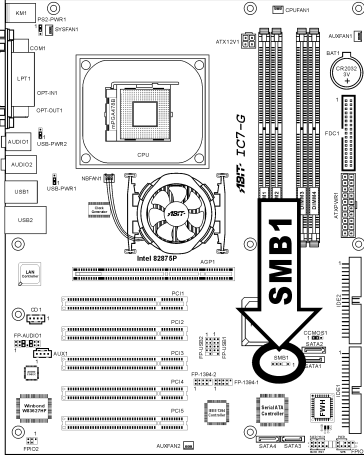

(11). Internal Audio Connectors [CD1, AUX1]

These connectors connect to the audio output of internal CD-ROM drive or add-on card.

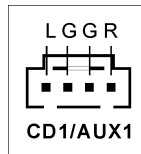
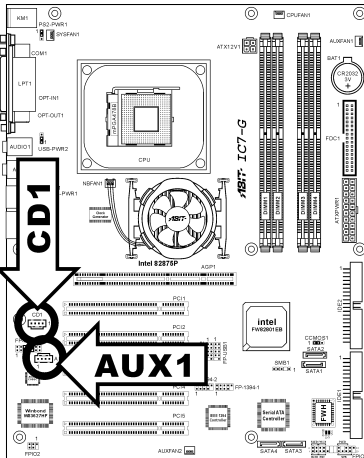

(12). Accelerated Graphics Port Slot [AGP1]

This motherboard provides an “AGP Pro 50” slot with up to AGP8X support.

To install an “AGP Pro 50” compliant card, the small plastic retention piece located in the AGP1 slot must be removed first (simply by your fingertips, and keep it for future use).

NOTE: Remove this plastic retention piece only when installing the “AGP Pro 50” compliant card. To install a regular VGA card will require this retention piece back in its original position to keep the VGA card from sliding back and forth, or even damage the VGA card and/or motherboard.

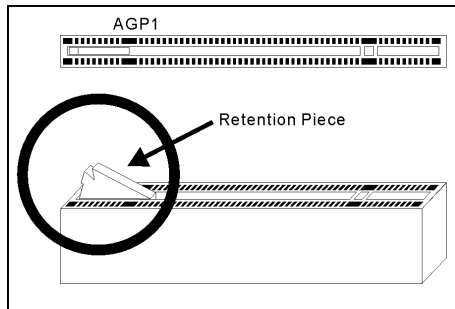
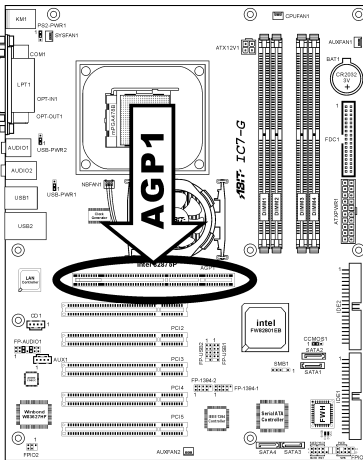

ATTENTION: This motherboard does not support 3.3V AGP cards. Use only 1.5V or 0.8V AGP cards.

(13). Floppy Disk Drive Connector [FDC1]

This connector supports two standard floppy disk drives via a 34-pin 34-conductor ribbon cable.

Connecting the Floppy Disk Drive Cable:

1. Install one end of the ribbon cable into the FDC1 connector. The colored edge of the ribbon cable should be aligned with pin-1 of FDC1 connector.
2. Install the other end(s) of ribbon cable into the disk drive connector(s). The colored edge of the ribbon cable should be also aligned with pin-1 of disk drive connector. The endmost connector should be attached to the drive designated as Drive A.

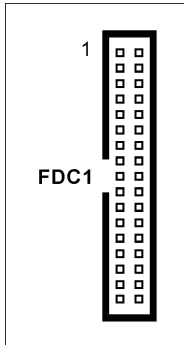
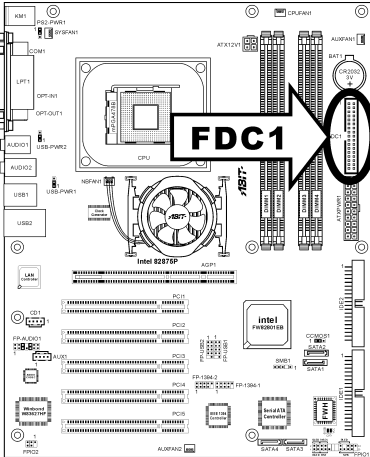

(14). IDE Connectors [IDE1, IDE2]

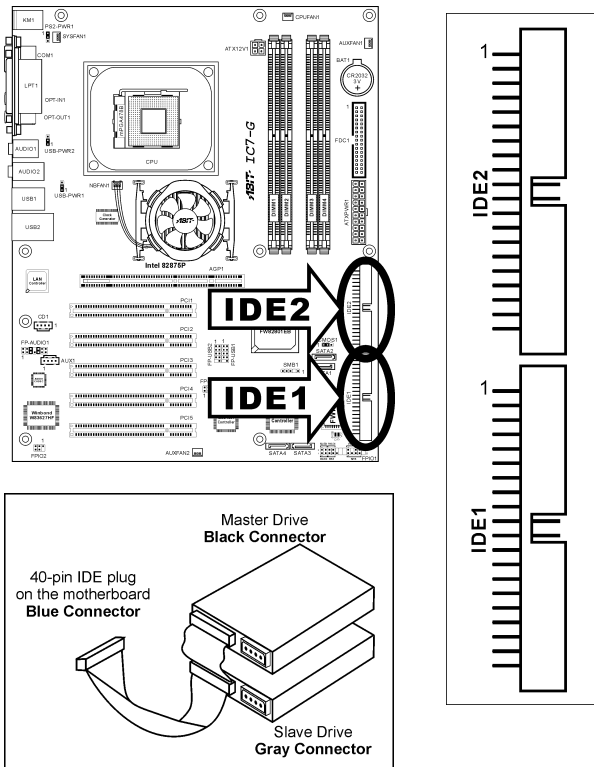

This motherboard provides two IDE ports to connect up to four IDE drives at Ultra ATA/100 mode by Ultra ATA/66 ribbon cables. Each cable has 40-pin 80-conductor and three connectors, providing two hard drives connection with motherboard. Connect the single end (blue connector) at the longer length of ribbon cable to the IDE port on motherboard, and the other two ends (gray and black connector) at the shorter length of the ribbon cable to the connectors on hard drives.

If you want to connect two hard drives together through one IDE channel, you must configure the second drive to Slave mode after the first Master drive. Please refer to the drives' documentation for jumper settings. The first drive connected to IDE1 is usually referred to as "Primary Master", and the second drive as "Primary Slave". The first drive connected to IDE2 is referred to as "Secondary Master" and the second drive as "Secondary Slave".

Keep away from connecting one legacy slow speed drive, like CD-ROM, together with another hard drive on the same IDE channel; this will drop your integral system performance.

(15). Serial ATA Connectors [SATA1~SATA4]

These connectors are provided to attach one Serial ATA device at each channel via Serial ATA cable. It is also possible to connect legacy IDE hard disk through an optional SERILLEL2 Converter.

SATA1 and SATA2 are controlled by ICH5R South Bridge. To enable the SATA1 and SATA2 controller, you have to enable the item “OnChip Serial ATA” first in the BIOS menu of “OnChip IDE Device”.

SATA3 and SATA4 are controlled by Silicon Image PCI Chip. To enable the SATA3 and SATA4 controller, you have to enable the item “Serial ATA Controller” first in the BIOS menu of “Onboard PCI Device”.

For more information on how to configure the function mode for SATA1 and SATA2, please refer to the item “Serial ATA 1 Mode” and “Serial ATA 2 Mode” in the BIOS menu of “OnChip IDE Device”.

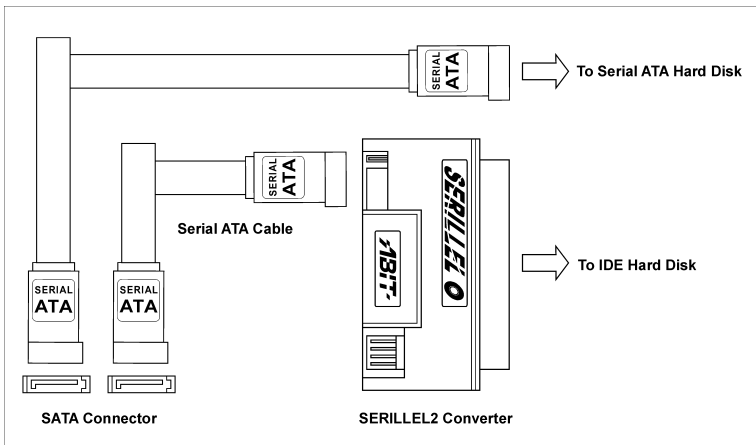
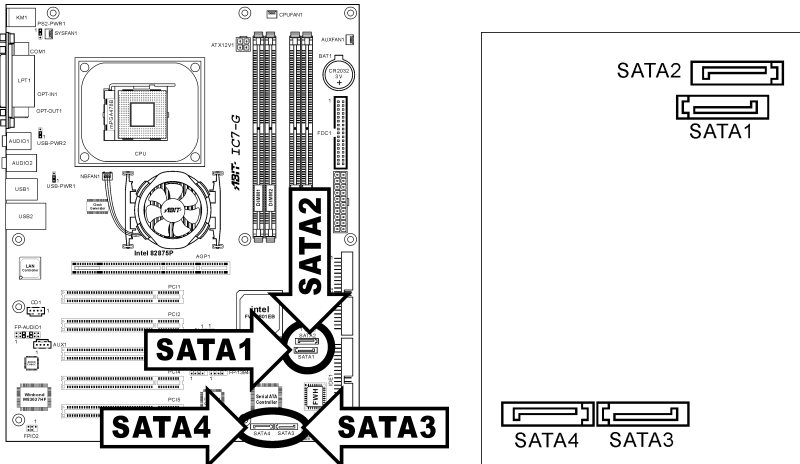

NOTE: The Serial ATA controller only supports Ultra DMA/ATA100 or higher hard drive. Do not use hard drives under this specification, or it won't work.

(16). Status Indicators [D1, D2]

- **D1 (VCC):** This LED lights up when the system power is on.
- **D2 (5VSB):** This LED lights up when the power supply is connected with power source.

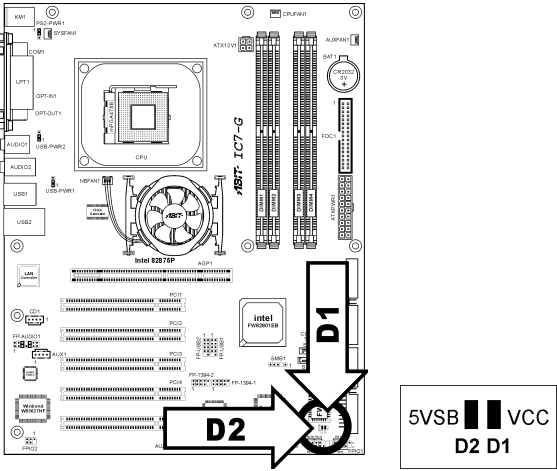

(17). **Back Panel Connectors [Mouse, Keyboard, LPT1, COM1, OPT-IN1, OPT-OUT1, AUDIO1, AUDIO2, IEEE1394/USB1, LAN/USB2]**

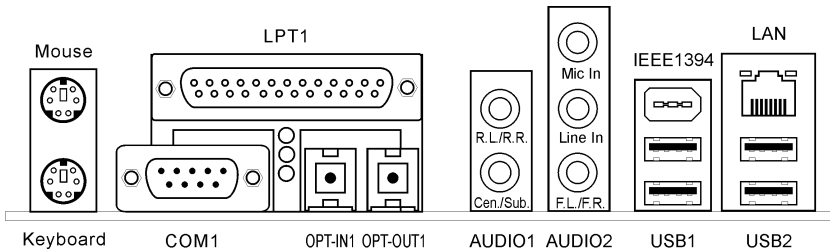

- **Mouse:** Connects to PS/2 mouse.
- **Keyboard:** Connects to PS/2 keyboard.
- **LPT1:** Connects to printer or other devices that support this communication protocol.
- **COM1:** Connects to external modem, mouse or other devices that support this communication protocol.
- **OPT-IN1:** This connector provides an S/PDIF in connection through optical fiber to digital multimedia devices.
- **OPT-OUT1:** This connector provides an S/PDIF out connection through optical fiber to digital multimedia devices.
- **AUDIO1:**
R.L./R.R. (Rear Left / Rear Right): Connects to the rear left and rear right channel in the 5.1 channel audio system.
Cen./Sub. (Center / Subwoofer): Connects to the center and subwoofer channel in the 5.1 channel audio system.
- **AUDIO2:**
Mic In: Connects to the plug from external microphone.
Line In: Connects to the line out from external audio sources.
F.L./F.R. (Front Left / Front Right): Connects to the front left and front right channel in the 5.1-channel or regular 2-channel audio system.
- **IEEE1394:** Connects to devices of IEEE1394 protocol.
- **LAN:** Connects to Local Area Network.
- **USB1/USB2:** Connects to USB devices such as scanner, digital speakers, monitor, mouse, keyboard, hub, digital camera, joystick etc.

Chapter 3. BIOS Setup

This motherboard provides a programmable EEPROM that you can update the BIOS utility. The BIOS (Basic Input/Output System) is a program that deals with the basic level of communication between processor and peripherals. Use the BIOS Setup program only when installing motherboard, reconfiguring system, or prompted to “Run Setup”. This chapter explains the Setup Utility of BIOS utility.

After powering up the system, the BIOS message appears on the screen, the memory count begins, and then the following message appears on the screen:

PRESS DEL TO ENTER SETUP

If this message disappears before you respond, restart the system by pressing <Ctrl> + <Alt> + keys, or by pressing the Reset button on computer chassis. Only when it failed by these two methods can you restart the system by powering it off and then back on.

After pressing key, the main menu screen appears.

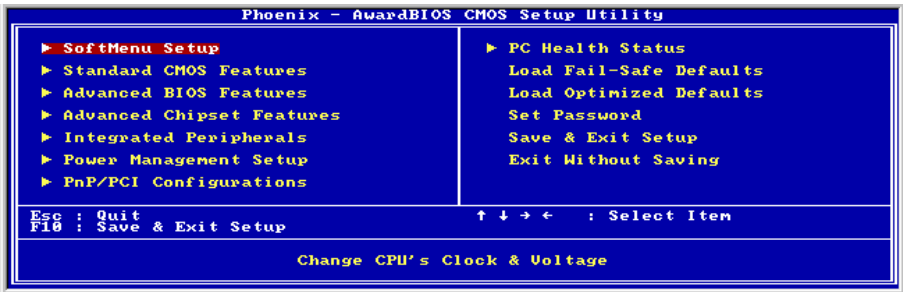

NOTE: In order to increase system stability and performance, our engineering staffs are constantly improving the BIOS menu. The BIOS setup screens and descriptions illustrated in this manual are for your reference only, may not completely match what you see on your screen.

3-1. SoftMenu Setup

The SoftMenu utility is ABIT's exclusive and ultimate solution in programming the CPU operating speed. All the parameters regarding CPU FSB speed, multiplier factor, the AGP & PCI clock, and even the CPU core voltage are all available at your fingertips.



Brand Name:

This item displays the CPU model name, for example: Intel Pentium (R) 4.

Frequency:

This item displays the processor speed.

Cache Size:

This item displays the L2 cache size of your CPU.

CPU Operating Speed:

This item displays the CPU operating speed according to the type and speed of your CPU. You can also select the [User Define] option to enter the manual option.

User Define:

WARNING: The wrong settings of the multiplier and external clock in certain circumstances may cause CPU damage. Setting the working frequency higher than the PCI chipset or processor specs, may cause abnormal memory module functioning, system hangs, hard disk drive data lose, abnormal functioning of the VGA card, or abnormal functioning with other add-on cards. Using non-specification settings for your CPU is not the intention of this explanation. These should be used for engineering testing, not for normal applications.

There will be no guaranty for the settings beyond specification, any damage of any component on this motherboard or peripherals result therein is not our responsibility.

* **Ext. Clock (CPU/AGP/PCI):**

This item selects the external clock frequency.

*** Multiplier Factor:**

This item selects the multiplier factors for your CPU if it is not locked.

*** Estimated new CPU clock:**

This item displays the frequency sum up from the previous item [Ext. Clock] and [Multiplier Factor].

*** N/B Strap CPU As:**

This item sets the external hardware reset strap assigned to MCH (Memory Controller Hub). The options are: [PSB400], [PSB533], [PSB800], [PSB667], and [By CPU]. The default setting is **By CPU**.

To set this option manually:

- Select [PSB400] for CPU of 100MHz FSB frequency.
- Select [PSB533] for CPU of 133MHz FSB frequency.
- Select [PSB800] for CPU of 200MHz FSB frequency.
- Select [PSB667] for CPU of 166MHz FSB frequency.

*** DRAM Ratio (CPU:DRAM):**

This item determines the frequency ratio between CPU and DRAM.

*** AGP Ratio (CPU:AGP:PCI):**

This item determines the ratio among CPU, AGP, and DRAM.

*** Fixed AGP/PCI Frequency:**

This item determines the AGP/PCI bus frequency. This option allows you to keep your AGP/PCI clock at some fixed frequency to improve system stability.

CPU Power Supply:

This option allows you to switch between CPU default and user-defined voltages. Leave this setting to default unless the current CPU type and voltage setting cannot be detected or is not correct. The option “**User Define**” enables you to select the Core Voltage manually.

*** CPU Core Voltage:**

This item selects the CPU core voltage.

ATTENTION: A wrong voltage setting may cause the system unstable or even damage the CPU. Please leave it to default settings unless you are fully aware of its consequences.

DDR SDRAM Voltage:

This item selects the voltage for DRAM slot.

AGP Voltage:

This item selects the voltage for AGP slot.

3-2. Standard CMOS Features

This section contains the basic configuration parameters of the BIOS. These parameters include date, hour, VGA card, FDD and HDD settings.



Figure 3-3. Standard CMOS Setup Screen Shot

Date (mm:dd:yy):

This item sets the date you specify (usually the current date) in the format of [Month], [Date], and [Year].

Time (hh:mm:ss):

This item sets the time you specify (usually the current time) in the format of [Hour], [Minute], and [Second].

↳ IDE Primary Master/Slave, IDE Secondary Master/Slave:

Click <Enter> key to enter its submenu:



IDE HDD Auto-Detection:

This item allows you to detect the parameters of IDE drives by pressing <Enter> key. The parameters will be shown on the screen automatically.

IDE Primary/Secondary Master/Slave

When set to [Auto], the BIOS will automatically check what kind of IDE drive you are using. If you want to define your own drive by yourself, set it to [Manual] and make sure you fully understand the meaning of the parameters. Please refer to the instruction manual provided by the device's manufacturer to get the setting right.

Access Mode:

This item selects the mode to access your IDE devices. Leave this item to its default [Auto] setting to detect the access mode of your HDD automatically.

Capacity:

This item displays the approximate capacity of the disk drive. Usually the size is slightly greater than the size of a formatted disk given by a disk-checking program.

Cylinder:

This item configures the numbers of cylinders.

Head:

This item configures the numbers of read/write heads.

Precomp:

This item displays the number of cylinders at which to change the write timing.

Landing Zone:

This item displays the number of cylinders specified as the landing zone for the read/write heads.

Sector:

This item configures the numbers of sectors per track.

 **Back to Standard CMOS Features Setup Menu:**

Drive A & Drive B:

This item sets the type of floppy drives (usually only Drive A) installed.

Floppy 3 Mode Support:

This item allows you to use "3 Mode Floppy Drive" in Japanese computer system by selecting drive A, B, or both. Leave this item to its default [Disabled] setting if you are not using this Japanese standard floppy drive.

Video:

This item selects the type of video adapter used for the primary system monitor.

[EGA/VGA]: (Enhanced Graphics Adapter/Video Graphics Array) For EGA, VGA, SVGA and PGA monitor adapters.

[CGA 40]: (Color Graphics Adapter) Power up in 40-column mode.

[CGA 80]: (Color Graphics Adapter) Power up in 80-column mode.

[Mono]: (Monochrome adapter) Includes high-resolution monochrome adapters.

Halt On:

This item determines whether the system stops if an error is detected during system boot-up.

[All Errors]: The system-boot will stop whenever the BIOS detect a non-fatal error.

[No Errors]: The system-boot will not stop for any error detected.

[All, But Keyboard]: The system-boot will stop for all errors except a keyboard error.

[All, But Diskette]: The system-boot will stop for all errors except a diskette error.

[All, But Disk/Key]: The system-boot will stop for all errors except a diskette or keyboard error.

Base Memory:

This item displays the amount of base memory installed in the system. The value of the base memory is typically 640K for system with 640K or more memory size installed on the motherboard.

Extended Memory:

This item displays the amount of extended memory detected during system boot-up.

Total Memory:

This item displays the total memory available in the system.

3-3. Advanced BIOS Features



Virus Warning:

When set to [Enabled], the BIOS will monitor the boot sector and partition table of the hard disk drive. If there is any attempt of writing to the boot sector or partition table of the hard disk drive, the BIOS will halt the system and an error message will appear.

Hyper-Threading Technology

This option enables or disables the processor's Hyper-Threading Technology

Leave this item to its default setting to enable the simultaneous multi-threaded (SMT) processor so as to make one physical processor look like two logical processors to the OS and applications.

This option is for CPU with Hyper-Threading Technology only. For more information on "Hyper-Threading Technology", please visit Intel Web site at <http://www.intel.com/homepage/land/hyperthreading.htm> , <http://www.intel.com/design/chipsets/ht/>.

Quick Power On Self Test:

When set to [Enabled], this item speeds up the Power On Self Test (POST) after powering on the system. The BIOS shorten or skip some check during the POST.

Hard Disk Boot Priority:

This item selects the hard disks booting priority. By pressing <Enter> key, you can enter its submenu where the hard disks detected can be selected for the booting sequence to boot up system.

This item functions only when there is the option of [Hard Disk] in any one of the First/Second/Third Boot Device items.

First Boot Device / Second Boot Device / Third Boot Device / Boot Other Device:

Select the drive to boot first, second and third in the [First Boot Device], [Second Boot Device], and [Third Boot Device] items respectively. The BIOS will boot the operating system according to the sequence of the drive selected. Set [Boot Other Device] to [Enabled] if you wish to boot from another device other than these three items.

Swap Floppy Drive:

When set to [Enabled], and the system is booting from the floppy drive, the system will boot from drive B instead of the regular drive A. There must be two floppy drives connected in the system to use this function.

Boot Up Floppy Seek:

When set to [Enabled], the BIOS will check whether the floppy disk drive is installed or not.

Boot Up NumLock Status:

This item determines the default state of the numeric keypad at system booting up.

[On]: The numeric keypad functions as number keys.

[Off]: The numeric keypad functions as arrow keys.

Security Option:

This item determines when the system will prompt for password - every time the system boots or only when enters the BIOS setup.

[Setup]: The password is required only when accessing the BIOS Setup.

[System]: The password is required each time the computer boots up.

NOTE: Don't forget your password. If you forget the password, you will have to open the computer case and clear all information in the CMOS before you can start up the system. But by doing this, you will have to reset all previously set options.

APIC Mode:

Leave this item to its default setting.

MPS Version Ctrl For OS:

This item specifies which version of MPS (Multi-Processor Specification) this motherboard will use. The options are 1.1 and 1.4. The default setting is *1.4*. If you use an older OS for dual processor executing, please set this option to 1.1.

OS Select For DRAM > 64MB:

This item allows you to access the memory that is over 64MB in OS/2. Leave this item to its default [Non-OS2] setting for operating system other than OS/2.

Report No FDD For OS:

When set to [Yes], this item allows you to run some older operating system without floppy disk drive. Leave this item to its default setting.

Delay IDE Initial (Secs):

This item allows the BIOS to support some old or special IDE devices by prolonging this delay time. A larger value will give more delay time to the device for which to initialize and to prepare for activation.

PCI Card Support for SMBus:

This option enables or disables the SMBus function on PCI slots for PCI 2.3 specification.

Disable Unused PCI Clock:

This option disables the clock of PCI slot that is not in use.

[Yes]: The system automatically detect the unused DIMM and PCI slots, and stop sending clock signal to these unused PCI slots.

[No]: The system always send clock signal to all PCI slots.

NOTE: Set this option to [No] setting if there are adapters that cannot be automatically detected by the system and will cause malfunction.

3-4. Advanced Chipset Features



DRAM Timing Selectable:

This item sets the optimal timings for the following four items, depending on the memory module you are using. The default setting “By SPD” configures these four items by reading the contents in the SPD (Serial Presence Detect) device. The EEPROM on the memory module stores critical parameter information about the module, such as memory type, size, speed, voltage interface, and module banks.

* CAS Latency Time:

This item controls the latency between the DRAM read command and the time that the data becomes actually available.

* Act to Precharge Delay:

This item controls the number of DRAM clocks used for the DRAM parameters.

* DRAM RAS# to CAS# Delay

This item controls the latency between the DRAM active command and the read/write command.

* DRAM RAS# Precharge:

This item controls the idle clocks after issuing a precharge command to the DRAM.

System BIOS Cacheable:

When set to [Enabled], accesses to the system BIOS ROM addressed at F0000H-FFFFFH are cached, provided that the cache controller is enabled. The larger the range of the Cache RAM, the higher the efficiency of the system will be.

Video BIOS Cacheable:

As with caching the system BIOS, enabling the Video BIOS cache will allow access to video BIOS addressed at C0000H to C7FFFH to be cached, if the cache controller is also enabled. The larger the range of the Cache RAM, the faster the video performance will be.

Memory Hole At 15M-16M:

When set to [Enabled], the memory address space at 15M-16M will be reserved for ISA expansion cards

that specifically requires this setting. This makes the memory from 15MB and up unavailable to the system. Leave this item to its default setting.

Delay Prior to Thermal:

This item selects the delay time before thermal activation.

AGP Aperture Size:

This option specifies the amount of system memory that can be used by the AGP device. The aperture is a portion of the PCI memory address range dedicated for graphics memory address space.

Init Display First:

This item selects to initialize AGP or PCI Slot first when the system boots.

[AGP]: When the system boots, it will first initialize AGP.

[PCI Slot]: When the system boots, it will first initialize PCI.

Memory Parity Check:

This item allows the BIOS to check the memory is parity module or not.

AGP Data Rate Capability:

This item selects the data transfer rate of AGP device. A higher rate delivers faster and better graphics to your system. Make sure your graphics card supports the mode you select.

3-5. Integrated Peripherals



↳ OnChip IDE Device:

Click <Enter> key to enter its submenu:



IDE HDD Block Mode:

This item determines to use the Block Mode for IDE HDD.

[Enabled]: The IDE HDD supports block mode.

[Disabled]: The IDE HDD supports standard mode.

OnChip IDE-1 Controller:

This item allows you to enable or disable the primary and secondary IDE controller. Select [Disabled] if you want to add a different hard drive controller.

* Master/Slave Drive PIO Mode

The PIO (Programmed Input/Output) mode allows the BIOS to tell the controller what it wants and then let the controller and the CPU perform the complete task, rather than having the BIOS issue a series of commands to affect a transfer to or from the disk drive.

[Auto]: The BIOS will select the best available mode after checking your disk drive.

[Mode 0-4]: You can select a mode that matches your disk drive's timing. Do not use the wrong setting or you will have drive errors.

✱ **Master/Slave Drive Ultra DMA**

This item allows you to set the Ultra DMA in use.

[Auto]: The BIOS will select the best available option after checking your hard drive or CD-ROM.

[Disabled]: The BIOS will not detect these categories. If problem arises in using Ultra DMA devices, try disabling this item.

OnChip IDE-2 Controller:

The description is same as the *OnChip IDE-1 Controller*.

OnChip Serial ATA:

This option enables or disables the SATA controller of ICH5R South Bridge.

✱ **Serial ATA 1 Mode / Serial ATA 2 Mode:**

This item determines the function mode for Serial ATA Port 1 (i.e. The SATA1 connector in this model) and Serial ATA Port 2 (i.e. The SATA2 connector in this model). Both SATA1 and SATA2 will be served each as one single IDE connector after selected as the following modes:

| | Serial ATA Port 1 (SATA1) | Serial ATA Port 2 (SATA2) | Description |
|--------|--------------------------------------|--------------------------------------|---|
| Mode 1 | IDE-1 Master | IDE-1 Slave | <ul style="list-style-type: none"> • SATA1 serves as IDE-1 Master • SATA2 serves as IDE-1 Slave • OnChip IDE-1 controller disabled |
| Mode 2 | IDE-1 Slave | IDE-1 Master | <ul style="list-style-type: none"> • SATA1 serves as IDE-1 Slave • SATA2 serves as IDE-1 Master • OnChip IDE-1 controller disabled |
| Mode 3 | IDE-2 Master | IDE-2 Slave | <ul style="list-style-type: none"> • SATA1 serves as IDE-2 Master • SATA2 serves as IDE-2 Slave • OnChip IDE-2 controller disabled |
| Mode 4 | IDE-2 Slave | IDE-2 Master | <ul style="list-style-type: none"> • SATA1 serves as IDE-2 Slave • SATA2 serves as IDE-2 Master • OnChip IDE-2 controller disabled |
| Mode 5 | Logical IDE-1 | Logical IDE-2 | <ul style="list-style-type: none"> • SATA1 serves as IDE-1 • SATA2 serves as IDE-2 • OnChip IDE-1 and IDE-2 controller disabled |
| Mode 6 | Logical IDE-2 | Logical IDE-1 | <ul style="list-style-type: none"> • SATA1 serves as IDE-2 • SATA2 serves as IDE-1 • OnChip IDE-1 and IDE-2 controller disabled |
| Mode 7 | IDE-3 Master | IDE-4 Master | <ul style="list-style-type: none"> • SATA1 serves as IDE-3 Master • SATA2 serves as IDE-4 Master • OnChip IDE-1 and IDE-2 controller enabled |
| Mode 8 | IDE-4 Master | IDE-3 Master | <ul style="list-style-type: none"> • SATA1 serves as IDE-4 Master • SATA2 serves as IDE-3 Master • OnChip IDE-1 and IDE-2 controller enabled |

✱ **RAID Function:**

This option enables or disables the SATA RAID function of ICH5R South Bridge.

ATTENTION: This item is only available when both the items “Serial ATA 1 Mode” and “Serial ATA 2 Mode” are selected as [IDE-3 Master] / [IDE-4 Master] or [IDE-4 Master] / [IDE-3 Master].

↵ **OnChip PCI Device:**

Click <Enter> key to enter its submenu:

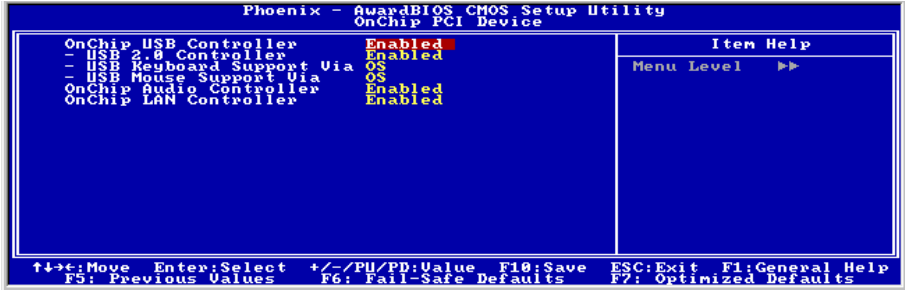

OnChip USB Controller:

This option enables or disables the USB controller.

✱ **USB 2.0 Controller:**

This option enables or disables the USB 2.0 controller.

✱ **USB Keyboard Support Via:**

This item allows you to select [BIOS] for using USB keyboard in DOS environment, or [OS] in OS environment.

✱ **USB Mouse Support Via:**

This item allows you to select [BIOS] for using USB mouse in DOS environment, or [OS] in OS environment.

OnChip Audio Controller:

This option enables or disables the audio controller.

OnChip LAN Controller:

This option enables or disables the LAN controller.

SuperIO Device:

Click <Enter> key to enter its submenu:



Onboard FDC Controller:

This option enables or disables the onboard FDC controller.

Onboard Serial Port 1 / Onboard Serial Port 2:

This item determines which I/O addresses the onboard Serial Port 1 & 2 controller will access.

[Auto]: The system automatically select an I/O address for the onboard Serial Port 1 & 2.

[3F8/COM1, 2F8/COM2, 3E8/COM3, 2E8/COM4]: Allows you to manually select an I/O address for the onboard Serial Port 1 & 2.

[Disabled]: Disables the onboard Serial Port 1 and/or 2.

* **UART Mode Select:**

This item selects the Infrared (IR) function mode.

* **RxD, TxD Active:**

This item sets the IR transmission/reception polarity.

* **IR Transmission Delay:**

This option enables or disables the IR transmission delay. When set to [Enabled], the transmission will be slower. This is recommended when transmission problem arise.

* **UR2 Duplex Mode:**

This item selects the duplex mode required by the IR device connected to the IR port. Full-duplex mode permits simultaneous two-direction transmission. Half-duplex mode permits transmission in one direction only at a time. Refer to your IR KIT user's guide to find out which setting is correct.

Onboard Parallel Port:

This item specifies the I/O address used by the parallel port.

[Disabled]: This option prevents the parallel port from accessing any system resources. When the value of this option is set to [Disabled], the printer port becomes unavailable.

[378]: This option allows the parallel port to use 378 as its I/O port address. The majority of parallel ports on computer systems use IRQ7 and I/O Port 378H as the standard setting.

[278]: This option allows the parallel port to use 278 as its I/O port address.

[3BC]: This option allows the parallel port to use 3BC as its I/O port address.

✱ **Parallel Port Mode:**

This item specifies the parallel port mode.

[Normal]: Allows the standard parallel port mode to be used.

[SPP]: (Standard Parallel Port) Allows bi-directional parallel port operation at normal speed.

[EPP]: (Enhanced Parallel Port) Allows bi-directional parallel port operation at maximum speed.

[ECP]: (Extended Capabilities Port) Allows bi-directional parallel port operation at a speed faster than the normal mode's data transfer rate.

✱ **EPP Mode Select:**

This item selects the EPP mode.

✱ **ECP Mode Use DMA:**

This item selects the DMA channel of the parallel port.

↳ **Onboard PCI Device:**

Click <Enter> key to enter its submenu:

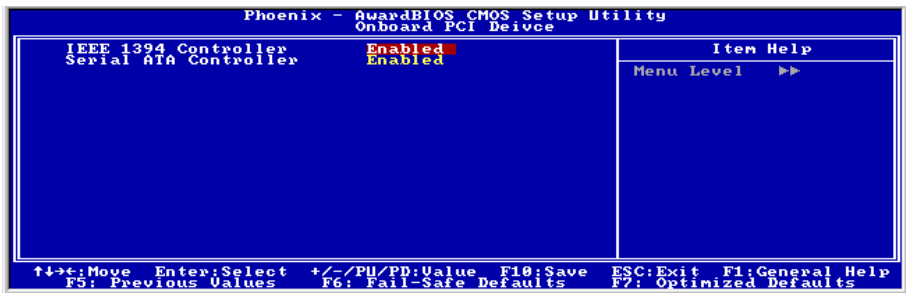

IEEE 1394 Controller:

This option enables or disables the IEEE 1394 controller.

Serial ATA Controller:

This option enables or disables the Serial ATA controller of Silicon Image PCI Chip

3-6. Power Management Setup

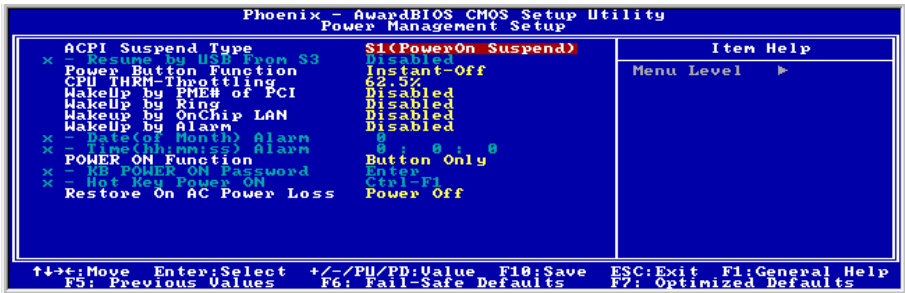

ACPI Suspend Type:

This item selects the type of Suspend mode.

[S1(POS)]: Enables the Power On Suspend function.

[S3(STR)]: Enables the Suspend to RAM function.

[Auto]: Automatically select the type of suspend mode.

Resume by USB From S3:

When set to [Enabled], this item allows you to use a USB device to wake up a system that is in the S3 (STR - Suspend To RAM) state. This item can be configured only if the item “ACPI Suspend Type” is set to [S3(STR)].

Power Button Function:

This item selects the method of powering off your system:

[Delay 4 Sec.]: Pushing the power button for more than 4 seconds will power off the system. This will prevent the system from powering off in case you accidentally hit or pushed the power button.

[Instant-Off]: Pressing and then releasing the power button at once will immediately power off the system.

CPU THRM-Throttling

This item controls the CPU speed by cutting down its regular power to a percentage during the STR (Suspend To RAM) state.

WakeUp by PME# of PCI:

When set to [Enabled], access to the onboard LAN or a PCI card such as a modem or LAN card will cause the system to wake up. The PCI card must support the wake up function.

WakeUp by Ring:

When set to [Enabled], telephone calls coming through an external or internal modem will power-on your system.

WakeUp by OnChip Lan:

When set to [Enabled], you can remotely wake up a PC in Soft-Off condition via a LAN card that support the wake up function.

WakeUp by Alarm:

When set to [Enabled], you can set the date and time you would like the Soft-Off PC to power-on in the “**Date (of Month) Alarm**” and “**Time (hh:mm:ss) Alarm**” items. However, if the system is being accessed by incoming calls or the network (Resume On Ring/LAN) prior to the date and time set in these items, the system will give priority to the incoming calls or network instead.

※ **Date (of Month) Alarm**

[0]: This option power-on the system everyday according to the time set in the “Time (hh:mm:ss) Alarm” item.

[1-31]: This option selects a date you would like the system to power-on. The system will power-on on the date set, and the time set in the “Time (hh:mm:ss) Alarm” item.

※ **Time (hh:mm:ss) Alarm**

This item sets the time you would like the system to power-on.

POWER ON Function:

This item selects the way you want your system to power on.

[**Password**]: Use a password to power on the system, select this option then press <Enter>. Enter your password. You can enter up to 5 characters. Type in exactly the same password to confirm, and then press <Enter>.

[**Hot Keys**]: Use any of the function keys between <F1> to <F12> to power on the system.

[**Mouse Left**]: Double click the mouse left button to power on the system.

[**Mouse Right**]: Double click the mouse right button to power on the system.

[**Any Key**]: Use any keyboard keys to power on the system.

[**Button Only**]: Use only the power button to power on the system.

[**Keyboard 98**]: Use the power-on button on the “Keyboard 98” compatible keyboard to power on the system.

NOTE: The mouse wake up function can only be used with the PS/2 mouse, not with the COM port or USB type. Some PS/2 mice cannot wake up the system because of compatible problems. If the specs of your keyboard are too old, it may fail to power on.

※ **KB Power ON Password:**

This item sets the password required in order to power on your computer.

NOTE: Do not forget your password, or you will have to clear the CMOS and reset all parameters in order to utilize this function again.

※ **Hot Key Power ON:**

This item powers on the system by pressing <Ctrl> key plus one of each function key (<F1> ~ <F12>) simultaneously.

Restore On AC Power Loss:

This item selects the system action after an AC power failure.

[Power Off]: When power returns after an AC power failure, the system's power remains off. You must press the Power button to power-on the system.

[Power On]: When power returns after an AC power failure, the system's power will be powered on automatically.

[Last State]: When power returns after an AC power failure, the system will return to the state where you left off before power failure occurs. If the system's power is off when AC power failure occurs, it will remain off when power returns. If the system's power is on when AC power failure occurs, the system will power-on when power returns.

3-7. PnP/PCI Configurations

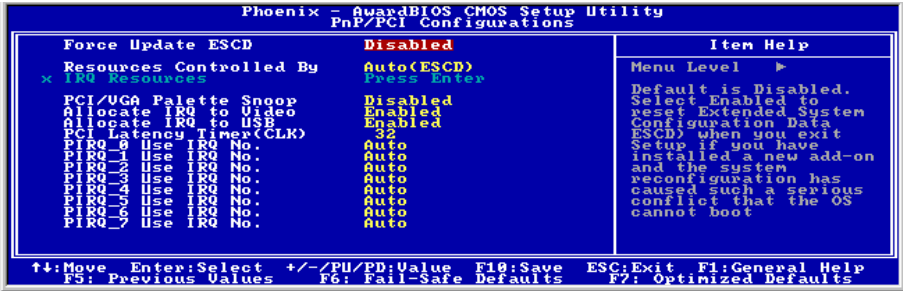

Force Update ESCD:

When set to [Enabled], the BIOS will reset the ESCD (Extended System Configuration Data) once automatically next time you boot up. It will then recreate a new set of configuration data. But the next time you boot up, this option will automatically be set as Disabled.

NOTE: The ESCD (Extended System Configuration Data) contains the IRQ, DMA, I/O port, memory information of the system. This is a specification and a feature specific to the Plug & Play BIOS.

Resources Controlled By:

This item configures all of the boot and Plug-and-Play compatible devices.

[Auto(ESCD)]: The system will automatically detect the settings.

[Manual]: Choose the specific IRQ resources in the “IRQ Resources” menu.

* **IRQ Resources:**

Click <Enter> key to enter its submenu:

This item sets each system interrupt to either [PCI Device] or [Reserved].

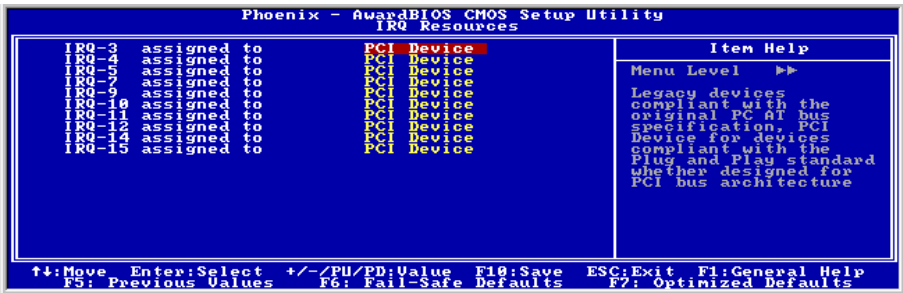

PCI/VGA Palette Snoop:

This item determines whether the MPEG ISA/VESA VGA cards can work with PCI/VGA or not.

[Enabled]: MPEG ISA/VESA VGA cards work with PCI/VGA.

[Disabled]: MPEG ISA/VESA VGA cards do not work with PCI/VGA.

Allocate IRQ To Video:

This item assigns an IRQ for the VGA card installed.

[Enabled]: Automatically assign an IRQ for the VGA card installed.

[Disabled]: The IRQ that was previously occupied by the VGA card will be available for new device.

Allocate IRQ To USB:

This item assigns an IRQ for the USB device connected.

[Enabled]: Automatically assign an IRQ for the USB device connected.

[Disabled]: The IRQ that was previously occupied by the USB device connected will be available for new device.

PCI Latency Timer(CLK):

This item controls how long each PCI device can hold the bus before another takes over. When set to higher values, every PCI device can conduct transactions for a longer time and thus improve the effective PCI bandwidth. For better PCI performance, you should set the item to higher values.

PIRQ 0 Use IRQ No. ~ PIRQ 7 Use IRQ No.:

This item specifies the IRQ number manually or automatically for the devices installed on PCI slots.

For the relations between the hardware layout of PIRQ (the signals from the ICH chipset), INT# (means PCI slot IRQ signals) and devices, please refer to the table below:

| Signals | AGP | LAN | PCI-1 | PCI-2 | PCI-3 | PCI-4 | PCI-5 | IEEE-1394 | SATA |
|-------------------|-------|-------|-------|-------|-------|-------|-------|-----------|-------|
| PIRQ_0 Assignment | INT A | | INT D | | | | | | |
| PIRQ_1 Assignment | INT B | | INT A | | | | | | |
| PIRQ_2 Assignment | | INT A | INT B | | | | | INT A | |
| PIRQ_3 Assignment | | | INT C | | | | | | INT A |
| PIRQ_4 Assignment | | | | INT A | INT D | INT C | INT B | | |
| PIRQ_5 Assignment | | | | INT B | INT A | INT D | INT C | | |
| PIRQ_6 Assignment | | | | INT C | INT B | INT A | INT D | | |
| PIRQ_7 Assignment | | | | INT D | INT C | INT B | INT A | | |

3-8. PC Health Status



FAN Fail Alarm Selectable:

This item selects the fan that will be monitored for malfunction.

Shutdown When CPU Fan Fail:

When set to [Enabled], the system will be shut down if the CPU fan is not running.

Smart Fan Speed Control:

This item allows you to control the speed of CPU fan down to a specific percentage. When the temperature limit of both the item “Shutdown Temperature” and “CPU Warning Temperature” are not exceeded, the CPU fan speed will run at the percentage you set. When the temperature limit of both the item “CPU Shutdown Temperature” and “CPU Warning Temperature” are exceeded, the CPU fan speed will run at its 100% speed, regardless of what the percentage you set.

Shutdown Temperature:

This item sets the temperature that would shutdown the system automatically in order to prevent system overheats.

CPU Warning Temperature:

This item selects the CPU’s warning temperature limit. Once the system has detected that the CPU’s temperature exceeded the limit, warning beeps will sound.

NOTE: The onboard hardware monitor function is capable of detecting these system health conditions. If you want a warning message to pop-up or a warning alarm to sound when an abnormal condition occurs, you must install the “Hardware Doctor” utility. This utility is included in the “Driver & Utility CD” that came packed with this motherboard.

All Voltages, Fans Speed and Thermal Monitoring:

These unchangeable items list the current status of the CPU and environment temperatures, fan speeds, and system power voltage.

NOTE: The hardware monitoring features for temperatures, fans and voltages will occupy the I/O address from 294H to 297H. If you have a network adapter, sound card or other add-on cards that might use those I/O addresses, please adjust your add-on card I/O address to avoid using these addresses.

3-9. Load Fail-Safe Defaults

This option loads the BIOS default values for the most stable, minimal-performance system operations.

3-10. Load Optimized Defaults

This option loads the BIOS default values that are factory settings for optimal-performance system operations.

3-11. Set Password

This option protects the BIOS configuration or restricts access to the computer itself.

3-12. Save & Exit Setup

This option saves your selections and exits the BIOS setup menu.

3-13. Exit Without Saving

This option exits the BIOS setup menu without saving any change.



Appendix A. Install Intel Chipset Software Utility

NOTE: Please install this Intel Chipset driver first after having installed the Windows operating system.

The installation procedures and screen shots in this section are based on Windows XP operating system. For those of other OS, please follow its on-screen instruction.

Insert the Driver & Utility CD into CD-ROM drive, it should execute the installation program automatically. If not, double-click the execution file at the main directory of this CD to enter the installation menu.

After entering the installation menu, move your cursor to [Driver] tab. Click [Intel Chipset Software Utility]. The following screen appears.

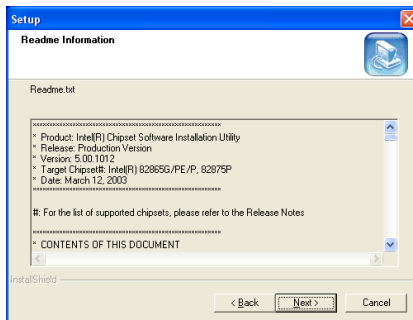

3. Click [Next].

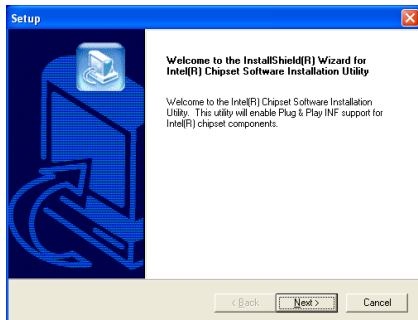

1. Click [Next].

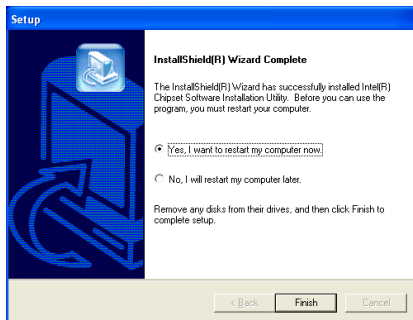

4. Choose [Yes, I want to restart my computer now.], and click [Finish] to complete setup.

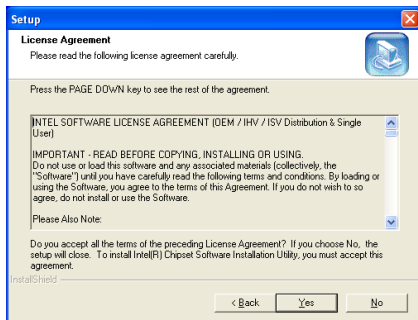

2. Click [Yes].



Appendix B. Install Intel Application Accelerator

The installation procedures and screen shots in this section are based on Windows XP operating system. For those of other OS, please follow its on-screen instruction.

Insert the Driver & Utility CD into CD-ROM drive, it should execute the installation program automatically. If not, double-click the execution file at the main directory of this CD to enter the installation menu.

After entering the installation menu, move your cursor to [Driver] tab. Click [Intel Application Accelerator]. The following screen appears.

NOTE: This “Intel Application Accelerator” program edition is available for Windows XP only. To install this program, you have to enable the item “RAID Function” first in the BIOS menu of “OnChip Serial ATA”.

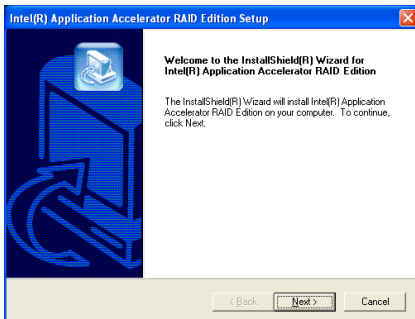

1. Click [Next].

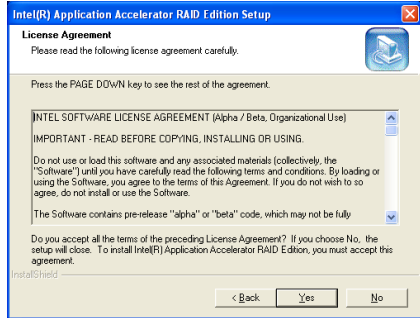

2. Click [Yes].

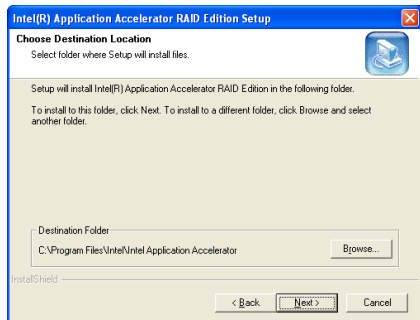

3. Click [Next].

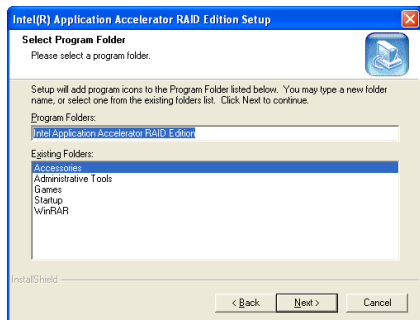

4. Click [Next].



5. Click [Continue Anyway].

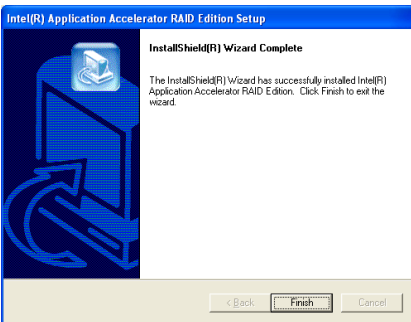

6. Choose [Yes, I want to restart my computer now.], and click [Finish] to complete setup.

Appendix C. Install Audio Driver

The installation procedures and screen shots in this section are based on Windows XP operating system. For those of other OS, please follow its on-screen instruction.

Insert the Driver & Utility CD into CD-ROM drive, it should execute the installation program automatically. If not, double-click the execution file at the main directory of this CD to enter the installation menu.

After entering the installation menu, move your cursor to [Driver] tab. Click [RealTek ALC650 Audio]. The following screen appears.

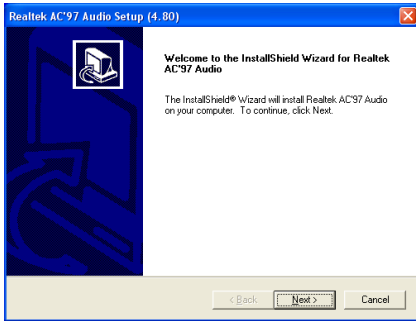

1. Click [Next].

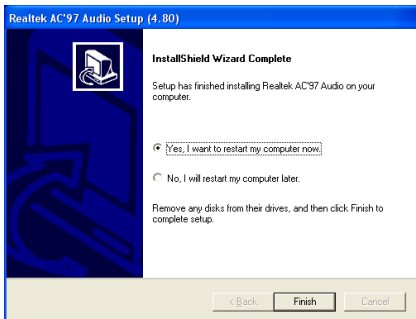

2. Choose [Yes, I want to restart my computer now.], and click [Finish] to complete setup.

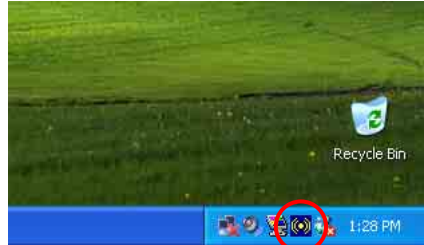

3. After the system restarted, a shortcut icon appears at the right corner of Windows task bar.

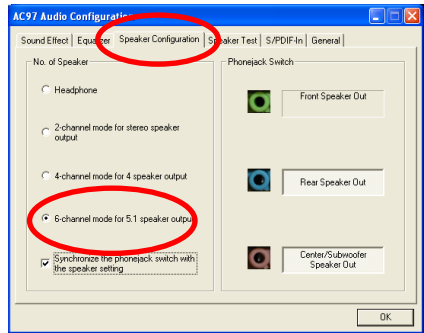

4. In this Speaker Configuration tab, select [6 channels mode for 5.1 speakers output] to enable 6-channel audio system.



Appendix D. Install LAN Driver

The installation procedures and screen shots in this section are based on Windows XP operating system. For those of other OS, please follow its on-screen instruction.

Insert the Driver & Utility CD into CD-ROM drive, it should execute the installation program automatically. If not, double-click the execution file at the main directory of this CD to enter the installation menu.

After entering the installation menu, move your cursor to [Driver] tab. Click [Intel Gigabit Lan]. The following screen appears.



1. Click [Wired LAN Adapters].

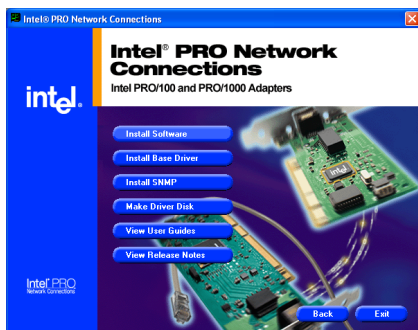

2. Click [Install Software].

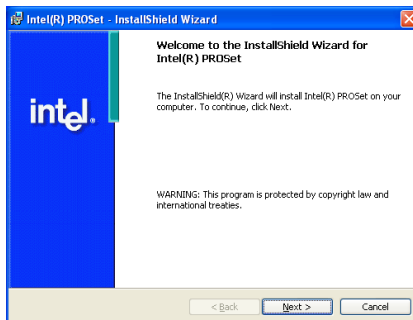

3. Click [Next].

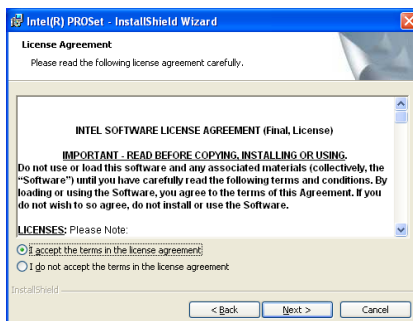

4. Select the check box “I accept the terms in the license agreement”, and the click [Next] to go on.

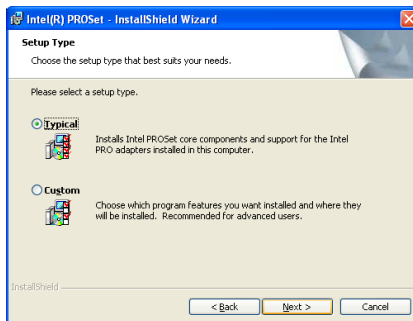

5. Click [Next].

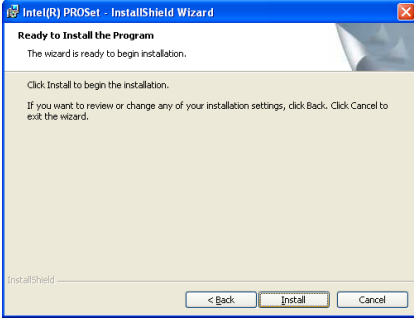

6. Click [Install].



7. Click [Continue Anyway].

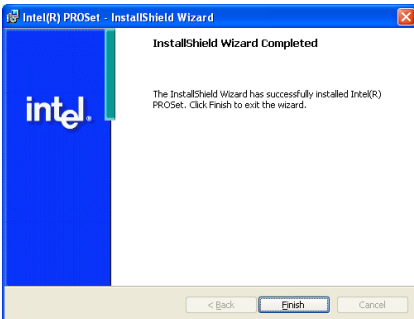

8. Click [Finish] to complete setup.

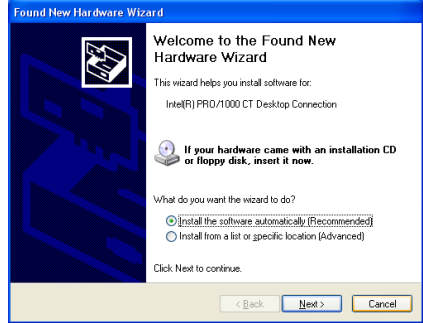

9. Restart the system, the Found New Hardware Wizard appears. Select [Install the software automatically]. Click [Next] to continue.

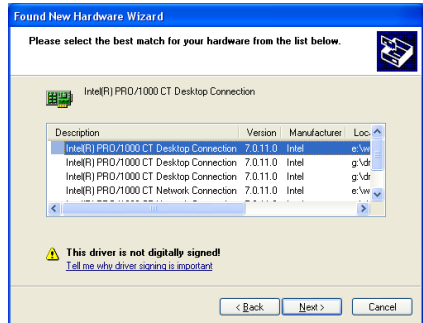

10. Click [Next].



11. Click [Continue Anyway].

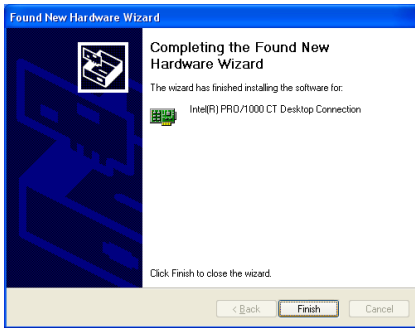

12. Click [Finish] to complete setup.



Appendix E. Install Silicon Serial ATA RAID Driver

The installation procedures and screen shots in this section are based on Windows XP operating system. For those of other OS, please follow its on-screen instruction.

Insert the Driver & Utility CD into CD-ROM drive, it should execute the installation program automatically. If not, double-click the execution file at the main directory of this CD to enter the installation menu.

After entering the installation menu, move your cursor to [Driver] tab. Click [Serial ATA RAID Driver]. The following screen appears.

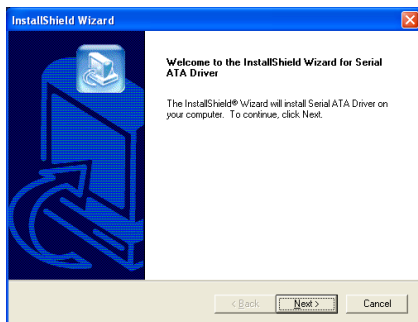

1. Click [Next].



2. Click [Continue Anyway].

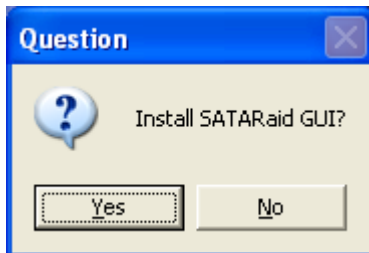

3. Click [Yes].

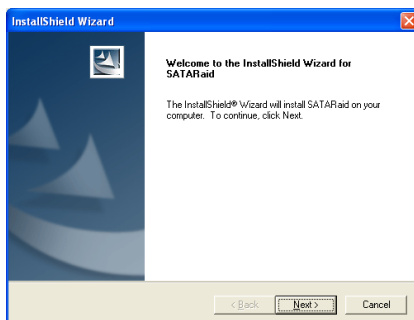

4. Click [Next].

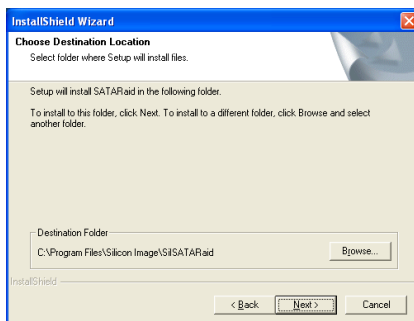

5. Click [Next].

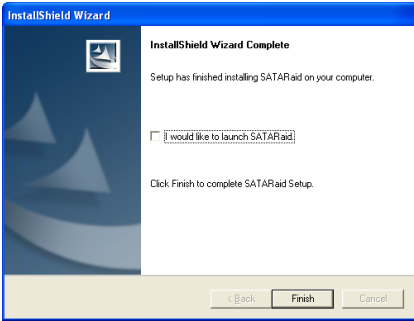

6. Click [Next].

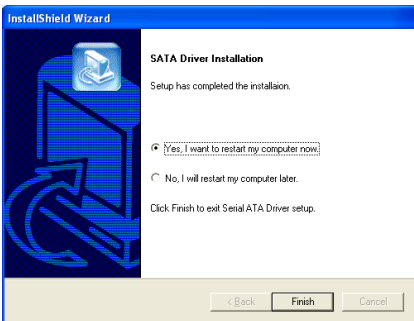

7. Choose [Yes, I want to restart my computer now.], and click [Finish] to complete setup.



8. Check [Device Manager]. [Silicon Image Sii 3112 SATARaid Controller] is successfully installed.

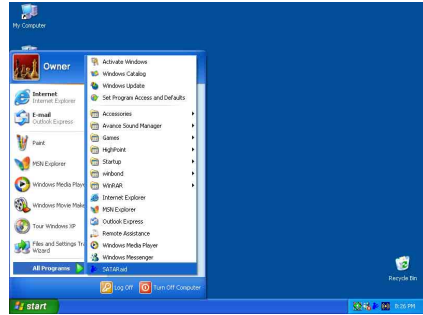

9. To run the [SATARaid] application, click [Start] → [All Programs] → [SATARaid].

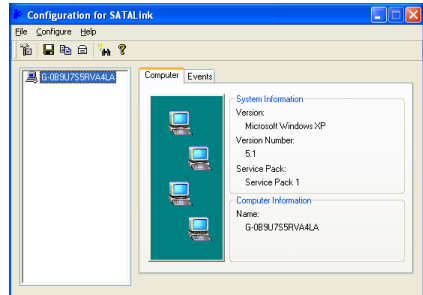

10. This is the SATALink configuration menu. For more information on how to operate, please refer to the “Help” menu.

BIOS Setup for Silicon Serial ATA RAID

The IC7-G supports Striped (RAID 0) and Mirrored (RAID 1) RAID set. For the striped RAID set, the identical drives can read and write data in parallel to increase performance. The Mirrored RAID set creates a complete backup of your files. Striped and Mirrored RAID set requires 2 hard disks to do so.

RAID Configuration Utility Menu

Main Menu

Reboot your system. Press **<CTRL> + <S>** or **<F4>** key while booting up the system to enter the BIOS setting menu. The main menu of BIOS Setting Utility appears as shown below:

| RAID Configuration Utility - Silicon Image Inc. Copyright (C) 2002 | | | |
|---|----|----------------|---------------|
| Create RAID set Delete RAID set Rebuild Mirrored set Resolve Conflicts | | | |
| * 0 | PM | Master 33073H3 | 29312MB |
| 1 | SM | Master 33073H3 | 29312MB |
| | | TL | Select Menu |
| | | ESC | Previous Menu |
| | | Enter | Select |
| | | Ctrl-E | Exit |
| | | * | First HDD |

To select the option in this menu, you may:

- Press **<↑ ↓>** (up, down arrow) to choose the option you want to confirm or to modify.
- Press **<Enter>** to confirm the selection.
- Press **<Esc>** to return to previous menu.
- Press **<Ctrl-E>** to exit the RAID configuration utility.

NOTE: If you want to create a RAID 0 (striping) array, all the data stored in the hard disks will first be erased! Please backup the hard disk data before starting to create the RAID array.

If you want to create a RAID 1 (mirroring) array, please make sure which hard disk is the source disk and which one is the destination disk. If you make a mistake, you may copy the blank data to the source disk, which will result in both hard disks becoming blank!

Option 1 Create RAID set

This item allows you to create a RAID array.

After you had selected the function from the main menu, press the **<Enter>** key to enter the sub menu as shown below:

| RAID Configuration Utility - Silicon Image Inc. Copyright (C) 2002 | | | |
|---|----|---------------------|---------------|
| Create RAID set Delete RAID set Rebuild Mirrored set Resolve Conflicts | | Striped Mirrored | |
| * 0 | PM | Master 33073H3 | 29312MB |
| 1 | SM | Master 33073H3 | 29312MB |
| | | TL | Select Menu |
| | | ESC | Previous Menu |
| | | Enter | Select |
| | | Ctrl-E | Exit |
| | | * | First HDD |

• Array Mode:

This item allows you to select the appropriate RAID mode for the desired array. There are two modes to choose. When you choose a “Striped” or “Mirrored” RAID set, the utility will ask “Are You Sure?” before the Creating RAID process. Press **<Y>** to confirm.

NOTE: It is highly recommended to attach hard disks with the same model in reaching the RAID performance.

Striping (RAID 0): This item is recommended for **high performance** usage. Requires at least 2 disks.

Mirror (RAID 1): This item is recommended for **data security** usage. Requires at least 2 disks.

**Option 2
Delete RAID set**

This item allows you to remove a RAID Array on this onboard Serial ATA RAID controller.

NOTE: After you have made and confirmed this selection, all the data stored in the hard disk will be lost. (The entire partition configuration will be deleted too.)

**Option 3
Rebuild Mirrored set**

This item allows you to rebuild only “Mirrored” RAID set.

You need to check which hard disk is the source disk and which one is the destination disk when you decide to rebuild mirrored RAID set.

**Option 4
Resolve Conflicts**

When a RAID set is created, the metadata written to the disk includes drive connection information (Primary Channel, Secondary Channel).

If, after a disk failure, the replacement disk was previously part of a RAID set (or used in another system), it may have conflicting metadata, specifically in reference to the drive connection information. If so, this will prohibit the RAID set from being either created or rebuilt.

In order for the RAID set to function properly, this old metadata must be first overwritten with the new metadata. To resolve this, select “Resolve Conflict”. The correct metadata, including the correct drive connection information, will then be written to the replacement disk.

NOTE: For more information on RAID function, please refer to the RAID Management Software enclosed in the CD that came packed with this motherboard.

Appendix F. BIOS Update Guide

The procedure illustrated here is based on the model SE6 as an example; all other models follow the same process.

1. First, find out the model name and version number of this motherboard. You can find a bar-code sticker typed with model name and version number on motherboard PCB.
2. Find out the current BIOS ID. For example, in this case, the current BIOS ID is [00]. If you already have the latest BIOS, no any update action is necessary. If your BIOS is not the latest BIOS, go on to the next step.

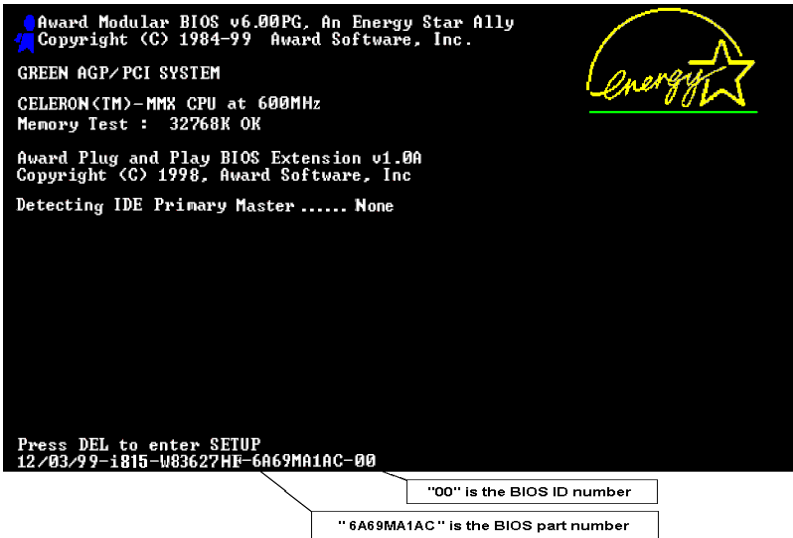

3. Download the correct BIOS file from our Web site.
4. Double click the downloaded file, it will self-extract to [awdf flash.exe] and [* .bin] files.
5. Make a bootable floppy disk and copy the necessary files onto it. You may make a floppy disk bootable either in Explorer or in the DOS prompt mode.

```
[c:\>]format a: /s
```

After formatting and transferring the system to the floppy disk, copy two files into it. One is the BIOS flash utility [awdf flash.exe] and the other is the decompressed BIOS binary [* .bin] file.

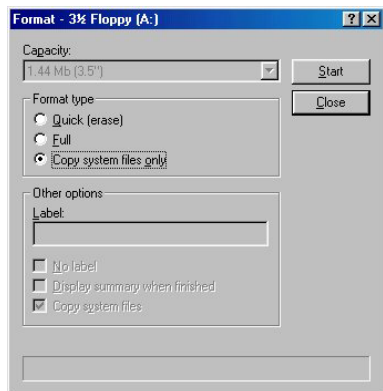

- Please set the first boot sequence as “**Floppy**” in BIOS and boot off the floppy disk.

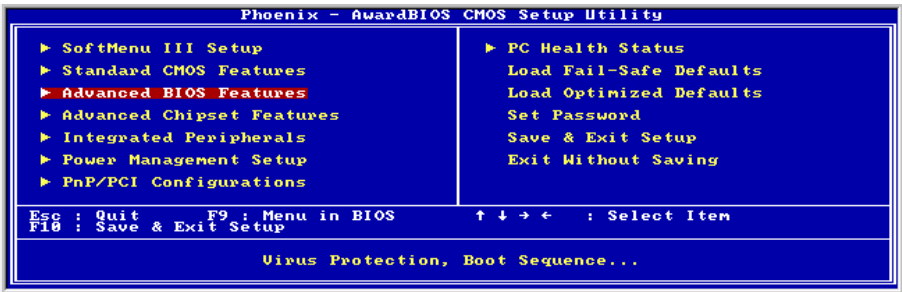

- Flash the BIOS in pure DOS mode.

```
A:\>awdf flash se6_sw.bin /cc /cd /cp /py /sn /cks /r_
```

Note

- We strongly recommend you use the above parameters following 'awdf flash' to flash your BIOS. **DO NOT** just type “awdf flash se6_sw.bin” without the above parameters following the “.bin” file.
- The Award flash utility cannot be completed under the Windows environment. It must be done in a pure DOS environment.
- You should check which BIOS file is to be used with your motherboard, don't flash with the wrong BIOS file. Otherwise, it may cause system malfunctions.
- Please do not use the Award flash memory writer version earlier than Version 7.52C to flash the BIOS. Otherwise, it may cause flash fail or un-anticipated problems.
- During the updating, the progress will be measured by white blocks. The last four *blue* blocks of the flash update process represent the “BIOS boot block”. The BIOS boot block is used to prevent the BIOS from becoming corrupt during programming. It should not be programmed every time. If this “BIOS boot block” remains intact when the BIOS becomes corrupt during programming, then you can boot from a bootable floppy next time you boot your computer. This allows you to flash your BIOS again without the need for technical support from the dealer.

Appendix G. Hardware Monitoring (The Winbond Hardware Doctor Utility)

The Winbond Hardware Doctor is a self-diagnostic system for PCs used with Winbond W83627HF chipset. It protects PC hardware by monitoring several critical items including power supply voltages, CPU & system fan speeds and CPU and system temperatures. These items are important for the system operation. Errors may result in permanent damage to the PC. Once any item is out of its normal range, a warning message pops up reminding you to take proper measures.

The installation procedures and screen shots in this section are based on Windows XP operating system. For those of other OS, please follow its on-screen instruction.

Insert the Driver & Utility CD into CD-ROM drive, it should execute the installation program automatically. If not, double-click the execution file at the main directory of this CD to enter the installation menu.

After entering the installation menu, move your cursor to [Hardware Doctor] tab. Click [Install Hardware Doctor]. The following screen appears.

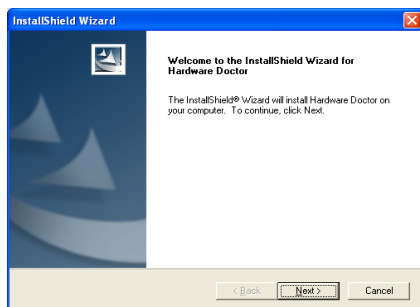

1. Click [Next].

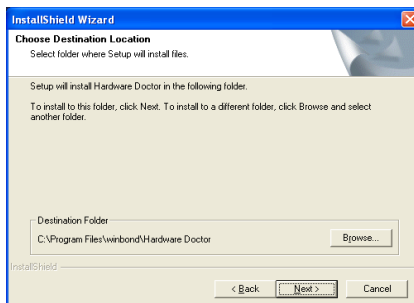

2. Click [Next].

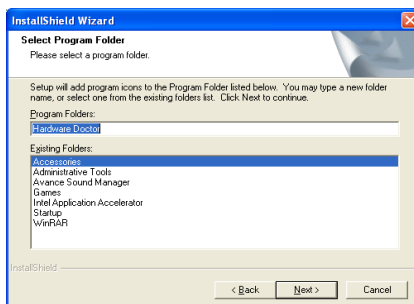

3. Click [Next].

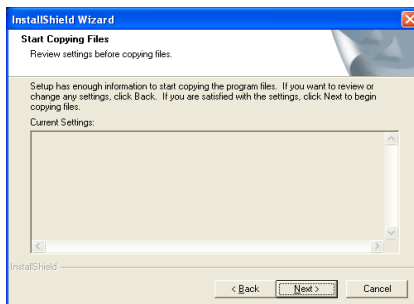

4. Click [Next].

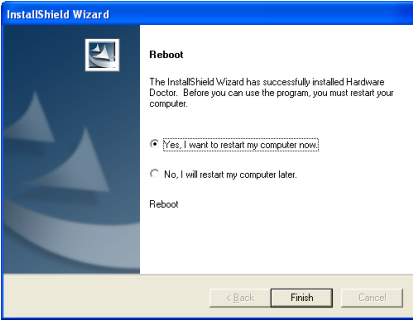

5. Choose [Yes, I want to restart my computer now.] and click [Finish] to complete setup.

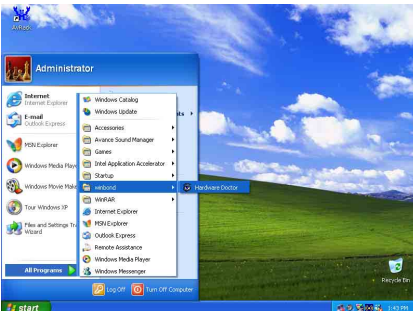

6. Execute the Hardware Doctor by entering the Windows Menu [Start] → [Programs] → [Winbond] → [Hardware Doctor].

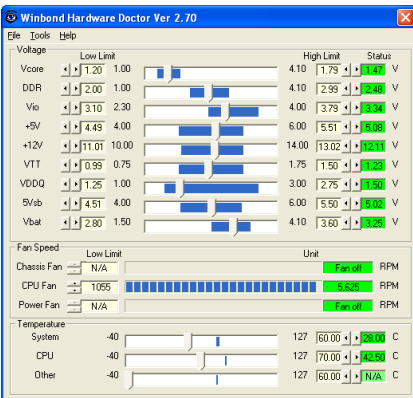

7. This screen appears. Hardware Doctor shows you the status of Voltage, Fan Speed, and Temperature readings as well. If any reading is

critical or over its limitation, the reading turns red. Also, a pop-up window appears warning you the system has a problem!



8. This is the warning message window:

Ignore: You can ignore the warning message of the item, but it will pop up again when an error of the same item reoccurs.

Disable: The chosen item will be no longer monitored thereafter, unless you activate it in the “**Configuration**” page.

Shutdown: Choosing this button will shutdown the computer.

Help: You can read more information and self-diagnose simple problems.

If the warning message pops up due to the wrong warning limit, you can adjust it in the “**Configuration**” option. For example, if you set the temperature high limit to 40°C, you will easily exceed the “proper” temperature.

Pay attention to two things when you want to make any change to the “**Configuration**” option. Firstly, you have to make sure your new setting is in the proper range. Secondly, after you finished the configuration, you have to save it. Otherwise, the program will start with the default value next time.

If you encounter any problem or have any question about the software settings and adjustments, please use the Winbond hardware doctor on-line help. It should give you enough information to answer your questions.

Appendix H. Installation Guide for Suspend to RAM

Suspend To RAM (STR) is a cost-effective, optimal implementation of the ACPI 1.0 specification. The ACPI specification defines the S3 sleep state, in which all system context is lost except system memory. CPU, cache, and chip set context are lost in this state. Hardware maintains memory context and restores some CPU and L2 configuration context.

The STR function enables a PC to achieve the S3 state during idle periods, then quick “wake up” and retrieve the last “state” of the system before it went to sleep. When idle, STR-enabled systems consume only a small fraction of the power used for full operation. Instead of shutting down the system to save power when not in use and then having to reboot later, users can let the STR function take over and not have to worry about using power to run all the electronics, fans and disks. When needed, a PC with STR function can restore all applications and features to an operational state within a few seconds.

The following description will tell you how to install the STR function and to use it.

After the operating system had been installed successfully, reboot your computer, you can see these ACPI items show up in the “Device Manager” menu by entering *Start* → *Settings* → *Control Panel* → *System* → *System Properties* → *Hardware*:

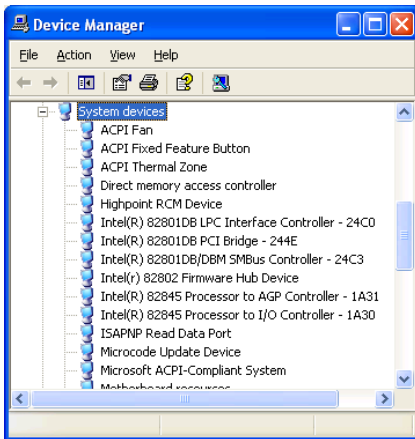

How to use the STR function:

There are two ways to put your system into STR mode:

Method 1: Select [Stand by] in the [Turn Off Computer...] area.



1. Click [Start] in the Windows Tools Bar, and then select [Turn Off Computer...]

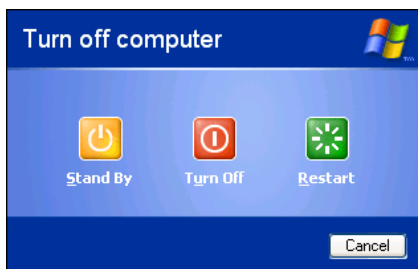

2. Click [Stand by].

Method 2: Define the chassis's [Power] button to initiate STR sleep Mode

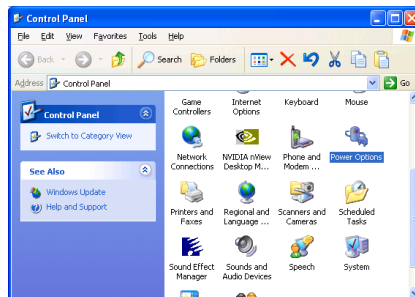

1. Open [Control Panel], and then enter [Power Options].

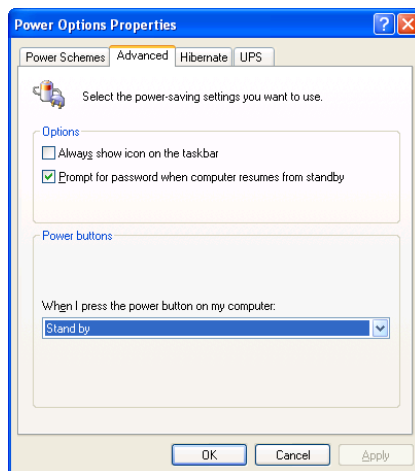

2. Select [Advanced] tab. Set the [Power Buttons] option to [Stand by].

Restart your computer to put these settings into effect. Now you will only need to press the [Power] button on the front panel of the chassis when you want to put your computer into STR sleep mode.

Appendix I. Troubleshooting (Need Assistance?)

Motherboard Troubleshooting:

Q & A:

Q: Do I need to clear the CMOS before I use a new motherboard to assemble my new computer system?

A: Yes, we highly recommend that you clear the CMOS before installing a new motherboard. Please move the CMOS jumper from its default 1-2 position to 2-3 for a few seconds, and then back. When you boot up your system for the first time, follow the instructions in the user's manual to load the optimized defaults.

Q: If my systems hang when I update the BIOS or set the wrong CPU parameters, what should I do?

A: Whenever you update the BIOS or if the system hangs due to wrong CPU parameters setting, always clear CMOS jumper before booting up again.

Q: Why the system failed to boot up and nothing was displayed on the screen after I did some over-clocking or non-standard settings inside the BIOS? Is the motherboard dead? Do I need to return it to where I bought from or go through an RMA process?

A: It should not cause hardware or permanent damage to motherboard when BIOS settings were changed from default to over-clocking or non-standard status.

We suggest the following three troubleshooting methods to discharge CMOS data, recover the hardware default status, and then make the motherboard working again. No need to bother returning the motherboard to where you bought from or go through an RMA process.

Step 1. Switch off the power supply unit and then switch it on again after one minute. If there is no power switch on the power supply unit, disconnect its power cord for one minute and then connect it back.

Press and hold the <Insert> key on the keyboard, press the power-on button to boot up system. If it works, loose the <Insert> key and hit key to enter the BIOS setup page to do the correct settings.

If the situation remains the same, repeat the procedures in Step 1 for three times, or try Step 2.

Step 2. Switch off the power supply unit or disconnect the power cord. Open the chassis cover. Locate the CCMOS jumper near the button battery. Change the jumper position from default 1-2 to 2-3 for one minute to discharge the CMOS data, and then put it back to default 1-2 position.

Close the chassis and switch on the power supply unit or plug in the power cord. Press the power-on button to boot up system. If it works, hit key to enter the BIOS setup page to do the correct settings.

If the situation remains the same, try Step 3.

Step 3. The same procedure as Step 2, but in the meantime of discharging the CMOS data, pull out ATX power connectors from motherboard and remove the button battery during CMOS discharging.

Q: How can I get a quick response to my request for technical support?

A: Be sure to follow the guidelines as stated in the “Technical Support Form” section of this manual.

If you have a problem during operation, in order to help our technical support personnel quickly determine the problem with your motherboard and give you the answers you need, before filling in the technical support form, eliminate any peripheral that is not related to the problem, and indicate it on the form. Fax this form to your dealer or to the company where you bought the hardware in order to benefit from our technical support. (You can refer to the examples given below)

Example 1:

With a system including: motherboard (with CPU, DRAM, COAST...) HDD, CD-ROM, FDD, VGA CARD, MPEG CARD, SCSI CARD, SOUND CARD, etc. After the system is assembled, if you cannot boot up, check the key components of the system using the procedure described below. First remove all interface cards except the VGA card and try to reboot.

If you still cannot boot up: Try installing another brand/model VGA card and see if the system will start. If it still does not start, note the VGA card model, motherboard model, Bios identification number, CPU on the technical support form (refer to main instructions), and describe the problem in the problem description space provided.

If you can boot up: Insert the interface cards you have removed back into the system, one by one and try to start the system each time you insert a card, until the system will not start. Keep the VGA card and the interface card that caused the problem inserted on the motherboard, remove any other cards or peripheral, and start again. If you still cannot start, note the information related to both cards in the add-on Card space provided, and don't forget to indicate the motherboard model, version, BIOS identification number, CPU (refer to main instructions), and give a description of the problem.

Example 2:

With a system including the motherboard (with CPU, DRAM, COAST...) HDD, CD-ROM, FDD, VGA CARD, LAN CARD, MPEG CARD, SCSI CARD, SOUND CARD, after assembly and after having installed the Sound Card Driver, when you restart the system, when it runs the Sound Card Driver, it resets automatically. This problem may be due to the Sound Card Driver. During the Starting DOS... procedure, press SHIFT (BY-PASS) key, to skip CONFIG.SYS and AUTOEXEC.BAT; edit CONFIG.SYS with a text editor, and in function the line that loads the Sound Card Driver, add a remark REM, in order to disable the Sound Card Driver. See the example below.

```
CONFIG.SYS:
DEVICE=C:\DOS\HIMEM.SYS
DEVICE=C:\DOS\EMM386.EXE HIGHSCAN
DOS=HIGH, UMB
FILES=40
BUFFERS=36
REM DEVICEHIGH=C:\PLUGPLAY\DWCFMG.MSYS
LASTDRIVE=Z
```

Restart the system. If the system starts and does not reset, you can be sure that the problem is due to the Sound Card Driver. Write down the Sound Card model, motherboard model, BIOS identification number on the technical support file (refer to main instructions), and describe the problem in the space provided.

We will show you how to fill the “Technical Support Form”.

Main instructions:

To fill in this “**Technical Support Form**”, refer to the step-by-step instructions given below:

- 1* **MODEL:** Note the model number given in your user’s manual.
Example: IC7-G.
- 2* **Motherboard model number (REV):** Note the motherboard model number labeled on the motherboard as “REV:*.***”.
Example: REV: 1.01
- 3* **BIOS ID and Part Number:** See the on screen message.
4. **DRIVER REV:** Note the driver version number indicated on the DEVICE DRIVER disk (if any) as “Release *.***”. For example:

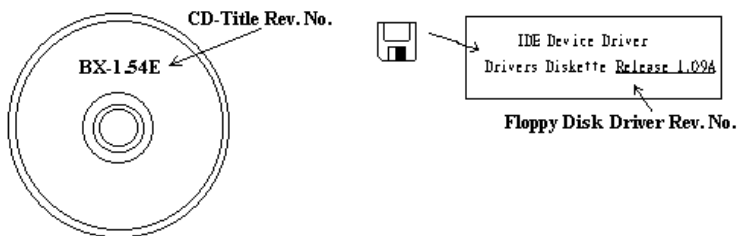

- 5* **OS/APPLICATION:** Indicate the operating system and applications you are running on the system.
Example: MS-DOS® 6.22, Windows® 98 SE, Windows® 2000, etc...
- 6* **CPU:** Indicate the brand and the speed (MHz) of your CPU.
Example:(A) In the “Brand” space, write “Intel”; in the “Specifications” space, write “Pentium® 4 1.9GHz”.
7. **HDD:** Indicate the brand and specifications of your HDD(s); specify if the HDD is using IDE1 or IDE2. If you know the disk capacity, indicate it and check (“✓”) ; in case you give no indication, we will consider that your HDD is “IDE1” Master.
Example: In the “HDD” space, check the box; in the Brand space, write “Seagate”; in the Specifications space, write “ST31621A (1.6GB)”.
8. **CD-ROM Drive:** Indicate the brand and specifications of your CD-ROM drive. Specify if it uses IDE1 or IDE2 , and check (“✓”) ; in case you give no indication, we will consider that your CD-ROM is “IDE2” Master.
Example: In the “CD-ROM drive” space, check the box, in the Brand space, write “Mitsumi”, in the Specifications space, write “FX-400D”.
9. **System Memory (DDR SDRAM):** Indicate the brand and specifications (DDR DIMM) of your system memory. Such as Density, Description, Module Components, Module Part Number, CAS Latency, and Speed (MHz).
For example: In the Brand space, write “**Micron**”; in the Specifications space, write: **Density:** 128MB, **Description:** SS 16 Megx72 2.5V ECC Gold, **Module Components:** (9) 16 Megx 8, **Module Part Number:** MT9VDDT1672AG, **CAS Latency:** 2, **Speed (MHZ):** 200 MHz.

Please give us the detailed information of your DDR SDRAM module; it will help us to simulate the problems you met.

- 10. ADD-ON CARD:** Indicate which add-on cards you are *absolutely sure* are related to the problem. If you cannot identify the problem's origin, indicate all the add-on cards inserted into your system.

NOTE: Items between the “*” are absolutely necessary.

RAID Troubleshooting

Q & A:

Q: May I use hard drives with different capacity or transfer mode?

A: In order to get optimized performance, we suggest using hard drives with the same model.

Q: How to assign a booting device?

A: You may press <Ctrl> <H> to assign a booting device in RAID BIOS (See Appendix G for detailed information).

Q: Why can't I see correct capacity in FDISK utility?

A: It's a well-known issue of Windows® 95/98's FDISK utility. If an IBM 75GB hard disk DTLA 307075 only gets 7768MB in Windows® 95/98's FDISK utility, please contact Microsoft® for a latest version of FDISK utility or download IBM's Disk Manager DiskGo! 2.5 to fix it. For windows® 2000, there is no such a 64GB issue.

<http://www.storage.ibm.com/techsup/hddtech/welcome.htm>

Q: How to create a striping and mirror array (RAID 0+1)?

A: You need four HDD drives, every two of them on the same channel/cable build a striping array. Then create a mirror array by these two striping arrays (See Appendix G for detailed information).

1. Press <Ctrl> <H> to setup configuration
2. Choose item 1 to Create RAID.
3. Choose item 1 to set Array Mode as Striping and Mirror (RAID 0+1).
4. Choose item 2 to Select Disk Drives. There are two striping arrays built automatically and you only have to enter twice.
5. Choose item 4 to Start Creation Process.
6. Press <Esc> to finish setting and leave RAID BIOS.

Q: How to rebuild a mirror array when one of the drives corrupts?

A: You need to delete previous array setting, duplicate the data, and then rebuild a new array setting (See Appendix G for detailed information).

1. Press <Ctrl> <H> to setup configuration
2. Choose item 2 to Delete Array.
3. Choose item 3 to Rebuild Mirror Array.
4. Choose sub item 1 to Select Source Disk, the one with data on it.
5. Choose sub item 2 to Select Target Disk, the brand new and empty one.
6. Choose sub item 3 to Start Duplication Process.
7. After duplication process completes, press <Esc> to leave RAID BIOS.

Q: Why I see “NO ROM BASIC SYSTEM HALTED” when booting?

A: There isn't any activated primary partition in you system. Please use FDISK or any other utilities to create/set one.

Do & Don't:

1. **Do** always use the same model drives to achieve best quality and performance. Different firmware has different timing characteristic, thus may somewhat decrease the RAID performance.
2. If you have two drives, do connect them on two different channels as master drive please.
3. When attach drives to the RAID card, do make sure the master/slave jumper settings are correct please. If there is only one drive on one channel/cable, do set it as master or single drive.
4. **Do** always use 80 conductor cables please.
5. **Don't** connect any ATAPI devices (CD-ROM, LS-120, MO, ZIP, removable HD etc.) on the RAID card please.
6. For the best performance result, please do use the Ultra DMA 66/100 Hard Disks.

Appendix J. How to Get Technical Support

(From our website) <http://www.abit.com.tw>

(In North America) <http://www.abit-usa.com>

(In Europe) <http://www.abit.nl>

Thank you for choosing ABIT products. ABIT sells all our products through distributors, resellers and system integrators; we have no direct sales to end-users. Before sending email for tech support please check with your resellers or integrators if you need any services, they are the ones who sold you your system and they should know best as to what can be done, how they serve you is a good reference for future purchases.

We appreciate every customer and would like to provide the best service to you. Providing fast service to our customers is our top priority. However we receive many phone calls and a huge amount of email from all over the world. At the present time it is impossible for us to respond to every single inquiry. Therefore it is quite possible that if you send an email to us that you may not receive a response.

We have done many compatibility tests and reliability tests to make sure our products have the best quality and compatibility. In case you need service or technical support, please understand the constraint we have and **always check with the reseller who sold the product to you first.**

To expedite service, we recommend that you follow the procedures outlined below before contacting us. With your help, we can meet our commitment to provide the best service to the **greatest number of ABIT customers:**

- 1. Check the Manual.** It sounds simple but we have taken a lot of care in making a well-written and thorough manual. It is full of information that doesn't only pertain to motherboards. The CD-ROM included with your board will have the manual as well as drivers. If you don't have either one, go to our Program Download Area of the Website or FTP server.
- 2. Download latest BIOS, software or drivers.** Please go to our Program Download area on our Website to check to see if you have the latest BIOS. They are developed over periods of time to fix bugs or incompatibilities. **Also please make sure you have the latest drivers from your peripheral cards makers!**
- 3. Check the ABIT Technical Terms Guide and FAQ on our Website.** We are trying to expand and make the FAQs more helpful and information rich. Let us know if you have any suggestions. For hot topics check out our HOT FAQ!

4. **Internet Newsgroups.** They are a great source of information and many people there can offer help. ABIT's Internet News group, alt.comp.periphs.mainboard.abit, is an ideal forum for the public to exchange information and discuss experiences they have had with ABIT products. Many times you will see that your question has already been asked before. This is a public Internet news group and it is reserved for free discussions. Here is a list of some of the more popular ones:

alt.comp.periphs.mainboard.abit
comp.sys.ibm.pc.hardware.chips
alt.comp.hardware.overclocking
alt.comp.hardware.homebuilt
alt.comp.hardware.pc-homebuilt

5. **Ask your reseller.** Your ABIT authorized distributor should be able to provide the fastest solution to your technical problem. We sell our products through distributors who sell to resellers and stores. Your reseller should be very familiar with your system configuration and should be able to solve your problem much more efficiently than we could. After all, your reseller regards you as an important customer who may purchase more products and who can urge your friends to buy from him or her as well. They integrated and sold the system to you. They should know best what your system configuration is and your problem. They should have reasonable return or refund policies. How they serve you is also a good reference for your next purchase.
6. **Contacting ABIT.** If you feel that you need to contact ABIT directly you can send email to the ABIT technical support department. First, please contact the support team for the branch office closest to you. They will be more familiar with local conditions and problems and will have better insight as to which resellers offer what products and services. Due to the huge number of emails coming in every day and other reasons, such as the time required for problem reproduction, we will not be able to reply to every email. Please understand that we are selling through distribution channels and don't have the resources to serve every end-user. However, we will try to do our best to help every customer. Please also remember that for many of our technical support team English is a second language, you will have a better chance of getting a helpful answer if your question can be understood in the first place. Be sure to use very, simple, concise language that clearly states the problem, avoid rambling or flowery language and always list your system components. Here is the contact information for our branch offices:

North America and South America:

ABIT Computer (U.S.A.) Corporation

45531 Northport Loop West,
Fremont, California 94538, U.S.A.

Tel: 1-510-623-0500

Fax: 1-510-623-1092

sales@abit-usa.com

technical@abit-usa.com

Germany, Benelux (Belgium, Netherlands, Luxembourg), Denmark, Norway, Sweden, Finland, and Switzerland:

AMOR Computer B.V. (ABIT's European Office)

Van Coehoornstraat 7,
5916 PH Venlo, The Netherlands

Tel: 31-77-3204428

Fax: 31-77-3204420

sales@abit.nl

technical@abit.nl

Japan:

ABIT Computer (Japan) Co. Ltd.

Fax: 81-3-5396-5110

<http://www.abit4u.jp>

Russia:

ABIT Computer (Russia) Corporation Ltd.

Fax: 7 (095) 937 8237

<http://www.abit.ru>

U.K. and Ireland:

ABIT Computer (U.K.) Corporation Ltd.

Unit 3, 24-26 Boulton Road,
Stevenage, Herts SG1 4QX, U.K.

Tel: 44-1438-228888

Fax: 44-1438-226333

sales@abitcomputer.co.uk

technical@abitcomputer.co.uk

Austria, Czech, Romania, Bulgaria, Yugoslavia, Slovakia, Slovenia, Croatia, Bosnia and Serbia:

Asguard Computer Ges.m.b.H

Schmalbachstrasse 5,
A-2201 Gerasdorf/wien, Austria

Tel: 43-1-7346709

Fax: 43-1-7346713

asguard@asguard.at

Shanghai:

ABIT Computer (Shanghai) Co. Ltd.

Tel: 86-21-6235-1829

Fax: 86-21-6235-1832

<http://www.abit.com.cn>

France:

ABIT Computer France SARL

4, Place La Defense,
92974 Paris La Defense cedex, France

Fax: 33-1-5858-0047

<http://www.abit.com.tw>

All other territories not covered above please contact Taiwan Head Office:

When contacting our headquarters please Note we are located in Taiwan and we are 8+ GMT time. In addition, we have holidays that may be different from those in your country.

ABIT Computer Corporation

No.323, YangGuang St., Neihu, Taipei, 114, Taiwan

Tel: 886-2-8751-8888

Fax: 886-2-8751-3381

sales@abit.com.tw

market@abit.com.tw

technical@abit.com.tw

<http://www.abit.com.tw>

7. **RMA Service.** If your system has been working but it just stopped, but you have not installed any new software or hardware recently, it is likely that you have a defective component. Please contact the reseller from whom you bought the product. You should be able to get RMA service there.
8. **Reporting Compatibility Problems to ABIT.** Because of tremendous number of email messages we receive every day, we are forced to give greater weight to certain types of messages than to others. For this reason, any compatibility problem that is reported to us, giving detailed system configuration information and error symptoms will receive the highest priority. For the other questions, we regret that we may not be able to reply directly. But your questions may be posted to the Internet news group in order that a larger number of users can have the benefit of the information. Please check the news group from time to time.
9. The information listed below are some **chipset vendors' WEB site addresses** for your reference:

HighPoint Technology Inc.'s WEB site: <http://www.highpoint-tech.com/>

Intel's WEB site: <http://www.intel.com/>

Silicon Image's WEB site: <http://www.siimage.com/>

SiS' WEB site: <http://www.sis.com.tw/>

VIA's WEB site: <http://www.via.com.tw/>

Thank You

ABIT Computer Corporation

<http://www.abit.com.tw>