



Your Reliable Partner

AN7

Socket 462 System Board User's Manual

Copyright and Warranty Notice

The information in this document is subject to change without notice and does not represent a commitment on part of the vendor, who assumes no liability or responsibility for any errors that may appear in this manual.

No warranty or representation, either expressed or implied, is made with respect to the quality, accuracy or fitness for any particular part of this document. In no event shall the manufacturer be liable for direct, indirect, special, incidental or consequential damages arising from any defect or error in this manual or product.

Product names appearing in this manual are for identification purpose only and trademarks and product names or brand names appearing in this document are the property of their respective owners.

This document contains materials protected under International Copyright Laws. All rights reserved. No part of this manual may be reproduced, transmitted or transcribed without the expressed written permission of the manufacturer and authors of this manual.

If you do not properly set the motherboard settings, causing the motherboard to malfunction or fail, we cannot guarantee any responsibility.

Table Of Contents

AN7 快速安裝指引	2
AN7 のクイックインストールガイド	4
AN7 Schnellinstallationsanleitung	6
AN7 Guide d'Installation Rapide	8
Краткое руководство по установке AN7.....	10
Guida all'installazione veloce Scheda madre AN7	12
Chapter 1. Introduction	1-1
1-1. Features & Specifications	1-1
1-2. Layout Diagram	1-3
Chapter 2. Hardware Setup.....	2-1
2-1. Install The Motherboard.....	2-1
2-2. Install CPU and Heatsink	2-1
2-3. Install System Memory	2-3
2-4. Connectors, Headers and Switches	2-4
(1). ATX Power Input Connectors	2-4
(2). FAN Connectors.....	2-5
(3). CMOS Memory Clearing Header	2-6
(4). Wake-up Header.....	2-7
(5). Front Panel Switches & Indicators Headers	2-8
(6). Additional USB Port Header	2-9
(7). Additional IEEE1394 Port Header.....	2-10
(8). Front Panel Audio Connection Header	2-11
(9). Internal Audio Connectors	2-12
(10). Accelerated Graphics Port Slot.....	2-13
(11). Floppy Disk Drive Connector	2-14
(12). IDE Connectors.....	2-15
(13). Serial ATA Connectors	2-16
(14). Status Indicators	2-17
(15). System Management Bus Headers.....	2-18
(16). POST Code Display	2-19
(17). Back Panel Connectors	2-20

Chapter 3. BIOS Setup	3-1
3-1. SoftMenu Setup.....	3-3
3-2. Standard CMOS Features.....	3-5
3-3. Advanced BIOS Features.....	3-8
3-4. Advanced Chipset Features.....	3-10
3-5. Integrated Peripherals	3-12
3-6. Power Management Setup	3-16
3-7. PnP/PCI Configurations.....	3-18
3-8. PC Health Status	3-20
3-9. Load Fail-Safe Defaults	3-23
3-10. Load Optimized Defaults	3-23
3-11. Set Password	3-23
3-12. Save & Exit Setup	3-23
3-13. Exit Without Saving.....	3-23
<i>Appendix A. Install NVIDIA nForce Chipset Driver</i>	<i>A-1</i>
<i>Appendix B. Install Serial ATA RAID Driver.....</i>	<i>B-1</i>
<i>Appendix C. Install ABIT μGuru Driver.....</i>	<i>C-1</i>
<i>Appendix D. POST Code Definition.....</i>	<i>D-1</i>
<i>Appendix E. Troubleshooting (Need Assistance?).....</i>	<i>E-1</i>
<i>Appendix F. How to Get Technical Support</i>	<i>F-1</i>



AN7 快速安裝指引

如您要瞭解此主機板更詳細的資訊，請參閱我們的完整版使用手冊，裡面會有詳盡的說明。此快速安裝手冊是給有經驗的系統組裝者使用，如果這是您第一次嘗試來組裝您的電腦系統，我們建議您先去閱讀完整版的使用手冊，或是詢問技術人員來幫助您組裝您的電腦系統。（完整版的使用手冊已包覆在隨本主機板所附的驅動程式與應用光碟之中。）

處理器的安裝

本主機板提供零出力（Zero Insertion Force, ZIF）式 Socket 462，以方便安裝 AMD Socket A。您所購買的 CPU 應已配備一組散熱套件及散熱片，如果沒有，請另行購買專為 Socket A 設計的散熱套件及散熱片。

請參考這裡所表示的圖來安裝 CPU 中央處理器和散熱器。（僅供參考。您的散熱器與風扇組合可能不見得與這一個完全相同。）

1. 請找出這塊主機板的 Socket 462 位置。將 CPU 插座桿拉出至插座旁，然後將插座桿以 90 度角向上拉。
2. 將 CPU 的缺角對準 CPU 插座的缺角，CPU 插腳的一端向下置 CPU 插座。因為只能朝著一個固定的方向插入 CPU，如果遇到阻礙時，切勿勉強用力。最後壓住 CPU，拴上插座桿。
3. 請將散熱器底面的自黏膠模移除，散熱器底部凹角一端面向 CPU 插座標示“Socket 462”的一方，散熱器面向下蓋住 CPU，直到完全蓋住 CPU 為止。
4. 先將固定夾具短的一邊壓下扣住 CPU 插座底端的中間鎖扣。
5. 再以螺絲起子插入固定夾具長的一邊的凹槽，壓下扣住 CPU 插座底端的中間鎖扣。現在散熱器與風扇組合已互相緊扣在 CPU 插座上。
6. 將散熱器與風扇組合的風扇電源端子與主機板上方的風扇電源端子連接。

注意：請不要忘記去設定處理器正確的匯流排頻率和倍頻的數值。

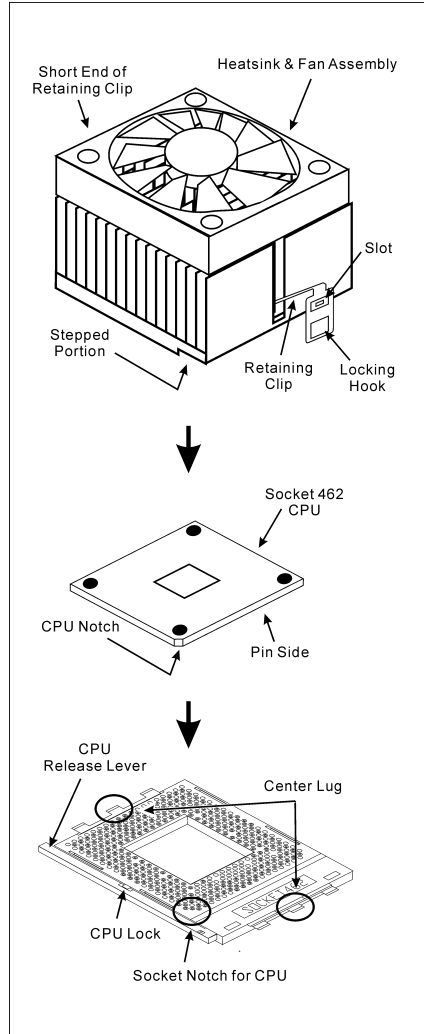

將主機板安裝到機殼上

當您將處理器安裝到主機板上之後，您便可以開始將主機板固定到電腦機殼裡去。首先；請您先將主機板固定到電腦機殼。大多數的電腦機殼底座都有許多的固定孔位，請將主機板上的固定孔位與機殼底座上的固定孔位對準。如果孔能對準並且有螺絲孔，就表示可使用銅柱來固定主機板。另外；您可以使用塑膠墊片來讓螺絲與主機板的 PCB 表層隔離（絕緣）。

安裝記憶體模組

1. 找出您主機板上 DIMM 插槽的位置。
2. 請您小心地抓住 DIMM 模組的兩側，請勿碰觸其接點。
3. 請將記憶體模組上的榫子與 DIMM 插槽上的卡榫對準。
4. 穩固地施壓來將記憶體模組向下插入 DIMM 插槽，直到 DIMM 插槽兩側的模組固定夾自動地扣入記憶體模組的固定夾缺口為止。切勿太過施力地來將 DIMM 模組插入插槽，因為您只能以一個固定的方向來插入 DIMM 模組。
5. 要取出 DIMM 模組，請您向外側同時地壓下 DIMM 插槽兩側的模組固定夾，即可將 DIMM 模組抽取出來。

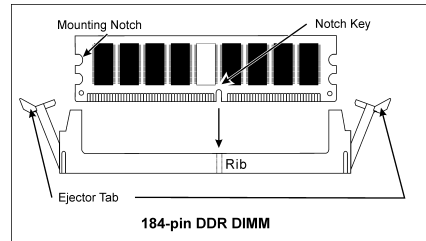

注意：靜電會造成電腦或是附加卡上電子元件的損壞，在您要進行這些程序之前，請確認您已經藉由暫時地接觸已接地的金屬物體來放掉您身上所帶有的靜電。

連接器、連接頭以及附加卡的安裝

在任何一部電腦機殼的裡面，都必需連接一些纜線與插頭。這些纜線與插頭通常都是一對一的連接至主機板的連接埠上，您必需注意任何一條纜線的連接方向。如果可能的話，請一併注意連接埠第一根針腳的位置。您將會安裝一些特殊功能的附加卡到主機板上面，像是 SCSI 卡或是 AGP 顯示卡等等。當您將它們安裝到主機板上適當的插槽之後，請以螺絲將這些附加卡與機殼背板牢牢地固定好，避免有鬆動的情況發生。

如您想要瞭解相關且更為詳細的資訊，請參閱我們的完整版使用手冊，裡面會有詳盡的說明。

將電源供應器的電源線連接頭與主機板上的 ATX12V 電源接頭連接起來

請將電源供應器的 ATX 電源接頭確實地壓入主機板上的 ATX12V 電源接頭，並確定連接妥當。

BIOS 的設定

當您將所有的硬體安裝完畢以後，就可以開啓電腦的電源並進入 BIOS 的選項。如您想要瞭解相關且更為詳細的資訊，請參閱我們的完整版使用手冊，裡面會有詳盡的說明。

AN7のクイックインストールガイド

このマザーボードの詳細については、ユーザーズマニュアルの完全版を参照してください。このクイックインストールガイドは、経験あるシステム構築者向けに書かれました。今回始めてコンピュータシステムをセットアップする方は、まず完全版のマニュアルをお読みになるか、専門技術者に連絡してコンピュータシステムのセットアップを行うようお勧めします。(完全なユーザーズマニュアルはこのマザーボードに付属するドライバとユーティリティ CD を検索して入手できます。)

プロセッサの取り付け

このマザーボードは ZIF (ゼロインサージョンフォース) Socket 462 を提供して AMD Socket A CPU をインストールします。お買い上げになった CPU には、ヒートシンクと冷却ファンのキットが付属しています。付属していない場合、Socket A 向けに特別に設計されたキットをお求めください。

ここに示した図を参照して、CPU とヒートシンクを取り付けます(この図は参照専用です。お使いのヒートシンクとファンアセンブリはこの図と異なっていることがあります)。

1. このマザーボードの Socket 462 を探します。CPU のリリースレバーを横に引っ張って掛け金を外し、上まで引き上げます。
2. CPU のノッチを CPU のソケットのノッチに合わせます。そのピンの横側を下にして CPU のソケットに差し込みます。CPU に差し込むときに無理な力を入れないでください。ピンは一方方向にだけフィットするようになっています。CPU のリリースレバーを閉じます。
3. ヒートシンクのプラスチックフィルム接着剤をはがします。ヒートシンクの段のある部分が“Socket 462”の文字のある側を向いていることを確認してください。ヒートシンクの面を下にして、プロセッサを完全に覆うまで降ろします。
4. まず支持クリップの短い方の端を押し下げて、ソケット下部のセンターラグに固定します。
5. ネジ回しを使用して、支持クリップの長い方の端のスロットに差し込みます。クリップを押し下げて、ソケット上部のセンターラグに固定します。これで、ヒートシンクとファンアセンブリが CPU のソケットにしっかり取り付けられました。
6. ヒートシンクとファンアセンブリのファンコネクタを、マザーボードのファンコネクタに取り付けます。

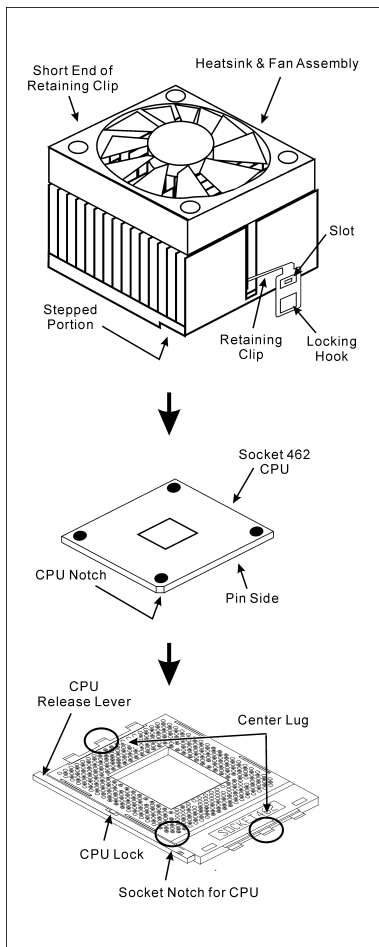

注意: 正しいバス周波数と倍数をプロセッサ用に設定するのを忘れないでください。

マザーボードをシャーシに取り付ける

マザーボードにプロセッサを取り付けた後、シャーシにマザーボードを固定することができるようになります。まず、シャーシにマザーボードを固定する必要があります。ほとんどのコンピュータシャーシには、多くの取り付け穴の付いた台が付属しており、それを使用することでマザーボードをしっかりと取り付けたり、同時にショートを避けることができます。シャーシに付属する飾りボタンかスパーサーを使用してマザーボードを固定します。

RAM モジュールの取り付け

1. ボードの DIMM スロットを探します。
2. DIMM モジュールの 2 つのエッジがそのコネクタに触れないように、注意して持ちます。
3. モジュールのノッチキーをスロットのリブに合わせます。
4. モジュールをスロットにしっかりと押し込むと、スロットの両側にあるイジェクタタブが取り付けノッチにかちっと音を立てて自動的にはめ込まれます。DIMM モジュールに余分な力をかけないでください。DIMM モジュールは一方方向にしかフィットしません。
5. DIMM モジュールは、スロットの 2 つのイジェクタタブを外側に同時に引っ張ると外れます。

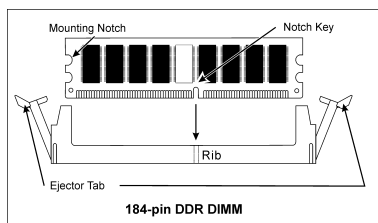

注意: 静電気はコンピュータやオプションのボードの電気コンポーネントを損傷させることがあります。これらの手順を開始する前に、アースされた金属物体に軽く触れて静電気を必ず放電してください。

コネクタ、ヘッダ、スイッチおよびアダプタ

コンピュータのケース内部には、複数のケーブルやプラグを接続できます。これらのケーブルやプラグは、通常マザーボードにあるコネクタに 1 つずつ接続されます。ケーブルの接続方向には十分な注意を払い、また必要に応じ、コネクタの第 1 ピンの位置にも注目する必要があります。SCSI アダプタ、AGP アダプタのような特殊なニーズ向けには、それに対応したアダプタを取り付けてください。アダプタをマザーボードのスロットに取り付けたら、ネジでシャーシの背面パネルに固定してください。

詳細については、ユーザーズマニュアルの完全版を参照してください。

電源コネクタを ATX12V 電源コネクタに差し込む

電源装置から出ている電源ブロックコネクタをこの ATX12V 電源に接続します。コネクタが十分奥まで装着されていることをご確認ください。

BIOS のセットアップ

ハードウェアの取り付けが完了したら、コンピュータの電源をオンにし、BIOS Setup アイテムに移動して、プロセッサのパラメータをセットアップします。詳細については、ユーザーズマニュアルの完全版を参照してください。

AN7 Schnellinstallationsanleitung

Beziehen Sie sich bitte für detaillierte Informationen über diese Hauptplatine auf die vollständige Version des Benutzerbuchs. Diese Schnellinstallationsanleitung ist für erfahrene Systemaufbauer gedacht. Ist es Ihr erster Versuch ein Computersystem aufzubauen, dann empfehlen wir Ihnen zuerst das vollständige Benutzerhandbuch zu lesen oder einen Techniker zum Aufbauen des Systems zu Hilfe zu holen. (Ein komplettes Handbuch finden Sie auf der CD mit den Treibern und Hilfsprogrammen, die diesem Motherboard beiliegt.)

Installieren des Prozessors

Dieses Motherboard verfügt über einen ZIF (Zero Insertion Force) Socket 462 zur Installation eines AMD Socket A CPU. Ihre CPU sollte über ein Kühlblech und einen Lüfter verfügen. Wenn dies nicht der Fall ist, kaufen Sie bitte diese Teile speziell für den Socket A.

Bitte schauen Sie sich zur Installation von CPU und Kühlblech diese Abbildung an. (Nur zur Referenz - Ihr Kühlblech & Lüftergefüge könnten sich von dieser Abbildung unterscheiden.)

1. Finden Sie Socket 462 auf diesem Motherboard. Ziehen Sie den CPU-Haltehebel zur Seite, um ihn zu entriegeln und ziehen ihn dann ganz hoch.
2. Richten Sie die CPU-Kerbe mit der Sockelkerbe der CPU aus. Stecken Sie den Prozessor mit den Pins nach unten in den CPU-Sockel. Wenden Sie keine Gewalt beim Einsetzen der CPU an; sie paßt nur in eine Richtung hinein. Schließen Sie den CPU-Haltehebel.
3. Entfernen Sie den Plastikfilm vom Kühlblech. Stellen Sie sicher, daß der abgestufte Teil des Kühlblechs in Richtung des Sockelendes zeigt, auf dem "Socket 462" steht. Setzen Sie das Kühlblech mit dem Gesicht nach unten auf den Prozessor, bis es den Prozessor komplett abdeckt.
4. Drücken Sie das kurze Ende des Halteclips zuerst an, um es mit der Mittellasche unten am Sockel zu verriegeln.
5. Setzen Sie es mit einem Schraubenzieher in den Schlitz am langen Ende des Halteclips. Drücken Sie den Clip nach unten, um ihn mit der Mittellasche oben am Sockel zu verriegeln. Nun sind Kühlblech & Lüftergefüge fest mit dem CPU-Sockel verbunden.
6. Verbinden Sie den Lüfteranschluß von Kühlblech & Lüftergefüge mit dem Lüfteranschluß am Motherboard.

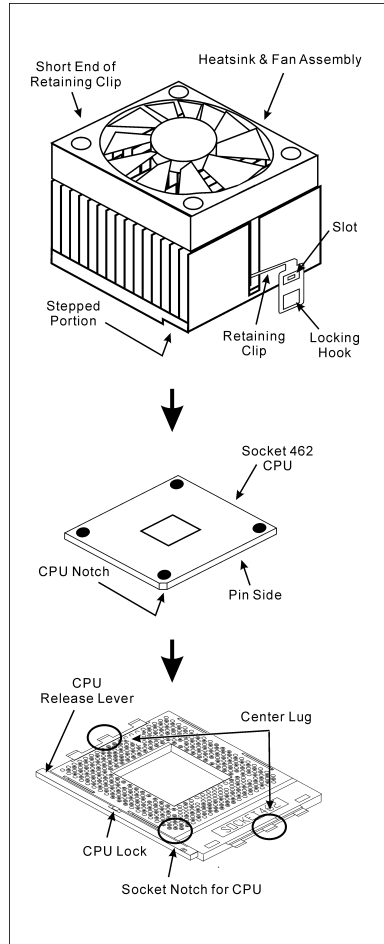

Achtung: Vergessen Sie nicht, die korrekte Busfrequenz und -Multiplikator für Ihren Prozessor einzustellen.

Installieren der Hauptplatine im Gehäuse

Nach der Installation des Prozessors können Sie anfangen die Hauptplatine im Computergehäuse zu befestigen. Die meisten Gehäuse haben eine Bodenplatte, auf der sich eine Reihe von Befestigungslöcher befinden, mit deren Hilfe Sie die Hauptplatine sicher verankern können und zugleich Kurzschlüsse verhindern. Verwenden Sie entweder die Dübeln oder die Abstandhalter, um die Hauptplatine auf der Bodenplatte des Gehäuses zu befestigen.

Installation der RAM-Module

1. Finden Sie den DIMM-Steckplatz auf dem Board.
2. Halten Sie ie beiden Ränder des DIMM-Moduls vorsichtig fest, wobei Sie darauf achten, nicht die Anschlüsse zu berühren.
3. Richten Sie die Nut am Modul mit der Erhöhung am Steckplatz aus.
4. Drücken Sie das Modul fest in die Steckplätze, bis die Auswurf flaschen zu beiden Seiten des Steckplatzes automatisch in die Befestigungs kerbe einschnappen. Wenden Sie keine Gewalt beim Einsetzen des DIMM-Moduls an; es paßt nur in eine Richtung hinein.
5. Zum Ausbau der Module drücken Sie die beiden Auswurf flaschen auf dem Steckplatz nach außen zusammen und ziehen das Modul heraus.

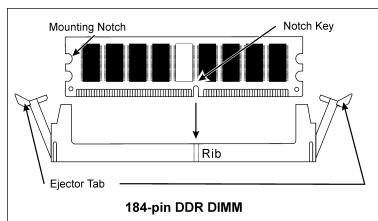

Anschlüsse, Sockel, Schalter und Adapter

Im Inneren des Gehäuses findet man in jedem Computer viele Kabel und Stecker, die angeschlossen werden müssen. Diese Kabel und Stecker werden normalerweise einzeln mit den Anschlüssen auf der Hauptplatine verbunden. Sie müssen genau auf die Anschlussorientierung der Kabel achten und, wenn vorhanden, sich die Position des ersten Pols des Anschlusses merken. Wenn Sie Adapter wie z.B. SCSI-Adapter, AGP-Adapter usw. installieren, befestigen Sie bitte die Adapter immer mit Hilfe der Schrauben auf die Rückseite des Computergehäuses.

Für detaillierte Informationen beziehen Sie sich bitte auf das vollständige Benutzerhandbuch.

Verbinden der Netzstecker mit dem ATX12V-Anschluss

Denken Sie daran, den Anschluss des ATX-Netzteils fest in das Ende mit dem ATX12V-Anschluss zu drücken, um eine feste Verbindung zu garantieren.

BIOS-Setup

Schalten Sie nach der vervollständigten Hardwareinstallation den Computer ein und gehen zur Option im BIOS, um die Prozessorparameter einzustellen. Für detaillierte Informationen beziehen Sie sich bitte auf das vollständige Benutzerhandbuch.

AN7 Guide d'Installation Rapide

Pour des informations relatives à cette carte mère plus détaillées, veuillez vous référer à notre version complète du manuel utilisateur. Ce guide d'installation rapide est créé pour les assembleurs système expérimentés. S'il s'agit de votre premier essai pour installer un ordinateur, nous vous suggérons de lire d'abord le manuel en version complète ou de demander l'aide d'un technicien pour vous aider à configurer le système ordinateur. (Un manuel de l'utilisateur complet est disponible en naviguant dans le CD des pilotes et utilitaires fournis avec la carte mère.)

Installer le Processeur

Cette carte mère fournit un support ZIF (Zero Insertion Force) Socket 462 permettant d'installer le Microprocesseur AMD Socket A. Le microprocesseur que vous achetez doit être muni d'un système de refroidissement avec dissipateur thermique et ventilateur. Dans le cas contraire, veuillez en acheter un, conçu spécialement pour les microprocesseurs Socket A.

Veuillez vous référer à la figure illustrée ci-contre pour installer le processeur et le dissipateur thermique. (Démonstration donnée à titre indicatif uniquement. L'assemblage de votre dissipateur thermique et de votre ventilateur peut ne pas être tout à fait identique à celui-ci.)

1. Repérez le support Socket 462 situé sur cette carte mère. Tirez le levier de maintien du processeur vers l'extérieur pour le libérer puis soulevez-le complètement vers le haut.
2. Alignez l'encoche du processeur avec celle du support pour processeur. Installez le processeur avec sa broche faisant face au support pour processeur. Ne forcez pas en insérant le processeur; il ne peut s'insérer que dans une seule direction. Rabattez le levier de maintien du processeur.
3. Retirez le film adhésif du dissipateur thermique. Assurez-vous que la partie surélevée du dissipateur thermique fait face à l'extrémité du support marquée "Socket 462". Installez le dissipateur thermique pour qu'il fasse face au processeur et jusqu'à ce qu'il couvre complètement le processeur.
4. Tout d'abord, poussez vers le bas l'extrémité courte de la bride de fixation pour verrouiller sur le crochet central situé en bas du support.
5. Utilisez un tournevis pour insérer dans la fente la longue extrémité de la bride de fixation. Poussez la bride de fixation vers l'avant pour verrouiller sur le crochet central situé en haut du support. L'assemblage du dissipateur Thermique et du ventilateur est maintenant solidement fixé sur le support du CPU.
6. Fixez le connecteur du ventilateur du dissipateur thermique & du ventilateur sur le connecteur correspondant de la carte mère.

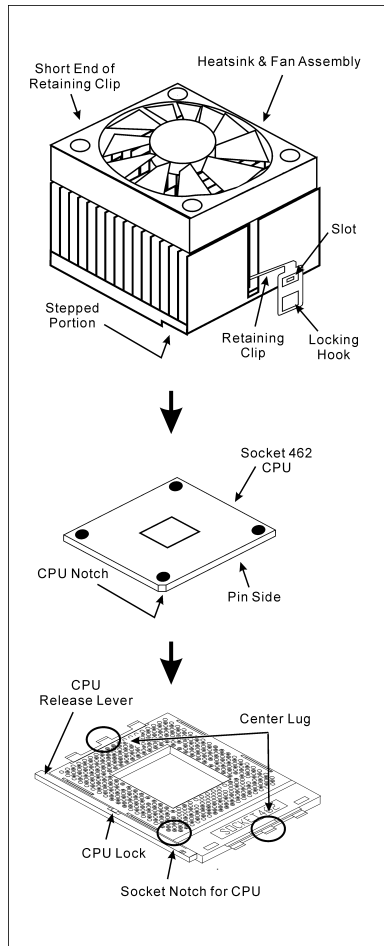

Attention: N'oubliez pas de programmer la fréquence de bus correcte et le multiple pour votre processeur.

Installer la Carte Mre dans le Châssis

Une fois que vous aurez installé le processeur sur la carte mère, vous pourrez commencer à fixer la carte mère sur le châssis. Tout d'abord, vous avez besoin de fixer la carte mère sur le châssis. La plupart des châssis d'ordinateur possèdent une base sur laquelle il y a nombreux trous de montage permettant à la carte mère d'être fixée fermement, et en même temps d'éviter les court-circuits. Utilisez les talons ou les entretoises fixés sur le châssis pour fixer la carte mère.

Installer des Modules RAM

1. Localisez le socle DIMM sur la carte.
2. Maintenez les deux bords du module DIMM avec précaution, en évitant de toucher ses connecteurs.
3. Alignez la touche du cran avec la ligne sur le socle.
4. Pressez fermement le module dans les socles jusqu'à ce que les languettes d'éjection sur les deux côtés du socle aillent automatiquement dans le cran de montage. Ne forcez pas à l'excès sur le module DIMM car celui-ci ne peut aller que selon une seule orientation.
5. Pour enlever des modules DIMM, pressez simultanément les deux languettes d'éjection sur le socle, puis sortez le module DIMM.

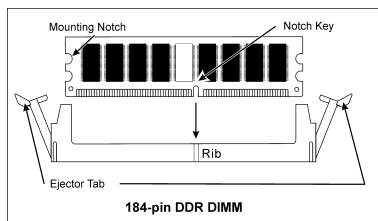

Attention: L'électricité statique risque d'endommager les composants électroniques de l'ordinateur ou des cartes optionnelles. Avant de commencer ces procédures, assurez-vous de bien décharger toute l'électricité statique en touchant rapidement un objet métallique relié au sol.

Connecteurs, Socles de connexion, Interrupteurs et Adaptateurs

A l'intérieur du boîtier de n'importe quel ordinateur il y a plusieurs câbles et prises qui doivent être connectés. Ces câbles et prises sont habituellement connectés les uns après les autres aux connecteurs situés sur la carte mère. Vous avez besoin de faire attention au sens de connexion des câbles et, s'il y a lieu, remarquez la position de la première broche du connecteur. Vous installerez certains adaptateurs pour des besoins spéciaux, tels adaptateurs SCSI, adaptateurs AGP, etc. Lorsque vous les installez dans les emplacements situés sur la carte mère, veuillez les fixer sur le panneau arrière du châssis à l'aide des vis.

Pour les informations détaillées, veuillez vous référer au manuel utilisateur en version complète.

Brancher les connecteurs d'alimentation dans les connecteurs ATX12V

Souvenez-vous que vous devez pousser le connecteur de votre alimentation fermement dans le connecteur ATX12V pour assurer une bonne connexion.

Configuration du BIOS

Une fois le matériel installé complètement, démarrez l'ordinateur et allez sur l'item dans le BIOS pour configurer les paramètres du processeur. Pour les informations détaillées, veuillez vous référer à la version complète du manuel utilisateur.

Краткое руководство по установке AN7

Более подробные сведения о материнской плате приведены в руководстве пользователя. Краткое руководство по установке предназначено для опытных специалистов. Если вы собираете компьютер впервые, ознакомьтесь сперва с руководством пользователя или попросите техника помочь в настройке компьютерной системы.

Установка процессора

На этой системной плате используется гнездо ZIP (с нулевым усилием установки) типа 'Socket 462' для процессора AMD Socket A. В комплект приобретаемого процессора должны входить радиатор и вентилятор. В противном случае следует приобрести радиатор и вентилятор, предназначенные для процессора AMD с разъемом 'Socket A'.

Для установки процессора и радиатора, посмотрите пожалуйста на рисунок, показанный на этой странице. (Только для справочной работы. Ваш радиатор и комплект вентилятора может быть не точно такой же как показанный рисунок здесь.)

1. Найдите на этой плате гнездо "Socket 462". Вытяните рычаг гнезда процессора в сторону от гнезда, затем поднимите его.
2. Расположите зарубку процессора и зарубку гнезда для процессора по одной линии. Положите процессор со стороны контактов в гнездо процессора. Устанавливая процессор, не прикладывайте чрезмерных усилий. Его установка возможна только в одном положении. Опустите рычаг гнезда процессора.
3. Уберите ту пластическую оболочку, находящуюся на радиаторе. Ступенчатая часть радиатора должна находиться лицом к стороне гнезда, где показано слово "Socket 462". Поместите радиатор плоской стороной на процессор так, чтобы процессор был полностью закрыт.
4. Сначала, прижмите вниз короткую сторону фиксирующего зажима до его фиксации в центральной проушине на нижней части гнезда.
5. Вставьте отвёртку в паз, находящийся на длинной стороне фиксирующего зажима. Прижмите зажим вниз до его фиксации в центральной проушине на верхней части гнезда. Радиатор и комплект вентилятора должны быть надежно скреплены к гнезду процессора.

6. Подключите разъем радиатора и комплекта вентилятора к разъёму вентилятора на материнской плате.

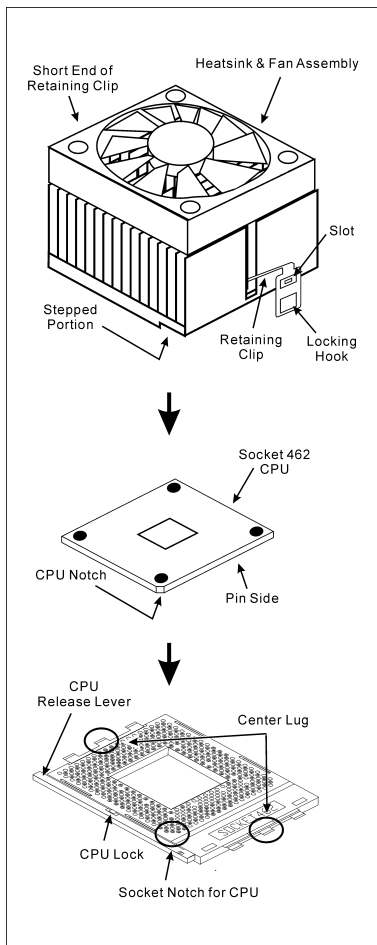

Внимание: Установите соответствующие частоту и кратность шины процессора.

Установка материнской платы в корпус

После установки процессора на материнскую плату можно начинать установку материнской платы в корпус. Большая часть корпусов оборудована основанием, в котором проделаны монтажные отверстия, которые позволяют надежно закрепить материнскую плату и предотвратить короткие замыкания. Для крепления материнской платы к основанию используются винты и прокладки.

Установка модулей памяти

1. Найдите на системной плате разъем для модулей памяти DIMM.
2. Аккуратно, за два конца, возьмите модуль памяти, не касаясь контактов.
3. Совместите выемку в модуле памяти с выступом в разъеме.
4. Нажмите на модуль так, чтобы лепестки выталкивателя с обеих сторон разъема автоматически защелкнулись и вошли в пазы. Не применяйте при установке излишнюю силу. Модуль входит в разъем только в одном положении.
5. Для извлечения модулей памяти DIMM одновременно нажмите на лепестки выталкивателя и вытащите модуль.

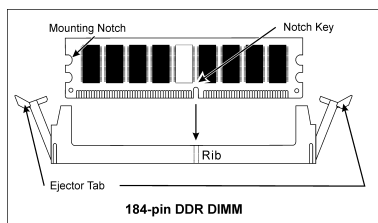

Внимание: Статическое электричество может стать причиной выхода из строя электронных компонентов компьютера. Перед началом данной процедуры снимите с себя статический заряд, коснувшись заземленного металлического предмета.

Разъемы, переключатели и адаптеры

Внутри корпуса компьютера необходимо расположены несколько кабелей и вилок, которые необходимо подключить. Обычно эти кабели подключаются к разъемам, расположенным на материнской плате. При подключении любого кабеля необходимо обращать внимание на расположение первого контакта разъема. Для особых целей могут потребоваться специальные адаптеры, например, адаптер SCSI, адаптер AGP и т.п.. При установке адаптеров в гнезда материнской платы закрепите их на задней панели с помощью винтов.

За более подробной информацией обращайтесь к полному руководству пользователя.

Подключение кабелей питания к разъемам ATX12V

Обратите внимание, разъем блока питания ATX необходимо вставить в разъем ATX12V до упора, чтобы обеспечить надежное соединение.

Настройка BIOS

По окончании установки аппаратуры включите питание и перейдите в меню BIOS Setup, чтобы настроить параметры процессора. За более подробной информацией обращайтесь к руководству пользователя.

Guida all'installazione veloce Scheda madre AN7

Per maggiori e dettagliate informazioni su questa scheda madre si prega di fare riferimento alla versione integrale del Manuale utente. Questa guida all'installazione veloce è intesa per costruttori esperti di sistemi. Se questa è la prima volta che si cerca di installare un sistema, si consiglia di leggere, innanzi tutto, la versione integrale del manuale oppure di chiedere aiuto ad un tecnico per l'installazione.

Installazione del processore

Questa scheda madre fornisce una presa "Socket 462" ZIF (Zero Insertion Force – forza d'inserimento zero) per installare il processore AMD Socket A. Il processore acquistato dovrebbe essere fornito di dissipatore di calore e ventolina per il raffreddamento. In caso contrario acquistare un dissipatore di calore specifico per la presa Socket A.

Per il montaggio della CPU e del termodissipatore, consultare la figura accanto. Si noti che il gruppo termodissipatore-ventola illustrati possono non essere identici a quelli effettivamente da montare.

1. Individuare il socket 462 sulla scheda madre. Tirare lateralmente la leva di sblocco della CPU e sollevare la CPU completamente.
2. Allineare la tacca della CPU con quella del socket CPU. Appoggiare il processore con il lato di connessione verso il basso nel socket, senza forzare. La CPU può essere montata in una sola direzione. Chiudere la leva di sblocco della CPU.
3. Staccare la pellicola adesiva dal termodissipatore. Rimuovere la pellicola adesiva dal dissipatore. Accertarsi che la superficie del termodissipatore provvista di gradino sia rivolta verso l'estremità del socket indicato come "Socket 462". Applicare il termodissipatore con il lato inferiore verso il basso sul processore fino a coprirlo completamente.
4. Tirare verso il basso il lato corto del clip di ritengo fino ad impegno con la linguetta centrale sul lato inferiore del socket.
5. Con l'aiuto di un cacciavite, inserire la linguetta nella fessura sul lato lungo del clip di ritengo. Spingere il clip verso il basso fino ad impegno con la linguetta centrale della parte superiore del socket. A questo punto, il gruppo termodissipatore-ventola è saldamente fissato al socket CPU.
6. Fissare il connettore ventola del gruppo termodissipatore-ventola al connettore ventola della scheda madre .

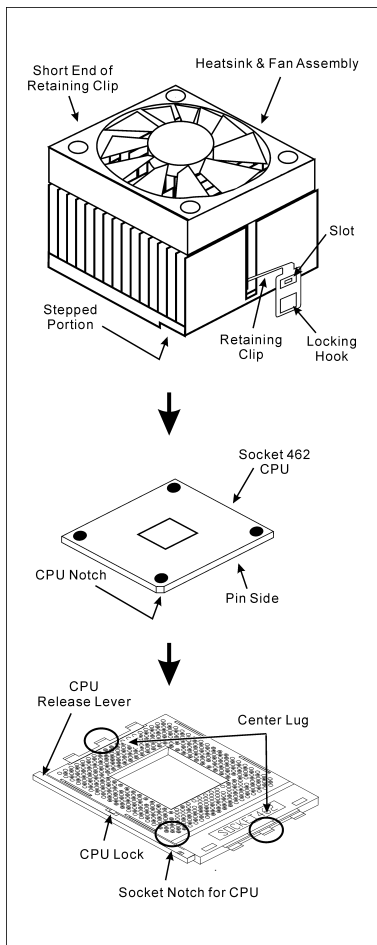

Attenzione: Non dimenticare di impostare la corretta frequenza multipla e BUS per il processore.

Installazione della scheda madre sul telaio

Dopo avere installato il processore sulla scheda madre si può iniziare a fissare la scheda madre sul telaio. Innanzi tutto è necessario fissare la scheda madre al telaio. La maggior parte dei telai ha una base sulla quale sono presenti diversi fori di montaggio che permettono di fissare in modo accurato la scheda madre e, allo stesso tempo, di prevenire corto circuiti. Impiegare le borchie o gli spaziatori attaccati al telaio per fissare la scheda madre.

Installare i moduli RAM

1. Ubicare gli alloggiamenti DIMM sulla scheda.
2. Tenere con delicatezza i lati del modulo DIMM senza toccare i connettori.
3. Allineare la tacca sul modulo con la nervatura dell'alloggiamento.
4. Premere con fermezza il modulo nell'alloggiamento finché le linguette d'espulsione su entrambi i lati dell'alloggiamento scattano sulla tacca di montaggio. Non forzare eccessivamente il modulo DIMM perché quest'ultimo si adatta solamente in una direzione.
5. Per rimuovere i moduli DIMM spingere contemporaneamente le due linguette d'espulsione sull'alloggiamento, poi estrarre il modulo DIMM.

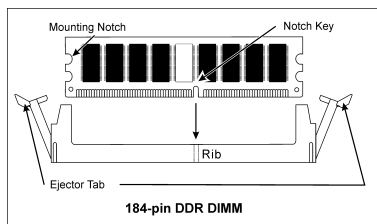

Attenzione: L'elettricità statica può danneggiare i componenti elettronici del computer o delle schede. Prima di iniziare queste procedure, assicurarsi di avere scaricato completamente l'elettricità statica toccando brevemente un oggetto metallico con massa a terra.

Connettori, collettori, interruttori ed adattatori

All'interno della copertura di ogni computer ci sono diversi cavi e prese che devono essere collegati. Questi cavi e prese sono solitamente collegati uno ad uno ai connettori situati sulla scheda madre. È necessario prestare particolare attenzione a qualunque orientamento del collegamento che possono avere i cavi e, se necessario, notare la posizione del primo pin del connettore. Si installeranno alcuni adattatori per particolari necessità quali l'adattatore SCSI, AGP, eccetera. Quando si installano gli adattatori sugli slot della scheda madre, si ricorda di fissarli con le viti anche sul pannello posteriore del telaio.

Per informazioni dettagliate si prega di fare riferimento alla versione integrale del Manuale utente.

Collegamento dei connettori d'alimentazione ai connettori ATX12V

Ricordarsi che è necessario spingere con fermezza fino in fondo il connettore della sorgente d'alimentazione ATX al connettore ATX12V, assicurando così un buon collegamento.

Impostazione BIOS

Quando l'hardware è stato installato completamente, accendere il computer ed andare alla voce BIOS per impostare i parametri del processore. Per informazioni dettagliate si prega di fare riferimento alla versione integrale del Manuale utente.



Chapter 1. Introduction

1-1. Features & Specifications

1. CPU

- Supports AMD-K7 Socket A 266/333/400MHz FSB Processors

2. Chipset

- NVIDIA nForce2 Ultra 400 chipset with MCP-T
- Integrated 128-bit memory controller
- Supports Advanced Configuration and Power Management Interface (ACPI)
- Accelerated Graphics Port connector supports AGP 8X/4X (0.8V/1.5V)

3. Memory

- 3x 184-pin DIMM sockets
- Supports 2 DIMM Un-buffered DDR 400 (Max. 2GB)
- Supports 3 DIMM Un-buffered DDR 200/266/333 (Max. 3GB)

4. ABIT Engineered

- ABIT μ Guru™ Technology
- ABIT SoftMenu™ Technology
- ABIT FanEQ™ Technology
- ABIT MaxFID™ Technology

5. SATA 150 RAID

- Onboard Silicon Image Sil 3112A SATA PCI Controller
- Supports 2 channels of Serial ATA 150MB/s data transfer rate with RAID function (0/1)

6. Audio

- Onboard Realtek ALC658 6-Channel AC 97 CODEC
- Professional digital audio interface supports S/PDIF Input/Output
- NVIDIA SoundStorm™ Technology with real-time Dolby Digital 5.1 encoder

7. LAN

- Onboard RTL8201BL 10/100M LAN Controller

8. IEEE 1394

- Supports IEEE 1394a at 400/200/100 Mb/s transfer rate

9. Internal I/O Connectors

- 1x AGP 8X/4X slot
- 5x PCI slots
- 1x floppy port supports up to 2.88MB
- 2x Ultra DMA 33/66/100/133 connectors

- 2x SATA 150 connectors
- 1x USB header
- 1x IEEE 1394a header
- 1x CD-IN, 1x AUX-IN header

10. Back Panel I/O

- 1x PS/2 keyboard, 1x PS/2 mouse
- 1x Serial port connector, 1x Parallel port connector
- 1x S/PDIF In connector
- 1x S/PDIF Out connector
- AUDIO2 connector (Rear-Left / Rear-Right, Center/Subwoofer)
- AUDIO1 connector (Mic-In, Line-In, Front-Left/Front-Right)
- 2x USB, 1x IEEE 1394a Connector
- 2x USB, 1x RJ-45 LAN Connector

11. Miscellaneous

- ATX form factor
- Hardware Monitoring – Including Fan speed, Voltages, CPU and System temperature

※ **Specifications and information contained herein are subject to change without notice.**

1-2. Layout Diagram

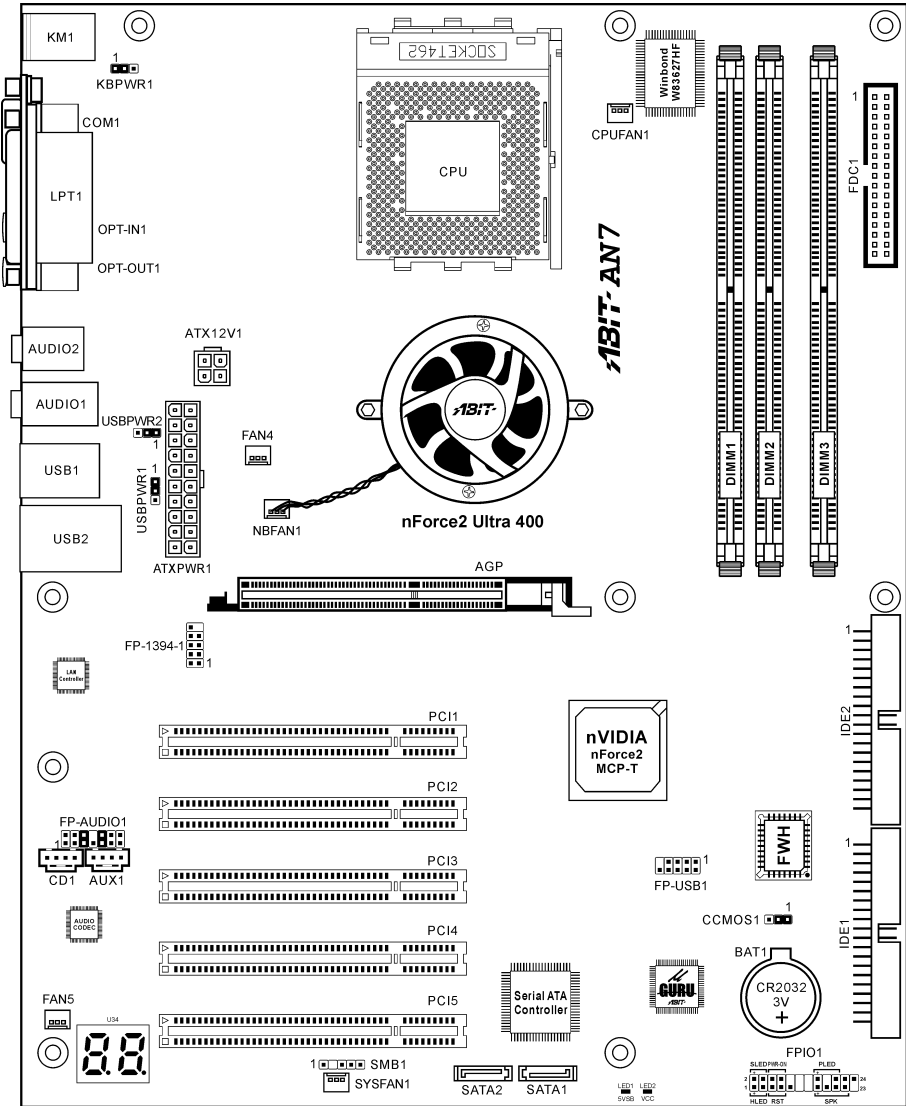



Chapter 2. Hardware Setup

Before the Installation: Turn off the power supply switch (fully turn off the +5V standby power), or disconnect the power cord before installing or unplugging any connectors or add-on cards. Failing to do so may cause the motherboard components or add-on cards to malfunction or damaged.

2-1. Install The Motherboard

Most computer chassis have a base with many mounting holes to allow motherboard to be securely attached on and at the same time, prevented from short circuits. There are two ways to attach the motherboard to the chassis base:

1. use with studs
2. or use with spacers

In principle, the best way to attach the board is to use with studs. Only if you are unable to do this should you attach the board with spacers. Line up the holes on the board with the mounting holes on the chassis. If the holes line up and there are screw holes, you can attach the board with studs. If the holes line up and there are only slots, you can only attach with spacers. Take the tip of the spacers and insert them into the slots. After doing this to all the slots, you can slide the board into position aligned with slots. After the board has been positioned, check to make sure everything is OK before putting the chassis back on.

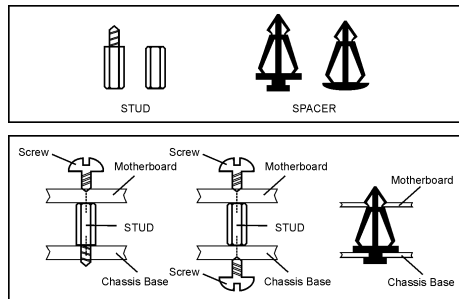

ATTENTION: To prevent shorting the PCB circuit, please REMOVE the metal studs or spacers if they are already fastened on the chassis base and are without mounting-holes on the motherboard to align with.

2-2. Install CPU and Heatsink

Note

- Installing a heatsink and cooling fan is necessary for heat to dissipate from your processor. Failing to install these items may result in overheating and processor damage.
- The AMD Socket A processor will produce a lot of heat while operating, so you need to use a large heat sink that is especially designed for the AMD socket A processor. Otherwise, it may result in overheating and processor damage.
- If your processor fan and its power cable are not installed properly, never plug the ATX power cable into the motherboard. This can prevent possible processor damage.
- Please refer to your processor installation manual or other documentation with your processor for detailed installation instructions.

This motherboard provides a ZIF (Zero Insertion Force) Socket 462 to install AMD Socket A CPU. The CPU you bought should have a kit of heatsink and cooling fan along with. If that's not the case, buy one specially designed for Socket A.

Please refer to the figure shown here to install CPU and heatsink. (For reference only. Your Heatsink & Fan Assembly may not be exactly the same as this one.)

1. Locate the Socket 462 on this motherboard. Pull the CPU release lever sideways to unlatch and then raise it all the way up.
2. Align the CPU notch to the socket notch for CPU. Drop the processor with its pin side down into the CPU socket. Do not use extra force to insert CPU; it only fit in one direction. Close the CPU release lever.
3. Remove the plastic film adhesive on the heatsink. Make sure the stepped portion of the heatsink is facing toward the end of the socket that reads "Socket 462". Put the heatsink faces down onto the processor until it covers the processor completely.
4. Push down the short end of the retaining clip first to lock up with the center lug at the bottom of the socket.
5. Use a screwdriver to insert into the slot at the long end of the retaining clip. Push the clip downward to lock up with the center lug at the top of the socket. The heatsink & fan assembly is now firmly attached on the CPU socket.
6. Attach the fan connector of Heatsink & Fan Assembly with the fan connector on the motherboard.

ATTENTION: Do not forget to set the correct bus frequency and multiple for your processor.

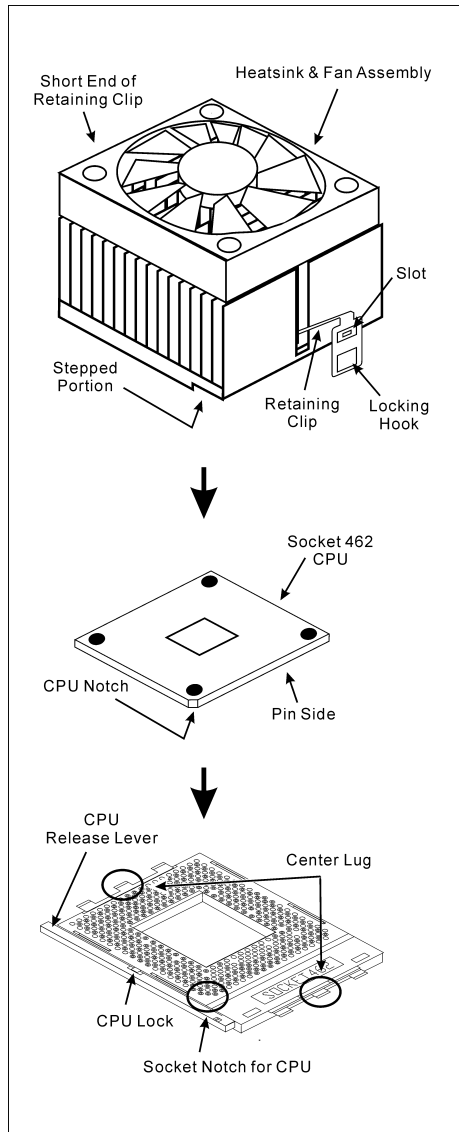

2-3. Install System Memory

This motherboard provides 3 184-pin DDR DIMM sites for memory expansion available from minimum 128MB to maximum 3GB.

Table 2-1. Valid Memory Configurations

Bank	Memory Module	Total Memory
Bank 0, 1 (DIMM1)	128, 256, 512MB, 1GB	128MB ~ 1GB
Bank 2, 3 (DIMM2)	128, 256, 512MB, 1GB	128MB ~ 1GB
Bank 4, 5 (DIMM3)	128, 256, 512MB, 1GB	128MB ~ 1GB
Total System Memory for Un-buffered DDR 200/266/333 DIMM		128MB ~ 3GB
Total System Memory for Un-buffered DDR 400 DIMM		128MB ~ 2GB

NOTE: We suggest you to install DDR SDRAM modules from DIMM3 to DIMM1 sockets in order.

Power off the computer and unplug the AC power cord before installing or removing memory modules.

1. Locate the DIMM slot on the board.
2. Hold two edges of the DIMM module carefully, keep away of touching its connectors.
3. Align the notch key on the module with the rib on the slot.
4. Firmly press the module into the slots until the ejector tabs at both sides of the slot automatically snaps into the mounting notch. Do not force the DIMM module in with extra force as the DIMM module only fit in one direction.
5. To remove the DIMM modules, push the two ejector tabs on the slot outward simultaneously, and then pull out the DIMM module.

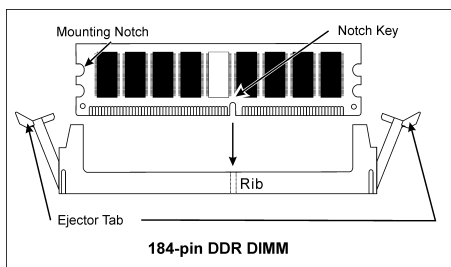

ATTENTION: Static electricity can damage the electronic components of the computer or optional boards. Before starting these procedures, ensure that you are discharged of static electricity by touching a grounded metal object briefly.

2-4. Connectors, Headers and Switches

Here we will show you all of the connectors, headers and switches, and how to connect them. Please read the entire section for necessary information before attempting to finish all the hardware installation inside the computer chassis. A complete enlarged layout diagram is shown in Chapter 1 for all the position of connectors and headers on the board that you may refer to.

WARNING: Always power off the computer and unplug the AC power cord before adding or removing any peripheral or component. Failing to do so may cause severe damage to your motherboard and/or peripherals. Plug in the AC power cord only after you have carefully checked everything.

(1). ATX Power Input Connectors

This motherboard provides two power connectors to connect to an ATX12V power supply with 300W, 20A +5VDC, and 720mA +5VSB capacity at least.

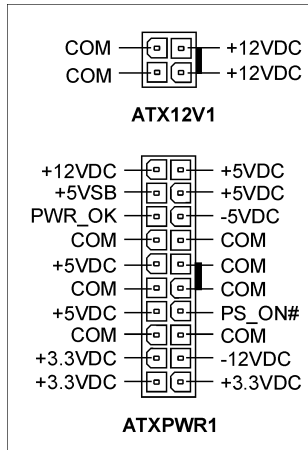
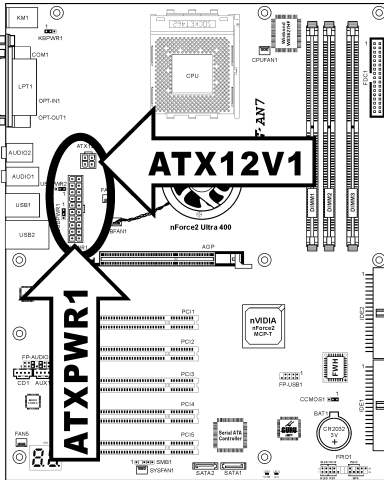

(2). FAN Connectors

These 3-pin connectors each provide power to the cooling fans installed in your system.

- **CPUFAN1:** CPU Fan
- **NBFAN1:** Chipset Fan
- **SYSFAN1:** System Fan
- **FAN4, FAN5:** Auxiliary Fan

WARNING: These fan connectors are not jumpers. DO NOT place jumper caps on these connectors.

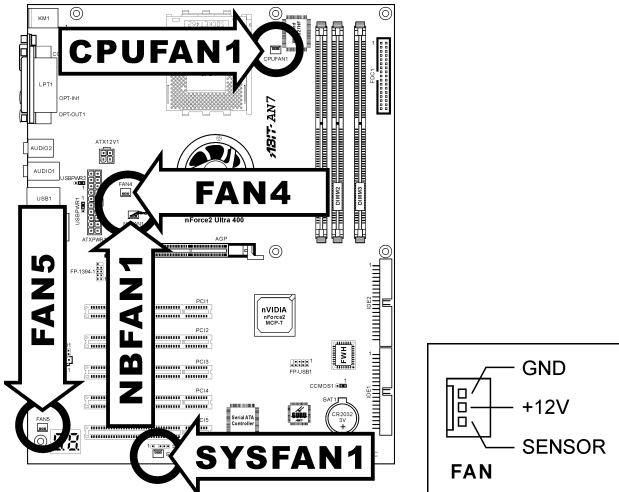

(3). CMOS Memory Clearing Header

This header uses a jumper cap to clear the CMOS memory.

- **Pin 1-2 shorted (default):** Normal operation.
- **Pin 2-3 shorted:** Clear CMOS memory.

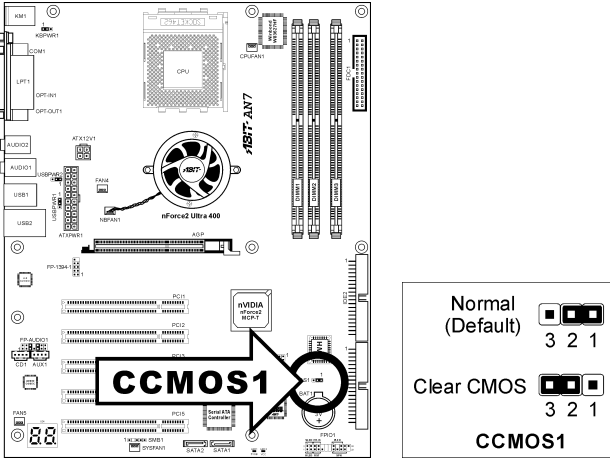

WARNING: Turn the power off first (including the +5V standby power) before clearing the CMOS memory. Failing to do so may cause your system to work abnormally or malfunction.

(4). Wake-up Header

These headers use a jumper cap to enable/disable the wake-up function.

- **KBPWR1:**
Pin 1-2 shorted (default): Disable wake-up function support at Keyboard/Mouse port.
Pin 2-3 shorted: Enable wake-up function support at Keyboard/Mouse port.
- **USBPWR1:**
Pin 1-2 shorted (default): Disable wake-up function support at USB1 port.
Pin 2-3 shorted: Enable wake-up function support at USB1 port.
- **USBPWR2:**
Pin 1-2 shorted (default): Disable wake-up function support at USB2 port.
Pin 2-3 shorted: Enable wake-up function support at USB2 port

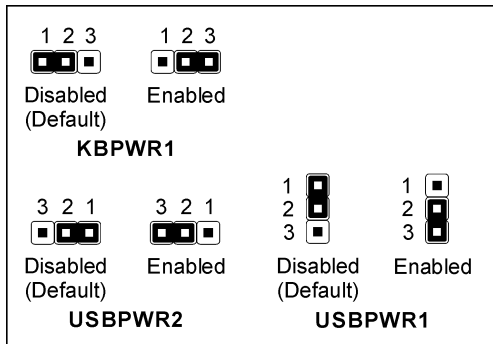
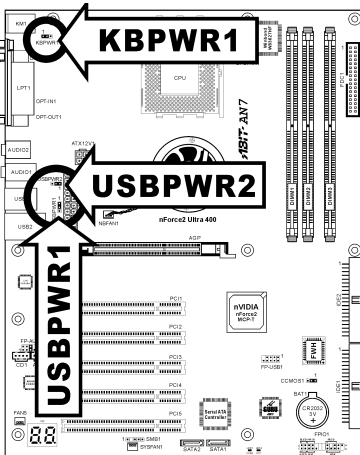

(5). Front Panel Switches & Indicators Headers

This header is used for connecting switches and LED indicators on the chassis front panel.

Watch the power LED pin position and orientation. The mark “+” align to the pin in the figure below stands for positive polarity for the LED connection. Please pay attention to connect these headers. A wrong orientation will only cause the LED not lighting, but a wrong connection of the switches could cause system malfunction.

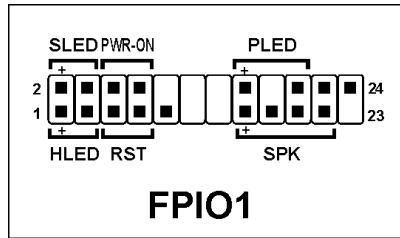
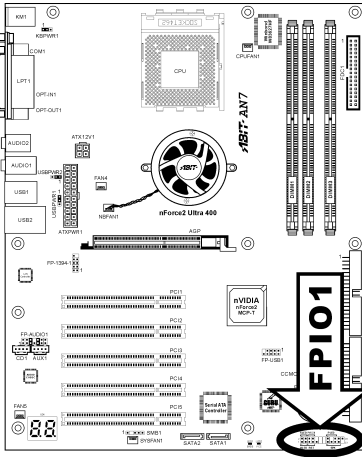

- **HLED (Pin 1, 3):**
Connects to the HDD LED cable of chassis front panel.
- **RST (Pin 5, 7):**
Connects to the Reset Switch cable of chassis front panel.
- **SPK (Pin 15, 17, 19, 21):**
Connects to the System Speaker cable of chassis.
- **SLED (Pin 2, 4):**
Connects to the Suspend LED cable (if there is one) of chassis front panel.
- **PWR-ON (Pin 6, 8):**
Connects to the Power Switch cable of chassis front panel.
- **PLED (Pin 16, 18, 20):**
Connects to the Power LED cable of chassis front panel.

(6). Additional USB Port Header

This header provides 2 additional USB 2.0 ports connection through an USB cable designed for USB 2.0 specifications.

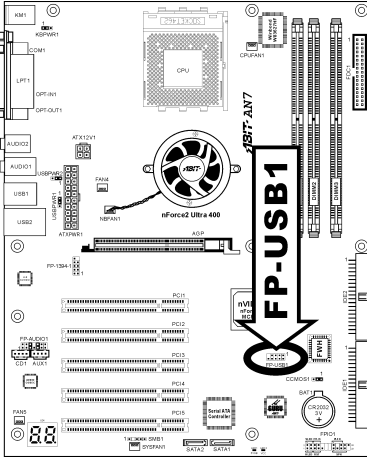

		Pin	Pin Assignment	Pin	Pin Assignment
		1	VCC	2	VCC
		3	Data0 -	4	Data1 -
		5	Data0 +	6	Data1 +
		7	Ground	8	Ground
		9	NC	10	NC

(7). Additional IEEE1394 Port Header

This header provides one additional IEEE1394 port connection through an extension cable and bracket.

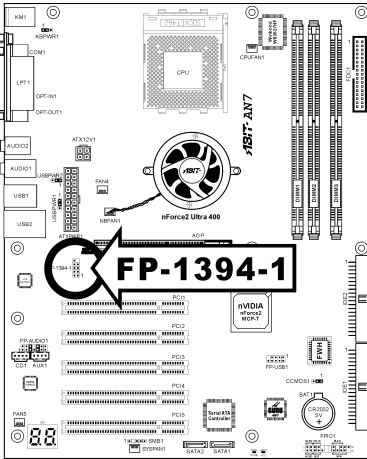

		Pin	Pin Assignment	Pin	Pin Assignment
1	2	1	TPA0 +	2	TPA0 -
3	4	3	GND	4	GND
5	6	5	TPB0 +	6	TPB0 -
7	8	7	+12V	8	+12V
9	10	9	NC	10	GND

(8). Front Panel Audio Connection Header

This header provides the connection to audio connector at front panel.

- To use the audio connector at front panel, remove all the jumpers on this header, and then connect to front panel by the extension cable provided with the chassis.
- To use the audio connector at rear panel, disconnect the extension cable, attach the jumpers back at pin 5-6, and pin 9-10 (default setting).

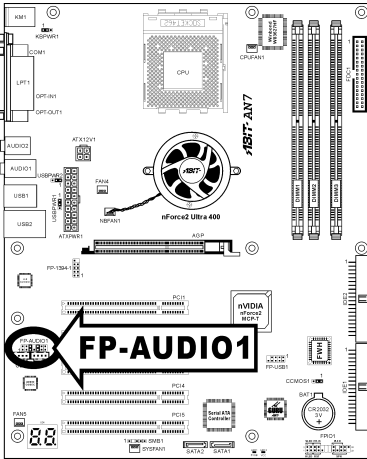

Pin	Pin Assignment	Pin	Pin Assignment
1	Audio Mic.	2	Ground
3	Audio Mic. Bias	4	VCC
5	Speaker Out Right Channel	6	Speaker Out Right Channel Return
7	X	8	NC
9	Speaker Out Left Channel	10	Speaker Out Left Channel Return
11	Ground	12	S/PDIF In
13	VCC	14	S/PDIF Out

FP-AUDIO1

(9). Internal Audio Connectors

These connectors connect to the audio output of internal CD-ROM drive or add-on card.

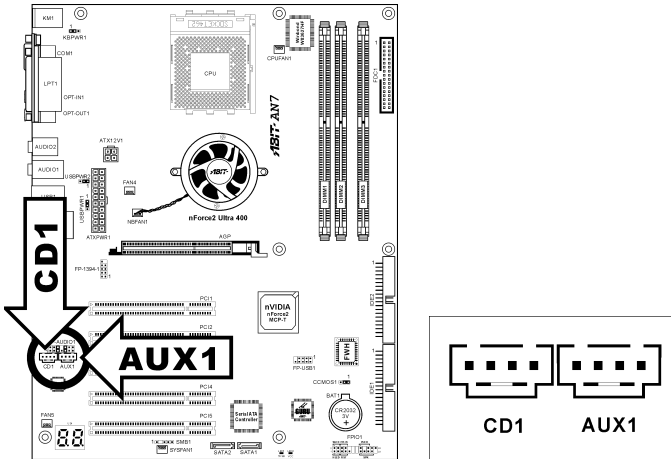

(10). Accelerated Graphics Port Slot

This slot supports an optional AGP graphics card up to AGP 8X mode. Please refer to our Web site for more information on graphics cards.

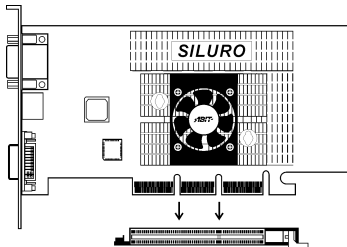
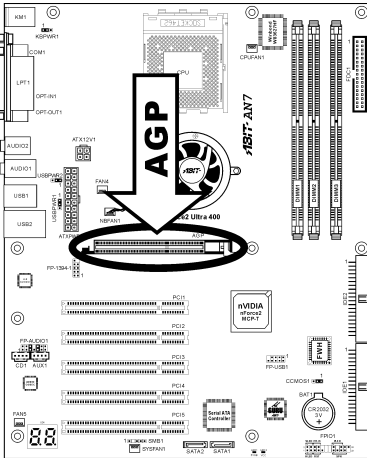

ATTENTION: This motherboard does not support 3.3V AGP cards. Use only 1.5V or 0.8V AGP cards.

(11). Floppy Disk Drive Connector

This connector supports two standard floppy disk drives via a 34-pin 34-conductor ribbon cable.

Connecting the Floppy Disk Drive Cable:

1. Install one end of the ribbon cable into the FDC1 connector. The colored edge of the ribbon cable should be aligned with pin-1 of FDC1 connector.
2. Install the other end(s) of ribbon cable into the disk drive connector(s). The colored edge of the ribbon cable should be also aligned with pin-1 of disk drive connector. The endmost connector should be attached to the drive designated as Drive A.

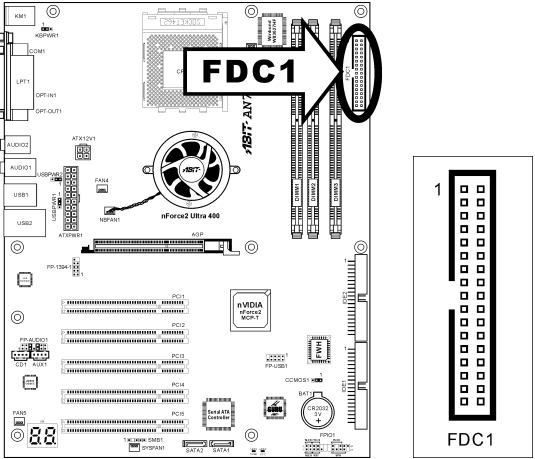

(12). IDE Connectors

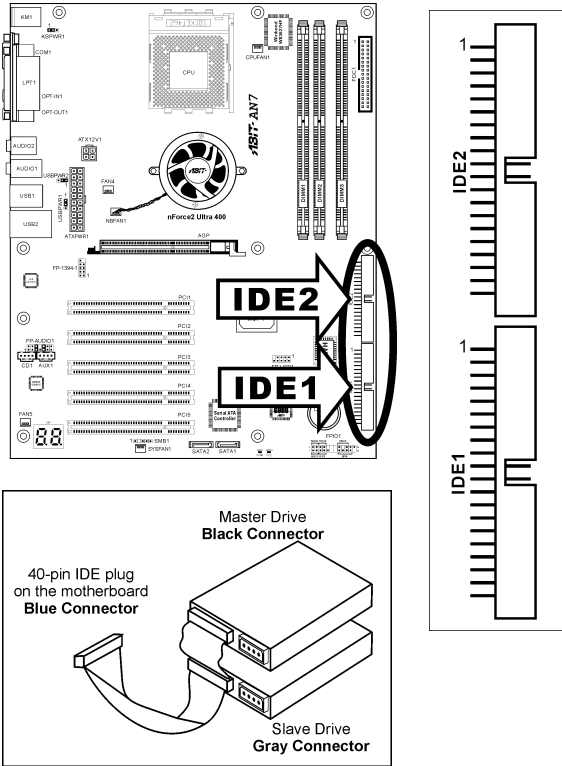

This motherboard provides two IDE ports to connect up to four IDE drives at Ultra DMA mode by Ultra ATA/66 ribbon cables. Each cable has 40-pin 80-conductor and three connectors, providing two hard drives connection with motherboard. Connect the single end (blue connector) at the longer length of ribbon cable to the IDE port on motherboard, and the other two ends (gray and black connector) at the shorter length of the ribbon cable to the connectors on hard drives.

If you want to connect two hard drives together through one IDE channel, you must configure the second drive to Slave mode after the first Master drive. Please refer to the drives' documentation for jumper settings. The first drive connected to IDE1 is usually referred to as "Primary Master", and the second drive as "Primary Slave". The first drive connected to IDE2 is referred to as "Secondary Master" and the second drive as "Secondary Slave".

Keep away from connecting one legacy slow speed drive, like CD-ROM, together with another hard drive on the same IDE channel; this will drop your integral system performance.

(13). Serial ATA Connectors

These connectors are provided to attach one Serial ATA device at each channel via Serial ATA cable.

To enable the SATA1 and SATA2 controller, the item “Serial ATA Controller” must be kept enabled (default setting) in the BIOS menu of “Onboard PCI Device”.

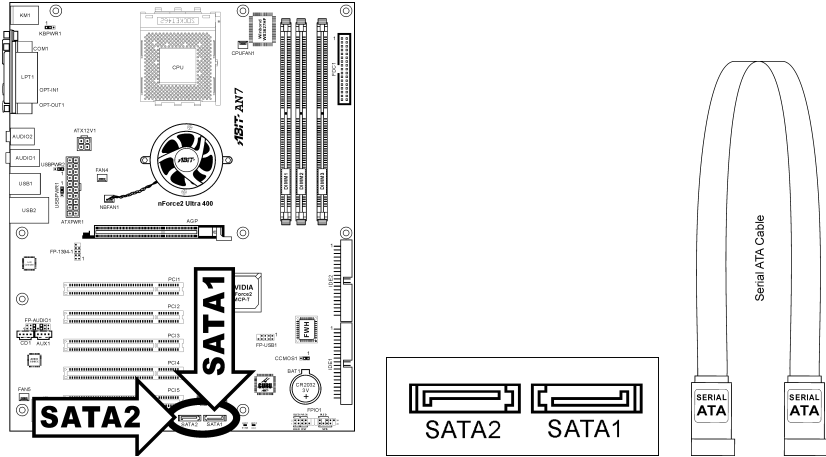

(14). Status Indicators

- **LED1 (5VSB):** This LED lights up when the power supply is connected with power source.
- **LED2 (VCC):** This LED lights up when the system power is on.

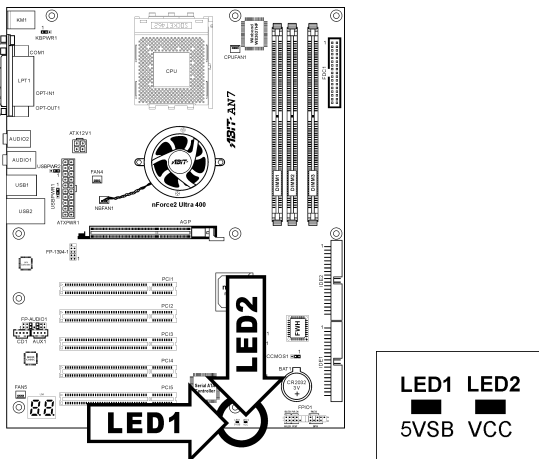

(15). System Management Bus Headers

This header is reserved for system management bus (SM bus). The SM bus is a specific implementation of an I²C bus. I²C is a multi-master bus, which means that multiple chips can be connected to the same bus and each one can act as a master by initiating a data transfer. If more than one master simultaneously tries to control the bus, an arbitration procedure decides which master gets priority.

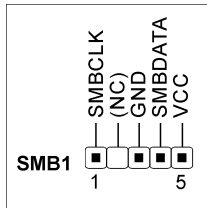
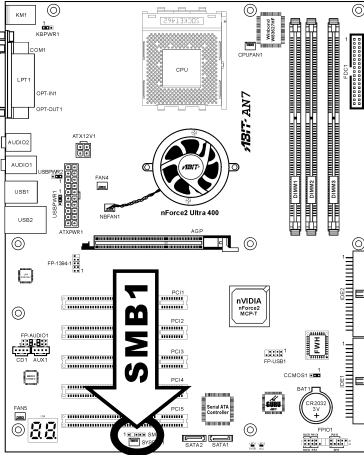

(16). POST Code Display

This is an LED device to display the “POST” Code, the acronym of **Power On Self Test**. The computer will execute the POST action whenever you power on the computer. The POST process is controlled by the BIOS. It is used to detect the status of the computer’s main components and peripherals. Each POST Code corresponds to different checkpoints that are also defined by the BIOS in advance. For example, “memory presence test” is an important checkpoint and its POST Code is “C1”. When the BIOS execute any POST item, it will write the corresponding POST Code into the address 80h. If the POST passes, the BIOS will process the next POST item and write the next POST Code into the address 80h. If the POST fails, we can check the POST Code in address 80h to find out where the problem lies.

This LED device also displays the “POST” Code of AC2003, an “uGuru” chipset developed exclusively by ABIT computer.

NOTE: The decimal point lights up when executing the AC2003 POST action.

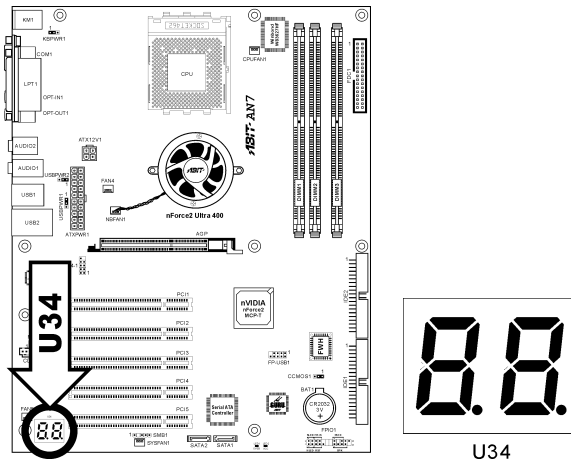

See Appendix for both AWARD and AC2003 POST Code definition.

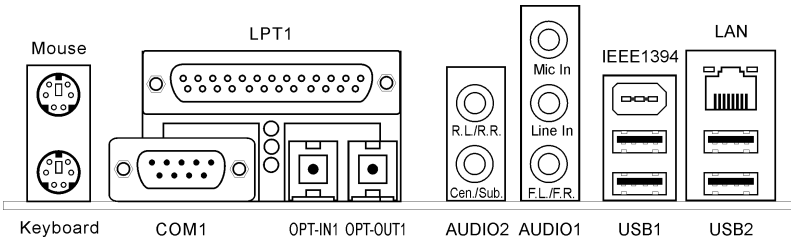
(17). Back Panel Connectors

- **Mouse:** Connects to PS/2 mouse.
- **Keyboard:** Connects to PS/2 keyboard.
- **LPT1:** Connects to printer or other devices that support this communication protocol.
- **COM1:** Connects to external modem, mouse or other devices that support this communication protocol.
- **OPT-IN1:** This connector provides an S/PDIF in connection through optical fiber to digital multimedia devices.
- **OPT-OUT1:** This connector provides an S/PDIF out connection through optical fiber to digital multimedia devices.
- **AUDIO2:**
R.L./R.R. (Rear Left / Rear Right): Connects to the rear left and rear right channel in the 5.1 channel audio system.
Cent./Sub. (Center / Subwoofer): Connects to the center and subwoofer channel in the 5.1 channel audio system.
- **AUDIO1:**
Mic In: Connects to the plug from external microphone.
Line In: Connects to the line out from external audio sources.
F.L./F.R. (Front Left / Front Right): Connects to the front left and front right channel in the 5.1-channel or regular 2-channel audio system.
- **IEEE1394:** Connects to devices of IEEE1394 protocol.
- **LAN:** Connects to Local Area Network.
- **USB1/USB2:** Connects to USB devices such as scanner, digital speakers, monitor, mouse, keyboard, hub, digital camera, joystick etc.

Chapter 3. BIOS Setup

This motherboard provides a programmable EEPROM that you can update the BIOS utility. The BIOS (Basic Input/Output System) is a program that deals with the basic level of communication between processor and peripherals. Use the BIOS Setup program only when installing motherboard, reconfiguring system, or prompted to “Run Setup”. This chapter explains the Setup Utility of BIOS utility.

After powering up the system, the BIOS message appears on the screen, the memory count begins, and then the following message appears on the screen:

PRESS DEL TO ENTER SETUP

If this message disappears before you respond, restart the system by pressing <Ctrl> + <Alt> + keys, or by pressing the Reset button on computer chassis. Only when it failed by these two methods can you restart the system by powering it off and then back on.

After pressing key, the main menu screen appears.

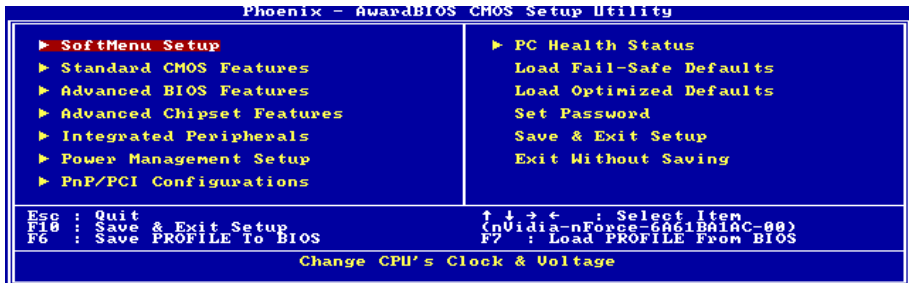

NOTE: In order to increase system stability and performance, our engineering staffs are constantly improving the BIOS menu. The BIOS setup screens and descriptions illustrated in this manual are for your reference only, may not completely match what you see on your screen.

In the BIOS Setup main menu, you can see several options. We will explain these options step by step in the following pages of this chapter, but let us first see a short description of the function keys you may use here.

Esc:

Press this button to quit the BIOS Setup.

↑ ↓ → ←:

Press these buttons to choose, in the main menu, the option you want to confirm or to modify.

F10:

When you have completed the setup of BIOS parameters, press this button to save these parameters and to exit the BIOS Setup menu.

F6:

You may create a profile to save the new BIOS settings in it. Press <F6> button in the main menu, a dialog box with five numbers (1~5) will appear on the screen. Select one number, and press <Enter>. Then, you will get a confirmation dialog box with a message similar to:

Save Profile To BIOS (Y/N)?

After pressing “Y”, the following message will appear to assist you in creating a name for the profile.

Enter Profile Name:

Type the profile name, and press <Enter>. The new BIOS settings now are saved to the selected profile.

NOTE: You may save up to five profiles to BIOS.

F7:

Press <F7> button in the main menu, a dialog box with five numbers (1~5) will appear on the screen. Select the profile you want, and press <Enter>. Then, you will get a confirmation dialog box with a message similar to:

Load Profile From BIOS (Y/N)?

Press “Y” to load the BIOS settings in this profile.

3-1. SoftMenu Setup

The SoftMenu utility is ABIT's exclusive and ultimate solution in programming the CPU operating speed. All the parameters regarding CPU FSB speed, multiplier factor, the AGP & PCI clock, and even the CPU core voltage are all available at your fingertips.

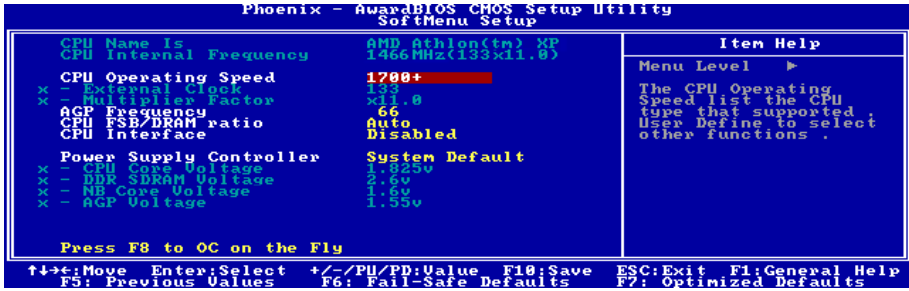

CPU Name Is:

This item displays the CPU model name, for example: AMD Athlon(tm) XP.

CPU Internal Frequency:

This item displays the CPU internal clock speed.

CPU Operating Speed:

This item displays the CPU operating speed according to the type and speed of your CPU. You can also select the [User Define] option to enter the manual option.

User Define:

WARNING: The wrong settings of the multiplier and external clock in certain circumstances may cause CPU damage. Setting the working frequency higher than the PCI chipset or processor specs, may cause abnormal memory module functioning, system hangs, hard disk drive data lose, abnormal functioning of the VGA card, or abnormal functioning with other add-on cards. Using non-specification settings for your CPU is not the intention of this explanation. These should be used for engineering testing, not for normal applications.

There will be no guaranty for the settings beyond specification, any damage of any component on this motherboard or peripherals result therein is not our responsibility.

* **External Clock:**

This item sets the CPU Front Side Bus speed from 100 to 300. Due to the specification limit of the CPU you installed, the speed you set over its standard bus speed is supported, but not guaranteed.

* **Multiplier Factor:**

This item sets the multiplier factor for the CPU you installed.

NOTE: Some processors might have this multiplier factor locked, so there is no way to choose a higher multiplier factor.

AGP Frequency:

This item allows you to set the AGP clock speed from 66MHz to 99MHz. Due to the AGP specification limit, the speed you set over its standard clock speed is supported, but not guaranteed.

CPU FSB/DRAM ratio:

This item allows you to set the frequency ratio between CPU and DRAM.

CPU Interface:

Two options are available: Disabled → Enabled. The default setting is *Disabled*. When set to *Disabled*, the system uses the most stable CPU/FSB parameters. If you choose *enabled*, the system will use overclocked CPU/FSB parameters.

Power Supply Controller:

This option allows you to switch between the default and user-defined voltages. Leave this setting to default unless the current voltage setting cannot be detected or is not correct. The option “**User Define**” enables you to select the following voltages manually.

※ **CPU Core Voltage:**

This item selects the CPU core voltage.

※ **DDR SDRAM Voltage:**

This item selects the voltage for DRAM slot.

※ **NB Core Voltage:**

This item selects the NB core voltage.

※ **AGP Voltage:**

This item selects the voltage for AGP slot.

ATTENTION: A wrong voltage setting may cause the system unstable or even damage the CPU. Please leave it to default settings unless you are fully aware of its consequences.

Press F8 to OC on the Fly:

After a new configuration on items “External Clock” and “Voltage”, pressing <F8> button now in this menu will make it become effective immediately.

ATTENTION: An external clock too much over its specification may cause the system unstable or even fail, please proceed with highly attention.

3-2. Standard CMOS Features

This section contains the basic configuration parameters of the BIOS. These parameters include date, hour, VGA card, FDD and HDD settings.



Date (mm:dd:yy):

This item sets the date you specify (usually the current date) in the format of [Month], [Date], and [Year].

Time (hh:mm:ss):

This item sets the time you specify (usually the current time) in the format of [Hour], [Minute], and [Second].

IDE Primary Master / Slave and IDE Secondary Master / Slave:

Click <Enter> key to enter its submenu:



IDE HDD Auto-Detection:

This item allows you to detect the parameters of IDE drives by pressing <Enter> key. The parameters will be shown on the screen automatically.

IDE Primary Master / Slave and IDE Secondary Master / Slave:

When set to [Auto], the BIOS will automatically check what kind of IDE drive you are using. If you want to define your own drive by yourself, set it to [Manual] and make sure you fully understand the meaning of the parameters. Please refer to the instruction manual provided by the device's manufacturer to get the setting right.

Access Mode:

This item selects the mode to access your IDE devices. Leave this item to its default [Auto] setting to detect the access mode of your HDD automatically.

Capacity:

This item displays the approximate capacity of the disk drive. Usually the size is slightly greater than the size of a formatted disk given by a disk-checking program.

Cylinder:

This item configures the numbers of cylinders.

Head:

This item configures the numbers of read/write heads.

Precomp:

This item displays the number of cylinders at which to change the write timing.

Landing Zone:

This item displays the number of cylinders specified as the landing zone for the read/write heads.

Sector:

This item configures the numbers of sectors per track.

 Back to Standard CMOS Features Setup Menu:

Drive A & Drive B:

This item sets the type of floppy drives (usually only Drive A) installed.

Floppy 3 Mode Support:

This item allows you to use "3 Mode Floppy Drive" in Japanese computer system by selecting drive A, B, or both. Leave this item to its default [Disabled] setting if you are not using this Japanese standard floppy drive.

Video:

This item selects the type of video adapter used for the primary system monitor.

[EGA/VGA]: (Enhanced Graphics Adapter/Video Graphics Array) For EGA, VGA, SVGA and PGA monitor adapters.

[CGA 40]: (Color Graphics Adapter) Power up in 40-column mode.

[CGA 80]: (Color Graphics Adapter) Power up in 80-column mode.

[Mono]: (Monochrome adapter) Includes high-resolution monochrome adapters.

Halt On:

This item determines whether the system stops if an error is detected during system boot-up.

[All Errors]: The system-boot will stop whenever the BIOS detect a non-fatal error.

[No Errors]: The system-boot will not stop for any error detected.

[All, But Keyboard]: The system-boot will stop for all errors except a keyboard error.

[All, But Diskette]: The system-boot will stop for all errors except a diskette error.

[All, But Disk/Key]: The system-boot will stop for all errors except a diskette or keyboard error.

Base Memory:

This item displays the amount of base memory installed in the system. The value of the base memory is typically 640K for system with 640K or more memory size installed on the motherboard.

Extended Memory:

This item displays the amount of extended memory detected during system boot-up.

Total Memory:

This item displays the total memory available in the system.

3-3. Advanced BIOS Features

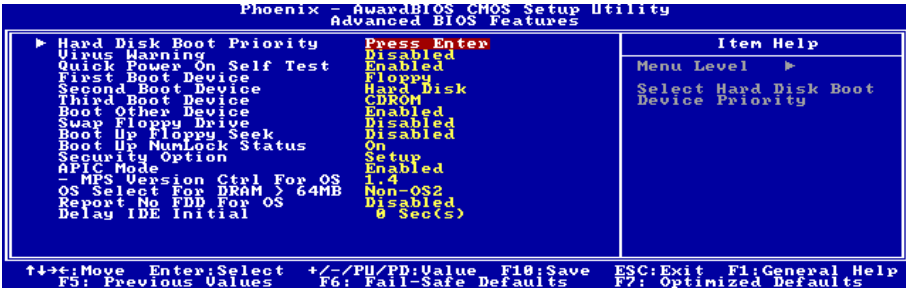

Hard Disk Boot Priority:

This item selects the hard disks booting priority. By pressing <Enter> key, you can enter its submenu where the hard disks detected can be selected for the booting sequence to boot up system.

This item functions only when there is the option of [Hard Disk] in any one of the First/Second/Third Boot Device items.

Virus Warning:

When set to [Enabled], the BIOS will monitor the boot sector and partition table of the hard disk drive. If there is any attempt of writing to the boot sector or partition table of the hard disk drive, the BIOS will halt the system and an error message will appear.

Quick Power On Self Test:

When set to [Enabled], this item speeds up the Power On Self Test (POST) after powering on the system. The BIOS shorten or skip some check during the POST.

First Boot Device / Second Boot Device / Third Boot Device / Boot Other Device:

Select the drive to boot first, second and third in the [First Boot Device], [Second Boot Device], and [Third Boot Device] items respectively. The BIOS will boot the operating system according to the sequence of the drive selected. Set [Boot Other Device] to [Enabled] if you wish to boot from another device other than these three items.

Swap Floppy Drive:

When set to [Enabled], and the system is booting from the floppy drive, the system will boot from drive B instead of the regular drive A. There must be two floppy drives connected in the system to use this function.

Boot Up Floppy Seek:

When set to [Enabled], the BIOS will check whether the floppy disk drive is installed or not.

Boot Up NumLock Status:

This item determines the default state of the numeric keypad at system booting up.

[On]: The numeric keypad functions as number keys.

[Off]: The numeric keypad functions as arrow keys.

Security Option:

This item determines when the system will prompt for password - every time the system boots or only when enters the BIOS setup.

[Setup]: The password is required only when accessing the BIOS Setup.

[System]: The password is required each time the computer boots up.

NOTE: Don't forget your password. If you forget the password, you will have to open the computer case and clear all information in the CMOS before you can start up the system. But by doing this, you will have to reset all previously set options.

APIC Mode:

Leave this item to its default setting.

MPS Version Ctrl For OS:

This item specifies which version of MPS (Multi-Processor Specification) this motherboard will use. The options are 1.1 and 1.4. The default setting is **1.4**. If you use an older OS for dual processor executing, please set this option to 1.1.

OS Select For DRAM > 64MB:

This item allows you to access the memory that is over 64MB in OS/2. Leave this item to its default [Non-OS2] setting for operating system other than OS/2.

Report No FDD For OS:

When set to [Enabled], this item allows you to run some older operating system without floppy disk drive. Leave this item to its default setting.

Delay IDE Initial:

This item allows the BIOS to support some old or special IDE devices by prolonging this delay time. A larger value will give more delay time to the device for which to initialize and to prepare for activation.

3-4. Advanced Chipset Features

Phoenix - AwardBIOS CMOS Setup Utility Advanced Chipset Features		Item Help
Enhance PCI Performance	Disabled	
CPU Disconnect Function	Enabled	
Memory Timings	Optimal	
- Row-active delay	7	Menu Level ▶
- RAS-to-CAS delay	1	[Optimall] - Use the most stable settings.
- Row-precharge delay	1	
- CAS Latency	2.5	[Aggressive/Turbo] - Use over clocked settings for higher performance but with higher risk of instability.
FSB Spread Spectrum	0.50 %	
ACP Spread Spectrum	0.50 %	
ACP Aperture Size	32M	
ACP Data Transfer Rate	Auto	
ACP Fast Write Capability	Enabled	
CPU Thermal-Throttling	50.0 %	
System BIOS Cacheable	Enabled	
Video RAM Cacheable	Enabled	[Expert] - Allows full customization of performance options. Advanced users only.

↑←→: Move Enter: Select +/~/PU/PD: Value F10: Save ESC: Exit F1: General Help
F5: Previous Values F6: Fail-Safe Defaults F7: Optimized Defaults

Enhance PCI Performance:

Two options are available: Disabled → Enabled. The default setting is *Disabled*. This item can improve the PCI transmission performance.

CPU Disconnect Function:

When set to [Enabled], the system will disconnect the S2K FSB on a C1 state change.

Memory Timings:

Five options are available: Optimal → Aggressive → Turbo → By SPD → Expert. The default setting is *Optimal*. Choose *Optimal* for better memory compatibility; choose *Aggressive/Turbo* for better memory performance; choose *Expert* for user-define. When set to *By SPD*, the BIOS will read the DRAM module SPD data and automatically set to the values stored in it.

* **Row-active delay:**

Fifteen options are available: from 1 to 15. This option specifies the row active time. This is the minimum number of cycles between an activate command and a precharge command to the same bank.

* **RAS-to-CAS delay:**

Seven options are available: from 1 to 7. This item is to set SDR/DDR SDRAM RAS to CAS delay. It can define the SDRAM ACT to Read/Write command period.

* **Row-precharge delay:**

Seven options are available: from 1 to 7. This item controls the idle clocks after issuing a precharge command to the DRAM.

* **CAS Latency:**

Three options are available: 2.0 → 2.5 → 3.0. The default setting is 2.5. You can select SDRAM CAS (Column Address Strobe) latency time according your SDRAM specification.

FSB Spread Spectrum:

Three options are available: Disabled → 0.50% → 1.00%. The default setting is 0.50%.

AGP Spread Spectrum:

Two options are available: Disabled → 0.50%. The default setting is 0.50%.

AGP Aperture Size:

This option specifies the amount of system memory that can be used by the AGP device. The aperture is a portion of the PCI memory address range dedicated for graphics memory address space.

AGP Data Transfer Rate:

This item selects the data transfer rate of AGP device. A higher rate delivers faster and better graphics to your system. Make sure your graphics card supports the mode you select.

AGP Fast Write Capability:

Two options are available: Disabled → Enabled. The default setting is *Enabled*. If your AGP adapter can support this function, then you can choose *Enabled*. Otherwise, choose *Disabled*.

CPU Thermal-Throttling:

Eight options are available: Disabled → 87.5% → 75.0% → 62.5% → 50.0% → 37.5% → 25.0% → 12.5%. The default setting is 50.0%.

System BIOS Cacheable:

Two options are available: Disabled or Enabled. The default setting is *Enabled*. When you select *Enabled*, you get faster system BIOS executing speed via the L2 cache.

Video RAM Cacheable:

Two options are available: Disabled or Enabled. The default setting is *Enabled*. When you select *Enable*, you get faster video RAM executing speed via the L2 cache. You must check your VGA adapter manual to find out if any compatibility problems will occur.

3-5. Integrated Peripherals



OnChip IDE Device:

Click <Enter> key to enter its submenu:

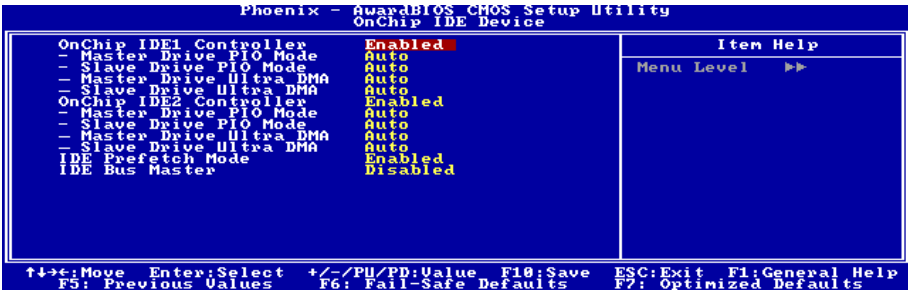

OnChip IDE1 Controller:

This item allows you to enable or disable the primary and secondary IDE controller. Select [Disabled] if you want to add a different hard drive controller.

* Master/Slave Drive PIO Mode

The PIO (Programmed Input/Output) mode allows the BIOS to tell the controller what it wants and then let the controller and the CPU perform the complete task, rather than having the BIOS issue a series of commands to affect a transfer to or from the disk drive.

[Auto]: The BIOS will select the best available mode after checking your disk drive.

[Mode 0-4]: You can select a mode that matches your disk drive's timing. Do not use the wrong setting or you will have drive errors.

* Master/Slave Drive Ultra DMA

This item allows you to set the Ultra DMA in use.

[Auto]: The BIOS will select the best available option after checking your hard drive or CD-ROM.

[Disabled]: The BIOS will not detect these categories. If problem arises in using Ultra DMA devices, try disabling this item.

OnChip IDE2 Controller:

The description is same as the *OnChip IDE1 Controller*.

IDE Prefetch Mode:

Two options are available: Disabled or Enabled. The default setting is *Enabled*. The onboard IDE drive interfaces supports IDE prefetching for faster drive accesses. If you install a primary and/or secondary add-in IDE interface, set this field to *Disabled* if the interface does not support prefetching.

IDE Bus Master:

This option enables or disables the IDE bus mastering capability under the DOS environment.

↩ Back to Integrated Peripherals Setup Menu:

OnChip PCI Device:

Click <Enter> key to enter its submenu:

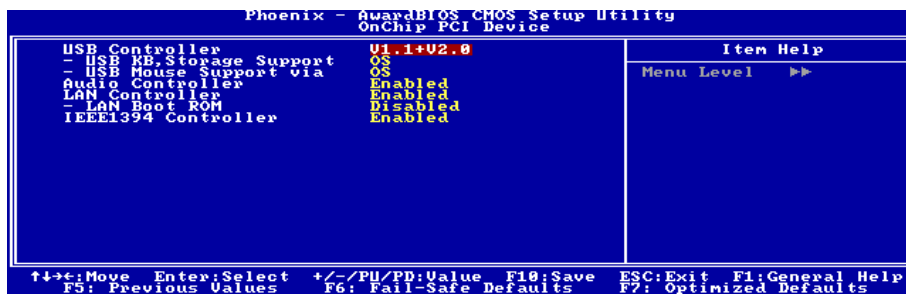

USB Controller:

Three options are available: Disabled → V1.1+V2.0 → V1.1. The default setting is *V1.1+V2.0*. If you choose to disable this item, the “USB Keyboard Support” and “USB Mouse Support” items will not be able to select in *Integrated Peripherals* menu.

* USB KB, Storage Support:

This item allows you to select **[BIOS]** for using USB keyboard/USB storage device in DOS environment, or **[OS]** in OS environment.

* USB Mouse Support:

This item allows you to select **[BIOS]** for using USB mouse in DOS environment, or **[OS]** in OS environment.

Audio Controller:

This option enables or disables the audio controller.

LAN Controller:

This option enables or disables the LAN controller.

* **LAN Boot ROM:**

This item allows you to use the boot ROM (instead of a disk drive) to boot-up the system and access the local area network directly.

IEEE1394 Controller:

This option enables or disables the IEEE 1394 controller.

↩ **Back to Integrated Peripherals Setup Menu:**

Onboard PCI Device:

Click <Enter> key to enter its submenu:

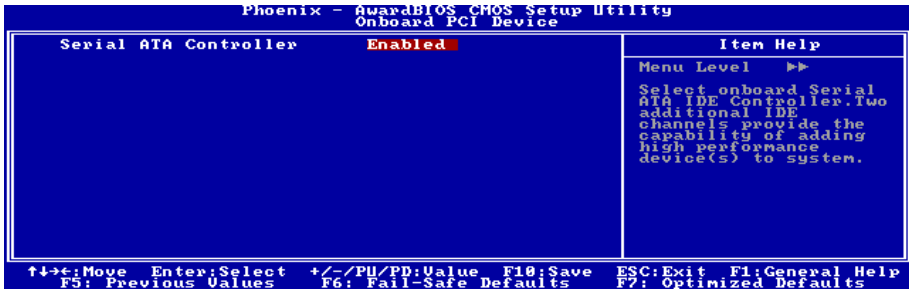
**Serial ATA Controller:**

This option enables or disables the onboard Silicon Image SIL3112A SATA controller.

↩ **Back to Integrated Peripherals Setup Menu:**

Init Display First:

This item selects to initialize AGP or PCI Slot first when the system boots.

[PCI Slot]: When the system boots, it will first initialize PCI.

[AGP]: When the system boots, it will first initialize AGP.

EXT-P2P's Discard Time:

This item allows you to set EXT-P2P's discard time.

Onboard FDD Controller:

Two options are available: Enabled and Disabled. The default setting is *Enabled*. You can enable or disable the onboard FDD controller.

Onboard Serial Port 1:

This is used to specify the I/O address and IRQ of Serial Port 1. Six options are available: Disabled → 3F8/IRQ4 → 2F8/IRQ3 → 3E8/IRQ4 → 2E8/IRQ3 → AUTO. The default setting is **3F8/IRQ4**.

Onboard Parallel Port:

Sets the I/O address and IRQ of the onboard parallel port. Four options are available: Disabled → 378/IRQ7 → 278/IRQ5 → 3BC/IRQ7. Default setting is **378/IRQ7**.

* **Parallel Port Mode:**

Four options are available: SPP → EPP → ECP → ECP+EPP. The default setting is **ECP+EPP** mode.

* **EPP Mode Select:**

Two options are available: EPP1.7 → EPP1.9. The default setting is **EPP 1.9**. When the mode selected for the parallel port mode is EPP, the two EPP version options are available.

* **ECP Mode Use DMA:**

Two options are available: 1 → 3. The default setting is **3**. When the mode selected for the parallel port mode is ECP, the DMA channel selected can be Channel 1 or Channel 3.

3-6. Power Management Setup

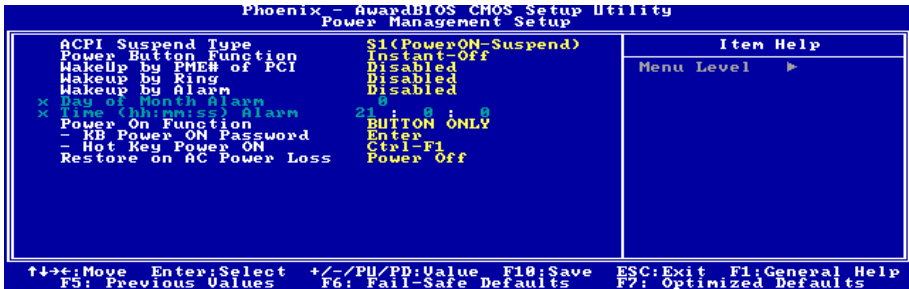

ACPI Suspend Type:

This item selects the type of Suspend mode.

[S1(PowerOn-Suspend)]: Enables the Power On Suspend function.

[S3(Suspend-To-RAM)]: Enables the Suspend to RAM function.

Power Button Function:

This item selects the method of powering off your system:

[Instant-Off]: Pressing and then releasing the power button at once will immediately power off the system.

[Delay 4 Sec.]: Pushing the power button for more than 4 seconds will power off the system. This will prevent the system from powering off in case you accidentally hit or pushed the power button.

WakeUp by PME# of PCI:

Two options are available: Disabled or Enabled. The default setting is *Disabled*. When set to *Enabled*, any event affecting from PCI card (PME) will awaken a system that has powered down.

WakeUp by Ring:

Two options are available: Disabled or Enabled. The default setting is *Disabled*. When set to *Enabled*, any event affecting from Modem Ring will awaken a system that has powered down.

WakeUp by Alarm:

Two options are available: Disabled or Enabled. The default setting is *Disabled*. When set to *Enabled*, you can set the date and time at which the RTC (real-time clock) alarm awakens the system from Suspend mode.

* Day of Month Alarm/ Time (hh:mm:ss) Alarm:

You can set the Date (month) Alarm and Time Alarm (hh:mm:ss). Any event occurring will awaken a system that has powered down.

Power On Function:

This item selects the way you want your system to power on.

[Password]: Use a password to power on the system, select this option then press <Enter>. Enter your password. You can enter up to 5 characters. Type in exactly the same password to confirm, and then press <Enter>.

[Hot KEY]: Use any of the function keys between <F1> to <F12> to power on the system.

[Mouse Left]: Double click the mouse left button to power on the system.

[Mouse Right]: Double click the mouse right button to power on the system.

[Any KEY]: Use any keyboard keys to power on the system.

[BUTTON ONLY]: Use only the power button to power on the system.

[Keyboard 98]: Use the power-on button on the “Keyboard 98” compatible keyboard to power on the system.

NOTE: To enable this “Power On” function, the wake-up header of [KBPWR1], [USBPWR1], [USBPWR2] must be set to [Enabled] position. Please refer to the configuration of “Wake-up Header” [KBPWR1], [USBPWR1], and [USBPWR2] in section 2-4, chapter 2.

The mouse wake up function can only be used with the PS/2 mouse, not with the COM port or USB type. Some PS/2 mice cannot wake up the system because of compatible problems. If the specs of your keyboard are too old, it may fail to power on.

※ **KB Power On Password:**

When you press the <Enter> key, then you can enter the password you want. When set be done, you need to saving and leave the BIOS setting menu to reboot your computer system. **Next time when you shutdown your computer, you can’t use the power button to turn on the computer power anymore.** You need to press the password to turn on your computer power.

※ **Hot Key Power On:**

Fifteen options are available: Ctrl+F1 ~ Ctrl+F12, Power, Wake and Any Key. The default setting is *Ctrl+F1*. You can choose the hot key that you want it to turn on your computer power.

Restore on AC Power Loss:

This item selects the system action after an AC power failure.

[Power Off]: When power returns after an AC power failure, the system’s power remains off. You must press the Power button to power-on the system.

[Power On]: When power returns after an AC power failure, the system’s power will be powered on automatically.

[Last State]: When power returns after an AC power failure, the system will return to the state where you left off before power failure occurs. If the system’s power is off when AC power failure occurs, it will remain off when power returns. If the system’s power is on when AC power failure occurs, the system will power-on when power returns.

3-7. PnP/PCI Configurations



Reset Configuration Data:

When set to [Enabled], the BIOS will reset the ESCD (Extended System Configuration Data) once automatically next time you boot up. It will then recreate a new set of configuration data. But the next time you boot up, this option will automatically be set as Disabled.

Resources Controlled By:

This item configures all of the boot and Plug-and-Play compatible devices.

[Auto(ESCD)]: The system will automatically detect the settings.

[Manual]: Choose the specific IRQ resources in the “IRQ Resources” menu.

* IRQ Resources:

Click <Enter> key to enter its submenu:

This item sets each system interrupt to either [PCI Device] or [Reserved].

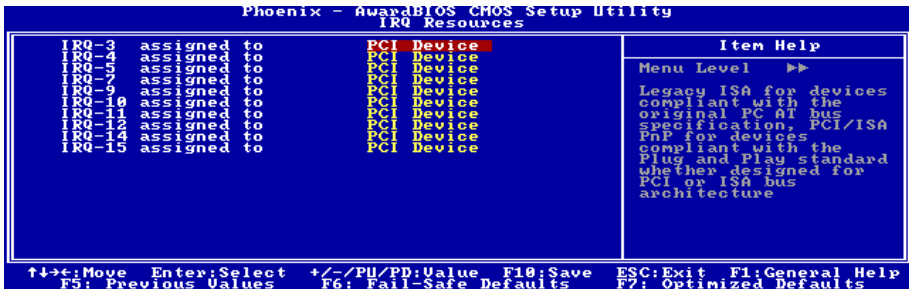

↩ **Back to PnP/PCI Configurations Setup Menu:**

PCI/VGA Palette Snoop:

This item determines whether the MPEG ISA/VESA VGA cards can work with PCI/VGA or not.

[Disabled]: MPEG ISA/VESA VGA cards do not work with PCI/VGA.

[Enabled]: MPEG ISA/VESA VGA cards work with PCI/VGA.

Assign IRQ For VGA:

This item assigns an IRQ for the VGA card installed.

[Enabled]: Automatically assign an IRQ for the VGA card installed.

[Disabled]: The IRQ that was previously occupied by the VGA card will be available for new device.

Assign IRQ For USB:

This item assigns an IRQ for the USB device connected.

[Enabled]: Automatically assign an IRQ for the USB device connected.

[Disabled]: The IRQ that was previously occupied by the USB device connected will be available for new device.

PCI Latency Timer(CLK):

The DEC (decimal) numbers from 0 to 255 are available, with the default setting at 32. This item can let you set the PCI latency clock delay time. Which means, you can set how many clocks you want it delay.

INT Pin 1 Assignment ~ INT Pin 4 Assignment:

This item specifies the IRQ number manually or automatically for the devices installed on PCI slots.

For the relations between the hardware layout of PIRQ (the signals from the south bridge chipset), INT# (means PCI slot IRQ signals) and devices, please refer to the table below:

Signals	PCI-1	PCI-2	PCI-3	PCI-4	PCI-5	SATA
PIRQ_0 Assignment	INT C	INT D	INT A	INT B	INT C	
PIRQ_1 Assignment	INT D	INT A	INT B	INT C	INT D	
PIRQ_2 Assignment	INT A	INT B	INT C	INT D	INT A	INT A
PIRQ_3 Assignment	INT B	INT C	INT D	INT A	INT B	

NOTE:

- PCI slot 1 shares IRQ signals with PCI-5, and SATA.
- If you want to install two PCI cards into those PCI slots that share IRQ with one another at the same time, you must make sure that your OS and PCI devices' driver supports the IRQ sharing function.

3-8. PC Health Status

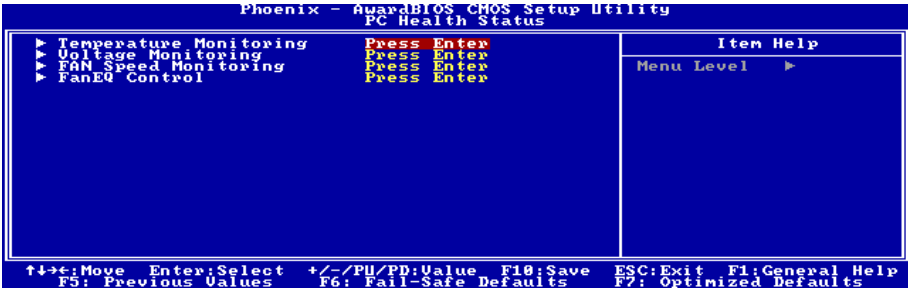

↳ Temperature Monitoring:

Click <Enter> key to enter its submenu:

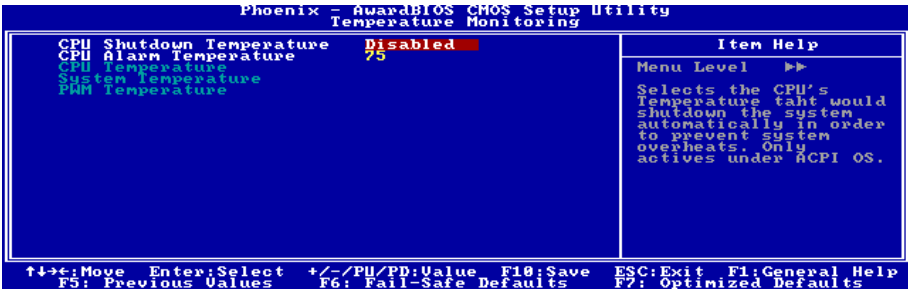

CPU Shutdown Temperature:

This item sets the temperature that would shutdown the system automatically in order to prevent system overheats.

NOTE: The CPU shutdown temperature limit must be higher than the CPU alarm temperature limit.

CPU Alarm Temperature:

This item selects the CPU's warning temperature limit. Once the system has detected that the CPU's temperature exceeded the limit, warning beeps will sound.

CPU Temperature/System Temperature/PWM Temperature:

These items display the temperature of CPU, System, and Power Module.

↳ **Voltage Monitoring:**

Click <Enter> key to enter its submenu:

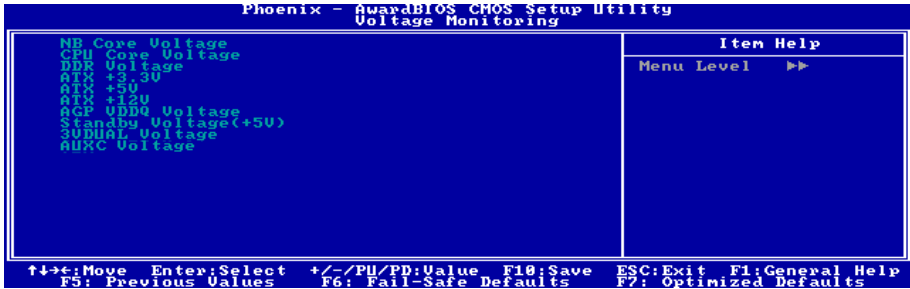

These items display the voltage of each element.

↳ **FAN Speed Monitoring:**

Click <Enter> key to enter its submenu:

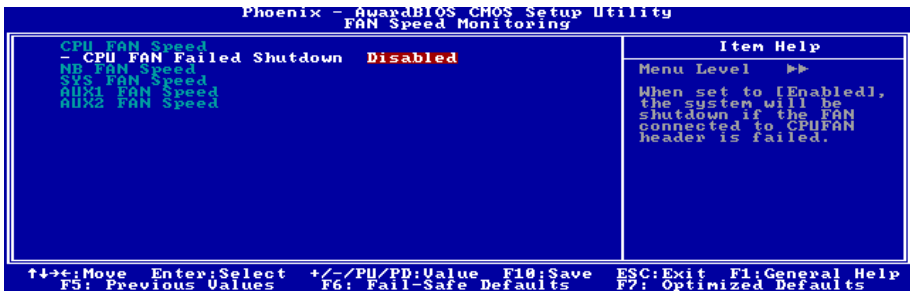

CPU/NB/SYS/AUX1/AUX2 FAN Speed:

These items display the speed of the fans connected to CPU, NB, SYS, AUX1 and AUX2 FAN headers.

※ **CPU FAN Failed Shutdown**

When set to [Enabled], the system will be shut down if the fan connected to CPUFAN header is failed.

NOTE: Only the fans with 3-pin plugs provide the speed monitoring function.

↳ FanEQ Control:

Click <Enter> key to enter its submenu:

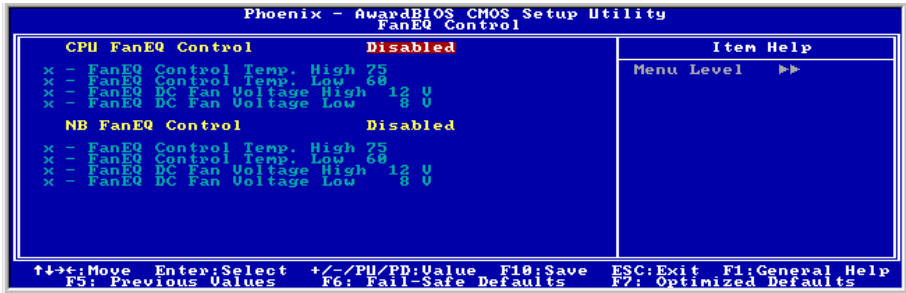

CPU FanEQ Control:

When set to [Enabled], this item allows you to control the CPU fan speed by its setting combination of temperature and voltage high/low limit.

* FanEQ Control Temp. High/Low

This item sets the high and low temperature limit that you want to do the fan speed control.

* FanEQ DC Fan Voltage High/Low

This item sets the high and low voltage limit that you want to provide the fan with.

NOTE: The value of high limit must be higher than the value of low limit.

NB FanEQ Control:

When set to [Enabled], this item allows you to control the NB fan speed by its setting combination of temperature and voltage high/low limit.

* FanEQ Control Temp. High/Low

This item sets the high and low temperature limit that you want to do the fan speed control.

* FanEQ DC Fan Voltage High/Low

This item sets the high and low voltage limit that you want to provide the fan with.

NOTE: The value of high limit must be higher than the value of low limit.

3-9. Load Fail-Safe Defaults

This option loads the BIOS default values for the most stable, minimal-performance system operations.

3-10. Load Optimized Defaults

This option loads the BIOS default values that are factory settings for optimal-performance system operations.

3-11. Set Password

This option protects the BIOS configuration or restricts access to the computer itself.

3-12. Save & Exit Setup

This option saves your selections and exits the BIOS setup menu.

3-13. Exit Without Saving

This option exits the BIOS setup menu without saving any change.







Appendix A. Install NVIDIA nForce Chipset Driver

NOTE: Please install this NVIDIA nForce Chipset driver first after having installed the Windows operating system.

The installation procedures and screen shots in this section are based on Windows XP operating system. For those of other OS, please follow its on-screen instruction.

Insert the Driver & Utility CD into CD-ROM drive, it should execute the installation program automatically. If not, double-click the execution file at the main directory of this CD to enter the installation menu.

After entering the installation menu, move your cursor to [Drivers] tab. Click [nVidia nForce Chipset Driver]. The following screen appears.

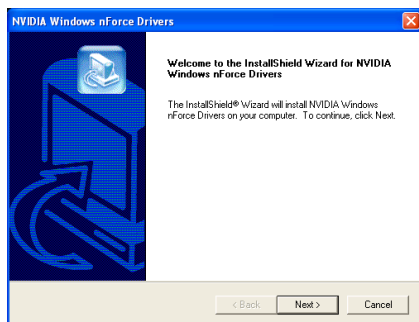

1. Click [Next].



2. Choose [Yes, I want to restart my computer now.], and click [Finish] to complete setup.



Appendix B. Install Serial ATA RAID Driver

The installation procedures and screen shots in this section are based on Windows XP operating system. For those of other OS, please follow its on-screen instruction.

Insert the Driver & Utility CD into CD-ROM drive, it should execute the installation program automatically. If not, double-click the execution file at the main directory of this CD to enter the installation menu.

After entering the installation menu, move your cursor to [Drivers] tab. Click [Serial ATA Driver]. The following screen appears.

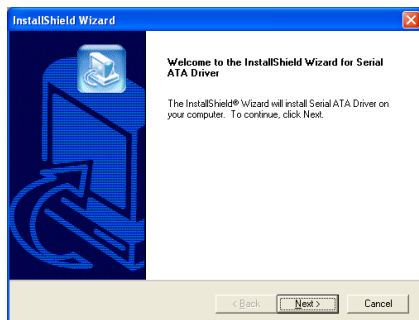

1. Click [Next].



2. Click [Continue Anyway].

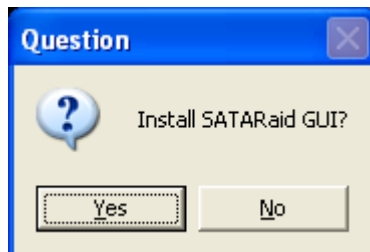

3. Click [Yes].

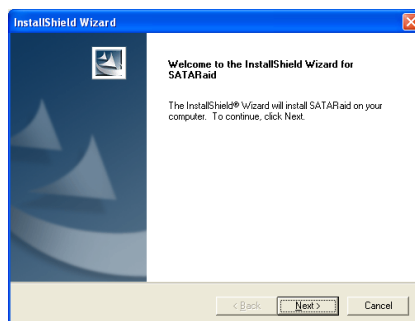

4. Click [Next].

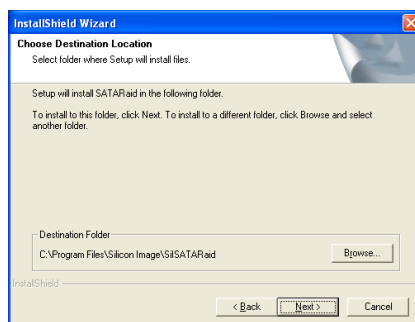

5. Click [Next].

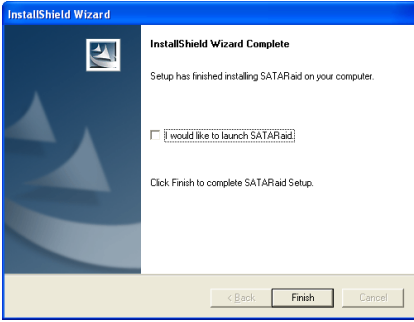

6. Click [Finish].

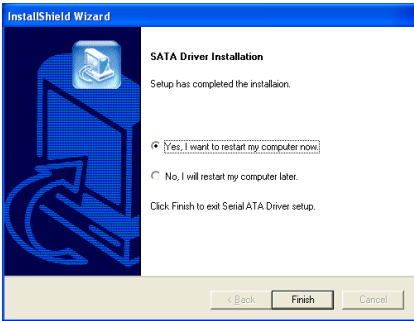

7. Choose [Yes, I want to restart my computer now.], and click [Finish] to complete setup.



8. Check [Device Manager]. [Silicon Image SiI 3112 SATARAid Controller] is successfully installed.

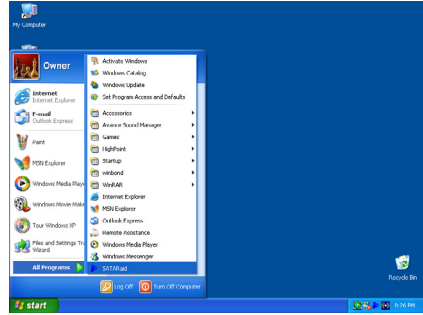

9. To run the [SATARAid] application, click [Start] → [All Programs] → [SATARAid].

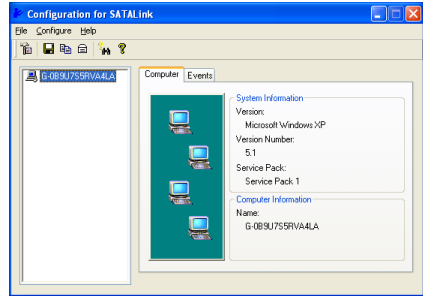

10. This is the SATALink configuration menu. For more information on how to operate, please refer to the “Help” menu.

BIOS Setup for Serial ATA RAID

This motherboard supports Striped (RAID 0) and Mirrored (RAID 1) RAID set. For the striped RAID set, the identical drives can read and write data in parallel to increase performance. The Mirrored RAID set creates a complete backup of your files. Striped and Mirrored RAID set requires 2 hard disks to do so.

RAID Configuration Utility Menu

Main Menu

Reboot your system. Press **<CTRL> + <S>** or **<F4>** key while booting up the system to enter the BIOS setting menu. The main menu of the BIOS Setting Utility appears as shown below:

RAID Configuration Utility - Silicon Image Inc. Copyright (C) 2002			
Create RAID set Delete RAID set Rebuild Mirrored set Resolve Conflicts		Striped Mirrored	
* 0	PM	Master 33073H3	29312MB
1	SM	Master 33073H3	29312MB
		F1 Select Menu ESC Previous Menu Enter Select Ctrl-E Exit * First HDD	

To select the option in this menu, you may:

- Press **<↑ ↓>** (up, down arrow) to choose the option you want to confirm or to modify.
- Press **<Enter>** to confirm the selection.
- Press **<Esc>** to return to previous menu.
- Press **<Ctrl-E>** to exit the RAID configuration utility.

NOTE: If you want to create a RAID 0 (striping) array, all the data stored in the hard disks will first be erased! Please backup the hard disk data before starting to create the RAID array.

If you want to create a RAID 1 (mirroring) array, please make sure which hard disk is the source disk and which one is the destination disk. If you make a mistake, you may copy the blank data to the source disk, which will result in both hard disks becoming blank!

Option 1 Create RAID set

This item allows you to create a RAID array.

After you had selected the function from the main menu, press the **<Enter>** key to enter the sub menu as shown below:

RAID Configuration Utility - Silicon Image Inc. Copyright (C) 2002			
Create RAID set Delete RAID set Rebuild Mirrored set Resolve Conflicts		Striped Mirrored	
* 0	PM	Master 33073H3	29312MB
1	SM	Master 33073H3	29312MB
		F1 Select Menu ESC Previous Menu Enter Select Ctrl-E Exit * First HDD	

- **Array Mode:**

This item allows you to select the appropriate RAID mode for the desired array. There are two modes to choose. When you choose a “Striped” or “Mirrored” RAID set, the utility will ask “Are You Sure?” before the Creating RAID process. Press **<Y>** to confirm.

NOTE: It is highly recommended to attach hard disks with the same model in reaching the RAID performance.

Striping (RAID 0): This item is recommended for **high performance** usage. Requires at least 2 disks.

Mirror (RAID 1): This item is recommended for **data security** usage. Requires at least 2 disks.

**Option 2
Delete RAID set**

This item allows you to remove a RAID Array on this onboard Serial ATA RAID controller.

NOTE: After you have made and confirmed this selection, all the data stored in the hard disk will be lost. (The entire partition configuration will be deleted too.)

**Option 3
Rebuild Mirrored set**

This item allows you to rebuild only “Mirrored” RAID set.

You need to check which hard disk is the source disk and which one is the destination disk when you decide to rebuild mirrored RAID set.

**Option 4
Resolve Conflicts**

When a RAID set is created, the metadata written to the disk includes drive connection information (Primary Channel, Secondary Channel).

If, after a disk failure, the replacement disk was previously part of a RAID set (or used in another system), it may have conflicting metadata, specifically in reference to the drive connection information. If so, this will prohibit the RAID set from being either created or rebuilt.

In order for the RAID set to function properly, this old metadata must be first overwritten with the new metadata. To resolve this, select “Resolve Conflict”. The correct metadata, including the correct drive connection information, will then be written to the replacement disk.

NOTE: For more information on RAID function, please refer to the RAID Management Software enclosed in the CD that came packed with this motherboard.

Appendix C. Install ABIT μ Guru Driver

ABIT μ Guru is a fresh Microprocessor developed by ABIT engineers used only on ABIT motherboards. This processor combines the current ABIT engineered features into a user-friendly Windows-based interface, providing users a perfect environment to maximize PC performance and stability.

ABIT μ Guru family currently includes six categories:

1. *ABIT EQ*
2. *ABIT FanEQ*
3. *ABIT OC Guru*
4. *ABIT FlashMenu*
5. *ABIT AudioEQ*
6. *ABIT BlackBox*

To install the ABIT μ Guru driver, please insert the Driver & Utility CD into CD-ROM drive. It should execute the installation program automatically. If not, double-click the execution file at the main directory of this CD to enter the installation menu. The following screen appears.



Move your mouse to “ABIT Utility” tab. Click [ABIT μ Guru]. Follow the on-screen instruction to complete the driver installation.



Appendix D. POST Code Definition

AWARD POST Code Definition:

Code	Description
CF	Test CMOS R/W functionality
C0	Early chipset initialization: -Disable shadow RAM -Disable L2 cache (socket 7 or below) -Program basic chipset registers
C1	Detect memory -Auto-detection of DRAM size, type and ECC -Auto-detection of L2 cache (socket 7 or below)
C3	Expand compressed BIOS code to DRAM
C5	Call chipset hook to copy BIOS back to E000 & F000 shadow RAM
01	Expand the Xgroup codes locating in physical address 1000:0
03	Initial Superio Early Init switch
05	1. Blank out screen 2. Clear CMOS error flag
07	1. Clear 8042 interface 2. Initialize 8042 self-test
08	1. Test special keyboard controller for Winbond 977 series Super I/O chips 2. Enable keyboard interface
0A	1. Disable PS/2 mouse interface (optional) 2. Auto detect ports for keyboard & mouse followed by a port & interface swap (optional) 3. Reset keyboard for Winbond 977 series Super I/O chips
0E	Test F000h segment shadow to see whether it is R/W-able or not. If test fails, keep beeping the speaker
10	Auto detect flash type to load appropriate flash R/W codes into the run time area in F000 for ESCD & DMI support
12	Use walking 1's algorithm to check out interface in CMOS circuitry. Also set real-time clock power status, and then check for override
14	Program chipset default values into chipset. Chipset default values are MODBINable by OEM customers
16	Initial onboard clock generator if Early_Init_Onboard_Generator is defined. See also POST 26.
18	Detect CPU information including brand, SMI type (Cyrix or Intel) and CPU level (586 or 686)
1B	Initial interrupts vector table. If no special specified, all H/W interrupts are directed to SPURIOUS_INT_HDLR & S/W interrupts to SPURIOUS_soft_HDLR.
1D	Initial EARLY_PM_INIT switch
1F	Load keyboard matrix (notebook platform)
21	HPM initialization (notebook platform)
23	1. Check validity of RTC value: e.g. a value of 5Ah is an invalid value for RTC minute. 2. Load CMOS settings into BIOS stack. If CMOS checksum fails, use default value instead.
24	Prepare BIOS resource map for PCI & PnP use. If ESCD is valid, take into consideration of the ESCD's legacy information.

25	Early PCI Initialization: -Enumerate PCI bus number. -Assign memory & I/O resource -Search for a valid VGA device & VGA BIOS, and put it into C000:0
26	1. If Early_Init_Onboard_Generator is not defined Onboard clock generator initialization. Disable respective clock resource to empty PCI & DIMM slots. 2. Init onboard PWM 3. Init onboard H/W monitor devices
27	Initialize INT 09 buffer
29	1. Program CPU internal MTRR (P6 & PII) for 0-640K memory address. 2. Initialize the APIC for Pentium class CPU. 3. Program early chipset according to CMOS setup. Example: onboard IDE controller. 4. Measure CPU speed.
2B	Invoke Video BIOS
2D	1. Initialize double-byte language font (Optional) 2. Put information on screen display, including Award title, CPU type, CPU speed, full screen logo.
33	Reset keyboard if Early_Reset_KB is defined e.g. Winbond 977 series Super I/O chips. See also POST 63.
35	Test DMA Channel 0
37	Test DMA Channel 1.
39	Test DMA page registers.
3C	Test 8254
3E	Test 8259 interrupt mask bits for channel 1
40	Test 8259 interrupt mask bits for channel 2
43	Test 8259 functionality
47	Initialize EISA slot
49	1. Calculate total memory by testing the last double word of each 64K page 2. Program writes allocation for AMD K5 CPU
4E	1. Program MTRR of M1 CPU 2. Initialize L2 cache for P6 class CPU & program CPU with proper cacheable range 3. Initialize the APIC for P6 class CPU 4. On MP platform, adjust the cacheable range to smaller one in case the cacheable ranges between each CPU are not identical
50	Initialize USB
52	Test all memory (clear all extended memory to 0)
53	Clear password according to H/W jumper (Optional)
55	Display number of processors (multi-processor platform)
57	Display PnP logo Early ISA PnP initialization -Assign CSN to every ISA PnP device
59	Initialize the combined Trend Anti-Virus code
5B	(Optional Feature) Show message for entering AWDFLASH.EXE from FDD (optional)
5D	1. Initialize Init_Onboard_Super_IO 2. Initialize Init_Onboard_AUDIO
60	Okay to enter Setup utility; i.e. not until this POST stage can users enter the CMOS setup utility
63	Reset keyboard if Early_Reset_KB is not defined
65	Initialize PS/2 Mouse
67	Prepare memory size information for function call: INT 15h ax=E820h
69	Turn on L2 cache

6B	Program chipset registers according to items described in Setup & Auto-configuration table
6D	1. Assign resources to all ISA PnP devices 2. Auto assign ports to onboard COM ports if the corresponding item in Setup is set to "AUTO"
6F	1. Initialize floppy controller 2. Set up floppy related fields in 40:hardware
75	Detect & install all IDE devices: HDD, LS120, ZIP, CDROM ...
76	(Optional Feature) Enter AWDFLASH.EXE if: -AWDFLASH is found in floppy drive -ALT+F2 is pressed
77	Detect serial ports & parallel ports.
7A	Detect & install co-processor
7C	Init HDD write protect
7F	Switch back to text mode if full screen logo is supported -If errors occur, report errors & wait for keys -If no errors occur or F1 key is pressed to continue: Clear EPA or customization logo
E8POST.ASM starts	
82	1. Call chipset power management hook 2. Recover the text font used by EPA logo (not for full screen logo) 3. If password is set, ask for password
83	Save all data in stack back to CMOS
84	Initialize ISA PnP boot devices
85	1. USB final Initialization 2. Switch screen back to text mode
87	NET PC: Build SYSID Structure
89	1. Assign IRQs to PCI devices 2. Set up ACPI table at top of the memory.
8B	1. Invoke all ISA adapter ROMs 2. Invoke all PCI ROMs (except VGA)
8D	1. Enable/Disable Parity Check according to CMOS setup 2. APM Initialization
8F	Clear noise of IRQs
93	Read HDD boot sector information for Trend Anti-Virus code
94	1. Enable L2 cache 2. Program Daylight Saving 3. Program boot up speed 4. Chipset final initialization. 5. Power management final initialization 6. Clear screen & display summary table 7. Program K6 write allocation 8. Program P6 class write combining
95	Update keyboard LED & typematic rate
96	1. Build MP table 2. Build & update ESCD 3. Set CMOS century to 20h or 19h 4. Load CMOS time into DOS timer tick 5. Build MSIRQ routing table
FF	Boot attempt (INT 19h)

AC2003 POST Code Definition:

POST (hex)	Description
Power On Sequence	
81	Start power on sequence
82	Enable ATX power supply
83	ATX power supply ready
84	DDR voltage ready
85	Setup PWM for CPU core voltage
86	Assert PWM for CPU core voltage
87	Check CPU core voltage
88	CPU core voltage ready
89	Initial clock generator IC
8A	North Bridge chipset voltage ready
8B	AGP voltage ready
8C	3VDUAL voltage ready
8D	VDDA 2.5V voltage ready
8D	GMCHVTT voltage ready
8E	Check CPU fan speed
8F	Assert all power ready
90	Complete uGuru initial process AWARD BIOS take over booting job
Power Off Sequence	
91	Start power off sequence
92	De-Assert all power
93	Se-Assert power on
94	De-Assert LDT Bus power
95	De-Assert PWM for CPU core voltage
96	De-Assert CPU core voltage
97	Check CPU core voltage
98	De-Assert ATX power supply
99	Complete power off sequence
Others	
F0	Button reset
F1	SoftMenu reset
F2	Power on sequence timeout
F3	Power off sequence timeout

Appendix E. Troubleshooting (Need Assistance?)

Q & A:

Q: Do I need to clear the CMOS before I use a new motherboard to assemble my new computer system?

A: Yes, we highly recommend that you clear the CMOS before installing a new motherboard. Please move the CMOS jumper from its default 1-2 position to 2-3 for a few seconds, and then back. When you boot up your system for the first time, follow the instructions in the user's manual to load the optimized defaults.

Q: If my systems hang when I update the BIOS or set the wrong CPU parameters, what should I do?

A: Whenever you update the BIOS or if the system hangs due to wrong CPU parameters setting, always clear CMOS jumper before booting up again.

Q: Why the system failed to boot up and nothing was displayed on the screen after I did some over-clocking or non-standard settings inside the BIOS? Is the motherboard dead? Do I need to return it to where I bought from or go through an RMA process?

A: It should not cause hardware or permanent damage to motherboard when BIOS settings were changed from default to over-clocking or non-standard status.

We suggest the following three troubleshooting methods to discharge CMOS data, recover the hardware default status, and then make the motherboard working again. No need to bother returning the motherboard to where you bought from or go through an RMA process.

Step 1. Switch off the power supply unit and then switch it on again after one minute. If there is no power switch on the power supply unit, disconnect its power cord for one minute and then connect it back.

Press and hold the <Insert> key on the keyboard, press the power-on button to boot up system. If it works, loose the <Insert> key and hit key to enter the BIOS setup page to do the correct settings.

If the situation remains the same, repeat the procedures in Step 1 for three times, or try Step 2.

Step 2. Switch off the power supply unit or disconnect the power cord. Open the chassis cover. Locate the CCMOS jumper near the button battery. Change the jumper position from default 1-2 to 2-3 for one minute to discharge the CMOS data, and then put it back to default 1-2 position.

Close the chassis and switch on the power supply unit or plug in the power cord. Press the power-on button to boot up system. If it works, hit key to enter the BIOS setup page to do the correct settings.

If the situation remains the same, try Step 3.

Step 3. The same procedure as Step 2, but in the meantime of discharging the CMOS data, pull out ATX power connectors from motherboard and remove the button battery during CMOS discharging.

Q: How can I get a quick response to my request for technical support?

A: Be sure to follow the guidelines as stated in the “Technical Support Form” section of this manual.

If you have a problem during operation, in order to help our technical support personnel quickly determine the problem with your motherboard and give you the answers you need, before filling in the technical support form, eliminate any peripheral that is not related to the problem, and indicate it on the form. Fax this form to your dealer or to the company where you bought the hardware in order to benefit from our technical support. (You can refer to the examples given below)

Example 1:

With a system including: motherboard (with CPU, DRAM, COAST...) HDD, CD-ROM, FDD, VGA CARD, MPEG CARD, SCSI CARD, SOUND CARD, etc. After the system is assembled, if you cannot boot up, check the key components of the system using the procedure described below. First remove all interface cards except the VGA card and try to reboot.

If you still cannot boot up: Try installing another brand/model VGA card and see if the system will start. If it still does not start, note the VGA card model, motherboard model, Bios identification number, CPU on the technical support form (refer to main instructions), and describe the problem in the problem description space provided.

If you can boot up: Insert the interface cards you have removed back into the system, one by one and try to start the system each time you insert a card, until the system will not start. Keep the VGA card and the interface card that caused the problem inserted on the motherboard, remove any other cards or peripheral, and start again. If you still cannot start, note the information related to both cards in the add-on Card space provided, and don't forget to indicate the motherboard model, version, BIOS identification number, CPU (refer to main instructions), and give a description of the problem.

Example 2:

With a system including the motherboard (with CPU, DRAM, COAST...) HDD, CD-ROM, FDD, VGA CARD, LAN CARD, MPEG CARD, SCSI CARD, SOUND CARD, after assembly and after having installed the Sound Card Driver, when you restart the system, when it runs the Sound Card Driver, it resets automatically. This problem may be due to the Sound Card Driver. During the Starting DOS... procedure, press SHIFT (BY-PASS) key, to skip CONFIG.SYS and AUTOEXEC.BAT; edit CONFIG.SYS with a text editor, and in function the line that loads the Sound Card Driver, add a remark REM, in order to disable the Sound Card Driver. See the example below.

```
CONFIG.SYS:
DEVICE=C:\DOS\HIMEM.SYS
DEVICE=C:\DOS\EMM386.EXE HIGHSCAN
DOS=HIGH, UMB
FILES=40
BUFFERS=36
REM DEVICEHIGH=C:\PLUGPLAY\DWCFMG.SYS
LASTDRIVE=Z
```

Restart the system. If the system starts and does not reset, you can be sure that the problem is due to the Sound Card Driver. Write down the Sound Card model, motherboard model, BIOS identification number on the technical support file (refer to main instructions), and describe the problem in the space provided.

We will show you how to fill the “**Technical Support Form**”.

Main instructions:

To fill in this “**Technical Support Form**”, refer to the step-by-step instructions given below:

- 1* **MODEL:** Note the model number given in your user’s manual.

Example: AN7

- 2* **Motherboard model number (REV):** Note the motherboard model number labeled on the motherboard as “REV:*.***”.

Example: REV: 1.01

- 3* **BIOS ID and Part Number:** See the on screen message.

- 4. **DRIVER REV:** Note the driver version number indicated on the DEVICE DRIVER disk (if any) as “Release *.*”. For example:

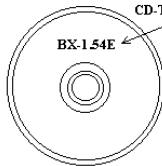

- 5* **OS/APPLICATION:** Indicate the operating system and applications you are running on the system.

Example: MS-DOS® 6.22, Windows® 98 SE, Windows® 2000, etc....

- 6* **CPU:** Indicate the brand and the speed (MHz) of your CPU.

Example:(A) In the “Brand” space, write “Intel”; in the “Specifications” space, write “Pentium® 4 1.9GHz”.

- 7. **HDD:** Indicate the brand and specifications of your HDD(s); specify if the HDD is using IDE1 or IDE2. If you know the disk capacity, indicate it and check (“✓”) “”; in case you give no indication, we will consider that your HDD is “IDE1” Master.

Example: In the “HDD” space, check the box; in the Brand space, write “Seagate”; in the Specifications space, write “ST31621A (1.6GB)”.

- 8. **CD-ROM Drive:** Indicate the brand and specifications of your CD-ROM drive. Specify if it uses IDE1 or IDE2 , and check (“✓”) “”; in case you give no indication, we will consider that your CD-ROM is “IDE2” Master.

Example: In the “CD-ROM drive” space, check the box, in the Brand space, write “Mitsumi”, in the Specifications space, write “FX-400D”.

- 9. **System Memory (DDR SDRAM):** Indicate the brand and specifications (DDR DIMM) of your system memory. Such as Density, Description, Module Components, Module Part Number, CAS Latency, and Speed (MHz).

For example: In the Brand space, write “**Micron**”; in the Specifications space, write: **Density:** 128MB, **Description:** SS 16 Megx72 2.5V ECC Gold, **Module Components:** (9) 16 Megx 8, **Module Part Number:** MT9VDDT1672AG, **CAS Latency:** 2, **Speed (MHz):** 200 MHz.

Please give us the detailed information of your DDR SDRAM module; it will help us to simulate the problems you met.

- 10. **ADD-ON CARD:** Indicate which add-on cards you are *absolutely sure* are related to the problem.

If you cannot identify the problem’s origin, indicate all the add-on cards inserted into your system.

NOTE: Items between the “*” are absolutely necessary.

 **Technical Support Form**

 **Company Name:**

 **Phone Number:**

 **Contact Person:**

 **Fax Number:**

 **E-mail Address:**

Model	*	BIOS ID #	*
Motherboard Model No.		DRIVER REV	
OS/Application	*		
Hardware Name	Brand	Specifications	
CPU	*		
HDD	<input type="checkbox"/> IDE1 <input type="checkbox"/> IDE2		
CD-ROM-Drive	<input type="checkbox"/> IDE1 <input type="checkbox"/> IDE2		
System Memory			
ADD-ON CARD			

Problem Description:



Appendix F. How to Get Technical Support

(From our website) <http://www.abit.com.tw>

(In North America) <http://www.abit-usa.com>

(In Europe) <http://www.abit.nl>

Thank you for choosing ABIT products. ABIT sells all our products through distributors, resellers and system integrators; we have no direct sales to end-users. Before sending email for tech support please check with your resellers or integrators if you need any services, they are the ones who sold you your system and they should know best as to what can be done, how they serve you is a good reference for future purchases.

We appreciate every customer and would like to provide the best service to you. Providing fast service to our customers is our top priority. However we receive many phone calls and a huge amount of email from all over the world. At the present time it is impossible for us to respond to every single inquiry. Therefore it is quite possible that if you send an email to us that you may not receive a response.

We have done many compatibility tests and reliability tests to make sure our products have the best quality and compatibility. In case you need service or technical support, please understand the constraint we have and **always check with the reseller who sold the product to you first.**

To expedite service, we recommend that you follow the procedures outlined below before contacting us. With your help, we can meet our commitment to provide the best service to the **greatest number of ABIT customers:**

- 1. Check the Manual.** It sounds simple but we have taken a lot of care in making a well-written and thorough manual. It is full of information that doesn't only pertain to motherboards. The CD-ROM included with your board will have the manual as well as drivers. If you don't have either one, go to our Program Download Area of the Website or FTP server.
- 2. Download latest BIOS, software or drivers.** Please go to our Program Download area on our Website to check to see if you have the latest BIOS. They are developed over periods of time to fix bugs or incompatibilities. **Also please make sure you have the latest drivers from your peripheral cards makers!**
- 3. Check the ABIT Technical Terms Guide and FAQ on our Website.** We are trying to expand and make the FAQs more helpful and information rich. Let us know if you have any suggestions. For hot topics check out our HOT FAQ!

4. **Internet Newsgroups.** They are a great source of information and many people there can offer help. ABIT's Internet News group, alt.comp.periphs.mainboard.abit, is an ideal forum for the public to exchange information and discuss experiences they have had with ABIT products. Many times you will see that your question has already been asked before. This is a public Internet news group and it is reserved for free discussions. Here is a list of some of the more popular ones:

alt.comp.periphs.mainboard.abit

comp.sys.ibm.pc.hardware.chips

alt.comp.hardware.overclocking

alt.comp.hardware.homebuilt

alt.comp.hardware.pc-homebuilt

5. **Ask your reseller.** Your ABIT authorized distributor should be able to provide the fastest solution to your technical problem. We sell our products through distributors who sell to resellers and stores. Your reseller should be very familiar with your system configuration and should be able to solve your problem much more efficiently than we could. After all, your reseller regards you as an important customer who may purchase more products and who can urge your friends to buy from him or her as well. They integrated and sold the system to you. They should know best what your system configuration is and your problem. They should have reasonable return or refund policies. How they serve you is also a good reference for your next purchase.
6. **Contacting ABIT.** If you feel that you need to contact ABIT directly you can send email to the ABIT technical support department. First, please contact the support team for the branch office closest to you. They will be more familiar with local conditions and problems and will have better insight as to which resellers offer what products and services. Due to the huge number of emails coming in every day and other reasons, such as the time required for problem reproduction, we will not be able to reply to every email. Please understand that we are selling through distribution channels and don't have the resources to serve every end-user. However, we will try to do our best to help every customer. Please also remember that for many of our technical support team English is a second language, you will have a better chance of getting a helpful answer if your question can be understood in the first place. Be sure to use very, simple, concise language that clearly states the problem, avoid rambling or flowery language and always list your system components. Here is the contact information for our branch offices:

North America and South America:

ABIT Computer (U.S.A.) Corporation
45531 Northport Loop West,
Fremont, California 94538, U.S.A.
Tel: 1-510-623-0500
Fax: 1-510-623-1092
sales@abit-usa.com
technical@abit-usa.com
<http://www.abit-usa.com>

U.K. and Ireland:

ABIT Computer (U.K.) Corporation Ltd.
Unit 3, 24-26 Boulton Road,
Stevenage, Herts SG1 4QX, U.K.
Tel: 44-1438-228888
Fax: 44-1438-226333
sales@abitcomputer.co.uk
technical@abitcomputer.co.uk

Germany, Benelux (Belgium, Netherlands, Luxembourg), Denmark, Norway, Sweden, Finland, and Switzerland:

AMOR Computer B.V. (ABIT's European Office)
Van Coehoornstraat 7,
5916 PH Venlo, The Netherlands
Tel: 31-77-3204428
Fax: 31-77-3204420
sales@abit.nl
technical@abit.nl
<http://www.abit.nl>

Austria, Czech, Romania, Bulgaria, Yugoslavia, Slovakia, Slovenia, Croatia, Bosnia, Serbia, and Macedonia:

Asguard Computer Ges.m.b.H
Schmalbachstrasse 5,
A-2201 Gerasdorf/Wien, Austria
Tel: 43-1-7346709
Fax: 43-1-7346713
asguard@asguard.at

Japan:

ABIT Computer (Japan) Co. Ltd.
Fax: 81-3-5396-5110
<http://www.abit4u.jp>

Shanghai:

ABIT Computer (Shanghai) Co. Ltd.
Tel: 86-21-6235-1829
Fax: 86-21-6235-1832
<http://www.abit.com.cn>

Russia:

ABIT Computer (Russia) Co. Ltd.
Fax: 7-095-937-2837
techrussia@abit.com.tw
<http://www.abit.ru>

France, Italy, Spain, Portugal, and Greece:

ABIT Computer France SARL
Tel: 33-1-5858-0043
Fax: 33-1-5858-0047
<http://www.abit.fr>

All other territories not covered above please contact Taiwan Head Office:

When contacting our headquarters please Note we are located in Taiwan and we are 8+ GMT time. In addition, we have holidays that may be different from those in your country.

ABIT Computer Corporation
No.323, Yang Guang St., Neihu, Taipei, 114, Taiwan
Tel: 886-2-8751-8888
Fax: 886-2-8751-3382
sales@abit.com.tw
market@abit.com.tw
technical@abit.com.tw
<http://www.abit.com.tw>

7. **RMA Service.** If your system has been working but it just stopped, but you have not installed any new software or hardware recently, it is likely that you have a defective component. Please contact the reseller from whom you bought the product. You should be able to get RMA service there.
8. **Reporting Compatibility Problems to ABIT.** Because of tremendous number of email messages we receive every day, we are forced to give greater weight to certain types of messages than to others. For this reason, any compatibility problem that is reported to us, giving detailed system configuration information and error symptoms will receive the highest priority. For the other questions, we regret that we may not be able to reply directly. But your questions may be posted to the Internet news group in order that a larger number of users can have the benefit of the information. Please check the news group from time to time.
9. The information listed below are some **chipset vendors' WEB site addresses** for your reference:

HighPoint Technology Inc.'s WEB site: <http://www.highpoint-tech.com/>

Intel's WEB site: <http://www.intel.com/>

Silicon Image's WEB site: <http://www.siimage.com/>

SiS' WEB site: <http://www.sis.com.tw/>

VIA's WEB site: <http://www.via.com.tw/>

Thank You

ABIT Computer Corporation

<http://www.abit.com.tw>