

TOSHIBA TE2300

User's Manual

TE 2300

TE2300 TOSHIBA TE2300 TOSHIBA TE2300

Choose freedom.
computers.toshiba-europe.com

TOSHIBA

Copyright

© 2003 by TOSHIBA Corporation. All rights reserved. Under the copyright laws, this manual cannot be reproduced in any form without the prior written permission of TOSHIBA. No patent liability is assumed, with respect to the use of the information contained herein.

TOSHIBA TE2300 Portable Personal Computer User's Manual

First edition May 2003

Copyright authority for music, movies, computer programs, data bases and other intellectual property covered by copyright laws belongs to the author or to the copyright owner. Copyrighted material can be reproduced only for personal use or use within the home. Any other use beyond that stipulated above (including conversion to digital format, alteration, transfer of copied material and distribution on a network) without the permission of the copyright owner is a violation of copyright or author's rights and is subject to civil damages or criminal action. Please comply with copyright laws in making any reproduction from this manual.

Disclaimer

This manual has been validated and reviewed for accuracy. The instructions and descriptions it contains are accurate for the TOSHIBA TE2300 Portable Personal Computer at the time of this manual's production. However, succeeding computers and manuals are subject to change without notice. TOSHIBA assumes no liability for damages incurred directly or indirectly from errors, omissions or discrepancies between the computer and the manual.

Trademarks

IBM is a registered trademark, and IBM PC and PS/2 are trademarks of International Business Machines Corporation.

Intel, Intel SpeedStep and Pentium are trademarks or registered trademarks of Intel Corporation.

Windows and Microsoft are registered trademarks of Microsoft Corporation.

Photo CD is a trademark of Eastman Kodak.

CompactFlash is a trademark of SunDisk Corporation.

Other trademarks and registered trademarks not listed above may be used in this manual.

EU Declaration of Conformity



This product is carrying the CE-Mark in accordance with the related European Directives. Responsible for CE-Marking is TOSHIBA Europe GmbH, Hammfelddamm 8, 41460 Neuss, Germany.

Modem warning notice

Conformity Statement

The equipment has been approved to [Commission Decision “CTR21”] for pan-European single terminal connection to the Public Switched Telephone Network (PSTN).

However, due to differences between the individual PSTNs provided in different countries/regions the approval does not, of itself, give an unconditional assurance of successful operation on every PSTN network termination point.

In the event of problems, you should contact your equipment supplier in the first instance.

Network Compatibility Statement

This product is designed to work with, and is compatible with the following networks. It has been tested to and found to conform with the additional requirements conditional in EG 201 121.

Germany	ATAAB AN005,AN006,AN007,AN009,AN010 and DE03,04,05,08,09,12,14,17
Greece	ATAAB AN005,AN006 and GR01,02,03,04
Portugal	ATAAB AN001,005,006,007,011 and P03,04,08,10
Spain	ATAAB AN005,007,012, and ES01
Switzerland	ATAAB AN002
All other countries/regions	ATAAB AN003,004

Specific switch settings or software setup are required for each network, please refer to the relevant sections of the user guide for more details.

The hookflash (timed break register recall) function is subject to separate national type approvals. It has not been tested for conformity to national type regulations, and no guarantee of successful operation of that specific function on specific national networks can be given.

General Precautions

TOSHIBA computers are designed to optimize safety, minimize strain and withstand the rigors of portability. However, certain precautions should be observed to further reduce the risk of personal injury, damage to the computer or impaired performance.

Be certain to read the general precautions below and to note the cautions included in the text of the manual. Please also refer to the *Safety Instruction Manual*.

Stress injury

Carefully read the *Safety Instruction Manual*. It contains information on prevention of stress injuries to your hands and wrists that can be caused by extensive keyboard use. Chapter 3, *Getting Started*, also includes information on work space design, posture and lighting that can help reduce physical stress.

Heat Warning

- Avoid prolonged physical contact with the computer. If the computer is used for long periods, its surface can become very warm. While the temperature will not feel hot to the touch, if you maintain physical contact with the computer for a long time (if you rest the computer on your lap, or if you keep your hands on the palm rest, for example) your skin might suffer low-heat injury.
- If the computer has been used for a long time, avoid direct contact with the metal plate supporting the I/O ports. It can become hot.
- The surface of the AC adaptor can become hot when in use. This condition does not indicate a malfunction. If you need to transport the AC adaptor, disconnect it and let it cool before moving it.
- Do not lay the AC adaptor on a material that is sensitive to heat. The material could be damaged.

Pressure or impact damage

Do not apply heavy pressure to the computer or subject it to strong impact. Excessive pressure or impact can cause damage to computer components or otherwise cause malfunctions.

PC card overheating

Some PC cards can become hot with prolonged use. Overheating of a PC card can result in errors or instability in the PC card operation. Also be careful when you remove a PC card that has been used for a long time.

Mobile phone

Use of mobile phones can interfere with the audio system. Computer operation is not impaired but it is recommended that a distance of 30 cm be maintained between the computer and a mobile phone in use.

Central Processing Unit (CPU) Performance Disclaimer

CPU performance in your computer product may vary from specifications under the following conditions:

- Use of certain peripheral products
- Use of battery power instead of AC power
- Use of certain multimedia games or videos with special effects
- Use of standard telephone lines or low speed network connections
- Use of complex modelling software, such as high end computer aided design applications
- Use of the computer in areas with low air pressure (high altitude > 1,000 meters or > 3,280 feet above sea level)
- Use of the computer at temperatures outside the range of 5°C to 35°C (41°F to 95°F) or > 25°C (77°F) at high altitude (all temperature references are approximate).

CPU performance may also vary from specifications due to design configuration.

Under some conditions, your computer product may automatically shut down. This is a normal protective feature designed to reduce the risk of lost data or damage to the product when used outside recommended conditions. To avoid risk of lost data, always make back-up copies of data by periodically storing it on an external storage medium. For optimum performance, use your computer product only under recommended conditions. Read additional restrictions under *Environmental requirements* in Appendix A, *Specifications*. Contact TOSHIBA Technical Service and Support for more information.

CE compliance

This product and the original options are designed to observe the related EMC (Electromagnetic compatibility) and safety standards. However, TOSHIBA should not guarantee that this product still observes these EMC standards if options or cables not produced by TOSHIBA are connected or implemented. In this case the persons who have connected / implemented those options / cables have to assure that the system (PC plus options / cables) still fulfils the required standards. To avoid in general EMC problems following advice should be observed:

- Only CE marked options should be connected / implemented
- Only best shielded cables should be connected

Working environment

This product was designed to fulfil the EMC (electromagnetic compatibility) requirements to be observed for so-called "Residential, commercial and light industry environments".

TOSHIBA do not approve the use of this product in working environments other than the above mentioned "Residential, commercial and light industry environments".

For example, the following environments are not approved:

- Industrial Environments (environments with a mains voltage >230V~)
- Medical Environments
- Automotive Environments
- Aircraft Environments



If this product is supplied with a network port, please refer to the paragraph "Network connection".

Any consequences resulting from the use of this product in working environments that are not approved are not the responsibility of TOSHIBA Europe GmbH.

The consequences of the use of this product in non-approved working environments may be:

- Interference with other devices or machines in the near surrounding area
- Malfunction of, or data loss from, this product caused by disturbances generated by other devices or machines in the near surrounding area

Therefore TOSHIBA strongly recommend that the electromagnetic compatibility of this product should be suitably tested in all non-approved working environments before use. In the case of automobiles or aircraft, the manufacturer or airline respectively should be asked for permission before use of this product.

Furthermore, for general safety reasons, the use of this product in environments with explosive atmospheres is not permitted.

Network connection (class A warning)

If this product has networking capabilities and will be connected to a network, Class A radiation limits will be observed (in accordance with technical conventions). This means that if the product will be used in a domestic environment, other devices in the near surrounding may suffer interference. Consequently, please do not use this product in such environments (for example a living room), otherwise you could be held responsible for any ensuing interference.

Information on the secure use of the CD-RW

Please adhere to the following information on the use of the CD-RW to minimise the risk of unsuccessful storing process. As the storing may be unsuccessful despite your adhering to these information, for example because of a defective storing medium, you should even if the software indicates a successful storage, always check if the data has been stored successfully.

Optical disc drive standards

TOSHIBA TE2300 series computer is shipped with one of the following drives preinstalled : DVD-ROM, CD-RW/DVD-ROM, or DVD Multi drive.

The drive has one of the following labels :

CLASS 1 LASER PRODUCT

LASER KLASSE 1

LUOKAN 1 LASERLAITE

APPAREIL A LASER DE CLASSE1

KLASS 1 LASER APPARAT

Before it is shipped, the Class 1 Laser is certified to meet the United States Chapter 21 Standards of the Department of Health and Human Services (DHHS 21 CFR).

For any other country, the drive is certified to meet the Class 1 Laser standards of IEC82

Table of Contents

General Precautions

Preface

Manual contents	xii
Conventions	xiii

Chapter 1: Introduction

Equipment checklist.....	1-1
Features	1-2
Special features	1-7
Utilities	1-9
Options	1-10

Chapter 2: The Grand Tour

Front with the display closed	2-1
Left side	2-2
Right side	2-3
Back side	2-3
Underside.....	2-5
Front with the display open.....	2-7
System Indicators	2-9
USB diskette drive	2-11
Slim Select Bay modules	2-11
AC adaptor.....	2-17

Chapter 3: Getting Started

Setting up your work space	3-1
Connecting the AC adaptor	3-4
Opening the display	3-6
Turning on the power	3-6
Starting up for the first time	3-7
Turning off the power	3-7
Restarting the computer	3-10
Restoring the preinstalled software from the Product Recovery CD-ROM	3-10

Chapter 4: Operating Basics

Using AccuPoint II.....	4-1
Using the USB diskette drive	4-2
Changing Slim Select Bay modules.....	4-3
Using optical media drives.....	4-5
Writing CDs on CD-RW/DVD-ROM drive.....	4-10
Writing CD/DVDs on DVD Multi drive.....	4-12
Media care	4-17
Modem.....	4-18
Wireless communications	4-20
LAN.....	4-22
Cleaning the computer.....	4-24
Moving the computer	4-24
Heat dispersal.....	4-24

Chapter 5: The Keyboard

Typewriter keys	5-1
F1 ... F12 function keys	5-1
Soft keys: Fn key combinations	5-2
Windows special keys.....	5-6
Keypad overlay	5-6
Generating ASCII characters	5-8

Chapter 6: Power and Power-Up Modes

Power conditions	6-1
Power indicators	6-3
Battery types.....	6-4
Care and use of the battery pack.....	6-6
Replacing the battery pack	6-12
Starting the computer by password.....	6-13

Chapter 7: HW Setup and Passwords

HW Setup.....	7-1
---------------	-----

Chapter 8: Optional Devices

PC cards	8-2
Memory expansion	8-3
Additional battery pack (Black)	8-6
Slim Select Bay 2nd battery pack	8-6
Additional AC adaptor.....	8-6
Slim Select Bay HDD adaptor (Black)	8-6
USB FDD Kit	8-8
Advanced Port Replicator II	8-8
Parallel printer	8-9
External monitor.....	8-10
Television	8-11
PS/2 mouse	8-11
PS/2 keyboard	8-12
Security lock	8-12

Chapter 9: Troubleshooting

Problem solving process.....	9-1
Hardware and system checklist.....	9-3
TOSHIBA support	9-18

Appendix A: Specifications**Appendix B: AC Power Cord and Connectors****Appendix C: The Toshiba International Warranty****Appendix D: Keyboard Layouts****Appendix E: Display Controller and Modes****Appendix F: If your computer is stolen****Appendix G: Internal Modem Guide****Appendix H: ASCII Character Codes****Appendix I: Wireless LAN****Glossary****Index**

Preface

Congratulations on your purchase of the TOSHIBA TE2300 series computer. This powerful, lightweight notebook computer is designed to provide years of reliable, high-performance computing.

This manual tells how to set up and begin using your TE2300 computer. It also provides detailed information on configuring your computer, basic operations and care, using optional devices and troubleshooting.

If you are a new user of computers or if you're new to portable computing, first read over the *Introduction* and *The Grand Tour* chapters to familiarize yourself with the computer's features, components and accessory devices. Then read *Getting Started* for step-by-step instructions on setting up your computer.

If you are an experienced computer user, please continue reading the preface to learn how this manual is organized, then become acquainted with this manual by browsing through its pages. Be sure to look over the *Special features* section of the *Introduction*, to learn about features that are uncommon or unique to the computers and carefully read *HW Setup and Passwords*. If you are going to install PC cards or connect external devices such as a printer, be sure to read Chapter 8, *Optional Devices*.

Manual contents

This manual is composed of nine chapters, nine appendixes, a glossary, and an index.

Chapter 1, *Introduction*, is an overview of the computer's features, capabilities, and options.

Chapter 2, *The Grand Tour*, identifies the components of the computer and briefly explains how they function.

Chapter 3, *Getting Started*, provides a quick overview of how to begin operating your computer and gives tips on safety and designing your work area.

Chapter 4, *Operating Basics*, includes tips on care of the computer and on using the AccuPoint II, Slim Select Bay modules, optical media drive, external diskette drive, Wireless LAN, LAN and internal modem.

Chapter 5, *The Keyboard*, describes special keyboard functions including the keypad overlay and hotkeys.

Chapter 6, *Power and Power-Up Modes*, gives details on the computer's power resources and battery save modes.

Chapter 7, *HW Setup and Passwords*, explains how to configure the computer using the HW Setup program. It also tells how to set a password.

Chapter 8, *Optional Devices*, describes the optional hardware available.

Chapter 9, *Troubleshooting*, suggests courses of action if the computer doesn't seem to be working properly.

The Appendixes provide technical information about your computer.

The Glossary defines general computer terminology and includes a list of acronyms used in the text.

The Index quickly directs you to the information contained in this manual.

Conventions

This manual uses the following formats to describe, identify, and highlight terms and operating procedures.

Abbreviations

On first appearance, and whenever necessary for clarity, abbreviations are enclosed in parentheses following their definition. For example: Read Only Memory (ROM). Acronyms are also defined in the Glossary.

Icons

Icons identify ports, dials, and other parts of your computer. The indicator panel also uses icons to identify the components it is providing information on.

Keys

The keyboard keys are used in the text to describe many computer operations. A distinctive typeface identifies the key top symbols as they appear on the keyboard. For example, **Enter** identifies the Enter key.

Key operation

Some operations require you to simultaneously use two or more keys. We identify such operations by the key top symbols separated by a plus sign (+). For example, **Ctrl + C** means you must hold down **Ctrl** and at the same time press **C**. If three keys are used, hold down the first two and at the same time press the third.

ABC When procedures require an action such as clicking an icon or entering text, the icon's name or the text you are to type in is represented in the type face you see to the left.

Display

ABC Names of Windows or icons or text generated by the computer that appears on its display screen is presented in the type face you see to the left.

Messages

Messages are used in this manual to bring important information to your attention. Each type of message is identified as shown below.



Pay attention! A caution informs you that improper use of equipment or failure to follow instructions may cause data loss or damage your equipment.



Please read. A note is a hint or advice that helps you make best use of your equipment.

Chapter 1

Introduction

This chapter provides an equipment checklist, and it identifies the computer's features, options and accessories.



Some of the features described in this manual may not function properly if you use an operating system that was not preinstalled by TOSHIBA.

Equipment checklist

Carefully unpack your computer. Save the box and packing materials for future use.

Hardware

Check to make sure you have all the following items:

- TE2300 Portable Personal Computer
- Universal AC adaptor and power cord
- USB diskette drive (Provided with some models)
- Modular cable

Software

Windows XP Professional Service Pack 1

- The following software is preinstalled:
 - Microsoft® Windows XP Professional
 - Microsoft Internet Explorer
 - Modem driver
 - Display Driver
 - TOSHIBA Utilities
 - Wireless LAN driver
 - Sound Driver

- DVD Video Player
- LAN Driver
- Infrared Device Driver
- TOSHIBA Power Saver
- TOSHIBA Console
- Online manual
- Documentation:
 - *TOSHIBA TE2300 Portable Personal Computer User's Manual*
 - *TOSHIBA TE2300 QuickStart*
 - Microsoft® Windows XP Professional manual
 - *Safety Instruction Manual*
 - Warranty information
- Product Recovery CD-ROM or DVD-ROM
- Tools & Utilities CD-ROM

Features

The computer uses TOSHIBA's advanced Large Scale Integration (LSI), Complementary Metal-Oxide Semiconductor (CMOS) technology extensively to provide compact size, minimum weight, low power usage, and high reliability. This computer incorporates the following features and benefits:

Processor

Built-in	The computer is equipped with an Intel® processor, on-die 32KB instruction L1 cache and 1MB L2 cache memory.
1.3 GHz	Mobile Intel® Pentium® M Processor 1.3 GHz Support Enhanced Intel® SpeedStep™ technology
1.4 GHz	Mobile Intel® Pentium® M Processor 1.4 GHz Support Enhanced Intel® SpeedStep™ technology
1.5 GHz	Mobile Intel® Pentium® M Processor 1.5 GHz Support Enhanced Intel® SpeedStep™ technology
1.6 GHz	Mobile Intel® Pentium® M Processor 1.6 GHz Support Enhanced Intel® SpeedStep™ technology

Some models carry Intel® Centrino™ technology, which is based on three separate technologies of Intel® Pentium® M, Intel® PRO/Wireless Network Connection, and Intel® 855 Chipset Family.

Memory

Slots	PC2100 256 or 512 or 1024MB memory modules can be installed in the two memory slots for a maximum of 2GB system memory.
Level 2 cache	A 1MB level 2 cache is provided to maximize performance.
Video RAM	Allocated a part of System Memory dynamically (Limit of graphics memory is 32MB at 128MB of System Memory, Limit of Graphics memory is 64MB at more than 256MB of System Memory).

Drives

Hard disk drive	<p>The computer has an integrated, 2 1/2" hard disk drive (HDD) for nonvolatile storage of data and software. It comes in the following sizes.</p> <ul style="list-style-type: none"> ■ 30.0GB(27.94 billion bytes) ■ 40.0GB(37.26 billion bytes) ■ 60.0GB(55.89 billion bytes) ■ 80.0GB(74.51 billion bytes)
Diskette drive	Your computer may come with a 3 1/2" 1.44-megabyte or 720-kilobyte connects to the USB port. (Windows® XP does not support 720-kilobyte diskettes.)
DVD-ROM drive	<p>Some models are equipped with a full-size, DVD-ROM drive module that lets you run either digital versatile or compact disks without using an adaptor. It runs DVD-ROMs at maximum 8 speed and CD-ROMs at maximum 24 speed. This drive supports following formats:</p> <ul style="list-style-type: none"> • Photo CD™ • CD-ROM • CD-DA • CD-ROM x A Mode 2 (Form1, Form2) • Enhanced CD (CD-EXTRA) • DVD-ROM • CD-R (read only) • CD-Rewritable (read only) • CD-Text • DVD-Video

CD-RW/DVD-ROM drive Some models are equipped with a full-size, CD-RW/DVD-ROM drive module that lets you run CD/DVDs without using an adaptor. It reads DVD-ROMs at maximum 8 speed and CD-ROMs at maximum 24 speed. It writes CD-R at up to 24 speed and CD-RW at up to 10 speed. See Chapter 4, *Operating Basics*, for details. For reading, this drive supports the same formats as the DVD-ROM drive.

DVD Multi drive Some models are equipped with a full-size DVD Multi drive that lets you read/write DVD-R, DVD-RW, DVD-RAM, CD-R and CD-RW discs. DVD Multi media can be read, written and erased with random access like a diskette. Data can be rewritten hundreds of thousands of times over the life of a disc. For reading, this drive supports the same formats as the DVD-ROM drive. Refer to chapter 2, *The Grand Tour*, for details.



Display

The computer's LCD panel supports high-resolution video graphics. The screen can be set at a wide range of viewing angles for maximum comfort and readability.

Built-in Thin-film transistor color LCD is available in three sizes: 14.1" XGA-TFT, 1024 horizontal x 768 vertical pixels

Graphics controller Graphics controller maximizes display performance. Refer to Appendix E for more information.

Keyboard

Built-in 85 keys or 86 keys, compatible with IBM enhanced keyboard, embedded numeric overlay, dedicated cursor control,  and  keys. See Chapter 5. *The Keyboard*, for details.

AccuPoint II

Built-in A pointing device, the AccuPoint II, in the center of the keyboard and control buttons at the base of the keyboard enable control of the on-screen pointer and scrolling of windows.

Power

Battery pack	The computer is powered by one rechargeable lithium-ion battery pack.
RTC battery	The internal RTC battery backs up the Real Time Clock (RTC) and calendar.
AC adaptor	The universal AC adaptor provides power to the system and recharges the batteries when they are low. It comes with a detachable power cord. Because it is universal, it can receive a range of AC voltage between 100 and 240 volts.

Ports

Headphone	Enables connection of a stereo headphone
Parallel	Parallel printer or other parallel device (ECP ompatible).
Serial	RS-232C compatible port (16550 UART compatible)
Infrared	This infrared port is compatible with Infrared Data Association (IrDA 1.1) Fast InfraRed (FIR) standards. It enables cableless 4 Mbps data transfer with IrDA 1.1 compatible external devices.
External monitor	A 15-pin, analog VGA port supports VESA DDC2B compatible functions.
PS/2 keyboard/ mouse	Connects an external PS/2 keyboard or PS/2 mouse.
Docking	Special port for connecting an optional Advanced Port Replicator II.
Universal Serial Bus	Two Universal Serial Bus (USB) ports enable chain connection of a number of USB-equipped devices to one port on your computer. The ports comply with USB2.0 standards.

Slots

PC card	A PC card slot accommodates: Two 5 mm Type II One 10.5 mm Type III Refer to Chapter 8, <i>Optional Devices</i> , for details.
----------------	--

Multimedia

Sound System	Windows Sound System compatible sound system provides internal speaker as well as jacks for an external microphone and headphone. It also has a volume control dial.
Video-out jack	This RCA jack lets you transfer NTSC-J, NTSC-M or PAL-B data to external devices.

Communications

Modem	An internal modem provides capability for data and fax communication. It supports V.92 (US/Canda) and V.90 (other countries/regions). The speed of data transfer and fax depends on analog telephone line conditions. It has a modem jack for connecting to a telephone line.
LAN	The computer is equipped with a LAN card that supports Ethernet LAN (10 Mbit/s, 10BASE-T) and Fast Ethernet LAN (100 Mbit/s, 100BASE-Tx).
Wireless LAN	Some computers in this series are equipped with a wireless LAN mini-PCI card that is compatible with other LAN systems based on Direct Sequence Spread Spectrum radio technology that complies with the IEEE 802.11 Standard (Revision A or B). Revision-A supports data transfer up to 54 Mbit/s. Revision-B supports data transfer up to 11 Mbit/s. Turbo Mode (USA,Canada only) supports data transfer up to 108 Mbit/s. It has Frequency Channel Selection (5 GHz or 2.4 GHz) and allows roming overmultiple channels.

Slim Select Bay

Modules	Slim Select Bay is a single-drive bay that accommodates a DVD-ROM drive, CD-RW/DVD-ROM drive, DVD Multi drive, optional Slim Select Bay HDD adaptor, optional Slim Select Bay 2nd battery pack. The TOSHIBA Mobile Extension enables hot insertion of modules when you are using a plug and play operating system.
----------------	--

Security

Security lock slot	Connects an optional security lock to anchor the computer to a desk or other large object
---------------------------	---

Software

Operating System	Windows® XP Professional is available. Refer to the preinstalled software section at the front of this chapter.
TOSHIBA Utilities	A number of utilities and drivers are preinstalled to make your computer more convenient to use. Refer to the Utilities section in this chapter.
Plug and Play	When you connect an external device to the computer or when you install a component, Plug and Play capability enables the system to recognize the connection and make the necessary configurations automatically.

Special features

The following features are either unique to TOSHIBA computers or are advanced features, which make the computer more convenient to use.

Hotkeys	Key combinations let you quickly modify the system configuration directly from the keyboard without running a system configuration program.
Keypad overlay	Keys with gray lettering make up the keypad overlay, which lets you use the keyboard for ten-key operations or cursor control.
Display automatic power off	This feature automatically cuts off power to the internal display when there is no keyboard input for a time specified. Power is restored when any key is pressed. You can specify the time in the Turn off monitor item of the Power Save Mode window in Power Saver.
HDD automatic power off	This feature automatically cuts off power to the hard disk drive when it is not accessed for a time specified. Power is restored when the hard disk is accessed. You can specify the time in the Turn off hard disks item of the Power Save Mode window in Power Saver.
System automatic power off	This feature automatically turns off power to the system when there is no input for a time specified. You can specify the time in the When the system standby time has passed item of the System Power Mode window in Power Saver.

Battery save mode	This feature lets you save battery power. You can specify the Power Save Mode in the Running on batteries item of the Power Save Modes window in Power Saver.
Power on password.	Two levels of password security are available: supervisor and user. This feature prevents unauthorized access to your computer.
Instant security	A hotkey function blanks the screen and disables the computer providing quick and easy data security.
Panel power on/off	This feature turns power to the computer off when the display panel is closed and turns it back on when the panel is opened. You can specify the setting in the When I close the lid item of the System Power Mode window in Power Saver.
Auto power on	This feature lets you set a time and date for the computer to turn on automatically. The feature is useful for receiving remote communications while you are asleep or away. You can specify the setting in Scheduled Tasks.
Standby	If you have to interrupt your work, you can turn off the power without exiting from your software. Data is maintained in the computer's main memory. When you turn on the power again, you can continue working right where you left off.
Hibernation	This feature lets you turn off the power without exiting from your software. The contents of main memory is saved to the hard disk, when you turn on the power again, you can continue working right where you left off.

Heat dispersal	To protect from overheating, the CPU has an internal temperature sensor. If the computer's internal temperature rises to a certain level, the cooling fan is turned on or the processing speed is lowered. Use the Fan item of the <i>Power Save Modes</i> window in Power Saver.	
	Maximum Performance	Turns on fan first, then if necessary lowers CPU processing speed.
	Performance	Uses a combination of fan and lowering the CPU processing speed.
	Battery optimized	Lowers the CPU processing speed first, then if necessary turns on the fan.

Utilities

This section describes preinstalled utilities and tells how to start them. For details on operations, refer to each utility's online manual, help files or read.me files.

TOSHIBA Power Saver	To access this power savings management program, open the Control Panel and select the TOSHIBA Power Saver icon.
HW Setup	This program lets you customize your hardware settings according to the way you work with your computer and the peripherals you use. To start the utility, click the Windows Start button and click Control Panel. In the Control Panel, select the TOSHIBA HW Setup icon.
DVD Video Player	The DVD Video Player is used to play DVD-Video. It has an on-screen interface and functions. Click Start, point to All Programs, point to InterVideo WinDVD 4, then click InterVideo WinDVD 4.
Drag'n Drop CD + DVD	This easy-to-use software lets you record CDs with just a few mouse clicks. You can create CDs in several formats including audio CDs that can be played on a standard stereo CD player and data CDs to store the files and folders on your hard drive. This software can be used only on model with CD-RW/DVD-ROM drive and DVDMulti drive.

TOSHIBA Mobile Extension	This utility enables hot insertion of Slim Select Bay modules, that is, you can remove/insert Slim Select Bay modules while the computer is on. To activate this utility, select TOSHIBA Mobile Extension from TOSHIBA Console.
ConfigFree	ConfigFree is a suite of utilities to allow easy control of communication device and network connections. ConfigFree also allows you to find communication problems and create profiles for easy switching between location and communication networks. You can boot ConfigFree from the menu bar as follows. Windows XP: [Start] - [All Programs] - [TOSHIBA ConfigFree] - [ConfigFree]

Options

You can add a number of options to make your computer even more powerful and convenient to use. The following options are available:

Memory expansion	Two memory slots are available for installing 256 or 512 or 1024MB memory modules. The modules are PC2100, 200-pin, SO Dual In-line (SO-DIMM).
Main battery pack	An additional battery pack (PA3286*) can be purchased from your TOSHIBA dealer. The battery pack is identical to the one that came with your computer. Use it as a spare or replacement.
AC adaptor	If you use your computer at more than one site, it may be convenient to purchase an additional AC adaptor for each site so you will not have to carry the adaptor with you.
USB diskette drive	A 3 1/2" diskette drive accommodates 1.44-megabyte or 720-kilobyte diskettes. It connects to a USB port. (Windows® XP does not support 720-kilobyte diskettes.)
Security lock	A slot is available to attach a security cable to the computer to deter theft.

Advanced Port Replicator II

The Port Replicator provides the ports available on the computer in addition to separate PS/2 mouse and PS/2 keyboard ports, a digital visual interface (DVI) port, i.LINK™ (IEEE1394) port, line-in jack and line-out jack.



The TE2300 does not support the DVI and i.LINK ports on the Advanced Port Replicator II.

Slim Select Bay options

The following modules can be installed in the Slim Select Bay.

DVD-ROM drive	Refer to the <i>Features</i> section for details.
CD-RW/DVD-ROM drive	Refer to the <i>Features</i> section for details.
DVD Multi drive	Refer to the <i>Features</i> section for details.
Slim Select Bay HDD adaptor	An adaptor lets you insert an optional HDD described in Chapter 8, <i>Optional Devices</i> .
Hard disk drive	You can increase your computer's data storage capacity with an additional 30 GB (27.94 billion bytes), 40 GB (37.26 billion bytes), 60 GB (55.89 billion bytes) and 80 GB (74.51 billion bytes) hard disk drive in the Slim Select Bay HDD adaptor.
Slim Select Bay 2nd battery pack	The secondary battery increases your computer's battery power and operating time when a main battery is also installed.

The Grand Tour

This chapter identifies the various components of your computer. Become familiar with each component before you operate the computer.

Front with the display closed

The figure below shows the computer's front with its display panel in the closed position.

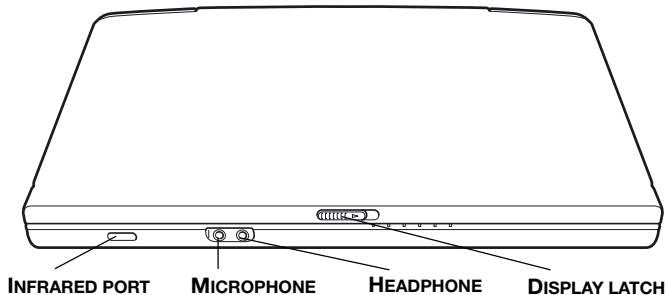

Front of the computer with display closed

Display latch This latch secures the LCD panel in its closed position. Slide the latch to open the display.



Microphone jack A standard 3.5 mm mini microphone jack enables connection of a three-conductor mini jack for monaural microphone input.



Headphone jack A standard 3.5 mm mini headphone jack enables connection of a stereo headphone (16 ohm minimum) or other device for audio output. When you connect headphones, the internal speakers are automatically disabled.



Infrared port

This infrared port is compatible with Infrared Data Association (IrDA 1.1) standards. It enables cableless 4 Mbps, 1.152 Mbps, 115.2 Kbps, 57.6 Kbps, 38.4 Kbps, 19.2 Kbps or 9.6 Kbps data transfer with IrDA 1.1 compatible external devices.

Left side

The figure below shows the computer's left side.

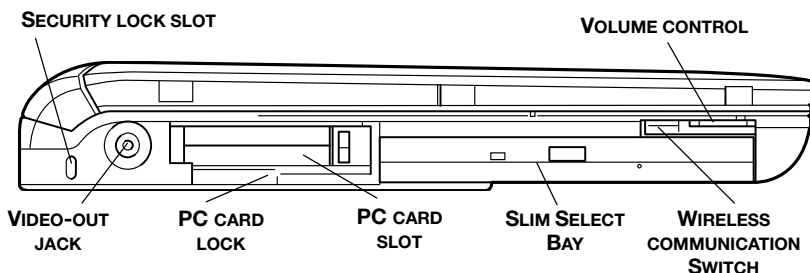

The left side of the computer



Security lock slot

A security cable attaches to this slot. The optional security cable anchors your computer to a desk or other large object to deter theft.



Video out

Video-out jack

Plug an RCA video connector into this jack.



PC card slot

A PC card slot can accommodate two 5 mm PC cards (Type II) or one 10.5 mm PC card (Type III). The slot supports 16-bit PC cards and CardBus PC cards.



Keep foreign objects out of the PC card slot. A pin or similar object can damage the computer's circuitry.



PC card lock

This lock prevents removal of a PC card when it is in the lock position and a security card is attached.

Slim Select Bay

A DVD-ROM drive, CD-RW/DVD-ROM drive, DVD Multi drive, Slim Select Bay HDD adaptor, or secondary battery pack can be installed in the Slim Select Bay.



Wireless communication switch

Slide this switch toward the back of the computer to turn on Wireless LAN. Slide it toward the front of the computer to turn off the functions.



Set the switch to off in airplanes and hospitals. Check the Wireless communication indicator. It will stop glowing when the wireless communication is off.



Volume control Use this dial to adjust the volume of the system speakers and headphones.

Right side

The figure below shows the computer's right side.



The right side of the computer

Back side

The figure below shows the computer's back side.

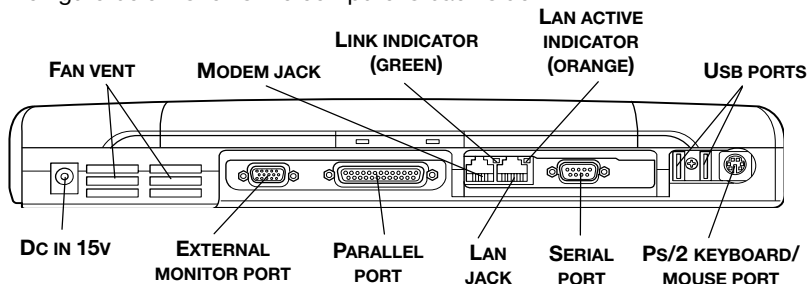

The computer's back side



DC IN 15V The AC adaptor connects to this socket. Use only the model of AC adaptor that comes with the computer. Using the wrong adaptor can damage your computer.

Fan vent Provides air flow for the fan.



Be careful not to block the fan vent. Also be careful to keep foreign objects out of the vents. A pin or similar object can damage the computer's circuitry.



External monitor This 15-pin port lets you connect an external monitor.



Parallel port This Centronics-compatible, 25-pin parallel port is used to connect a parallel printer or other parallel device. This port supports Extended Capabilities Port (ECP) standard.



Modem jack This jack lets you use a modular cable to connect the modem directly to a telephone line.



1. In case of a lightning storm, unplug the modem cable from the telephone jack.
2. Do not connect the modem to a digital telephone line. A digital line will damage the modem.

**LAN jack**

This jack lets you connect to a LAN. The adaptor has built-in support for Ethernet LAN (10 megabits per second, 10BASE-T) and Fast Ethernet LAN (100 megabits per second, 100BASE-Tx).

LAN active indicator (orange)

This indicator glows orange when data is being exchanged between the computer and the LAN.

Link indicator (green)

This indicator glows green when the computer is connected to a LAN and the LAN is functioning properly.

**Serial port**

Use this 9-pin port to connect external serial devices such as an external modem, a serial mouse or printer.

**Universal Serial Bus Port**

The two Universal Serial Bus (USB) ports comply with USB 2.0 standards, which enable data transfer speeds 40 times faster than the USB 1.1 standards. (The ports also support USB 1.1)



Keep foreign objects out of the USB connectors. A pin or similar object can damage the computer's circuitry.



Operation of all functions of all USB devices has not been confirmed. Some functions might not execute properly.

**PS/2 keyboard/mouse port**

Use this port to connect an external PS/2 compatible keyboard or mouse. The computer automatically recognizes which device you have connected when you turn on the power.

Underside

The figure below shows the underside of the computer. Make sure the display is closed before turning over your computer.

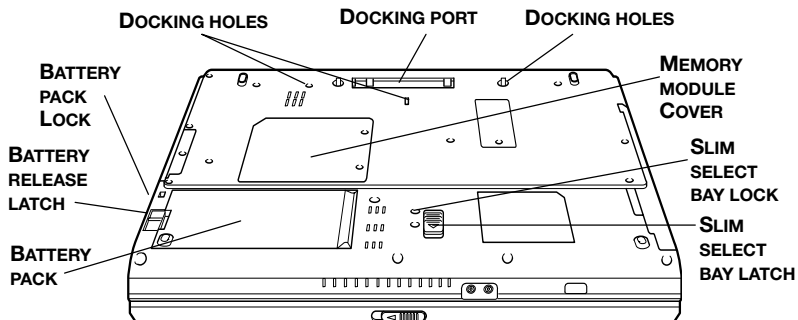

The underside of the computer



Docking port Use this port to connect an optional Advanced Port Replicator II.



Keep foreign objects out of the docking port. A pin or similar object can damage the computer's circuitry.

Docking holes These holes ensure a proper connection between the computer and an optional Advanced Port Replicator II.

Battery pack The battery pack powers the computer when the AC adaptor is not connected. The *Batteries* section in Chapter 6, *Power and Power-Up Modes*, describes how to access the battery pack. Additional battery packs can be purchased from your TOSHIBA dealer to extend the computer's battery operating time.



Battery pack lock Slide this lock to release or secure the battery pack.



Battery release latch Slide this latch to release or the battery pack.



Memory module cover This cover protects two memory module sockets. One or two modules are preinstalled.



Slim Select Bay lock

There are two screw holes next to the Slim Select Bay latch. One screw is initially set in the front hole, which is the unlock position. To lock the Slim Select Bay latch, set the screw in the back hole.



Use a point size 0 Phillips screwdriver.



Slim Select Bay latch

Slide this latch to free the Slim Select Bay for removal.

Front with the display open

The figure below shows the front of the computer with the display open. To open the display, slide the display latch on the front of the computer and lift the display up. Position the display at a comfortable viewing angle.

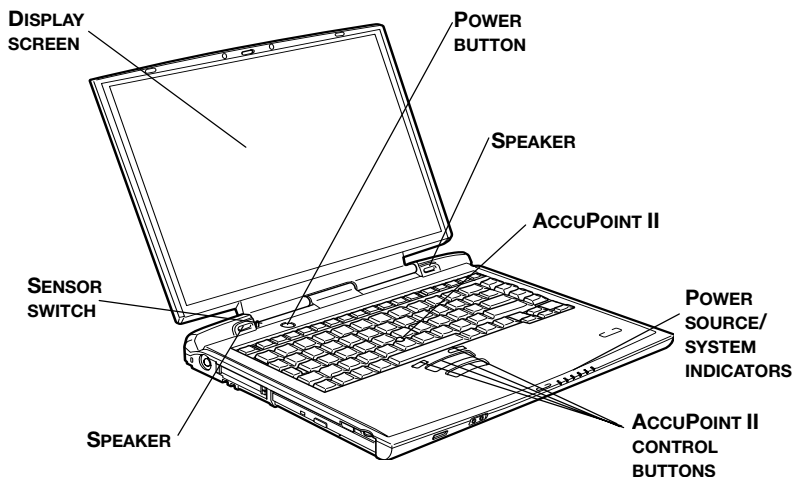

The front with the display open

Display screen	<p>The full-color LCD displays high-contrast text and graphics and is compatible with the industry standard eXtended Graphics Array (XGA). The LCD consists of up to 1024 × 768 pixels or dots. The computer has a Thin-Film Transistor (TFT) display. Refer to Appendix E.</p> <p>When the computer operates on power through the AC adaptor, the display screen's image will be somewhat brighter than when it operates on battery power. The lower brightness level is intended to save battery power.</p>
Power button	<p>Press the power button to turn the computer's power on and off.</p>
AccuPoint II	<p>A pointer control device located in the center of the keyboard is used to control the on-screen pointer. Refer to the AccuPoint II section in Chapter 4, <i>Operating Basics</i>.</p>
AccuPoint II control buttons	<p>Control buttons below the keyboard let you select menu items or manipulate text and graphics designated by the on-screen pointer.</p>
Speakers	<p>The speakers emit sound generated by your software as well as audio alarms, such as low battery condition, generated by the system.</p>
Power source/system indicators	<p>LEDs let you monitor the status of various computer functions. Details are given in the <i>Indicators</i> section.</p>
Sensor switch	<p>This switch shuts down the computer when you close the cover and the panel power on/off feature is enabled.</p>

System Indicators

The figure below shows the indicators, which light when various computer operations are in progress.

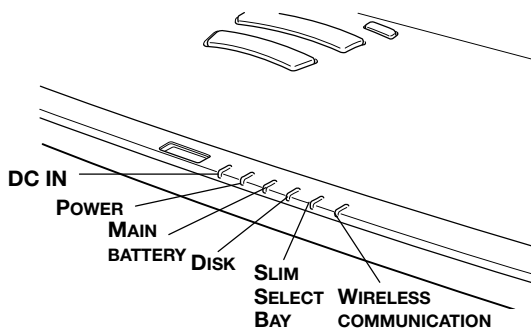

The power source/system indicators

Power source/system indicators



DC IN

The **DC IN** indicator glows green when DC power is supplied from the AC power adaptor. If the adaptor's output voltage is abnormal or if the power supply malfunctions, this indicator flashes orange.



Power

The **Power** indicator glows green when the computer is on. If you turn off the computer in Resume mode, this indicator blinks orange (one second on, two seconds off) while the computer shuts down.



Main battery

The **Main battery** indicator shows the condition of the charge. Green means fully charged and orange means being charged. Refer to Chapter 6, Power and Power-Up Modes.



Disk

The **Disk** indicator glows green when the computer is accessing a disk drive.



Slim Select Bay

The **Slim Select Bay** indicator glows green when the computer is accessing a DVD-ROM drive, CD-RW/DVD-ROM drive, DVD Multi drive, Slim Select Bay HDD adaptor or secondary battery pack in the Slim Select Bay. When the secondary battery is charging, the indicator glows orange.



Wireless communication

The **Wireless communication** indicator glows orange when the Wireless LAN function is turned on.

The figures below show the positions of the keypad overlay indicators and the CapsLock indicator.

When the F10 key indicator glows the keypad overlay lets you enter numbers. When the F11 key indicator glows the keypad overlay lets you control the cursor.

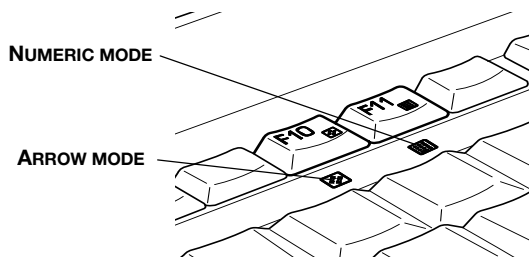

Keypad overlay indicators

When the CapsLock indicator glows the keyboard is in all-caps mode.

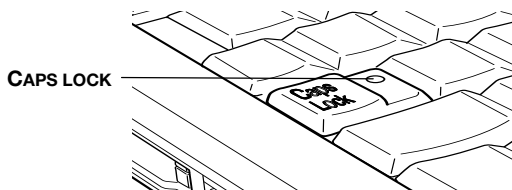

CapsLock indicator

Keyboard indicator

Caps Lock This indicator glows green when the alphabet keys are locked in uppercase.



Arrow mode When the **Arrow mode** indicator lights green, you can use the keypad overlay (white labeled keys) as cursor keys. Refer to the *Keypad overlay* section in Chapter 5, *The Keyboard*.



Numeric mode You can use the keypad overlay (white labeled keys) for numeric input when the **Numeric mode** indicator lights green. Refer to the *Keypad overlay* section in Chapter 5, *The Keyboard*.

USB diskette drive

Some computers in this series come with a 3 1/2" diskette drive that accommodates 1.44-megabyte or 720-kilobyte diskettes. It connects to the USB port.

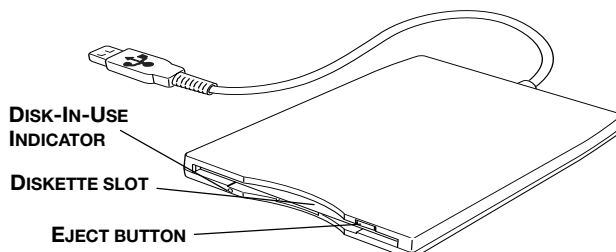

USB diskette drive

Disk-In-Use Indicator	This indicator lights when the diskette is being accessed.
Diskette slot	Insert diskette in this slot.
Eject button	When a diskette is fully seated in the drive, the eject button pops out. To remove a diskette, push in the eject button and the diskette pops out partially for removal.



Check the **Disk-In-Use** indicator when you use the diskette drive. Do not press the eject button or turn off the computer while the light is glowing. Doing so could destroy data and damage the diskette or the drive.



1. The external diskette drive should be placed on a flat, horizontal surface when in use. Do not set the drive on an incline greater than 20° while it is operating.
2. Do not set anything on top of the diskette drive.

Slim Select Bay modules

The Slim Select Bay can accommodate the following modules: DVD-ROM drive, CD-RW/DVD-ROM drive, DVD multi drive, optional Slim Select Bay HDD adaptor and optional Slim Select Bay 2nd battery pack.

DVD-ROM drive

An optional full-size DVD-ROM drive module lets you run either 12 cm (4.72") or 8 cm (3.15") CD/DVDs without using an adaptor. It may be selected as a standard component or as an option.



The read speed is slower at the center of a disk and faster at the outer edge. The maximum (outer edge) speeds for DVDs and CDs are:

DVD 8 speed (maximum)

CD 24 speed (maximum)

This drive supports the following formats:

- DVD-ROM
- DVD-Video
- Photo CD
- CD-R (read only)
- CD-ROM
- CD-Rewritable (read only)
- CD-ROM x A
- CD-DA
- CD-EXTRA
- CD-Text

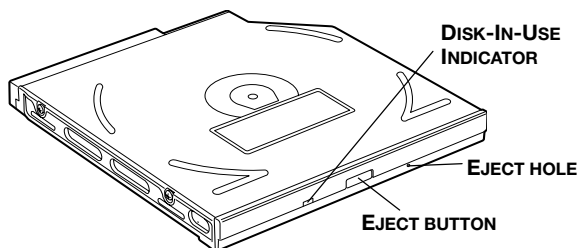

The optical media device

Disc-In-Use Indicator	This indicator lights when the CD/DVD is being accessed.
Eject button	Press the eject button to open the drawer partially.
Eject hole	Insert a slender object to open the drawer when the power to the computer is off.



Check the **Slim Select Bay** indicator when you use the DVD-ROM drive. Do not press the eject button, disconnect a drive or turn off the computer while the light is glowing. Doing so could damage the DVD/CD or the drive.

DVD-ROM drives and media are manufactured according to the specifications of six marketing regions. When you purchase DVD media, make sure it matches your drive, otherwise it will not play properly.

Code	Region
1	Canada, United States
2	Japan, Europe, South Africa, Middle East
3	Southeast Asia, East Asia
4	Australia, New Zealand, Pacific Islands, Central America, South America, Caribbean
5	Russia, Indian Subcontinent, Africa, North Korea, Mongolia
6	China

CD-RW/DVD-ROM drive

The full-size CD-RW/DVD-ROM drive module lets you record data to rewritable CDs as well as run either 12 cm (4.72") or 8 cm (3.15") CD/DVDs without using an adaptor. The computer is configured with either a DVD-ROM drive or CD-RW/DVD-ROM drive.



The read speed is slower at the center of a disc and faster at the outer edge.

DVD read	8 speed (maximum)
CD read	24 speed (maximum)
CD-R write	24 speed (maximum)
CD-RW write	10 speed (maximum)

This drive supports the following formats:

- Photo CD
- CD-ROM
- CD-DA
- CD-ROM x A Mode 2 (Form1, Form2)
- CD-R
- CD-Rewritable
- CD-Text
- Enhanced CD (CD-EXTRA)

CD-R describes compact disks that can be written only once. The recorded data cannot be erased or changed. Use 8-speed CD-R disks.

CD-RW describes compact disks that can be recorded more than once. Use either 1, 2, or 4 multi speed CD-RW disks or high-speed 4- to 10-speed disks. The write speed of the high-speed CD-RW disks is maximum 8-speed.

- Use Drag'n Drop CD+DVD to write compact disks.



The physical features of this drive are similar to those of the DVD-ROM drive. Refer to the illustration in the DVD-ROM drive section.



*Check the **Slim Select Bay** indicator when you use the CD-RW/DVD-ROM drive. Do not press the eject button, disconnect a drive or turn off the computer while the light is glowing. Doing so could damage the CD or the drive.*

CD-RW/DVD-ROM drives and media are manufactured according to the specifications of six marketing regions. When you purchase DVD media, make sure it matches your drive, otherwise it will not play properly.

Code	Region
1	Canada, United States
2	Japan, Europe, South Africa, Middle East
3	Southeast Asia, East Asia
4	Australia, New Zealand, Pacific Islands, Central America, South America, Caribbean
5	Russia, Indian Subcontinent, Africa, North Korea, Mongolia
6	China

DVD Multi drive

The full-size DVD Multi drive module lets you record data to rewritable CD/DVDs as well as run either 12 cm (4.72") or 8 cm (3.15") CD/DVDs without using an adaptor.

An ATAPI interface controller is used for CD/DVD-ROM operation. When the computer is accessing a CD/DVD, an indicator on the drive glows and Slim Select Bay indicator glows.



The read speed is slower at the center of a disc and faster at the outer edge.

DVD read	8 speed (maximum)
DVD-R write	1 speed
DVD-RW write	1 speed

DVD-RAM write	2 speed
CD read	24 speed (maximum)
CD-R write	16 speed (maximum)
CD-RW write	8 speed (maximum)

This drive supports the following formats:

- DVD-ROM
- DVD-Video
- CD-DA
- CD-Text
- Photo CD (single/multi-session)
- CD-ROM Mode1, Mode2
- CD-ROM XA Mode2 (Form1, Form2)
- Enhanced CD (CD-EXTRA)
- CD-G (Audio CD only)
- Addressing Method 2

DVD Multi drives and disc are manufactured according to the specifications of six marketing regions. When you purchase DVD-Video, make sure it matches your drive, otherwise it will not play properly.

Code	Region
1	Canada, United States
2	Japan, Europe, South Africa, Middle East
3	Southeast Asia, East Asia
4	Australia, New Zealand, Pacific Islands, Central America, South America, Caribbean
5	Russia, Indian Subcontinent, Africa, North Korea, Mongolia
6	China



Use the WinDVD 4 application to view DVD-Video discs.

CD-R and DVD-R discs can be written only once. The recorded data cannot be erased or changed.

CD-RW discs can be recorded more than once. Use either 1, 2, or 4 multi speed CDRW discs or high-speed 4- to 10-speed discs. The write speed of the high-speed CD-RW discs is maximum 10-speed.

DVD-RW/-RAM discs can be recorded more than once.

Slim Select Bay HDD adaptor (Black)

You can increase your computer's data storage capacity by installing an optional, integrated, 2 1/2" HDD in the Slim Select Bay.

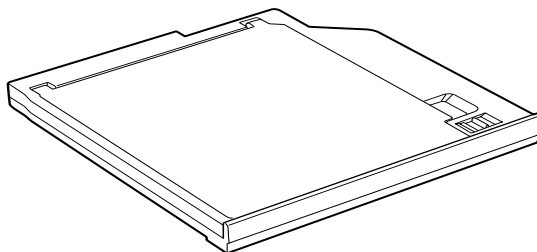

The Slim Select Bay HDD adaptor

Slim Select Bay 2nd battery pack (Black)

An optional battery pack can be installed in the Slim Select Bay to increase the computer's battery power and operating time. For details, refer to the documentation accompanying the secondary battery pack. Refer to Chapter 8, *Optional Devices*, for details on installing a Slim Select Bay 2nd battery pack.

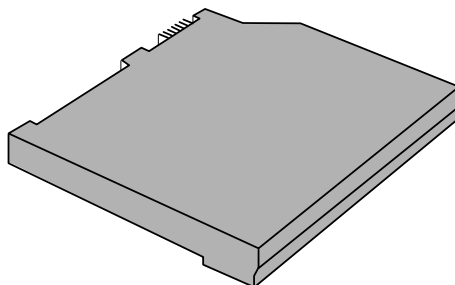

The Slim Select Bay 2nd battery pack

AC adaptor

The AC adaptor converts AC power to DC power and reduces the voltage supplied to the computer. It can automatically adjust to any voltage from 100 to 240 volts and to a frequency of either 50 or 60 hertz, enabling you to use the computer in almost any region.

To recharge the battery, simply connect the AC adaptor to a power source and the computer. See Chapter 6, *Power and Power-Up Modes*, for details.

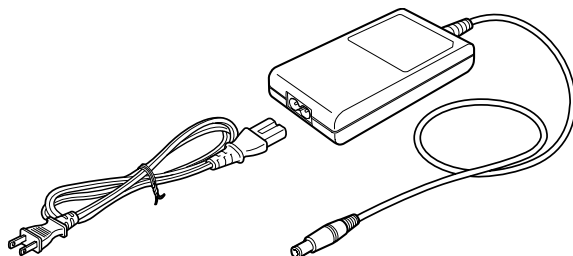

The AC adaptor



Use of the wrong adaptor could damage your computer. TOSHIBA assumes no liability for any damage in such case. The current rating for the computer is 5.0 amperes.

Getting Started

This chapter provides basic information to get you started using your computer. It covers the following topics:

- Setting up your work space — for your health and safety



Be sure also to read the Safety Instruction Manual. This guide, which is included with the computer, explains product liability.

- Connecting the AC adaptor
- Opening the display
- Turning on the power
- Starting up for the first time
- Turning off the power
- Restarting the computer
- Restoring the preinstalled software

If you are a new user, follow the steps in each section of this chapter as you prepare to operate your computer.



All users should be sure to carefully read the section Restoring the preinstalled software.

Setting up your work space

Establishing a comfortable work site is important for you and your computer. A poor work environment or stressful work habits can result in discomfort or serious injury from repetitive strain to your hands, wrists or other joints. Proper ambient conditions should also be maintained for the computer's operation. This section discusses the following topics:

- General conditions
- Placement of the computer and peripheral devices
- Seating and posture
- Lighting
- Work habits

General conditions

In general, if you are comfortable, so is your computer, but read the following to make sure your work site provides a proper environment.

- Make sure there is adequate space around the computer for proper ventilation.
- Make sure the AC power cord connects to an outlet that is close to the computer and easily accessible.
- The temperature should be 5 to 35 degrees Centigrade (41 to 95 degrees Fahrenheit) and the relative humidity should be 20 to 80 percent.
- Avoid areas where rapid or extreme changes in temperature or humidity may occur.
- Keep the computer free of dust, moisture, and exposure to direct sunlight.
- Keep the computer away from heat sources, such as electric heaters.
- Do not use the computer near liquids or corrosive chemicals.
- Do not place the computer near objects that create strong magnetic fields (e.g., stereo speakers).
- Do not operate the computer in close proximity to a mobile phone.
- Leave ample ventilation room for the fan. Do not block the vents.

Placement of computer

Position the computer and peripheral devices to provide comfort and safety.

- Set the computer on a flat surface at a comfortable height and distance. The display should be no higher than eye level to avoid eye strain.

- Place the computer so that it is directly in front of you when you work and make sure you have adequate space to easily operate other devices.
- Allow adequate space behind the computer to let you freely adjust the display. The display should be angled to reduce glare and maximize visibility.
- If you use a paper holder, set it at about the same height and distance as the computer.

Seating and posture

The height of your chair in relation to the computer and keyboard as well as the support it gives your body are primary factors in reducing work strain. Refer to the following tips and to the figure below.

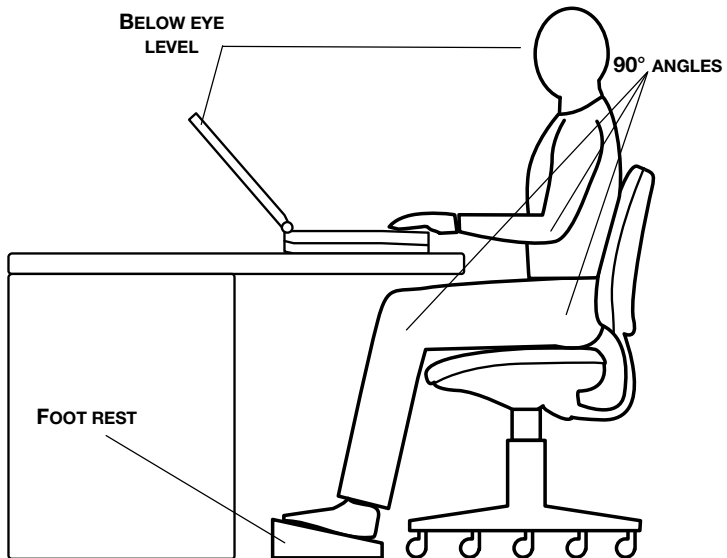

Posture and positioning of the computer

- Place your chair so that the keyboard is at or slightly below the level of your elbow. You should be able to type comfortably with your shoulders relaxed.
- Your knees should be slightly higher than your hips. If necessary, use a foot rest to raise the level of your knees to ease pressure on the back of your thighs.
- Adjust the back of your chair so it supports the lower curve of your spine.
- Sit straight so that your knees, hips and elbows form approximately 90 degree angles when you work. Do not slump forward or lean back too far.

Lighting

Proper lighting can improve legibility of the display and reduce eye strain.

- Position the computer so that sunlight or bright indoor lighting does not reflect off the screen. Use tinted windows, shades or other screen to eliminate sun glare.
- Avoid placing the computer in front of bright light that could shine directly in your eyes.
- If possible, use soft, indirect lighting in your computer work area. Use a lamp to illuminate your documents or desk, but be sure to position the lamp so that it does not reflect off the display or shine in your eyes.

Work habits

A key to avoiding discomfort or injury from repetitive strain is to vary your activities. If possible, schedule a variety of tasks into your work day. If you must spend long periods at the computer, finding ways to break up the routine can reduce stress and improve your efficiency.

- Sit in a relaxed posture. Good positioning of your chair and equipment as described earlier can reduce tension in your shoulders or neck and ease back strain.
- Vary your posture frequently.
- Occasionally stand up and stretch or exercise briefly.
- Exercise and stretch your wrists and hands a number of times during the day.
- Frequently, look away from the computer and focus your eyes on a distant object for several seconds, for example 30 seconds every 15 minutes.
- Take frequent short breaks instead of one or two long breaks, for example, two or three minutes every half hour.
- Have your eyes examined regularly and visit a doctor promptly, if you suspect you might be suffering from a repetitive strain injury.

A number of books are available on ergonomics and repetitive strain injury or repetitive stress syndrome. For more information on these topics or for pointers on exercises for such stress points as hands and wrists, please check with your library or book vendor. Also refer to the computer's Safety Instruction Manual.

Connecting the AC adaptor

Attach the AC adaptor when you need to charge the battery or you want to operate from AC power. It is also the fastest way to get started, because the battery pack will need to be charged before you can operate from battery power.

The AC adaptor can be connected to any power source supplying from 100 to 240 volts and 50 or 60 hertz. For details on using the AC adaptor to charge the battery pack, refer to Chapter 6, *Power and Power-Up Modes*.



Use of the wrong adaptor could damage your computer. TOSHIBA assumes no liability for any damage in such case. The current rating for the computer is 5.0 amperes.

1. Connect the power cord to the AC adaptor.

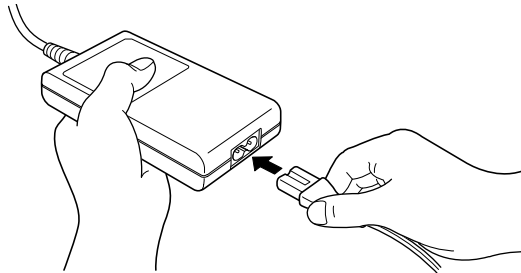

Connecting the power cord to the AC adaptor

2. Connect the AC adaptor's DC output plug to the **DC IN** port on the back side of the computer.

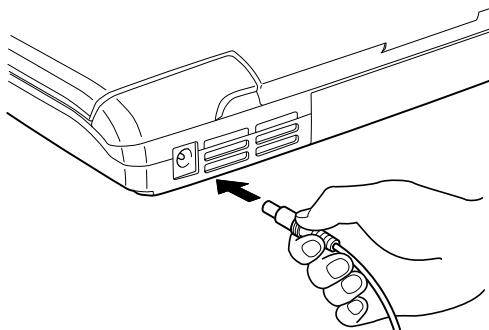

Connecting the adaptor to the computer

3. Plug the power cord into a live wall outlet. The Battery and **DC IN** indicator on the front of the computer should glow.

Opening the display

The display panel can be rotated in a wide range of angles for optimal viewing.

1. Slide the display latch on the front of the computer to the right to unlatch the display panel.
2. Lift the panel up and adjust it to the best viewing angle for you.



When you open the display, hold it with both hands and lift up slowly.

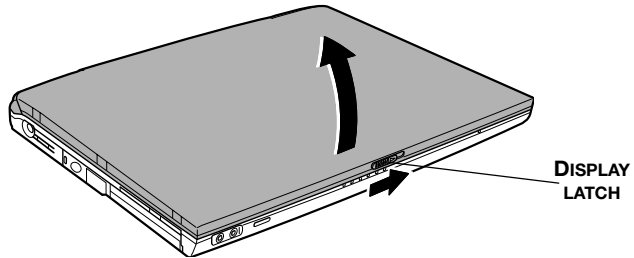

Opening the display panel

Turning on the power

This section describes how to turn on the power.



After you turn on the power for the first time, do not turn it off until you have set up the operating system (OS) and the OS has started up.

1. If an external diskette drive is connected, make sure it is empty. If a diskette is in the drive, press the eject button and remove the diskette.
2. Open the display panel.
3. Press and hold the button for two or three seconds.

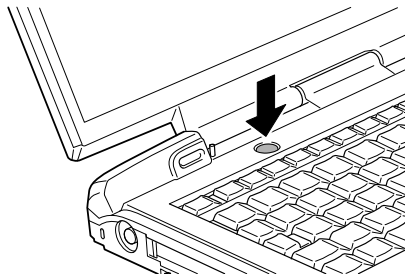

Turning on the power

Starting up for the first time

When you first turn on the power, the computer's initial screen is the Microsoft Windows® XP Professional Startup Screen Logo.

Follow the on-screen directions.

Turning off the power

The power can be turned off in one of the following modes: Shut down (Boot), Hibernation or Standby mode.

Shut Down mode (Boot mode)

When you turn off the power in Shut Down mode, no data is saved and the computer will boot to the operating system's main screen.

1. If you have entered data, save it to the hard disk or to a diskette.
2. Make sure all disk(disc)activity has stopped, then remove any CD/DVDs or diskette.



Make sure the Disk, Slim Select Bay and Slim Select Bay's module indicators are off. If you turn off the power while a disk (disc) is being accessed, you can lose data or damage the disk(disc).

3. Click start then click **Turn off computer**. From the **Turn off computer** menu select **Turn off**.
4. Turn off the power to any peripheral devices.



Do not turn the computer or devices back on immediately. Wait a moment to let all capacitors fully discharge.

Hibernation mode

The hibernation feature saves the contents of memory to the hard disk when the computer is turned off. The next time the computer is turned on, the previous state is restored. The hibernation feature does not save the status of peripheral devices.



1. *While entering hibernation mode, the computer saves the contents of memory to the HDD. Data will be lost if you remove the battery or disconnect the AC adaptor before the save is completed. Wait for the **Disk** indicator to go out.*
2. *Do not install or remove a memory module while the computer is in hibernation mode. Data will be lost.*

Benefits of hibernation

The hibernation feature provides the following benefits:

- Saves data to the hard disk when the computer automatically shuts down because of a low battery.



For the computer to shut down in hibernation mode, the hibernation feature must be enabled in two places in TOSHIBA Power Saver: the Hibernate window and the Battery Alarm item of the Alarm window. Otherwise, the computer will shut down in Standby mode. If battery power becomes depleted, data saved in Standby will be lost.

- You can return to your previous working environment immediately when you turn on the computer.
- Saves power by shutting down the system when the computer receives no input or hardware access for the duration set by the System hibernate feature.
- You can use the panel power off feature.

Starting Hibernation

To enter Hibernation mode, follow the steps below.

1. Click **Start**.
2. Select **Turn Off Computer**.
3. Open the **Turn Off Computer** dialog box. **Hibernate** is not displayed.
4. Press the **Shift** key. The **standby** item will change to **Hibernate**.
5. Select **Hibernate**.

Automatic Hibernation

The computer will enter Hibernate mode automatically when you press the power button or close the lid. First, however, make the appropriate settings according to the steps below.

1. Open the **Control Panel**.
2. Open **Performance and Maintenance** and open **TOSHIBA Power Saver**.
3. Select the **Hibernate window**, select the **Enable Hibernate support** check box and click the **Apply** button.
4. Select the **Power Save Modes** window.
5. Double-click **Power Mode (Full Power, Normal, etc.)** and open the **System Power Mode** window.
6. Enable the desired Hibernation settings for **When I press the power button** and **When I close the lid**.
7. Click the **OK** button.

Data save in hibernation mode

When you turn off the power in hibernation mode, the computer takes a moment to save current memory data to the hard disk. During this time, the Built-in HDD indicator will light.

After you turn off the computer and memory is saved to the hard disk, turn off the power to any peripheral devices.



Do not turn the computer or devices back on immediately. Wait a moment to let all capacitors fully discharge

Standby mode

In standby mode the power remains on, but the CPU and all other devices are in sleep mode.



1. Before entering Standby mode, be sure to save your data.
2. Do not install or remove a memory module while the computer is in standby mode. The computer or the module could be damaged.
3. Do not remove the battery pack while the computer is in standby mode (unless the computer is connected to an AC power source). Data in memory will be lost.
4. If you carry the computer on board an aircraft or into a hospital, be sure to shut down the computer in hibernation mode or in shutdown mode to avoid radio signal interference.

Benefits of standby

The standby feature provides the following benefits:

- Restores the previous working environment more rapidly than does hibernation.
- Saves power by shutting down the system when the computer receives no input or hardware access for the duration set by the System Standby feature.
- You can use the panel power off feature.

Executing standby



*You can also enable Standby by pressing **Fn + F3**. See Chapter 5, The Keyboard, for details.*

You can enter standby mode in one of three ways:

1. Click **Start**, click **Turn Off Computer** and click **Stand by**.
2. Close the display panel. This feature must be enabled. Refer to the System Power Mode item in Power Saver Utility described in the Control Panel.

Open **Performance and Maintenance** and open **TOSHIBA Power Saver**.

3. Press the power button. This feature must be enabled. Refer to the System Power Mode item in Power Saver Utility described in the Control Panel.

Open **Performance and Maintenance** and open **TOSHIBA Power Saver**.

When you turn the power back on, you can continue where you left when you shut down the computer.



1. *When the computer is shut down in standby mode, the power indicator glows orange.*
2. *If you are operating the computer on battery power, you can lengthen the operating time by shutting down in hibernation mode. Standby mode consumes more power.*

Standby limitations

Standby will not function under the following conditions:

- Power is turned back on immediately after shutting down.
- Memory circuits are exposed to static electricity or electrical noise.

Restarting the computer

Certain conditions require that you restart the computer system. For example, if:

- You change certain computer settings.
- An error occurs and the computer does not respond to your keyboard commands.

There are three ways to restart the computer system:

1. Click **start** then click **Turn off computer**. From the **Turn off** computer menu select **Restart**.
2. Press **Ctrl + Alt + Del** to display the **Windows Task Manager**, then select **Shutdown** and **Restart**.
3. Press the power button and hold it down for five seconds. Wait 10 to 15 seconds, then turn the power on again by pressing the power button.

Restoring the preinstalled software

If preinstalled files are damaged, use the Product Recovery CD-ROM or the TOSHIBA Tools & Utilities CD-ROM to restore them.

Restoring the complete system

To restore the operating system and all preinstalled software, follow the steps below.



When you reinstall the Windows operating system, the hard disk will be reformatted and all data will be lost.

1. Load the Product Recovery CD-ROM in the drive and turn off the computer's power.
2. Hold down the **F12** key and turn on the power. When **In Touch with Tomorrow TOSHIBA** appears, release the **F12** key.
3. Use the left or right cursor key to select the CD-ROM drive in the display menu. For details, refer to *the Boot priority section* in Chapter 7, *HW Setup and Passwords*.
4. Follow the on-screen instructions.
5. If your computer came with additional software installed, this software can not be recovered from the Product Recovery disk. Re-install these applications (e.g. Works Suite, DVD Player, Games, etc) separately from other media.

Restoring TOSHIBA utilities and drivers

If Windows is working properly, individual drivers or applications can be separately restored. Use the Tools & Utilities CD-ROM according to instructions in the booklet contained in the CD box to reinstall TOSHIBA utilities and drivers.

Chapter 4

Operating Basics

This chapter gives information on basic operations including using AccuPoint II, USB diskette drive, optical media drives, the internal modem, Wireless LAN, LAN and changing Slim Select Bay modules. It also provides tips on caring for your computer, diskettes and CD/DVDs.

Using AccuPoint II

To use the AccuPoint II, simply push it with your finger tip in the direction you want to move the on-screen pointer.

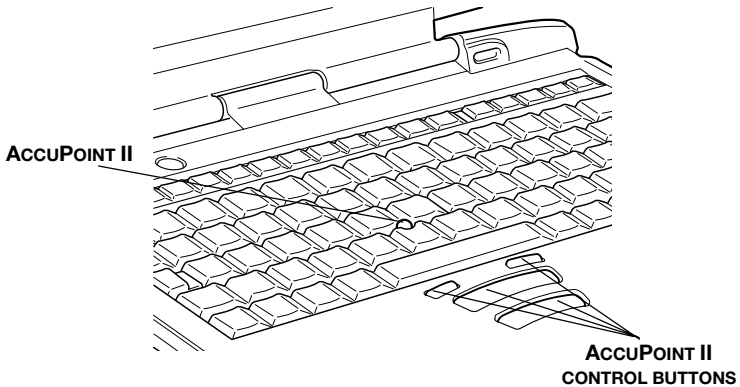

AccuPoint II and control buttons

Two large buttons below the keyboard are used like the buttons on a mouse pointer. Press a button to select a menu item or to manipulate text or graphics designated by the pointer. The right small button scrolls down the screen and the left one scrolls up.

AccuPoint II precautions

Certain conditions can affect the on-screen pointer when using AccuPoint II. For example, the pointer may travel contrary to AccuPoint II operation or an error message may appear, if

- You touch the AccuPoint II during power-up.
- You apply constant, soft pressure during power-up.
- There is a sudden temperature change.
- Strong stress is applied to the AccuPoint II.

If an error message appears, reboot the computer. If an error message does not appear, wait a moment for the pointer to stop, then continue operation.

Replacing the cap

The AccuPoint II cap is an expendable item that should be replaced after prolonged use.

1. To remove the AccuPoint II cap, firmly grasp the cap and pull it straight up.

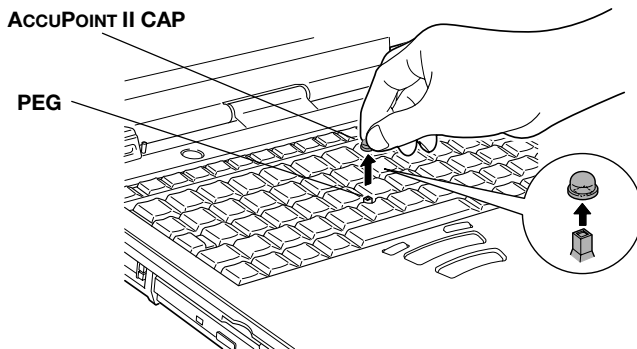

Removing the AccuPoint II cap

2. Position a new cap on the peg and press it into place.



The peg is square, so be careful to align the cap's square hole with the peg.

Using the USB diskette drive

A 3 1/2" diskette drive connects to the computer's USB port. It accommodates 1.44-megabyte or 720-kilobyte diskettes. Refer to Chapter 2, *The Grand Tour*, for more information.

Connecting 3 1/2" diskette drive

To connect the drive, plug the diskette drive connector into a USB port. Refer to figure below.



Make sure the connector is right side up and properly aligned with the socket. Do not try to force the connection, doing so can damage the connecting pins.

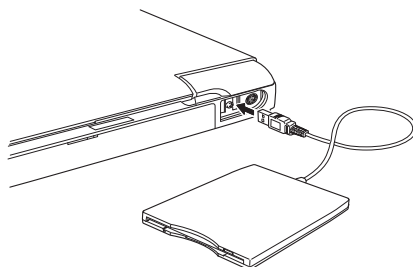

Connecting the USB diskette drive



If you connect the diskette drive after turning on the computer, it will take about 10 seconds for the computer to recognize the drive. Do not disconnect and reconnect before 10 seconds has elapsed.

Disconnecting 3 1/2" diskette drive

When you have finished using the diskette drive, follow the procedures below to disconnect it:

1. Wait for the indicator light to go out to make sure all diskette activity has stopped.



If you disconnect the diskette drive or turn off the power while the computer is accessing the drive you may lose data or damage the diskette or the drive.

2. Open the **Safety Remove Hardware** icon on the system tray.
3. Click **Diskette drive**.
4. Pull the diskette drive connector out of the USB port.

Changing Slim Select Bay modules

This section explains how to change modules in the Slim Select Bay. The illustrations show replacement of the DVD-ROM drive with the Slim Select Bay HDD adaptor. Therefore, the text refers to those modules. However, the procedures are the same for any of the other modules: CD-RW/DVD-ROM drive, DVD Multi drive, Slim Select Bay 2nd battery pack.



1. To avoid injury, do not put your hand into the Slim Select Bay slot.
2. Before removing or inserting a second battery pack, turn off the computer's power.



The TOSHIBA Mobile Extension is preinstalled to support hot swapping under Windows. Refer to Chapter 1, Introduction, for information on using this utility to change modules while the computer's power is on.

Removing a module

Remove the DVD-ROM drive as described below.

1. Check all disk indicators to make sure no disks are operating.
2. Turn the computer upside down.



Wait for all disc indicators to go out before you turn over the computer and be careful to lay the computer down gently. Shock can damage the HDD or other components.

3. Be sure the screw near the icon securing the Slim Select Bay.
4. Make sure the screw in the Slim Select Bay lock is set in the hole for the unlock position.
5. Slide the Slim Select Bay latch to the unlock position.
6. Graps the DVD-ROM drive and Slide it out.



The DVD-ROM drive and other Slim Select Bay modules can become hot with use. Be careful when removing the module.

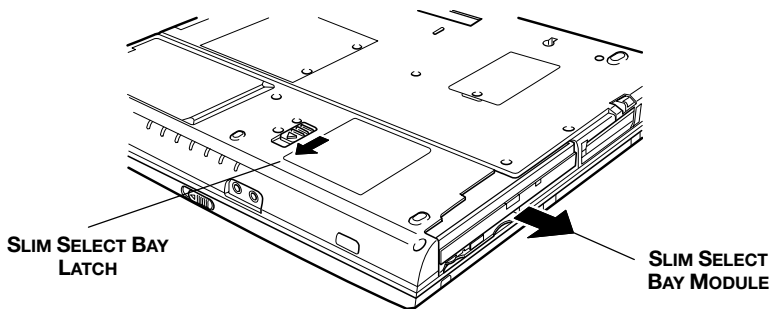

Removing the DVD-ROM drive

Installing a module

Install the Slim Select Bay HDD adaptor as described below.

1. Insert the Slim Select Bay HDD adaptor in the computer as shown below and press until the ejector clicks.
2. If you want to lock the Slim Select Bay module, set the screw of the Slim Select Bay lock in the back hole.

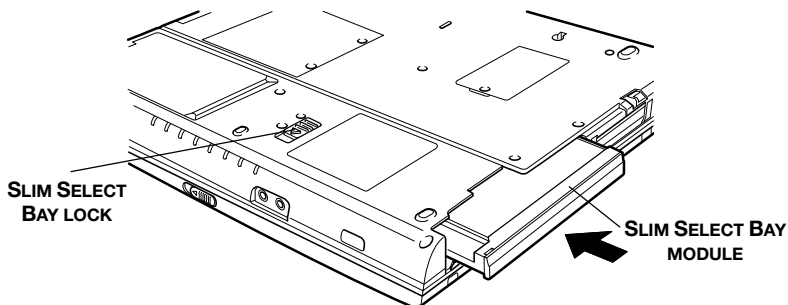

Installing the Slim Select Bay HDD adaptor

Using optical media drives

The text and illustrations in this section refer primarily to the DVD-ROM drive. However, operation is the same for the CD-RW/DVD-ROM and DVD Multi drives. The full-size drive provides high-performance execution of CD/DVD-ROM-based programs. You can run either 12 cm (4.72") or 8 cm (3.15") CD/DVDs without an adaptor. An ATAPI interface controller is used for CD/DVD-ROM operation. When the computer is accessing a CD/DVD-ROM, an indicator on the drive glows and the **Slim Select Bay** indicator glows.



Use the WinDVD 4 application to view DVD-Video discs.

If you have a CD-RW/DVD-ROM drive, refer also to the *Writing CDs* section for precautions on writing to CDs.

Loading discs

To load CD/DVDs, follow the steps below and refer to next figures.

1. a. When the power is on, press the DVD-ROM eject button to open the drawer slightly.

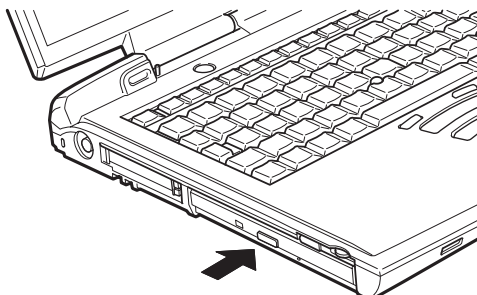

Pressing the DVD-ROM eject button

1. b. Pressing the eject button will not open the drawer when the DVD-ROM drive's power is off. If the power is off, you can open the drawer by inserting a slender object (about 15 mm) such as a straightened paper clip into the eject hole just to the right of the eject button.

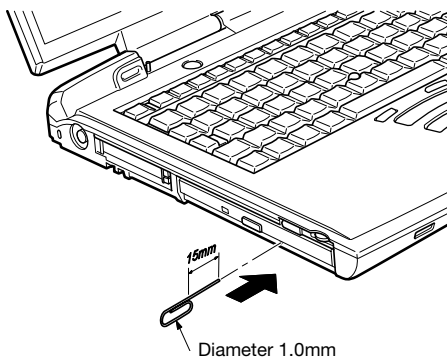

Manual release with the eject hole

2. Grasp the drawer gently and pull until it is fully opened.

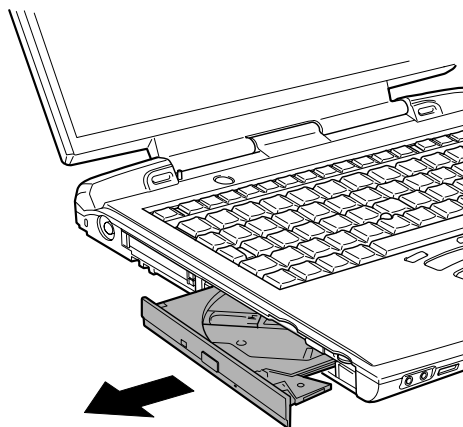

Pulling the drawer open

3. Lay the CD/DVD, label side up, in the drawer.

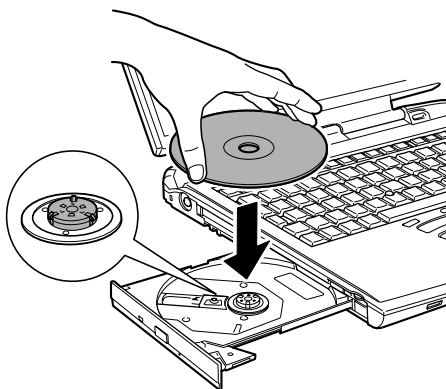

Inserting a CD/DVD



When the drawer is fully opened, the edge of the computer will extend slightly over the CD/DVD tray. Therefore, you will need to turn the CD/DVD at an angle when you place it in the tray. After seating the CD/DVD, however, make sure it lies flat, as shown in the figure above.



- 1. Do not touch the laser lens. Doing so could cause misalignment.*
- 2. Be careful to keep foreign matter from entering the drive. Check the back edge of the tray to make sure it carries no debris before closing the drive.*
- 4. Press gently at the center of the CD/DVD until you feel it click into place. The CD/DVD should lie below the top of the spindle, flush with the spindle base.*
- 5. Push the center of the drawer to close it. Press gently until it locks into place.*



If the CD/DVD is not seated properly when the drawer is closed, the CD/DVD might be damaged. Also, the drawer might not open fully when you press the eject button.

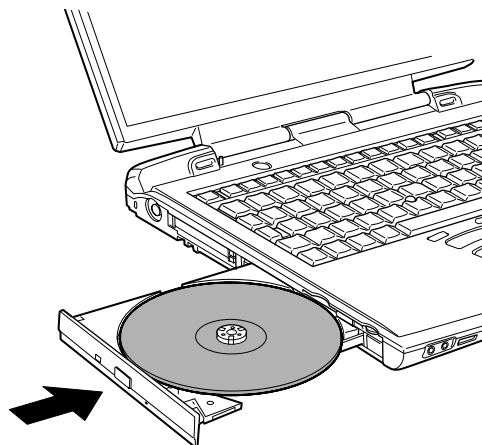

Closing the DVD-ROM drawer

Removing discs

To remove the CD/DVD, follow the steps below and refer to the next figure.



*Do not press the eject button while the computer is accessing the DVD-ROM drive. Wait for the **DVD-In-Use** indicator to go out before you open the drawer. Also, if the CD/DVD is spinning when you open the drawer, wait for it to stop before you remove it.*

1. To pop the drawer partially open, press the eject button. Gently pull the drawer out until it is fully opened.



1. When the drawer pops open slightly, wait a moment to make sure the CD/DVD has stopped spinning before pulling the drawer fully open.

2. Turn off the power before you use the eject hole. If the CD/DVD is spinning when you open the drawer, the CD/DVD could fly off the spindle and cause injury.

2. The CD/DVD extends slightly over the sides of the drawer so you can grasp it. Hold the CD/DVD gently and lift it out.

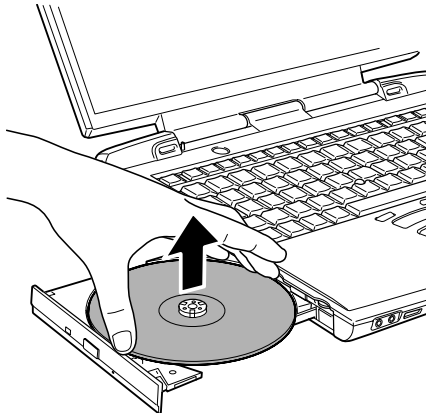

Removing a CD/DVD

3. Push the center of the drawer to close it. Press gently until it locks into place.

Writing CDs on CD-RW/DVD-ROM drive

Depending on the type of drive installed, you may be able to write CDs. The CD-RW/DVD-ROM drive lets you write as well as read CD-ROMs. Observe the precautions in this section to ensure the best performance for writing CDs. For information on loading and unloading CDs refer to the *Using optical media drive* section.



CD-R discs can be written to only once. CD-RW discs can be rewritten many times.

Before writing or rewriting

Please observe the following points when you write or rewrite the data.

- We recommend the following manufacturers of CD-R and CD-RW media. Media quality can affect write or rewrite success rates.

CD-R:	TAIYOYUDENCO.,LTD. Mitsui Chemicals Inc. MITSUBISHICHEMICALCORPORATION RICOH Co., Ltd. Hitachi Maxell Ltd.
--------------	--

CD-RW:	MITSUBISHI CHEMICAL CORPORATION RICOH Co., Ltd.
---------------	--

TOSHIBA has confirmed the operation of CD-R and CD-RW media of the manufacturers above. Operation of other media cannot be guaranteed.

- CD-RW can generally be rewritten about 1,000 times. However, the actual number of rewrites is affected by the quality of the media and the way it is used.
- Be sure to connect the AC adaptor when you write or rewrite.
- Be sure to close all other software programs except the writing software.
- Do not run software such as a screen saver which can put a heavy load on the CPU.
- Operate the computer at full power. Do not use power-saving features.
- Do not write while virus check software is running. Wait for it to finish, then disable virus detection programs including any software that checks files automatically in the background
- Do not use hard disk utilities, including those intended to enhance HDD access speed. They may cause unstable operation and damage data.
- Write from the computer's HDD to the CD. Do not try to write from shared devices such as a LAN server or any other network device.

- Writing with software other than *Drag'n Drop CD+DVD* has not been confirmed. Therefore, operation with other software cannot be guaranteed.

When writing or rewriting

Note the following when you write or rewrite a CD-R or CD-RW.

- Always copy data from the HDD to the CD. Do not use cut-and-paste. The original data will be lost if there is a write error.
- Do not perform any of the following actions:
 - Operate the computer for any other function, including use of a mouse or AccuPoint II, closing/opening the LCD panel.
 - Start a communication application such as a modem.
 - Apply impact or vibration to the PC.
 - Install, remove or connect external devices, including the following: PC card, USB devices, external display, i.LINK devices, optical digital devices.
 - Use the CD/MP3 control buttons to reproduce music and voice.
 - Open the optical media drive.
- If the media is poor in quality, dirty or damaged, writing or rewriting errors may occur.
- Set the computer on a level surface and avoid places subject to vibration such as airplanes trains, or cars. Do not use an unstable surface such as a stand.
- Keep mobile phones and other wireless communication devices away from the computer.

Writing CD/DVDs on DVD Multi drive

You can use the DVD Multi drive to write data to either CD-R/-RW or DVD-R/-RW/-RAM discs.

Important message

Before you write or rewrite to CD-R/-RW or DVD-R/-RW/-RAM disc, read and follow all set-up and operating instructions in this section. If you fail to do so, the DVD Multi drive may not function properly, and you may fail to write or rewrite, lose data or incur other damage.

Disclaimer

TOSHIBA does not bear responsibility for the following:

- Damage to any CD-R/-RW or DVD-R/-RW/-RAM disc that may be caused by writing or rewriting with this product.
- Any change or loss of the recorded contents of CD-R/-RW or DVD-R/-RW/-RAM disc that may be caused by writing or rewriting with this product, or for any business profit loss or business interruption that may be caused by the change or loss of the recorded contents.
- Damage that may be caused by using third party equipment or software.

Given the technological limitations of current optical disc writing drives, you may experience unexpected writing or rewriting errors due to disc quality or problems with hardware devices. Also, it is a good idea to make two or more copies of important data, in case of undesired change or loss of the recorded contents.

Read/write function chart

Disc type	CD-R	CD-RW	DVD-R	DVD-RW	DVD-RAM	DVD+R	DVD+RW
Read	Yes	Yes	Yes	Yes	Yes	No	No
Write	Yes	Yes	Yes	Yes	Yes	No	No
Drag'n Drop CD+DVD ^{*1}	Yes	Yes	Yes	Yes	No	No	No

^{*1} Software supplied with the product can be used for writing to a disc.

- Based on TOSHIBA's limited compatibility testing, we suggest the following manufacturers of CD-R/-RW and DVD-R/-RW/-RAM disc. However, in no event does TOSHIBA guarantee the operation, quality or performance of any disc. Disc quality can affect write or rewrite success rates.

CD-R:	TAIYOYUDEN CO., LTD. Mitsui Chemicals Inc. MITSUBISHI CHEMICAL CORPORATION RICOH Co., Ltd. Hitachi Maxell Ltd.
CD-RW:	MITSUBISHI CHEMICAL CORPORATION RICOH Co., Ltd.
DVD-R:	DVD Specifications for Recordable Disc for General Version 2.0 TAIYOYUDEN CO., LTD. PIONEER VIDEO CORPORATION MITSUBISHI CHEMICAL CORPORATION
DVD-RW:	DVD Specifications for Re-recordable Disc for Version 1.1 VICTOR COMPANY OF JAPAN.LIMITED TDK Corporation
DVD-RAM:	DVD Specifications for DVD-RAM Disc for Version 2.0 or Version 2.1 Matsushita Electric Industrial Co., Ltd.

- If the disc is poor in quality, dirty or damaged, writing or rewriting errors may occur. Be careful to check the disc for dirt or damage before you use it.
- The actual number of rewrites to CD-RW or DVD-RW/-RAM is affected by the quality of the disc and the way it is used.
- There are two types of DVD discs: authoring and general use discs. Do not use authoring discs. Only general use discs can be written to by a computer drive.
- You can use DVD-RAM discs that can be removed from a cartridge and DVD-RAM discs designed without a cartridge. You cannot use a disc with a 2.6 GH single-sided capacity or 5.2 GB double-sided capacity.
- Other DVD-ROM drives for computers or other DVD players may not be able to read DVD-R/-RW discs.
- You cannot partially delete any data written to a DVD-RW disc.
- Data written to a CD-R/DVD-R disc cannot be deleted either in whole or in part.
- Data deleted (Erase) from a CD-RW and DVD-RW/-RAM disc cannot be recovered. Check the content of the disc carefully before you delete it. If multiple drives that can be written to are connected, be careful not to delete data from the wrong drive.

- In writing to a DVD-R/-RW disc, some disc space is required for file management, so you may not be able to write the full capacity of the disc.
- Since the disc is based on the DVD standard, it will be filled with dummy data if the written data is less than about 1 GB. Even if you write only a small amount of data, it might take time to fill in the dummy data.
- DVD-RAM formatted by FAT32 cannot be read in Windows 2000 without DVD-RAM Driver Software.

Before writing or rewriting

Please observe the following points when you write or rewrite data.

- When multiple drives that can be written are connected, be careful not to write to the wrong drive.
- Be sure to connect the AC adaptor before you write or rewrite.
- Before you enter standby/hibernation mode, be sure to finish DVD-RAM writing. Writing is finished if you can eject DVD-RAM media.
- Be sure to close all other software programs except the writing software.
- Do not run software such as a screen saver, which can put a heavy load on the CPU.
- Operate the computer in the full-power mode. Do not use power-saving features.
- Do not write while virus check software is running. Wait for it to finish, then disable virus detection programs including any software that checks files automatically in the background.
- Do not use hard disk utilities, including those intended to enhance HDD access speed. They may cause unstable operation and data damage.
- Write from the computer's HDD to the CD/DVD. Do not try to write from shared devices such as a LAN server or any other network device.
- Writing with software other than Drag'n Drop CD+DVD is not recommended.

When writing or rewriting

Please observe/consider the following when you write or rewrite to a CD-R/-RW or DVD-R/-RW/-RAM disc.

- Do not perform any of the following actions when writing or rewriting:
 - Operate the computer for any other function, including using a mouse or AccuPoint II or closing/opening the LCD panel.
 - Start a communication application such as a modem.
 - Apply impact or vibration to the computer.

- Install, remove or connect external devices, including the following: PC card, USB devices, external display, i.LINK devices, optical digital devices.
- Use the Audio/Video control button to reproduce music or voice.
- Open the DVD Multi drive
- Do not use standby/hibernation while you write or rewrite.
- Make sure writing or rewriting is completed before going into standby/hibernation. Writing is completed if you can open the DVD Multi drive tray.
- Set the computer on a level surface and avoid places subject to vibration such as airplanes, trains, or cars. Do not use an unstable surface such as a stand.
- Keep mobile phones and other wireless communication devices away from the computer.
- Always copy data from the HDD to the DVD-RAM. Do not use cut-and-paste. The original data will be lost if there is a write error.

Drag'n Drop CD+DVD

Note the following limitations when you use Drag'n Drop CD+DVD:

- DVD-Video cannot be created using Drag'n Drop CD+DVD.
- DVD-Audio cannot be created using Drag'n Drop CD+DVD.
- You cannot use Drag'n Drop CD+DVD's music CD function to record music to a DVD-R/-RW disc.
- Do not use the DISC Backup function of Drag'n Drop CD+DVD to copy DVDVideo and DVD-ROM with copyright protection, because the copy will not play correctly.
- DVD-RAM disc cannot be backed up with the DISC Backup function of Drag'n Drop CD+DVD.
- You cannot backup a CD-ROM or CD-R/-RW to DVD-R/-RW using the DISC Backup function of Drag'n Drop CD+DVD.
- You cannot back up DVD-ROM, DVD-Video or DVD-R/-RW to CD-R/-RW using the DISC Backup function of Drag'n Drop CD+DVD.
- Drag'n Drop CD+DVD cannot record in packet format.
- You might not be able to use the DISC backup function of Drag'n Drop CD+DVD to back up a DVD-R/-RW disc that was made with other software on a different DVD-R/-RW recorder.

Data Verification

To verify that data is written or rewritten correctly, follow the steps below before you write or rewrite a Data CD/DVD.

1. Right-click **Data BOX** and select **Options** to display the **DATA DISC Option** window.
2. Mark the **Record and Verify** check box and select **Byte compare**.
3. Click the **OK** button.

The “Record and Verify” function automatically checks whether data has been correctly recorded onto a CD/DVD. “Byte compare” compares the original data file with the data recorded on the CD/DVD and checks that the data completely matches.

Media care

This section provides tips on protecting data stored on your CD/DVDs and diskettes.

Handle your media with care. The following simple precautions will increase the lifetime of your media and protect the data stored on them:

CD/DVDs

1. Store your CD/DVDs in the container they came in to protect them and keep them clean.
2. Do not bend the CD/DVD.
3. Do not write on, apply a sticker to, or otherwise mar the surface of the CD/DVD that contains data.
4. Hold the CD/DVD by its outside edge or the edge on the center hole. Fingerprints on the surface can prevent the drive from properly reading data.
5. Do not expose to direct sunlight, extreme heat or cold. Do not place heavy objects on your CD/DVDs.
6. If your CD/DVDs become dusty or dirty, wipe them with a clean dry cloth. Wipe from the center out, do not wipe in a circular direction around the CD/DVD. If necessary, use a cloth dampened in water or a neutral cleaner. Do not use benzine, thinner or similar cleaner.

Diskettes

1. Store your diskettes in the container they came in to protect them and keep them clean. If a diskette is dirty, do not use cleaning fluid. Clean it with a soft damp cloth.
2. Do not slide back the diskette’s protective metal covering or touch the diskette’s magnetic surface. Fingerprints may prevent the diskette drive from reading data from the diskette.
3. Data may be lost if the diskette is twisted; bent; or exposed to direct sunlight, extreme heat or cold.
4. Do not place heavy objects on your diskettes.
5. Do not eat, smoke, or use erasers near your diskettes. Foreign particles inside the diskette’s jacket can damage the magnetic surface.
6. Magnetic energy can destroy the data on your diskettes. Keep your diskettes away from speakers, radios, television sets and other sources of magnetic fields.

Modem

This section describes how to connect and disconnect the internal modem to and from a telephone jack.



The internal modem does not support voice functions. All data and fax functions are supported.



1. In case of a lightning storm, unplug the modem cable from the telephone jack.
2. Do not connect the modem to a digital telephone line. A digital line will damage the modem.

Region selection

Telecommunication regulations vary from one region to another, so you will need to make sure the internal modem's settings are correct for the region in which it will be used.

To select a region, follow the steps below.

1. In Windows XP, click **start**, point to **All Programs**, point to **TOSHIBA Internal Modem** and click **Region Select Utility**.



Do not use the Country/Region Select function in the Modem setup utility in the Control Panel if the function is available. If you change the Country/Region in the Control Panel, the change may not take effect.

2. The Region Selection icon will appear in the Windows Task Bar.



The Region Selection icon (Windows XP)

3. Click the icon with the primary mouse button to display a list of regions that the modem supports. A sub menu for telephony location information will also be displayed. A check will appear next to the currently selected region and telephony location.
4. Select a region from the region menu or a telephony location from the submenu.
 - When you click a region it becomes the modem's region selection, and the New Location for telephony will be set automatically.
 - When you select a telephony location, the corresponding region is automatically selected and it becomes the modem's current region setting.

Properties menu

Click the icon with the secondary mouse button to display the following menu.

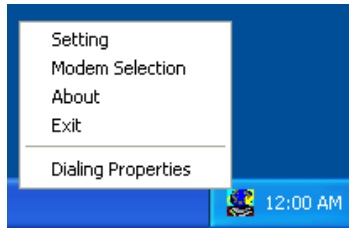

The menu list (Windows XP)

Setting

You can enable or disable the following settings:

AutoRun Mode

The Region Select utility starts automatically when you start up the operating system.

Open the Dialing Properties dialog box after selecting region.

The dialing properties dialog box will be displayed automatically after you select the region.

Location list for region selection.

A submenu appears displaying location information for telephony.

Open dialog box, if the modem and Telephony Current Location region code do not match.

A warning dialog box is displayed if current settings for region code and telephony location are incorrect.

Modem Selection

If the computer cannot recognize the internal modem, a dialog box is displayed. Select the COM port for your modem to use.

Dialing Properties

Select this item to display the dialing properties.



If you are using the computer in Japan, the Telecommunications Business Law requires that you select Japan region mode. It is illegal to use the modem in Japan with any other selection.

Connecting

To connect the internal modem cable, follow the steps below.

1. Plug one end of the modular cable into the modem jack.
2. Plug the other end of the modular cable into a telephone jack.

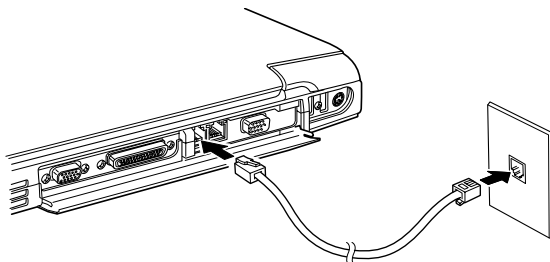

Connecting the internal modem



Do not pull on the cable or move the computer while the cable is connected



If you use a storage device such as a DVD-ROM drive, CD-RW/DVD-ROM drive or HDD connected to a 16-bit PC card, you might experience the following modem problems:

1. *Modem speed is slow or communication is interrupted.*
2. *Skips may occur in sound.*

Disconnecting

To disconnect the internal modem cable, follow the steps below.

1. Pinch the lever on the connector in the telephone jack and pull out the connector.
2. Disconnect the cable from the computer in the same manner.

Wireless LAN

The Wireless LAN is compatible with other LAN systems based on Direct Sequence Spread Spectrum radio technology that complies with IEEE 802.11 Wireless LAN standard (Revision A or B) and Turbo Mode. It supports the following features:

- Automatic Transmit Rate Select mechanism in the transmit range of 54, 48, 36, 24, 18, 12, 9 and 6 Mbit/s. (Revision A)
- Automatic Transmit Rate Select mechanism in the transmit range of 11, 5.5, 2 and 1 Mbit/s. (Revision B)
- Automatic Transmit Rate Select mechanism in the transmit range of 108, 96, 72, 48, 36, 24, 18 and 12 Mbit/s. (Turbo Mode)
- Frequency Channel Selection (Revision A/Turbo Mode: 5 GHz, Revision B: 2.4 GHz)
- Roaming over multiple channels
- Card Power Management
- Wired Equivalent Privacy (WEP) data encryption, based on the 152 bit RC4 encryption algorithm.
- Advanced Encryption Standard (AES) data encryption, based on the 256 bit encryption algorithm.

Wake-up on LAN does not function on a Wireless LAN.

Radio links

You can easily establish links between two or more devices. The link is maintained even if the devices are not within line of sight.

Security

Two advanced security mechanisms ensure a high level of security:

1. Authentication prevents access to critical data and makes it impossible to falsify the origin of a message.
2. Encryption prevents eavesdropping and maintains link privacy.

Wireless communication switch

You can enable or disable Wireless LAN functions, with the on/off switch. No transmissions are sent or received when the switch is off. Slide the switch toward the left of the computer to turn it on and toward the right of the computer to turn it off.



Set the switch to off in airplanes and hospitals. Check the indicator. It will stop glowing when the wireless communication function is off.

Wireless communication Indicator

The wireless communication indicator indicates the status of the wireless communication functions.

Indicator status	Indication
Indicator off	Wireless communication switch is set to off. Automatic power down because of overheating. Power malfunction
Indicator glows	Wireless communication switch is on. Wireless LAN is turned on by an application.

If you used the Task Bar to disable W-LAN, restart the computer or follow the procedures below to enable the system to recognize W-LAN. Open or click the following: **start, Control Panel, System, Hardware, Device Manager, Network adapters, TOSHIBA Wireless LAN Mini PCI Card** and **enable**.

LAN

The computer has built-in support for Ethernet LAN (10 megabits per second, 10BASE-T) and Fast Ethernet LAN (100 megabits per second, 100BASE-Tx).

This section describes how to connect/disconnect to a LAN.



Do not install or remove an optional memory module while Wake-up on LAN is enabled.



The Wake-up on LAN function consumes power even when the system is off. Leave the AC adaptor connected while using this feature.

Connecting a LAN cable



The computer must be configured properly before connecting to a LAN. Logging onto a LAN using the computer's default settings could cause a malfunction in LAN operation. Check with your LAN administrator regarding set-up procedures.

If you are using Fast Ethernet LAN (100 megabits per second, 100BASE-TX), be sure to connect with a category 5 cable, CAT5, or higher.

If you are using Ethernet LAN (10 megabits per second, 10BASE-T), connect with a category 3 cable, CAT3, or higher.

To connect the LAN cable, follow the steps below.

1. Turn off the power to the computer and to all external devices connected to the computer.

2. Plug one end of the cable into the LAN jack. Press gently until you hear the latch click into place.

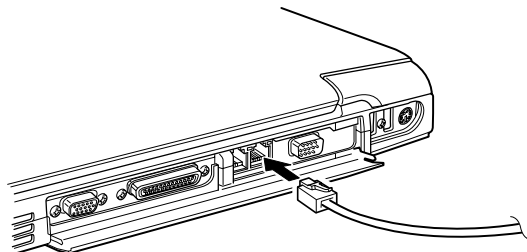

Connecting the LAN cable

3. Plug the other end of the cable into a LAN hub connector. Check with your LAN administrator before connecting to a hub.



*When the computer is exchanging data with the LAN, the **LAN active** indicator glows orange. When the computer is connected to a LAN hub but is not exchanging data, the **Link** indicator glows green.*

Disconnecting a LAN cable

To disconnect the LAN cable, follow the steps below.



*Make sure the **LAN active** indicator (orange LED) is out before you disconnect the computer from the LAN.*

1. Pinch the lever on the connector in the computer's LAN jack and pull out the connector.
2. Disconnect the cable from the LAN hub in the same manner. Check with your LAN administrator before disconnecting from the hub.

Cleaning the computer

To help ensure long, trouble-free operation, keep the computer free of dust and use care with liquids around the computer.

- Be careful not to spill liquids into the computer. If the computer does get wet, turn the power off immediately and let the computer dry completely before you turn it on again.
- Clean the computer using a slightly damp (with water) cloth. You can use glass cleaner on the display. Spray a small amount of cleaner on a soft, clean cloth and wipe the screen gently with the cloth.



Never spray cleaner directly onto the computer or let liquid run into any part of it. Never use harsh or caustic chemical products to clean the computer.

Moving the computer

The computer is designed for rugged durability. However, a few simple precautions taken when moving the computer will help ensure trouble-free operation.

- Make sure all disk activity has ended before moving the computer. Check the **Disk** and **Slim Select Bay** indicators on the computer.
- If a CD/DVD is in the drive, remove it. Also make sure the drawer is securely closed.
- Turn off the power to the computer.
- Disconnect the AC adaptor and all peripherals before moving the computer.
- Close the display. Do not pick up the computer by its display panel.
- Close all port covers.
- Use the carrying case when transporting the computer.

Heat dispersal

To protect from overheating, the CPU has an internal temperature sensor. If the computer's internal temperature rises to a certain level, the cooling fan is turned on or the processing speed is lowered. You can select whether to control the CPU temperature by turning on the fan first, then if necessary, lowering the CPU speed. Or, by lowering the CPU speed first, then if necessary, turning on the fan. Use the *Cooling Method* item of the *Power Save Mode* window in TOSHIBA Power Saver.

Maximum Performance Turn on the fan first, then if necessary, lower the CPU processing speed.

Performance Use a combination of the fan and lowering the CPU processing speed.

Battery optimized Lower the CPU processing speed first, then if necessary turn on the fan.

When the CPU temperature falls to a normal range, the fan is turned off and the CPU operation returns to standard speed.



If the CPU temperature reaches an unacceptably high level with either setting, the system automatically shuts down to prevent damage. Data in memory will be lost.

The Keyboard

The computer's keyboard layouts are compatible with a 101/102-key enhanced keyboard. By pressing some keys in combination, all the 101/102-key keyboard functions can be executed on the computer.

The number of keys on your keyboard depends on which country/region's keyboard layout your computer is configured with. Keyboards for numerous languages are available.

There are five types of keys: typewriter keys, keypad overlay, function keys, soft keys and cursor control keys.

Typewriter keys

The typewriter keys, produce the upper- and lowercase letters, numbers, punctuation marks, and special symbols that appear on the screen.

There are some differences, however, between using a typewriter and using a computer keyboard:

- Letters and numbers produced in computer text vary in width. Spaces, which are created by a "space character," may also vary depending on line justification and other factors.
- The lowercase l (el) and the number 1 (one) are not interchangeable on computers as they are on a typewriter.
- The uppercase O (oh) and the 0 (zero) are not interchangeable.
- The **Caps Lock** function key locks only the alphabetic characters in uppercase while the shift lock on a typewriter places all keys in the shifted position.
- The **Shift** keys, the **Tab** key, and the **Bk Sp** (backspace) key perform the same function as their typewriter counterparts but also have special computer functions.

F1 ... F12 function keys

The function keys, not to be confused with **Fn**, are the 12 keys at the top of your keyboard. These keys are dark gray, but function differently from the other dark gray keys.



F1 through **F12** are called function keys because they execute programmed functions when pressed. Used in combination with the **Fn** key, keys marked with icons execute specific functions on the computer. See the section, *Soft keys: Fn key combinations*, in this chapter. The function executed by individual keys depends on the software you are using.

Soft keys: Fn key combinations

The **Fn** (function) is unique to Toshiba computers and is used in combination with other keys to form soft keys. Soft keys are key combinations that enable, disable or configure specific features.



Some software may disable or interfere with soft-key operations. Soft-key settings are not restored by the Resume feature.

Emulating keys on enhanced keyboard

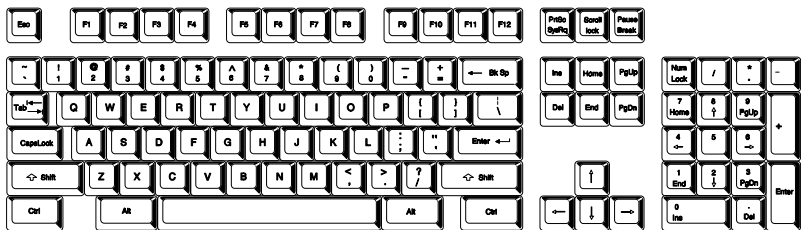

A 101-key enhanced keyboard layout

The keyboard is designed to provide all the features of the 101-key enhanced keyboard, shown in the figure above. The 101/102-key enhanced keyboard has a numeric keypad and scroll lock key. It also has additional **Enter**, **Ctrl** and **Alt** keys to the right of the main keyboard. Since the keyboard is smaller and has fewer keys, some of the enhanced keyboard functions must be simulated using two keys instead of one on the larger keyboard.

Your software may require you to use keys that the keyboard does not have. Pressing the **Fn** key and one of the following keys simulates the enhanced keyboard's functions.



Press **Fn + F10** or **Fn + F11** to access the integrated keypad. When activated, the keys with white markings on the bottom edge become numeric keypad keys (**Fn + F11**) or cursor control keys (**Fn + F10**). Refer to the Keypad overlay section in this chapter for more information on how to operate these keys. The power on default for both settings is off.



Press **Fn + F12 (ScrLock)** to lock the cursor on a specific line. The power on default is off.



Press **Fn + Enter** to simulate **Enter** on the enhanced keyboard's numeric keypad.



Press **Fn + Ctrl** to simulate the enhanced keyboard's right **Ctrl** key.



Press **Fn + Alt** to simulate the enhanced keyboard's right **Alt** key.

Hotkeys

Hotkeys (**Fn** + a function or Esc key) let you enable or disable certain features of the computers.



Sound mute: Pressing **Fn + Esc** in a Windows environment turns sound on or off. When you press these hotkeys, the current setting will be displayed as an icon.



Instant security: Press **Fn + F1** to lock the keyboard and blank the screen to prevent others from accessing your data. To restore the screen and original settings, press any key or move the AccuPoint II. When a dialog box appears, enter the screensaver password and click **OK**. If no password is set, the screen will be restored when you press any key.



Power save mode: Pressing **Fn + F2** changes the power save mode. If you press **Fn + F2**, the Power Save Mode is displayed in a dialog box. Continue holding down **Fn** and press **F2** again to change the setting. You can also change this setting through the *Plugged in or Running on batteries* item of the *Power Saver Properties* window in *Power Saver*.



Standby: When you press **Fn + F3**, the computer can enter Standby. To avoid entering Standby unexpectedly, a dialog box appears for verification. However, if you check the checkbox in the dialog box, it will not appear from the next time.



Hibernation: When you press **Fn + F4**, the computer can enter Hibernation. To avoid entering Hibernation unexpectedly, a dialog box appears for verification. However, if you check the checkbox in the dialog box, it will not appear from the next time.



Display selection: Press **Fn + F5** to change the active display device. When you press these hot keys a dialog box appears. Only selectable devices will be displayed. Hold down **Fn** and press **F5** again to change the device. When you release **Fn** and **F5**, the selected device will change. If you hold down the keys for three seconds the selection will return to **LCD**.



Display Brightness: Pressing **Fn + F6** decreases the display brightness in increments. When you press these hotkeys, the current setting will be displayed for two seconds by an icon. You can also change this setting through the *Monitor brightness* item of the *Power Save Mode* window in Power Saver.

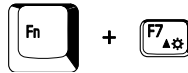

Display Brightness: Pressing **Fn + F7** increases the display brightness in increments. When you press these hotkeys, the current setting will be displayed for two seconds by a pop-up icon. You can also change this setting through the *Monitor brightness* item of the *Power Save Mode* window in Power Saver.



You cannot change the display brightness for about 18 seconds after the LCD turns on. To protect display quality, the brightness level is set at the maximum value.

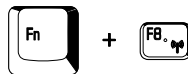

Wireless setting: Non functioning key combination.

Emulating Fn key on external keyboard

The **Fn** key is only on Toshiba keyboards. If you use an external keyboard attached to the computer, you can execute **Fn** key combinations by emulating the **Fn** key. See Chapter 7, *HW Setup and Passwords*, for details on setting the **Fn** key equivalent.

Fn Sticky key

You can use the Toshiba Accessibility Utility to make the **Fn** key sticky, that is, you can press it once, release it, and they press an **“F number”** key.

Windows special keys

The keyboard provides two keys that have special functions in Windows : one activates the **Start** menu and the other has the same function as the secondary mouse button.



This key activates the Windows **Start** menu.



This key has the same function as the secondary mouse button.

Keypad overlay

Your computer's keyboard does not have an independent numeric keypad, but its numeric keypad overlay functions like one.

The keys in the center of the keyboard with white letters make up the numeric keypad overlay. The overlay provides the same functions as the numeric keypad on the 101/102-key enhanced keyboard in the next figure.

Turning on the overlays

The numeric keypad overlay can be used for numeric data input or cursor and page control.

Arrow mode

To turn on the Arrow mode, press **Fn + F10**. The Arrow mode indicator lights. Now try cursor and page control using the keys shown in next figure. Press **Fn + F10** again to turn off the overlay.

Numeric mode

To turn on the Numeric mode, press **Fn + F11**. The Numeric mode indicator lights. Now try numeric data entry using the keys in the next figure. Press **Fn + F11** again to turn off the overlay.

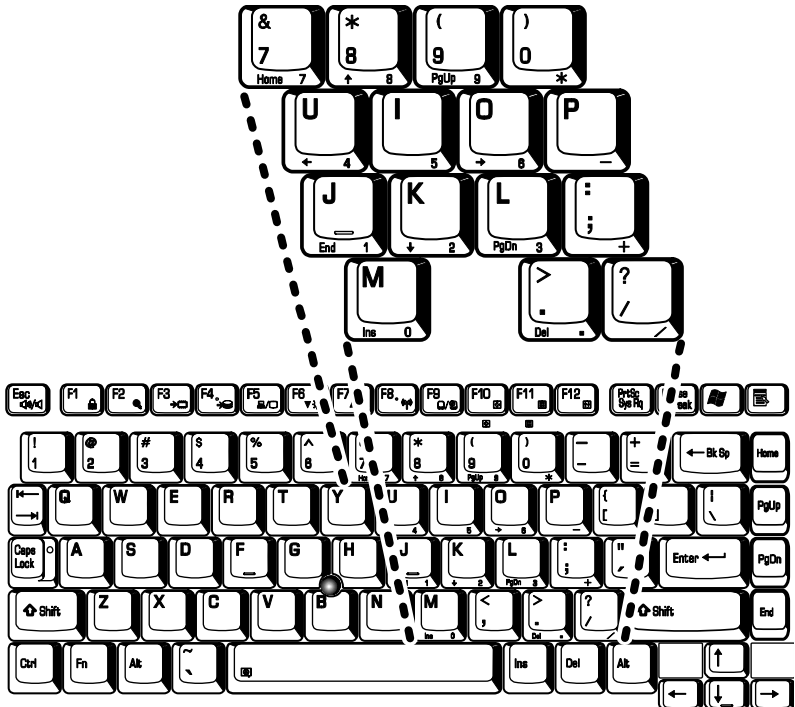

The numeric keypad overlay

Temporarily using normal keyboard (overlay on)

While using the overlay, you can temporarily access the normal keyboard without turning off the overlay:

1. Hold **Fn** and press any other key. All keys will operate as if the overlay were off.
2. Type uppercase characters by holding **Fn + Shift** and pressing a character key.
3. Release **Fn** to continue using the overlay.

Temporarily using overlay (overlay off)

While using the normal keyboard, you can temporarily use the keypad overlay without turning it on:

1. Press and hold down **Fn**.
2. Check the keyboard indicators. Pressing **Fn** turns on the most recently used overlay. If the Numeric mode indicator lights, you can use the overlay for numeric entry. If the Arrow mode indicator lights, you can use the overlay for cursor and page control.
3. Release **Fn** to return to normal keyboard operation.

Temporarily changing modes

If the computer is in **Numeric mode**, you can switch temporarily to **Arrow mode** by pressing a shift key.

If the computer is in **Arrow mode**, you can switch temporarily to **Numeric mode** by pressing a shift key.

Generating ASCII characters

Not all ASCII characters can be generated using normal keyboard operation. But, you can generate these characters using their ASCII codes.

With the overlay on:

1. Hold down **Alt**.
2. Using the overlay keys, type the ASCII code.
3. Release **Alt**, and the ASCII character appears on the display screen.

With the overlay off:

1. Hold **Alt + Fn**.
2. Using the overlay keys, type the ASCII code.
3. Release **Alt + Fn**, and the ASCII character appears on the display screen.

Power and Power-Up Modes

The computer's power resources include the AC adaptor and internal batteries. This chapter gives details on making the most effective use of these resources including charging and changing batteries, tips for saving battery power, and power up modes.

Power conditions

The computer's operating capability and battery charge status are affected by the power conditions: whether an AC adaptor is connected, whether a battery is installed and what the charge level is for the battery.

		Power on	Power off (no operation)
AC adaptor connected	Main battery fully charged	<ul style="list-style-type: none"> Operates No charge LED: Main Battery green DC IN green 	<ul style="list-style-type: none"> No charge LED: Main Battery green DC IN green
	Main battery partially charged or no charge	<ul style="list-style-type: none"> Operates Charge*¹ LED: Main Battery orange DC IN green 	<ul style="list-style-type: none"> Quick charge*¹ LED: Main Battery orange DC IN green
	No main battery installed	<ul style="list-style-type: none"> Operates No charge LED: Main Battery off DC IN green 	<ul style="list-style-type: none"> No charge LED: Main Battery off DC IN green

		Power on	Power off (no operation)
AC adaptor connected	2nd battery fully charged	<ul style="list-style-type: none"> Operates No charge LED: 2nd battery green DC IN green 	<ul style="list-style-type: none"> No charge LED: 2nd battery green DC IN green
	2nd battery partially charged or no charge	<ul style="list-style-type: none"> Operates Charge*² LED: 2nd battery orange DC IN green 	<ul style="list-style-type: none"> Quick charge*² LED: 2nd battery orange DC IN green
	No 2nd battery installed	<ul style="list-style-type: none"> Operates No charge LED: 2nd battery off DC IN green 	<ul style="list-style-type: none"> No charge LED: 2nd battery off DC IN green
AC adaptor not connected	Main battery charge is above low battery trigger point	<ul style="list-style-type: none"> Operates LED: Main Battery off DC IN off 	–
	Main battery charge is below low battery trigger point	<ul style="list-style-type: none"> Operates LED: Main Battery flashes orange DC IN off 	–
	Main battery charge is exhausted	Computer shuts down* ³	–
	No main battery installed	<ul style="list-style-type: none"> No operation*⁴ LED: Main Battery off DC IN off 	–
AC adaptor not connected	2nd battery charge is above low battery trigger point	<ul style="list-style-type: none"> Operates LED: 2nd battery off DC IN off 	–
	2nd battery charge is below low battery trigger point	<ul style="list-style-type: none"> Operates LED: 2nd battery flash orange DC IN off 	–
	2nd battery charge is exhausted	Computer shuts down* ³	–
	No 2nd battery is installed	<ul style="list-style-type: none"> No operation*⁵ LED: 2nd battery off DC IN off 	–



2nd battery indicator refers to the **Slim Select Bay indicator** when a secondary battery is installed.

*¹ When the secondary battery is not charging.

*² When the main battery is not charging

- *3 For the computer to shut down in hibernation mode, the hibernation feature must be enabled in two places in TOSHIBA Power Saver: the Hibernate window and the Battery Alarm item of the Alarm window. If a main battery and a secondary battery are installed, the computer does not shut down until the charge in both batteries is exhausted.
- *4 When no secondary battery is installed
- *5 When no main battery is installed



When batteries are charged, the main battery is charged first. When it is fully charged, the secondary battery is charged.

Power indicators

The **Main battery**, **Slim Select Bay**, **DC IN** and **Power** indicators on the system indicator panel alert you to the computer's operating capability and battery charge status.

Battery indicators

Check the **Main battery** indicator to determine the status of the main battery and the **Slim Select Bay** indicator to determine the status of the secondary battery. The following indicator lights indicate the battery status:

Flashing orange	The battery charge is low. The AC adaptor must be connected to recharge the battery.
Orange	Indicates the AC adaptor is connected and charging the battery.
Green	Indicates the AC adaptor is connected and the battery is fully charged.
No light	Under any other conditions, the indicator does not light.



If the battery becomes too hot while it is being charged, the charge will stop and the battery indicator will go out. When the battery's temperature falls to a normal range, charge will resume. This event occurs regardless of whether the power to the computer is on or off.

DC IN indicator

Check the **DC IN** indicator to determine the power status with the AC adaptor connected:

Green	Indicates the AC adaptor is connected and supplying proper power to the computer.
Flashing orange	Indicates a problem with the power supply. Plug the AC adaptor into another outlet. If it still does not operate properly, see your dealer.
No light	Under any other conditions, the indicator does not light.

Power indicator

Check the **Power** indicator to determine the power status.

Green	Indicates power is being supplied to the computer and the computer is turned on.
Blinking orange	Indicates the power was turned off while the computer was in Resume mode. The indicator turns on for one second and turns off for two seconds.
No light	Under any other conditions, the indicator does not light.

Battery types

The computer has three types of batteries:

- Battery packs — main and secondary (option)
- Real Time Clock (RTC) battery

Main battery

When the AC power cord is not connected, the computer's main power source is a removable lithium ion battery pack, also referred to in this manual as the main battery. You can purchase additional battery packs for extended use of the computer away from an AC power source.



The battery pack is a lithium ion battery, which can explode if not properly replaced, used, handled or disposed of. Dispose of the battery as required by local ordinances or regulations. Use only batteries recommended by TOSHIBA as replacements.

The main battery recharges the RTC batteries. The main battery maintains the state of the computer when you enable Resume.



When the computer is powered off in Resume mode, and the AC adaptor is not connected, the main battery pack and optional secondary battery pack supply power to maintain data and programs in memory. If the battery pack(s) is completely discharged, Resume does not function and the computer loses all data in memory.

The following message appears when you turn on the power:

**WARNING: RESUME FAILURE.
PRESS ANY KEY TO CONTINUE.**

To ensure that the battery pack maintains its maximum capacity, operate the computer on battery power at least once a month until the battery pack is fully discharged. Refer to Extending battery life in this chapter for procedures. If the computer is continuously operated on AC power, either through an AC adaptor or a docking station for an extended period, more than a month, the battery may fail to retain a charge. It may not function efficiently over the expected life of the battery and the Battery LED may not indicate a low-battery condition.

Secondary battery (option)

An optional secondary battery can be installed in the Slim Select Bay to increase your battery operating time. Note the caution on Resume mode in the previous section Main battery.



The secondary battery pack is a lithium ion battery, which can explode if not properly replaced, used, handled or disposed of. Dispose of the battery as required by local ordinances or regulations. Use only batteries recommended by TOSHIBA as replacements.

Real time clock battery

The Real Time Clock (RTC) battery provides power for the internal real time clock and calendar. It also maintains the system configuration.

If the RTC battery becomes completely discharged, the system loses this data and the real time clock and calendar stop working. The following message appears when you turn on the power:

Check system. Then press [F1] key



The computer's RTC battery is a lithium ion battery and should be replaced only by your dealer or by a TOSHIBA service representative. The battery can explode if not properly replaced, used, handled or disposed of. Dispose of the battery as required by local ordinances or regulations.

Care and use of the battery pack

The battery pack is a vital component of portable computing. Taking proper care of it will help ensure longer operating time on battery power as well as a longer life for your battery pack. Follow the instructions in this section carefully to ensure safe operation and maximum performance.

Safety precautions

Mishandling of batteries can cause death, serious injury or property damage. Carefully observe the following advisories :

Danger: Indicates an imminently hazardous situation, which could result in death or serious injury, if you do not follow instructions.

Warning: Indicates a potentially hazardous situation, which could result in death or serious injury, if you do not follow instructions.

Caution: Indicates a potentially hazardous situation, which if not avoided, may result in moderate or minor injury or property damage.

Note: Provides important information.

Danger

1. Never try to dispose of the battery pack by burning or expose it to a heating device such as a microwave oven. The battery pack could explode and cause bodily injury.
2. Never try to disassemble, repair or otherwise tamper with a battery pack. The battery pack will overheat and ignite. Leakage of caustic alkaline solution or other electrolytic substances will cause fire or injury, possibly resulting in death or serious injury.
3. Never short-circuit the battery pack by contacting the terminals with a metal object. A short-circuit can cause fire or otherwise damage the battery pack and possibly cause injury. To avoid accidental short-circuit, always wrap the battery pack in plastic and cover the terminals with electrical tape when storing or disposing of the battery pack.
4. Never puncture the battery pack with a nail or other sharp object. Never strike it with a hammer or other object. Never step on it.
5. Never try to change the battery pack in any manner other than that described in user's manual. Never connect the battery pack to a plug socket or to a automobile's cigarette lighter socket. It may rupture or ignite.

6. Use only the battery pack supplied with the computer or other device or an battery pack approved by the computer or device's manufacturer. Battery packs have different voltages and terminal polarities. Use of an improper battery could cause smoke, fire or rupture of the battery pack.
7. Never subject a battery pack to heat, such as storage near a heat source. Exposure to heat can cause the battery pack to ignite, explode or leak caustic liquid and cause death or serious injury. It could also fail or malfunction causing data loss.
8. Never expose the battery pack to abnormal shock, vibration or pressure. The battery pack's internal protective device will fail, causing it to overheat, explode, ignite or leak caustic liquids possibly resulting in death or serious injury.
9. Never let a battery pack become wet. A wet battery pack will overheat, ignite or rupture possibly resulting in death or serious injury.

Warning

1. Never allow caustic electrolyte fluid leaked from a battery pack to contact your eyes, skin or clothing. If caustic electrolyte fluid should contact your eyes, immediately wash your eyes with large amounts of running water and seek medical attention, to help prevent eye damage. If electrolyte fluid should contact your skin immediately wash it under running water to prevent rash. If it contacts your clothes, promptly remove them to prevent the fluid from contacting your skin or eyes.
2. Immediately turn off the power, disconnect the AC adaptor and remove the battery if any of the following events are observed in the battery pack: offensive or unusual odor, excessive heat, discoloration or deformation. Never use the computer again until it has been checked by a TOSHIBA service provider. It might generate smoke or fire, or the battery pack might rupture.
3. Make sure the battery is securely installed in the computer before attempting to charge the battery pack. Improper installation could generate smoke or fire, or cause the battery pack to rupture.
4. Keep the battery pack out of reach of infants and children. It can cause injury.

Caution

1. Never continue to use a battery pack after its recharging capacity has become impaired, or after the display of a warning message indicating that the battery pack's power is exhausted. Continued use of an exhausted or impaired battery pack could cause the loss of data.

2. Never dispose of battery packs with normal trash. Bring them to your TOSHIBA dealer or to another recycling center to save resources and prevent environmental damage. Cover the terminals with electrical tape to prevent short-circuits, which could cause the battery pack to ignite or rupture.
3. Use only battery packs recommended by TOSHIBA as replacements.
4. Always make sure the battery pack is installed correctly and securely. Otherwise, a battery pack could fall out and possibly cause injury.
5. Change the battery pack only in an ambient temperature between 5 and 35 degrees Celsius. Otherwise, the electrolyte solution might leak, battery pack performance might deteriorate and the battery life might be shortened.
6. Be sure to monitor the remaining battery power. If the battery pack and real time clock battery discharge completely. Standby and Suspend will not function and data in memory will be lost. Also, the computer might register an incorrect time and date. In this case, connect the AC adaptor to recharge the batteries.
7. Never install or remove the battery pack without first turning off the power and disconnecting the AC adaptor. Never remove the battery pack while the computer is in Suspend or Standby mode. Data will be lost.

Note

1. Never remove the battery pack while the Wake-up on LAN function is enabled. Data will be lost. Before you remove a battery pack, disable the Wake-up on LAN function.
2. To ensure the battery pack maintains maximum capacity, operate the computer on battery power once a week until the battery pack is fully discharged. Refer to the section Extending battery life in this chapter for procedures. If the computer is continuously operated on AC power for an extended period, more than a week, the battery might fail to retain a charge. It might not function efficiently over the expected life of the battery pack and **Battery** indicator might not indicate a low-battery condition.
3. After the battery pack is charged, avoid leaving the AC adaptor connected and the computer turned off for more than a few hours at a time. Continuing to charge a fully-charged battery pack can damage the battery.

Charging the batteries

When the power in the battery pack becomes low, the **Battery** indicator flashes orange indicating that only a few minutes of battery power remain. If you continue to use the computer while the **Battery** indicator flashes, the computer enables Hibernation mode (so you don't lose data) and automatically turns off.



The computer enters Hibernate mode only if Hibernation is enabled in two places in TOSHIBA Power Saver : the Hibernate window and the battery Alarm item of the Alarm window.

You must recharge a battery pack when it becomes discharged.

Procedures

To recharge a battery pack while it is installed in the computer, connect the AC adaptor to the **DC IN** socket and plug the other end into a working outlet.

The **Battery** indicator glows orange when the battery is being charged.



Use only the computer connected to an AC power source or the optional TOSHIBA Battery charger to charge the battery pack. Do not attempt to charge the battery pack with any other charger.

Time

The following table shows the approximate time required to fully charge a discharged battery.

Charging time (hours)

Battery type	Power on	Power off
Main battery pack	about 3 or longer	about 3
Secondary battery pack	about 3 or longer	about 3
RTC battery	about 8	Doesn't charge



The charging time when the computer is on is affected by ambient temperature, the temperature of the computer and how you use the computer. If you make heavy use of external devices, for example, the battery might scarcely charge at all during operation. Refer also to the section Maximizing battery operating time.

Battery charging notice

The battery may not charge right away under the following conditions:

- The battery is extremely hot or cold. If the battery is extremely hot, it might not charge at all. Also, to ensure the battery charges to its full capacity, charge the battery at room temperature of 10– to 30–C (50– to 88–F).
- The battery is nearly completely discharged. Leave the AC adaptor connected for a few minutes and the battery should begin charging.

The **Battery** indicator may show a rapid decrease in battery operating time when you try to charge a battery under the following conditions:

- The battery has not been used for a long time.

- The battery has completely discharged and been left in the computer for a long time.
- A cool battery is installed in a warm computer.

In such case, follow the steps below.

1. Fully discharge the battery by leaving it in the computer with the power on until the power automatically shuts off.
2. Plug in the AC adaptor.
3. Charge the battery until the **Battery** indicator glows green.

Repeat the steps two or three times until the battery recovers normal capacity.



Leaving the AC adaptor connected will shorten battery life. At least once a month, run the computer on battery power until the battery is fully discharged, then recharged the battery.

Monitoring battery capacity

Remaining battery power can be monitored in the Power Save Modes window in Power Saver of Windows.



1. *Wait at least 16 seconds after turning on the computer before trying to monitor the remaining operating time. The computer needs this time to check the battery's remaining capacity and to calculate the remaining operating time, based on the current power consumption rate and remaining battery capacity. The actual remaining operating time may differ slightly from the calculated time.*
2. *With repeated discharges and recharges, the battery's capacity will gradually decrease. Therefore, an often used, older battery will not operate for as long as a new battery even when both are fully charged. In this case, Power Saver Utility will indicate a 100% charge for both the old and new battery, but the displayed estimated time remaining will be shorter for the older battery.*

Maximizing battery operating time

A battery's usefulness depends on how long it can supply power on a single charge.

How long the charge lasts in a battery depends on:

- How you configure the computer, for example, whether you enable battery-power saving options. The computer provides a battery save mode to conserve battery power. This mode has the following options:
 - Processing speed
 - Monitor brightness
 - System standby
 - System Hibernate
 - Turn off monitor

- Turn off hard disks
- How often and how long you use the hard disk, CD/DVD-ROM drive and the diskette drive.
- How much charge the battery contained to begin with.
- How you use optional devices, such as a PC card, to which the battery supplies power.
- Enabling Resume mode conserves battery power if you are frequently turning the computer off and on.
- Where you store your programs and data.
- Closing the display when you are not using the keyboard saves power.
- Operating time decreases at low temperatures.
- The condition of the battery terminals. Make sure the battery terminals stay clean by wiping them with a clean dry cloth before installing the battery pack.

Retaining data with power off

When you turn off your computer with fully charged batteries, the batteries retain data for the following approximate time periods:

Battery pack (6cell)	3 days (Resume mode)
	34 days (Boot mode)
RTC battery	1 month

Extending battery life

To maximize the life of your battery pack:

- At least once a month, disconnect the computer from a power source and operate it on battery power until the battery pack fully discharges. Before doing so, follow the steps below.
 1. Turn off the computer's power.
 2. Disconnect the AC adaptor and turn on the computer's power. If it does not turn on go to step 4.
 3. Operate the computer on battery power for five minutes. If the battery pack has at least five minutes of operating time, continue operating until the battery pack is fully discharged. If the battery LED flashes or there is some other warning to indicate a low battery, go to step 4.
 4. Connect the AC adaptor to the computer and the power cord to a power outlet. The DC IN LED should glow green, and the Battery LED should glow orange to indicate that the battery pack is being charged. If the DC IN indicator does not glow, power is not being supplied. Check the connections for the AC adaptor and power cord.
 5. Charge the battery pack until the Battery LED glows green.

- If you have extra battery packs, rotate their use.
- If you will not be using the system for an extended period, more than one month, remove the battery pack.
- Disconnect the AC adaptor when the battery is fully charged. Overcharging makes the battery hot and shortens life.
- If you are not going to use the computer for more than eight hours, disconnect the AC adaptor.
- Store spare battery packs in a cool dry place out of direct sunlight.

Replacing the battery pack

When the battery pack reaches the end of its operating life you will need to install a new one. The life of the battery pack is generally about 500 recharges. If the **Battery** indicator flashes orange shortly after fully recharging the battery, the battery pack needs to be replaced.

You might also replace a discharged battery pack with a charged spare when you are operating your computer away from an AC power source. This section explains how to remove and install battery packs. For the detail about removing/installing the Slim Select Bay 2nd battery pack, refer to Chapter 8, *Optional Devices*.

Removing the battery pack

To replace a discharged battery pack, follow the steps below.



1. *When handling battery packs, be careful not to short circuit the terminals. Also do not drop, hit or otherwise apply impact; do not scratch or break the casing and do not twist or bend the battery pack.*
2. *Do not remove the battery pack while the computer is in Standby mood. Data is stored in RAM, so if the computer loses power it will be lost.*
3. *In Hibernation mode, data will be lost if you remove the battery or disconnect the AC adaptor before the save is completed. Wait for the **Fixed HDD/ODD** indicator to go out.*

1. Save your work.
2. Turn the computer's power off. Make sure the **Power** indicator is off.
3. Remove all cables connected to the computer.
4. Turn the computer upside down with the back of the computer facing you.
5. Slide the battery release latch to free the battery pack for removal, then lift up the battery pack.
6. Pull the battery pack forward to remove it.



For environmental reasons, do not throw away a spent battery pack. Please return spent battery packs to your TOSHIBA dealer.

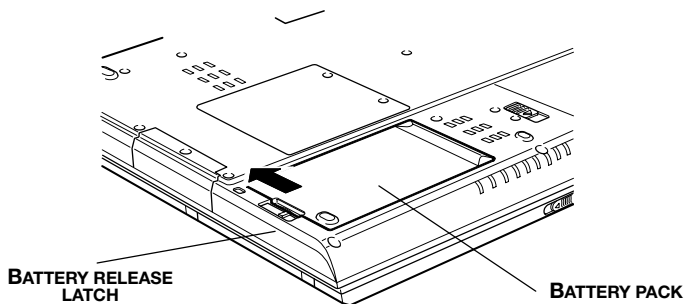

Removing the battery pack

Installing the battery pack

To install a battery pack, follow the steps below.



The battery pack is a lithium ion battery, which can explode if not properly replaced, used, handled or disposed of. Dispose of the battery as required by local ordinances or regulations. Use only batteries recommended by TOSHIBA as replacements.

1. Be sure the computer's power is off and all cables are disconnected.
2. Insert the battery pack.

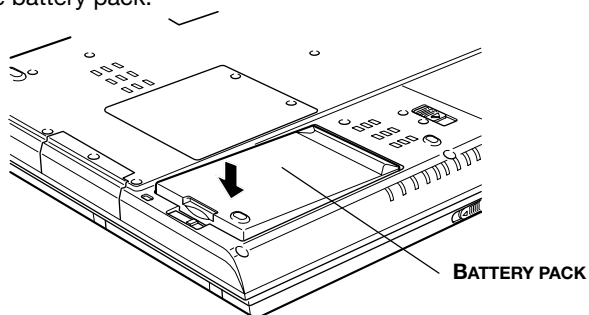

Installing the battery pack

3. Push down the battery pack until it is firmly seated.

Starting the computer by password

If you registered a password as supervisor or user, you must enter it to start the computer. For more information about how to set a password, refer to Chapter 7, *HW Setup and Passwords*.

To start up the computer with the password, follow these steps:

1. Turn on the power as described in Chapter 3, *Getting Started* and the following message appears:

Password =

2. Enter the password.
3. Press **Enter**. The computer displays the message below while it starts up.

Valid password entered, system is now starting up.



If you enter the password incorrectly three times in a row, the computer shuts off. In this case, you must turn the computer back on to retry password entry.

Power-up modes

The computer has the following power-up modes:

- **Boot** : Computer shuts down without saving data. Always save your work before you turn the computer off in boot mode.
- **Hibernation** : Data in memory is saved to the hard disk.
- **Standby** : Data is maintained in the computer's main memory.



*Refer also to the sections [Turning on the power](#) and [Turning off the power](#) in Chapter 3, *Getting Started*.*

Windows utilities

You can specify the setting in TOSHIBA Power Saver.

Hotkeys

You can use hotkeys **Fn + F3** to enter Standby mode and **Fn + F4** to enter Hibernation. See Chapter 5, *The Keyboard*, for details.

Panel power off

You can set up your computer so that power turns off automatically when you close the display panel. When you open the panel, power turns on in Standby or Hibernation mode but not in boot mode.



If the panel power off function is enabled and use [Shut down Windows](#), do not close the display until the shut down function is completed.

System Auto Off

This feature turns the system off automatically if it is not used for a set duration. The system shuts down in Standby mode or Hibernation mode in windows.

HW Setup and Passwords

This chapter explains how to use the TOSHIBA HW Setup program to configure your computer and how to set passwords.

HW Setup

TOSHIBA HW Setup lets you configure settings for pointing devices, display, CPU, boot priority, keyboard, USB, LAN, general, password, device config and parallel/printer.



If the supervisor password is set, access to the TOSHIBA HW Setup program can be prevented when the user password is used to log on to the computer.

Accessing HW Setup

Click **start**, click **Control Panel**, click **Printers and Other Hardware**, and select **TOSHIBA HW Setup** to run HW Setup.

HW Setup window

The HW Setup window contains the following tabs: Pointing Devices, Display, CPU, Boot Priority, Keyboard, USB, LAN, General, Password, Device Config and Parallel/Printer.

There are also three buttons: **OK**, **Cancel** and **Apply**.

OK	Accepts your changes and closes the HW Setup window.
Cancel	Closes the window without accepting your changes.
Apply	Accepts all your changes without closing the HW Setup window.

General

This window displays the BIOS version and contains two buttons: **Default** and **About**.

Default	Return all HW Setup values to the factory settings.
About	Display the HW Setup version.

Setup

This field displays BIOS **Version** and date.

Password

User Password

This option allows you to set or reset the user password for power on.

Not Registered	Change or remove the password. (Default)
Registered	Set the password. A dialogue box will appear to let you set the password.

To enter a user password:

1. Select **Registered** to display the following prompt:
Enter Password:
2. Enter a password of up to 10 characters. The character string you enter is displayed as a string of asterisks. For example, if you enter a password consisting of four characters, the display is shown as:
Enter Password: ****



*If you click the **OK** button before entering the password, **Not registered** will appear on the display.*

3. Click the **OK** button. The following message appears, allowing you to verify the password.
Verify Password:
4. If character strings match, the password is registered click **OK** button.
If they do not match, the following message appears. You must repeat from step 1.
Entry Error!!!

To delete a user password:

1. Select **Not Registered** to display the following prompt:
Enter Password:

2. Enter the currently registered password. The character string you enter is displayed as a string of asterisks.

Enter Password: ****



*If you click the **OK** button before entering the password, **Registered** will appear on the display.*

3. Click the **OK** button. If the character string you enter matches the registered password, the password option is reset and the display changes to:

Not registered

If they do not match, the following message appears. You must repeat step 1.

Incorrect Password!!!



If you enter the password incorrectly three times in a row, the computer needs to shut down.

You will not be able to access the password option in HW Setup. In this case you must turn the power off and back on to retry the procedure.

4. Follow the same procedures described earlier in this section to set a new user password.

Device Config

Device Configuration

This option lets you set the device configuration.

All Devices	BIOS sets all devices.
Setup by OS	Operating system sets devices that it can control.

Parallel/Printer

This tab lets you set the Printer Port Type. Use the Windows Device Manager to make settings for the Parallel port.

Parallel Port Mode

The options in this tab are **ECP** and **Standard Bi-directional**.

ECP	Sets the port type to Extended Capabilities Port (ECP). For most printers, the port should be set to ECP . (Default)
Standard Bi-directional	This setting should be used with some other parallel devices.

Pointing Devices

Pointing Devices

This tab lets you select **Auto-Selected** and **Simultaneous**.

Auto-Selected	If a PS/2 mouse is connected to the computer when you turn on the power, the PS/2 mouse is enabled and the AccuPoint II is disabled. Otherwise, the AccuPoint II is enabled. (Default)
Simultaneous	Enables both the AccuPoint II and a PS/2 mouse.

Display

This tab lets you customize your computer's display settings for either the internal LCD screen or for an external monitor.

Power On Display

Lets you set the display to be used when the computer is booted.

Auto-Selected	Selects an external monitor if one is connected. Otherwise, it selects the internal LCD. (Default)
LCD+AnalogRGB	Selects both the internal LCD and external monitor for simultaneous display.

CPU

Dynamic CPU Frequency Mode

This option lets you choose from the following settings:

Dynamically Switchable	CPU power consumption and clock speed automatic switching function is enabled. When the computer is in use, CPU operation is automatically switched when necessary. (Default)
Always High	CPU power consumption and clock speed automatic switching function is disabled. The CPU always runs at its fastest speed.
Always Low	CPU power consumption and clock speed automatic switching function is disabled. The CPU always runs at low power consumption and low speed.

Boot Priority

Boot Priority Options

This option sets the priority for booting the computer. Select from the following settings:

HDD → FDD → CD -ROM(-> LAN)	The computer looks for bootable files in the following order: HDD, diskette drive, CD-ROM* and LAN. (default)
FDD → HDD → CD -ROM(-> LAN)	The computer looks for bootable files in the following order: diskette drive, HDD, CD-ROM* and LAN.
HDD → CD-ROM (-> LAN)-> FDD	The computer looks for bootable files in the following order: HDD, CD-ROM*, LAN and diskette drive.
FDD → CD-ROM (-> LAN)-> HDD	The computer looks for bootable files in the following order: diskette drive, CD-ROM*, LAN and HDD.
CD-ROM(-> LAN) -> HDD → FDD	The computer looks for bootable files in the following order: CD-ROM*, LAN, HDD, diskette drive.
CD-ROM(-> LAN) -> FDD → HDD	The computer looks for bootable files in the following order: CD-ROM*, LAN, diskette drive and HDD.

You can override the settings and manually select a boot device by pressing one of the following keys while the computer is booting:

- U** Selects the USB diskette drive.
- N** Selects the Network.
- 1** Selects the primary HDD.
- 2** Selects the secondary HDD.
- C** Selects the CD-ROM*.

This procedure does not affect the settings.

* In this computer, CD refers to the DVD-ROM, CD-RW/DVD-ROM drives, or DVD Multi drives.

To change the boot drive, follow the steps below.

1. Hold down **F12** and boot the computer.
2. The following menu will be displayed with the following icons:
Built-in HDD, Select Bay HDD, CD-ROM, FDD, Network (LAN).



A bar will appear only under the selected device.

- Use the left/right cursor keys to highlight boot device you want and press **Enter**.



- If a supervisor password is set, the menu above does not appear when you use the user password to start the computer.
- The selection method above does not change the boot priority settings in HW Setup.
- If you press a key other than one of those above or if the selected device is not installed, the system will boot according to the current setting in HW Setup.

HDD Priority Options

This option lets you set the boot priority for the HDD if more than one is installed in the computer. If the first detected HDD has a boot command, the system will boot from the HDD.

Built-in HDD -> Second HDD	The built-in HDD is checked first for the boot command, then the HDD installed in the Slim Select Bay. (Default)
--	--

Second HDD -> Built-in HDD	The HDD installed in the Slim Select Bay is checked first for the boot command, then the built-in HDD.
--	--

Keyboard

External Keyboard Fn key

Use this option to set a key combination on an external keyboard to emulate the **Fn** key on the computer's internal keyboard. Setting an **Fn** key equivalent will let you use "Hotkeys" by pressing the set combination instead of the **Fn** key. (PS/2 keyboard only)

Disabled	No Fn key equivalent (Default)		
Fn Equivalent	Left Ctrl	+	Left Alt
	Right Ctrl	+	Right Alt
	Left Alt	+	Left Shift
	Right Alt	+	Right Shift
	Left Alt	+	Caps Lock



If you select **Left Ctrl + Left Alt** or **Right Ctrl + Right Alt** for this option, you cannot use the selected keys to reboot the computer in combination with the **Del** key. For example, if you select **Left Ctrl + Left Alt**, you must use **Right Ctrl, Right Alt** and **Del** to reboot the computer. **Left Ctrl, Left Alt** and **Del** cannot be used.

Wake-up on Keyboard

When this feature is enabled and the computer is in standby mode, you can turn on the computer by pressing any key. It is effective only for the internal keyboard and only when the computer is in standby mode.

Enabled	Enables Wake-up on Keyboard.
Disabled	Disables Wake-up on Keyboard. (Default)

USB

USB KB/Mouse Legacy Emulation

Use this option to enable or disable USB KB/Mouse Legacy Emulation. If your operating system does not support USB, you can still use a USB mouse and keyboard by setting the **USB KB/Mouse Legacy Emulation** item to **Enabled**.

Enabled	Enables the USB KB/Mouse Legacy Emulation. (Default)
Disabled	Disables the USB KB/Mouse Legacy Emulation.

USB-FDD Legacy Emulation

Use this option to enable or disable USB-FDD Legacy Emulation.

Enabled	Enables the USB-FDD Legacy Emulation. (Default)
Disabled	Disables the USB-FDD Legacy Emulation.

LAN

Wake-up on LAN

This feature lets the computer's power be turned on when it receives a wake-up signal from the LAN.

Enabled	Enables Wake-up on LAN.
Disabled	Disables Wake-up on LAN. (Default)



Do not install or remove an optional memory module while Wake-up on LAN is enabled.



Wake-up on LAN does not work without the AC adaptor. Leave it connected, if you are using this feature.

Built-in LAN

Enabled	Enables built-in LAN functions. (Default)
Disabled	Disables built-in LAN functions.

Optional Devices

Optional devices can expand the computer's capabilities and its versatility. The following optional devices are available from your TOSHIBA dealer:

Cards/memory

- PC cards
- Memory expansion

Power devices

- Additional battery pack
- Slim Select Bay 2nd battery pack
- Additional AC adaptor

Peripheral devices

- Slim Select Bay HDD adaptor
- USB FDD Kit
- Advanced Port Replicator II
- Parallel printer
- External monitor
- Television
- PS/2 mouse
- PS/2 keyboard

Other

- Security lock

PC cards

The computer is equipped with a PC card expansion slot that can accommodate two 5 mm Type II cards or one 10.5 mm Type III card. Any PC card that meets industry standards (manufactured by TOSHIBA or other vendor) can be installed. The slots support 16-bit PC cards, including PC card 16's multifunction card and CardBus PC cards.

CardBus supports the new standard of 32-bit PC cards. The bus provides superior performance for the greater demands of multimedia data transmission.

Installing a PC card

Two PC card connectors are located one above the other on the left side of the computer. Both connectors are accessed from the same slot. You can install two Type II cards, one in each connector, or one Type III card in the bottom connector.

Windows' hot-install feature lets you install PC cards while the computer's power is on.



1. *Do not install a PC card while the computer is in standby or hibernation mode. Some cards might not work properly.*
2. *An HDD or CD-ROM connected to a 16-bit PC card, might affect the performance of the computer's sound system and data transmission, including slower transmission speeds and dialing errors.*

To install a PC card, follow the steps below.

1. Insert the PC card.
2. Press gently to ensure a firm connection.

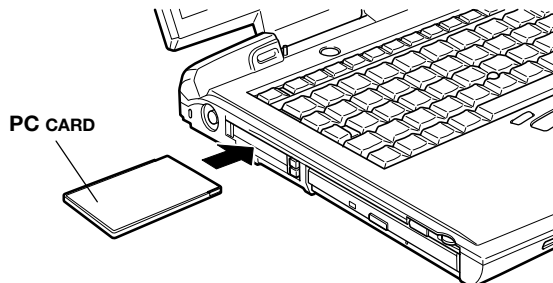

Inserting the PC card

3. Check the configuration in the HW Setup window to make sure it is appropriate for your card.

Removing a PC card

To remove the PC card, follow the steps below.

1. Open the **Safety Remove Hardware** icon on the system tray and disable the PC card.
2. Press the eject button of the PC card you want to remove to extend the button.
3. Press the extended eject button to pop the card out slightly.
4. Grasp the PC card and remove it.

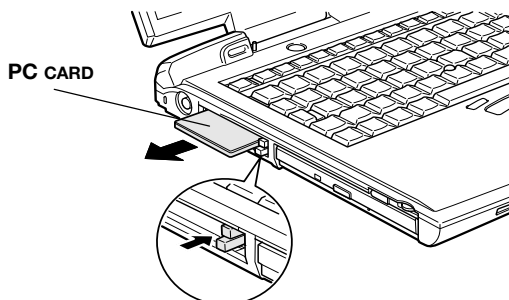

Removing the PC card

Memory expansion

You can install additional memory in the computer's memory module to increase the amount of RAM.



Only memory modules with the following parts numbers can be installed:

■ PA3127U-1M25	256 MB
■ PA3164U-1M51	512MB
■ PA3278U-1M1G	1024MB

Installing memory module

To install a memory module, make sure the computer is in boot mode then:

1. Turn the computer off in boot mode. Refer to the *Turning off the power* section in Chapter 3.



1. If you use the computer for a long time, the memory modules will become hot. In this case, let the memory modules cool to room temperature before you replace them.
2. Do not try to install a memory module with the computer turned on or turned off in Standby and Hibernation mode. You can damage the computer and the memory module.
3. If you install a memory module that is not compatible with the computer, a beep will sound when you turn on the power. If the module is installed in slot A, there will be a long beep followed by a short beep. If the module is in slot B, there will be a long beep followed by two short beeps. In this case shut down the power and remove the incompatible module.

2. Remove all cables connected to the computer.
3. Turn the computer upside down and remove the battery pack (refer to Chapter 6, *Power and Power-Up Modes.*)
4. Remove one screw securing the memory module cover.
5. Lift off the cover.



Use a point size 0 Phillips screwdriver.

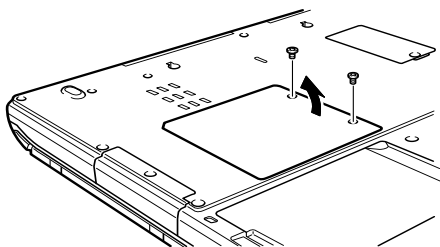

Removing the cover

6. Insert the memory module into the connector on the computer. Press the module carefully and firmly to ensure a solid connection.
7. Push the module down so that it lies flat and is secured by two latches.



Do not touch the connectors on the memory module or on the computer. Debris on the connectors may cause memory access problems.

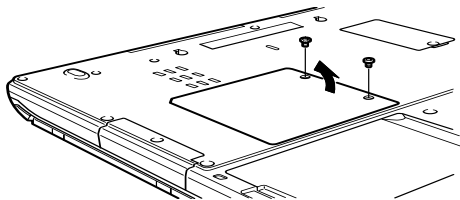

Inserting the memory module

8. Seat the cover and secure it with one screw.
9. When you turn the computer on, it should automatically recognize the total memory capacity. Use the HW Setup program to verify that the added memory is recognized. If it is not recognized, check the module's connection.

Removing memory module

To remove the memory module, make sure the computer is in boot mode then:

1. Turn the computer off and remove all cables connected to the computer.



1. *If you use the computer for a long time, the memory modules will become hot. In this case, let the memory modules cool to room temperature before you replace them.*
2. *Do not try to remove a memory module with the computer turned on or turned off in Standby and Hibernation mode. You can damage the computer and the memory module.*

2. Turn the computer upside down and remove the battery pack (refer to Chapter 6, *Power and Power-Up Modes*.)
3. Remove one screw securing the memory module cover.
4. Lift off the cover.
5. Use a slender object such as a pen to press two latches on either side of the memory module to the outside. The memory module will pop up.
6. Grasp the memory module by the sides and pull it out.



Do not touch the connectors on the memory module or on the computer. Debris on the connectors may cause memory access problems.

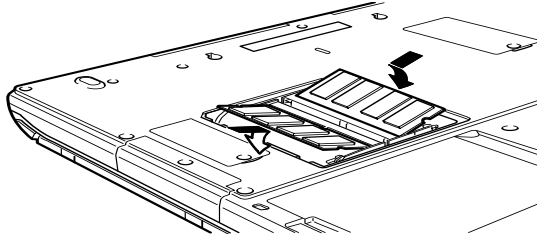

Removing the memory module

7. Seat the cover and secure it with one screw.

Additional battery pack

You can increase the portability of the computer with additional battery packs (PA3286*). If you're away from an AC power source, you can replace a low battery with a fully charged one. See Chapter 6, *Power and Power-Up Modes*.

Slim Select Bay 2nd battery pack

You can install a secondary battery pack (PA3249*) in the computer's Slim Select Bay. For details on installing modules in the Slim Select Bay, refer to Chapter 4, *Operating Basics*.

Additional AC adaptor

If you frequently transport the computer between different sites such as your home and office, purchasing an AC adaptor for each location will reduce the weight and bulk of your carrying load: PA3083*.

Slim Select Bay HDD adaptor

A integrated 2 1/2" HDD is available for installation in the Slim Select Bay.

To install an HDD in the Slim Select Bay HDD adaptor (PA3134U-1ETC) follow the steps below.

1. Slide the lock to the unlock position and open the lid.

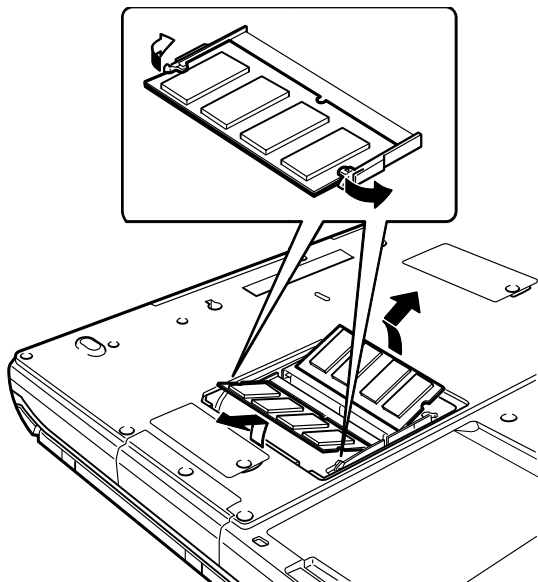

Opening the lid

2. Insert the HDD and push forward to ensure a firm connection.

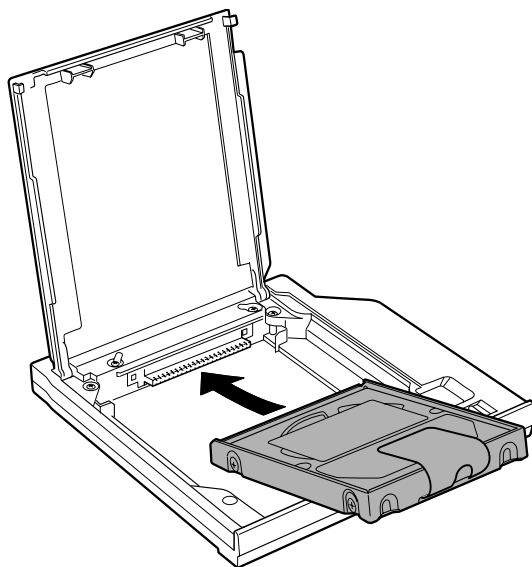

Installing the HDD

3. Close the lid and slide the lock to the lock position.

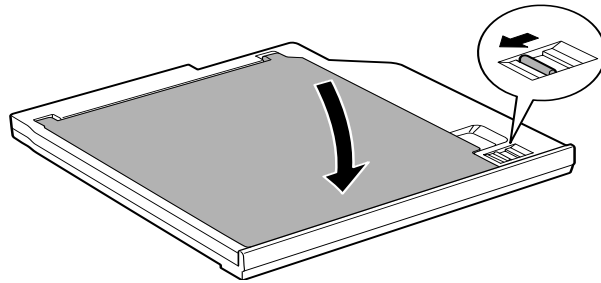

Closing the lid

For details on installing the Slim Select Bay HDD adaptor in the Slim Select Bay, refer to Chapter 4, *Operating Basics*.

USB FDD Kit

The 3 1/2" external FDD drive module can be connected to the USB port. For details on connecting the 3 1/2" external diskette drive module, refer to Chapter 4, *Operating Basics*.

Advanced Port Replicator II

In addition to the ports available on the computer, the Advanced Port Replicator II provides audio line-out jack, line-in jack and separate ports for PS/2 mouse and PS/2 keyboard. The Advanced Port Replicator II connects directly to the docking interface on the bottom of the computer. The AC adaptor connects the Advanced Port Replicator II to a power source.



The computer must be configured properly before connecting to a LAN. Logging onto a LAN using the computer's default settings could cause a malfunction in LAN operation. Check with your LAN administrator regarding set-up procedures.

The following ports and accessories are available on the Advanced Port Replicator II.

- One RJ45 LAN jack
- One RJ11 Modem jack
- External monitor port
- Parallel port
- Serial port
- PS/2 mouse port
- PS/2 keyboard port
- DC IN socket

- Security lock slot
- Audio line-in, line-out jacks
- Universal Serial Bus (two) ports
- i.LINK (IEEE 1394) port (This port is not supported by the computer.)
- DVI port (This port is not supported by the computer.)



1. *When a Port Replicator is connected to the computer, remove all cables connected to the computer.*
2. *The TE2300 does not support the DVI and i.LINK ports on the Advanced Port Replicator II.*

Parallel printer

You can connect any standard Centronics-compatible parallel printer to your computer. All you need is an IBM PC™ parallel printer cable. Your dealer can supply one or you can purchase one at most computer stores.

The cable's connectors are designed so that it is impossible for you to connect them incorrectly. You can also connect a parallel printer to an optional Advanced Port Replicator. To connect a printer, follow these steps:

1. Turn off the computer.
2. Insert one end of the cable into the computer's parallel port.
3. Tighten the screws that fasten the cable connector to the computer's parallel port.
4. Insert the other end of the cable into the printer's parallel connector.
5. Fasten the connector to the printer with the clips on the parallel port.
6. Turn on the printer.
7. Turn on the computer.
8. Start the Hardware Setup program. Refer to Chapter 7 *HW Setup and Passwords*.
9. Select the **Parallel/Printer** tab from the **TOSHIBA HW Setup** window.
10. Set the **Parallel Port Mode** and press **OK**.
11. Choose **Reboot** for the change to take effect.
12. Select the printer in Windows Add Print Wizard. To access the **Add Print Wizard** utility, click **Start**, point to **Settings**, click **Printers** and double click the **Add Printer** icon.

External monitor

An external analog monitor can be connected to the external monitor port on the computer, Port Replicator. The computer supports VGA and Super VGA video modes. To connect a monitor, follow the steps below.



If an external monitor is connected to the computer, do not connect the Port Replicator. First disconnect the external monitor from the computer then connect the Port Replicator and use its external monitor port.



The Resume feature can be used with an external monitor. Simply enable Resume and the computer will maintain the data as it is displayed on the external monitor.

1. Connect the monitor to the external monitor port.
2. Turn the monitor's power on.

When you turn on the power, the computer automatically recognizes the monitor and determines whether it is color or monochrome.

You can use the HW Setup to select between **Auto-Selected** and **Simultaneous** displays. Refer to Chapter 7, *HW Setup and Passwords*.

If you have selected **Simultaneous** under the **Display** options of the HW Setup, both the external monitor and the internal LCD will be active when you turn on the computer. If **Auto-Selected** is selected, only the external monitor will be active.

To change the display settings, press **Fn + F5**. If you disconnect the monitor before you turn the computer off, be sure to press **Fn + F5** to switch to the internal display. Refer to Chapter 5, *The Keyboard*, for details on using hotkeys to change the display setting.



*If you set **Simultaneous** for the computer's display, you must set the computer's display resolution to the same as that of the external monitor or other device, such as a projector.*

Television

A television can be connected to the video out port on the computer. To connect a television, follow the steps below.

1. Turn the computer off.
2. Use a video cable (not supplied) to connect the television to the video out port.

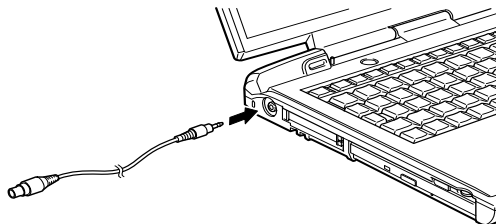

Connecting a television

3. Turn the television on.
4. Turn the computer on.

PS/2 mouse

Use the PS/2 keyboard/mouse port on the computer or optional Advanced Port Replicator to connect a PS/2 mouse.

Make sure the mouse has a cable with a 6-pin connector for the PS/2 mouse port. If the mouse's cable is not compatible, see your dealer for an adaptor cable.



1. *How the computer treats the connection to a PS/2 mouse depends on the setting for **Pointing Devices** under the HW Setup program. If **Simultaneous** is selected, you can operate both the AccuPoint II and the PS/2 mouse. If **Auto-Selected** is chosen, the AccuPoint II is disabled when a PS/2 mouse is connected.*
2. *If you connect a PS/2 mouse to the computer while it is in Standby mode, you will not be able to use the mouse when you turn the computer on.*

To connect a PS/2 mouse:

1. Turn the computer off.
2. Connect the PS/2 mouse to the PS/2 keyboard/mouse port on the computer or the mouse port on the optional Advanced Port Replicator, pressing gently to assure a firm connection.
3. Turn on the computer.

To disconnect the mouse, turn off the computer and pull out the mouse connector.

Consult your mouse manual for instructions on how to install necessary software.

PS/2 keyboard

Use the PS/2 keyboard/mouse port on the computer or optional Advanced Port Replicator to connect a PS/2 keyboard. When an external keyboard is connected, you can use both the external keyboard and the computer's internal keyboard. To connect a PS/2 keyboard:



If you connect a PS/2 keyboard to the computer while it is in Standby mode, you will not be able to use the keyboard when you turn the computer on.

1. Turn the computer off.
2. Plug the PS/2 keyboard connector into the PS/2 keyboard/mouse port on the computer or the keyboard port on the optional Advanced Port Replicator, pressing gently to assure a firm connection.
3. Turn on the computer.

To disconnect the keyboard, turn off the computer and pull out the keyboard connector.

Security lock

A security lock enables you to anchor your computer to a desk or other heavy object to help prevent unauthorized removal of the computer.

Attach one end of a cable to the desk and the other end to the security lock slot on the left side of the computer.

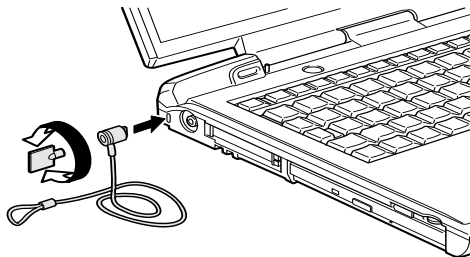

Security lock

Troubleshooting

TOSHIBA designed the computer for durability. However, should problems occur, following the procedures in this chapter can help to determine the cause.

All readers should become familiar with this chapter. Knowing what might go wrong can help prevent problems from occurring.

Problem solving process

Resolving problems will be much easier if you observe the following guidelines:

- Stop immediately when you recognize a problem exists. Further action may result in data loss or damage. You may destroy valuable problem-related information that can help solve the problem.
- Observe what is happening. Write down what the system is doing and what actions you performed immediately before the problem occurred. If you have a printer attached, print a copy of the screen using **PrtSc**.

The questions and procedures offered in this chapter are meant as a guide, they are not definitive problem solving techniques. Many problems can be solved simply, but a few may require help from your dealer. If you find you need to consult your dealer or others, be prepared to describe the problem in as much detail as possible.

Preliminary checklist

Consider the simplest solution first. The items in this checklist are easy to fix and yet can cause what appears to be a serious problem.

- Make sure you turn on all peripheral devices before you turn on the computer. This includes your printer and any other external device you are using.
- Before you attach an external device, turn the computer off. When you turn the computer back on it recognizes the new device.

- Make sure all options are set properly in the setup program.
- Check all cables. Are they correctly and firmly attached? Loose cables can cause signal errors.
- Inspect all connecting cables for loose wires and all connectors for loose pins.
- Check that your diskette is correctly inserted and that the diskette's write protect tab is correctly set.

Make notes of your observations and keep them in a permanent error log. This will help you describe your problems to your dealer. If a problem recurs, the log will help you identify the problem faster.

Analyzing the problem

Sometimes the system gives clues that can help you identify why it is malfunctioning. Keep the following questions in mind:

- Which part of the system is not operating properly: keyboard, diskette drives, hard disk drive, printer, display. Each device produces different symptoms.
- Is the operating system configuration set properly? Check the configuration options.
- What appears on the display screen? Does it display any messages or random characters? Print a copy of the screen if you have a printer attached. Look up the messages in the software and operating system documentation. Check that all connecting cables are correctly and firmly attached. Loose cables can cause erroneous or intermittent signals.
- Do any icons light? Which ones? What color are they? Do they stay on or blink? Write down what you see.
- Do you hear any beeps? How many? Are they long or short? Are they high pitched or low? Is the computer making any unusual noises? Write down what you hear.

Record your observations so you can describe them to your dealer.

Software

The problems may be caused by your software or diskette. If you cannot load a software package, the media (usually a diskette) may be damaged or the program might be corrupted. Try loading another copy of the software.

If an error message appears while you are using a software package, check the software documentation. These documents usually include a problem solving section or a summary of error messages.

Next, check any error messages in the OS documentation.

Hardware

If you cannot find a software problem, check your hardware. First run through the items in the preliminary checklist above. If you still cannot correct the problem, try to identify the source. The next section provides checklists for individual components and peripherals.

Hardware and system checklist

This section discusses problems caused by your computer's hardware or attached peripherals. Basic problems may occur in the following areas:

- | | |
|-----------------------|-----------------------|
| ■ System start-up | ■ Printer |
| ■ Self test | ■ Pointing device |
| ■ Power | ■ PC card |
| ■ Password | ■ Monitor |
| ■ Keyboard | ■ Sound system |
| ■ LCD panel | ■ TV output signal |
| ■ Hard disk drive | ■ USB |
| ■ DVD-ROM drive | ■ Modem |
| ■ CD-RW/DVD-ROM drive | ■ Standby/Hibernation |
| ■ Diskette drive | ■ Memory Expansion |
| ■ Infrared port | ■ LAN |
| | ■ Wireless LAN |

System start-up

When the computer does not start properly, check the following items:

- Self Test
- Power Sources
- Power-on Password

Self test

When the computer starts up, the self-test will be run automatically, and the following will be displayed:

In Touch with Tomorrow
TOSHIBA

This message remains on the screen for a few seconds.

If the self test is successful, the computer tries to load the operating system. Depending on how the Boot Priority is set in the Hardware Setup, the computer tries to load first from drive A then from drive C, or first from drive C then from drive A.

If any of the following conditions are present, the self test failed:

- The computer stops and does not proceed to display information or messages.
- A beep sounds, and after a few seconds no new messages appear.
- Random characters appear on the screen, and the system does not function normally.
- The screen displays an error message.

Turn off the computer and check all cable connections. If the test fails again, contact your dealer.

Power

When the computer is not plugged into an AC adaptor, the battery pack is the primary power source. However, your computer has a number of other power resources, including intelligent power supply and Real Time Clock battery. These resources are interrelated and any one could affect apparent power problems. This section provides check lists for AC adaptor and the main battery. If you cannot resolve a problem after following them, the cause could lie with another power resource. In such case, contact your dealer.

Overheating power down

If the computer's internal temperature becomes too high, the computer will automatically enter Hibernation or Resume mode and shut down.

Problem	Procedure
Computer shuts down and DC IN indicator blinks orange	<p>Leave the computer off until the DC IN indicator stops blinking.</p> <p><i>It is recommended to leave the computer off until the its interior reaches room temperature even though the DC IN indicator stops blinking.</i></p> <p>If the computer has reached room temperature and still does not start, or if it starts but shuts down quickly contact your dealer.</p>
Computer shuts down and its DC IN indicator is flashing green	Indicates a problem with the heat dispersal system. Please contact your dealer.

AC power

If you have trouble turning on the computer with the AC adaptor connected, check the **DC IN** indicator. Refer to Chapter 6, *Power and Power-Up Modes* for more information.

Problem	Procedure
AC adaptor doesn't power the computer DC IN indicator does not glow green)	<p>Check the connections. Make sure the cord is firmly connected to the computer and a power outlet.</p> <p>Check the condition of the cord and terminals. If the cord is frayed or damaged, replace it. If the terminals are soiled, wipe them with cotton or a clean cloth.</p> <p>If the AC adaptor still does not power the computer, contact your dealer.</p>

Battery

If you suspect a problem with the battery, check the **DC IN** indicator as well as the **Main battery** and **Slim Select Bay** indicators. For information on indicators and battery operation see Chapter 6, *Power and Power-Up Modes*.

Problem	Procedure
Battery doesn't power the computer	The battery may be discharged. Connect the AC adaptor to charge the battery.
Battery doesn't charge when the AC adaptor is attached (Main battery or Slim Select Bay indicator does not glow orange.)	<p>If the battery is completely discharged, it will not begin charging immediately. Wait a few minutes.</p> <p>If the battery still does not charge, make sure the outlet is supplying power. Test it by plugging in an appliance. If it doesn't work, try another power source.</p> <p>Check whether the battery is hot or cold to the touch. If the battery is too hot or too cold, it will not charge properly. Let it reach room temperature.</p>

Unplug the AC adaptor and remove the battery to make sure the terminals are clean. If necessary wipe them with a soft dry cloth dipped in alcohol.

Connect the AC adaptor and replace the battery. Make sure it is securely seated.

Check the **Battery** indicator. If it does not glow, let the computer charge the battery for at least 20 minutes. If the **Battery** indicator glows after 20 minutes, let the battery continue to charge at least another 20 minutes before turning on the computer.

If the indicator still does not glow, the battery may be at the end of its operating life. Replace it.

Battery doesn't power the computer as long as expected	If you frequently recharge a partially charged battery, the battery might not charge to its full potential. Fully discharge the battery, then try to charge it again.
--	---

Check the power consumption settings in Power Saver utility. Consider using a power saving mode.

Password

Problem	Procedure
Cannot enter password	Refer to the Password section in Chapter 7, <i>HW Setup and Passwords</i> .

Keyboard

Keyboard problems can be caused by your setup configuration. For more information refer to Chapter 5, *The Keyboard* and Chapter 7, *HW Setup and Passwords*.

Problem	Procedure
Some letter keys produce numbers	Check that the numeric keypad overlay is not selected. Press Fn + F10 and try typing again.
Output to screen is garbled	Make sure the software you are using is not remapping the keyboard. Remapping involves reassigning the meaning of each key. See your software's documentation. If you are still unable to use the keyboard, consult your dealer.

LCD panel

Apparent LCD problems may be related to the computer's setup. Refer to Chapter 7, *HW Setup and Passwords*, for more information.

Problem	Procedure
No display	Press hotkeys Fn + F5 to change the display priority, to make sure it is not set for an external monitor.
Markings appear on the LCD	They might have come from contact with the keyboard or AccuPoint II. Try wiping the LCD gently with a clean dry cloth. If markings remain, use LCD cleaner. Be sure to let the LCD dry before closing it.
Problems above remain unresolved or other problems occur	Refer to your software's documentation to determine if the software is causing the difficulty. Contact your dealer if the problems continue.

Hard disk drive

Problem	Procedure
Computer does not boot from hard disk drive	Check if a diskette is in the diskette drive or a CD-ROM is in the optical media drive. Remove any diskette and/or CD-ROM and check Boot priority. Refer to the <i>Boot Priority</i> section in Chapter 7, <i>HW Setup and Passwords</i> . There may be a problem with your operating system files. Refer to your OS documentation.
Slow performance	Your files may be fragmented. Run SCANDISK and defragmenter to check the condition of your files and disk. Refer to your OS documentation or online HELP for information on running SCANDISK and the defragmenter. As a last resort, reformat the hard disk. Then, reload the operating system and other files. If problems persist, contact your dealer.

DVD-ROM drive

For more information, refer to Chapter 4, *Operating Basics*.

Problem	Procedure
You cannot access a DVD in the drive	<p>Make sure the drive's drawer is securely closed. Press gently until it clicks into place.</p> <p>Open the drawer and make sure the DVD is properly seated. It should lie flat with the label facing up.</p> <p>A foreign object in the drawer could block laser light from reading the DVD. Make sure there is no obstruction. Remove any foreign object.</p> <p>Check whether the DVD is dirty. If it is, wipe it with a clean cloth dipped in water or a neutral cleaner. See the <i>CD/DVDs care</i> section in Chapter 4, <i>Operating Basics</i>, for details on cleaning.</p>
Some DVD/CDs run correctly, but others do not	<p>The software or hardware configuration may be causing a problem. Make sure the hardware configuration matches your software's needs. Check the DVD/CD's documentation.</p> <hr/> <p>Check the type of DVD/CD you are using. The drive supports:</p> <p>DVD-ROM: DVD-ROM, DVD-Video</p> <p>CD-ROM: CD-DA, CD-Text, Photo CD (single/multi-session), CD-ROM Mode 1, Mode 2, CD-ROMXA Mode 2 (Form1,Form2), Enhanced CD(CD-EXTRA),CD-G(Audio CD only), Addressing Method 2</p> <hr/> <p>Check the region code on the DVD. It must match that on the DVD drive. Region codes are listed in the <i>DVD-ROM drive section</i> in Chapter 2, <i>The Grand Tour</i>.</p>
DVD does not play correctly in an optional Expansion Station	<p>Some video discs might not play properly in a Expansion Station. Play the disc in the DVD-ROM drive installed in the computer.</p> <p>If problems persist, contact your dealer.</p>

CD-RW/DVD-ROM drive

For more information, refer to Chapter 4, *Operating Basics*.

Problem	Procedure
You cannot access a CD or DVD in the drive	<p>Make sure the drive's drawer is securely closed. Press gently until it clicks into place.</p> <hr/> <p>Open the drawer and make sure the CD or DVD is properly seated. It should lie flat with the label facing up.</p> <p>A foreign object in the drawer could block laser light from reading the CD or DVD. Make sure there is no obstruction. Remove any foreign object.</p> <p>Check whether the DVD is dirty. If it is, wipe it with a clean cloth dipped in water or a neutral cleaner. See the <i>CD/DVDs care</i> section in Chapter 4, <i>Operating Basics</i>, for details on cleaning.</p>
Some DVD/CDs run correctly, but others do not	<p>The software or hardware configuration may be causing a problem. Make sure the hardware configuration matches your software's needs. Check the DVD/CD's documentation.</p> <hr/> <p>Check the type of DVD/CD you are using. The drive supports:</p> <p>DVD-ROM: DVD-ROM, DVD-Video</p> <p>CD-ROM: CD-DA, CD-Text, Photo CD (single/multi-session), CD-ROM Mode 1, Mode 2, CD-ROMXA Mode 2 (Form1,Form2), Enhanced CD(CD-EXTRA),CD-G(Audio CD only), Addressing Method 2</p> <hr/> <p>Check the region code on the DVD. It must match that on the DVD drive. Region codes are listed in the <i>DVD-ROM drive</i> section in Chapter 2, <i>The Grand Tour</i>.</p>

-
- Cannot write correctly If you have trouble writing, make sure you are observing the following precautions :
- Use only media recommended by TOSHIBA
 - Do not use the mouse or keyboard during writing.
 - Use only the software supplied with the computer for recording.
 - Do not run or start other software during writing.
 - Do not jar the computer during writing.
 - Do not connect/ disconnect external devices or install/ remove internal cards during writing.
- If problems persist, contact your dealer.
-

Diskette drive (optional)

For more information, refer to Chapter 4, *Operating Basics*.

Problem	Procedure
Drive does not operate	There may be a faulty cable connection. Check the connection to the computer and to the drive.
Some programs run correctly but others do not	The software or hardware configuration may be causing a problem. Make sure the hardware configuration matches your software needs.
You cannot access the external 3 1/2" diskette drive	Try another diskette. If you can access the diskette, the original diskette (not the drive) is probably causing the problem.

If problems persist, contact your dealer.

Infrared port

Refer also to the documentation for your IrDA compatible device and related software.

Problem	Procedure
Infrared devices do not work as expected	<p>Check that the device is connected to an electric outlet. Make sure the outlet is supplying power by plugging in an appliance.</p> <p>Make sure there is no obstruction blocking communication between the computer and the target device.</p> <p>If problems persist, contact your dealer.</p>

Printer

Refer to the troubleshooting and other relevant sections in your printer and software documentation.

Problem	Procedure
Printer does not turn on.	<p>Check that the printer is connected to an electric outlet. Make sure the outlet is supplying power by plugging in an appliance.</p>
Computer/printer do not communicate	<p>Make sure the printer is turned on and is online (ready to use).</p> <p>Inspect the cable connecting the printer to the computer for damage. Make sure it is securely connected.</p> <p>A parallel printer connects to the parallel port and a serial printer to the serial port. Make sure the ports are configured correctly.</p> <p>Make sure your software is configured to recognize the printer. Check your printer and software documentation.</p>
Printer error	<p>Check your printer documentation.</p> <p>If problems persist, contact your dealer.</p>

Pointing device

If you are using a PS/2 or serial mouse, also refer to Chapter 8, *Optional Devices*, and to your mouse documentation. If you are using a USB mouse, also refer to the USB section in this chapter and to your mouse documentation.

AccuPoint II

Problem	Procedure
On-screen pointer does not respond to AccuPoint II operation	<p>The system might be busy. If the pointer is shaped as an hourglass, wait for it to resume its normal shape and try again to move it.</p> <p>If a PS/2 or serial mouse is connected, check the HW Setup window. The Pointing Device option should be set to simultaneous to use both the AccuPoint II and an external PS/2 mouse.</p>
Double-Click does not work	<p>Try changing the double-click speed setting in the mouse control utility.</p> <ol style="list-style-type: none"> 1. Open the Control Panel, select the Mouse icon and press Enter. 2. Click the Buttons tab. 3. Set the double-click speed as instructed and click OK.
The mouse pointer moves too fast or too slow	<p>Try changing the speed setting in the mouse control utility.</p> <ol style="list-style-type: none"> 1. Open the Control Panel, select the Mouse icon and press Enter. 2. Click the Pointer Option tab. 3. Set the speed as instructed and click OK. <p>If problems persist, contact your dealer.</p>

PS/2 mouse

Problem	Procedure
On-screen pointer does not respond to PS/2 mouse operation	<p>Check that the PS/2 mouse cable's 6-pin connector is firmly connected to the PS/2 mouse/ keyboard port.</p> <p>You may have connected the mouse after turning the computer on. Turn off the computer, make sure the mouse is firmly connected and turn the computer back on.</p>
	<p>Is your software configured to recognize the mouse? Check the software documentation.</p> <p>If problems persist, contact your dealer.</p>

Serial mouse

This section applies only with Windows® XP operating systems. You cannot use a serial mouse with Windows®2000.

Problem	Procedure
On-screen pointer does not respond to serial mouse operation	<p>Check for a firm connection between the computer's serial port and the cable's 9-pin connector.</p> <p>Did you connect the mouse before turning on the computer?</p> <p>Is your software configured to recognize the mouse? Check the software documentation.</p> <p>If problems persist, contact your dealer.</p>

USB mouse

Problem	Procedure
On-screen pointer does not respond to mouse operation	<p>The system might be busy. If the pointer is shaped as an hourglass, wait for it to resume its normal shape and try again to move it.</p> <p>Make sure the mouse is properly connected to the USB port.</p>
Double-clicking does not work	<p>Try changing the double-click speed setting in the mouse control utility.</p> <ol style="list-style-type: none"> 1. Open the Control Panel, select the Mouse icon and press Enter. 2. Click the Buttons tab. 3. Set the double-click speed as instructed and click OK.
The mouse pointer moves too fast or too slow	<p>Try changing the speed setting in the mouse control utility.</p> <ol style="list-style-type: none"> 1. Open the Control Panel, select the Mouse icon and press Enter. 2. Click the Pointer Options tab. 3. Set the speed as instructed and click OK.
The mouse pointer moves erratically	<p>The mouse might be dirty. Refer to your mouse documentations for instructions on cleaning.</p> <p>If problems persist, contact your dealer.</p>

PC card

Refer also to Chapter 8, *Optional Devices*.

Problem	Procedure
PC card error occurs	<p>Reseat the PC card to make sure it is firmly connected.</p> <p>Make sure the connection between the external device and the card is firm.</p> <p>Check the card's documentation.</p> <p>If problems persist, contact your dealer.</p>

Monitor

Refer also to Chapter 8, *Optional Devices*, and to your monitor's documentation.

Problem	Procedure
Monitor does not turn on	<p>Make sure that the external monitor's power switch is on. Confirm that the external monitor's power cable is plugged into a working power outlet.</p>
No display	<p>Try adjusting the contrast and brightness controls on the external monitor.</p> <p>Press hotkeys Fn + F5 to change the display priority and make sure it is not set for the internal display.</p>
Display error occurs	<p>Check that the cable connecting the external monitor to the computer is attached firmly.</p> <p>If problems persist, contact your dealer.</p>

Sound system

Problem	Procedure
No sound is heard	<p>Adjust the volume control dial.</p> <p>Check the software volume settings.</p> <p>Make sure the headphone connection is secure.</p>

Check Windows Device Manager. Make sure the sound function is enabled and that settings for I/O address, Interrupt level and DMA are correct for your software and do not conflict with other hardware devices that you may have connected to the computer.

If problems persist, contact your dealer.

TV output signal

Refer also to your Personal Conferencing Kit's documentation.

Problem	Procedure
Display on TV is poor	Make sure the TV type is correct for your area: NTSC (US, JAPAN), PAL (Europe).
No display	<p>Try adjusting the contrast and brightness controls on the external monitor.</p> <p>Press hotkeys Fn + F5 to change the display. Refer to Chapter 5, <i>The Keyboard</i>.</p> <p><i>If you turn the computer off in Resume mode while the display is on TV, the computer will select either the internal LCD or an external computer CRT as the display device.</i></p>

If problems persist, contact your dealer.

USB

Refer also to your USB device's documentation.

Problem	Procedure
USB device does not work	<p>Check for a firm cable connection between the USB ports on the computer and the USB device.</p> <p>Make sure the USB device drivers are properly installed. Refer to your Windows documentation for information on checking the drivers.</p> <p>If you are using an operating system that does not support USB, you can still use a USB mouse and/or USB keyboard. If these devices do not work, make sure the USB KB/Mouse Legacy Emulation item in HW Setup is set to Enabled.</p> <p>If problems persist, contact your dealer.</p>

Modem

Problem	Procedure
Communication software can't initialize modem	Make sure the computer's internal modem settings are correct. Refer to <i>Phone and Modem Options</i> in the Control Panel.
You can hear a dial tone but can't make a call	If the call is going through a PBX machine, make sure the communication application's tone dial detection feature is disabled.
You place a call, but a connection can't be made	Make sure the settings are correct in your communications application.
After making a call you can't hear a ring	Make sure the tone or pulse selection in your communications application is set correctly.
Communication is cut off unexpectedly	The computer will automatically cut off communication when connection with the carrier is not successful for a set time interval. Try lengthening this time interval.
A CONNECT display is quickly replaced by NO CARRIER	Check the error control setting in your communications application.
Character display becomes garbled during a communication	In data transmission, make sure the parity bit and stop bit settings correspond with those of the remote computer. Check the flow control and communication protocol.
You cannot receive an incoming call	Check the rings before auto answer setting in your communications application. If problems persist, contact your dealer.

Standby/Hibernation

Problem	Procedure
The system will not enter Standby/Hibernation	<p>Is Windows Media™ Player open? The system might not enter Standby/Hibernation, if Windows Media Player is either playing a selection or finished playing a selection. Close Windows Media Player before you select Standby/Hibernation.</p> <p>If problems persist, contact your dealer.</p>

LAN

Problem	Procedure
Cannot access LAN	Check for a firm cable connection between the LAN jack and the LAN HUB.
Wake-up on LAN does not work	<p>Make sure the AC adaptor is connected. The Wake-up on LAN function consumes power even when the system is off.</p> <p>If problems persist, consult your LAN administrator.</p>

Wireless LAN

If the following procedures do not restore LAN access, consult your LAN administrator. For more information on wireless communication, refer to Chapter 4, *Operating Basics*.

Problem	Procedure
Cannot access Wireless LAN	<p>Make sure the computer's wireless communication switch is set to on.</p> <p>If problems persist, consult your LAN administrator.</p>

TOSHIBA support

If you require any additional help using your computer or if you are having problems operating the computer, you may need to contact TOSHIBA for additional technical assistance.

Before you call

Some problems you experience may be related to software or the operating system, it is important to investigate other sources of assistance first. Before contacting TOSHIBA, try the following:

- Review troubleshooting sections in the documentation for software and peripheral devices.
- If a problem occurs when you are running software applications, consult the software documentation for troubleshooting suggestions. Call the software company's technical support for assistance.
- Consult the dealer you purchased your computer and/or software from. They are your best sources for current information and support.

Where to write

If you are still unable to solve the problem and suspect that it is hardware related, write to TOSHIBA at the nearest location listed Appendix C.

Appendix A

Specifications

This appendix summarizes the computer's technical specifications.

Physical Dimensions

Size	316 (w) x 275(d) x 33.9 (front)/38.1 (back) millimeters (does not include the thicker part of the bottom of the computer)
-------------	---

Weight (typical*)	2.7kilograms (Approximate), configured with: 14"XGA display, fixed DVD-ROM drive, 256MB memory, 40GB(5400rpm) HDD.
--------------------------	--

* Weight will vary depending on whether or not and what kind of options are adopted.

Environmental Requirements

Conditions	Ambient temperature	Relative humidity
Operating	5°C (41°F) to 35°C (95°F)	20% to 80%
Nonoperating	-20°C (-4°F) to 65°C (149°F)	10% to 90%
Thermal Gradient	20°C per hour maximum	
Wet-bulb temperature	26°C maximum	

Conditions	Altitude (from sea level)
Operating	-60 to 3,000 meters
Nonoperating	-60 to 10,000 meters maximum

Power Requirements

AC adaptor	100- 240 volts AC 50 or 60 hertz (cycles per second)
Computer	15 VDC 5.0 amperes

Built-in Modem**Network control unit (NCU)**

Type of NCU	AA
Type of line	Telephone line (analog only)
Type of dialing	Pulse Tone
Control command	AT commands EIA-578 commands
Monitor function	Computer's speaker

Communication specifications

Communication system	Data: Fax:	Full duplex Half duplex
Communication protocol	Data ITU-T-Rec (Former CCITT) Bell Fax ITU-T-Rec (Former CCITT)	V.21/V.22/V.22bis/V.32 /V.32bis/V.34/V.90 103/212A V.17/V.29/V.27ter /V.21 ch2
Communication speed	Data transmission and reception 300/1200/2400/4800/7200/9600/12000/14400/ 16800/19200/21600/24000/26400/28800/ 31200/33600 bps Data reception only with V.90 28000/29333/30666/32000/33333/34666/ 36000/37333/38666/40000/41333/42666/ 44000/45333/46666/48000/49333/50666/ 52000/53333/54666/56000 bps Fax 2400/4800/7200/9600/12000/14400 bps	
Error correcting	MNP class 4 and ITU-T V.42	
Data compression	MNP class 5 and ITU-T V.42bis	

Appendix B

AC Power Cord and Connectors

The power cord's AC input plug must be compatible with the various international AC power outlets and the cord must meet the standards for the country/region in which it is used. All cords must meet the following specifications:

Length:	Minimum 2 meters
Wire size:	Minimum 0.75 mm ²
Current rating:	Minimum 2.5 Amperes
Voltage rating:	125 or 250 VAC (depending on country/region's power standards)

Certification agencies

U.S. and Canada:	UL listed and CSA certified No. 18 AWG, Type SVT or SPT-2 two conductor
-------------------------	--

Europe:

Austria:	OVE	Italy:	IMQ
Belgium:	CEBEC	The Netherlands:	KEMA
Denmark:	DEMKO	Norway:	NEMKO
Finland:	FIMKO	Sweden:	SEMKO
France:	UTE	Switzerland:	SEV
Germany:	VDE	United Kingdom:	BSI

Australia:	AS	Japan:	DENANHO
-------------------	----	---------------	---------

In Europe, power cords must be VDE type, H05VVH2-F and two conductor.

For the United States and Canada, plug configuration must be a 2-15P (250 V) or 1-15P (125 V) as designated in the U.S. National Electrical code handbook and the Canadian Electrical Code Part II.

The following illustrations show the plug shapes for the U.S.A. and Canada, the United Kingdom, Australia and Europe.

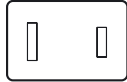
USA and Canada

UL approved
CSA approved

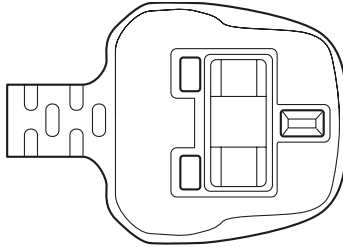
United Kingdom

BS approved

Australia

AS approved

Europe

Approved by the appropriate agency

The TOSHIBA International Warranty

The TOSHIBA International Warranty is a service policy on the parts and repair on your TOSHIBA portable personal computer which is automatically available to purchasers of the computer.

The cover is assured in major industrial countries of the world. It means that wherever you take your TOSHIBA mobile PC in this area, you will never be left without help should any problems arise.

For more information on the warranty coverage please refer to your warranty booklet supplied with your Notebook.

What the warranty covers

The Warranty covers the computer in the standard version, including the AC adaptor. Batteries, modems, memory expansion kits and other TOSHIBA branded options, as well as third party expansion boards are NOT covered by this warranty. For information concerning warranties for these products, please consult your dealer.



If you would like to use the international warranty, please register for this warranty. In case no registration card for the international warranty was bundled with your computer, please contact at the following Internet website:

<http://www.toshiba-europe.com/computers/warranty>

Once your registration has been received by TOSHIBA the warranty entitlement of your Notebook can be checked on the following Internet website:

<http://gedb.toshiba.com>

On the following pages is a list of the TOSHIBA Authorised Service Providers who can be contacted if a claim on the warranty needs to be made.

If users need further addresses in Eastern Europe or outside Europe, these are available from the national or European companies.

The countries to which the international warranty applies can be found using the TOSHIBA Global ASP locator.

Click: Support, Find an Authorised Service Provider

TOSHIBA's Worldwide Computer Representatives

Australia	Toshiba (Australia) Pty. Limited 84-92 Talavera Road, North Ryde NSW 2113	Tel: +61-2-9887-3322 Fax: +61-2-9888-3664 http://www.isd.toshiba.com.au
Austria	Toshiba Europe GmbH Leibnizstr. 2 93055 Regensburg	Tel: 0800-29 74 88 Fax: +49-(0)941-780 79 25 www.computer.toshiba.at
Azerbaijan	AZEL (Azerbaijan Electronics) Floor 5, 65 Fizuli Str. 370014 Baku	Tel: +99412-974040 Fax: +99412-974042 http://www.azel.net
Belgium	Toshiba Information Systems Belgium Excelsiorlaan 40 1930 Zaventem	Tel: +32-900-10990 Fax: +32-2-7253030 www.toshiba.be
Bulgaria	IMPEX Sofia Ltd. 12, Anton Naydenov Street, PO Box 184, 1710 Sofia	Tel: +359-2-962-1219 Fax: +359-2-962-5062
Canada	Toshiba of Canada Ltd. 191 McNabb Street Markham, Ontario L3R-8H2	Tel: +1-905-470-3500 Fax: +1-905-470-3487 http://www.toshiba.ca
Czech Republic	CHG Service , s.r.o. Videnska 102 619 00 Brno	Tel: +420-5-4742-6581 Fax: +420-5-4742-6590 http:// www.chgservice.cz or www.toshiba-pc.cz
Denmark	Scribona Toshiba Digital Media Hovedvejen 9, DK-2600 Glostrup	Tel: +45-3823-7600 Fax: +45-3823-7601 www.toshiba-dm.com
Egypt	El Araby Co. for Trading and Manufacturing P.O. Box 1224/Off Beirut St. 10, Mohammed Sabry Abolaalm Street Kourba , Heliopolis / Cairo 11511	Tel: +202-291-6989 Fax: +202-291-6454 http://www.elaraby.com.eg
Estonia	ServiceNet EE Pärnu str. 142A 11317 Tallinn	Tel: +372-6504-949 Fax: +372-6504-916 http://www.servicenet.ee
Finland	Scribona TPC OY / Toshiba Digital Media Sinimäentie 14,P.O.Box 83, 02630 ESPOO	Tel: +358-9-5272555 Fax: +358-9-5272500 http://www.toshiba.se
France	Toshiba Systèmes (France) S.A. 7 Rue Ampère ; B.P. 131 92804 Puteaux Cedex	Tel.: +33-8 92 69 70 92 Fax: +33-1-4728-2247 http://www.pc.toshiba.fr
Germany	Toshiba Europe GmbH Leibnizstraße 2, D-93055 Regensburg	Tel: 01805-23 16 32 Fax: +49-(0)941-7807-925 www.computer.toshiba.de

Greece	Ideal Electronics S.A. 25 Kreontos Str. 10442 Sepolia, Athens	Tel: +30-210-5193950 Fax: +30-210-5193960 http://www.ideal.gr
Hungary	Technotrade Informatikai Rt. Öv u, 185, 1147 Budapest	Tel: +36-1-467 6100 Fax: +36-1-252 6470 http://www.technotrade.hu
Ireland	Toshiba Information Systems (U.K.) Limited, Toshiba Court, Weybridge Business Park, Addlestone Road, Weybridge, Surrey KT15 2UL	Tel.: +353 (0)1248 1 248 Fax: + 44 (0)8702 202 303 www.toshiba.co.uk/computers/
Israel	Mafil Technologies (3000) Ltd 8 Bareket Street 49517 Petah Tikwa	Tel: +972-3-918-3333 Fax: +972-3-924-1310 http://www.mafil.co.il
Italy	Progetto Elettronica 92.S.p.A Via de Gasperi 88a, 20017 Mazzo di Rho	Tel: +39-02-9397-5551 +39-02-939 75678 Fax: +39-02-9397-5299 http://www.pe92.it
Japan	Toshiba Corporation, IOPC 1-1, Shibaura 1-Chome, Minato-KU Tokyo 105-01	Tel: +81-3-3457-5565 Fax: +81-3-5444-9262 http://www.toshiba.co.jp
Jordan	Scientific & Medical Supplies Co. Jabal Amman, 1st Circle , Al Hayyek Street, Opposite to Housing Bank 11118 Amman	Tel: +962 (6) 4624907 Fax: +962 (6) 462858
Kuwait	Arabian Business Machines Co. Salhiya-Sulaiman AL Laheeb Building 3 P.O. Box 29961, 13160 Safat	Tel: +965-242-9154 244-5373/-5369 Fax: +965-241-4399 www.abm-kuwait.com
Latvia	Servicenet LV Bullu Str 9 LV1055 Riga	Tel: +371-7052079 Tel.: +371 7460399 Fax: + 371-7460299 http://www.servicenet.lv
Lebanon	ALCS Diab Bldg. Mkalles Rd., P.O. Box 11-316 Beirut	Tel: +961-1-682-956 Fax: +961-1-682-965 www.pcdealnet.com
Lithuania	ServiceNet LT Palemono 7A 3023 Kaunas	Tel: + 370 37 4000 88 Fax: + 370 37 3108 05 http://www.servicenet.lt
Luxemburg	See 'Netherlands'	
Malta	Tabone Computer Centre Limited 111 Old Railway Track HMR-16 St Venera	Tel: +356-49 36 04 Fax: +356-49 36 03 http://www.tabone.com.mt
Morocco	C.B.I. Lotissement Attoufik, Rue No 1 Immeuble 29, Sidi Maarouf 20190 Casablanca/ Maroc	Tel: +212- 22 43 71 60/61 Fax: +212-22 43 71 88

Netherlands	Toshiba Information Systems Benelux B.V. Rivium Boulevard 41 2909 LK Capelle a/d IJssel	Tel: +31-0900-1000-1000 Fax: +31-10-2882-390 http://www.toshiba.nl
Norway	Scribona Norway A/S Stålfjæra 20, P.O.Box 51, Kalbakken 0901 Oslo	Tel: +47-22-897-189 Fax: +47-22-897-166 http://www.toshiba.se
Oman (Sultanate of Oman)	Suhail&Saud Bahwan (SSB) Sarco Building, Ground Floor No. 459, Way No. 310 Al Noor Street, Ruwi 113 Muscat	Tel.: + 968 790191-117 Fax: +968-790 192 http://www.bahwanit.com
Poland	AC Serwis Sp. Z o. o. ul. Partyzantów 71, 43-316 Bielsko-Biala	Tel: +48- 33-8130-205 Fax: +48- (33-8130-209 http://www.acserwis.com.pl
Portugal	Toshiba Information Systems Portugal Edificio D. Pedro I, Sala 17 Quinta da Fonte 2780-730 Paço d' Arcos	Tel: +351-707265265 Fax: +351-21-000-1675 http://www.toshiba.pt
Qatar	Mannai Trading Company Rayyan Road, P.O. Box 76 Doha	Tel: +974 441-2555 Fax: +974 444-5413
Qatar	Jarir Bookstore Qatar Al Maha Center, Ramada Crossing, Salwa Road, P.O. Box 24824, Doha	Tel: +974 444 0212 Fax: +974 444 04 32 www.jarirbookstore.com
Romania	Scop Computers SRL 162 Barbu Vacarescu St, Sector 2 71424 Bucharest	Tel: +40-1-231-4602 Fax: +40-1-231-4606 http://www.scop.ro
Russia	AC SERSO Sovetskoi Armii st. 5 127018 Moscow	Tel: +7 - 095 284 5577 Tel: +7-095 105-8161 Fax: +7-095 284 5880 http://www.cepco.ru
Russia	Microbit SERSO Izmailovskiy Pr.2 S.Petersburg 198005	Tel.: +7 812 327-5700 www.microbit.ru
Saudi Arabia	Arabian Business Machines Co. Dareen Center, Ahsaa Road P.O. Box 2006 11451 Riyadh	Tel: +966-1 478 4909 Fax: +966-1 477 7803 www.olayangroup.com
Saudi Arabia	Jarir Bookstore P.O. Box 3196 Olaya Street 11471 Riyadh	Tel: +966-1 462 6000 Fax: +966-1 462 9500 www.jarirbookstore.com
Slovakia	HT Computers a.s. Dobrovicova 8; 81109 Bratislava	Tel: +421-2-59334 550 Fax: +421-2-59334 555 http://www.htc.sk

Slovenia	Inea d.o.o. Stegne 11, 1000 Ljubljana	Tel: +386-1-513-81-00 Fax: +386-1-513-81-60 http://www.inea.si
South Africa	CS IT Solutions, CS Holdings Office Park Block D, 241 Third Road PO Box 786691 1685 Midrand	Tel: +27 (0) 11 205-7000 Fax: +27-0-11-205-8586 http://www.cs.co.za/it.htm
South Africa	RECTRON (Pty) Ltd. 152 15th Road, Randjespark Midrand, 1685	Tel: +27-0-11-203-1000 Fax: +27-0-11-203-1100
Spain	Toshiba Information Systems (España) S.A. Parque Empresarial San Fernando Edificio Europa, 1a Planta, Escalera A 28830 (Madrid) San Fernando de Henares	Tel: +34-91-6606-700 Fax: +34-91-6606-760 http://www.toshiba.es
Sweden	Toshiba Digital Media Sundbybergsvägen 1, Box 1374 171 27 Solna	Tel: +46-200-212100 Fax: +46-8-734-4656 http://www.toshiba.se
Switzerland	Toshiba Europe GmbH, Swiss Sales branch, Chriesbaumstrasse 4 Postfach 171 CH-8604 Volketswil	Tel: +41-848-845250 Fax: +41-1-908 5658 http://www.toshiba.ch
Turkey	Bekom Bilgisayar Sistemleri San. ve TIC. A.S. Burhaniye Mah. Neset Bey Sok. No:7 USKUDAR, ISTANBUL	Tel: +90 216 422 40 50 Fax: +90 216 422 55 20 http://www.toshibatr.com
Ukraine	DKT-SERSO Lesya Ukrainka blv, 26 01133 Kiev	Tel: +380-44-573-9627 Fax: +380-44-254-4646 http://www.dkt-cepco.com.ua
United Arab Emirates	Al-Futtaim Electronics P.O. Box 5866, Bin Ham Building, Mezzanine Floor Adjacent to BurJuman Centre, Trade Centre Road, Dubai	Tel: +971 4 351 5004 Fax: +971 4 351 4254 http://www.toshibauae.com
United Arab Emirates	Al-Futtaim Electronics, Central Services Operation Garhound Area, P.O. Box:531 Dubai, U.A.E.	Tel: +971 4 282 5112 Fax: +971 4 282 4094
United Arab Emirates	Al-Futtaim Electronics, Central Services Operation Mina-Area, P.O. Box:26605, Abudhabi, U.A.E.	Tel: +971 2 673 3004 Fax: +971 2 673 3809
United Kingdom	Toshiba Information Systems (UK) Ltd. Toshiba Court, Weybridge Business Park Addlestone Road, Weybridge Surrey KT15 2UL	Tel: +44-(0)8702 202202 Fax: + 44-(0)8702 202303 www.toshiba.co.uk/computers/
United States	Toshiba America Information Systems, Inc. 9740 Irvine Blvd., P.O. Box 19724 Irvine, CA 92713-9724	Tel: +1-949-583-3000 Fax: +1-949-583-3345 http://www.toshiba.com
Yugoslavia	CT Computers d.o.o. Vladimira Popovica 6 11070 Beograde	Tel: +381-11-311-2060 Fax: +381-11-311-2060 http://www.comtrade.co.yu

Or for all countries not listed, please call the
Toshiba International Service Line:
or E-mail: toshibawarranty@nl.unisys.com

Tel: +352 460433
Fax: +31-20-488 7654

TOSHIBA addresses for the Internet/World Wide Web

TOSHIBA Europe

<http://www.toshiba-europe.com>

TOSHIBA America

<http://www.toshiba.com>

TOSHIBA Japan

<http://www.toshiba.co.jp>

TOSHIBA Canada

<http://www.toshiba.ca>

Appendix D

Keyboard Layouts

Arabic

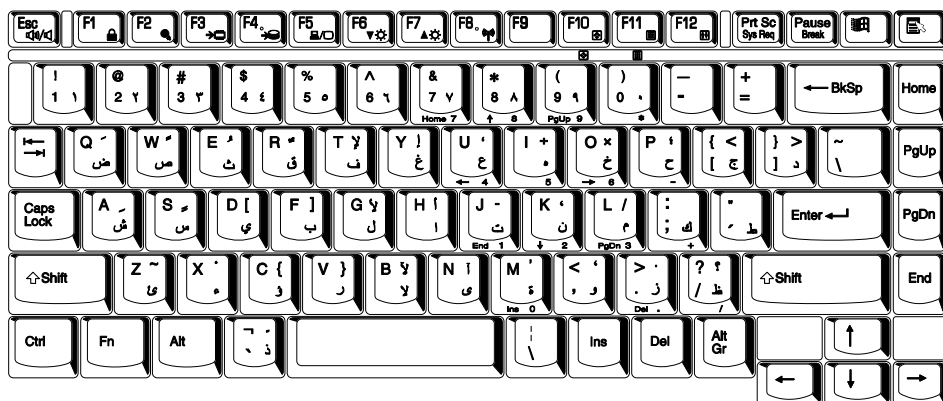

Belgian



Danish



French



German

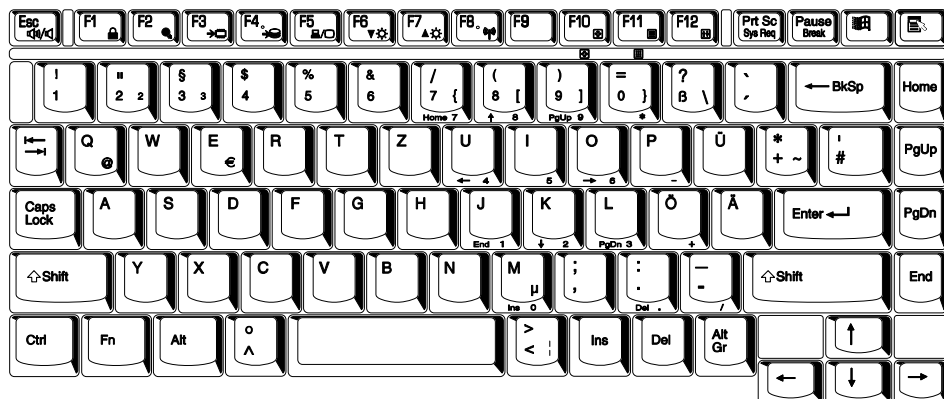

Greek



Hebrew

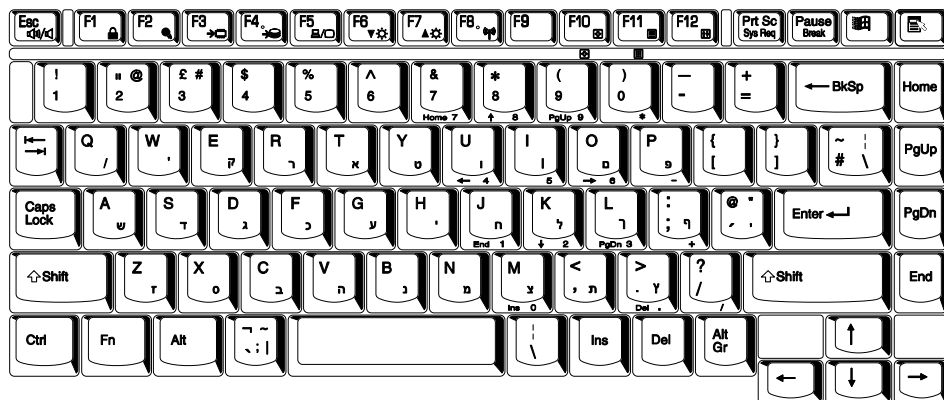

Italian

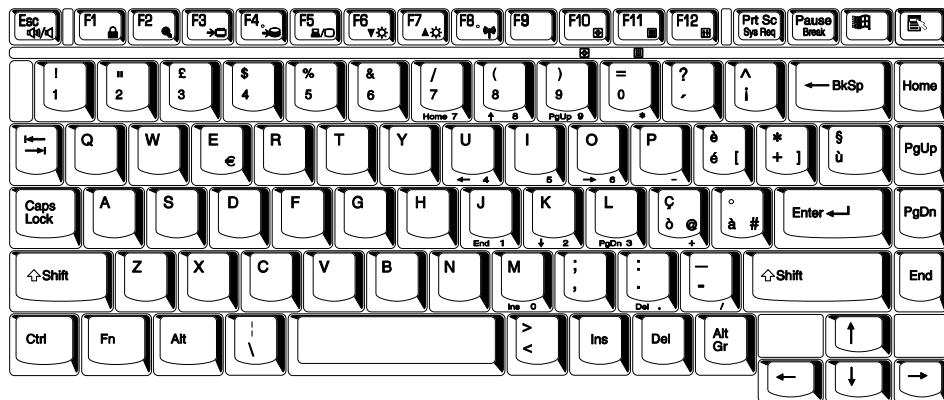

Norwegian

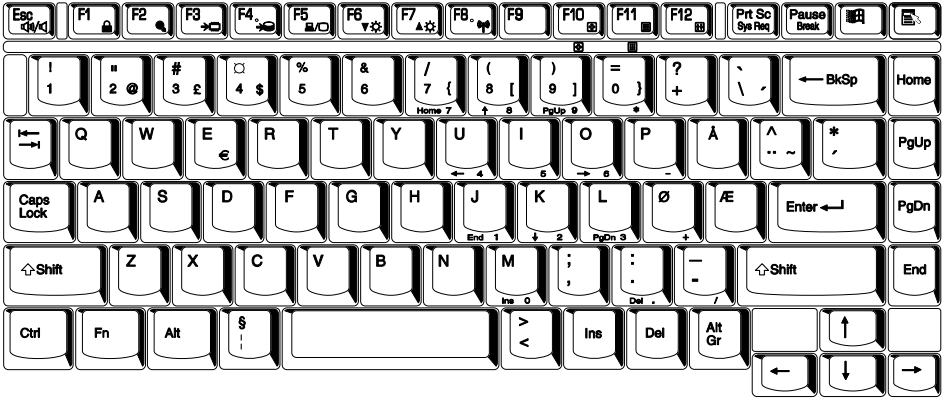

Polish

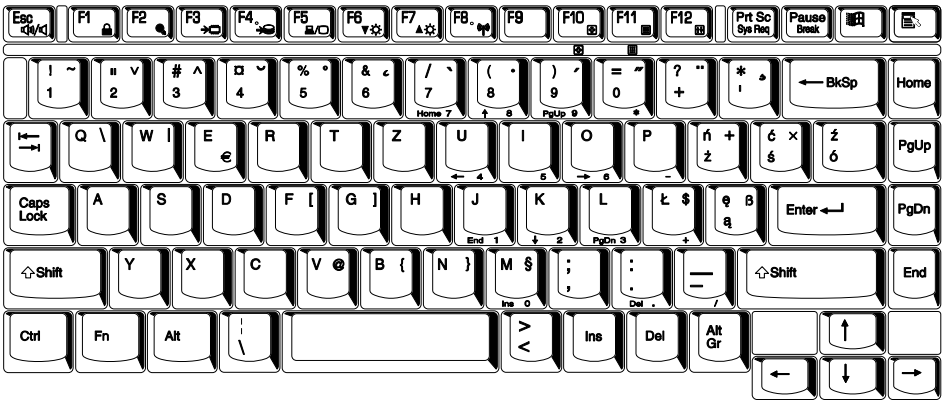

Portuguese



Russian

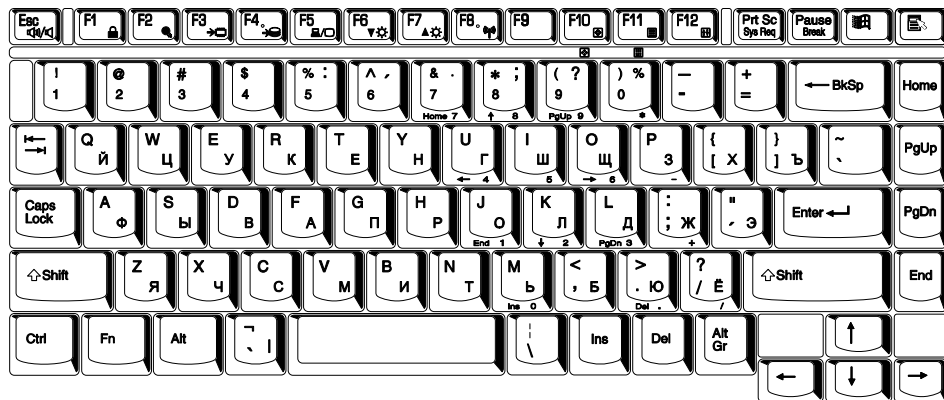

Spanish

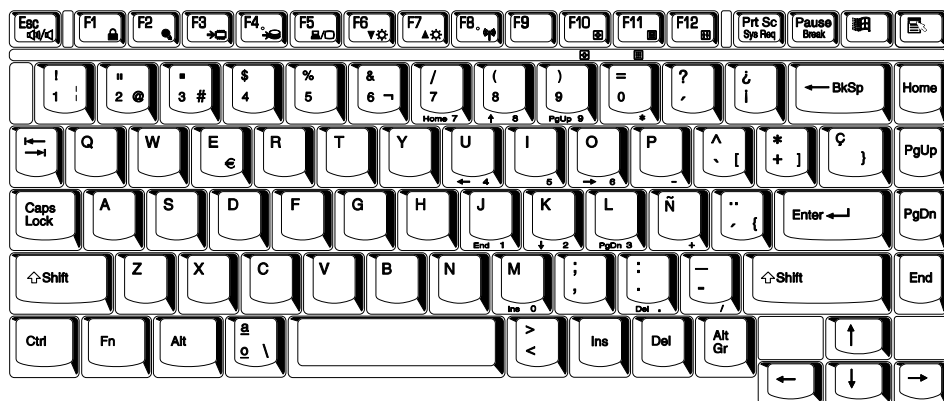

Swedish



Swiss-German

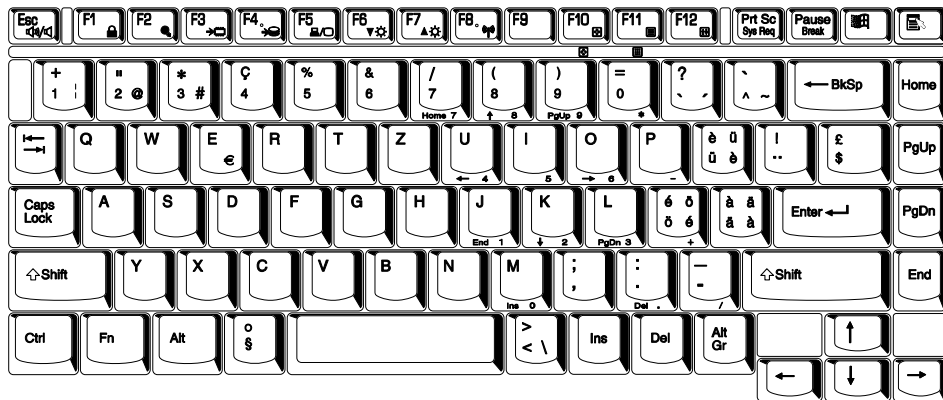

Turkish

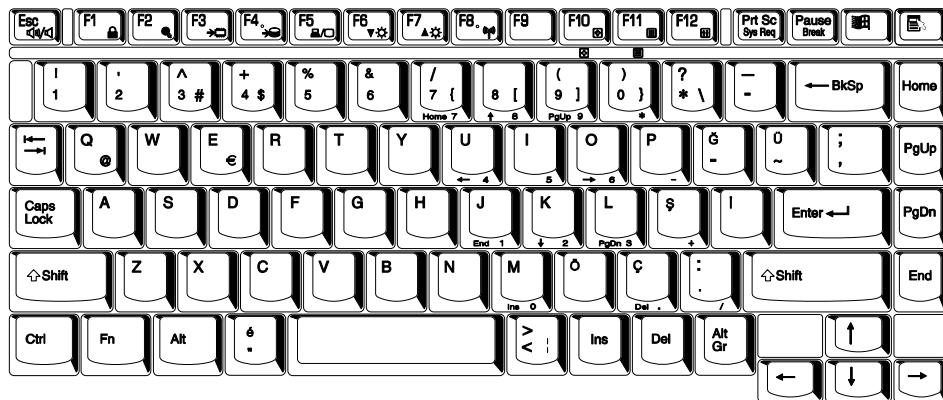

UK English

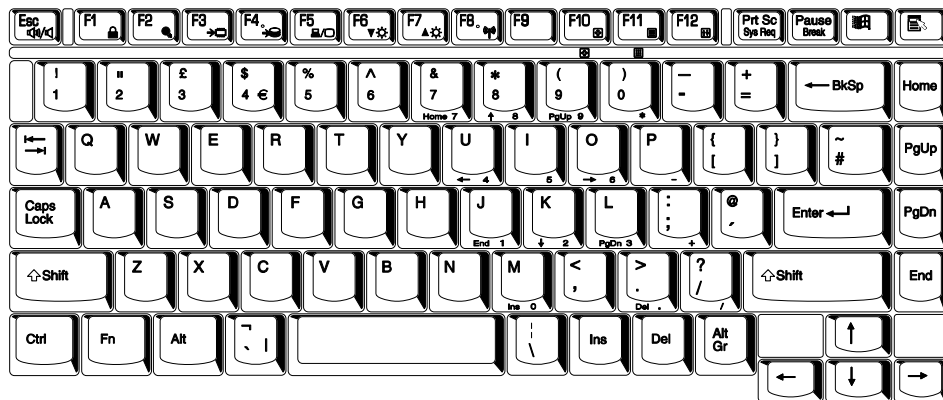

US English



Appendix E

Display Controller and Modes

Display controller

The display controller interprets software commands into hardware commands that turn particular pels on or off.

The controller is an advanced Video Graphics Array (VGA) that provides Super VGA (SVGA) and Extended Graphics Array (XGA) support for the internal LCD and external monitors.

The following model is available:

- 14" XGA, 1024 horizontal x 768 vertical pixels

A high-resolution external monitor connected to the computer can display up to 2048 horizontal and 1536 vertical pixels at up to 16M colors.

The display controller also controls the video mode, which uses industry standard rules to govern the screen resolution and the maximum number of colors that can be displayed on screen.

Software written for a given video mode will run on any computer that supports the mode.

The computer's display controller supports all VGA and SVGA modes, the most widely used industry standards.

Display modes

This appendix is a table of the display mode options of your computer's Graphics and Memory Controller Hub.

Display Modes

CRT Display Resolution	Color Depth	Refresh Rate (Hz)		
		60	75	85
800*600	16bpp	60	75	85
	32bpp	60	75	85
1024*768	16bpp	60	75	85
	32bpp	60	75	85
1280*1024	16bpp	60	75	85
	32bpp	60	75	85
1600*1200	16bpp	60	75	85
	32bpp	60	75	85
1920*1440	16bpp	60	75	
	32bpp	60	75	
2048*1536	16bpp	60	75	
	32bpp	60	75	

If your computer is stolen



Always take care of your computer and try to prevent it from being stolen. You are the owner of a valuable technical device, which may be highly attractive to thieves, so please do not leave it unattended in a public place. To further help protect against theft, security cables can be bought for use with your notebook when it is being used at home or in the office.

Make a note of your computer's machine type, model number, and serial number, and put it in a safe place. You will find this information on the underside of your notebook. Please also keep the receipt of the computer you purchased.

Should your computer be stolen, however, we'll help you try to find it. Before contacting Toshiba, please prepare the following information which is necessary to uniquely identify your computer:

- In which country was your computer stolen?
- What type of machine do you have?
- What was the model number (PA number)?
- What was the serial number (8 digits)?
- When was it stolen, i.e. date?
- What was the warranty seal number (if available)?
- What is your address, phone, and fax number?

To register the theft, please follow these procedures:

- Fill in the Toshiba Theft Registration form (or a copy of it) below.
- Attach a copy of your receipt showing where your computer was purchased.
- Either fax or send the receipt and registration form to the address below.

Your registration will be entered in a database, which is used to track Toshiba computers at our service points around Europe.

Toshiba Theft Registration

Send to: Toshiba Europe GmbH
 Technical Service and Support
 Leibnizstr. 2
 93055 Regensburg
 Germany

Fax number: +49 (0) 941 7807 925

Country stolen:	
Machine type: (e.g. TOSHIBA TE2300)	
Model number: (e.g. PT230E YXT)	
Serial number: (e.g. 70123456E)	
Date stolen:	
Warranty seal: (e.g. 9813 123456 049)	

Owner's details

Name:	
Company:	
Street:	
Postal Code/City:	
Country:	
Phone:	
Fax:	

Internal Modem Guide

This appendix describes how to install and the remove the internal modem.



Do not disassemble the computer beyond the steps described in this instruction or touch any components not specifically described.

Installing the modem board



The internal modem is preinstalled. The following is for information only.

To install the modem board, follow the steps below.

1. Save your data, quit Windows and turn off the power.
2. Disconnect the AC adaptor and any other peripheral devices.
3. Turn the computer upside down and remove the battery pack.
4. Remove one screw securing the modem cover and remove the cover.
5. Remove two screws, which you use later to secure the modem board.
6. Seat the modem board.
7. Connect the modem board cable.
8. Secure the modem board with two screws removed in step 5.
9. Seat the modem board cover and secure it with one screw.
10. Install the battery pack.

Removing the modem board

To remove the internal modem.

1. Save your data, quit Windows and turn off the power.
2. Disconnect the AC adaptor and any other peripheral devices.
3. Turn the computer upside down and remove the battery pack.
4. Remove one screw securing the modem cover and remove the cover.
5. Remove two screws securing the modem board.
6. Lift out the modem board.
7. Disconnect the modem board cable.
8. Seat the modem board cover and secure it with one screw.
9. Install the battery pack.

Appendix H

ASCII Character Codes

This appendix shows the American Standard Code for Information Interchange (ASCII) on the following pages. The characters in the **IBM char** column appear on your display when you type the corresponding ASCII code (as described in Chapter 5, *The Keyboard*). The characters that are printed, however, depend on the software you are using. For most software, the printed output for decimal codes 32 to 128 will match your screen display.

Dec code	Hex code	IBM char	Sort seq	Ctrl char
000	00		000	NUL
001	01	☺	1	SOH
002	02	☹	2	STX
003	03	♥	3	ETX
004	04	♦	4	EOT
005	05	♣	5	ENQ
006	06	♠	6	ACK
007	07	•	7	BEL
008	08	◼	8	BS
009	09	○	9	HT
010	0A	◼	10	LF
011	0B	○	11	VT
012	0C	○	12	FF
013	0D	♪	13	CR
014	0E	♪	14	SO
015	0F	⚙	15	SI
016	10	▶	16	DLE
017	11	◀	17	DC1
018	12	↕	18	DC2
019	13	!!	19	DC3
020	14	¶	20	DC4
021	15	§	21	NAK
022	16	▬	22	SYN
023	17	↕	23	ETB
024	18	↑	24	CAN
025	19	↓	25	EM
026	1A	→	26	SUB
027	1B	←	27	ESC
028	1C	└	28	FS
029	1D	↔	29	GS
030	1E	▲	30	RS
031	1F	▼	31	US

Dec code	Hex code	IBM char	Sort seq
032	20	space	32
033	21	!	33
034	22	"	34
035	23	#	35
036	24	\$	36
037	25	%	37
038	26	&	38
039	27	'	39
040	28	(40
041	29)	41
042	2A	*	42
043	2B	+	43
044	2C	,	44
045	2D	-	45
046	2E	.	46
047	2F	/	47
048	30	0	48
049	31	1	49
050	32	2	50
051	33	3	51
052	34	4	52
053	35	5	53
054	36	6	54
055	37	7	55
056	38	8	56
057	39	9	57
058	3A	:	58
059	3B	;	59
060	3C	<	60
061	3D	=	61
062	3E	>	62
063	3F	?	63

Dec code	Hex code	IBM char	Sort seq
064	40	@	64
065	41	A	65
066	42	B	66
067	43	C	67
068	44	D	68
069	45	E	69
070	46	F	70
071	47	G	71
072	48	H	72
073	49	I	73
074	4A	J	74
075	4B	K	75
076	4C	L	76
077	4D	M	77
078	4E	N	78
079	4F	O	79
080	50	P	80
081	51	Q	81
082	52	R	82
083	53	S	83
084	54	T	84
085	55	U	85
086	56	V	86
087	57	W	87
088	58	X	88
089	59	Y	89
090	5A	Z	90
091	5B	[91
092	5C	\	92
093	5D]	93
094	5E	^	94
095	5F	_	95

Dec code	Hex code	IBM char	Sort seq
096	60	'	96
097	61	a	97
098	62	b	98
099	63	c	99
100	64	d	100
101	65	e	101
102	66	f	102
103	67	g	103
104	68	h	104
105	69	i	105
106	6A	j	106
107	6B	k	107
108	6C	l	108
109	6D	m	109
110	6E	n	110
111	6F	o	111
112	70	p	112
113	71	q	113
114	72	r	114
115	73	s	115
116	74	t	116
117	75	u	117
118	76	v	118
119	77	w	119
120	78	x	120
121	79	y	121
122	7A	z	122
123	7B	{	123
124	7C		124
125	7D	}	125
126	7E	~	126
127	7F	␣	127

Dec code	Hex code	IBM char	Sort seq
128	80	Ç	67
129	81	ü	85
130	82	é	69
131	83	â	65
132	84	ä	65
133	85	à	65
134	86	â	65
135	87	ç	67
136	88	è	69
137	89	ë	69
138	8A	è	69
139	8B	ï	73
140	8C	î	73
141	8D	ì	73
142	8E	Ä	65
143	8F	Å	65
144	90	É	69
145	91	æ	65
146	92	Æ	65
147	93	ô	79
148	94	ö	79
149	95	ò	79
150	96	û	85
151	97	ù	85
152	98	ÿ	89
153	99	Ö	79
154	9A	Ü	85
155	9B	ç	36
156	9C	£	36
157	9D	¥	36
158	9E	Pt	36
159	9F	f	36

Dec code	Hex code	IBM char	Sort seq	Dec code	Hex code	IBM char	Sort seq
160	A0	á	65	192	C0	└	
161	A1	í	73	193	C1	┘	
162	A2	ó	79	194	C2	┐	
163	A3	ú	85	195	C3	┌	
164	A4	ñ	78	196	C4	—	
165	A5	Ñ	78	197	C5	+	
166	A6	ā	166	198	C6	┌	
167	A7	ō	167	199	C7	┐	
168	A8	ı	63	200	C8	└	
169	A9	┌	169	201	C9	┐	
170	AA	└	170	202	CA	┘	
171	AB	½	171	203	CB	┐	
172	AC	¼	172	204	CC	┌	
173	AD	ı	33	205	CD	═	
174	AE	«	34	206	CE	≠	
175	AF	»	34	207	CF	┘	
176	B0	⋮		208	D0	┘	
177	B1	⋮		209	D1	┐	
178	B2	⋮		210	D2	┐	
179	B3	┌		211	D3	└	
180	B4	┘		212	D4	┐	
181	B5	┐		213	D5	┐	
182	B6	┐		214	D6	┐	
183	B7	┐		215	D7	┐	
184	B8	┐		216	D8	≠	
185	B9	≠		217	D9	┘	
186	BA			218	DA	└	
187	BB	┐		219	DB	■	
188	BC	┘		220	DC	■	
189	BD	┘		221	DD	■	
190	BE	┘		222	DE	■	
191	BF	┘		223	DF	■	

Dec code	Hex code	IBM char	Sort seq
224	E0	α	
225	E1	β	83
226	E2	Γ	
227	E3	Π	
228	E4	Σ	
229	E5	σ	
230	E6	μ	
231	E7	Υ	
232	E8	Φ	
233	E9	Θ	
234	EA	Ω	
235	EB	δ	
236	EC	ϕ	
237	ED	ϕ	
238	EE	E	
239	EF	Λ	
240	F0	Ξ	
241	F1	\pm	
242	F2	\geq	
243	F3	\leq	
244	F4	\int	
245	F5	J	
246	F6	\div	
247	F7	\approx	
248	F8	\circ	
249	F9	■	
250	FA	■	
251	FB	$\sqrt{\quad}$	
252	FC	η	
253	FD	2	
254	FE	■	
255	FF		

Appendix I

Wireless LAN

This appendix is intended to help you get your Wireless LAN network up and running, with a minimum of parameters.

Card specifications

Form Factor	■ Mini PCI Typelll
Capability	<ul style="list-style-type: none"> ■ IEEE 802.11 Standard for Wireless LANS (DSSS) ■ Wi-Fi (Wireless Fidelity) certified by the Wireless Ethernet Compatibility Alliance (WECA)
Network Operating System	■ Microsoft Windows® Networking
Media Access Protocol Data Rate	<ul style="list-style-type: none"> ■ CSMA/CA (Collision Avoidance) with Protocol Acknowledgment (ACK) ■ 54/48/36/24/18/12/9/6 Mb/s (Revision A) ■ 11/5.5/2/1 Mb/s (Revision B) ■ 108/96/72/48/36/24/18/12 Mb/s (Turbo Mode)

Radio characteristics

Radio characteristics of Wireless LAN cards may vary according to:

- Country/region where the product was purchased
- Type of product

Wireless communication is often subject to local radio regulations. Although Wireless LAN wireless networking products have been designed for operation in the license-free 2.4 GHz and 5 GHz band, local radio regulations may impose a number of limitations to the use of wireless communication equipment.



Refer to the sheet *Information to the User for regulatory information that may apply in your country/region.*

R-F Frequency	<ul style="list-style-type: none"> ■ Band 5 GHz (5150-5850 MHz) (Revision A, Turbo Mode) ■ Band 2.4 GHz (2400-2483.5 MHz) (Revision B)
Modulation Technique	<p>Direct Sequence Spread Spectrum</p> <ul style="list-style-type: none"> ■ CCK, DQPSK, DBPSK (Revision B) ■ OFDM-BPSK, OFDM-QPSK, OFDM-16QAM, OFDM-64QAM (Revision A, Turbo Mode)

The range of the wireless signal is related to the transmit rate of the wireless communication. Communications at lower transmit range may travel larger distances.

- The range of your wireless devices can be affected when the antennas are placed near metal surfaces and solid high-density materials.
- Range is also affected by “obstacles” in the signal path of the radio signals that may either absorb or reflect the radio signal.

Supported frequency sub-bands

Subject to the radio regulations that apply in your country/region, your Wireless LAN card may support a different set of 5 GHz/2.4 GHz channels.

Consult your Authorized Wireless LAN or TOSHIBA Sales office for information about the radio regulations that apply in your country/region.

Wireless IEEE 802.11 Channels Sets (Revision B)

Frequency Range	Channel ID	2400-2472 MHz
	1	2412
	2	2417
	3	2422
	4	2427
	5	2432
	6	2437
	7	2442
	8	2447
	9	2452
	10	2457*
	11	2462

* Factory-set default channels

When installing Wireless LAN cards, the channel configuration is managed as follows:

- For wireless clients that operate in a Wireless LAN Infrastructure, the Wireless LAN card will automatically start operation at the channel identified by the Wireless LAN Access Point. When roaming between different access points the station can dynamically switch to another channel if required.
- For Wireless LAN cards installed in wireless clients operating in a peer-to-peer mode, the card will use the default channel 10.
- In a Wireless LAN Access Point, the Wireless LAN card will use the factoryset default channel (printed in bold), unless the LAN Administrator selected a different channel when configuring the Wireless LAN Access Point device.

Wireless IEEE 802.11 Channels Sets (Revision A)

Frequency Range	Channel ID	5150-5850 MHz	Note
	36	5180	
	40	5200	
	44	5220	
	48	5240	
	52	5260	
	56	5280	
	60	5300	
	64	5320	
	149	5745	US only *
	153	5765	US only *
	157	5785	US only *
	161	5805	US only *

* Available Area: US (USA, CANADA) only

A peer-to-peer mode is available under the following condition:

A Wireless LAN card receives a "US county/region code" beacon of the standard IEEE 802.11 (Revision D) from a Wireless LAN Access Point.

Wireless Channels Sets (Turbo Mode)

Frequency Range	Channel ID	5150-5850 MHz	Note
	42	5210	US only *
	50	5250	US only *
	58	5290	US only *
	152	5760	US only *
	160	5800	US only *

* Available Area: US (USA, CANADA) only

Glossary

The terms in this glossary cover the topics discussed in this manual. Alternate naming is included for reference.

Abbreviations

AC:	alternating current
AGP:	accelerated graphics port
ANSI:	American National Standards Institute
APM:	advanced power manager
ASCII:	American Standard Code for Information Interchange
BIOS:	basic input output system
CMOS:	complementary metal-oxide semiconductor
CPU:	central processing unit
CRT:	cathode ray tube
DC:	direct current
DDC:	display data channel
DOS:	disk operating system
DMA:	direct memory access
DRAM:	dynamic random access memory
DSVD:	Digital Simultaneous Voice and Data
DVD:	Digital Versatile Disc
DVI:	Digital Visual Interface
ECP:	extended capabilities port
EGA:	enhanced graphics adapter
FDD:	floppy disk drive
FIR:	fast infrared
HDD:	hard disk drive
IDE:	integrated drive electronics
I/O:	input/output
IrDA:	Infrared Data Association

IRQ:	interrupt request
KB:	kilobyte
LCD:	liquid crystal display
LED:	light emitting diode
LSI:	large scale integration
MDA:	monochrome display adapter
MPEG:	moving picture coding experts group
MS-DOS:	Microsoft Disk Operating System
OCR:	optical character recognition (reader)
PCB:	printed circuit board
PCI:	peripheral component interconnect
PCMCIA:	Personal Computer Memory Card International Association
RAM:	random access memory
RGB:	red, green, and blue
ROM:	read only memory
RTC:	real time clock.
SCSI:	small computer system interface
SIO:	serial input/output
SO-DIMM:	small-outline dual in-line memory module
SVGA:	super video graphics adapter
SDRAM:	synchronized dynamic random access memory
TFT:	thin-film transistor
UART:	universal asynchronous receiver/transmitter
USB:	Universal Serial Bus
VESA:	Video Electronic Standards Association
VGA:	video graphics array
VRM:	video ready modem
VRT:	voltage reduction technology

A

- AccuPoint II:** A pointing device integrated into the TOSHIBA computer keyboard.
- adapter:** A device that provides an interface between two dissimilar electronic devices. For example, the AC adapter modifies the power from a wall outlet for use by the computer. This term also refers to the add-in circuit cards that control external devices, such as video monitors and magnetic tape devices.
- allocate:** To assign a space or function for a specific task.
- alphanumeric:** Keyboard characters including letters, numbers and other symbols, such as punctuation marks or mathematical symbols.
- alternating current (AC):** Electric current that reverses its direction of flow at regular intervals.
- analog signal:** A signal whose characteristics such as amplitude and frequency vary in proportion to (are an analog of) the value to be transmitted. Voice communications are analog signals.
- ANSI:** American National Standards Institute. An organization established to adopt and define standards for a variety of technical disciplines. For example, ANSI defined the ASCII standard and other information processing requirements.
- antistatic:** A material used to prevent the buildup of static electricity.
- application:** A group of programs that together are used for a specific task such as accounting, financial planning, spreadsheets, word processing, and games, etc.
- ASCII:** American Standard Code for Information Interchange. ASCII code is a set of 256 binary codes that represent the most commonly used letters, numbers, and symbols.
- async:** Short for asynchronous.
- asynchronous:** Lacking regular time relationship. As applied to computer communications, asynchronous refers to the method of transmitting data that does not require a steady stream of bits to be transmitted at regular time intervals.
- AUTOEXEC.BAT:** A batch file that executes a series of MS-DOS commands and programs each time you start the computer.

B

- backup:** A duplicate copy of files kept as a spare in case the original is destroyed.
- batch file:** A file that can be executed from the system prompt containing a sequence of operating system commands or executable files. See also AUTOEXEC.BAT.

- binary:** The base two number system composed of zeros and ones (off or on), used by most digital computers. The right most digit of a binary number has a value of 1, the next a value of 2, then 4, 8, 16, and so on. For example, the binary number 101 has a value of 5. *See also* ASCII.
- BIOS:** Basic Input Output System. The firmware that controls data flow within the computer. *See also* firmware.
- bit:** Derived from “binary digit,” the basic unit of information used by the computer. It is either zero or one. Eight bits is one byte. *See also* byte.
- Bluetooth:** A short-range radio technology designed to simplify wireless communication among computers, communication devices and the Internet.
- board:** A circuit board. An internal card containing electronic components, called chips, which perform a specific function or increase the capabilities of the system.
- boot:** Short for bootstrap. A program that starts or restarts the computer. The program reads instructions from a storage device into the computer’s memory.
- bps:** Bits per second. Typically used to describe the data transmission speed of a modem.
- buffer:** The portion of the computer’s memory where data is temporarily stored. Buffers often compensate for differences in the rate of flow from one device to another.
- bus:** An interface for transmission of signals, data or electric power.
- byte:** The representation of a single character. A sequence of eight bits treated as a single unit; also the smallest addressable unit within the system.

C

- cache memory:** High speed memory which stores data that increases processor speed and data transfer rate. When the CPU reads data from main memory, it stores a copy of this data in cache memory. The next time the CPU needs that same data, it looks for it in the cache memory rather than the main memory, which saves time. The computer has two cache levels. Level one is incorporated into the processor and level two resides in external memory.
- card:** Synonym for board. *See* board.
- CardBus:** An industry standard bus for 32-bit PC Cards.
- capacity:** The amount of data that can be stored on a magnetic storage device such as a diskette (floppy disk) or hard disk. It is usually described in terms of kilobytes (KB), where one KB = 1024 bytes and megabytes (MB), where one MB = 1024 KB.
- CD-ROM:** A Compact Disk-Read Only Memory is a high capacity disk that can be read from but not written to. The CD-ROM drive uses a laser, rather than magnetic heads, to read data from the disk.

- Centronics:** The printer manufacturer whose method of data transmission between a parallel printer and a computer has become an industry standard.
- CGA:** Color/graphics adapter. A video display protocol defined by the IBM Color/Graphics Monitor Adapter and its associated circuitry. This protocol supports two-color 640x200 and four-color 320x200 graphics, and 16-color 640x200 and 320x200 text modes.
- character:** Any letter, number, punctuation mark, or symbol used by the computer. Also synonymous with byte.
- chassis:** The frame containing the computer.
- chip:** A small semiconductor containing computer logic and circuitry for processing, memory, input/output functions and controlling other chips.
- CMOS:** Complementary Metal-Oxide Semiconductor. An electronic circuit fabricated on a silicon wafer that requires very little power. Integrated circuits implemented in CMOS technology can be tightly packaged and are highly reliable.
- cold start:** Starting a computer that is currently off (turning on the power).
- COM1, COM2, COM3 and COM4:** The names assigned to the serial and communication ports.
- commands:** Instructions you enter at the terminal keyboard that direct the actions of the computer or its peripheral devices.
- communications:** The means by which a computer transmits and receives data to and from another computer or device. See parallel interface; serial interface.
- compatibility:** 1) The ability of one computer to accept and process data in the same manner as another computer without modifying the data or the media upon which it is being transferred.
2) the ability of one device to connect to or communicate with another system or component.
- components:** Elements or parts (of a system) which make up the whole (system).
- computer program:** A set of instructions written for a computer that enable it to achieve a desired result.
- computer system:** A combination of hardware, software, firmware, and peripheral components assembled to process data into useful information.
- configuration:** The specific components in your system (such as the terminal, printer, and disk drives) and the settings that define how your system works. You use the Hardware Setup, MaxTime or HW Setup program to control your system configuration.
- control keys:** A key or sequence of keys you enter from the keyboard to initiate a particular function within a program.
- controller:** Built-in hardware and software that controls the functions of a specific internal or peripheral device (e.g. keyboard controller).
- co-processor:** A circuit built into the processor that is dedicated to intensive math calculations.

- CPS:** Characters per second. Typically used to indicate the transmission speed of a printer.
- CPU:** Central processing unit. The portion of the computer that interprets and executes instructions.
- CRT:** Cathode Ray Tube. A vacuum tube in which beams projected on a fluorescent screen-producing luminous spots. An example is the television set.
- cursor:** A small, blinking rectangle or line that indicates the current position on the display screen.

D

- data:** Information that is factual, measurable or statistical that a computer can process, store, or retrieve.
- data bits:** A data communications parameter controlling the number of bits (binary digits) used to make up a byte. If data bits = 7 the computer can generate 128 unique characters. If data bits = 8 the computer can generate 256 unique characters.
- DC:** Direct Current. Electric current that flows in one direction. This type of power is usually supplied by batteries.
- default:** The parameter value automatically selected by the system when you or the program do not provide instructions. Also called a preset value.
- delete:** To remove data from a disk or other data storage device. Synonymous with erase.
- device driver:** A program that controls communication between a specific peripheral device and the computer. The CONFIG.SYS file contains device drivers that MS-DOS loads when you turn the computer on.
- dialog box:** A window that accepts user input to make system settings or record other information.
- disk drive:** The device that randomly accesses information on a disk and copies it to the computer's memory. It also writes data from memory to the disk. To accomplish these tasks, the unit physically rotates the disk at high speed past a read-write head.
- disk storage:** Storing data on magnetic disk. Data is arranged on concentric tracks much like a phonograph record.
- diskette:** A removable disk that stores magnetically encoded data used on a microcomputer. Also called floppy disk.
- diskette drive:** An electromechanical device that reads and writes to floppy disks. See *also* diskette.
- display:** A CRT, plasma screen, LCD, or other image producing device used to view computer output.

documentation: The set of manual and/or other instructions written for the users of a computer system or application. Computer system documentation typically includes procedural and tutorial information as well as system functions.

DOS: Disk operating system. See operating system.

driver: A software program, generally part of the operating system, that controls a specific piece of hardware (frequently a peripheral device such as a printer or mouse).

E

echo: To send back a reflection of the transmitted data to the sending device. You can display the information on the screen, or output it to the printer, or both. When a computer receives back data it transmitted to a CRT (or other peripheral device) and then retransmits the data to the printer, the printer is said to echo the CRT.

EGA: Enhanced Graphics Adapter. A video display protocol defined by the IBM Enhanced Graphics Adapter and its associated circuitry for direct drive TTL displays that supports 16-color/monochrome 640x350 and 16-color 640x200 and 320x200 graphics, and 16-color 640x350 and 320x350 text modes.

erase: See delete.

escape: 1) A code (ASCII code 27), signaling the computer that what follows are commands; used with peripheral devices such as printers and modems.

2) A means of aborting the task currently in progress.

escape guard time: A time before and after an escape code is sent to the modem which distinguishes between escapes that are part of the transmitted data, and escapes that are intended as a command to the modem.

execute: To interpret and execute an instruction.

Extended Capability Port: An industry standard that provides a data buffer, switchable forward and reverse data transmission, and run length encoding (RLE) support.

F

fast infrared: An industry standard that enables cableless infrared serial data transfer at speeds of up to 4 Mbps.

file: A collection of related information; a file can contain data, programs, or both.

firmware: A set of instructions built into the hardware which controls and directs a microprocessor's activities.

fixed disk: See hard disk.

floppy disk: See diskette.

floppy disk drive (FDD): See diskette drive.

Fn-esse: A TOSHIBA utility that lets you assign functions to hotkeys.

format: The process of readying a blank disk for its first use. Formatting establishes the structure of the disk that the operating system expects before it writes files or programs onto the disk.

folder: An icon in Windows used to store documents or other folders.

function keys: The keys labeled **F1** through **F12** that tell the computer to perform certain functions.

G

gigabyte (GB): A unit of data storage equal to 1024 megabytes. *See also* megabyte.

GND: Ground. An RS-232C signal used in the exchange of data between a computer and serial device.

graphics: The use of drawings, pictures, or other images, such as charts or graphs, to present information.

H

hard disk: A non-removable disk usually referred to as drive C. Also called fixed disk.

hard disk drive (HDD): An electromechanical device that reads and writes a hard disk. *See also* hard disk.

hardware: The physical electronic and mechanical components of a computer system: typically, the computer itself, external disk drives, etc. *See also* software and firmware.

hertz: A unit of wave frequency that equals one cycle per second.

hexadecimal: The base 16 numbering system composed of the digits 0 through 9 and the letters A, B, C, D, E, and F.

host computer: The computer that controls, regulates, and transmits information to a device or another computer.

hot dock/undock: Connecting or disconnecting a device to or from the computer while the computer's power is turned on.

hotkey: The computer's feature in which certain keys in combination with the extended function key, **Fn**, can be used to set system parameters, such as speaker volume.

HW Setup: A TOSHIBA utility that lets you set the parameters for various hardware components.

I

icon: A small graphic image displayed on the screen or in the indicator panel. In Windows, an icon represents an object that the user can manipulate.

iLINK (IEEE1394): This port enables high-speed data transfer directly from external devices such as digital video cameras.

infrared port: A cableless communications capable of using infrared signals to send serial data.

input: The data or instructions you provide to a computer, communication device or other peripheral device from the keyboard or external or internal storage devices. The data sent (or output) by the sending computer is input for the receiving computer.

instruction: Statements or commands that specify how to perform a particular task.

interface: 1) Hardware and/or software components of a system used specifically to connect one system or device to another.

2) To physically connect one system or device to another to exchange information.

3) The point of contact between user, the computer, and the program, for example, the keyboard or a menu.

interrupt request: A signal that gives a component access to the processor.

I/O: Input/output. Refers to acceptance and transfer of data to and from a computer.

I/O devices: Equipment used to communicate with the computer and transfer data to and from it.

J

jumper: A small clip or wire that allows you to change the hardware characteristics by electrically connecting two points of a circuit.

K

K: Taken from the Greek word kilo, meaning 1000; often used as equivalent to 1024, or 2 raised to the 10th power. *See also* byte and kilobyte.

KB: *See* kilobyte.

keyboard: An input device containing switches that are activated by manually pressing marked keys. Each keystroke activates a switch that transmits a specific code to the computer. For each key, the transmitted code is, in turn, representative of the (ASCII) character marked on the key.

kilobyte (KB): A unit of data storage equal to 1024 bytes. *See also* byte and megabit.

L

level 2 cache: See cache.

Light Emitting Diode (LED): A semiconductor device that emits light when a current is applied.

Liquid Crystal Display (LCD): Liquid crystal sealed between two sheets of glass coated with transparent conducting material. The viewing-side coating is etched into character forming segments with leads that extend to the edge of the glass. Applying a voltage between the glass sheets darkens the liquid crystal to provide contrast to lighted portions of the display.

LSI: Large Scale Integration. 1) A technology that allows the inclusion of up to 100,000 simple logic gates on a single chip.
2) An integrated circuit that uses the large scale integration.

M

main board: See motherboard.

MDA: Monochrome Display Adapter. A video display protocol defined by the IBM Monochrome Display Adapter and its associated circuitry for direct drive TTL displays that supports a monochrome 720x350 text mode.

megabyte (MB): A unit of data storage equal to 1024 kilobytes. See also kilobyte.

megahertz: A unit of wave frequency that equals 1 million cycles per second. See also hertz.

menu: A software interface that displays a list of options on the screen. Also called a screen.

microprocessor: A hardware component contained in a single integrated circuit that carries out instructions. Also called the central processing unit (CPU), one of the main parts of the computer.

MMX: Refers to microprocessors with additional instructions beyond the x86 standard. The instructions were developed on the basis of multimedia code requirements and thus improve the performance of multimedia applications.

mode: A method of operation, for example, the boot mode or the resume mode.

modem: Derived from modulator/demodulator, a device that converts (modulates) digital data for transmission over telephone lines and then converts modulated data (demodulates) to digital format where received.

monitor: A device that uses rows and columns of pixels to display alphanumeric characters or graphic images. See CRT.

motherboard: A name sometimes used to refer to the main printed circuit board in processing equipment. It usually contains integrated circuits that perform the processor's basic functions and provides connectors for adding other boards that perform special functions. Sometimes called a main board.

MPEG: Moving picture coding expert group is an industry standard architecture for compression of video signals.

N

non-system disk: A formatted diskette (floppy disk) you can use to store programs and data but you cannot use to start the computer. See system disk.

nonvolatile memory: Memory, usually read-only (ROM), that is capable of permanently storing information. Turning the computer's power off does not alter data stored in nonvolatile memory.

numeric keypad overlay: A feature that allows you to use certain keys on the keyboard to perform numeric entry, or to control cursor and page movement.

O

OCR: Optical Character Recognition (reader). A technique or device that uses laser or visible light to identify characters and input them into a storage device.

OCR wand: A device that reads, using an optical device, hand written or machine printed symbols into a computer. See *also* OCR.

on-line state: A functional state of a peripheral device when it is ready to receive or transmit data.

operating system: A group of programs that controls the basic operation of a computer. Operating system functions include interpreting programs, creating data files, and controlling the transmission and receipt (input/output) of data to and from memory and peripheral devices.

output: The results of a computer operation. Output commonly indicates data

- 1) printed on paper,
- 2) displayed at a terminal,
- 3) sent through the serial port of internal modem, or
- 4) stored on some magnetic media.

P

- parallel:** Refers to two or more processes or events that can occur simultaneously, and without interfering with each other. *See also* serial.
- parallel interface:** Refers to a type of information exchange that transmits information one byte (8 bits) at a time. *See also* serial interface.
- parity:** 1) The symmetrical relationship between two parameter values (integers) both of which are either on or off; odd or even; 0 or 1.
2) In serial communications, an error detection bit that is added to a group of data bits making the sum of the bits even or odd. Parity can be set to none, odd, or even.
- password:** A unique string of characters used to identify a specific user. The computer provides various levels of password protection such as user, supervisor and eject.
- pel:** The smallest area of the display that can be addressed by software. Equal in size to a pixel or group of pixels. *See* pixel.
- peripheral component interconnect:** An industry standard 32-bit bus.
- peripheral device:** An I/O device that is external to the central processor and/or main memory such as a printer or a mouse.
- plug and play:** A capability with Windows that enables the system to automatically recognize connections of external devices and make the necessary configurations in the computer.
- pixel:** A picture element. The smallest dot that can be made on a display or printer. Also called a pel.
- port:** The electrical connection through which the computer sends and receives data to and from devices or other computers.
- Port Replicator:** Devices that enables one-point connection to a number of peripheral devices and provides additional ports and slots.
- printed circuit board (PCB):** A hardware component of a processor to which integrated circuits and other components are attached. The board itself is typically flat and rectangular, and constructed of fiberglass, to form the attachment surface.
- program:** A set of instructions a computer can execute that enables it to achieve a desired result. *See also* application.
- prompt:** A message the computer provides indicating it is ready for or requires information or an action from you.

R

- Radio frequency interference (RFI) shield:** A metal shield enclosing the printed circuit boards of the printer or computer to prevent radio and TV interference. All computer equipment generates radio frequency signals. The FCC regulates the amount of signals a computing device can allow past its shielding. A Class A device is sufficient for office use. Class B provides a more stringent classification for home equipment use. TOSHIBA portable computers comply with Class B computing device regulations.
- Random Access Memory (RAM):** High speed memory within the computer circuitry that can be read or written to.
- restart:** Resetting a computer without turning it off (also called 'warm boot' or 'soft reset'). To restart the computer, press **Ctrl + Alt + Del** while the computer is on. *See also* boot.
- RCA jack:** A single-pin connector that carries composite video signals, which include both contrast and color information. *See also* S-video.
- RGB:** Red, green, and blue. A device that uses three input signals, each activating an electron gun for a primary additive color (red, green, and blue) or port for using such a device. *See also* CRT.
- RJ11:** A modular telephone jack.
- ROM:** Read Only Memory: A nonvolatile memory chip manufactured to contain information that controls the computer's basic operation. You cannot access or change information stored in ROM.
- RS-232C:** The Electronic Industries Association (EIA) interface standard that describes the 25-pin connector interface and control, data, and status signals that allow asynchronous communications between computers, printers, communications and other peripheral devices.

S

- SCSI:** Small Computer System Interface is an industry standard interface for connection of a variety of peripheral devices.
- serial:** The handling of data bits one after the other.
- serial communications:** A communications technique that uses as few as two interconnecting wires to send bits one after another.
- serial interface:** Refers to a type of information exchange that transmits information sequentially, one bit at a time. Contrast: Parallel interface.
- serial port:** A communications port to which you can connect devices, such as a modem, mouse, or serial printer.
- SIO:** Serial Input/Output. The electronic methodology used in serial data transmission.

- soft key:** Key combinations that emulate keys on the IBM keyboard, change some configuration options, stop program execution, and access the numeric keypad overlay.
- software:** The set of programs, procedures and related documentation associated with a computer system. Specifically refers to computer programs that direct and control the computer system's activities. *See also* hardware.
- stop bit:** One or more bits of a byte that follow the transmitted character or group codes in asynchronous serial communications.
- subpixel:** Three elements, one red, one green and blue (RGB), that make up a pixel on the color LCD. The computer sets subpixels independently, each may emit a different degree of brightness. *See also* pixel.
- S-video:** This connection provides separate lines for contrast and color, which produces a video image superior to that produced by a composite connection. *See also* RCA jack.
- synchronous:** Having a constant time interval between successive bits, characters or events.
- system disk:** A disk that has been formatted with an operating system. For MS-DOS the operating system is contained in two hidden files and the COMMAND.COM file. You can boot a computer using a system disk. Also called an operating system disk.

T

- terminal:** A typewriter-like keyboard and CRT display screen connected to the computer for data input/output.
- TFT:** A color LCD technology that applies individual transistors to each pixel enabling fine display control and excellent screen legibility.
- TTL:** Transistor-transistor logic. A logic circuit design that uses switching transistors for gates and storage.

U

- USB:** Enables chain connection of a number of USB-equipped devices to one port on your computer. For example, you might connect a USB-HUB to the computer, then connect a keyboard to the USB-HUB and a mouse to the keyboard.

V

- VGA:** Video graphics array is an industry standard video adapter that lets you run any popular software.
- volatile memory:** Random access memory (RAM) that stores information as long as the computer is connected to a power source.

W

Warm dock/undock: Connecting or disconnecting a device to or from the computer while the computer is suspended.

warm start: Restarting or resetting a computer without turning it off.

window: A portion of the screen that can display its own application or document. Often used to mean a Microsoft Windows window.

Wireless LAN: A short-range radio technology designed to simplify wireless communication with other LAN systems based on Direct Sequence Spread Spectrum radio technology that complies with the IEEE 802.11 Standard (Revision B).

write protection: A method for protecting a diskette (floppy disk) from accidental erasure.

Index

5 1/4" disk drive, 2-4

A

AC adaptor, 1-5, 2-17
 Connecting, 3-5
 AccuPoint II, 1-4, 2-8
 control buttons, 2-8
 precautions, 4-1
 Using, 4-1

Advanced Port Replicator, 8-8
 ASCII Character Codes, H-1
 ASCII characters, 5-8, H-1

B

Battery
 additional, 8-6
 indicators, 6-3
 Main battery, 6-4
 Real time clock, 6-5
 real time clock battery, 1-5
 Replacing, 6-12
 save mode, 1-8
 Secondary battery, 6-5
 types, 6-4
 Battery pack, 1-5, 2-6

C

Cache memory
 CPU cache, 1-3
 level 2 cache, 1-3
 CD/DVD drives
 CD-R/RW drive, 1-3
 CD-RW/DVD ROM drive, 1-3
 Certification agencies, B-3
 Cleaning the computer, 4-24
 Cooling, 1-9

D

Diskette drive, 1-3
 USB, 8-8
 Display, 1-4
 controller, 1-4
 Display controller, E-8
 Display modes, E-2
 Docking, 2-6

E

Equipment checklist, 1-1
 External monitor, 8-10

H

Hard disk drive, 1-3
 Heat dispersal, 4-25
 Hibernation, 1-8
 benefits, 3-8
 starting, 3-8
 Hotkey, 1-7, 1-11
 Hotkeys, 5-3
 HW Setup, 7-15

U

indicators
 Battery, 6-3
 DC IN, 6-4
 Infrared port, 2-2
 Internal Modem Guide, G-1

K

Keyboard, 1-4
 function keys, 5-2
 Soft Keys, 5-2
 Keyboard indicator, 2-10
 Keypad overlay, 1-7, 1-11

L

LAN, 1-6, 4-22
Loading discs, 4-6

M

Media care, 4-17
Memory, 1-3
 expansion, 1-10
Memory expansion, 8-3
Modem, 1-6, 4-18
 Specifications, A-2
Moving the computer, 4-24

O

Operating System, 1-7
Optical media drives, 4-6

P

Parallel printer, 8-9
Password
 power on, 1-8
PC card, 8-2
 Installing, 8-2
 Removing, 8-3
Plug and Play, 1-7, 1-10
Ports, 1-5
 DC IN 15V, 2-4
 expansion port, 1-5
 external monitor, 1-5, 2-4
 headphone, 1-5
 infrared, 1-5
 Infrared, 2-2
 LAN, 2-5
 Microphone, 2-1
 Parallel, 2-4
 Serial, 2-5
 Universal Serial Bus, 1-5
Power
 Auto power on, 1-8
 Display automatic power off,
 1-7
 HDD automatic power off,
 1-7
 panel power on/off, 1-8
 Requirements, A-1
 restarting the computer, 3-10
 System automatic power off,
 1-7
 Turning off, 3-7
 Turning on, 3-6
Power button, 2-8
Power conditions, 6-1

Power indicators, 6-3

Problems

 CD-RW drive, 9-9
 Diskette drive, 9-10
 DVD-ROM drive, 9-8
 Hard disk drive, 9-7
 Hibernation, 9-17
 Infrared port, 9-11
 Keyboard, 9-6
 LAN, 9-17
 LCD panel, 9-7
 Modem, 9-16
 Monitor, 9-14
 Password, 9-6
 PC card, 9-14
 Pointing device, 9-11
 Power, 9-4
 AC power, 9-5
 Battery, 9-5
 Overheating, 9-4
 Printer, 9-11
 Sound system, 9-14
 support from Toshiba, C-1
 TV output signal, 9-15
 USB, 9-15
 Wireless LAN, 9-17
Processor, 1-2
PS/2
 keyboard, 8-12
 mouse, 8-11

R

Removing discs, 4-9
Restarting the computer, 3-10
Restoring the Windows system,
 3-10

S

Security lock, 1-11, 8-12
Select Bay, 1-6
SelectBay
 Changing modules, 4-4
Slim Select Bay
 2nd battery pack, 2-16
 CD-RW/DVD-ROM drive,
 2-13
 DVD Multi drive, 2-14
 DVD-ROM drive, 2-12
 HDD adaptor, 2-16
 modules, 2-12
Slim Select Bay options, 1-11

- Soft Keys
 - Alt Gr Key Combinations, 5-2
- Sound system
 - volume control, 2-3
- Sound System, 1-6
- Speaker, 2-8
- Specifications, A-1
 - Built-in Modem, A-2
 - Environmental Requirements, A-1
 - Physical Dimensions, A-1
 - Power Requirements, A-1
- Standby, 1-8
- Standby mode, 3-9
- Stolen computer, F-3
- Support, 9-18

T

- Television, 8-11
- The Keyboard, 5-26
- TOSHIBA Utilities, 1-7, 1-9
- Typewriter keys, 5-26

U

- USB diskette drive, 2-11, 4-3

W

- Windows special keys, 5-6
- Wireless communication
 - switch, 2-2
- Wireless LAN, 1-7, 1-6, 4-21
- Work space
 - Setting up, 3-2
- Writing CD/DVDs, 4-13
- Writing CDs, 4-11