

Satellite[®] 2430/2435 Series User's Guide

If you need assistance:

- ❖ InTouch[®] Center
Calling within the United States (800) 457-7777
Calling from outside the United States (949) 859-4273

For more information, see [“If Something Goes Wrong”](#) on [page 179](#) in this guide.

Model: Satellite 2430/2435

ReWritable CD/DVD Drives

The computer system you purchased may include a ReWritable CD and/or DVD drive(s), among the most advanced data storage technologies available. As with any new technology, you must read and follow all set-up and usage instructions in the applicable user guides and/or manuals enclosed. If you fail to do so, this product may not function properly and you may lose data or suffer other damage. TOSHIBA AMERICA INFORMATION SYSTEMS (“TOSHIBA”), ITS AFFILIATES AND SUPPLIERS DO NOT WARRANT THAT OPERATION OF THE PRODUCT WILL BE UNINTERRUPTED OR ERROR FREE. YOU AGREE THAT TOSHIBA, ITS AFFILIATES AND SUPPLIERS SHALL HAVE NO RESPONSIBILITY FOR DAMAGE TO OR LOSS OF ANY BUSINESS, PROFITS, PROGRAMS, DATA OR REMOVABLE STORAGE MEDIA ARISING OUT OF OR RESULTING FROM THE USE OF THE PRODUCT, EVEN IF ADVISED OF THE POSSIBILITY THEREOF.

Protection of Stored Data

For your important data, please make periodic back-up copies of all the data stored on the hard disk or other storage devices as a precaution against possible failures, alteration, or loss of the data. **IF YOUR DATA IS ALTERED OR LOST DUE TO ANY TROUBLE, FAILURE OR MALFUNCTION OF THE HARD DISK DRIVE OR OTHER STORAGE DEVICES AND THE DATA CANNOT BE RECOVERED, TOSHIBA SHALL NOT BE LIABLE FOR ANY DAMAGE OR LOSS OF DATA, OR ANY OTHER DAMAGE RESULTING THEREFROM. WHEN COPYING OR TRANSFERRING YOUR DATA, PLEASE BE SURE TO CONFIRM WHETHER THE DATA HAS BEEN SUCCESSFULLY COPIED OR TRANSFERRED. TOSHIBA DISCLAIMS ANY LIABILITY FOR THE FAILURE TO COPY OR TRANSFER THE DATA CORRECTLY.**

Critical Applications

The computer you have purchased is not designed for any “critical applications.” “Critical applications” means life support systems, medical applications, connections to implanted medical devices, commercial transportation, nuclear facilities or systems or any other applications where product failure could lead to injury to persons or loss of life or catastrophic property damage. **ACCORDINGLY, TOSHIBA, ITS AFFILIATES AND SUPPLIERS DISCLAIM ANY AND ALL LIABILITY ARISING OUT OF THE USE OF THE COMPUTER PRODUCTS IN**

ANY CRITICAL APPLICATIONS. IF YOU USE THE COMPUTER PRODUCTS IN A CRITICAL APPLICATION, YOU, AND NOT TOSHIBA, ASSUME FULL RESPONSIBILITY FOR SUCH USE.

FCC Notice

This equipment has been tested and found to comply with the limits for a Class B digital device, pursuant to Part 15 of the FCC rules. These limits are designed to provide reasonable protection against harmful interference in a residential installation.

This equipment generates, uses and can radiate radio frequency energy and, if not installed and used in accordance with the instructions, it may cause harmful interference to radio communications. However, there is no guarantee that interference will not occur in a particular installation. If this equipment does cause harmful interference to radio or television reception, which can be determined by turning the equipment off and on, the user is encouraged to try to correct the interference by one or more of the following measures:

- ❖ Reorient or relocate the receiving antenna.
- ❖ Increase the separation between the equipment and receiver.
- ❖ Connect the equipment to an outlet on a circuit different from that to which the receiver is connected.
- ❖ Consult the dealer or an experienced radio/TV technician for help.



NOTE: Only Peripherals complying with the FCC Class B limits may be attached to this equipment. Operation with noncompliant peripherals or peripherals not recommended by Toshiba is likely to result in interference to radio and TV reception. Shielded cables must be used between the external devices and the computer's or expansion unit's serial port, parallel port, monitor port, USB port, PS/2 port®, i.LINK® port and microphone jack. Changes or modifications made to this equipment not expressly approved by Toshiba or parties authorized by Toshiba could void the user's authority to operate the equipment.

This device complies with Part 15 of the FCC Rules. Operation is subject to the following two conditions:

- ❖ This device may not cause harmful interference.
- ❖ This device must accept any interference received, including interference that may cause undesired operation.

4

Contact:

Toshiba America Information Systems, Inc.
9740 Irvine Blvd.
Irvine, CA 92618-1697
(949) 583-3000

Industry Canada Requirement

This Class B digital apparatus complies with Canadian ICES-003.

Cet appareil numérique de la classe B est conforme à la norme NMB-003 du Canada.

FCC Requirements

The following information is pursuant to FCC CFR 47, Part 68 and refers to internal modems.

Installation

When you are ready to install or use the modem, call your local telephone company and give them the following information:

- ❖ The telephone number of the line to which you will connect the modem.
- ❖ The FCC registration number of the modem.
- ❖ The ringer equivalence number (REN) of the modem, which is 0.6B.

The modem connects to the telephone line by means of a standard jack called the USOC RJ11C.

Type of Service

Your modem is designed to be used on standard-device telephone lines. Connection to telephone company-provided coin service (central office implemented systems) is prohibited. Connection to party lines service is subject to State tariffs. If you have any questions about your telephone line, such as how many pieces of equipment you can connect to it, the telephone company will provide this information upon request.

Telephone Company Procedures

The goal of the telephone company is to provide you with the best service it can. In order to do this, it may occasionally be necessary for them to make changes in their equipment, operations or procedures. If these changes might affect your service or the operation of your equipment, the telephone

company will give you notice, in writing, to allow you to make any changes necessary to maintain uninterrupted service.

If Problems Arise

If any of your telephone equipment is not operating properly, you should immediately remove it from your telephone line, as it may cause harm to the telephone network. If the telephone company notes a problem, they may temporarily discontinue service. When practical, they will notify you in advance of this disconnection. If advance notice is not feasible, you will be notified as soon as possible. When you are notified, you will be given the opportunity to correct the problem and informed of your right to file a complaint with the FCC. In the event repairs are ever needed on your modem, they should be performed by Toshiba Corporation, Toshiba America Information Systems, Inc. or an authorized representative of Toshiba.

Disconnection

If you should ever decide to permanently disconnect your modem from its present line, please call the telephone company and let them know of this change.

Fax Branding

The Telephone Consumer Protection Act of 1991 makes it unlawful to use a computer or other electronic device to send any message via a telephone fax machine unless such message clearly contains in a margin at the top or bottom of each transmitted page or on the first page of the transmission, the date and time it is sent and an identification of the business, other entity or individual sending the message and the telephone number of the sending machine or such business, other entity or individual.

In order to program this information into your fax modem, you should complete the setup for your fax software before sending a message.

Instructions for IC CS-03 certified equipment

- 1** NOTICE: The Industry Canada label identifies certified equipment. This certification means that the equipment meets certain telecommunications network protective, operational and safety requirements as prescribed in the appropriate Terminal Equipment Technical Requirements document(s). The Department does not guarantee the equipment will operate to the user's satisfaction.

Before installing this equipment, users should ensure that it is permissible to be connected to the facilities of the local telecommunications company. The equipment must also be installed using an acceptable method of connection. The customer should be

aware that compliance with the above conditions may not prevent degradation of service in some situations.

Repairs to certified equipment should be coordinated by a representative designated by the supplier. Any repairs or alterations made by the user to this equipment, or equipment malfunctions, may give the telecommunications company cause to request the user to disconnect the equipment.

Users should ensure for their own protection that the electrical ground connections of the power utility, telephone lines and internal metallic water pipe system, if present, are connected together. This precaution may be particularly important in rural areas.

Caution: Users should not attempt to make such connections themselves, but should contact the appropriate electric inspection authority, or electrician, as appropriate.

- 2 The user manual of analog equipment must contain the equipment's Ringer Equivalence Number (REN) and an explanation notice similar to the following:

The Ringer Equivalence Number (REN) of this device can be found on the label affixed to your computer.

NOTICE: The Ringer Equivalence Number (REN) assigned to each terminal device provides an indication of the maximum number of terminals allowed to be connected to a telephone interface. The termination on an interface may consist of any combination of devices subject only to the requirement that the sum of the Ringer Equivalence Numbers of all the devices does not exceed 5.

- 3 The standard connecting arrangement (telephone jack type) for this equipment is jack type(s): USOC RJ11C.

Wireless Interoperability

The TOSHIBA Wireless LAN Mini PCI Card products are designed to be interoperable with any wireless LAN product that is based on Direct Sequence Spread Spectrum (DSSS) radio technology, and is compliant to:

- ❖ The IEEE 802.11 Standard on Wireless LANs (Revision A/B), as defined and approved by the Institute of Electrical and Electronics Engineers.
- ❖ The Wireless Fidelity (WiFi) certification as defined by the WECA Wireless Ethernet Compatibility Alliance.

Caution

Bluetooth™ and Wireless LAN devices operate within the same radio frequency range and may interfere with one another. If you use Bluetooth™ and Wireless LAN devices simultaneously, you may occasionally experience a less than optimal network performance or even lose your network connection.

If you should experience any such problem, immediately turn off either one of your Bluetooth™ or Wireless LAN.

Please contact Toshiba PC product support on web site <http://www.toshiba-europe.com/computers/tnt/bluetooth.htm> in Europe or <http://www.pcsupport.global.toshiba.com> in the United States for more information.

Caution

This device is restricted to indoor use due to its operation in the 5.15 to 5.85 GHz frequency range.

Wireless LAN and your Health

Wireless LAN products, like other radio devices, emit radio frequency electromagnetic energy. The level of energy emitted by Wireless LAN devices however is far much less than the electromagnetic energy emitted by wireless devices like for example mobile phones.

Because Wireless LAN products operate within the guidelines found in radio frequency safety standards and recommendations, TOSHIBA believes Wireless LAN is safe for use by consumers. These standards and recommendations reflect the consensus of the scientific community and result from deliberations of panels and committees of scientists who continually review and interpret the extensive research literature.

In some situations or environments, the use of Wireless LAN may be restricted by the proprietor of the building or responsible representatives of the organization. These situations may for example include:

- ❖ Using the Wireless LAN equipment on board of airplanes, or
- ❖ In any other environment where the risk of interference to other devices or services is perceived or identified as harmful.

If you are uncertain of the policy that applies on the use of wireless devices in a specific organization or environment (e.g. airports), you are encouraged to ask for authorization to use the Wireless LAN device prior to turning on the equipment.

Regulatory Information

The TOSHIBA Wireless LAN Mini PCI Card must be installed and used in strict accordance with the manufacturer's instructions as described in the user documentation that comes with the product. This device complies with the following radio frequency and safety standards.

Canada – Industry Canada (IC)

This device complies with RSS 210 of Industry Canada.

Operation is subject to the following two conditions: (1) this device may not cause interference, and (2) this device must accept any interference, including interference that may cause undesired operation of this device.

L'utilisation de ce dispositif est autorisée seulement aux conditions suivantes: (1) il ne doit pas produire de brouillage et (2) l'utilisateur du dispositif doit être prêt à accepter tout brouillage radioélectrique reçu, même si ce brouillage est susceptible de compromettre le fonctionnement du dispositif.

The term "IC" before the equipment certification number only signifies that the Industry Canada technical specifications were met.

IC: 248H-DPA3233W

This device has been designed to operate with an antenna having a maximum gain of 4.8dBi. Antenna having a higher gain is strictly prohibited per regulations of Industry Canada. The required antenna impedance is 50 ohms.

To reduce potential radio interference to other users, the antenna type and its gain should be so chosen that the equivalent isotropically radiated power (EIRP) is not more than that required for successful communication.

To prevent radio interference to the licensed service, this device is intended to be operated indoors and away from windows to provide maximum shielding. Equipment (or its transmit antenna) that is installed outdoors is subject to licensing.

Europe – EU Declaration of Conformity

This device complies with the essential requirements of the R&TTE Directive 1999/5/EC with essential test suites as per standards:

- ❖ EN 60950 Safety of Information Technology equipment
- ❖ ETS 300 328 Technical requirements for radio equipment
- ❖ ETS 300 826 General EMC requirements for radio equipment.

België/ Belgique:	<p>For outdoor usage only channel 10 (2457 MHz) and 11 (2462 MHz) is allowed.</p> <p>For private usage outside buildings across public grounds over less than 300m no special registration with IBPT/BIPT is required. Registration to IBPT/BIPT is required for private usage outside buildings across public grounds over more than 300m. An IBPT/BIPT license is required for public usage outside building. For registration and license please contact IBPT/BIPT.</p>
	<p>Gebruik buiten gebouw alleen op kanalen 10 (2457 MHz) en 11 (2462 MHz). Voor privé-gebruik buiten gebouw over publieke grond over afstand kleiner dan 300m geen registratie bij BIPT/IBPT nodig; voor gebruik over afstand groter dan 300m is wel registratie bij BIPT/IBPT nodig. Voor publiek gebruik buiten gebouwen is licentie van BIPT/IBPT verplicht. Voor registratie of licentie kunt u contact opnemen met BIPT.</p>
	<p>L'utilisation en extérieur est autorisé sur le canal 10 (2457 MHz) et 11 (2462 MHz). Dans le cas d'une utilisation privée, à l'extérieur d'un bâtiment, audessus d'un espace public, aucun enregistrement n'est nécessaire pour une distance de moins de 300m. Pour une distance supérieure à 300m un enregistrement auprès de l'IBPT est requise. Pour une utilisation publique à l'extérieur de bâtiments, une licence de l'IBPT est requise. Pour les enregistrements et licences, veuillez contacter l'IBPT.</p>
Deutschland:	<p>License required for outdoor installations. Check with reseller for procedure to follow.</p>
	<p>Anmeldung im Outdoor-Bereich notwendig, aber nicht genehmigungspflichtig. Bitte mit Händler die Vorgehensweise abstimmen.</p>
France:	<p>Restricted frequency band: only channels 10 and 11 (2457 MHz and 2462 MHz respectively) may be used in France. License required for every installation, indoor and outdoor installations. Please contact ART for procedure to follow.</p>
	<p>Bande de fréquence restreinte : seuls les canaux 10 à 11 (2457 et 2462 MHz respectivement) doivent être utilisés en France. Toute utilisation, qu'elle soit intérieure ou extérieure, est soumise à autorisation. Vous pouvez contacter l'Autorité de Régulation des Télécommunications (http://www.art-telecom.fr) pour la procédure à suivre.</p>

Italia:	License required for indoor use. Use with outdoor installations not allowed.
	E' necessaria la concessione ministeriale anche per l' uso interno. Verificare con i rivenditori la procedura da seguire. L'uso per installazione in esterni non e' permessa.
Nederland:	License required for outdoor installations. Check with reseller for procedure to follow.
	Licentie verplicht voor gebruik met buitenantennes. Neem contact op met verkoper voor juiste procedure.

USA-Federal Communications Commission (FCC)

This device complies with Part 15 of FCC Rules. Operation of the devices in a Wireless LAN System is subject to the following two conditions:

- ❖ This device may not cause harmful interference.
- ❖ This device must accept any interference that may cause undesired operation.

TOSHIBA is not responsible for any radio or television interference caused by unauthorized modification of the devices included with this TOSHIBA Wireless LAN Mini PCI Card, or the substitution or attachment of connecting cables and equipment other than specified by TOSHIBA.

The correction of interference caused by such unauthorized modification, substitution or attachment will be the responsibility of the user.

Caution: Exposure to Radio Frequency Radiation

The Toshiba Wireless LAN Mini PCI Card will be installed with one of two types of antennas. The both of antenna types, when installed are located at the upper edge of the LCD screen.

For both antennas, the radiated output power of the TOSHIBA Wireless LAN Mini PCI Card is far below the FCC radio frequency exposure limits. Nevertheless, the TOSHIBA Wireless LAN Mini PCI Card shall be used in such a manner that the potential for human contact during normal operation is minimized. In normal operating configuration, the LCD in the upright position, the distance between the antenna and the user should not be less than 20cm. The antenna(s) used for this transmitter must not be co-located or operating in conjunction with any other antenna or transmitter.

Antenna(s) used in 5.15-5.25GHz frequency band must be integral antenna which provide no access to the end user.

Refer to the Regulatory Statements as identified in the documentation that comes with those products for additional information.

Relevant transmitters include FCC IDs: CJ6UPA3233WL, CJ6UPA3232BT.

The installer of this radio equipment must ensure that the antenna is located or pointed such that it does not emit RF field in excess of Health Canada limits for the general population; consult Safety Code 6, obtainable from Health Canada's website www.hc-sc.gc.ca/rpb.

Caution: Radio Frequency Interference Requirements

This device is restricted to indoor use due to its operation in the 5.15 to 5.25 GHz frequency range. FCC requires this product to be used indoors for frequency range 5.15 to 5.25 GHz to reduce the potential for harmful interference to co-channel Mobile Satellite systems.

High power radars are allocated as primary users of the 5.25 to 5.35 GHz and 5.65 to 5.85 GHz bands. These radar stations can cause interference with and/or damage this device.

Taiwan

Article 14 Unless approved, for any model accredited low power radio frequency electric machinery, any company, trader or user shall not change the frequency, increase the power or change the features and functions of the original design.

Article 17 Any use of low power radio frequency electric machinery shall not affect the aviation safety and interfere with legal communications. In event that any interference is found, the use of such electric machinery shall be stopped immediately, and reusing of such products can be resumed until no interference occurs after improvement.

The legal communications mentioned in the above item refer to radio communications operated in accordance with telecommunication laws and regulations.

Low power radio frequency electric machinery shall resist against interference from legal communications or from industrial, scientific and medical radio emission electric machinery.

Using this equipment in Japan

In Japan, the frequency bandwidth of 2,400.2,483.5MHz for second-generation low-power data communication systems such as this equipment overlaps that of mobile object identification systems (premises radio station and specified low-power radio station).

1. Sticker

Please put the following sticker on devices incorporating this product.

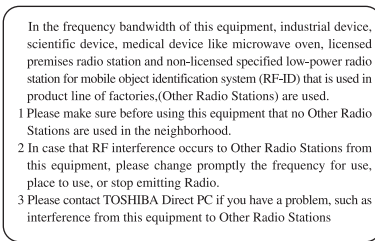

2. Indication

The indication shown below appears on this equipment.

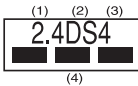

- 1 2.4 this equipment uses a frequency of 2.4GHz.
- 2 DS.This equipment uses DS-SS modulation.
- 3 The interference range of this equipment is less than 40m.
- 4 This equipment uses a frequency bandwidth from 2,400 MHz to 2,483.5 MHz.

It is possible to avoid the band of mobile object identification systems.

3. TOSHIBA Direct PC

Monday – Friday: 10:00 – 17:00

Toll Free Tel: 0120-13-1100

Direct Dial: 03-3457-5916

Fax: 03-5444-9450

Device Authorization

This device obtains the Technical Regulation Conformity Certification and the Technical Conditions Compliance Approval, and it belongs to the device class of radio equipment of low-power data communication system radio station stipulated in the Radio Law and the Telecommunications Business Law of Japan.

The Name of the radio equipment: PA3232U-1MPC

TELECOM ENGINEERING CENTER Approval Number: 03NY.A0018,
03GZDA0017

The following restrictions apply:

- ❖ Do not disassemble or modify the device.
- ❖ Do not install the embedded wireless module into other device.

Interference Statement

This equipment has been tested and found to comply with the limits for a Class B digital device, pursuant to Part 15 of the FCC Rules. These limits are designed to provide reasonable protection against harmful interference in a residential installation. This equipment generates, uses, and can radiate radio frequency energy. If not installed and used in accordance with the instructions, it may cause harmful interference to radio communications. However, there is no guarantee that interference will not occur in a particular installation.

If this equipment does cause harmful interference to radio or television reception, which can be determined by turning the equipment off and on, the user is encouraged to try and correct the interference by one or more of the following measures:

- ❖ Reorient or relocate the receiving antenna.
- ❖ Increase the distance between the equipment and the receiver.
- ❖ Connect the equipment to an outlet on a circuit different from that to which the receiver is connected.
- ❖ Consult the dealer or an experienced radio/TV technician for help.

Toshiba is not responsible for any radio or television interference caused by unauthorized modification of the devices included with this Toshiba Wireless LAN Mini PCI Card, or the substitution or attachment of connecting cables and equipment other than specified by Toshiba.

The correction of interference caused by such unauthorized modification, substitution or attachment will be the responsibility of the user.

Approved Countries for use

This equipment is approved to the radio standard by the countries in Fig.1.

Australia	Austria	Belgium
Canada	Denmark	Finland
Germany	Iceland	Ireland
Japan	Luxembourg	Netherlands
New Zealand	Norway	Sweden
Switzerland	UK	USA
Greece	Italy	France
Poland	Portugal	Spain

Caution: Do not use this equipment except in the countries in Fig.1.

DVD-ROM, Multifunction drive safety instructions

The DVD-ROM and Multifunction drives employ a laser system. To ensure proper use of this product, please read this instruction manual carefully and retain for future reference. Should the unit ever require maintenance, contact an authorized service location.

Use of controls, adjustments or the performance of procedures other than those specified may result in hazardous radiation exposure.

To prevent direct exposure to the laser beam, do not try to open the enclosure. enclosure.

Location of the required label

(Sample shown below. Location of the label and manufacturing information may vary.)

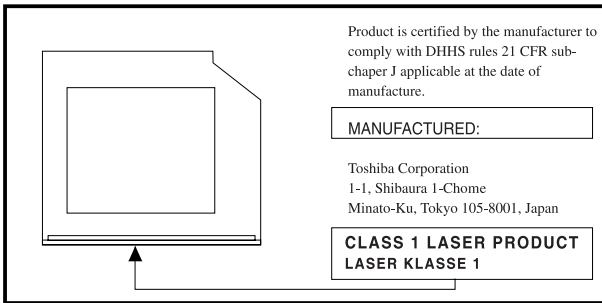

CAUTION: This appliance contains a laser system and is classified as a "CLASS 1 LASER PRODUCT." To use this model properly, read the instruction manual carefully and keep it for your future reference. In case of any trouble with this model, please contact your nearest "AUTHORIZED service station." To prevent direct exposure to the laser beam, do not try to open the enclosure.

CLASS 1 LASER PRODUCT
LASERKLASSE 1

Use of controls or adjustments or performance of procedures other than those specified in the owner's manual may result in hazardous radiation exposure.

Copyright

This guide is copyrighted by Toshiba America Information Systems, Inc. with all rights reserved. Under the copyright laws, this guide cannot be reproduced in any form without the prior written permission of Toshiba. No patent liability is assumed, however, with respect to the use of the information contained herein.

©2002 by Toshiba America Information Systems, Inc. All rights reserved.

Export Administration Regulation

This document contains technical data that may be controlled under the U.S. Export Administration Regulations, and may be subject to the approval of the U.S. Department of Commerce prior to export. Any export, directly or indirectly, in contravention of the U.S. Export Administration Regulations is prohibited.

Notice

The information contained in this manual, including but not limited to any product specifications, is subject to change without notice.

TOSHIBA CORPORATION AND TOSHIBA AMERICA INFORMATION SYSTEMS, INC. (TOSHIBA) PROVIDES NO WARRANTY WITH REGARD TO THIS MANUAL OR ANY OTHER INFORMATION CONTAINED HEREIN AND HEREBY EXPRESSLY DISCLAIMS ANY IMPLIED WARRANTIES OF MERCHANTABILITY OR FITNESS FOR ANY PARTICULAR PURPOSE WITH REGARD TO ANY OF THE FOREGOING. TOSHIBA ASSUMES NO LIABILITY FOR ANY DAMAGES INCURRED DIRECTLY OR INDIRECTLY FROM ANY TECHNICAL OR TYPOGRAPHICAL ERRORS OR OMISSIONS CONTAINED HEREIN OR FOR DISCREPANCIES BETWEEN THE PRODUCT AND THE MANUAL. IN NO EVENT SHALL TOSHIBA BE LIABLE FOR ANY INCIDENTAL, CONSEQUENTIAL, SPECIAL, OR EXEMPLARY DAMAGES, WHETHER BASED ON TORT, CONTRACT OR OTHERWISE, ARISING OUT OF OR IN CONNECTION WITH THIS MANUAL OR ANY OTHER INFORMATION CONTAINED HEREIN OR THE USE THEREOF.

Trademarks

Satellite, InTouch, and Noteworthy are registered trademarks, SelectServ, FreedomWare, and SmartMedia are trademarks, of Toshiba America Information Systems, Inc. and/or Toshiba Corporation.

Microsoft, Windows, DirectX, Active Desktop, and DirectShow are registered trademarks, and Windows Media is a trademark of Microsoft Corporation.

LapLink is a registered trademark of Traveling Software, Inc.

WinDVD is a trademark of InterVideo, Inc.

CompuServe is a registered trademark of America Online, Inc.

Dolby - Manufactured by Toshiba under license from Dolby Laboratories/ Dolby and the double-D symbol are trademarks of Dolby Laboratories.

TouchPad is a trademark of Synaptics, Inc.

All other brand and product names are trademarks or registered trademarks of their respective companies.

Computer Disposal Information

This product contains mercury. Disposal of this material may be regulated due to environmental considerations. For disposal, reuse or recycling information, please contact your local government or the Electronic Industries Alliance at www.eiae.org.

Contents

Introduction	25
This guide	25
Safety icons	26
Other icons used	27
Other documentation	27
Service options	28
Chapter 1: Finding Your Way Around	29
Making sure you have everything	29
Front with the display closed	30
Back	30
Right side	32
Left side	33
Front with the display open	34
Indicator lights	36
Underside	37

Chapter 2: Getting Started	39
Selecting a place to work	39
Creating a computer-friendly environment.....	39
Keeping yourself comfortable	40
Precautions.....	43
Setting up your computer	45
Setting up your software.....	45
Registering your computer with Toshiba	47
Adding external devices	47
Connecting the AC adapter.....	48
Charging the main battery.....	50
Using the computer for the first time	51
Opening the display panel	51
Turning on the power	51
Using the TouchPad™	52
Control buttons	53
Disabling or enabling the TouchPad.....	53
Installing additional memory (optional)	54
Removing a memory module.....	60
Connecting a mouse	60
Connecting a printer	61
Setting up a printer	62
Turning off the computer	65
Caring for your computer.....	66
Cleaning the computer	66
Moving the computer.....	67
Using a computer lock.....	67

Chapter 3: Learning the Basics.....	69
Computing tips	69
Using the keyboard	70
Character keys	71
Ctrl, Fn, and Alt keys	71
Function keys.....	71
Windows® special keys	72
Overlay keys.....	72
Starting a program.....	74
Saving your work.....	74
Printing your work	75
Backing up your files	76
Using the DVD-ROM or Multifunction drive.....	76
Drive components and control buttons.....	77
DVD-ROM drive components.....	77
CD/DVD control buttons	78
CD/DVD control and digital audio modes.....	79
Inserting a disc	80
Playing an audio CD	82
Playing a DVD	84
Viewing the contents of a CD or DVD.....	84
Removing a disc with the computer on.....	84
Removing a disc with the computer off	85
Caring for CDs and DVDs.....	85
Setting up for communications.....	86
Connecting the modem to a phone line.....	86
Connecting your computer to a network.....	86
Powering down the computer	87
Using Turn Off or Shut down	88
Hibernation command	89
Stand By command.....	90
Turning off more quickly	91
Starting again after Turn Off.....	92
Using Hibernation	92

Starting again from Hibernation mode	94
Using Stand by	94
Going into Stand by mode more quickly	95
Starting again from Stand by	96
Toshiba's online resources	96
Chapter 4: Mobile Computing	97
Toshiba's energy-saver design	97
Running the computer on battery power	98
Power management	99
Charging the battery	99
Charging the RTC battery	100
Monitoring battery power	101
Determining remaining battery power	101
Conserving battery power	102
What to do when the battery runs low	103
Setting battery alarms	104
Changing the main battery	105
Removing the battery from the computer	105
Taking care of your battery	106
Maximizing battery life	107
Disposing of used batteries safely	109
Traveling tips	110
Chapter 5: Getting to Know the Windows® XP Operating	
System	111
Lesson 1: Exploring the desktop	112
Finding your way around the desktop	112
Windows® XP file system	114
Lesson 2: Using the TouchPad and control buttons	
together	115
Lesson 3: Learning about the Internet	118
Lesson 4: Creating a new document	119
Lesson 5: Creating a new folder	120

Lesson 6: Starting programs	121
Lesson 7: Resizing, repositioning, and hiding windows	123
Using the taskbar	124
Minimizing and maximizing windows	124
Resizing and moving windows.....	125
Lesson 8: Closing programs	126
Lesson 9: Creating shortcuts	127
Creating a shortcut to the Calculator.....	127
Creating a shortcut to the Character Map	128
Lesson 10: Changing the screen saver.....	130
Lesson 11: Setting the date and time	132
Lesson 12: Removing objects from the desktop..	134
Lesson 13: Using System Restore	136
Lesson 14: If I am lost, what do I do?	137
Windows® XP Help and Support Center	137
Using the online tours and tutorials	139
Lesson 15: Turning off your computer.....	140
Chapter 6: Exploring Your Options	141
Windows® XP special features	141
Personalizing your desktop	142
Customizing the taskbar	142
Bringing the world to your desktop.....	143
Changing desktop and browsing style	144
Personalizing individual windows	145
Customizing window toolbars	146
Displaying information about each folder	147
Using your computer at the office.....	148
Setting up for communications.....	149
Connecting the modem to a telephone line	150
Setting up a dial-up connection	150
Exchanging data with another computer.....	151

Transferring files using a parallel port connection	151
Getting help transferring files.....	152
Connecting to the Internet	152
An overview of using the Internet	153
The Internet	153
The World Wide Web	154
Internet Service Providers.....	154
Signing up with an Internet Service Provider	154
Surfing the Internet.....	155
Internet features.....	155
Uploading and downloading files on the Internet	156
Exploring video features	157
Changing the display properties setting	157
Display settings hot key	158
Exploring audio features	158
Recording sounds.....	158
Using a microphone.....	159
Adjusting recording settings	160
Using external speakers or headphones.....	160
Connecting a monitor, keyboard and mouse	161
Using the Modular Bay.....	162
Removing a module from the Modular Bay....	162
Inserting a module into the Modular Bay	163
Using PC Cards.....	164
PC Card supporting software	164
Inserting PC Cards	164
Removing PC Cards	165
Hot swapping	166

Chapter 7: WinDVD™	167
Playing DVDs	167
Using the WinDVD control panel	170
Using WinDVD Advanced Features	174
Using playlists	175
Getting Help	178
Exiting WinDVD	178
Chapter 8: If Something Goes Wrong	179
Problems when you turn on the computer.....	182
The Windows® operating system is not working .	183
Using Startup options to fix problems	183
Internet problems	184
The Windows®XP operating system can help you	185
Resolving a hardware conflict.....	185
A plan of action.....	186
Resolving hardware conflicts on your own	186
Fixing a problem with Device Manager	188
Memory card problems.....	190
Power and the batteries	190
Keyboard problems.....	192
Display problems	192
Disk drive problems	194
DVD-ROM or multifunction drive problems ...	196
Sound system problems	204
PC Card problems.....	204
Printer problems.....	207
Modem problems.....	208
Develop good computing habits	209
If you need further assistance.....	210
Before you call	210
Contacting Toshiba	211
Other Toshiba Internet Web sites	212

Toshiba's worldwide offices	212
Appendix A: Hot Keys	215
Instant password security	215
Without a password	215
With a password	215
Maintaining security when the battery isn't fully charged	216
Sound	217
Power usage mode	217
Stand by mode	218
Hibernation mode	219
Display modes	220
Display modes	220
Enabling a wireless device	221
Disabling or enabling the TouchPad	221
Keyboard hot keys	222
Appendix B: Power Cable Connectors.....	223
Glossary	224
Index	239

Introduction

Welcome to the world of powerful and portable multimedia computers! With your new Toshiba notebook computer, your access to information can accompany you wherever you go.

You will find your operating system, Microsoft® Windows® XP already installed on your computer. Your operating system offers exciting features and easy Internet access.

This guide contains information about your operating system and how it functions with your Toshiba computer. For specific information on the software, see the Microsoft booklet that shipped with your computer.

This guide

This guide introduces the computer's features. You can:

- ❖ Read the entire guide from beginning to end.
- ❖ Skim through and stop when a topic interests you.
- ❖ Use the table of contents and the index to find specific information.

If you are new to computers, or have not used a notebook computer before, read through the first couple of chapters to familiarize yourself with the components of the computer and how to turn it on. After that, seek out whatever interests you most.

Safety icons

This manual contains safety instructions that must be observed in order to avoid potential hazards that could result in personal injuries, damage to your equipment, or loss of data. These safety cautions have been classified according to the seriousness of the risk, and the icons highlight these instructions as follows:



***DANGER:** This icon indicates the existence of a hazard that could result in death or serious bodily injury if the safety instruction is not observed.*



***WARNING:** This icon indicates the existence of a hazard that could result in bodily injury if the safety instruction is not observed.*



***CAUTION:** This icon indicates the existence of a hazard that could result in damage to equipment or property if the safety instruction is not observed.*



***NOTE:** This icon indicates information that relates to the safe operation of the equipment or related items.*

Other icons used

Additional icons highlight other helpful or educational information:



TECHNICAL NOTE: This icon highlights technical information about the computer.



HINT: This icon denotes helpful hints and tips.



DEFINITION: This icon indicates the definition of a term used in the text.

Other documentation

Your computer comes with the following documentation:

- ❖ This electronic user's guide. Look for the user's guide icon on your desktop or in the DOCS folder on the C: drive.
- ❖ Guides for other programs that may come preinstalled on your computer or that are available for installation on your Recovery CDs.
- ❖ For accessory information, visit Toshiba's web site at toshiba.com.
- ❖ The Microsoft® Windows® operating system documentation which explains the features of the operating system.

Service options

Toshiba offers a full line of service options built around its SelectServ™ warranty programs. For more information, visit Toshiba's Web site at toshiba.com.

If you have a problem or need to contact Toshiba, see “[If Something Goes Wrong](#)” on page 179.

Chapter 1

Finding Your Way Around

This chapter presents a “grand tour” of your notebook computer. It serves as a reference when you need to locate specific parts of the computer.

Making sure you have everything

Before doing anything else, consult the Quick Start card provided with your system to make sure you received everything. If any items are missing or damaged, notify your dealer immediately. For additional help, see [“If you need further assistance” on page 210.](#)

Front with the display closed

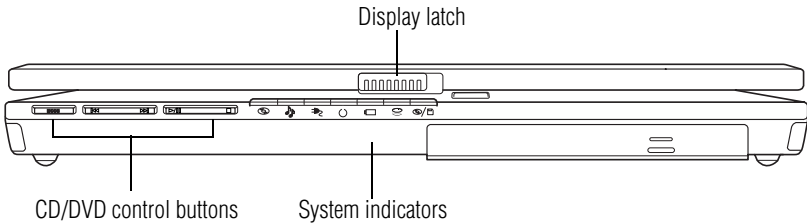

The **display latch** keeps the display panel closed and locked. To open the display panel, press the display latch and raise the panel.

The **CD/DVD control buttons** let you play audio CDs when the computer is turned off. You can also use them to play CDs and DVDs with the computer turned on. For more information, see “[CD/DVD control buttons](#)” on page 78.

Back

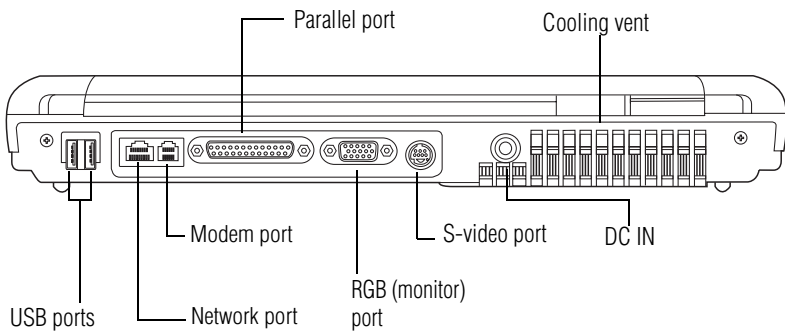

The **DC IN** port is where you plug in the AC adapter for either operating the computer on external power or charging the battery.



The **S-video port** lets you play DVD audio and video on a projector or TV that accepts video inputs.



The **RGB (monitor) port** lets you connect an external monitor.



The **parallel port** lets you connect a parallel printer or other parallel device, including ECP-compatible devices.



The **modem port** lets you use a standard RJ-11 telephone cable to connect the modem directly to a standard telephone line. For more information, see [“Connecting the modem to a phone line”](#) on page 86.



The **Network port** (RJ-45 jack) provides access to a Local Area Network (LAN) using a standard Ethernet® network cable.



The **USB (Universal Serial Bus) ports** allow you to connect USB peripherals to your computer.



DEFINITION: USB is a peripheral expansion standard that supports a data-transfer rate of up to 480 Mbps for peripherals such as keyboards, pointing devices, and monitors. USB peripherals have a single standard for cabling and connectors. The USB standard allows hot swapping of peripherals.

The **cooling vent** prevents the computer’s central processing unit (CPU) from overheating so that it can continue to perform at maximum speed.



CAUTION: To prevent possible overheating of the CPU, do not block the cooling vents.

Right side

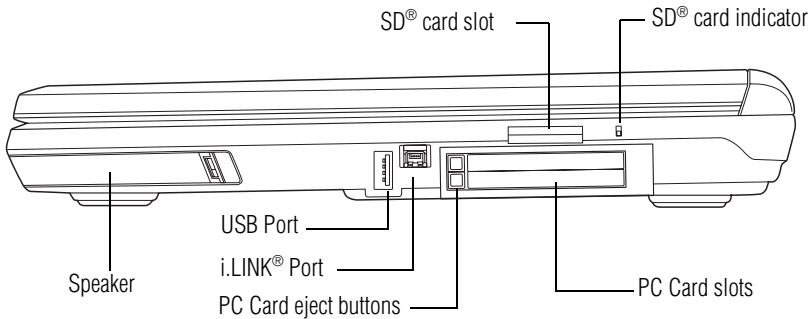

The two stacked **PC Card slots** support up to two Type I or Type II PC Cards, or one Type III PC Card. See [“Using PC Cards”](#) on page 164 for more information.

The **PC Card eject buttons** release PC Cards from the corresponding slots.



The **SD® card slot** holds a highly secure, stamp-size flash memory card with a capacity of 16 MB, 32 MB, 64 MB or 128 MB. The card can be used with a variety of digital I/O (input/output) products: digital music players, cellular phones, PDAs, digital cameras, and digital video camcorders.

The **SD card indicator** flashes when the drive is in use.

The **i.LINK® port**, also known as the IEEE 1394 port, allows transfers of large quantities of data between the computer and an external device, such as a video camera.



The **USB port** lets you connect a USB peripheral to your computer.

Left side

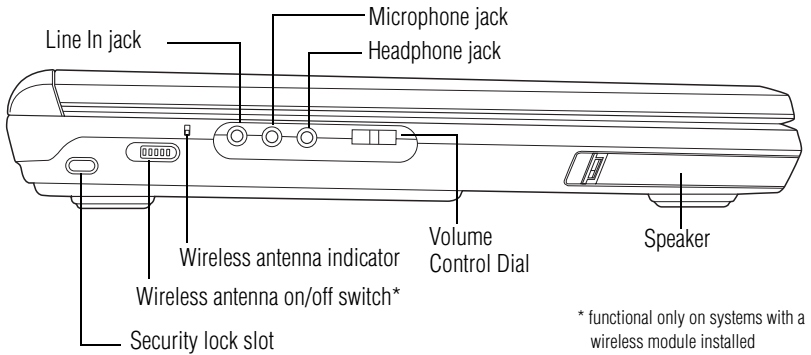

The 3.5 mm **headphone jack** lets you connect stereo headphones or other audio-output devices, such as external speakers. Connecting other devices automatically disables the internal speakers.



The 3.5 mm **microphone jack** lets you connect an external monaural microphone or other audio input device.

The **line in jack** lets you connect a DVD or CD player, cassette tape player, or record player to your computer.

The **volume control** lets you adjust the sound on your computer. To turn the volume up, turn the dial to the right. To turn the volume down, turn the dial to the left.



The **security lock slot** allows you to attach an optional PORT- Noteworthy[®] computer lock cable to your computer for securing it to a large, heavy object such as your desk.

On those systems with Wi-Fi[™], the **wireless antenna on/off switch** turns the computer's wireless antenna on or off. The Wi-Fi Mini PCI module is optional.

On those systems with Wi-Fi[™], the **wireless antenna indicator** glows amber when the computer's wireless antenna is on.

Front with the display open

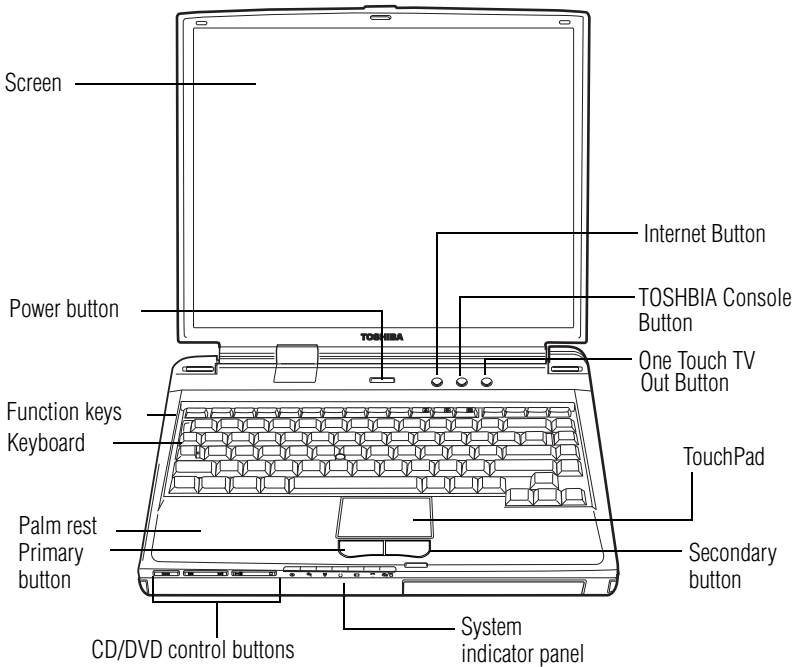

The computer's **screen** is a liquid crystal display (LCD) that provides clear, sharp images. For more information about viewing options, see [“Exploring video features” on page 157](#).



The **power button** turns the computer on and off. Holding down the power button for four seconds resets the computer.



The **Internet button** launches your default Internet browser.



The **TOSHIBA Console button** allows quick access to various functions.

The **One Touch TV out button** activates an external display device such as a TV when connected to the video/audio line out jack.

The 85-key **keyboard** provides all the functionality of a full-size keyboard. For more information, see [“Using the keyboard”](#) on page 70.

The **function keys**, when used with the Fn key, activate several different system functions. For more information, see [“Hot Keys”](#) on page 215.

The **system indicator panel** provides information about various system functions.

The **TouchPad™** enables you to move the cursor with the stroke of a finger.

The **primary and secondary buttons** below the TouchPad act like the buttons on a mouse, with primary and secondary functions.

The front panel provides a **palm rest** to assist you in maintaining proper posture while using the computer.

The **CD/DVD control buttons** let you play audio CDs when the computer is turned off. You can also use them to play CDs and DVDs with the computer turned on. For more information, see [“CD/DVD control buttons”](#) on page 78.

The stereo speakers let you hear sounds, such as system alarms associated with your software, and music from DVD-ROMs and audio CDs.

Indicator lights

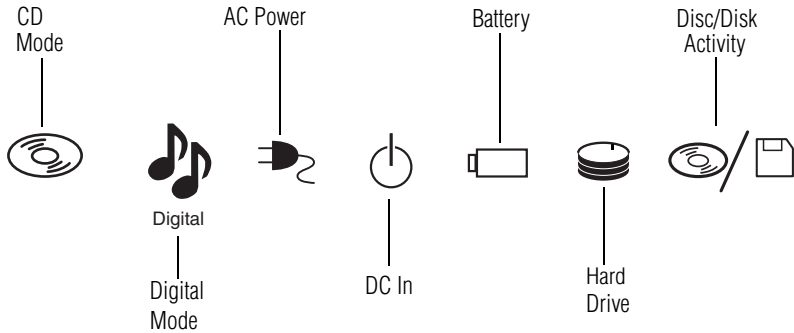

The **CD mode light** goes on in CD mode when the computer is playing a CD with the computer off.



The **digital mode light** goes on in digital mode, when the computer is playing a CD or DVD with the computer on.



The **DC In light** glows green when the computer is on. The light blinks when the computer is in Standby mode.



The **main battery light** indicates the main battery's current charge. It glows green when the battery is fully charged. It glows amber while the battery is being charged. It does not glow if the external power source is disconnected or if the battery is completely discharged. For more information on determining remaining battery power, see [“Monitoring battery power”](#) on page 101.



The **hard disk drive light** flashes while the hard disk drive is being accessed.



The **disc/disk activity light** flashes when the Modular Bay drive is being accessed.

The **caps lock light** glows when you press the Caps Lock key. When this light is on, pressing a letter key on the keyboard produces an uppercase (capital) letter.



The **cursor control mode light** glows when the cursor control overlay is on. When this light is on, pressing an overlay key moves the cursor in the direction of the white arrow printed on the key instead of typing the letter printed on the top of the key. For more information, see “Using the cursor control overlay” on page 73.



The **numeric mode light** glows when the numeric overlay is on. When this light is on, pressing an overlay key types the white number printed on the key instead of typing the letter printed on the top of the key. For more information, see “Using the numeric keypad overlay” on page 73.



CAUTION: Never turn off the computer while any drive is in use. Doing so may damage the media and result in loss of data.

Underside

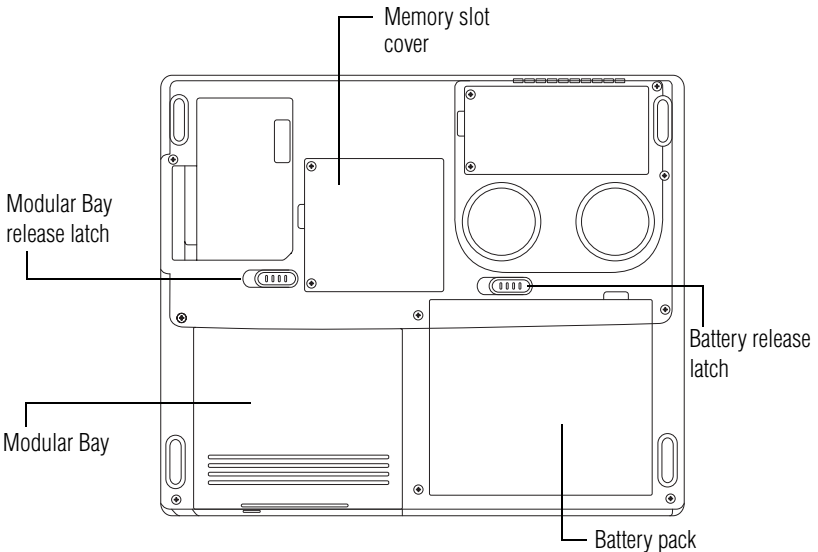

The **Modular Bay** lets you use one of several possible Modular Bay optical drive modules. A DVD-ROM drive is shown in place. For more information, see [“Using the Modular Bay” on page 162](#).

The **expansion memory slot cover** protects the two expansion memory slots where you insert additional memory. See for detailed information.

The **hard disk drive** is the computer’s permanent data storage device.



CAUTION: To prevent possible CPU overheating, do not block the cooling vents when the computer is in use.



The **battery pack** contains the battery. For information about replacing the battery, see [“Changing the main battery” on page 105](#).



The **battery release latch** secures the battery cover to the computer, preventing the cover from dislodging from the computer case.

Chapter 2

Getting Started

This chapter provides tips for working comfortably, describes how to connect components, and explains what to do the first time you use your notebook computer.

Selecting a place to work

Your computer is portable and designed to be used in a variety of circumstances and locations.

Creating a computer-friendly environment

Place the computer on a flat surface which is large enough for the computer and any other items you need to use, such as a printer. Leave enough space around the computer and other equipment to provide adequate ventilation and prevent overheating.

To keep your computer in prime operating condition, protect your work area from:

- ❖ Dust, moisture, and direct sunlight.

-
- ❖ Equipment that generates a strong electromagnetic field, such as stereo speakers (other than speakers that are connected to the computer) or speakerphones.
 - ❖ Rapid changes in temperature or humidity and sources of temperature change such as air conditioner vents or heaters.
 - ❖ Extreme heat, cold, or humidity.
 - ❖ Liquids and corrosive chemicals.
-



CAUTION: If you spill liquid into the computer, turn it off, unplug it from the AC power source, and let it dry out completely before turning it on again.

If the computer does not operate correctly after you turn it back on, contact a Toshiba authorized service provider.

Keeping yourself comfortable

Strain and stress injuries are becoming more common as people spend more time using their computers. With a little care and proper use of the equipment, you can work comfortably throughout the day.

This section provides hints on avoiding strain and stress injuries. For more information, consult books on ergonomics, repetitive-strain injury, and repetitive-stress syndrome.

Placement of the computer

Proper placement of the computer and external devices is important to avoid stress-related injuries.

- ❖ Place the computer on a flat surface at a comfortable height and distance. You should be able to type without twisting your torso or neck, and look at the screen without slouching.

- ❖ If you are using an external monitor, the top of the display should be no higher than eye level.
- ❖ If you use a paper holder, set it at about the same height and distance as the screen.

Seating and posture

When using your computer, maintain good posture with your body relaxed and your weight distributed evenly. Proper seating is a primary factor in reducing work strain. Some people find a backless chair more comfortable than a conventional chair.

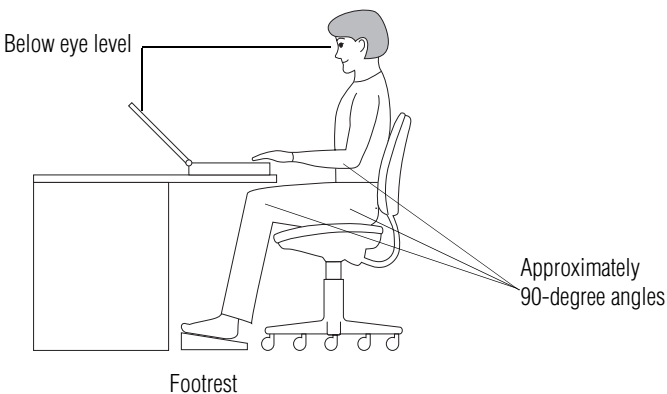

Correct posture and positioning of the computer

Whichever type you choose, use the following guidelines to adjust your chair for maximum computing comfort.

- ❖ Position your chair so that the keyboard is at or slightly below the level of your elbow. You should be able to type comfortably with your shoulders relaxed and your forearms parallel to the floor.

If you are using a conventional chair:

- ❖ Your knees should be slightly higher than your hips. If necessary, use a footrest to raise the level of your knees and ease the pressure on the back of your thighs.

- ❖ Adjust the back of your chair so that it supports the lower curve of your spine. If necessary, use a cushion to provide extra back support. Lower-back-support cushions are available at many office supply stores.
- ❖ Sit with your back straight so that your knees, hips, and elbows form approximately 90-degree angles when you work. Do not slump forward or lean back too far.

Lighting

Proper lighting can improve the visibility of the display and reduce eyestrain.

- ❖ Position the display panel or external monitor so that sunlight or bright indoor lighting does not reflect off the screen. Use tinted windows or shades to reduce glare.
- ❖ Avoid placing your computer in front of a bright light that could shine directly in your eyes.
- ❖ If possible, use soft, indirect lighting in your computer work area.

Arms and wrists

- ❖ Avoid bending, arching, or twisting your wrists. Keep them in a relaxed, neutral position while typing.
- ❖ Exercise your hands, wrists, and arms to improve circulation.



***WARNING:** Using the computer keyboard incorrectly may result in discomfort and possible injury. If your hands, wrists, and/or arms bother you while typing, stop using the computer and rest. If the discomfort persists, consult a physician.*

Work habits

The key to avoiding discomfort or injury from strain is to vary your activities. If possible, schedule a variety of tasks into your working day. Finding ways to break up the routine can reduce stress and improve your efficiency.

- ❖ Take frequent breaks to change position, stretch your muscles, and relieve your eyes. A break of two or three minutes every half hour is more effective than a long break after several hours.
- ❖ Avoid performing repetitive activities for long periods. Intersperse such activities with other tasks.
- ❖ Focusing your eyes on your computer screen for long periods can cause eyestrain. Look away from the computer frequently and focus your eyes on a distant object for at least 30 seconds.

Precautions

Your notebook computer is designed to provide optimum safety and ease of use, and to withstand the rigors of travel. You should observe certain precautions to further reduce the risk of personal injury or damage to the computer.

- ❖ Avoid prolonged physical contact with the underside of the computer.

If the computer is used for long periods, its case can become very warm. While the temperature may not feel too hot to the touch, if you maintain physical contact with the computer for a long time (if you rest the computer on your lap, for example), your skin might suffer low-heat injury.

- ❖ Never apply heavy pressure to the computer or subject it to sharp impacts. Excessive pressure or impact can damage computer components or otherwise cause your computer to malfunction.

- ❖ Some PC Cards can become hot with prolonged use. If two cards are installed, both can become hot even if only one is being used. Overheating of a PC Card can result in errors or instability in its operation.

Be careful when you remove a PC Card that has been used for a long period.

- ❖ Avoid spilling liquids into the computer's keyboard.
If you do spill a liquid that gets into the keyboard, turn off the computer immediately. Leave the computer turned off overnight to let it dry out before you use it again.
- ❖ Never turn off the computer if a drive light indicates a drive is active.

Turning off the computer while it is reading from or writing to a disk may damage the disk, the drive, or both.

- ❖ Keep the computer and disks away from objects that generate strong magnetic fields, such as large stereo speakers.

Information on disks is stored magnetically. Placing a magnet too close to a disk can erase important files.

- ❖ Scan all new files for viruses.

This precaution is especially important for files you receive via email or download from the Internet. Occasionally, even new programs you buy from a supplier may contain a computer virus. You'll need a special program to check for viruses. Ask your dealer to help you.

Setting up your computer



TECHNICAL NOTE: You must complete all set up steps up to “Setting up your software” on page 45 before adding external or internal components to your computer. These components include, but are not limited to, a mouse, keyboard, printer, memory, and PC cards.

Your computer contains a rechargeable high-capacity battery that needs to be charged before you can use it.

To use external power or to charge the battery, you must attach the AC adapter. See [Connecting the AC adapter](#) for more information.

Setting up your software

The first time you turn on your computer, the Setup Wizard guides you through steps to set up your software.

- 1 From the welcome screen, click **Next** to enter the Setup Wizard.
- 2 Confirm acceptance of Microsoft’s End User License Agreement and click **Next**.
- 3 Enter the computer name and description and click **Next** or **Skip**.

The computer will pause for a moment while checking for an internet connection, and you will see the screen “Checking your internet connectivity.”

A window will display the message: “How will this computer connect to the internet?” The system displays three selections: Telephone modem, Digital subscriber line (DSL) or cable, or Local Area Network (LAN).

- 4 Click **Skip** to exit the process or **Next** to continue.
-



NOTE: To register online, your computer's modem must have an Internet connection.

A window will display asking if you wish to register with Toshiba and Microsoft.

- 5 Click **Yes** to register, or **No** to exit the process.
-



NOTE: If you click No, you may register with Toshiba by clicking the Register with Toshiba icon on the desktop.

- 6 If you selected Yes in step 5, enter your personal information in the registration window.

A window will display the message, "Who will use this computer?"

- 7 Enter your name and click **Next** to complete the process.

A window will display the message, "Thank you."

- 8 Click **Finish** to continue.

Your computer restarts automatically.

Registering your computer with Toshiba

Registering your computer lets Toshiba keep you up-to-date with information about new products and upgrades, and also extends your Toshiba warranty worldwide at no charge to you. You can register your computer with Toshiba during the start-up process or by clicking on the icon on the desktop at a later time.



NOTE: To register online, your computer's modem must be connected to a voice-grade telephone line.

Adding external devices



NOTE: Before adding external devices, Toshiba recommends setting up your software first. See “Setting up your software” on page 45.

Before starting to use your computer, you may also want to:

- ❖ Add more memory (see “Installing additional memory (optional)” on page 54)
- ❖ Connect a mouse (see “Connecting a mouse” on page 60)
- ❖ Connect a local printer (see “Connecting a printer” on page 61)
- ❖ Install PC Cards (see “Using PC Cards” on page 164)

Connecting the AC adapter

Your computer requires power to operate. Use the power cable and AC adapter to connect the computer to a live electrical outlet, or to charge the computer's battery.

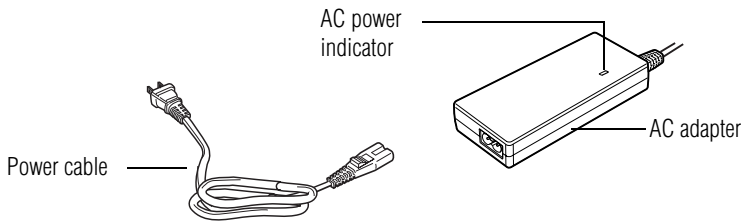

Power cable and AC adapter



CAUTION: Use only the AC adapter supplied with your computer or an equivalent adapter that is compatible. Use of any incompatible adapter could damage your computer. Toshiba assumes no liability for any damage caused by use of an incompatible adapter.

When you connect the AC adapter to the computer, always follow the steps in the exact order as described in the User's Manual. Connecting the power cable to a live electrical outlet should be the last step otherwise the adapter DC output plug could hold an electrical charge and cause an electrical shock or minor bodily injury when touched. As a general safety precaution, avoid touching any metal parts.



DANGER: Hold the power cable by its plug when you connect/disconnect it. Do NOT pull the cable itself. Doing so may damage the power cable and result in a short circuit or electric shock.

To connect AC power to the computer:

- 1 Connect the power cable to the AC adapter.

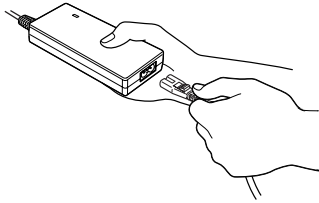

Connecting the power cable to the AC adapter



- 2 Plug the AC adapter into the DC-IN on the back of the computer.

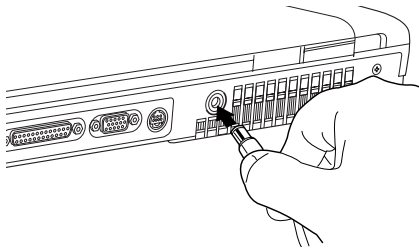

Connecting the AC adapter to the computer

- 3 Connect the power cable to a live electrical outlet.

The AC power and battery lights glow.



DANGER: Damaged power cables can cause fire or electric shock. Never modify, forcibly bend, place heavy objects on top of, or apply heat to the power cable.

If the power cable becomes damaged or the plug overheats, discontinue use. There is a risk of electric shock.

Never remove the power plug from the outlet with wet hands. Doing so may cause an electric shock.

Charging the main battery

To charge the main battery, plug the computer into a live wall outlet. It takes several hours to charge the battery with the computer off. It takes much longer to charge the battery while the computer is on. For more information on battery use, see [“Running the computer on battery power”](#) on page 98.



TECHNICAL NOTE: The battery does not charge while the computer is consuming full power.



CAUTION: Once the battery is charged for the first time, avoid leaving the computer plugged in and turned off for more than a few hours at a time. Continuing to charge a fully charged battery can damage the battery.



NOTE: Battery life and charge time may vary depending on the applications, power management settings, and features used.

Using the computer for the first time

Opening the display panel

Press the display latch and lift the display panel.

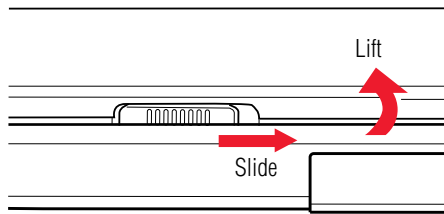

Opening the display panel



CAUTION: To avoid damaging the display panel, don't force it beyond the point where it moves easily.

Never lift or move the computer using the display panel.

Turning on the power



- 1 Check that any drives on the computer are empty.
- 2 Turn on the computer by pressing and releasing the power button located on the top of the keyboard. For an illustration to help you locate this button, see [“Front with the display open”](#) on page 34.



NOTE: When you turn on the computer for the first time, don't turn off the power again until the operating system has loaded completely.



The AC power indicator glows when the computer is connected to an external power source.



The battery light:

- ❖ Glows amber while the battery is being charged.
- ❖ Glows green when the battery is fully charged.
- ❖ Is unlit when the computer is not connected to an external power source. For information on determining battery power, see [“Monitoring battery power” on page 101](#).



The hard disk drive indicator flashes to indicate that the hard disk drive is currently in use.



The disc/disk activity indicator flashes while the Modular Bay is being accessed.



CAUTION: Never turn off the computer while any drive is in use.

Using the TouchPad™

The TouchPad, the small, smooth square cutout located in front of the keyboard, is sensitive to touch and enables you to move the cursor with the stroke of a finger. Simply move your finger on the TouchPad in the direction you'd like to move the cursor:

- ❖ To move the cursor to the top of the page, push your finger forward on the TouchPad.
- ❖ To move the cursor to the bottom of the page, drag your finger toward yourself.
- ❖ To move the cursor to the right side of the page, slide your finger across the TouchPad from left to right.

-
- ❖ To move it to the left side, slide your finger from right to left.



NOTE: Because the TouchPad is much smaller than the display screen, moving your cursor across the screen often means having to move your finger several times across the TouchPad in the preferred direction.

Once you've positioned your cursor, you can either click it into place by double-tapping the TouchPad or clicking the control buttons. For more on the TouchPad, see [“Lesson 2: Using the TouchPad and control buttons together”](#) on page 115.

Control buttons

When a step instructs you to click or choose an item, move the cursor to the item, then press and release the primary (left-hand) button. To double-click, press the primary button twice in rapid succession. The primary button usually corresponds to the left mouse button.

The function of the secondary (right-hand) button depends on the program you are using. It usually corresponds to the right mouse button. Check your program's documentation to find whether it uses the right mouse button.

Disabling or enabling the TouchPad

The TouchPad is enabled by default. To change the enable/disable TouchPad setting:

- 1 Click **Start, Control Panel**.
The Control Panel window appears.
- 2 Click **Printers and Other Hardware**.
- 3 Click **Mouse** or press the Fn + F9 hot keys.
The Mouse Properties window appears.

- 4 Click the **TouchPAD ON/OFF** tab.
The TouchPAD ON/OFF tab view window appears.
- 5 Select **Disable** or **Enable**, whichever is appropriate.
- 6 Click **Apply**.
- 7 Click **OK**.
The Mouse Properties window closes.
- 8 Close the Printers and Other Hardware window.
- 9 Close the Control Panel window.



NOTE: The Fn + F9 shortcut can be used to enable or disable the TouchPad (see “Hot Keys” on page 215).

Installing additional memory (optional)



CAUTION: Before you install or remove a memory module, turn off the computer using the Start menu. If you install or remove a memory module while the computer is in Stand by or Hibernation mode, data will be lost.

A memory module must be installed in slot A. Do not try to operate the computer with a memory module in slot B only.

If you install a memory module that is incompatible with the computer, a beep will sound when you turn on the computer. If the module is installed in slot A, there will be a long beep followed by a short beep. If the module is in slot B, there will be a long beep followed by two short beeps. In this case, turn off the computer and remove the incompatible module.

Your computer comes with enough memory to run most of today's popular applications. You may want to increase the computer's memory if you use complex software or process large amounts of data.

Additional memory comes in various capacities (visit Toshiba's website at toshiba.com for more information). There are two memory slots. Your system may have both slots occupied.



CAUTION: If you use the computer for a long time, the memory modules will become hot. If this happens, let the modules cool to room temperature before you replace them.

You need a standard Phillips no. 1 screwdriver to install a memory module.



CAUTION: To avoid damaging the computer's screws, use a standard Phillips no. 1 screwdriver that is in good condition.

If you are adding memory after you have started to use the computer, begin at step 1, otherwise skip to step 2.

- 1** Turn off the computer via the Start menu.
See “Using Turn Off or Shut down” on page 88.
The operating system turns off the computer.
- 2** Unplug and remove any cables connected to the computer.
- 3** Close the display panel and turn the computer upside down to locate the expansion memory slot cover.

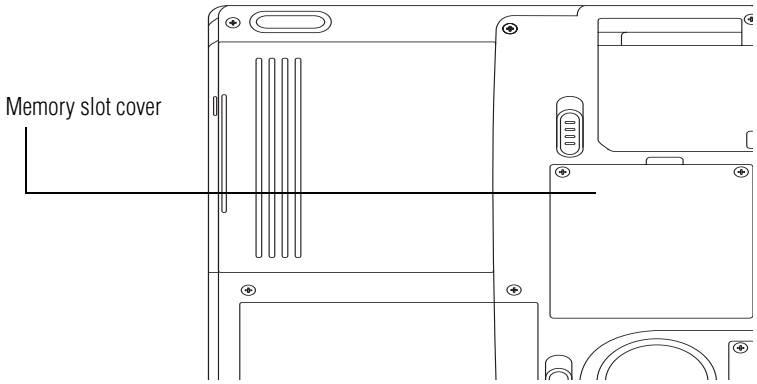

Base of a Satellite 2430/2435 computer

- 4 Using a standard Phillips no. 1 screwdriver, unscrew the two screws that secure the expansion memory slot cover, then remove the memory slot cover.

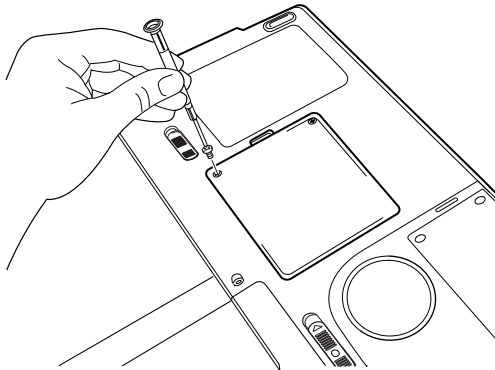

Removing the memory slot cover

-
- 5 Put the screws and the cover in a safe place so that you can retrieve them later.
-



CAUTION: Static electricity can damage the memory module. Before you handle the module, touch a grounded metal surface to discharge any static electricity you may have built up.

To avoid damaging the memory module, be careful not to touch its gold connector bar (on the side you insert into the computer).

- 6 The memory enclosure shares its space with an optional Wi-Fi Mini PCI module. If there is no Wi-Fi module installed, proceed to step 7. Otherwise:

Release the white antenna wire from the Main connector on the module. Then remove the black antenna wire from the Aux connector.

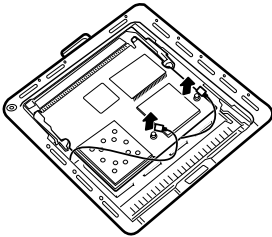

Removing the antenna wires

Unclip one of the sides securing the Wi-Fi module and gently remove it from the connector.

Remove the Wi-Fi module from the compartment to gain access to the memory module connectors.

The following figure shows the inside of the memory compartment.

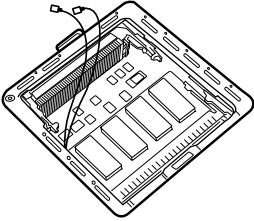

Viewing the inside of the memory compartment

- 7** Remove the memory module from its antistatic packaging.
- 8** Holding the memory module by its edges so that the gold connector bar faces the slot, fit the module into the socket.
- 9** Gently put the memory module connector down at an angle and press down until the clips snap into place.

Do not force the module into position. The memory module should be level when secured in place.

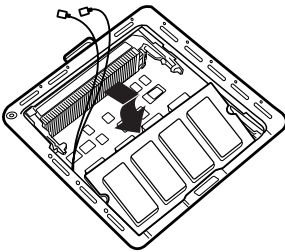

Inserting the memory module



CAUTION: Avoid touching the connectors on the memory module or on the computer. Grease or dust on the connectors may cause memory access problems.

- 10 If you removed the Wi-Fi module, reinstall it by reversing the steps in step 6 and referring to the following figures.

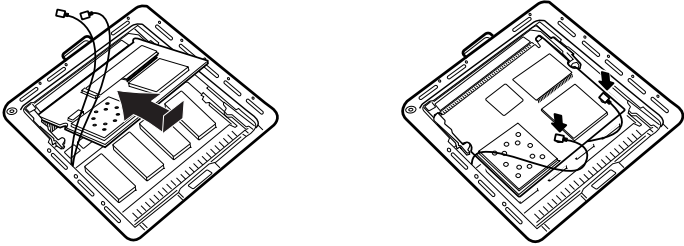

Replacing the Optional Wi-Fi Module and reconnecting the antenna wires

- 11 Replace the expansion memory slot cover.
- 12 Replace the screws and tighten them.
- 13 Turn the computer over and reconnect any cables you removed.
- 14 Turn on the computer.

To verify that the computer correctly recognizes the memory, click **Start, Control Panel** and click **Performance and Maintenance**. Click **System** to view the recognized memory.

- 15 If the computer does not recognize the memory, shut down the computer, remove the memory slot cover, and make sure the memory module is seated properly, as described in step 8.

Removing a memory module

- 1 Follow steps 1 through 6 in “[Installing additional memory \(optional\)](#)” on page 54.
- 2 Gently push the memory locks outward until the memory module pops up.

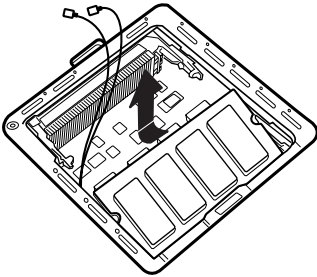

Removing the memory module

- 3 Gently pull the memory module diagonally to pull it out of the slot.
- 4 Complete the procedure by following steps 10 through 12 in “[Installing additional memory \(optional\)](#)” on page 54.

Connecting a mouse

You may want to use a mouse instead of the TouchPad, the computer's built-in pointing device.

To connect a USB mouse, plug the mouse cable into one of the USB ports.

Connecting a printer



NOTE: Read the documentation that came with your printer. Follow the manufacturer's instructions when connecting a local printer.



NOTE: You must supply the proper printer cable. If one did not come with your printer, you may purchase one from an electronics or computer store.

If your printer is ECP- or IEEE-compliant, make sure your printer cable is an IEEE 1284 cable.



CAUTION: Your printer documentation may require you to install the printer software before physically connecting the printer to your computer. If you do not install the software as instructed by the printer manufacturer, the printer may not function correctly.



CAUTION: Never connect the printer cable while the computer's power is on. Doing so may damage the printer, the computer, or both.

You can connect a USB-compatible printer to your computer through the USB ports. To determine if the printer is USB-compatible, check its documentation.

To achieve the connection, you need a suitable USB cable, which may come with your printer. You can purchase one from a computer or electronics store.

To connect a USB printer:



- 1** Plug the USB connector into one of the USB ports on your computer

-
- 2 Plug the printer's power cable into a live AC outlet.

To connect a parallel printer:



CAUTION: Connecting the parallel printer cable while the computer is on may damage the printer, the computer, or both.



- 1 Connect the printer cable to the printer and to the computer's parallel port.



Identifying the ends of a parallel printer cable

- 2 Plug the printer's power cable into a live AC outlet.

See your printer documentation for additional configuration steps, or see “Setting up a printer,” below.

Setting up a printer

If you started your computer with a printer connected and turned on, it may have been detected automatically (Plug and Play). If this is not the case, then you must install the printer driver for the model of printer that is connected to your computer. You install the printer driver either by following the instructions indicated in your printer manual, or by using the operating system Add Printer Wizard.

If you plan to set up a printer later, click **Cancel**.

Using the Add Printer Wizard

To set up a printer with the Add Printer Wizard:

- 1 Click **Start**, **Control Panel**, then **Printers and Other Hardware**.
- 2 Select **Printers and Faxes**.

The Printers and Faxes window appears.

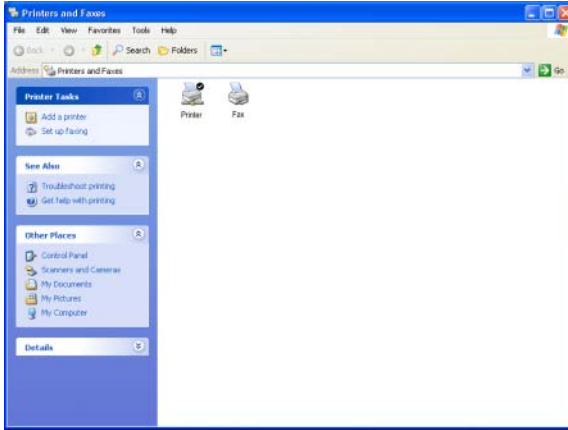

Sample Printers and Faxes window

3 Click **Add Printer**.

The Add Printer Wizard starts.



Sample Add Printer Wizard

4 Click **Next**.

The Add Printer Wizard asks you to select your printer.



TECHNICAL NOTE: If your printer is Plug and Play, the operating system recognizes it automatically. You can ignore the remainder of this section. See your printer manual.

5 If the printer you are setting up:

- ❖ Is not connected to a network, select **Local printer attached to this computer**.

If you select Local printer, check “Automatically detect and install my Plug and Play printer.”

- ❖ Is connected to a network, select **Network printer, or a printer attached to another computer**.

6 Click **Next**.

The Add Printer Wizard prompts you to select your printer.

7 From the list of manufacturers and printers, select your printer, then click **Next**.**8** Select the port settings according to the instructions in your printer’s documentation and the port to which your printer is connected, then click **Next**.

The Add Printer Wizard prompts you to enter a printer name.

9 Enter a name for your printer.

HINT: If you are using more than one printer, make sure the name is descriptive enough to help you tell the difference.

10 To set up the printer to be the default printer for the operating system, click **Yes**.

11 Click **Next**.

The operating system prompts you to print a test page.

12 If your printer is connected and turned on, click **Next**.

To complete the setup procedure without printing a test page, click **No**, then click **Next**.

13 Click **Finish**.

You are now ready to print.

Depending on your program, you may see various messages indicating the status of your print job.

Turning off the computer

It is a good idea to turn off your computer when you are not using it for a while.

If you are using the computer for the first time, leave the computer plugged into a power source (even though the computer is off) to fully charge the main battery. With the computer off, it may take up to three hours to recharge the main battery.

When you power down the computer, you have three options to choose from: Turn Off (or Shut down), Hibernate and Standby. Each option has its advantages.

- ❖ Use the Turn Off command if you are using the Windows® XP Home version operating system, or the Windows® XP Professional operating system when not connected to a domain server.
- ❖ Use the Shut down command if you are using the Windows® XP Professional operating system and connected to a domain server.
- ❖ If you have work in progress and are not connected to a network, use the Windows® Standby or Hibernate commands to save your system settings to memory so that, when you turn on the computer again, you will automatically return to where you left off.

-
- ❖ To leave the computer off for a longer period, you can use the Windows® Turn Off command when not connected to a domain server or the Shut down when connected to a domain server instead.



CAUTION: Never turn off the computer while any drive is in use. Doing so may damage the media in use and result in loss of data.

For more information, see [“Powering down the computer” on page 87](#).

Caring for your computer

This section gives tips on cleaning and moving your computer, and explains how to fit an antitheft lock. For information about taking care of your computer’s battery, see [“Running the computer on battery power” on page 98](#).

Cleaning the computer

To keep your computer clean, gently wipe the display panel and exterior case with a lightly dampened cloth. Ask your Toshiba dealer for suggestions for appropriate cleaning products.



CAUTION: Keep liquid, including cleaning fluid, out of the computer's keyboard, speaker grille, and other openings. Never spray cleaner directly onto the computer. Never use harsh or caustic chemical products to clean the computer.

Moving the computer

Before moving your computer, even across the room, make sure all disk activity has ended (the disk activity lights stop glowing) and all external peripheral cables are disconnected.



CAUTION: Never pick up the computer by its display panel or by the back (where the ports are located).

Although your notebook computer is built to withstand reasonable shock and vibration, transport it in a carrying case for long trips. You can purchase a carrying case from your Toshiba dealer or visit Toshiba's Web site at toshiba.com.

Using a computer lock

You may want to secure your computer to a heavy object such as your desk. The easiest way to do this is to purchase an optional PORT-Noteworthy[®] computer lock cable.



PORT-Noteworthy[®] computer lock cable

To secure the computer:

- 1** Loop the cable through or around some part of a heavy object.

Make sure there is no way for a potential thief to slip the cable off the object.

- 2** Pass the locking end through the loop.

- 
- 3** Insert the cable's locking end into the security lock slot, then rotate the key a quarter turn and remove it.

The computer is now securely locked to deter computer theft.

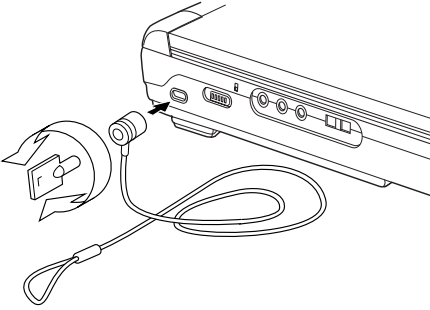

Locking the computer

Chapter 3

Learning the Basics

This chapter lists some computing tips and provides important information about basic features.

Computing tips

- ❖ Save your work frequently.

Your work temporarily stays in the computer's memory until you save it to the disk. You will lose all unsaved work, if, for example, a system error occurs and you must restart your computer, or your battery runs out of charge while you are working. Your computer can be configured to warn you when the battery is running low. See [“Power management”](#) on page 99.



HINT: Some programs have an automatic save feature which you can turn on. This feature saves your file to the hard disk at preset intervals. See your software documentation for details.

- ❖ Back up your files to storage media on a regular basis. Label the backup copies clearly and store them in a safe place.
If your hard disk suddenly fails, you may lose all the data on it unless you have a separate backup copy.
- ❖ Use Error-Checking and Disk Defragmenter regularly to conserve disk space and help your computer perform at its optimal level. Consult your Windows® XP operating system documentation for more information on these and other utilities.
- ❖ Always use the proper procedure to turn off the computer. (See “Powering down the computer” on page 87.)



CAUTION: The operating system records information, such as your desktop setup, during its shut down procedure. If you don't let the operating system shut down normally, details such as new icon positions may be lost.

Using the keyboard

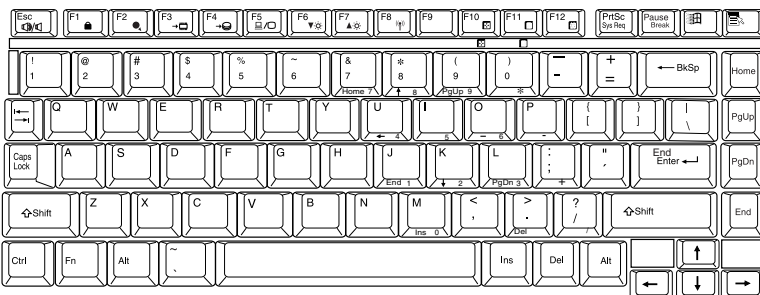

Keyboard

Character keys

Typing with the character keys is very much like typing on a typewriter, except that:

- ❖ The spacebar creates a space character instead of just passing over an area of the page.
- ❖ The lowercase l (el) and the number 1 are not interchangeable.
- ❖ The uppercase letter O and the number 0 are not interchangeable.
- ❖ The Caps Lock key changes only the alphabet keys to upper case — the number and symbol keys are not affected. The caps lock light on the keyboard indicator panel illuminates when you press the Caps Lock key.

Ctrl, Fn, and Alt keys



Ctrl, Fn and Alt keys

The Ctrl, Fn, and Alt keys do different things depending on the program you are using. For more information, see your program documentation.

Function keys

The function keys (not to be confused with the Fn key) are the 12 keys at the top of the keyboard.



Function keys

F1 through F12 are called function keys because they run programmed functions when you press them. Used in combination with the Fn key, function keys marked with icons run specific functions on the computer.

Windows® special keys

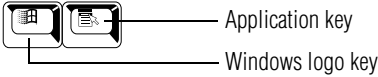

Windows® special keys

The keyboard provides two keys that have special functions in the operating system:

- ❖ The Windows® logo key opens the Start menu.
- ❖ The Application key has the same function as the secondary TouchPad control button (or secondary mouse button).

Overlay keys

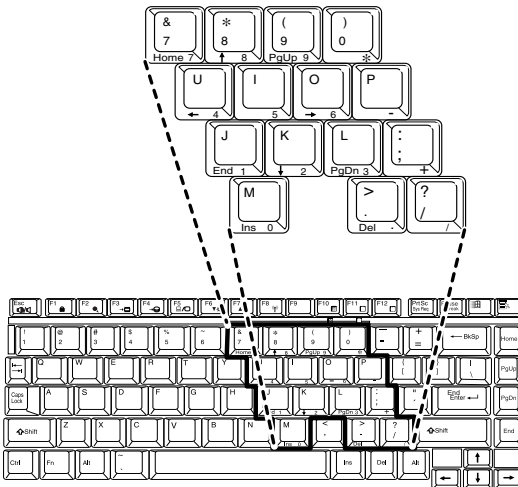

Keyboard overlay keys

The keys with numbers and symbols on the front of them form the numeric and cursor overlay. This overlay lets you enter numeric data or control the cursor as you would using the ten-key keypad on a desktop computer's keyboard.

Using the numeric keypad overlay



To turn on the numeric keypad overlay, press Fn and F11 simultaneously. The numeric mode light on the keyboard indicator panel glows when the numeric overlay is on.

You can still use the overlay keys to type alphabetic characters while the numeric overlay is on. To do so:

- ❖ For lowercase letters, hold down Fn while you type the letters.
- ❖ For uppercase letters, hold down both Fn and Shift while you type the letters.

To use the cursor control overlay when the numeric overlay is on, press and hold down Shift while you use the cursor control keys. To return to the numeric overlay, release Shift.

To turn off the numeric keypad overlay, hold down the Fn key and press F11 again. The numeric mode light on the keyboard indicator panel goes out.

Using the cursor control overlay



To turn on the cursor control overlay, press Fn and F10 simultaneously. The cursor control mode light on the keyboard indicator panel glows when the cursor control overlay is on.

To type alphabetic characters while the overlay is on:

- ❖ For lowercase letters, hold down Fn while you type the letters.
- ❖ For uppercase letters, hold down both Fn and Shift while you type the letters.

To use the numeric keypad overlay when the cursor control overlay is on, hold down Shift while you use the numeric overlay keys. To return to the cursor control overlay, release Shift.

To turn off the cursor control overlay, hold down the Fn key and press F10 again. The cursor control mode light on the keyboard indicator panel goes out.

Starting a program

The easiest way to start a program is to double-click the name of the file that contains the information you want to work on. To find the file, use My Computer or Windows Explorer.

If you prefer to open the program first, you have four options:

- ❖ Double-click the icon for the program on your desktop
- ❖ Use the Start menu
- ❖ Use Windows Explorer to locate the program file
- ❖ Use the Run dialog box

The Windows[®] XP operating system tutorial chapter gives step-by-step instructions for starting a program from the Start menu. See [“Lesson 6: Starting programs” on page 121](#).

Saving your work

Before you turn off the computer, save your work to the hard disk drive.



NOTE: Always save your data even when you are using the Stand by. If your battery fully discharges, your information will be lost. Your computer can be configured to warn you when the battery is running low, see [“Power management” on page 99](#).

Many programs offer a feature that saves documents at regular intervals, such as every 15 minutes. Check your programs' documentation to see whether they have an automatic save feature.

To save:

- ❖ A file you are updating, open the program's **File** menu and click **Save**.
- ❖ A new file, choose **Save As** from the **File** menu, type a name for the file, and click **OK**.



*HINT: To make another copy of the file you are currently working with, choose **Save As** from the **File** menu and give the new file a different name.*

For information on how to name a file, see “[Windows® XP file system](#)” on page 114.

Printing your work

Verify that the Windows® XP operating system is set up for your printer as described in “[Setting up a printer](#)” on page 62.



TECHNICAL NOTE: You only need to set up the printer the first time you connect it. If you use more than one printer or are changing printers, you will need to set up the operating system to run with the additional printer(s).

To print a file:

- 1 If your printer is not on, turn it on now.
- 2 In the **File** menu of your program, click **Print**.
The program displays a Print dialog box.
- 3 Click **OK** to print.

Backing up your files

Backing up your files means copying individual files to media, such as CD, or copying entire sections of your hard disk to another device, such as a tape drive.

For those systems with a floppy disk drive, you may back up file to a floppy disk as follows:

- 1 To back up to a CD or other media, insert the media into the diskette appropriate drive.
- 2 Click **Start**, then click **My Computer**.
- 3 Click the drive that contains the file you want to copy.
- 4 Double-click the folder that contains the file, then click the file you want to copy.



HINT: You can use the Ctrl or Shift keys to select more than one file.

- 5 Click **File**, then click **Send To**.

Using the DVD-ROM or Multifunction drive

Optical storage has become the preferred medium for software, music, and video. Digital versatile discs (DVDs) provide a significant increase in data storage and support features that are not available on any other video platform. These features include wide-screen movies, multiple language tracks, digital surround sound, multiple camera angles, and interactive menus.

For these reasons, your computer may come with a DVD-ROM.

If a DVD-ROM drive or Multifunction drive is not currently installed in the Modular Bay, follow the instructions in “Using the Modular Bay” on page 162.

drive or Multifunction drive.



HINT: Your DVD-ROM or Multifunction drive is designed to play region 1 (North America) DVD-ROMs.



NOTE: For optimum DVD performance, it is recommended that you play DVDs while running the computer on AC power.

You use CD-ROMs to load and run software, and to access reference material such as catalogs, as well as listen to music. A special feature allows you to play audio CDs even when the computer is turned off. For more information, see “CD/DVD control buttons” on page 87.

Drive components and control buttons

The DVD-ROM or multifunction drive resides in the Modular Bay on the bottom-right side of the computer. The CD/DVD control buttons are located at the front edge of the computer and can be accessed when the display panel is closed or open.

DVD-ROM drive components

Your DVD-ROM drive may look like this:

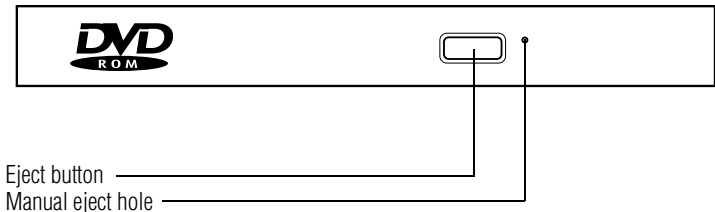

Sample DVD-ROM drive



CAUTION: Never press the eject button or turn off the computer while the drive-in-use indicator light is glowing. Doing so could damage the disc or the drive.

The eject button requires power to operate. The manual eject button does not require power.



CAUTION: Never use a pencil to press the manual eject button. Pencil lead can break off inside the computer and damage it. Instead, use a slim object such as a straightened paper clip.



HINT: When the computer is off and the DVD-ROM drive is on, press the stop/eject control button on the top of the computer to eject a disc.

CD/DVD control buttons

The control buttons on the front edge of the computer let you to play audio CDs when the computer is off. You can also use them to play CDs and DVDs when the computer is on.

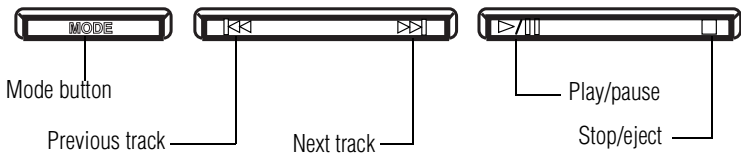

CD/DVD control buttons in front of the computer

The **mode** button switches between the CD/DVD and digital audio modes. When you use this button to select a mode, the CD or Digital Mode indicator lights to show the active mode. You can lock the mode to its current setting by pressing and

holding the mode button for four seconds. When the mode button is locked, you cannot switch between the CD/DVD and digital audio modes. To unlock the mode button, press and hold it for four seconds.

The **previous track** button returns to the preceding track on the disc.

The **next track** button skips to the following track on the disc.

The **play/pause button** starts playing the disc or makes it pause if currently playing.

The **stop/eject** button stops a disc that is currently playing.

You can eject a disc by pressing the stop/eject button twice. Use this method to eject a disc when the computer is turned off and the sound subsystem is turned on.

CD/DVD control and digital audio modes

The following chart describes CD/DVD control and digital audio mode.

	<i>CD/DVD Mode</i>	<i>Digital Audio Mode</i>
Power is off and you press Play/Pause	<p>If a CD is in the drive, the system enters CD player mode and operates as a stand-alone CD player.</p> <p>If a DVD is in the drive, the operating system starts and the DVD player starts.</p>	<p>The operating system starts, the Media Player starts and the digital audio file begins to play.</p>
While in CD/DVD mode, you press the mode button	DVD-ROM drive power turns off.	

	<i>CD/DVD Mode</i>	<i>Digital Audio Mode</i>
Power is off and you press Play/Pause	<p>If a CD is in the drive, the system enters CD player mode and operates as a stand-alone CD player.</p> <p>If a DVD is in the drive, the operating system starts and the DVD player starts.</p>	<p>The operating system starts, the Media Player starts and the digital audio file begins to play.</p>
Operating system is running and you press Play/Pause	<p>If a CD is in the drive, the Media Player starts and the digital audio file begins to play.</p> <p>If a DVD is in the drive, WinDVD starts and the DVD begins to play.</p>	<p>Media Player starts and the digital audio file begins to play.</p>

Inserting a disc



WARNING: Before playing an audio CD, turn the volume down. Playing the compact disc at maximum volume could damage your ears. To turn the volume down, use the Volume Control switch or access the Volume Control program (click Start, All Programs, Accessories, Entertainment, Volume Control).

- 1 If the computer is turned on, press the eject button on the DVD-ROM drive.

The disc tray partially opens.



CAUTION: To avoid damaging a disc or losing data, check that the disc activity light is off before opening the disc tray.

- 2 Grasp the disc tray and pull it fully open.
 - 3 Hold the disc by its edges and check that it is clean and free of dust.
-



CAUTION: Handle discs carefully. Avoid touching the surface of the disc. Grasp it by its center hole and edge. If you handle the disc incorrectly, you could lose data.

- 4 Carefully place the disc in the empty tray with its label facing up.

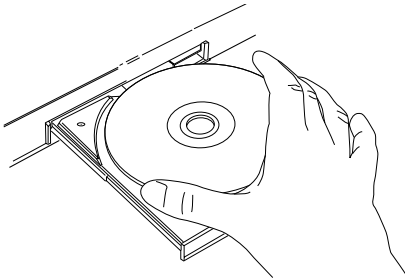

Inserting a disc



CAUTION: Be careful not to touch the drive's lens (located underneath the drive's spindle) or the area around it. Doing so could cause the drive to malfunction.

- 5 Gently press the center of the disc onto the spindle until it locks into place.

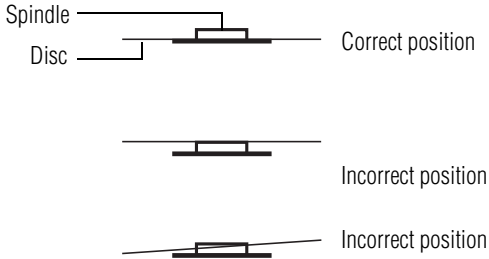

Positioning the disc on the spindle



CAUTION: Make sure the disc is properly positioned on the spindle. If you position the disc incorrectly, it can jam the disc tray.

- 6 Close the disc tray by pressing gently on the center of the tray until it clicks indicating that it is locked.

Playing an audio CD

Insert an audio CD and close the disc tray.

The computer automatically detects a disc in the drive and opens the Audio CD window. To play an audio CD select the Play Audio CD using Windows Media Player option and click OK.

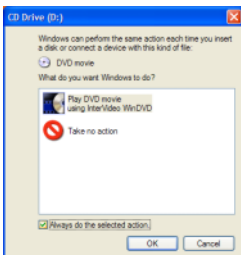

Sample Audio CD window

The Windows Media Player window appears.

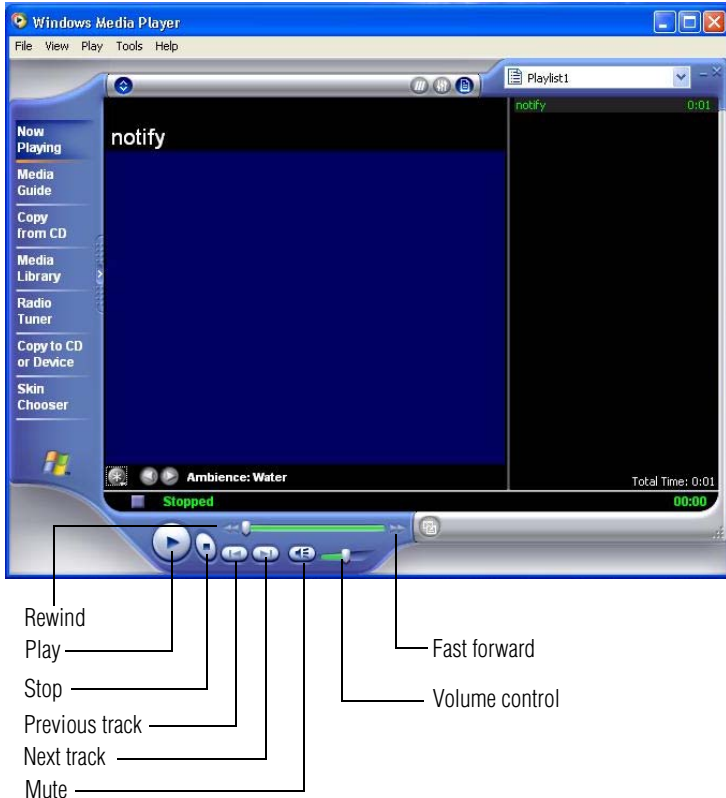

Sample Windows Media™ Player screen

The Windows Media™ Player control panel works much like an ordinary compact disc player:

- ❖ To play the CD or to pause, click the **Play/Pause** button on the CD Player control panel.
- ❖ To stop the CD, click the **Stop** button.

Playing a DVD

This manual has an entire chapter devoted to using WinDVD. For information about how to play back a DVD, see “[Playing DVDs](#)” on page 167.

Viewing the contents of a CD or DVD

CDs and DVDs contain files just like the hard disk. CDs are often used to install software or store files that require lots of space, such as photographs and large presentation files. You can use Explorer or My Computer to view the contents of any CD or DVD.

Removing a disc with the computer on



CAUTION: Never press the eject button or turn off the computer while the drive-in-use light is glowing. Doing so could damage the disk or the drive.

- 1 Locate and press the eject button.
The disc tray partially opens.
 - 2 Grasp the sides of the disc tray and pull it fully open.
 - 3 Remove the disc from the disc tray and place it in its protective cover.
-



CAUTION: If the disc is spinning when you open the disc tray, wait for the disc to stop before removing it.

- 4 Close the disc tray by pressing gently on the center of the tray until it clicks indicating that it is locked.

Removing a disc with the computer off

- 1 Insert a slender object, such as a straightened paper clip, into the manual eject button access hole.



CAUTION: Never use a pencil to press the manual eject button. Pencil lead can break off inside the computer and damage it.

- 2 Pull the tray fully open, remove the disc and place it in its protective cover.
- 3 Close the disc tray by pressing gently on the center of the tray until it clicks indicating that it is locked.

Caring for CDs and DVDs

- ❖ Store your discs in their original containers to protect them from scratches and keep them clean.
- ❖ Never bend a disc or place heavy objects on top of it.
- ❖ Hold a disc by its outside edge. Fingerprints on the surface of a compact disc can prevent the drive from reading the data properly.
- ❖ Avoid exposing discs to direct sunlight or extreme heat or cold.
- ❖ To clean a disc, wipe it from the center outwards (not in a circle) with a clean, dry cloth. If necessary, moisten the cloth with water or a neutral cleaner (not benzine or rubbing alcohol). Let the disc dry completely before inserting it in the drive.

Setting up for communications

To communicate across the telephone lines with another computer, you need:

- ❖ The computer's modem
- ❖ A telephone line
- ❖ An Internet Service Provider (ISP)

To connect to the Internet, you need a Web browser, such as Microsoft® Internet Explorer.



TECHNICAL NOTE: Disable Call Waiting before you connect through the modem. Call Waiting may interrupt data transmission.

Connecting the modem to a phone line

Your computer comes with a built-in modem. To use the modem, you must connect it to a standard voice-grade RJ-11 telephone line. For more information regarding your computer's modem, visit Toshiba's web site at toshiba.com.

- 1 Attach one end of a standard RJ-11 telephone cable to the modem port.

To locate the modem port, see “Back” on page 30.

- 2 Plug the other end of the RJ-11 telephone cable into the modular jack of a standard voice-grade telephone line.

Connecting your computer to a network

You can connect your computer to a network remotely, using the built-in modem and a dial-up connection. For specific information about connecting to the local area network (LAN) or wide area network (WAN), consult your network administrator.

To use a dial-up connection, have your network administrator configure your computer for the network and supply you with the telephone number for the dial-up connection. To set up the network connection, use the Dial-Up Networking Wizard:

- 1 Click **Start** and point to **All Programs**.
- 2 Point to **Accessories**, then to **Communications**.
- 3 Click **Network Setup Wizard** or **Network Connections**.
- 4 Enter the phone number of your network connection and let the program dial the number.

The computer connects with the network.

Powering down the computer



NOTE: Pushing the power button before shutting down the Windows® operating system could cause you to lose your work. Make sure the system indicator panel's disk light and the drive-in-use light are off. If you turn off the power while a disk is being accessed, you may lose data or damage the disk and/or drive.

When you power down the computer, you have three options to choose from: Turn Off, Stand By, and Hibernation.

You can set the computer to turn on automatically at a time you designate. This option is helpful for transferring files by modem at night. You can set the computer to turn on and send

or receive the files while you are asleep. This option is called Auto Power On.



TECHNICAL NOTES: Before using any of these options to power down your computer, save your files and make sure the disk activity lights are off.

If you change your mind and decide to continue working after all, wait a few seconds before turning the computer on again.

Using Turn Off or Shut down

For the Windows® XP Home operating system, follow these steps to shut down the computer:

- 1 Click **Start**, select **Turn off computer**.

The Turn off computer dialog box appears.

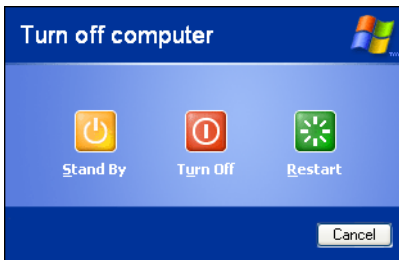

Sample Turn off computer dialog box

- 2 Click **Turn Off**.

The computer shuts down completely.

For the Windows® XP Professional operating system, follow these steps to shut down the computer:

- 1 Click the **Start** button, then **Shut down**.

The Shut Down Windows dialog box appears.

-
- 2 Select **Shut down** from the drop-down list.
 - 3 Click **OK**.

The computer shuts down completely.



NOTE: Holding the shift key while the Turn Off computer Windows dialog box is open, changes the Stand By button to hibernate. For more information about setting up hibernation “Hibernation command” on page 89 and “Using Hibernation” on page 92.

Hibernation command

The Hibernation command shuts the computer down completely, but it first saves the current state of the computer to the hard disk. Since Hibernation mode does not require power to maintain the saved information, the system settings are retained indefinitely. Restoring information from the hard disk takes longer than restoring it from memory. When you start up again, the computer runs a self-test, loads the operating system, and then returns to the state in which you left it.

Factors when choosing Hibernation mode:

- ❖ While in Hibernation mode, the computer uses no battery power.
- ❖ Because the state of the system is held on the hard disk, no data is lost if the battery discharges.
- ❖ Restarting from Hibernation mode uses less time and battery power than restarting from Turn Off.
- ❖ Restarting from Hibernation mode uses a little more time and battery power than restarting from Stand by because information is being retrieved from the hard disk instead of memory.

-
- ❖ When starting up again, the computer returns to the state in which you left it, including all open programs and files you were using.

For more information about the Hibernation command, see [“Using Hibernation” on page 92](#). For information about going into Hibernation mode more quickly, see [“Going into Hibernation mode more quickly” on page 93](#).

Stand By command

The Stand by puts the computer into a power-saving mode. Stand by holds the current state of the computer in memory so that, when you restart the computer, you can continue working from where you left off.

Factors when choosing Stand by:

- ❖ While in Stand by mode, the computer uses some battery power. The battery will eventually discharge in Stand by mode. If the battery discharges, your data will be lost if you do not save your work before entering Stand by mode.
- ❖ Restarting from Stand by mode uses less time and battery power than restarting from Turn Off or Hibernation mode.
- ❖ When starting up again, the computer returns to the mode in which you left it, including all open programs and files you were using.



NOTE: If you power down using the Stand by and the battery discharges fully, your information will be lost. Be sure to save your work first.

For more information about the Stand by, see [“Using Stand by” on page 94](#). For information about going into Stand by mode more quickly, see [“Going into Stand by mode more quickly” on page 95](#).

Turning off more quickly

You can also turn off the computer by pressing the power button or closing the display panel.

To use either of these methods, you first need to turn on the feature in the Toshiba Power Management Utility.



- 1 Click **Start, Control Panel**, then **Performance and Maintenance**.
- 2 Double-click the **Toshiba Power Management** icon.
The Power Options Properties dialog box appears.
- 3 Click the **Advanced** tab, and select the options you want.
 - ❖ **When I close the lid of my portable computer**
Set this option to **Power Off** to have the computer shut down when you close the display panel.
 - ❖ **When I press the power button on my computer**
Set this option to **Power Off** to have the computer shut down when you press the power button.

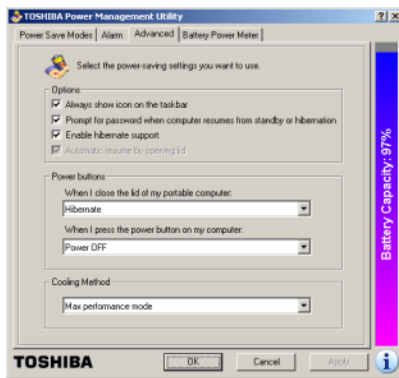

Sample Toshiba Power Management Advanced tab

- 4 Click **Apply**.
- 5 Click **OK**, then close the Control Panel.

Starting again after Turn Off

To start the computer up again, press and release the power button. The on/off light turns on.

Using Hibernation

Follow these steps to power down the computer using Hibernation:

- 1 Click **Start**, select **Turn off computer**.

The Turn off computer dialog box appears.

- 2 Hold down the shift key.

The Stand by option changes to the Hibernation option.

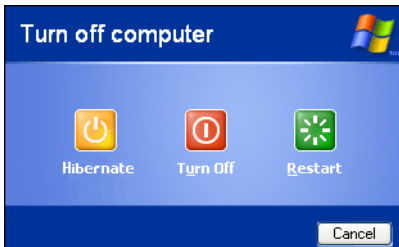

Sample Turn off computer dialog box

- 3 Click **Hibernate**.

The computer saves the mode of the system, including all open programs and files, to the hard disk, and then powers down completely.

Going into Hibernation mode more quickly

You can also put the computer into Hibernation mode by pressing the power button or closing the display panel.

- 1 Click **Start**, **Control Panel**, then **Performance and Maintenance**.
- 2 Double-click the **Toshiba Power Management** icon.
- 3 Click the **Advanced** tab, and select the options you want.



- ❖ **When I press the power button**
Set this option to **Hibernation** for the computer to go into Hibernation mode when you press the power button.
- ❖ **When I close the lid**
Set this option to **Hibernation** for the computer to go into Hibernation mode when you close the display panel.

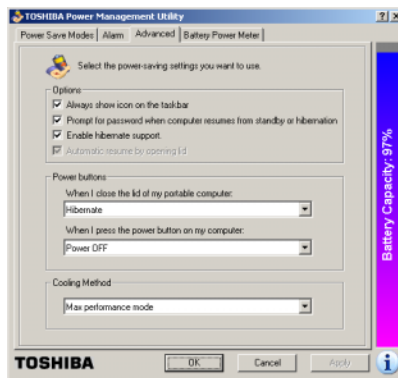

Sample Toshiba Power Management Advanced tab

- 4 Click **Apply**.
- 5 Click **OK**, then close the Control Panel.

Starting again from Hibernation mode

To start the computer from Hibernation mode, press and release the power button. The computer returns to the screen you were using.

If you put the computer in Hibernation mode by closing the display panel, you can start it again by opening the display panel.



NOTE: If your computer is running on batteries, you cannot start it again by opening the display panel. To turn the system back on, press the Power button.

Using Stand by

Follow these steps to power down the computer using the Stand by:

- 1 Click **Start**, select **Turn off computer**.
The Turn off computer box appears.
- 2 Click **Stand By**.

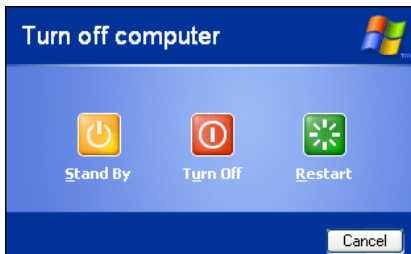

Sample Turn off computer dialog box

The computer saves the status of all open programs and files to memory, turns off the display, and goes into a low-power mode. The on/off light blinks to indicate the machine is in Stand by mode.



NOTE: If you power down using the Stand by and the battery discharges fully, your information will be lost. Be sure to save your work first.



NOTE: If you power down using the Stand by and the battery discharges fully, your information will be lost. Be sure to save your work first.

Going into Stand by mode more quickly

In addition, you can put the computer into Stand by mode by either pressing the power button or closing the display panel. You can also specify an amount of time after which the computer automatically goes into Stand by mode.

To use any of these methods, you first need to enable them in Toshiba's Power Saver utility.

- 1 Open the **Start** menu, then click **Control Panel**.
- 2 Click the **Performance and Maintenance** icon, and then click the **Toshiba Power Management** icon.
- 3 Click the **Advanced** tab.
- 4 Select **Stand By** for the options you want.

When I press the power button

Set this option to **Stand By** to put the computer into Stand by mode when you press the power button.

When I close the lid

Set this option to **Stand By** to put the computer into Stand by mode when you close the display panel.

- 5 Click **OK**.
- 6 Close the Control Panel.

Starting again from Stand by

To start the computer from Stand by mode, press the power button. The computer returns to the screen you were using.

If you put the computer in Stand by mode by closing the display panel, you can start it again by opening the display panel.

Toshiba's online resources

Toshiba maintains a number of online sites to which you can connect. These sites provide information about Toshiba products, give help with technical questions, and keep you up to date with future upgrades. For more information, see [“Contacting Toshiba” on page 211](#).

Chapter 4

Mobile Computing

This chapter covers all aspects of using your computer while traveling.

Toshiba's energy-saver design

Your computer enters a low-power standby mode when it is not being used, thereby conserving energy and saving money in the process. It has a number of other features that enhance its energy efficiency.

Many of these energy-saving features have been set by Toshiba. We recommend you leave these features active, allowing your computer to operate at its maximum energy efficiency, so that you can use it for longer periods while traveling.

Running the computer on battery power

The computer contains a removable Lithium Ion (Li-Ion) high-capacity battery that provides power when you are away from an AC outlet. You can recharge it many times.

Battery Notice

Battery life may vary depending on applications, power management settings and features utilized. Recharge time varies depending on usage. The battery may not charge while the computer is consuming full power.

After a period of time, the battery will lose its ability to perform at maximum capacity and will need to be replaced. This is normal for all batteries. To purchase a new battery pack, see your accessories information that shipped with your computer, or visit the Toshiba Web site at: toshiba.com.

To ensure that the battery maintains its maximum capacity, operate the computer on battery power at least once a month until the battery is fully discharged. Please see “[Maximizing battery life](#)” on page 107 for procedures. If the computer is continuously operated on AC power, either through an AC adapter or a docking station (if applicable to your system), for an extended period (more than a month) the battery may fail to retain a charge. This may shorten the life of the battery, and the battery light may not indicate a low-battery condition.

In addition, the computer has an internal real-time clock (RTC) battery. The RTC battery powers the RTC memory, which stores your system configuration settings and the current time and date for up to a month while the computer is turned off.



NOTE: For optimum DVD performance, Toshiba recommends that you play DVDs while running on AC power rather than on battery power.

Power management

Your computer ships with the power management options preset to a configuration that will provide the most stable operating environment and optimum system performance for both AC power and battery modes.



CAUTION: Changes to these settings may result in system performance or stability issues. Users who are not completely familiar with the power management component of the system should use the preset configuration. For assistance with setup changes, contact Toshiba's InTouch Center.

Charging the battery



NOTE: Battery charge time may vary depending on the applications, power management settings, and features used.

The battery needs to be charged before you can use it to power the computer.

To charge the battery, plug the computer into a live wall outlet. It takes several hours to charge the battery with the computer off. It takes much longer to charge the battery while the computer is on.



TECHNICAL NOTE: The battery does not charge while the computer is consuming full power.

The battery may not start charging immediately if:

- ❖ The battery is extremely hot or cold.

To ensure that the battery charges to its full capacity, wait until it reaches room temperature (50 to 80 degrees Fahrenheit, 10 to 26 degrees Celsius).

- ❖ The battery is almost completely discharged.

Leave the power connected, and the battery should begin charging after a few minutes.



HINT: Once the battery is fully charged, we recommend that you operate your computer on battery power until the battery discharges completely. Doing this extends battery life and helps ensure accurate monitoring of battery capacity.

Charging the RTC battery

The computer contains an internal battery that provides power for the real-time clock (RTC) and calendar.

During normal use, the main battery keeps the RTC battery adequately charged. Occasionally, the RTC battery may lose its charge completely, especially if you have had the computer turned off for a long time.

If the RTC battery is low, the real-time clock and calendar may display the incorrect time and date, or stop working.

To recharge the RTC battery, plug in the computer and leave it turned off for at least 24 hours.



NOTE: When Hibernate mode is enabled and the RTC battery is completely discharged, a warning prompts you to reset the real-time clock.

Monitoring battery power

-  The battery light indicates the battery's current charge. The indicator light:
 - ❖ Glows green when the battery is fully charged
 - ❖ Glows amber while the battery is being charged
 - ❖ Does not glow if the external power source is disconnected or if the battery is completely discharged

Determining remaining battery power



NOTE: Wait at least 16 seconds after turning on the computer before trying to monitor the remaining battery power. The computer needs this time to check the battery's remaining capacity and perform its calculations.

- 1** Click **Start, Control Panel, then Performance and Maintenance.**
-  **2** Double-click the **Toshiba Power Management** icon.

The current power source and battery power remaining section displays the current charge state of the battery. The value displays as a percentage of remaining battery charge.

3 Click the Battery Power Meter tab.

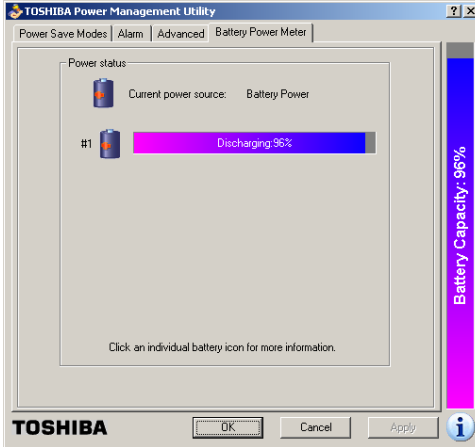

Sample Toshiba Power Management Battery Power Meter tab



TECHNICAL NOTE: The computer drains the battery faster at low temperatures. Check your remaining charge frequently if you are working in temperatures below 50 degrees Fahrenheit.

The computer calculates the remaining battery charge based on your current rate of power use and other factors such as the age of the battery.

Conserving battery power

How long a fully charged battery lasts when you are using the computer depends on a number of factors, such as:

- ❖ How the computer is configured
- ❖ How much you use the display panel instead of an external monitor
- ❖ How much you use the hard disk and other drives

-
- ❖ Whether you use any optional devices to which the battery supplies power, such as a PC Card
 - ❖ Where you are working—since operating time decreases at low temperatures

Toshiba's power-saving options greatly increase the length of time you can use the computer before it becomes necessary to recharge the battery.

Toshiba has combined these options into preset power usage modes.

What to do when the battery runs low

When the battery runs low you can:

- ❖ Plug the computer into an external power source and recharge the battery.
- ❖ Put the computer in Hibernate mode and replace the battery with a charged spare.
- ❖ Save your work and turn off the computer.

If you don't manage to do any of these things before the battery completely runs out of power, the computer automatically enters Hibernate mode and turns itself off. Hibernate mode keeps track of where you were so, when you turn on the power again, you can continue where you left off.

The computer stores the information on what you were doing until the battery runs out of power. If you have Hibernate mode enabled (the default), the computer copies the details of your open programs and files to the hard disk before shutting down.

Setting battery alarms

Your computer can be configured to warn you when the battery is running low.

You can set multiple alarms. Each alarm can be set to alert you when a specified percentage of remaining battery power has been reached. You can set how the warning occurs: sound an alarm, display a message, both, or none. You can also set the computer to enter Standby mode or Hibernate mode or to completely power down when the alarm goes off.

To set an alarm:

- 1 Click **Start, Control Panel**, then **Performance and Maintenance**.
- 2 Double-click the **Toshiba Power Management** icon.
- 3 Click the **Alarm** tab and set the alarm, as desired.

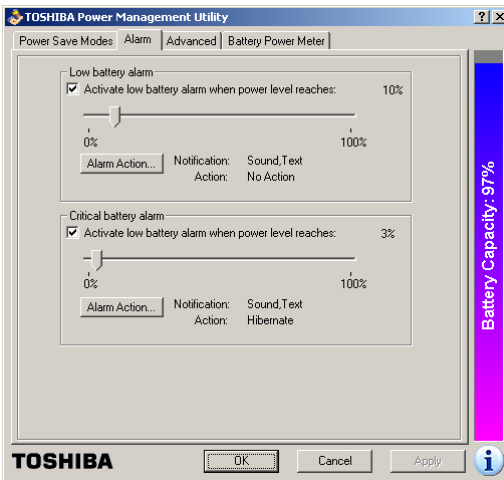

Sample Toshiba Power Management Alarm tab

Changing the main battery

When your battery power is running low, you have two options—connect the computer to an AC power source or install a charged battery.



CAUTION: When handling a battery, be careful not to drop it or short-circuit its terminals.

Removing the battery from the computer

- 1 Save your work.
- 2 Turn off the computer via the **Start** menu or place it in Hibernate mode according to the instructions in [“Using Hibernation”](#) on page 92.
- 3 Remove all cables connected to the computer.
- 4 Close the display panel and turn the computer upside down with the front side of the computer facing you.
- 5 Push and hold the battery release latch.

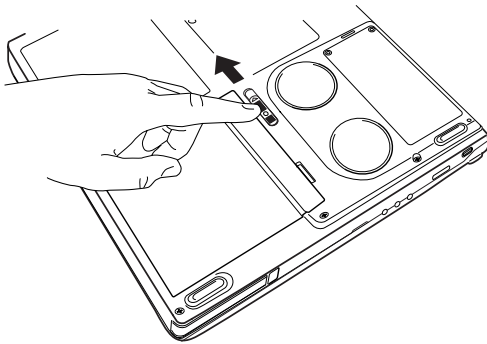

Releasing the battery

-
- 6 While still holding the release latch in the open position, lift the battery pack out of the computer.

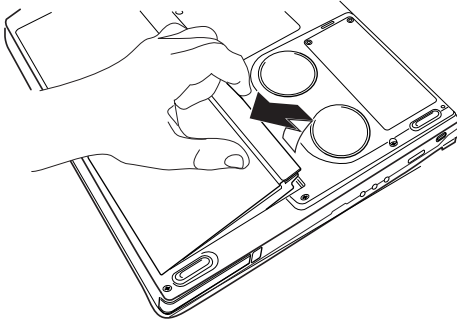

Removing the battery



WARNING: If the battery is leaking or its case is cracked, put on protective gloves to handle it, and discard it immediately following the advice in *“Disposing of used batteries safely”* on page 109.

Taking care of your battery

The following sections offer tips on how to take care of your battery and prolong its life.

Safety precautions

- ❖ If the battery pack produces an odor, overheats or changes color or shape while it is being used or charged, turn off the computer’s power immediately and disconnect the power cord from the power socket. Carefully remove the battery pack from the computer.
- ❖ Do not try to disassemble a battery pack.
- ❖ Do not overcharge or reverse charge a battery. Overcharging will shorten its life, and reverse charging could damage it.

- ❖ Avoid touching the metal terminals of the battery with another metal object. Short-circuiting the battery can cause it to overheat and may cause damage to the battery or the computer.
- ❖ Do not incinerate a spent battery, as this could cause it to explode and release toxic materials.
- ❖ If a battery is leaking or damaged, replace it immediately. Use protective gloves when handling a damaged battery.
- ❖ To replace the main battery, use an identical battery that you can purchase through toshiba.com.
- ❖ Reverse Polarity should be avoided with all batteries. The main battery is designed so that it cannot be installed in reverse polarity.
- ❖ Charge the battery pack only in the computer.
- ❖ When you install the battery pack, you should hear a click when it is inserted properly.
- ❖ Do not expose the battery pack to fire. The battery pack could explode.

Maximizing battery life

To maximize the life of your battery pack:

- ❖ At least once a month, disconnect the computer from a power source and operate it on battery power until the battery pack fully discharges. Before doing so, follow the steps below:
 - 1 Turn off the computer's power.
 - 2 Disconnect the AC adapter and turn on the computer's power. If it does not turn on, go to step 4.
 - 3 Operate the computer on battery power for five minutes. If the battery pack has at least five minutes of operating time, continue operating until the battery pack is fully discharged. If the battery light LED

flashes or there is some other warning to indicate a low battery, go to step 4.

- 4** Connect the AC adapter to the computer and the power cord to a power outlet. The DC-IN or AC power-light LED should glow green, and the Battery LED should glow amber to indicate that the battery pack is being charged. If the DC-IN or AC power-light indicator does not glow, power is not being supplied. Check the connections for the AC adapter and power cord.
 - 5** Charge the battery pack until the Battery LED glows green.
- ❖ If you have extra battery packs, rotate their use.
 - ❖ If you will not be using the system for an extended period, more than one month, remove the battery pack.
 - ❖ Disconnect the AC adapter when the battery is fully charged. Overcharging makes the battery hot and shortens life.
 - ❖ If you are not going to use the computer for more than eight hours, disconnect the AC adapter.
 - ❖ Store spare battery packs in a cool dry place out of direct sunlight.

Disposing of used batteries safely

You can recharge a battery many times. When the battery needs replacing, the battery light flashes amber shortly after you have fully recharged the battery.

You must discard a battery if it becomes damaged.



CAUTION: The computer's main battery is a Lithium Ion (Li-Ion) battery, which can explode if not properly replaced, used, handled, or disposed of. Putting spent batteries in the trash is not only irresponsible, it may be illegal. Dispose of the battery as required by local ordinances or regulations.

Use only batteries recommended by Toshiba.

The materials that came with your computer may include an insert regarding the disposal of batteries. If not, check with your local government agency for information on where to recycle or dispose of old batteries.

Traveling tips

The environmental precautions listed in “[Selecting a place to work](#)” on page 39, also apply while traveling.

- ❖ Never leave your computer on a sunny ledge or in a place where it could get wet or covered in dust.
- ❖ Always travel with the computer in a carrying case. Toshiba offers a choice of carrying cases for the computer. They all provide plenty of extra space for manuals, power cables, and compact discs. Contact your authorized Toshiba representative for more information.



TECHNICAL NOTE: When traveling by air, you may be required to pass your notebook through airport security equipment. The X-ray equipment will not harm your computer.

Chapter 5

Getting to Know the Windows[®] XP Operating System

This chapter introduces the Windows[®] XP operating system by guiding you through a few basic tasks.

If you have used a Windows[®] operating system before, you will find the Windows[®] XP operating system familiar. Whether you have used a Windows[®] operating system or not, the skill and confidence you will gain from this chapter will more than offset the short amount of time spent going through these lessons.

As you explore your computer's operating system further, you will often discover alternative ways of accomplishing a particular task.

For more detailed information on your operating system, refer to the Microsoft[®] Windows[®] XP operating system documentation that came with your computer.



HINT: The illustrated examples in this guide may appear slightly different from the screens displayed by your system. However, the differences are not significant and do not indicate any change in the functionality of your system.

You can create a new desktop icon for any folder, file, or program by dragging the element's icon from its location in a window to the desktop area.

The icons initially displayed on your system desktop include:



Toshiba Access—Opens a window with links to software updates, services and support, and other important benefits.



Recycle Bin—Holds files you've deleted using the Windows Explorer. You may retrieve these files until you empty the Recycle Bin.

Your desktop may contain other icons depending on your configuration. See Windows® XP online Help and Support for more specific information on each icon and how to use it.

Start button

You use the Start button to:

- ❖ Start programs
- ❖ Access Microsoft® Windows® XP operating system update information
- ❖ Open recently accessed documents
- ❖ Adjust system settings
- ❖ Search for files
- ❖ Access Windows Help and Support Center
- ❖ Run programs
- ❖ Suspend system activity and shut down the computer

For more information on starting programs, see [“Lesson 6: Starting programs” on page 121](#).

Taskbar

Each time you open a program, a button associated with that program appears on the taskbar. With some programs, a button appears on the taskbar for each document or window

you open. You can use these buttons to quickly switch between the programs or windows.

To make a program or window the active one, click the program's or window's button on the taskbar.

System tray

The System tray displays icons of tasks or programs that run continuously in the background. To learn more about each task, position the cursor over the icon for a few moments and a short description of the task appears.

Typical tasks in the System tray are Current time, Power usage mode, and speaker volume.

To activate a specific task, double-click the appropriate System tray icon.

Windows® XP file system

All files on your computer are organized for accessibility using a hierarchical file system.

Programs, documents, and other data are held in *files*. These files can be grouped together in *folders*, and folders can be grouped inside other folders for convenient organizing. All the files and folders reside in your computer on a storage *device*, such as a disk drive.

You can think of your computer storage system in terms of office equipment. You have a file cabinet (device), that contains folders, and each folder may contain documents. Your office may have more than one file cabinet, just as your computer may have more than one disk drive.

Computers can be connected together to form a *network*, so that programs, documents and other data can be quickly and easily shared between computers.

You can use the My Computer feature on the Start menu to access any file in the Windows® file system.

For more information, read the Microsoft documentation that comes with your computer.

Lesson 2: Using the TouchPad and control buttons together

The “Getting Started” chapter introduced you to the TouchPad, which is your basic tool for moving around the screen. This lesson lets you practice using the TouchPad and control buttons in tandem.

- 1 Using the TouchPad, move the pointer to the **Start** button, then click the primary button (usually the left) to open the **Start** menu.



NOTE: In this guide, the term “click” refers to the primary button, which is usually the left-hand button. You can also double-tap the touch pad surface to perform the same function. Instructions requiring the secondary button specifically mention that button. For example, “click the secondary button.”

- 2 Click an empty area of the desktop to close the **Start** menu.

- 3 With the pointer in an empty area of the desktop, click the secondary button (the right-hand button) to open the desktop shortcut menu.

As the name implies, shortcut menus provide quick access to many operating system features.

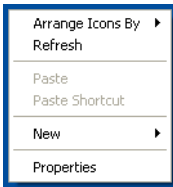

Sample desktop shortcut menu

- 4 Click an empty area to close the shortcut menu.
- 5 Use the TouchPad to move the pointer to the **Start** button. Click **Start**, and select **My Computer**.

The My Computer window appears.

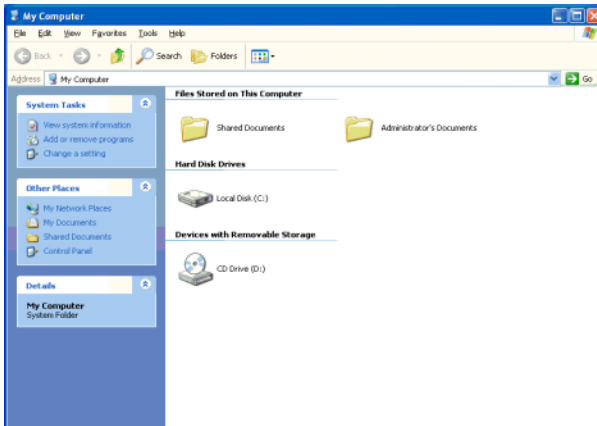

Sample My Computer window



- 6 Now click the **Close** button in the upper-right corner of this window.

The operating system closes the My Computer window.



NOTE: If the taskbar is locked, you need to unlock it. To unlock the taskbar, place the cursor on the taskbar and click the secondary button. Uncheck “Lock the Taskbar.”

- 7 Click an empty area of the taskbar at the bottom of the screen and, while holding down the primary button, use the TouchPad to drag the pointer to the right edge of the desktop, then release the primary button. (This process is known as “clicking and dragging.”)

The taskbar moves from the bottom to the right edge of the desktop.



Sample desktop with the taskbar on the right



HINT: You can move the taskbar to any of the desktop's four edges.

- 8 Click the taskbar once again and drag it back to the bottom of the desktop.

Lesson 3: Learning about the Internet

This lesson demonstrates how to access a Web page from a window and from the taskbar.

The lesson assumes you have an account with an Internet Service Provider (ISP).

Opening a Web page from a window

The most common way to open a Web page is by typing a Web address in the address line of the Web browser itself. But you can also type a Web address in the My Computer window.

- 1 Click **Start**, then double-click **My Computer**.

The My Computer window appears.

- 2 On the **View** menu, point to **Toolbars**, then click **Address Bar** if it is not checked.

The operating system displays the address bar. It indicates that you are in “My Computer.” You can also type a Web address in the address line.

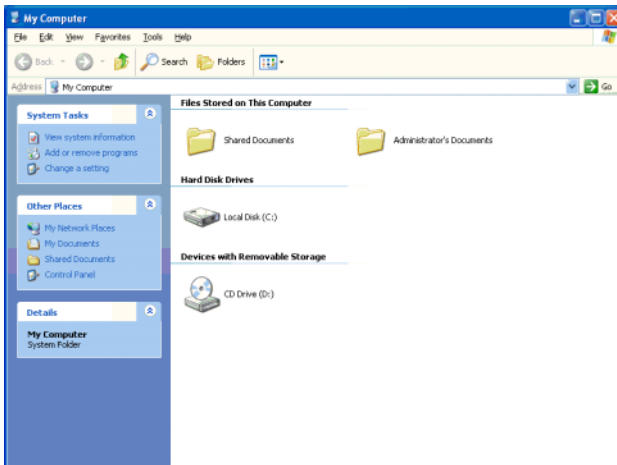

Sample My Computer window

Lesson 4: Creating a new document

This lesson teaches you how to create a text file without having to first open a program.

- 1 Move the pointer to an empty area of the desktop, then click the secondary button.

The operating system displays a shortcut menu of commands applicable to the desktop.

- 2 Click **New**, then click **Text Document**.

The operating system creates an icon on the desktop called New Text Document with the icon name highlighted.

- 3 To give your document a meaningful name, type My New Doc.txt and press Enter.

- 4 Double-click the **My New Doc** icon.

The operating system opens the new document in Notepad—the text editor built into the operating system.

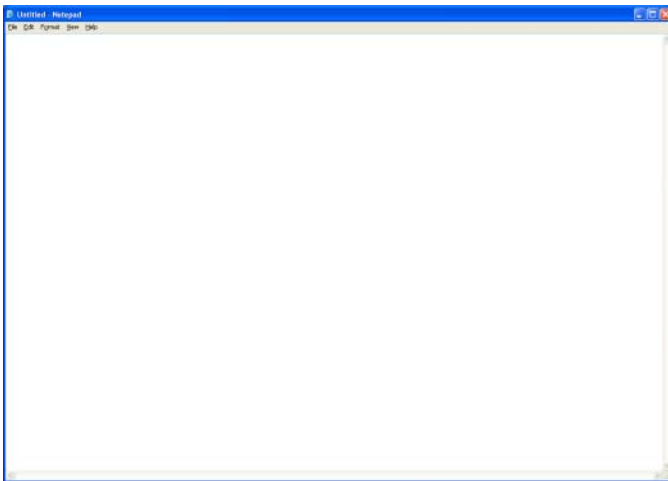

Sample Notepad window

Notice that when the document opens, there is a new button on the taskbar that reads My New Doc- Notepad (the name may be too long to fit into the taskbar space but, if you point to the name, the complete name is visible). By displaying buttons like this one, the taskbar helps you keep track of the programs and files you currently have open.

To learn more about Notepad, click **Help** or open the Help menu by pressing F1. For now, leave Notepad open and go on to the next lesson.

Lesson 5: Creating a new folder



DEFINITION: A folder is an area where you can store documents and other types of files. It is analogous to a file folder stored in a file cabinet. In this case, a disk drive in the computer is the file cabinet.

The operating system stores documents and programs in folders. It even stores other folders in folders. In this lesson, you will create a folder in which to store your new document.

- 1 Move the pointer to an empty area of the desktop, then click the secondary button.

The operating system displays the desktop shortcut menu.

- 2 Click **New**, then click **Folder**.

The operating system creates an icon on the desktop called New Folder with the icon name highlighted.

- 3 Type a name for the folder, such as **My Folder**, then press Enter.



- 4 Close the Notepad document you just created by clicking the **Close** button on the right side of the Notepad title bar.

The operating system displays the document as an icon on the desktop.

- 5 Click the document icon and drag it toward your New Folder icon. Position the document icon over the New Folder icon until it changes color, then release the primary button.

The outline of the document icon moves across the desktop and disappears into the folder.

- 6 To see your document, double-click the folder icon.

A window opens and displays the contents of the folder.



- 7 Close the window by clicking its **Close** button and continue with the next lesson to learn how to start programs.

Lesson 6: Starting programs

Usually, you will know which program you want to use for a particular task.

This lesson teaches you how to launch programs from the Start menu, using two of the programs that are built into the Windows® XP operating system: Paint and Windows Explorer.

- 1 Click **Start**, then point to **All Programs**.

The operating system displays a list of program folders.

- 2 Point to **Accessories**, then click **Paint**.

The operating system opens Paint—a basic drawing program.

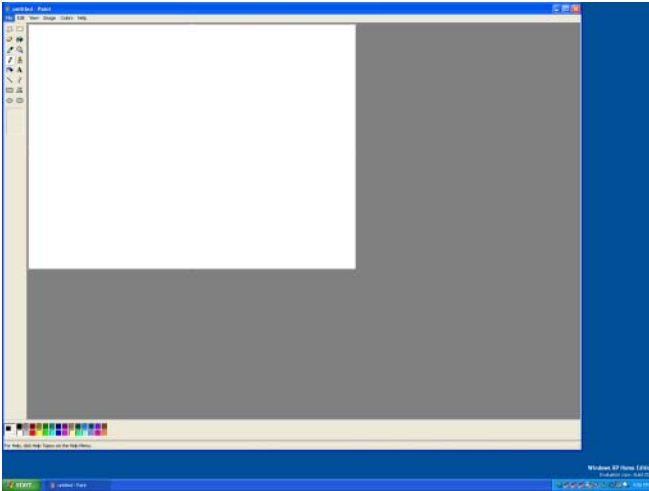

Sample Paint window

- 3 To open the second program, click **Start**, then click **All Programs**.
- 4 Point to **Accessories**, then click **Windows Explorer**.

The operating system opens Windows Explorer, which provides access to all your computer's resources. For example, it lets you see all the files in a particular folder on the computer's hard disk.

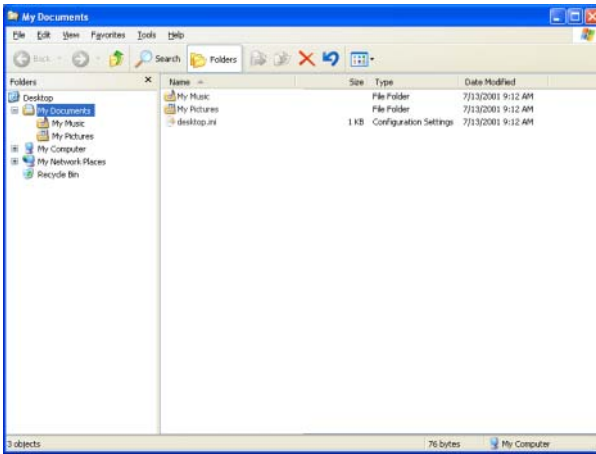

Sample Windows Explorer window

Notice the taskbar now has two buttons on it—one for Paint and one for Windows Explorer.

- 5 Click the **Paint** button on the taskbar.

The operating system displays the Paint program.

The operating system places the active window on top of other windows on the desktop unless you have selected a different display option. You can move back and forth between the two programs by alternately clicking each button.

Lesson 7: Resizing, repositioning, and hiding windows

If you have followed the lessons in this chapter, you now have a screen with several program windows open. You can organize these windows by resizing and repositioning windows so that you can see more than one of them at a time. You can also hide windows by removing them from the desktop without actually closing your document or program.

This lesson introduces several ways to adjust the size, shape, and position of windows open on the desktop.

Using the taskbar

If you have applications open on the desktop, you can rearrange them by pointing to the taskbar using the TouchPad and clicking the secondary button. The Windows® XP operating system provides these options:

- ❖ Move windows
- ❖ Size windows
- ❖ Minimize all windows—display only the taskbar buttons
- ❖ Maximize windows
- ❖ Close windows

Choose your option depending on how you wish to set up your desktop.

Minimizing and maximizing windows

- 1 To make the Windows Explorer window the active window, click the **Windows Explorer** button on the taskbar.

The operating system highlights the Windows Explorer title bar to show that Windows Explorer is the active window.



- 2 Click the **Minimize** button at the top-right of the Explorer window to hide the window.

Windows Explorer disappears from the desktop. However, it is still open, as you can see from the taskbar.



HINT: Minimizing program windows is a good way to clean up the desktop without actually closing programs.



- 3 Click the **Maximize** button in the top-right corner of the Paint window.

The Paint window expands to fill the screen, hiding everything except the taskbar. Notice that the Maximize button has changed. It is now called the Restore Down button.



HINT: Maximizing a program is a good way to work when you are only using that program and do not want any distractions on the screen.

Resizing and moving windows



- 1 Click the **Restore Down** button in the top-right corner of the Paint window.

Paint returns to its previous size and location. Notice that the Restore Down button has changed back into the Maximize button.

For the next few steps assume that you want to be able to see both Paint and Windows Explorer at the same time.

- 2 Move the pointer to the right-hand edge of the Paint window.

The pointer changes to a two-headed arrow.

- 3 Click and drag the edge of the window until it takes up just less than half the width of the desktop.

- 4 Click the title bar of the Paint window and drag it to the left side of the desktop.

You can move any window by clicking its title bar and dragging it.

- 5 Click **Windows Explorer** button on the taskbar.

- Repeat steps 3 and 4 to change the size and position of Windows Explorer, placing it on the right side of the desktop.

Now that the windows are side by side, you can see how you could refer to one window while working in the other.

Resizing and moving windows allows you to rearrange the desktop to suit your needs. Experiment with different sizes and placements of windows to find the best arrangement for your work.

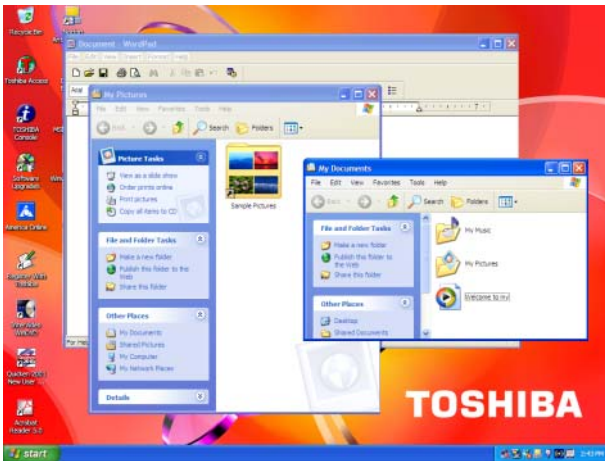

Sample Windows Explorer windows

At this point you have two programs open on the desktop. The next lesson shows you how to close them.

Lesson 8: Closing programs

Once you are finished working with a document or program, it is a good idea to close it. While you can run several programs at the same time, having a large number of programs and documents open simultaneously can slow down your computer.

This lesson teaches you how to close the programs you opened earlier in this tutorial.

To close the programs:



- 1 Click the **Close** button at the top-right of the Explorer window.

Windows Explorer closes, removing the Explorer button from the taskbar as well.

- 2 Close Paint and the My Computer window (assuming it is still open) by clicking the **Close** buttons for each program.
-



HINT: Always save your work before you close a program.

Lesson 9: Creating shortcuts

By adding shortcuts to your desktop, you can open programs or files with the click of a button. You will probably want to create shortcuts for the programs you use most frequently. This lesson explains how to create shortcuts using two Windows® accessories, Calculator and Character Map, as examples.

Creating a shortcut to the Calculator

Use this method when you know the name and location of the program file to which you would like to create a shortcut.

- 1 Move the pointer to an empty area of the desktop, then click the secondary button.

The operating system displays the desktop shortcut menu.

- 2 Click **New**, then click **Shortcut**.

The operating system displays the Create Shortcut dialog box.

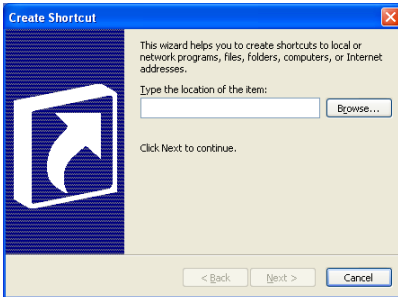

Sample Create Shortcut dialog box

- 3 In the **Command line** box, type `c:\windows\system32\calc.exe` and click **Next**.

The operating system prompts you to select a name for the shortcut.

- 4 Type **Calculator** and click **Finish**.

The operating system displays the new shortcut on your desktop.

Creating a shortcut to the Character Map

Use this method when you don't know the name and location of the program file.

- 1 Click **Start**, then point to **Search**.

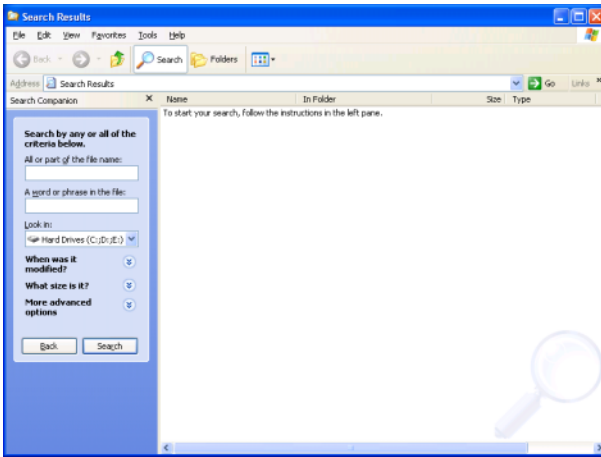

Sample Search options on the Start menu

2 Click All Files and Folders.

The operating system displays the Search Results dialog box.

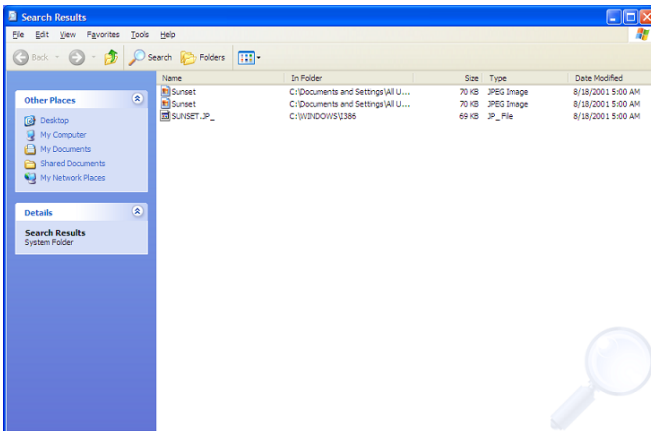

Sample Search Results dialog box



HINT: Search also allows you to perform searches on the Internet.

- 3 Type **char** in the **All or part of the file name:** text box, and then click **Search**.

The operating system displays a list of all the files with “char” in their names.

- 4 Click the **Character Map** file with the secondary button and drag it to the desktop.

A shortcut menu appears.

- 5 Click **Create Shortcut here**.

A shortcut to the Character Map appears on your desktop.

Clicking a shortcut icon opens the program or folder immediately. You can place as many shortcuts on your desktop as you find useful.



HINT: The Character Map is a useful tool when you want to add a special character to a document.

Lesson 10: Changing the screen saver

You can personalize the background area of your desktop with pictures, patterns, or colors. The background is considered a “property” of your desktop. This lesson will not only teach you how to change the background, but will also introduce you to properties.

The operating system treats all windows, icons, programs, drives, etc. as self-contained objects, each with its own set of properties (such as size, position on-screen, and color). Many

of these properties can be customized to meet your particular needs and tastes.



DEFINITION: An object is an independent block of data, text, or graphics that was created by an individual application.

This lesson introduces object properties by showing you how to change one of the properties of the desktop—the screen saver. This is a continuously changing pattern that appears on the screen during pauses in your work.

- 1 Move the pointer to an empty area of the desktop, then click the secondary button.

The operating system displays the desktop shortcut menu.

- 2 Click **Properties**.

The operating system opens the Display Properties dialog box.

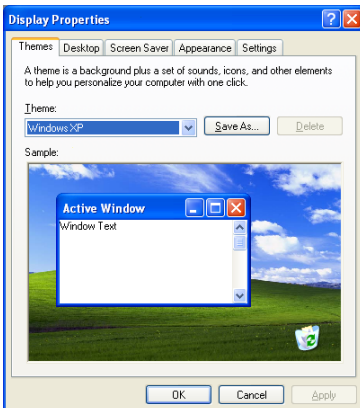

Sample Display Properties dialog box

- 3 Click the **Screen Saver** tab.
- 4 Click the arrow beside the current option to open the screen saver list box.

- 5 Scroll through the screen saver options by clicking the scroll arrows in the list box.
- 6 Try a screen saver pattern by clicking a name in the list box.

The operating system displays your selection in the monitor above the list box. Try several patterns.

- 7 To apply a pattern to your desktop, click **Apply**.
- 8 After you have chosen a screen saver pattern and applied it to your desktop, click **OK**.

The operating system returns you to the desktop.

You can view any object's properties by clicking the object with the secondary button, then choosing **Properties** from the shortcut menu that appears.

The next lesson explains how to set two other properties—the date and time.

Lesson 11: Setting the date and time

You initially set the computer's date and time properties when you turned the computer on for the first time and set up the operating system.

To change the date and time settings:

- 1 Click **Start**, then click **Control Panel**.
- 2 Click the **Date, Time, Language, and Regional Options** icon.
- 3 Click the **Date and Time** icon.

The operating system displays the Date and Time Properties dialog box.

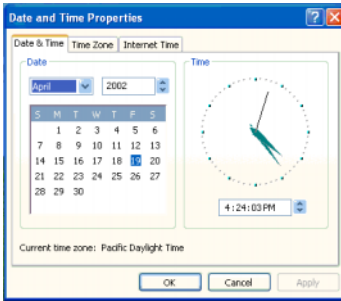

Sample Date and Time Properties dialog box



HINT: To open the Date and Time Properties dialog box more quickly, either click the time display on the taskbar with the secondary button, then click Adjust Date and Time, or double-click the time display.

- 4** Click the **Date & Time** tab and set the correct month, year, day, and time.
- 5** Click the **Time zone** tab, then the drop-down list box and set your time zone.
- 6** Click **OK**.

There is a third tab, Internet Time, which when selected allows you to have Windows® XP automatically synchronize your time. However, you need to be connected to the Internet for this function to work.

Continue with the next lesson to finish cleaning up the desktop.

Lesson 12: Removing objects from the desktop

Earlier in this tutorial, you created a new icon on the desktop. Since everything you have done to this point has been just practice, you may want to return the desktop back to its original uncluttered state. This lesson explains how to remove objects from the desktop and introduces the Recycle Bin.

- 1 Click the **New Folder** icon you created, drag it until it is over the Recycle Bin icon and it changes color, then release the primary button.

The icon disappears. But it is not really gone. It is merely set aside in the Recycle Bin so that you can restore or delete it later.

- 2 Repeat step 1 for any other icons you created during this tutorial.

Each icon disappears as you drop it on the Recycle Bin.

- 3 Double-click the **Recycle Bin** icon.

The operating system opens the Recycle Bin window. Notice that all the icons you dropped on the Recycle Bin are listed.

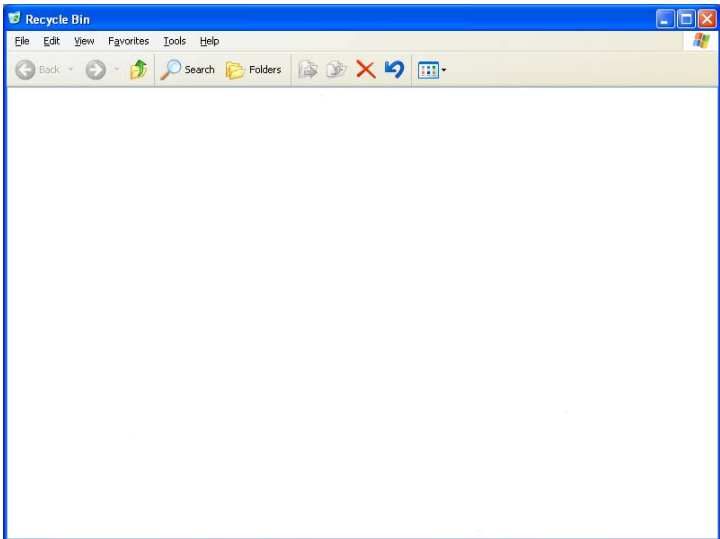

Sample Recycle Bin open on the desktop

- 4 To completely remove an object, select it, and then click **File, Delete**.

The object is permanently deleted from the Recycle Bin.

Later on—in your real work, not in this tutorial—you will use the Recycle Bin to delete other objects such as folders, documents, and sometimes even programs. Still, the process is the same. Just drag an object's icon to the Recycle Bin.

If you change your mind and want to restore an object you sent to the Recycle Bin, select the object with the secondary button and click **Restore Down**. The operating system restores the object to the place from which it was deleted.

When you are absolutely certain that you never want to see it again, delete it from the Recycle Bin.

To delete everything from the Recycle Bin at once, choose **Empty Recycle Bin** from the File menu. Click **Yes** to confirm that you are sure.



HINT: Empty the Recycle Bin periodically. Even though an item is moved to the Recycle Bin, it still uses valuable space on the hard disk drive until it is deleted from the Recycle Bin.

Lesson 13: Using System Restore

The System Restore feature allows you to return your computer to the way it was configured on a specific date or time, a “restore point.” This is useful if you are reconfiguring your computer for new hardware or software. In the event that your hardware or software causes your computer to malfunction, you can remove the offending item(s) and restore the system to the state it was in at the preset time.

To get to System Restore, click **Start**, point to **All Programs**, **Accessories**, **System Tools** and click **System Restore**.

The System Restore Welcome screen appears.

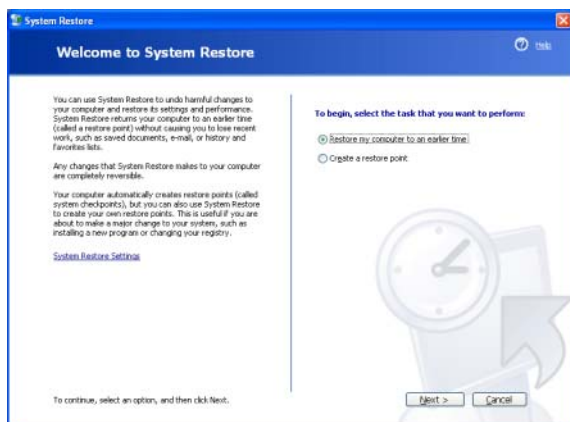

Sample System Restore Welcome screen

The left side of the screen contains the index. The text box above the index, where the cursor is flashing, lets you type in a topic you want to find in the index.

- 3 Type pictures in the **Type in the keyword to find:** text box.

Notice as you type that the index moves to locate what you typed. When you type the letter p, the topic list moves to the first entry that begins with P, and so on.

There are a number of topics listed under Picture. One of them, **Creating pictures using Paint**, looks promising.

- 4 Double-click **Creating pictures using Paint**.

Help opens a topic screen that gives a brief description of how to draw pictures, including an icon to start the Paint program.

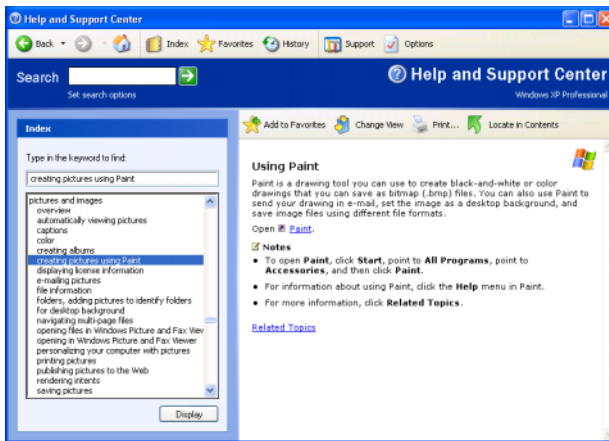

Sample Drawing help window

- 5 Click the **Paint** link.

The operating system opens the Paint program.

Not every Help topic contains a hot link to start the program it is talking about. However, when you do encounter one, it provides a convenient way to start the

program to look at it while you read about the program in the Help topic.

Using the online tours and tutorials

Whether you are new to computers or you have some experience, the Windows® XP Tours and Tutorials collection is a good place to start.

If you are not familiar with the Windows® XP operating system, start with “Windows XP Preview.”

“Learning about the benefits of Windows XP features” is a helpful introduction to the new features in the Windows® XP operating system.

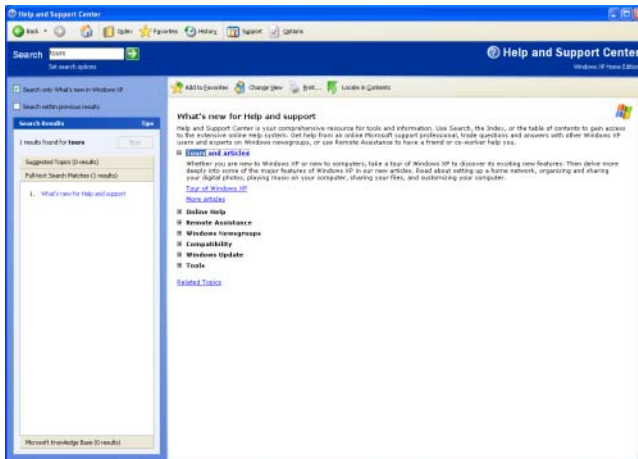

Sample Windows® XP Tours and tutorials window

To start a Windows® XP tour or tutorial:

- 1 Click **Start**, then **Help and Support**.
- 2 Click **What's new in Windows XP**.
- 3 Click **Taking a tour or tutorial**.
- 4 On the right pane, click **Take the Windows XP tour**.

Lesson 15: Turning off your computer

It is very important that you let the Windows® XP operating system shut down your computer. As it shuts down, the operating system performs a number of tasks that ensure that everything is in place the next time you turn on the computer. This lesson teaches you how to shut down the operating system and turn off your computer.

To let the operating system shut down your computer:

- 1 Click **Start**, then click **Turn off computer**.

The Turn off computer dialog box appears.

- 2 Click **Turn Off**.

The computer shuts down.

There are other ways to shut down your computer. For more information, see [“Powering down the computer” on page 87](#).

Chapter 6

Exploring Your Options

In this chapter, you will explore other features of your notebook computer.

Windows® XP special features

The Windows® XP operating system offers you several new features and enhancements, including:

- ❖ New system file protection
- ❖ A system restore function, allowing you to rollback the system to its previous mode
- ❖ An improved help center, support automation, and automatic Windows® operating system update
- ❖ Wizards to simplify setting up your home network
- ❖ Ability to share one Internet connection among multiple PCs
- ❖ An automatic discovery feature that allows your computer to detect new and intelligent devices

Personalizing your desktop

Your desktop is your virtual workspace. This section explains how to customize its features for the way you like to work. You can customize the following aspects of the desktop:

- ❖ Taskbar—which resources to display for quick access
- ❖ Active Desktop® interface—what information from the Internet to always display
- ❖ Desktop style—how windows are displayed and how to browse folders and files
- ❖ Toolbars—what information appears at the top of each window

Customizing the taskbar

As you work, the taskbar changes to reflect what you are doing. Its icons provide shortcuts to programs, documents, files, folders, system features, and components. Open applications also have Forward and Backward buttons to allow navigation through folders, documents, and Web sites.

For example, you can personalize the taskbar to include Quick Launch icons, and also your favorite URL addresses or local folders and programs.



DEFINITION: URL stands for Uniform Resource Locator, which is the address that defines the route to a file on the Web or any other Internet facility. Generically, it is known as the World Wide Web site address.

Having a list of favorite URLs handy saves time. Using it bypasses the need for you to launch your browser first.

To customize your taskbar settings, point to an empty space in the taskbar and click the secondary button. Then click **Properties**.

Bringing the world to your desktop

With the Windows® XP operating system you can set up your desktop with complete World Wide Web integration at a single click.

Turning on the Web content interface

The first step to bring active content to your desktop is to turn on the Web content interface:

- 1 Point to an empty space on the desktop and click the secondary button.
- 2 Click **Properties**.
The Display Properties window appears.
- 3 Click the **Desktop** tab.
- 4 Click the **Customize Desktop** button.
- 5 Click the **Web** tab.
- 6 Follow the instructions to set up your desktop.

Adding components to the Web content interface

- 1 Point to an empty space on the desktop and click the secondary button.
- 2 Click on **Properties**.
The Display Properties window appear.
- 3 Click the **Desktop** tab.
- 4 Click the **Customize Desktop** button.
- 5 Click the **Web** tab.
The operating system displays a list of items to add to the desktop.
- 6 To view additional components, click **New**.
The New Desktop Item dialog box appears.

- 7 To browse the Gallery for more components to add, click **Visit Gallery**.

In order to browse, an active Internet connection must be established.

- 8 To select some other Web site, type the address of the Web site you want or click **Browse** to locate it.

You can configure the Web content interface in several other ways. For further information, see your operating system documentation or access Windows[®] Help by clicking **Start, Help and Support**.

Changing desktop and browsing style

The operating system enables you to customize the way you view your desktop and browse the files and folders on your local computer or network file server.

You can make it so that:

- ❖ Items that normally require a double-click will open with a single click.
- ❖ Folders will open in their own window instead of in the same window.
- ❖ Folders are accompanied by a list of common tasks instead of displayed alone.

The options you choose determines how you browse in the operating system, regardless of whether you start from the desktop, My Computer, Windows Explorer, or Internet Explorer.

For more information about changing your desktop style, enter desktop in the Help and Support Index.

Choosing a style

To select desktop and browsing style options:

- 1 Click **Start**, then click **My Computer**.

The My Computer window appears.

- 2 Select the **Tools** menu, then click **Folder Options**.

The Folder Options dialog box appears.

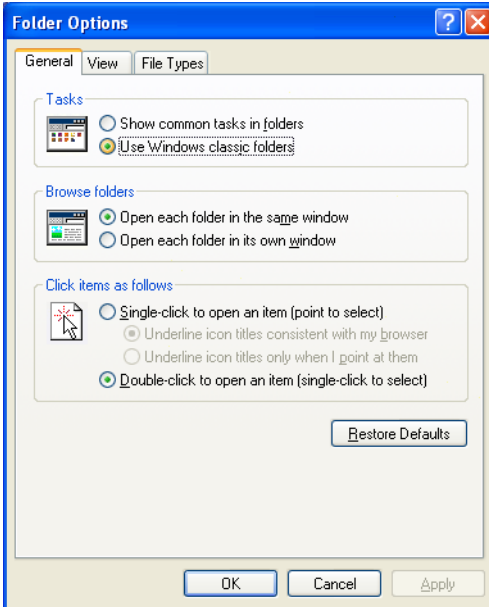

Sample Folder Options dialog box

- 3 Click the preferred options.
- 4 Click **Apply**, then **OK**.

Personalizing individual windows

Just as you can display a Web page on your desktop, you can also display a Web page in an individual window. If you subscribe to the Web page, it can be automatically updated on a regular basis. For example, using this Web integration feature you can monitor weather, game scores, stock prices, or headlines—all in the window of your choice.

Customizing window toolbars

You can display one or more customizable toolbars at the top of a window. As you browse, the operating system detects the kind of information presented in the window and automatically displays the appropriate toolbar buttons and menus.

You can also add these toolbars to the taskbar.

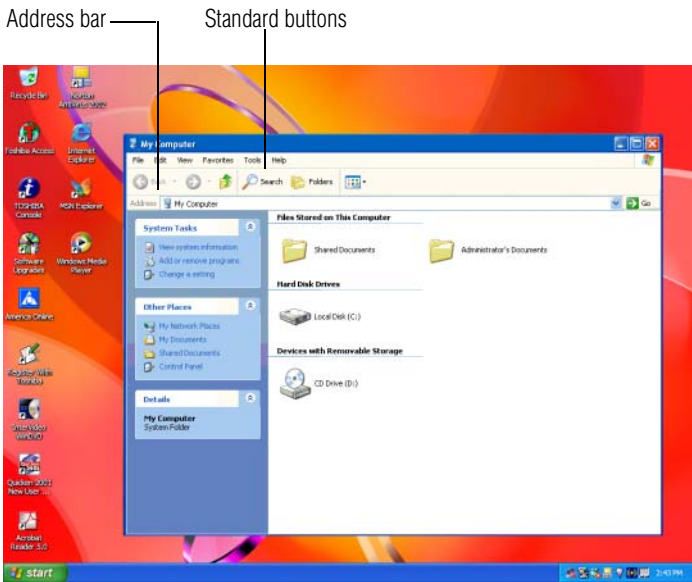

Sample toolbar locations

The elements you can add to the top of the window are:

Toolbar element *Description*

Address Bar Opens Web pages, programs, folders, or documents. By default, the address bar shows your current location, and whether it is a folder or a Web page. You can browse to another location by typing an address — a URL, a path, or even a program name.

If you start typing a previously typed address, the AutoComplete feature finishes the address for you.

Standard buttons Displays buttons for commonly used commands, such as copying, pasting, deleting items, changing views, and browsing backward and forward.

Displaying a toolbar in a window

- 1 Click **Start**, then click **My Computer**.

The My Computer window appears.

- 2 On the **View** menu, point to **Toolbars**, then click the name of the toolbar you want to display.

The toolbar appears below the menu bar of the current window.

Displaying information about each folder

In addition to displaying the contents of each window, you might find it helpful to have the operating system display the name of the folder and brief information about how to use the folder. This means displaying an individual window as a Web page.

- 1 Click **Start**, then click **My Computer**.

The My Computer window appears.

- 2 Open the folder you want to view as a Web page.
- 3 In the **Tools** menu, select **Folder Options**.
- 4 In the Tasks section, click the button for **Show common tasks in folders**.
- 5 Click **Apply**, then **OK**.

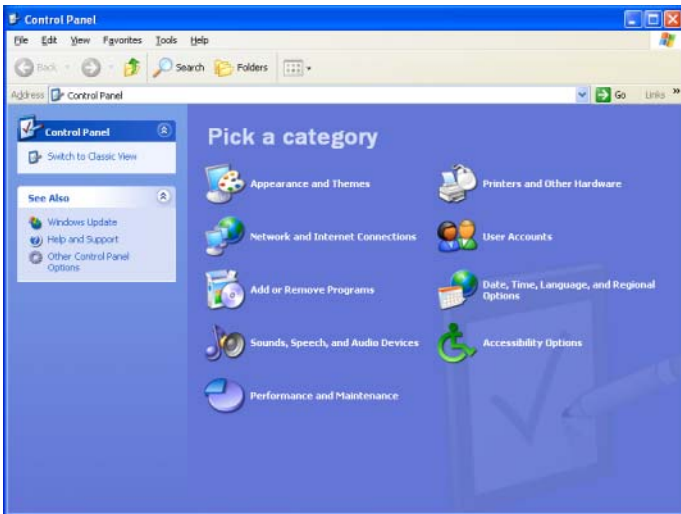

Sample Control Panel window as a Web page

The addition of the name of the folder and instructions for how to use the folder on the left give the window the appearance of a Web page.

Using your computer at the office

By connecting an external monitor, external full-size keyboard, an external mouse, and an external diskette drive, you can work with your notebook as if it were a standard office computer.



An external monitor connects to the RGB (monitor) port.



An external mouse, keyboard, and diskette drive connect to the USB ports.

Setting up for communications

To connect to the Internet, use an online service, or communicate across the telephone lines with another computer, you need:

- ❖ A modem (one comes with your computer)
- ❖ A telephone line
- ❖ A browser or communications program
- ❖ An Internet Service Provider (ISP) or online service if you plan to use the Internet

Determining the COM port

Your modem is connected to one of the computer's COM (communications) ports. The default setting for the modem is COM3.

The following procedure is intended to support you if you need to either upgrade your modem or reset the port to the default settings.

If you're having trouble connecting through the modem, you may need to determine the current COM port name and possibly change it.

To find out which port your modem is connected to in the operating system:

- 1** Click **Start, Control Panel**, then **Printers and Other Hardware**.
- 2** Click **Phone and Modem options**.
- 3** The Phone and Modem options window appears.
- 4** Click the **Modems** tab.
A location box appears.
- 5** In the **Attached to** field, the COM port is specified.
- 6** Make a note of the COM port number.

-
- 7 To verify that the modem is set up properly, double-click the COM port to which your modem is connected.
The Modem AMR Properties box appears.
 - 8 In the device status area, the computer should indicate whether the modem is working properly.
 - 9 If the modem isn't working properly, click **Troubleshooting** and follow the instructions.
 - 10 Click **OK** to close the properties box, then the Phone and Modem options box.
 - 11 Close the Control Panel.

Connecting the modem to a telephone line

Before you can use the modem, you must connect it to a standard voice-grade telephone line.



TECHNICAL NOTE: If you are using the telephone line at home, disable Call Waiting before you connect through the modem. Call Waiting interrupts data transmission.

Setting up a dial-up connection

To set up a dial-up connection, use the Dial-Up Networking Wizard:

- 1 Click **Start** and point to **All Programs**.
- 2 Point to **Accessories**, then to **Communications**, and click **New Connection Wizard**.
- 3 Click **Next**.
- 4 Select the type of connection you want to make.
 - ❖ Connect to the Internet
 - ❖ Connect to the Network at My Workplace

- ❖ Set up a home or small office network
 - ❖ Set up an advanced connection
- 5** Click **Next** and follow the directions on the screen.
- The computer connects to the network.

Exchanging data with another computer

To transfer a large amount of information between computers, you need a physical connection and a synchronization program.

You can use the Windows[®] XP Briefcase or a specialized synchronization program that transfers data using a cable connected to the computers' parallel ports.

Transferring files using a parallel port connection

To transfer files using the computers' parallel ports, you need a LapLink[®]- compatible parallel cable.

Getting started

- 1** Connect the cable.
- 2** Load the transfer program on both computers.
- 3** Set any specific options.
- 4** Start the transfer.
- 5** When you have finished transferring files, close the programs on both computers.

Getting help transferring files

- 1 Click **Start**, then **Help and Support**.
The Help and Support window appears.
- 2 Click the **Index** button.
- 3 In the dialog box, type direct cable connections.
- 4 Follow the online guide instructions.

Connecting to the Internet

To connect to the Internet you may need:

- ❖ A modem (one comes with your computer)
- ❖ A telephone line, DSL, a cable connection, or a satellite link
- ❖ A browser or communications program
- ❖ An Internet Service Provider (ISP)

Once you have established an ISP account, you can access the Internet.

Connect to the Internet by using a telephone and modem or through other higher-speed communication methods, such as Digital Subscriber Lines (DSL), cable or a satellite link.



TECHNICAL NOTE: If you are using the telephone line at home, disable Call Waiting before you connect through the modem. Call Waiting interrupts data transmission.

After your Internet connection has been made, start your Web browser.

If you are using your computer at the office, then you probably connect to the Internet through your company's network. See your network administrator about connecting to the Internet.

Using a modem

If you're using a modem, you connect the modem to one of the computer's COM (communications) ports. The default setting for the modem is COM3.

If you are having trouble connecting through the modem, you may need to determine the current COM port name and possibly change it.

For more information on connecting a modem, see [“Connecting the modem to a phone line” on page 86.](#)

An overview of using the Internet

The following sections give a quick introduction to the Internet and some of its exciting features, under these headings:

- ❖ The Internet
- ❖ The World Wide Web
- ❖ Signing up with an Internet Service Provider
- ❖ Getting started
- ❖ Surfing the Internet
- ❖ Internet features
- ❖ Uploading and downloading files from the Internet

For more information about the Internet, see [“Lesson 3: Learning about the Internet” on page 118.](#)

The Internet

The Internet is an association of thousands of networks and millions of computers around the world connected by communications lines. They all work together to share information.

The World Wide Web

The World Wide Web (or ‘Web’) is a subset of the Internet — a collection of interlinked documents (located on computers connected to the Internet) that work together using a specific Internet protocol called Hypertext Transfer Protocol (HTTP).

The World Wide Web offers information as text, images, audio, or video to be referenced from anywhere in the world. Special programs called Web browsers are specifically designed to work with HTTP. They make it easier to connect to a particular network address and send and receive information.

Internet Service Providers

To connect a computer directly to the Internet, many people and businesses use an Internet Service Provider (ISP). An ISP is a company that has the equipment and the telecommunication lines necessary to maintain an Internet connection.

You can connect to the Internet by using a telephone and modem or through other higher-speed communication methods such as Digital Subscriber Lines (DSL), cable, and satellite links.

Signing up with an Internet Service Provider



Microsoft’s Web browser, Internet Explorer, which is preinstalled on your system, is automatically configured so that when you first start it, it guides you through signing up for a new ISP account, or assists you in setting up your computer to work with your existing ISP.

Once you have established an ISP account, you can access the Internet.

Surfing the Internet

Once connected to the Internet, the Web browser displays a home page, for example, your ISP's home page on the Internet or your company's Web site home page.

To visit a desired Web site, type in the Web address. The Web address, or Uniform Resource Locator (URL), is a unique identifier for that computer system linked to the Internet. Web addresses can also appear within a Web page's text, and are known as links. Clicking a link automatically transfers your Web browser to that site.

You can also use a Search Engine, a Web site specifically designed to help you look for information.

Internet features

The Internet offers many types of communication tools to help you perform many tasks.

- ❖ Internet email

To send and receive email of your own, you need a mailbox on the Web, or an email address.

If you have an account with an ISP, you can probably set up an email address at the same time as you sign up for the service.

- ❖ Internet chat rooms

A chat room is a Web site that offers a place where people with similar interests and ideas can communicate in real-time, one-on-one or in groups, by typing messages which are instantly viewed by others on their computer screens.

❖ Internet news groups

A news group is similar to a chat room, but instead of using a dedicated site to converse about a specialized subject with others in real-time, it uses a Web site as a clearinghouse where all the messages are placed, like a gigantic bulletin board.

❖ Online shopping

Many Web sites offer products and services for sale.

Uploading and downloading files on the Internet

Transferring files from one computer to another is termed uploading (transferring data from your computer to a site on the Web), or downloading (transferring data from a site on the Web to your computer).

There are several ways to upload or download data. It can be as simple as attaching a file or document to an email, or you can use the HTTP features of your Web browser to transfer large amounts of data. You can also use the File Transfer Protocol (FTP) supported by a separate software program.

Exploring video features

Your computer's video features provide the viewing of presentations or DVD movies on the computer screen.



TECHNICAL NOTE: Video CD playback capability is not enabled on all systems.



HINT: There are no menus for Video CD 1.0 titles.

For more information about using WinDVD, see “WinDVD™” on page 167.

Changing the display properties setting

- 1 Right-click anywhere on your desktop and select **Properties**.

The Display Properties dialog box appears.



Sample Display Properties dialog box

- 2 Click the **Settings** tab.
- 3 Slide the Screen area slider bar toward **Less** until the setting reads **800 x 600**, then click **Apply**.
The screen blinks momentarily while the settings are adjusted.
- 4 The Monitor Settings window appears and asks if you want to keep the settings.
- 5 Click **Yes**.
- 6 To change the settings back, repeat steps 2 through 5.

Display settings hot key

Using the Fn + F5 keys, you can set your system's display to view DVD movies or presentations on an external device. For more information, see "[Display modes](#)" on page 220.

Exploring audio features

You can use your computer to record sounds using an external microphone. You can play .wav sound files or audio CDs using the built-in speakers, headphones or external speakers.

Recording sounds

You can make audio recordings and save them as .wav files by connecting an external microphone or other sound source

to the microphone jack and using the Sound Recorder feature in the operating system.



DEFINITION: A .wav (pronounced “wave”) file is a format for storing sound in files.



TECHNICAL NOTE: If you record MP3 files, you will only be able to play them on a drive capable of playing MP3 files.

Using a microphone

- 1 Connect an external microphone to the computer.
- 2 Click **Start**, point to **All Programs, Accessories, Entertainment**, then click **Sound Recorder**.

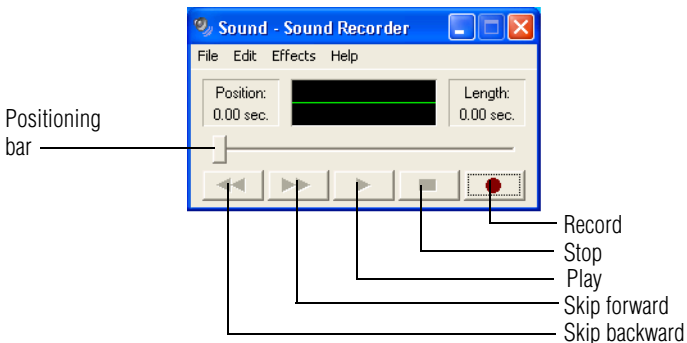

Sample Sound Recorder screen



- 3 Click the **Record** button and speak normally into the microphone.



NOTE: You can only record 60 seconds at a time.



4 When you have finished recording, click the **Stop** button.



5 To hear what you just recorded, click the **Play** button.

6 To save the file, select **Save** from the **File** menu.

Adjusting recording settings

The better the quality of the recording, the more disk space the sound file requires. Experiment to find a balance that fits your needs.

- 1 Open Sound Recorder, if necessary (click **Start**, point to **All Programs, Accessories, Entertainment**, then click **Sound Recorder**).
- 2 In the Sound Recorder window, click **Edit**, then click **Audio Properties**.
- 3 In the Audio Properties dialog box, adjust the Recording Volume and Preferred device.
- 4 Click **OK**.

Your new settings take effect the next time you record.

Using external speakers or headphones

Your computer is equipped with a full stereo sound system with internal speakers. Instead of using the internal speakers, you can connect headphones or a pair of external stereo speakers.



TECHNICAL NOTE: Use amplified speakers that require an external power source. Other types of speakers will be inadequate to produce sound from the computer.

To play back sound files through external speakers or headphones:



- 1 Locate the headphone jack on the left side of the computer.
- 2 Using any necessary adapters, plug the cable from the headphones or external speakers into the headphone jack.

The headphone jack requires a 16-ohm stereo mini-jack.

Connecting a monitor, keyboard and mouse

By connecting an external monitor, external full-size keyboard and a mouse, you can work with your notebook as if it were a standard office desktop computer.



You can connect an external monitor to the RGB (monitor) port. For more information, see [“Back” on page 30](#).



You can connect an external USB-compatible keyboard and a USB-compatible mouse to one of the three USB ports. For more information about connecting a mouse, see [“Connecting a mouse” on page 60](#).

Using the Modular Bay

The Modular Bay gives you additional flexibility. By inserting and removing Modular Bay modules, you can configure your computer for the task at hand without having to carry unnecessary components with you when you travel.



HINT: Items from this list that did not come with your computer can be purchased separately. See the accessories information packaged with your system or visit toshibaaccessories.com.

Removing a module from the Modular Bay



NOTE: Use caution when lifting or turning your computer. Failure to do so may result in damage to components, such as cables, attached to your computer, or to the computer itself.

- 1 Turn off the computer.

You can also hot swap a module in the Modular Bay. Stop the module by clicking the **Safely Remove Hardware** icon on the System tray. After the module is stopped, it is safe to remove.

- 2 Slide the Modular Bay ejection bar towards the front of the computer.

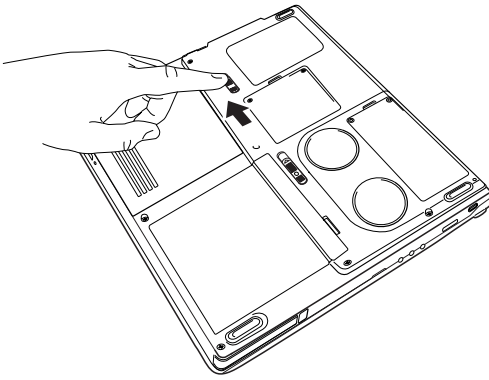

Unlatching the Modular Bay

- 3 Slide the module out of the computer.

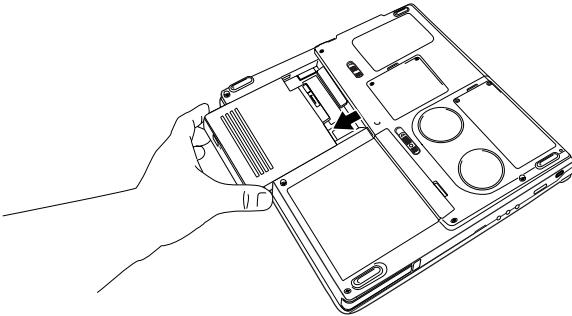

Sliding the module out

Inserting a module into the Modular Bay

To install a module into the Modular Bay, simply slide the module all the way into the Modular Bay.

Using PC Cards

PC Cards expand your computer's capabilities and usefulness. You can purchase additional PC Cards from your dealer. Most PC Cards conform to the PCMCIA (Personal Computer Memory Card International Association) standard.

Your computer has two stacked PC Card slots and supports three types of PC Cards:

- ❖ Two Type I and Type II cards.
- ❖ One Type III card.

Check the documentation that came with the PC Card to see if it conforms to the PCMCIA 2.1 standard, or later. Other cards may work with your computer, but are likely to be much more difficult to set up and use.

PC Card supporting software

PC Cards require Card and Socket Services software — a set of programs that acts as a translator between the PC Card and the computer, and that makes hot swapping (switching cards while the computer is on) possible.

The operating system provides the Card and Socket Services for your PC Card. Even if your PC Card comes with its own version of Card and Socket Services, you should use the files included in the operating system.

Inserting PC Cards



NOTE: Use caution when lifting or turning your computer. Failure to do so may result in damage to components, such as cables, attached to your computer, or to the computer itself.

Before you insert a PC Card, refer to the documentation that comes with the card to see if you need to do anything before you insert it.

To insert a PC Card:

- 1 Turn off the computer.

You may also hot swap a PC Card. Stop the PC Card by clicking the **Safely Remove Hardware** icon on the System tray. After the Safe to Remove Hardware message appears, it is safe to remove the PC Card.

- 2 Align the card connectors with an available PC Card slot and carefully slide the card into the slot until it locks into place.



NOTE: If you have a Type III card, insert the connector into the lower slot. If you have a Type I or Type II card, you can insert it into either the upper or the lower slot.

There are two eject buttons, one per slot.



CAUTION: To avoid damaging the PC Card or the computer, don't force the card into the PC Card slot.

Removing PC Cards

- 1 Stop the PC Card by clicking the **Safely Remove Hardware** icon on the System tray.
After the Safe to Remove Hardware message appears, it is safe to remove the PC Card.
- 2 To remove the PC Card, press the slot's eject button once.
- 3 Remove the PC Card and store it properly.

Hot swapping

One of the great things about PC Cards is that you can replace one PC Card with another while the computer is on. This is called “hot swapping.”

Hot swapping precautions

Although you can insert a PC Card at any time, to avoid data loss never remove a card while it is in use. For example:

- ❖ Never remove a hard disk card while the system is accessing it.
- ❖ Never remove a network card while you are connected to a network.

Before removing a PC Card, stop it by clicking the **Safely Remove Hardware** icon on the System tray. Once the PC Card has stopped, you can safely remove it. See “[Removing PC Cards](#)” on page 165.

Chapter 7

WinDVD™

WinDVD™ is a software program for playing DVDs. This chapter explains how to use this program.

Playing DVDs



TECHNICAL NOTE: For optimum DVD performance, play DVDs while your computer is connected to AC power.

For systems with a DVD-ROM or DVD-R/RW drive, you can use WinDVD to play DVDs. WinDVD is an easy-to-use, full-featured multimedia control center that helps you get the most out of the exciting world of DVD technology. Your computer comes with WinDVD preinstalled.



WARNING: Before playing a DVD, turn down the volume. Playing the disc at maximum volume could damage your ears.

Insert a DVD into the drive. The computer automatically detects the disc in the drive and will prompt you what to do.

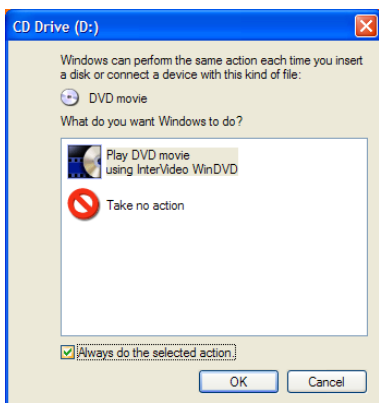

Sample DVD Drive Window



NOTE: If you wish to have WinDVD run automatically, select Play DVD movie using WinDVD, then select the Always do the selected action checkbox. This checkbox is unchecked by default.

To open WinDVD manually:

- 1** Click **Start**, and point to **All Programs**.
- 2** Point to **InterVideo WinDVD**, then click **InterVideo WinDVD**.

The WinDVD player window opens.



Sample WinDVD video window with the control panel

Using the WinDVD slider bar (location)

 The slider bar enables you to move forward or backward through the DVD content. Move the slider bar to the left to go backward or move it to the right to go forward.

Using the WinDVD control panel

The WinDVD control panel resembles the control panel of a standard home DVD player.



TECHNICAL NOTE: The DVD author determines what features the DVD supports. Depending on the DVD format and your computer's hardware configuration, some of the control panel features may be unavailable when playing a DVD. Unsupported features may not appear or may appear gray, and you cannot select them.

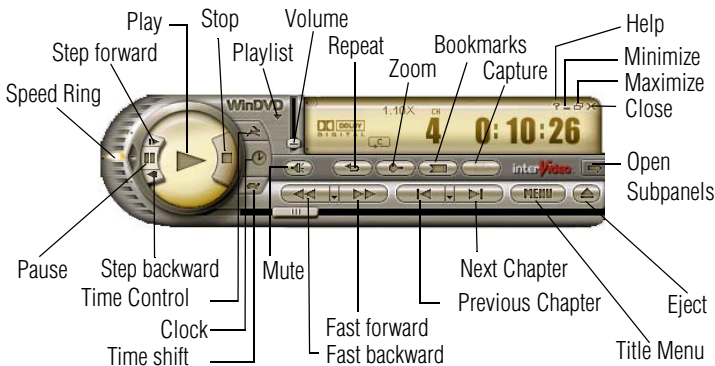

Sample WinDVD control panel

You can open a shortcut menu by positioning the cursor over the WinDVD window (other than over the control panel), then clicking the secondary button. The shortcut menu contains the same features as the control panel, plus the enable caption feature, which displays captions for the hearing impaired.

You can also create a playlist, to customize the order in which the DVD content plays. Once a DVD is playing, the counter displays the current chapter and elapsed time, in *hours:minutes:seconds* format.





From the WinDVD control panel, you can open an expanded control panel by clicking the **expanded controls button**. The expanded control panel contains several advanced features. See “Using WinDVD Advanced Features” on page 174 for an explanation of these features.







Using the control panel playback buttons









Once you have inserted a DVD and started WinDVD, you are ready to play the disc. Using the control panel, you can play a DVD from the beginning, or move to a desired location then begin playing.



Sample WinDVD control panel with expanded view for showing advanced features

<i>Click this</i>	<i>To do this</i>	<i>Or use keyboard shortcut</i>
	Play — starts disc playback.	[spacebar]
	Step forward — steps forward in the playback one frame at a time.	None
	Pause — pauses disc playback. Resume playback by clicking Play.	[spacebar]
	Step backward — steps backward in the playback one frame at a time.	None
	Stop — stops playback. Restart the movie by clicking Play.	[End]

<i>Click this</i>	<i>To do this</i>	<i>Or use keyboard shortcut</i>
	Volume — click and drag the slider up to increase volume and down to decrease volume.	Shift ↑ (increases) Shift ↓ (decreases)
	Speed Ring — enables you to control the speed at which the DVD plays. Move the slider upward to play the movie in fast forward. Move it further upward to increase forward speed. Move the slider downward to play the movie in fast reverse. Move it further downward to increase reverse speed. Placing the slider in the center, or clicking Play, plays the DVD at normal speed. This will play the DVD at normal speed.	
	Time Control — click to increase playback speed.	None
	Clock — enables you to select and control playback time.	None
	Time shift — click to slow playback speed.	None
	Fast Back — starts fast reverse movie playback.	R
	Fast Forward — starts fast forward movie playback.	F

<i>Click this</i>	<i>To do this</i>	<i>Or use keyboard shortcut</i>
	Previous Chapter — skip to the previous chapter in the movie.	PgUp
	Next Chapter — skip to the next chapter in the movie.	PgDn
	Title Menu — opens the title menu of the inserted DVD.	T
	Mute — click to mute movie sound. Click again to restore movie sound to its original level.	M
	Repeat — shows the current media loop settings, including repeat chapter, repeat title, loop, or no repeat.	[Ctrl] B
	Zoom — zooms in on the movie window for a closer look. After zooming in, you can pan around to see other areas of the image.	None
	Bookmarks — opens the Bookmark browser, which enables you to bookmark scenes in a movie so that you can skip to them when selected.	[K]
	Capture — opens the Capture browser, which enables you to capture still images of a movie.	None

<i>Click this</i>	<i>To do this</i>	<i>Or use keyboard shortcut</i>
	Eject — ejects the disk. If the disk is still playing, this button stops play before the disk is ejected.	E

Maximizing the video window



To close the WinDVD control panel and expand the video window to fill the screen, click the Maximize button.

To display the control panel again, double-click anywhere in the video window.

Using WinDVD Advanced Features



TECHNICAL NOTE: The DVD author determines what features the DVD supports. Depending on the DVD format and your computer's hardware configuration, some of the control panel features may be unavailable when playing a DVD. Unsupported features may not appear or may appear gray, and you cannot select them.

The features described in this section may be available on the WinDVD expanded control panel. To open the expanded control panel, click the expanded controls button on the WinDVD main control panel. Select from the following options: Navigation, Language, Display, Color, and Audio effect.



Sample WinDVD with expanded subpanel

Using playlists



TECHNICAL NOTE: The DVD author determines what features the DVD supports. Depending on the DVD format and your computer's hardware configuration, some of the control panel features may be unavailable when playing a DVD. Unsupported features appear gray, and you cannot select them.

The playlist selection options are accessed by selecting the **Expand subpanel** button and the Navigation submenu. The playlist options are found within the Navigation menu.

Options to use and create playlists allow you to open files, open existing playlists, create new playlists, and select DVDs from an existing folder. A playlist is a customized list of DVD files in the order in which you want to view them. For example, you may want to create a playlist for DVDs that contain music files, so you can play the music selections you want in the order you want to hear them. You can only save one playlist at a time.



NOTE: Some audio and video formats are not supported.

Creating a Playlist

To create a new playlist:



- 1 Open the playlist menu by clicking the **Playlist** button. See “Using the WinDVD control panel” on page 170. to locate the playlist button.

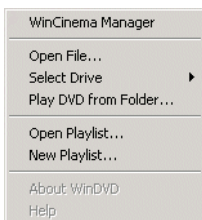

Sample Playlist dialog

- 2 Select **New Playlist** from the menu.

The Playlist window opens.

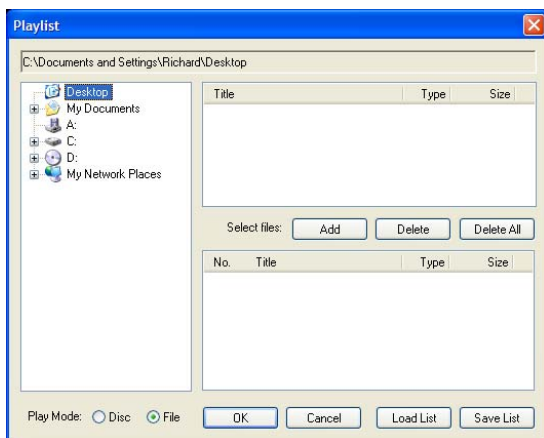

Sample WinDVD Playlist window

- 3 Select **File** to enable selection of a file, or **Disc** to create a playlist for an entire disc.

- 4 Locate each file (you may select multiple files) for your playlist using the directory browser.
- 5 Highlight the files and click **Add**, then **OK** to confirm your selection.
- 6 After adding all the files you want to include in the new playlist, click **Save List**.

The Save As dialog appears.

- 7 Browse to the folder where you want to save your playlist, name the playlist, then click **Save**.

Playlist files are saved with the file extension .plf. The playlist can be reopened and played.

Playing a Playlist

After creating a new playlist, you can open it with WinDVD. The playlist keeps your selections organized so that you can play your favorites at any time.

To play a playlist:



- 1 Open the playlist menu by clicking the **Playlist** button. See “Using the WinDVD control panel” on page 170. to locate the playlist button.

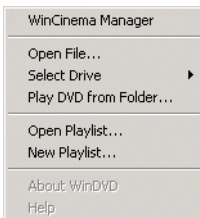

Sample Playlist dialog

- 2 Select **Open Playlist** from the menu.

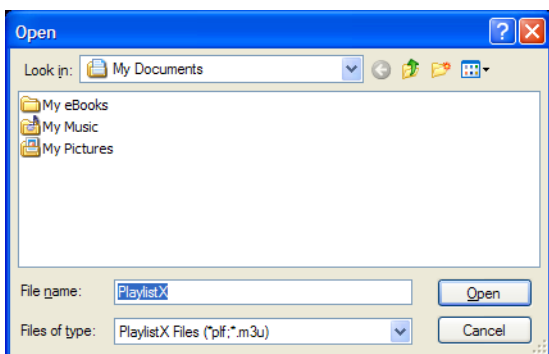

Sample Open Playlist dialog

- 3 Locate the playlist you wish to open, then click **Open**.
The Playlist window appears.
- 4 Click **Load List** to open the saved playlists.
- 5 Browse to the playlist you want to open then click **Open** and WinDVD displays the playlist.

Getting Help



Click the **Help** button to open the WinDVD Help system.

Exiting WinDVD



Click the **Close** button, to exit WinDVD.

Chapter 8

If Something Goes Wrong

Some problems you may encounter when using your notebook computer are relatively easy to identify and solve. Others may require help from your dealer or the manufacturer of a software program.

This chapter aims to help you solve many problems by yourself. It covers the problems you are most likely to encounter.

If all else fails, contact Toshiba. You will find information on Toshiba's support services at the end of this chapter.

Your program stops responding.

If you are working with a program that suddenly freezes all operations, chances are the program has stopped responding. You can exit the failed program without shutting down the operating system or closing other programs.

To close a program that has stopped responding in the Windows® XP operating system:

- 1 Press Ctrl, Alt, and Del simultaneously.
- 2 The Windows Task Manager appears.
- 3 Click the **Applications** tab.

If a program has stopped responding, the words “not responding” appear beside its name in the list.

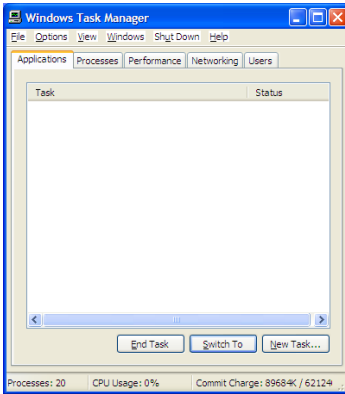

Windows Task Manager Applications tab

- 4 Select the program you want to close, then click **End Task**.

Closing the failed program should allow you to continue working. If it does not, continue with step 3.

- 5 Close the remaining programs one by one by selecting the program name, then **End Task**.
- 6 Select the **Shut Down** menu, then click **Turn Off**.

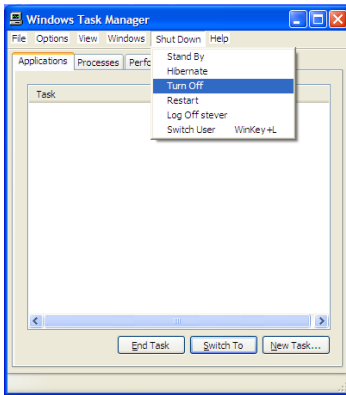

Windows Task Manager Shutdown menu, Turn Off option

The computer shuts down.

Your program performs an illegal operation.

If you receive the message, “Your program has performed an illegal operation,” you should record the details of the message and consult the software manufacturer.

To record the details:

- 1** Click the **Details** button and select the text the operating system displays.
The Details button displays information that the software manufacturer needs to help you solve your problem.
- 2** Press Ctrl and c simultaneously to copy the text to the clipboard.
- 3** Open Notepad (click **Start**, point to **All Programs**, then point to **Accessories** and click **Notepad**).
- 4** Press Ctrl and v simultaneously to paste the details into Notepad.
- 5** Add a paragraph break and type some notes describing what you were doing when you received the message.

- 6 Save the file and refer to it when you contact the software manufacturer.

Problems when you turn on the computer

These problems may occur when you turn on the power.

The computer will not start.

Make sure you attached the AC adapter and power cable properly or installed a charged battery.

Press and hold down the power button for a few seconds.

If you are using the AC adapter, check that the wall outlet is working by plugging in another device, such as a lamp.

The computer starts but, when you press a key, nothing happens.

You are probably in Standby mode and have a software or resource conflict. When this happens, turning the power on returns you to the problem instead of restarting the system. To clear the condition, press the power button until it turns off the computer.

Clearing the condition may get the computer running, but it won't solve a resource conflict. Read the documentation that came with the conflicting device and [“Resolving a hardware conflict” on page 185](#).

The computer displays the WARNING RESUME FAILURE message.

The computer was placed in Standby mode and the battery has discharged. Data stored in the computer's memory has been lost. Press Enter to continue booting.

To charge the battery, leave the computer plugged into a live wall outlet for several hours. For more information, see [“Power and the batteries” on page 190](#).

The computer displays the Non-System disk or disk error message.

Press any key. If this does not resolve then problem, press Ctrl, Alt, and Del to restart the computer.

The Windows® operating system is not working

Once you are familiar with the desktop and used to the way the operating system responds to your work routine, you can easily detect if the operating system is not working correctly. For example:

- ❖ The operating system fails to start after the Starting Windows XP message appears.
- ❖ The operating system takes a long time to start.
- ❖ The operating system responds differently from the normal routine.
- ❖ The screen does not look right.

Unless a hardware device has failed, problems usually occur when you change the system in some way such as installing a new program or adding a device.

If you experience any of these problems, use the options in the Startup menu to fix the problem.

Using Startup options to fix problems

If the operating system fails to start properly, you may have to change your system's configuration or verify the startup procedure to fix the problem. To do this, use the options in the Startup menu.

To open the Startup menu:

- 1 Restart your computer.
- 2 Press F8 when your computer starts.

The Windows® Advanced Options menu displays these options:

- ❖ Safe Mode
- ❖ Safe Mode (with Networking)
- ❖ Safe Mode (with Command Prompt)
- ❖ Enable Boot Logging
- ❖ Enable VGA Mode
- ❖ Last known good configuration (your most recent settings that worked)
- ❖ Directory services restore mode (Windows® domain controllers only)
- ❖ Debugging Mode
- ❖ Start Windows® normally
- ❖ Reboot

For detailed information, refer to your operating system's documentation.

Internet problems

My Internet connection is very slow.

Many factors contribute to the speed with which you can surf the Internet. They include: modem speed, time of day (when everyone else is surfing, your access can be slow) and popularity of the site. If accessing a particular site is very slow, try later.

My browser can't find the URL address I typed in.

Make sure you separated the domain names of the address with the forward slash (/). Check the spelling of each name and the syntax of the address carefully. A single incorrect letter or missed character, comma instead of period ("dot") or other mistake makes it impossible for your browser to locate the site.

My browser can't find a site I bookmarked.

The World Wide Web is constantly changing. A site you bookmarked yesterday may not be available today or its server may be down for temporary repair. Try again later.

The Windows® XP operating system can help you

If the operating system has started properly, but you still have a problem using your computer, the online Help can assist you in troubleshooting the problem.

To access Windows® XP Help and Support:

- 1** Click **Start**, then click **Help and Support**.

The Help and Support window appears.

- 2** Then do one or both of the following:

- ❖ In the search field, type in the topic of the problem with which you need help and follow the on-screen instructions.
- ❖ Click a problem you would like help with from the listings and follow the on-screen instructions.

Resolving a hardware conflict

If you receive an error message telling you there is a device driver conflict or a general hardware problem, try using Windows® Help and Support to troubleshoot the problem first.

For help on hardware conflicts:

- 1** Click **Start**, then click **Help and Support**.

- 2** Click the **Hardware** link in the window.

A list of category links appear.

- 3** Click the **Fixing a hardware problem** or other appropriate link.

- 4 Choose from specific topics and follow the steps.

If there is still a problem, the operating system should display a message that explains what the conflict is.

A plan of action

The smooth operation of the system depends on the interaction of all devices, programs, and features. If the system or one of its attached devices isn't working, resolving the problem can be time-consuming and frustrating.

The recommended procedure for getting multiple devices to work together is to add and set up one device at a time. After you add each device, test it to make sure it and all previously connected devices work.

The device most recently connected to the system is the one most likely to be causing a hardware conflict.

Resolving hardware conflicts on your own

Computer components need resources to accomplish a task. A device, such as a disk drive or a modem, needs a channel to the computer's Central Processing Unit (CPU). It also needs a direct channel to the computer's memory to store information as it works. These channels of communication are commonly referred to as system resources.

Direct Memory Access

Similarly, the data required by the device is stored in a specific place or address in memory called the Direct Memory Access (DMA). The DMA provides a dedicated channel for adapter cards to bypass the microprocessor and access memory directly. If two or more devices use the same DMA, the data required by one device overwrites the data required by the other. That may cause a hardware conflict.

Plug and Play

With Plug and Play and the Windows® XP operating system, avoiding hardware conflicts is easy. Plug and Play is a computer standard that helps the system BIOS (basic input/output system) and the operating system to automatically assign resources to Plug and Play-compliant devices. In theory, if every device connected to the computer is Plug and Play-compliant, no two devices will compete for the same system resources. Simply plug in the device and turn on your computer. The operating system automatically sets up your system to accommodate the new device.

If you install an older (legacy) device that the operating system cannot recognize, the operating system may have difficulty assigning resources to it. As a result, a hardware conflict can occur. To see what resources the operating system has assigned to the device, see [“Checking device properties” on page 189](#).

Resolving conflicts

There are three things you can do to resolve hardware conflicts:

- ❖ **Disable the device.**
For an older device, remove it from the computer. For a Plug and Play device.
- ❖ **Disable another system component and use its resources for the new device.**
- ❖ **Reconfigure the device so that its requirements do not conflict.** Refer to the device’s documentation for instructions about changing settings on the device.

Fixing a problem with Device Manager

Device Manager provides a way to check and change the configuration of a device.



CAUTION: Changing the default settings using Device Manager can cause other conflicts that make one or more devices unusable. Device Manager is a configuration tool for advanced users who understand configuration parameters and the ramifications of changing them.

Disabling or enabling a device

- 1 Click **Start**, click the **My Computer** icon with the secondary button, then click **Properties**.
The System Properties dialog box appears.
- 2 Click the **Hardware** tab.
- 3 Click the **Device Manager** button.
- 4 Select the specific device from the device category.
- 5 To enable a device, look at the far right of the toolbar. Look for an icon of a monitor with a strike mark through a circle on the front. When you mouse over the small icon, the status of Disabled displays.

To disable a device, look at the far right of the toolbar. Look for an icon of a monitor with a blue check mark on it. When you mouse over the small icon, the status of Enabled displays.

- 6 Click the icon.
You are given the option of disabling or enabling the device.
- 7 Click **yes** or **no**, whichever is appropriate.

Checking device properties

Device Manager provides a way to view the properties of a device. Properties include the name of the manufacturer, the type of device, the drivers installed, and the system resources assigned to the device.

To check a device's properties:

- 1 Click **Start**.
- 2 Click **My Computer** with the secondary button, then click **Properties**.
The System Properties dialog box appears.
- 3 Click the **Hardware** tab.
- 4 Click the **Device Manager** button.
- 5 To view the device(s) installed, double-click the device type.
- 6 To view the properties, double-click the device.

The operating system displays the Device Properties dialog box, which provides an array of tabs. They include:

- ❖ The **General** tab, which provides basic information about the device.
- ❖ The **Resource** tab, which lists resources assigned to the monitor, DVD-ROM, and other power-using functions.
- ❖ The **Drivers** tab, which displays the drivers being used by the device.

A Troubleshooting button is also present.

Click **troubleshooting**.

A Help and Support window for that device appears.

For more information about Device Manager, refer to Windows[®] XP online help.

Memory card problems

Incorrectly connected or faulty memory modules may cause errors that seem to be device-related. It is worthwhile checking for these first:

- 1 Turn off the computer via the Start menu.
- 2 Remove the memory module.
- 3 Reinstall the memory module, following the instructions in “Using the computer for the first time” on page 51, and making sure it is seated properly.
- 4 Check for the error again.
- 5 If the error recurs, remove the memory module entirely and check for the error again.

If removing the memory module eliminates the error, the memory module may be faulty. If the error recurs without the memory module installed, the error is not caused by the memory module.



NOTE: Toshiba recommends using only memory approved by Toshiba.

Power and the batteries

Your computer receives its power through the AC adapter and power cable or from the system batteries (main battery and optional secondary battery). Power problems are interrelated. For example, a faulty AC adapter or power cable will neither power the computer nor recharge the batteries.

Here are some typical problems and how to solve them:

The AC power light does not come on when you plug in the AC adapter and power cable.

Make sure the AC adapter and power cable are firmly plugged into both the wall outlet and the computer.

If the AC power light still does not come on, check that the wall outlet is working properly by plugging in a lamp or other appliance.

The AC adapter and power cable work correctly, but the battery will not charge.

The battery doesn't charge while the computer is consuming full power. Try turning off the computer.

The main battery may not be inserted correctly in the computer. Turn off the computer, remove and replace the battery.

The battery may be too hot or too cold to charge properly. If you think this is the probable cause, let the battery reach room temperature and try again.

If the battery has completely discharged, it will not begin charging immediately. Leave the AC adapter and power cable connected, wait 20 minutes and see if the battery is charging.

If the battery light is glowing after 20 minutes, let the computer continue charging the battery for at least another 20 minutes before you turn on the computer.

If the battery light does not glow after 20 minutes, the battery may have reached the end of its useful life. Try replacing it.

The battery appears not to power the computer for as long as it usually does.

If you frequently recharge a partially charged battery, it may not charge fully. Let the battery discharge completely, then try charging it again.

Check the power options using the Toshiba Power Management Utility. Have you added a device, such as a PC Card or memory module, that takes its power from the battery? Is your software using the hard disk more? Is the display power set to turn off automatically? Was the battery fully charged to begin with? All these conditions affect how long the charge lasts.

For more information on maximizing battery power, see “Charging the battery” on page 99.

Keyboard problems

If, when you type, strange things happen or nothing happens, the problem may be related to the keyboard itself.

The keyboard produces unexpected characters.

A keypad overlay may be on. If the numeric keypad or cursor control light is on, press Fn and F10 simultaneously to turn off the cursor control light or press Fn and F11 simultaneously to turn off the numeric keypad light.

If the problem occurs when both the keypad overlays are off, make sure the software you are using is not remapping the keyboard. Refer to the software’s documentation and check that the program does not assign different meanings to any of the keys.

You have connected an external keyboard and the operating system displays one or more keyboard error messages.

If you have a second keyboard, try it. If it works, the first keyboard may be defective or incompatible with your computer.

Display problems

Here are some typical display problems and their solutions:

The display is blank.

Display Auto Off may have gone into effect. Press any key to activate the screen.

You may have activated the instant password feature by pressing Fn and F1 simultaneously. If you have registered a password, press the Enter key, type the password and press Enter. If no password is registered, press Enter. The screen reactivates and allows you to continue working.

If you are using the built-in screen, make sure the display priority is not set for an external monitor. To do this, press Fn and F5 simultaneously (once). If this does not correct the problem, press Fn and F5 simultaneously again to return the display priority to its previous setting.

If you are using an external monitor:

- ❖ Check that the monitor is turned on.
- ❖ Check that the monitor's power cable is firmly plugged into a working power outlet.
- ❖ Check that the cable connecting the external monitor to the computer is firmly attached.
- ❖ Try adjusting the contrast and brightness controls on the external monitor.
- ❖ Press Fn and F5 simultaneously to make sure the display priority is not set for the built-in screen.

The screen does not look right.

You can change the display settings by clicking a blank area of the desktop with the secondary control button, then clicking Properties. This opens the Display Properties dialog box. The Appearance tab of this dialog box allows you to choose the colors for the screen. The Settings tab allows you to choose the screen resolution.

The built-in screen flickers.

Some flickering is a normal result of the way the screen produces colors. To reduce the amount of flickering, try using fewer colors.

To change the number of colors displayed:

- 1** Point at the desktop and click with the secondary button.
- 2** Click **Properties**, and then the **Settings** tab.
- 3** Choose a lower quality color option and click **OK**.

For more information, see Windows[®] Help.

A message tells you that there is a problem with your display settings and that the adapter type is incorrect or the current settings do not work with your hardware.

Reduce the size of the color palette to one that is supported by the computer's internal display.

To change the display properties:

- 1 Point at the desktop and click with the secondary button. The Display Properties window appears.
- 2 Click **Properties**, then click the **Settings** tab.
- 3 Adjust the screen resolution and/or color quality.
- 4 Click **OK**.

The display mode is set to Simultaneous and the external display device does not work.

Make sure the external monitor is capable of displaying at resolutions of 800 x 600 or higher. Devices that do not support this resolution will only work in Internal/External mode.

Disk drive problems

Problems with the hard disk usually show up as an inability to access the disk or as sector errors. Sometimes a disk problem may cause one or more files to appear to have garbage in them. Typical disk problems are:

You are having trouble accessing a disk, or one or more files appear to be missing.

Make sure you are identifying the drive by its correct name (for example, C:).

Error-checking

Run Error-checking, which analyzes the directories, files and NT file system (NTFS) on the disk and repairs any damage it finds:

To run Error-checking:

- 1 Click **Start**, then click **My Computer**.
- 2 Right-click the drive you want to check.
The drive's properties box appears.
- 3 Click on **Properties**.
- 4 Click the **Tools** tab.
- 5 Click the **Check now** button.
The Check Disk box appears (for example, Check Disk C).
- 6 You can choose one or both options:
 - ❖ Automatically fix file system errors
 - ❖ Scan for and attempt recovery of bad sectors
 - ❖ Click **Start**.

Error-checking runs the test.

Your hard disk seems very slow.

If you have been using your computer for some time, your files may have become fragmented. Run Disk Defragmenter. To do this, click **Start**, point to **All Programs, Accessories, System Tools**, and click **Disk Defragmenter**.

Your data files are damaged or corrupted.

Refer to your software documentation for file recovery procedures. Many software packages automatically create backup files.

You may also be able to recover lost data using utility software, which is available from your dealer.

Some programs run correctly but others do not.

This is probably a configuration problem. If a program does not run properly, refer to its documentation and check that the hardware configuration meets its needs.

DVD-ROM or multifunction drive problems

You cannot access a disc in the drive.

Make sure the drive tray has closed properly. Press gently until it clicks into place.

Open the drive tray and remove the disc. Make sure the drive tray is clean. Any dirt or foreign object can interfere with the laser beam.

Examine the disc to see whether it is dirty. If necessary, wipe it with a clean cloth dipped in water or a neutral cleaner.

Replace the disc in the tray. Make sure it is lying flat, label side uppermost. Press the disc down until it locks on the spindle. Close the drive tray carefully, making sure it has shut completely.

You press the disc eject button, but the drive tray does not slide out.

Make sure the computer is connected to a power source and turned on. The Modular Bay drive eject mechanism requires power to operate.

To remove a disc without turning on the computer, use a narrow object, such as a straightened paper clip, to press the manual eject button. This button is in the small hole next to the disc eject button on the right side of the computer.



CAUTION: Never use a pencil to press the manual eject button. Pencil lead can break off inside the computer and damage it.

Pull the tray fully open, remove the disc and place it in its

Some discs run correctly, but others do not.

If the problem is with an application CD-ROM, refer to the software's documentation and check that the hardware configuration meets the program's needs.

The color of the materials used to make the disc can affect its reliability. Silver-colored CD-ROMs are the most reliable, followed by gold-colored CD-ROM. Green-colored CD-ROMs are the least reliable.

WinDVD problems: General issues

WinDVD™ has been configured to provide optimum performance and quality based upon your system's available resources. Changes made to the system or its configuration may impact the playback performance of the WinDVD player.

WinDVD controls are disabled.

Controls may be grayed out by commands on the DVD. For example, it is common for DVD movie titles to disable fast-forward and rewind during the legal notices at the beginning of a movie.

Playback performance is poor.

The use of DMA dramatically increases the DVD playback performance of your system.

To make sure DMA is turned on and to check its settings:

- 1** Click **Start**, then **Control Panel**.
- 2** Click the **Performance and Maintenance** icon, then click the **System** icon.
- 3** Click **Hardware** tab, then the **Device Manager** button.
- 4** Double-click **IDE ATA/ATAPI controllers** to expand it, then double-click **Secondary IDE Channel**.

The Properties Box appears.

- 5** Select the **Advanced Settings** tab, then select **DMA if available** from the **Transfer Modes** drop-down list. In the correct device area, click **OK**.
- 6** The system must be restarted for this setting to take effect.

The Root or Title menu does not open.

Most DVD titles have one or both of the “Root” and “Title” menus. If one menu button appears to do nothing, try the other menu button.

WinDVD performance decreases after making a system change.

DVD playback performance is dependent upon several system resources. Changes to these system resources caused, for example, by installing a new graphics or audio card may impact performance. Some software changes may also impact playback performance (for example, downloading new drivers from the Web).

Before installing a new hardware or software component on your system, check for any potential conflicts between its resource requirements and your current system configuration. Also, if you change your operating system, check with your PC manufacturer or your graphics card vendor to ensure that you have the appropriate drivers for both your hardware (for example, the graphics card) and software (drivers must support the operating system and DVD with WinDVD).

Slow playback performance.

DVD playback is a resource intensive application. Other applications and/or changes to your system hardware, software or configuration can impact playback performance. If playback is slower than normal, try:

- 1** Closing any other open applications to improve the performance of the DVD playback.
- 2** Ensuring DMA is turned on. (See [“Playback performance is poor.”](#) on page 197.)
- 3** If you have installed new hardware (such as a new graphics card or audio card), ensure the component’s drivers support Microsoft® DirectX® 5.2b or higher and WinDVD. Contact the manufacturer of the component.

-
- 4 Verifying that your display driver resolution, color depth and refresh rate are optimal for DVD playback. (Some systems do not support video overlays if these parameters are not optimal.) Try lowering these settings to improve performance.

WinDVD problems: Content issues

Movies exhibit poor performance of “Director's Commentary” or other similar optional content versions.

Some movies may exhibit poor performance of these features. In particular, the video portion of the movie may become jerky or show pauses. The normal version of the movie will not show this problem.

WinDVD will not function properly with “debug” software installed.

The WinDVD application will not function properly if it detects that debug software is present on the system. Remove the debug software to restore functionality of WinDVD.

Minimum system requirements

WinDVD performs best when these recommended components are present in your system:

- ❖ Sound card (with 48 KHz sampling rate support)
- ❖ DirectX® Foundation 6.0 or higher (Source: Microsoft)
- ❖ DirectShow® 6.0 (Source: Microsoft)
- ❖ DVD-ROM drive with DMA enabled (only available with Microsoft OSR 2.1 or above with PIXX 4.0 and USB support added)
- ❖ WinDVD software

WinDVD: Error messages

This table offers descriptions and resolutions for error messages that may appear when using WinDVD.

<i>Error message and additional information</i>	<i>Resolution</i>
<p>The disc in the DVD-ROM drive is not a valid disc type.</p> <p>Valid disc types are DVD-Video and audio CD.</p>	<p>Ensure the disc is a valid disc type.</p> <p>If the disc works in other players, try using a disc cleaner.</p> <p>The disc may require features that are not supported by WinDVD.</p>
<p>Microsoft[®] DirectShow[®] components are missing.</p> <p>Microsoft[®] DirectShow[®] is not installed properly on the system.</p>	<p>Reinstall Microsoft[®] DirectShow[®] version 6.0 or higher (available from the Microsoft Web site).</p>
<p>No audio subsystem could be found for playback.</p> <p>There is a problem with the audio card or audio component within the system. The problem may be one of the following:</p> <p>The audio card is faulty.</p> <p>There is a problem with the audio driver.</p>	<p>Check installation of the sound card drivers.</p>

<i>Error message and additional information</i>	<i>Resolution</i>
<p>WinDVD cannot display the selected resolution due to system limitations.</p> <p>The screen size exceeds the allowable display limit. There are not enough system resources to play the DVD at the selected setting.</p>	<p>Alter the display settings to reduce the resolution or number of colors.</p> <p>Update video drivers.</p>
<p>The audio settings are incorrect. Please check sound card or drivers.</p> <p>The audio card was found, but there is a problem with the audio card or drivers. The wrong audio driver may be installed in the system.</p>	<p>Check installation of the audio card drivers.</p>
<p>An unexpected error has occurred.</p> <p>This error is unclassified. Report the problem and any error code to your supplier's Technical Support.</p>	<p>This is usually a rare, title-specific problem.</p>

<i>Error message and additional information</i>	<i>Resolution</i>
<p>There is a problem with the copy protection system within the DVD-ROM drive. Playback cannot continue.</p> <p>The DVD-ROM drive failed to authenticate (authorize playback of) the DVD disc. There may be a problem with the DVD-ROM drive.</p>	<p>Try to play another disc. Contact your supplier's Technical Support.</p>
<p>WinDVD does not support this version of the DVD specification.</p>	<p>Check that this is a DVD-Video 1.0 disc.</p>
<p>This DVD disc cannot be played in this region.</p> <p>The selected region cannot be used due to one of the following:</p> <p>The Region Code of WinDVD and the DVD disc do not match. Check the Region Code of WinDVD within the About tab and use a disc from the appropriate region.</p> <p>The Windows operating system is assigned to a region that does not match the Region Code of WinDVD.</p>	<p>Use DVD content from the appropriate region. If applicable on your system, refer to the Help file for how to change the Region Code.</p>

<i>Error message and additional information</i>	<i>Resolution</i>
Permission to play is denied. Please check the Parental Control setting. The Parental Control setting of WinDVD is lower than the Parental Control level of the content being played. Playback of the DVD disc is not authorized.	Change the Parental Control level in the DVD Options dialog. Note that WinDVD requires a password for this change.
WinDVD encountered an error.	Report the problem and any error code to your supplier's Technical Support.
This file appears to contain unsupported data.	Please refer to the Supported Formats section of the WinDVD Help file and ensure that this file contains valid data.
The drive or disc cannot be found. This may be caused by one of the following: No disc in the DVD-ROM drive. No DVD-ROM drive. A disc of an unsupported type in the DVD-ROM drive.	Check the Modular Bay drive or DVD disc. Ensure the disc is a valid type (DVD-Video, Video CD, or audio CD).

Sound system problems

You do not hear any sound from the computer.

Adjust the volume control.

If you are using external headphones or speakers, check that they are securely connected to your computer.

The computer emits a loud, high-pitched noise.

This is feedback between the microphone and the speakers. It occurs in any sound system when input from a microphone is fed to the speakers and the speaker volume is too loud. Adjust the volume control.

Changing the settings for the Record Monitor feature in the Recording Control Utility (default Off), or the Mute feature in the Mixer Utility (default Enabled), may cause feedback. Revert to the default settings.

PC Card problems

PC Cards (PCMCIA-compatible) include many types of devices, such as a removable hard disk, additional memory, or a pager.

Most PC Card problems occur during installation and setup of new cards. If you're having trouble getting one or more of these devices to work together, several sections in this chapter may apply. Verify with the PC Card documentation that it is compatible with Windows® XP.

Resource conflicts can cause problems when using PC Cards. See [“Resolving a hardware conflict” on page 185](#).

Card Information Structure

When you insert a PC Card into a slot, the computer attempts to determine the type of card and the resources it requires by reading its Card Information Structure (CIS). Sometimes the CIS contains enough information for you to use the card immediately.

Other cards must be set up before you can use them. Use the Windows[®] XP PC Card (PCMCIA) Wizard to set up the card. Refer to your Microsoft[®] documentation for more information, or refer to the documentation that came with the PC Card.

Some card manufacturers use special software called *enablers* to support their cards. Enablers result in nonstandard configurations that can cause problems when installing the PC Card.

If your system does not have built-in drivers for your PC Card and the card did not come with an operating system driver, it may not work under the operating system. Contact the manufacturer of the PC Card for information about using the card under the operating system.

PC Card checklist

- ❖ Make sure the card is inserted properly into the slot.
See [“Inserting PC Cards” on page 164](#) for how to insert PC Cards.
- ❖ Make sure all cables are securely connected.
- ❖ Make sure the computer is loading only one version of Card and Socket Services.
- ❖ Occasionally a defective PC Card slips through quality control. If another PCMCIA-equipped computer is available, try the card in that machine. If the card malfunctions again, it may be defective.

Resolving PC Card problems

Here are some common problems and their solutions:

The slots appear to be dead. PC Cards that used to work no longer work.

Check the PC Card status:

- 1 Click **Start**.

- 2 Click **My Computer** icon with the secondary button, then click **Properties**.

The System Properties dialog box appears.

- 3 Click the **Hardware** tab.
- 4 Click the **Device Manager** button.
- 5 Double-click the category listed as **PCMCIA adapter**.

The operating system displays your PC Card's Properties dialog box, which contains information about your PC Card configuration and status.

The computer stops working (hangs) when you insert a PC Card.

The problem may be caused by an I/O (input/output) conflict between the PCMCIA socket and another device in the system. Use Device Manager to make sure each device has its own I/O base address. See [“Fixing a problem with Device Manager” on page 188](#) for more information.

Since all PC Cards share the same socket, each card is not required to have its own address.

Hot swapping (removing one PC Card and inserting another without turning the computer off) fails.

Follow this procedure before you remove a PC Card:

- 1 Click the **PC Card** icon in the system tray.
- 2 Click **Stop xxxx**, where *xxxx* is the identifier for your PC Card.

The operating system displays a message that you may safely remove the card.

- 3 Remove the card from the slot.

The system does not recognize your PC Card or PCMCIA socket controller.

- 1 Make sure the computer is not in Standby mode. For more information, see [“Using Stand by” on page 94](#).

- 2** Turn off the computer.
- 3** Connect the AC adapter and power cable.
- 4** Keep the computer plugged in for about three hours with the power turned off.

The problem may also be caused by a conflict with any additional memory in your system.

Removing a malfunctioning card and reinstalling it can correct many problems. For more information, see [“Inserting PC Cards” on page 164](#).

A PC Card error occurs.

Reinsert the card to make sure it is properly connected.

If the card is attached to an external device, check that the connection is secure.

Refer to the card’s documentation, which should contain a troubleshooting section.

Printer problems

This section lists some of the most common printer problems:

The printer will not print.

Check that the printer is connected to a working power outlet, turned on and ready (on line).

Check that the printer has plenty of paper. Some printers will not start printing when there are just two or three sheets of paper left in the tray.

Make sure the USB printer cable is firmly attached to the computer and the printer.

Run the printer’s self-test to check for any problem with the printer itself.

Make sure you installed the proper printer drivers, as shown in [“Setting up a printer” on page 62](#).

You may have connected the printer while the computer is on. Disable Standby mode, turn off the computer, and turn off the printer. Turn the printer back on, make sure it is on line, then turn the computer back on.

Try printing another file. For example, you could create and attempt to print a short test file using Notepad. If a Notepad file prints correctly, the problem may be in your original file.

If you cannot resolve the problem, contact the printer's manufacturer.

The printer will not print what you see on the screen.

Many programs display information on the screen differently from the way they print it. See if your program has a print preview mode. This mode lets you see your work exactly as it will print. Contact the software manufacturer for more information.

Modem problems

This section lists common modem problems:

The modem will not receive or transmit properly.

Make sure the cable from the modem to the telephone line is firmly connected to the computer's modem port and the telephone line jack.

Check the port settings to make sure the hardware and software are referring to the same COM port. See [“Determining the COM port” on page 149](#).

Check the communications parameters (baud rate, parity, data length and stop bits) specified in the communications program. It should be set up to transmit at 300, 1200, 2400, 4800, 9600, 14400, 28800, 33600 bps (bits per second) or higher. Refer to the program's documentation and the modem manual for information on how to change these settings.

The modem is on, set up properly and still will not transmit or receive data.

Make sure the line has a dial tone. Connect a telephone handset to the line to check this.

The other system may be busy or off line. Try making a test transmission to someone else.

Develop good computing habits

Make sure you are prepared.

Save your work frequently.

You can never predict when your computer will lock, forcing you to close a program and lose unsaved changes. Many software programs build in an automatic backup, but you should not rely solely on this feature. Save your work! See [“Computing tips” on page 69](#) for instructions.

On a regular basis, back up the information stored on your hard disk.

Here are some ways you can do this:

- ❖ Copy files to a CD or other media, following the steps in [“Saving your work” on page 74](#).
- ❖ Connect a tape drive to the system and use specialized software to copy everything on the hard disk to a tape.

Some people use a combination of these methods, backing up all files to tape weekly and copying critical files to media, such as a CD, on a daily basis.

If you have installed your own programs, you should back up these programs as well as your data files. If something goes wrong that requires you to reformat your hard disk and start again, reloading all your programs and data files from a backup source will save time.

Read the user's guides.

It's very difficult to provide a fail-safe set of steps you can follow every time you experience a problem with the computer. Your ability to solve problems will improve as you learn about how the computer and its software work together.

Get familiar with all the user's guides provided with your computer, as well as the manuals that come with the programs and devices you purchase.

Your local computer store or book store sells a variety of self-help books you can use to supplement the information in the manuals.

If you need further assistance

If you have followed the recommendations in this chapter and are still having problems, you may need additional technical assistance. This section contains the steps to take to ask for help.

Before you call

Since some problems may be related to the operating system or the program you are using, it is important to investigate other sources of assistance first.

Try the following before contacting Toshiba:

- ❖ Review the troubleshooting information in your Windows® XP documentation.
- ❖ If the problem occurs while you are running a program, consult the program's documentation for troubleshooting suggestions. Contact the software company's technical support group for their assistance.
- ❖ Consult the dealer from whom you purchased your computer and/or program. Your dealer is your best source for current information.

For the number of a Toshiba dealer near you in the United States, call: (800) 457-7777.

Contacting Toshiba

If you still need help and suspect that the problem is hardware-related, Toshiba offers a variety of resources to help you.

- 1** Start with accessing Toshiba on the Internet using any Internet browser by typing support.toshiba.com
- 2** Next, try one of Toshiba's online services. The Toshiba Forum can be accessed through CompuServe® by typing: go toshiba.

Toshiba voice contact

Before calling Toshiba, make sure you have:

- ❖ Your computer's serial number.
- ❖ The computer and any optional devices related to the problem.
- ❖ The recovery CDs that came with your system.
- ❖ Name and version of the program involved in the problem along with its installation CD-ROM.
- ❖ Information about what you were doing when the problem occurred.
- ❖ Exact error messages and when they occurred.

For technical support, call the Toshiba InTouch® Center:

Within the United States at (800) 457-7777

Outside the United States at (949) 859-4273

Other Toshiba Internet Web sites

toshiba.com	Worldwide Toshiba corporate site
computers.toshiba.com	Marketing and product information in the USA
www.toshiba.ca	Canada
www.toshiba-Europe.com	Europe
www.toshiba.co.jp/index.htm	Japan
http://servicio.toshiba.com	Mexico and all of Latin America

Toshiba's worldwide offices

Australia

Toshiba (Australia) Pty. Limited
84-92 Talavera Road
North Ryde NSW 2113
Sydney
Australia

Belgium

Toshiba Information Systems Benelux
(Belgium) B.V.
Excelsiorlaan 40
B-1930 Zaventem
Belgium

Czech Republic

CHG Toshiba, s.r.o.
Hnevkovskeho 65
61700 Brno

Finland

Scribona TPC OY
Sinimäentie 14
P.O. Box 83
02630 ESPOO
Finland

Austria

Toshiba Europe GmbH
Handelskai 388
1020 Wien, Austria

Canada

Toshiba Canada Ltd.
191 McNabb Street
Markham, Ontario
L3R - 8H2
Canada

Denmark

Scribona Danmark A/S
Naverland 27
DK2600 Glostrup
Denmark

France

Toshiba Systèmes (France) S.A.
7, Rue Ampère
92804 Puteaux Cédex
France

Germany

Toshiba Europe GmbH
Leibnizstraße 2
D-93055 Regensburg
Germany

Hungary

Technotrade Kft.
Szerencs utca 202
1147 Budapest
Hungary

Italy

Progetto Elettronica 92 s.r.l.
Viale Certosa 138,
20156 Milano
Italy

Luxembourg

Toshiba Information Systems Benelux B.V.
Rivium Boulevard 41
2909 LK, Capelle a/d IJssel
The Netherlands

Morocco

C.B.I.
22 Rue de Béthune
Casablanca
Morocco

Norway

Scribona Norge A/S
Toshiba PC Service
Stalfjaera 20
P.O. Box 51
Kalbakken
0901 OSLO 9
Norway

Greece

Ideal Electronics S.A.
109 Syngrou Avenue
176 71 Kalithea
Athens
Greece

Ireland

Toshiba Information Systems
(U.K.) Ltd.
Toshiba Court
Weybridge Business Park
Addlestone Road
Weybridge KT15 2UL
United Kingdom

Japan

Toshiba Corporation, PCO-IO
1-1, Shibaura 1-Chome
Minato-Ku, Tokyo, 105-8001
Japan

Mexico and all of Latin America

Toshiba de México S.A.
Sierra Candela No.111, 6to. Piso
Col. Lomas de Chapultepec.
CP 11000 Mexico, DF.

800-457-7777 (outside of the US)

949-859-4273 (within the US - this call may incur long distance charges)

The Netherlands

Toshiba Information Systems Benelux B.V.
Rivium Boulevard 41
2909 LK, Capelle a/d IJssel
The Netherlands

Papua New Guinea

Fujitsu (PNG) Pty. Ltd.
P.O. Box 4952 Boroko
NCD, Papua
New Guinea

Poland

TECHMEX S.A.
ul. Partyzantów 71,
43-316 Bielsko-Biala
01-059 Warszawa
Poland

Singapore

Toshiba Singapore Pte. Ltd.
438B Alexandra Rd. # 06-01
Alexandra Technopark
Singapore 119968

Slovenia

Inea d.o.o.
Ljubljanska 80
61230 Domzale
Slovenia

Sweden

Scribona PC AB
Sundbybergsvägen 1
Box 1374
171 27 Solna
Sweden

United Kingdom

Toshiba Information Systems
(U.K) Ltd.
Toshiba Court
Weybridge Business Park
Addlestone Road
Weybridge KT15 2UL
United Kingdom

The Rest of Europe

Toshiba Europe (I.E.) GmbH
Hammfelddamm 8
D-4-1460 Neuss
Germany

Portugal

Quinta Grande Assistência Técnica
Informática, Lda.
Av. Moinhos no. 15A
Ur. Quinta Grande
2720 Alfragide
Portugal

Slovakia

HTC a.s.
Dobrovicova 8
81109 Bratislava
Slovakia

Spain

Toshiba Information Systems (España) S.A.
Parque Empresarial San Fernando
Edificio Europa, 1a Planta
Escalera A
28831 (Madrid) San Fernando de Henares
Spain

Switzerland

Ozalid AG
Herostrasse 7
8048 Zürich
Switzerland

United States

Toshiba America Information
Systems, Inc.
9740 Irvine Boulevard
Irvine, California 92618
United States

Appendix A

Hot Keys

Hot keys are keys that, when pressed in combination with the Fn key, turn system functions on and off. Hot keys have a legend on or above the key indicating the option or feature the key controls.

Instant password security

Fn +  This hot key blanks the display.

Without a password

The Fn + F1 key combination turns off the display and activates instant security. Using the pointing device or any key will make the display's content reappear, if no password is set for the current user.

With a password

The Fn + F1 key combination turns off the display and activates instant security.

If you set a blank screen saver, pressing the Fn + F1 key combination to activate instant security will cause the screen to go blank. Using the pointing device or any key will make

the display's content reappear. The Windows® operating system log-on screen will appear, prompting you for a password. After typing in the password for the current user, press Enter.

To activate the password feature:

- 1 Click **Start, Control Panel**.
- 2 Click **Appearances and Themes**.
- 3 Click one of the following:
 - ❖ **Choose a screen saver** in the "Pick a task" section.
 - ❖ **Display** in the "or pick a Control Panel icon" section.

The Display Properties window appears.

- 4 If you clicked **Choose a screen saver**, the Screen Saver tab has already been selected. If it isn't selected, click the **Screen Saver** tab.
- 5 Click the **On resume, password protected** check box.
- 6 Click **OK**.

Maintaining security when the battery isn't fully charged

When the battery is not fully charged (even if the computer is operating on AC power) your display may reappear automatically after a short time. To protect your desktop, you must set up a screen saver with a password before activating the password feature.

To set up a password with a screen saver, go to Windows XP help for instructions:

- 1 Click **Start, Help and Support**.
- 2 In the **Search** field, type password screen saver.
- 3 Press Enter.
- 4 Click the **Protect your files with a screen saver password link** located under the suggested topics.

Follow the steps listed in the Windows help to set up your password-protected screen saver.

To ensure the password protection is activated after pressing Fn + F1 (to activate instant security), wait ten seconds before walking away from the computer.

Sound

Fn +  This hot key cycles through the different alarm volume levels.

The alarm volume options are:
Off, Low, Medium, and High.

Off is always first.

Power usage mode

Fn +  This hot key displays the power usage pop-up window and cycles through the battery save modes.

The power usage modes in the operating system under battery power are:

Long Life, Normal, and High Power; DVD Playback, Presentation and Super Long Life

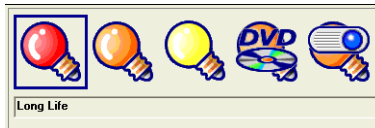

Sample power usage modes

The power usage mode in the Windows[®] operating system under AC power is Full Power only.

The properties of each mode are set in the Toshiba Power Management utility.

Stand by mode

Fn +



This hot key puts the computer into Stand by mode.

- ❖ A message box is displayed by default to confirm that the computer is going into Stand by mode. This message box can be set so it doesn't display.

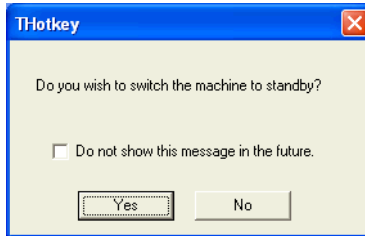

Sample Stand by confirmation box

- ❖ For more information about Stand by mode, please see [“Using Stand by”](#) on [page 94](#).

Hibernation mode

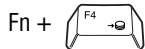

This hot key puts the computer into Hibernation mode.

- ❖ If Hibernation mode is enabled (the default) a message box is displayed by default to confirm the computer is going into Hibernation mode. The message box can be set so it doesn't display.

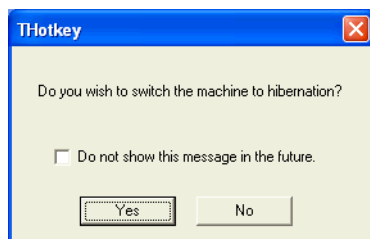

Sample Hibernation confirmation box

- ❖ If Hibernation mode is disabled, this hot key will not respond. For more information on Hibernation mode, see [“Using Hibernation” on page 92.](#)

Display modes

Fn +



This hot key cycles through the power-on display options.

The display modes are:

- ❖ Built-in display panel only
- ❖ Built-in display panel and external monitor simultaneously
- ❖ External monitor only
- ❖ Built-in display panel and external video device simultaneously
- ❖ External video device only



Sample display options window

In order to use a simultaneous mode, you must set the resolution of the internal display panel to match the resolution of the external display device.

Display modes

Fn +



This hot key cycles through the power-on display mode options.

The display mode options are:

Built-in display panel only, Built-in display panel and external monitor simultaneously, External monitor only.

Enabling a wireless device

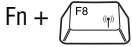

This hot key enables/disables the optional wireless devices in your computer (for systems with Wi-Fi™ or Bluetooth™ only).

The wireless modes are:

Bluetooth™ enabled—This enables only the Bluetooth™ module

Wi-Fi enabled—This enables only the Wi-Fi module.

All devices enabled—This enables both the Bluetooth™ module and the Wi-Fi modules.

All devices disabled—This disables both the Bluetooth™ module and the Wi-Fi modules.



Sample wireless modes window

Disabling or enabling the TouchPad

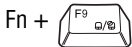

This hot key enables/disables the TouchPad.

To use the TouchPad, see [“Disabling or enabling the TouchPad”](#) on page 53.



Sample disable and enable TouchPad windows

Keyboard hot keys

Fn +  This hot key turns the cursor control overlay on and off.

Fn +  This hot key turns the numeric overlay on and off.

Fn +  This hot key turns the scroll lock feature on and off.

For more information, see [“Overlay keys” on page 72](#).

Appendix B

Power Cable Connectors

Your notebook computer features a universal power supply you can use worldwide. This appendix shows the shapes of the typical AC power cable connectors for various parts of the world.

USA and Canada



UL approved
CSA approved

United Kingdom

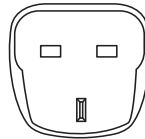

BS approved

Australia



AS approved

Europe



VDA approved
NEMKO approved

Glossary



TECHNICAL NOTE: Some features defined in this glossary may not be available on your computer.

Acronyms

The following acronyms may appear in this user's guide.

AC	alternating current
BIOS	basic input/output system
bps	bits per second
CD	compact disc
CD-ROM	compact disc read-only memory
CD-RW	compact disc rewrite memory
CMOS	complementary metal-oxide semiconductor
COM1	communications port 1 (serial port)
COM2	communications port 2 (serial port)
CPU	central processing unit
DC	direct current

DMA	direct memory access
DIMM	dual inline memory module
DOS	disk operating system
DPI	dots per inch
DSTN	dual supertwist nematic
DVD	digital versatile (or video) disc
DVD-ROM	digital versatile (or video) disc read-only memory
ECP	enhanced capabilities port
EPROM	erasable programmable read-only memory
FAT	file allocation table
FCC	Federal Communications Commission
FIR	fast infrared
GB	gigabyte
HDD	hard disk drive
HTML	Hypertext Markup Language
IEEE	Institute of Electrical and Electronics Engineers
I/O	input/output
IRQ	interrupt request
ISP	Internet service provider
KB	kilobyte
LAN	local area network
LCD	liquid crystal display
LPT1	line printer port 1 (parallel port)
LSI	large-scale integration
MB	megabyte
MIDI	Musical Instrument Digital Interface
NTFS	NT file system
PC	personal computer
PCI	Peripheral Component Interconnect

PCMCIA	Personal Computer Memory Card International Association
RAM	random access memory
RFI	radio frequency interference
ROM	read-only memory
RTC	real-time clock
SCSI	small computer system interface
SDRAM	synchronous dynamic random access memory
SRAM	static random access memory
SVGA	super video graphics adapter
TFT	thin film transistor
USB	universal serial bus
URL	uniform resource locator
WAN	wide area network
www	World Wide Web

Terms

The following terms may appear in this user's guide.

A

active-matrix display — A liquid crystal display (LCD) made from an array of liquid crystal cells using active-matrix technology. Also known as a “TFT display,” in its simplest form there is one thin film transistor (TFT) for each cell. This type of display works well with notebook computers because of its shallow depth and high-quality color. Active-matrix displays are viewable from wider angles than most passive-matrix displays.

adapter — A device that provides a compatible connection between two units. For example, the computer's internal display adapter receives information from the software and translates it into images on the screen. An adapter can take a number of forms, from a microprocessor to a simple connector. An intelligent adapter (one that is capable of doing some processing) may also be called a controller.

alternating current (AC) — The type of power usually supplied to residential and commercial wall outlets. AC reverses its direction at regular intervals. Compare *direct current (DC)*.

application — A computer program that you use to perform tasks of a specific type. Applications include word processors, spreadsheets, and database management systems. See also *program*.

B

backup — A copy of a file, usually on a removable disk, kept in case the original file is lost or damaged.

basic input/output system (BIOS) — See *BIOS*.

baud rate — The speed at which a communication device, such as a printer or modem, transmits information. Baud rate is the number of signal changes per second (not necessarily the same as bits per second). See also *bits per second*.

BIOS (basic input/output system) — Basic instructions, stored in read-only memory (ROM), containing the information the computer needs in order to check hardware and load the operating system when you start up the computer.

bit — Short for “binary digit.” A bit is the smallest unit of information used by a computer. A group of eight bits is a byte. See also *byte*.

bits per second (bps) — A way of measuring the speed at which information is passed between two devices. The basic measure used in modem communications, bps is similar, but not identical, to the baud rate. See also *baud rate*.

boot — To start the computer. The term “boot” originates from bootstrap program (as in “pulling itself up by its bootstraps”), a program that loads and initializes the operating system. See also *reboot*.

boot disk — See *system disk*.

boot priority (startup sequence) — The order in which the computer accesses its disk drives to locate the startup files. Under the default startup sequence, the computer looks for the startup files in the diskette drive before checking the hard disk.

bus — An electrical circuit that connects the central processing unit (CPU) with other parts of the computer, such as the video adapter, disk drives, and ports. It is the pathway through which data flows from one device to another. See also *bus speed*, *frontside bus*.

bus speed — The speed at which the central processing unit (CPU) communicates with the other parts of the computer.

byte — A sequence of eight bits. A byte is the smallest addressable unit of data. See also *bit*, *gigabyte*, *kilobyte*, *megabyte*.

C

cache — A section of very fast memory in which frequently used information is duplicated for quick access. Accessing data from cache is faster than accessing it from the computer's main memory. See also *CPU cache*, *L1 cache*, *L2 cache*.

CD — An individual compact disc. See also *CD-ROM*.

CD-ROM (compact disc read-only memory) — A form of high-capacity storage that uses laser optics instead of magnetic means for reading data. See also *CD*. Compare *DVD-ROM*.

central processing unit (CPU) — The chip that functions as the “brain” of the computer. It takes information from outside sources, such as memory or keyboard input, processes the information, and sends the results to another device that uses the information.

character — Any letter, number, or symbol you can use on the computer. Some characters are non-printing characters, such as a paragraph break in a word-processing program. A character occupies one byte of computer storage.

chip — A small piece of silicon containing computer logic and circuits for processing, memory, input/output, and/or control functions. Chips are mounted on printed circuit boards.

click — To press and release the TouchPad control button or mouse button without moving the cursor or mouse. In the Windows[®] operating system, this refers to the left mouse button or primary TouchPad control button, unless otherwise stated. See also *double-click*.

color palette — A set of specified colors that establishes the colors that can be displayed on the screen at a particular time.

compatibility — The extent to which computers, programs, or devices can work together harmoniously, using the same commands, formats, or language as another.

configuration — (1) The collection of components that make up a single computer system. (2) How parts of the system are set up (that is, configured).

controller — A device that controls the transfer of data from a computer to a peripheral device and vice versa. For example, disk drives, monitors, keyboards, and printers all require controllers.

CPU — See *central processing unit (CPU)*.

CPU cache — A section of very fast memory residing between the CPU and the computer's main memory that temporarily stores data and instructions the CPU will need to execute commands and programs. See also *cache, L1 cache, L2 cache*.

cursor — A symbol that indicates the current position on the screen. The shape of the cursor varies, depending on the program you're using and what you're doing.

D

default — The setting selected by a program when the user does not specify an alternative setting.

device — A component attached to the computer. Devices may be external (outside the computer's case) or internal (inside the computer's case). Printers, disk drives, and modems are examples of devices.

device driver — A program (called a "driver") that permits a computer to communicate with a device.

dialog box — An on-screen window displayed by the operating system or a program giving a direction or requesting input from the user.

direct current (DC) — The type of power usually supplied by batteries. DC flows in one direction. Compare *alternating current (AC)*.

direct memory access (DMA) — A dedicated channel, bypassing the CPU, that enables direct data transfer between memory and a device.

directory — See *folder*.

disable — To turn a computer option off. See also *enable*.

disc — A round, flat piece of metal, designed to be read from and written to by optical (laser) technology, and used in the production of optical discs, such as CDs and DVDs. Compare *disk*.

disk — A round, flat piece of material that can be magnetically influenced to hold information in digital form, and used in the production of magnetic disks, such as diskettes and hard disks. Compare *disc*. See also *diskette*, *hard disk*.

disk drive — The device that reads and writes information and programs on a diskette or hard disk. It rotates the disk at high speed past one or more read/write heads.

diskette — A thin, flexible disk in a protective jacket that stores magnetically encoded data. Diskettes can be removed from the computer and come in two sizes: 5.25-inch and 3.5-inch. Your computer uses 3.5-inch diskettes. See also *double-density diskette*, *high-density diskette*.

document — Any file created with an application and, if saved to disk, given a name by which it can be retrieved. See also *file*.

double-click — To press the TouchPad control button or mouse button rapidly twice without moving the cursor or mouse. In the Windows® operating system, this refers to the primary TouchPad control button or left mouse button, unless otherwise stated.

download — (1) In communications, to receive a file from another computer through a modem or network. (2) To send font data from the computer to a printer. See also *upload*.

drag — To hold down the TouchPad control button or mouse button while moving the cursor to drag a selected object. In the Windows® operating system, this refers to the primary TouchPad control button or left mouse button, unless otherwise stated.

driver — See *device driver*.

DVD — An individual digital versatile (or video) disc. See also *DVD-ROM*.

DVD-ROM (digital versatile [or video] disc read-only memory)
— A very high-capacity storage medium that uses laser optics for reading data. Each DVD-ROM can hold as much data as several CD-ROMs. Compare *CD-ROM*.

E **emulation** — A technique in which a device or program imitates another device or program.

enable — To turn on a computer option. See also *disable*.

executable file — A computer program that is ready to run. Application programs and batch files are examples of executable files. Names of executable files usually end with a *.bat* or *.exe* extension.

extension — See *file extension*.

external device — See *device*.

F **file** — A collection of related information, saved on disk with a unique name. A file may be a program, information used by a program, or a document. See also *document*.

file allocation table (FAT) — The section of a disk that keeps track of the location of files stored on the disk.

file name — A set of characters that uniquely identifies a file within a particular folder. It consists of two parts: the actual name and the file name extension. See also *file extension*.

file extension — The three characters following the period (pronounced “dot”) at the end of a file name. The extension indicates the type of file. Examples are *.exe* for program files and *.hlp* for help files. See also *file name*.

folder — Also called directory. A container for organizing files saved to a disk. A folder is symbolized on screen by a graphical image (icon) of a file folder. A folder can contain files and other folders.

format — (verb) To prepare a blank disk for use with the computer's operating system. Formatting creates a structure on the disk so the operating system can write information to the disk or read information from it.

frontside bus — The primary pathway (bus) between the CPU and the computer's main memory. Also called "system bus." See also *bus*.

function keys — The keys labeled F1 through F12, typically located on the keyboard. Their function is determined by the operating system and/or individual programs.

G

gigabyte (GB) — A unit of data equal to 1,073,741,824 bytes (1024 x 1024 x 1024 bytes). See also *byte*.

ground — A conductor to which all components of an electric circuit are connected. It has a potential of zero (0) volts, is connected to the earth, and is the point of reference for voltages in the circuit.

H

hard disk — A storage device composed of a rigid platter or platters that can be magnetically coded with data. Hard disks hold much more information than diskettes and are used for long-term storage of programs and data. The primary (or only) hard disk in a computer is usually fixed, but some computers have secondary hard disks that are removable. By default, the hard disk is referred to as drive C.

hardware — The physical components of a computer system. Compare *software*.

Hibernate — A feature of many Toshiba notebook computers that saves to the hard disk the current state of your work, including all open files and programs, when you turn the computer off. When you turn on the computer again, your work is returned to the same state it was when the computer was turned off. See also *Standby*, *Suspend*.

high-density diskette — A 3.5-inch diskette that holds 1.44 MB of data. See also *diskette*.

hot key — (1) A feature in which certain keys in combination with the Fn key can set system options or control system parameters, such as the battery save mode. (2) A key or combination of keys that activates a memory resident program.

hot swapping — The ability to add or remove devices from a computer while the computer is running and have the operating system automatically recognize the change.

icon — A small image displayed on the screen that represents a function, file, or program.

interlaced — A method of refreshing a computer screen, in which only every other line of pixels is refreshed. Interlaced monitors take two passes to create a complete screen image. Compare *non-interlaced*.

internal device — See *device*.

Internet — The decentralized, world-wide network of computers that provides electronic mail, the World Wide Web, and other services. See also *World Wide Web*.

keyboard shortcut — A key or combination of keys that you use to perform a task instead of using a pointing device such as the TouchPad.

kilobyte (KB) — A unit of data equal to 1024 bytes. See also *byte*.

L1 (level one) cache — Memory cache built into the processor to help improve processing speed. See also *cache*, *CPU cache*, *L2 cache*.

L2 (level two) cache — Memory cache installed on the motherboard to help improve processing speed. It is slower than L1 cache and faster than main memory. See also *cache*, *CPU cache*, *L1 cache*.

LAN (local area network) — A group of computers or other devices dispersed over a relatively limited area and connected by a communications link that enables any device to interact with any other on the network.

liquid crystal display (LCD) — A type of display that uses a liquid substance between two transparent electrode panels. When an electric current passes through the electrodes, the molecules in the liquid form a crystalline pattern that polarizes the light passing through it. A filter over the electrodes permits only non-polarized light to pass to the surface of the display, creating light and dark pixels.

load — To move information from a storage device (such as a hard disk) into memory for processing.

local area network — See *LAN*.

logical drive — A section of a disk that is recognized by the operating system as a separate disk drive. A system's logical drives may differ from its physical drives. For example, a single hard disk drive may be partitioned into two or more logical drives.

M

megabyte (MB) — A unit of data equal to 1,048,576 bytes (1024 x 1024 bytes). See also *bytes*.

memory — Typically refers to the computer's main memory, where programs are run and data is temporarily stored and processed. Memory can be volatile and hold data temporarily, such as RAM, or it can be nonvolatile and hold data permanently, such as ROM. A computer's main memory is RAM. See *RAM*, *ROM*.

microprocessor — See *central processing unit (CPU)*.

MIDI (Musical Instrument Digital Interface) — A standard for connecting musical instruments, synthesizers, and computers. The MIDI standard provides a way of translating music into a form computers can use, and vice versa.

modem — Short for "modulator/demodulator." A device that converts information from digital to analog and back to digital, enabling information to pass back and forth between digital computers and analog telephone lines.

motherboard — The main circuit board in the computer. It contains the processor, memory, and other primary components.

MS-DOS prompt — See *system prompt*.

multimedia — A combination of two or more media, such as sound, animation, and video in a computer program or presentation.

Musical Instrument Digital Interface — See MIDI.

N

network — A collection of computers and associated devices that are connected by communications facilities. A network allows you to share data and peripheral devices, such as printers, with other users and to exchange electronic mail.

non-interlaced — A method of refreshing a computer screen, in which each pixel of every line is refreshed as the electron beam scans across and down the screen. Compare *interlaced*.

non-system disk — A disk for storing programs and data that cannot be used to start the computer. Compare *system disk*.

NT file system (NTFS) — An advanced file system designed for use specifically with the Windows NT operating system.

O

online — Available through the computer. Online may refer to information being read from your own computer's hard disk, such as online documentation or online help, or to information coming from another company on a company network or the Internet.

operating system — A set of programs that controls how the computer works. Examples of operating systems are Windows® 98 Second Edition and Windows® 2000 operating systems.

P

palette — See *color palette*.

parallel — Processes that occur simultaneously. In communications, it means the transmission of more than one bit of information at a time. On your computer, the parallel port provides a parallel communications interface between the computer and an appropriate device. Most modern printers are parallel. Compare *serial*.

password — A unique string of characters entered by a user to verify his or her identity to the computer or the network.

PC Card — A credit-card-sized expansion card designed to increase the capabilities of notebook computers. PC Cards provide functions such as modem, fax/modem, hard disk drive, network adapter, sound card, or SCSI adapter.

peripheral — Any device, such as a printer or joystick, that is attached to the computer and controlled by the computer's CPU.

pixel — Short for "picture element." The smallest dot that can be produced on a screen or printer.

Plug and Play — Generally, refers to the computer's ability to automatically configure itself to work with peripheral devices. When capitalized, refers to a standard that, when followed by a device manufacturer, allows a PC to configure itself automatically to work with the device.

pointing device — Any device, such as the TouchPad or a mouse, that enables you to move the cursor on the screen.

port — A socket on the computer where you plug in a cable for connection to a network or a peripheral device.

processor — See *central processing unit (CPU)*.

program — A set of instructions that can be executed by a computer. The general classes of programs (also called software) are operating system, application, and utility. See also *operating system, application, utility*.

properties — The attributes of an object or device. For example, the properties of a file include the file's type, size, and creation date.

R

RAM (random access memory) — Volatile memory that can be written to as well as read. By volatile, we mean that information in RAM is lost when you turn off your computer. This type of memory is used for your computer's main memory. See also *memory*. Compare *ROM*.

random access memory — See *RAM*.

read-only memory — See *ROM*.

reboot — See *boot, restart*.

removable disk — A disk that can be removed from a disk drive. A diskette is one example of a removable disk.

resolution — A measure of the sharpness of the images that can be produced by a printer or displayed on a screen. For a printer, resolution is expressed in dots per inch (dpi). For a screen, it is expressed as the number of pixels available horizontally and vertically.

restart — Synonymous with reboot. To reset the computer by reloading the operating system without turning the computer off. See also *boot*.

RJ-11 — A modular connector used on most U.S. telephone systems and direct-connect modems. The RJ-11 connector is a 6-wire connector.

RJ-45 — A connector used to attach computers to LANS (local area networks) and to link ISDN (Integrated Services Digital Network) devices to NT-1 (Network Terminator devices). Also called.

ROM (read-only memory) — Non-volatile memory that can be read but not written to. By non-volatile, we mean that information in ROM remains whether or not the computer is receiving power. This type of memory is used to store your computer's BIOS, which is essential instructions the computer reads when you start it up. See also *BIOS*, *memory*. Compare *RAM*.

S **select** — To highlight or otherwise specify text, data, or graphics with the intent to perform some operation on it.

serial — Processes that occur one at a time. In communications, it means the transmission of one bit at a time sequentially over a single channel. On your computer, the serial port provides a serial interface between the computer and an appropriate device. Compare *parallel*.

shortcut — See *keyboard shortcut*.

software — See *program*. Compare *hardware*.

Standby — A feature of some Windows® operating systems that allows you to turn off the computer without exiting your open applications and to continue from where you left off when you turn the computer on again.

Suspend — A feature of some Windows® operating systems that allows you to turn off the computer without exiting your open applications and to continue from where you left off when you turn the computer on again.

system disk — A diskette that contains the operating system files needed to start the computer. Any diskette can be formatted as a system disk. A system disk is also called a “bootable disk” or a “startup disk.” Compare *non-system disk*.

system prompt — The symbol (in the MS-DOS® operating system, generally a drive letter followed by a “greater than” sign) indicating where users are to enter commands.

T U

TFT display — See *active-matrix display*.

universal serial bus (USB) — A serial bus that supports a data transfer rate of up to 12 Mbps (12 million bits per second). USB can connect up to 127 peripheral devices through a single all-purpose USB port. USB allows hot swapping of peripherals. See also *bus*, *hot swapping*, *serial*.

upload — To send a file to another computer through a modem or network. See also *download*.

USB — See *universal serial bus (USB)*.

utility — A computer program designed to perform a narrowly focused operation or solve a specific problem. Utilities are often related to computer system management.

W

Web — See *World Wide Web*.

World Wide Web (www) — The worldwide network of Web sites linked together over the Internet. A user of the Web can jump from site to site regardless of the location of the computer hosting the site. See also *Internet*.

Index

A

- AC power light 52
- Accessories programs 122, 136
- approved countries for use 14
- audio features 158
- avoiding injury 40

B

- battery
 - caring for 106
 - changing 105
 - charge not lasting 191
 - charging 65, 99
 - conserving power 102
 - disposal 109
 - installing 105
 - light 36, 52, 101
 - monitoring power 101
 - not charging 191
 - power usage mode 217
 - removing 105
 - RTC (real-time clock) 98, 100
- battery cover 38

latch 38

buttons

- CD Player 83
- CD/DVD control 35
- DVD-ROM or multifunction
 - drive eject 78
- Internet 34, 35
- one-touch TV out 35
- PC Card eject 32
- power 34, 35
- Start 113
- TOSHIBA Console 34

C

- calculator 127
- caps lock light 36
- Card and Socket Services 164
- CD and DVDs
 - caring for 85
 - viewing contents 84
- CD Player control panel 83
- CD/DVD control and digital audio
 - modes 79
- CDs

- inserting 81
 - problem solving 196
 - channels
 - DMA 186
 - Character Map 128
 - charging
 - main battery 99
 - RTC (real-time clock) battery 100
 - checking device properties 189
 - cleaning
 - CD or DVDs 85
 - computer 66
 - click 53
 - closing programs 126
 - comfort
 - chair 41
 - lighting 42
 - work habits 43
 - commands
 - Hibernate 89
 - powering down 87
 - Standby 90
 - communications
 - programs 86
 - setting up 86
 - system resources 186
 - via modem 86
 - compact discs
 - inserting 81
 - problem solving 196
 - removing 84
 - computer
 - cleaning 66
 - lock 67
 - moving 67
 - non-system disk or disk error message 183
 - placement 40
 - protection 39
 - running on battery power 98
 - setting up 45, 55
 - transferring information 151
 - turning off 88, 92, 94, 140
 - turning on 51
 - using at the office 148, 161
 - warning resume failure message 182
 - work area 39
 - computing tips 69
 - connecting
 - external monitor 148, 161
 - external speakers 161
 - modem 86
 - mouse 60
 - power cable 49
 - to a network 86
 - USB mouse 60
 - conserving battery power 102
 - Contents
 - CDs 84
 - DVDs 84
 - control buttons 53
 - control buttons for DVD-ROM or multifunction drive 78
 - cursor control mode light 37
 - customizing
 - taskbar 142
- ## D
- date and time
 - setting 132
 - DC-IN jack 49
 - desktop 112
 - browsing style 144
 - creating new icon 113
 - creating shortcuts 127
 - major features 112
 - properties 131

- shortcut menu 116
 - Start button 113
 - system tray 114
 - taskbar 113, 124
 - Device Manager 188
 - checking properties 189
 - disabling a device 188
 - dial-up connection 87
 - Dial-Up Networking Wizard 87
 - Digital Subscriber Lines (DSL) 152, 154
 - DirectShow 199
 - DirectX Foundation 199
 - disk activity light 36
 - Disk Defragmenter 195
 - disk drive
 - corrupted/damaged data files 195
 - missing files/trouble accessing a disk 194
 - running slow 195
 - diskettes
 - copying files to 76
 - display
 - doesn't look normal/flickers 193
 - external monitor not working 194
 - latch 51
 - properties 131
 - screen is blank 192
 - display modes
 - changing 220
 - display panel
 - opening 51
 - Display settings
 - hot key 158
 - displaying folder information 147
 - disposing of used batteries 109
 - DMA (Direct Memory Access) 186
 - check settings 197
 - double-click 53
 - downloading 156
 - DVD-ROM drive
 - removing a disc 84
 - DVD-ROM or multifunction drive
 - can't access disc 196
 - control buttons 78
 - eject button 78
 - inserting a disc 80
 - inserting discs 81
 - removing 84
 - DVD-ROM/multifunction drive
 - light 36
- ## E
- email 155
 - energy saving features 97
 - environmental considerations 40, 41
 - ergonomics
 - lighting 42
 - posture 41
 - seating guidelines 41
 - work habits 43
 - error messages
 - device driver conflict 185
 - general hardware problem 185
 - non-system disk or disk error 183
 - problem with display settings/
 - current settings not working with hardware 194
 - program has performed an illegal operation 181
 - warning resume failure 182
 - WinDVD 200
 - expansion memory slot 56
 - cover 38
 - external monitor
 - connecting 148, 161
 - not working 194
 - external speakers 161

F

- FAT (File Allocation Table) 194
- files 114
 - backing up 70, 76
 - copying to diskette 76
 - printing 75
 - saving 69, 74
 - transferring 151
- Fn key 35
- folders 114
 - displaying information 147
- front panel 35
- function keys 35, 71

H

- hard disk drive
 - light 36, 52
- hardware conflicts 185
 - resolving 187
- headphone jack 33
- Help 137, 185
- Hibernate
 - restarting 94
 - using 92
- Hibernation 89
- Hibernation mode 66, 87
- hiding windows 123
- hot key
 - display modes 220
 - display settings 158
 - power usage mode 217
 - Stand by mode 218
 - wireless mode 221
- hot keys
 - display modes 220
 - instant password 215
 - keyboard functions 222
 - sound 217
- hot swapping 164

precautions 166

Hypertext Transfer Protocol (HTTP)
154

I

- icon 112
 - desktop 113
 - moving to desktop 113
 - naming 120
 - safety 26
- indicator panel
 - keyboard 36
- inserting
 - CDs and DVDs 81
 - PC Cards 164
- installing
 - main battery 105
- interference statement 13
- Internal/External mode 194
- Internet 153
 - bookmarked site not found 185
 - button 34, 35
 - chat rooms 155
 - connecting to 152
 - news groups 156
 - overview 153
 - slow connection 184
 - URL address not found 184
- Internet Service Provider (ISP) 154

J

- jacks
 - headphone 33
 - microphone 33

K

- keyboard 35
 - character keys 71
 - Ctrl, Fn, and Alt keys 71
 - cursor control overlay 73

- function keys 71
- hot keys 222
- indicator panel 36
- not working 182, 192
- numeric keypad overlay 73
- overlay keys 72
- unexpected characters 192
- Windows special keys 72

L

- lights 36
 - AC power 52
 - battery 36, 52, 101
 - caps lock 36
 - cursor control mode 37
 - disk activity 36
 - DVD-ROM/multifunction drive 36
 - hard disk drive 36, 52
 - numeric mode 37
 - on/off 36
- lock slot 33

M

- main battery
 - changing 105
 - removing 105
- memory
 - problem solving 190
 - removing 60
 - removing expansion slot cover 56
- memory cards
 - SD 32
- memory module
 - inserting 58
 - removing 60
- microphone jack 33
- Microsoft Internet Explorer 86
- Microsoft Windows XP 111
- minimizing 124

- modem
 - determining COM port 149
 - port 31, 86
 - problem solving 208, 209
 - resetting port to default settings 149
 - upgrading 149
- modem, using 86
- Modular Bay 162
- monitor
 - connecting 148, 161
 - not working 193
 - port 31
- mouse
 - connecting 60
- moving the computer 67
- My Computer 114, 116

N

- network
 - connecting to 86
 - dial-up connection 87
- New Folder icon 120
- new text document 119
- Notepad 120
- numeric mode light 37

O

- object properties 131
- on/off light 36
- online tours 139

P

- Paint 121
- palm rest 35
- parallel port 31
- password
 - instant 215
- PC Card
 - Card and Socket Services 164

- checklist 205
- CIS (Card Information Structure) 204
- computer stops working 206
- eject button 32
- errors 207
- hot swapping fails 206
- inserting 164
- modem default 149
- not recognized 206
- problem solving 204, 205
- removing 165
- replacing 166
- slots 32
- using 164
- PCMCIA (Personal Computer Memory Card International Association) 164
- Plug and Play 187
- ports
 - modem 31
 - monitor 31
 - parallel 31
 - USB 31, 32
- power
 - cable 49
 - cable connectors 223
 - computer will not start 182
 - monitoring 101
 - on/off button 35
 - problem solving 190
 - taking care of your battery 106
- power down options
 - Turn Off 88, 92, 94
- Power Management
 - powering down 87
- power usage mode 103
- powering off 87
- precautions 43, 49
- primary button 53
- printer
 - Add Printer Wizard 62
 - problem solving 207, 208
- printing a file 75
- problem solving
 - AC power 190
 - battery charge doesn't last 191
 - battery not charging 191
 - can't access disc 196
 - changing display properties 194
 - checking device properties 189
 - compact discs not running
 - correctly 196
 - computer hangs when PC Card inserted 206
 - computer will not power up 182
 - contacting Toshiba 210, 211
 - corrupted/damaged data files 195
 - Device Manager 188
 - disabling a device 188
 - disk drive is slow 195
 - display is blank 192
 - DVD-ROM or multifunction drive
 - controls are gray 197
 - drive tray doesn't eject 196
 - not functioning properly 199
 - performance is poor 198
 - Root or Title menu does not open 198
 - video content poor 199
 - DVD-ROM or multifunction drive performance is poor 197
 - DVD-ROM or multifunction drive slow playback 198
 - external display not working 194
 - external keyboard not working 192

- external monitor 193
 - faulty memory 190
 - hardware conflict 185, 186
 - hardware conflict caused by
 - legacy device 187
 - Help 185
 - high-pitched noise 204
 - illegal operation 181
 - Internet bookmarked site not found 185
 - Internet connection is slow 184
 - keyboard
 - not responding 182
 - keyboard produces unexpected characters 192
 - missing files/trouble accessing a disk 194
 - modem not receiving or transmitting 208, 209
 - no sound 204
 - non-system disk or disk error 183
 - PC Card 204
 - checklist 205
 - error occurs 207
 - hot swapping fails 206
 - not recognized 206
 - slots appear dead 205
 - Plug and Play 187
 - power and batteries 190
 - printer 207, 208
 - program not responding 179
 - program not working properly 195
 - screen does not look right/flickers 193
 - system resources 186
 - Touchpad
 - not responding 182
 - trouble prevention 209
 - URL address not found 184
 - using Startup options 183
 - warning resume failure 182
 - Windows XP not working 183
 - WinDVD error messages 200
 - programs
 - closing 126
 - not running correctly 195
 - starting 74
 - Web browsers 154
 - properties 131
- ## R
- recharging
 - main battery 99
 - RTC battery 100
 - recording
 - adjusting quality 160
 - sounds 158, 159
 - Recovery CD 27
 - Recycle Bin 113, 134
 - removing
 - CDs and DVDs 84
 - main battery 105
 - PC Cards 165
 - resizing windows 123, 125
 - restarting from Hibernate 94
 - restarting from Standby 96
 - restarting from Turn Off 92
 - RTC (real-time clock) battery 98
 - running the computer on battery power 98
- ## S
- safety
 - computer 110
 - disposing of batteries 109
 - icons 26
 - precautions 43
 - saving your work 74
 - ScanDisk 195

- screen
 - blank 192
 - doesn't look normal/flickers 193
 - Screen Saver tab 131
 - SD cards 32
 - Search Engine 155
 - secondary button 53
 - security
 - fitting a computer lock cable 67
 - instant password 215
 - lock slot 33
 - SelectServ 28
 - setting up
 - communications 86
 - computer 39, 45, 55
 - date and time 132
 - printer 62
 - shortcut
 - creating 127
 - menu 116
 - shut down 66
 - sound
 - .wav files 159
 - problem solving 204
 - speakers
 - external 161
 - Stand by mode
 - hot key 218
 - Standby 87, 90
 - low battery 103
 - mode 36
 - restarting 96
 - using 94
 - Start button 113
 - starting a program 74
 - starting up the computer
 - from Standby 96
 - Startup menu
 - problem solving 183
 - support for Windows 113
 - S-video 31
 - system indicator panel 35
 - system requirements
 - WinDVD 199
 - System Restore 136
 - System Tools 136
 - system tray 114
- T**
- taskbar 113, 124
 - customizing 142
 - telephone line
 - connecting the modem 86
 - text file 119
 - toolbars
 - displaying in a window 147
 - Toshiba
 - Forum 211
 - Internet Web sites 212
 - online services 211
 - Toshiba Accessories
 - information 27
 - TOSHIBA Console button 34
 - TouchPad 35
 - using 115
 - using with control buttons 115
 - transferring files 151
 - transferring information between computers 151
 - traveling tips 110
 - Turn Off
 - restarting from 92
 - using 92, 94
 - turning computer on/off 35, 51, 88, 92, 94
 - turning off the computer 87
 - tutorials 118, 139

U

- Uniform Resource Locator (URL)
 - 142, 155
- uploading 156
- URL (Uniform Resource Locator)
 - 142, 155
- USB (Universal Serial Bus) port 31,
32
- USB mouse
 - connecting 60
- using
 - Hibernate 92
 - modem 86
 - PC Cards 164
 - Standby 94

V

- video features
 - exploring 157
- volume, adjusting alarm 217

W

- warranty
 - SelectServ 28
- Web address 155
- Web browsers 154
- Web content interface 143
- Web sites 211
- Web sites, Toshiba 212
- windows
 - hiding 123
 - repositioning 123
 - resizing 123, 125
- Windows Explorer 121
- Windows Help 113
- Windows Media Player 82
- Windows Standby 65
- Windows XP
 - change date and time settings 132

- changing the screen saver 131
- closing programs 127
- creating a new folder 120
- creating a text file 119
- creating shortcuts 127
- desktop 112
- Help 137, 185
- problem solving 183
- Recycle Bin 134
- removing objects 134
- resizing or moving windows 124,
125
- special features 141
- starting programs 121
- System Restore 136
- tours and tutorials 139
- Turn Off 140
- Web Tutorial 118

WinDVD

- advanced features 174
- control panel 170
- controls are disabled 197
- error messages 200
- help 178
- not functioning properly 199
- performance is poor 197, 198
- playlists 175
- Root or Title menu does not open
198
- slow playback 198
- starting 168
- status bar 169
- system requirements 199
- video content poor 199
- video window, maximizing 174
- wireless antenna
 - indicator 33
 - on-off switch 33
- wireless interoperability 6

wireless mode hot key 221

Wizards

 Add Printer 62

 Windows PC Card 205

World Wide Web 154