

HP OmniBook 7100 User's Handbook

HP OMNIBOOK 7100 USER'S HANDBOOK.....	4
Using This Online Handbook.....	4
Finding More Information	4
Notice	5
1. INTRODUCING THE OMNIBOOK	6
Identifying the Parts of the OmniBook.....	6
Learning About Windows	8
Safety Information.....	8
Working in Comfort.....	9
2. OPERATING THE OMNIBOOK	10
Powering the OmniBook	10
To connect ac power.....	10
Starting and Stopping the OmniBook.....	10
To start and stop the OmniBook	11
To reset the OmniBook.....	12
To transport the OmniBook	12
Using the OmniBook Pointing Devices	12
To use the built-in pointing devices	13
To activate full touch pad capabilities.....	14
To activate full pointing stick capabilities.....	14
To configure pointing devices.....	15
Using the OmniBook Display	15
To adjust the display.....	15
To extend the life of the display.....	15
Adjusting the Sound System.....	16
To adjust the volume manually	16
To adjust the volume in Windows.....	16
Using the OmniBook Keyboard	16
To use the Fn hot keys.....	17
To use the Windows keys.....	17
To use the embedded keypad	17

To use the Alt Gr key	18
Checking the Status of the OmniBook.....	18
To interpret the status lights	18
To interpret the status panel indicators	19
Protecting the OmniBook.....	20
To set or change a password	20
To delete a password	21
To attach a security cable.....	21
To install McAfee VirusScan.....	22
3. MANAGING BATTERY POWER.....	23
Recharging and Replacing Batteries	23
To respond to a low-battery warning.....	23
To recharge the battery	24
To replace the battery	24
Conserving Battery Power	25
To optimize battery operating time	25
To get the most from your batteries.....	26
To change a time-out setting.....	26
4. MAKING CONNECTIONS	28
Using Plug-In Modules and Storage Media	28
To replace a plug-in module	28
To insert or eject a floppy disk.....	29
To insert or remove a CD	29
Connecting External Devices	30
To connect an external monitor	30
To connect a printer or other parallel device.....	31
To connect a serial mouse or other serial device.....	32
To connect an external PS/2 keyboard or a PS/2 mouse	32
To connect a universal serial bus device.....	33
To connect an audio source, a microphone, or headphones	34
To connect a television	34
To make an infrared connection	34
Using PC Cards	35
To insert a PC Card	35
To remove a PC Card	36
Using Docking Products	37
To install a docking tray	37
To dock the OmniBook.....	37
To undock the OmniBook.....	39
5. MAINTENANCE AND TROUBLESHOOTING.....	40

Cleaning the Computer	40
To clean the case	40
To clean the display.....	40
Solving Common Problems.....	40
Accessory Problems	41
Audio Problems	41
Display Problems.....	42
Hard Disk Drive Problems	42
Infrared Problems	43
Keyboard and Pointing Device Problems	43
Memory Problems	44
PC Card (PCMCIA) Problems	44
Performance Problems	44
Power and Battery Problems	45
Printing Problems.....	46
Serial, Parallel, and USB Problems.....	47
Startup Problems	48
INDEX.....	49

HP OmniBook 7100 User's Handbook

- [Using This Online Handbook.](#)
- [Finding More Information.](#)
- [Notice.](#)

This handbook describes how to use the OmniBook with a Microsoft® Windows® operating system. It focuses on the special Hewlett-Packard hardware and software, not the Windows operating system itself. For questions about the use of the operating system, refer to the Microsoft Windows manual shipped with the OmniBook.

Using This Online Handbook

This online *User's Handbook* looks similar to a printed manual—and it works like a printed manual in many ways, too. However, you can do several handy things you can't do with a manual. For example, you can make the type larger or smaller. You can click pictures to enlarge them. You can add electronic bookmarks for marking key information. And you can print all or part of the manual on your printer.

- Press F1. You'll see a description of the features of this online manual.

Finding More Information

This OmniBook *User's Handbook* introduces the OmniBook and shows you how to operate and troubleshoot your OmniBook. For more information about using your OmniBook, look in these additional places:

- The printed OmniBook *Reference Guide* shows how to set up the operating system, install and connect accessories, and maintain and upgrade the OmniBook.
- The Microsoft Windows manual, shipped with your OmniBook, contains information about using the standard features of your Windows operating system.
- The online Help for Windows applications provides information about those applications. Use the Help menu or Help button, or just press F1.
- The OmniBook Notes icon gives late-breaking information available after the online manual was completed. Click Start, Programs, OmniBook Library, OmniBook Notes.
- Many bookstores have books about Windows for people with different levels of experience.
- For updates to the BIOS and other technical information, connect to our website on the Internet at <http://www.hp.com/omnibook>.
- You can obtain a backup copy of the OmniBook *Reference Guide* (which came with your OmniBook) from our website (<http://www.hp.com/omnibook>). You can view or print it using an Acrobat viewer, available free of charge through our

website. To re-install the *User's Handbook* onto your hard drive, insert the *Recovery CD* and run `Omnibook\Hputils\Disk1\Setup.Exe`.

- OmniBook accessories may be purchased online. For the latest information, visit our website at <http://www.hp.com/omnibook>.

Notice

This manual and any examples contained herein are provided “as is” and are subject to change without notice. Hewlett-Packard Company makes no warranty of any kind with regard to this manual, including, but not limited to, the implied warranties of merchantability and fitness for a particular purpose. Hewlett-Packard Co. shall not be liable for any errors or for incidental or consequential damages in connection with the furnishing, performance, or use of this manual or the examples herein.

Consumer transactions in Australia and the United Kingdom: The above disclaimers and limitations shall not apply to Consumer transactions in Australia and the United Kingdom and shall not affect the statutory rights of Consumers.

© Copyright Hewlett-Packard Company 1998. All rights reserved. Reproduction, adaptation, or translation of this manual is prohibited without prior written permission of Hewlett-Packard Company, except as allowed under the copyright laws.

The programs that control this product are copyrighted and all rights are reserved. Reproduction, adaptation, or translation of those programs without prior written permission of Hewlett-Packard Co. is also prohibited.

This product incorporates copyright protection technology that is protected by method claims of certain U.S. patents and other intellectual property rights owned by Macrovision Corporation and other rights owners. Use of this copyright protection technology must be authorized by Macrovision Corporation, and is intended for home and other limited viewing uses only unless otherwise authorized by Macrovision Corporation. Reverse engineering or disassembly is prohibited.

Portions of the programs that control this product may also be copyrighted by Microsoft Corporation, SystemSoft Corp., Crystal Semiconductor Corporation, Phoenix Technologies, Ltd., and ATI Technologies Inc. See the individual programs for additional copyright notices.

Microsoft, MS, MS-DOS, and Windows are registered trademarks of Microsoft Corporation. Pentium and the Intel Inside logo are U.S. registered trademarks and MMX is a U.S. trademark of Intel Corporation. TrackPoint is a U.S. registered trademark of International Business Machines.

For warranty information, see the *Support and Service* booklet.

Hewlett-Packard Company
Mobile Computing Division
19310 Pruneridge Ave.
Cupertino, CA 95014, U.S.A.

Edition 1 March 1998

1. Introducing the OmniBook

- [Identifying the Parts of the OmniBook.](#)
- [Learning About Windows.](#)
- [Safety Information.](#)
- [Working in Comfort.](#)

Keep in mind the following features as you learn about your OmniBook.

- The OmniBook's modular design provides maximum expandability without compromising portability.
- The high-performance Pentium® CPU with MMX™ technology and enhanced IDE hard drive provide you with the processing power needed to handle complex graphics and large sound files.
- Two PC Card slots give you the ability to use standard [PC Cards](#), such as a LAN adapter or memory cards.
- The CD-ROM / floppy disk drive in the [plug-in module bay](#) can be replaced with a second battery to give extended travel time.

Identifying the Parts of the OmniBook

OmniBook–Front View

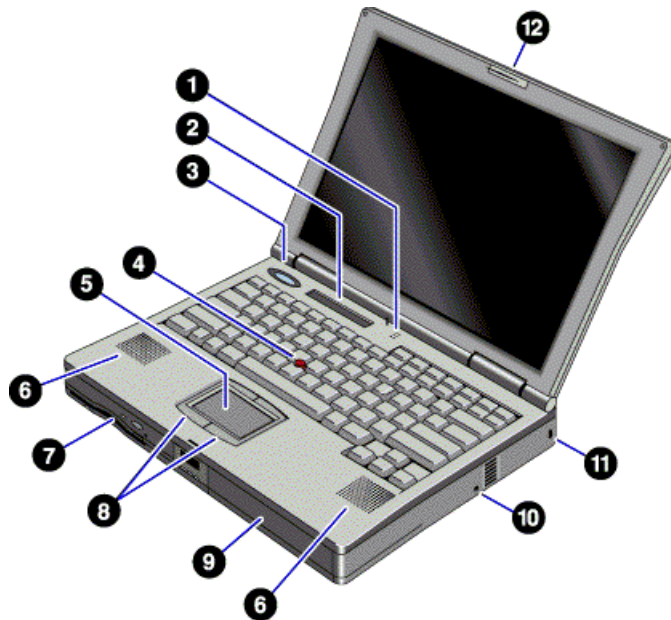

1. Built-in microphone.
2. Status panel.

3. Blue power button.
Turns the OmniBook on and off.
4. Pointing stick (pointing device).
5. Touch pad (pointing device).
6. Built-in speakers.
7. Plug-in module bay.
The OmniBook includes a CD-ROM / floppy disk drive. You can purchase an optional LS-120 drive, DVD drive, or a second battery.
8. Click buttons (for pointing devices).
9. Main battery.
10. System-off button (to shut down the OmniBook).
11. Kensington lock slot (security connector).
12. Latch to open and close the OmniBook.

OmniBook–Side View

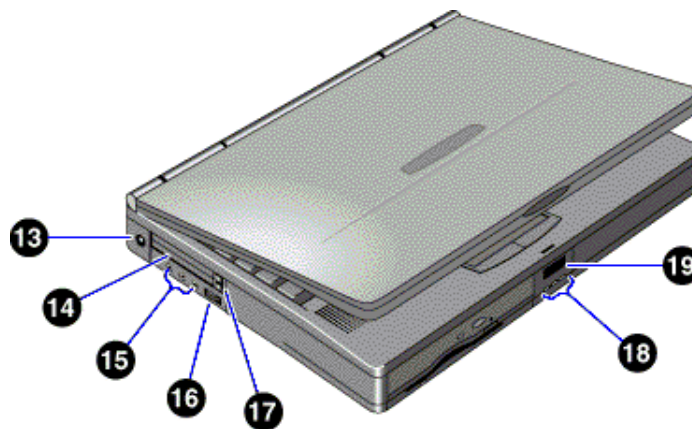

13. AC adapter jack.
14. PC Card slots (upper and lower).
Accepts two Type-II cards or one Type-III card.
15. Audio jacks (left to right): audio line-in, external microphone, audio line-out.
16. Volume control wheel.
17. PC Card eject buttons (upper and lower PC Card slots).
Press once to pop out the button, and press again to eject the card.
18. Status lights (left to right): power state, hard disk activity, charging status.
19. Front infrared port.
There is a second infrared port on the rear of the OmniBook. Only one infrared port can be enabled at a time.

OmniBook–Rear View

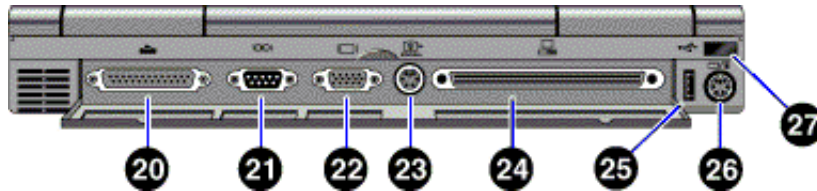

20. Parallel port (LPT1).
Use this port for a parallel printer or other parallel device.
21. Serial port (COM1).
Use this port for a serial mouse, a modem, a serial printer, or other serial device.
22. External monitor port (VGA).
23. TV-out port (supports video adapter cable).
24. Docking port (for the port replicator).
25. Universal serial bus port (USB).
26. PS/2 keyboard or PS/2 mouse port (supports Y-adapter).
27. Rear infrared port.
There is another infrared port on the front of the OmniBook. Use this port for wireless data transmission between the OmniBook and another computer or a printer with an infrared port. You must install infrared drivers. See the *OmniBook Reference Guide* for instructions.

Learning About Windows

This *OmniBook User's Handbook* does not discuss the Windows operating system. Rather, it introduces the OmniBook and shows you how to operate it. For information about Windows, see the following sources:

- The Windows online Help. Click Start, then Help.
- The Microsoft Windows manual shipped with your OmniBook.
- Many bookstores have books about Windows for people with different levels of experience.

Safety Information

AC Adapter Safety

- Use only the ac adapter shipped with the OmniBook (HP part number F1454A). *Using any other ac adapter could damage the OmniBook and may void your warranty.* Refer to the warranty statement for your product.

Battery Safety

- To avoid risk of fire, burns, or damage to your battery, do not allow a metal object to touch across the battery contacts.
- Use only the battery designated for use with your model of the HP OmniBook.

- Do not disassemble. There are no serviceable parts inside.
- Do not dispose of the battery in fire or water.
- Handle a damaged or leaking battery with extreme care. If you come in contact with the electrolyte, wash the exposed area with soap and water. If it contacts the eye, flush the eye with water for 15 minutes and seek medical attention.
- Do not expose the battery to high storage temperatures—above 60 °C (140 °F).
- When discarding a battery, contact your local waste disposal provider regarding local restrictions on the disposal or recycling of batteries.
- To obtain a replacement battery, contact your local dealer or HP sales office.
- The battery cannot charge if the ambient temperature exceeds 45 °C (113 °F).

LED Safety

The infrared ports located on the front and rear panels of the OmniBook are classified as a Class 1 LED (light-emitting diode) device according to International Standard IEC 825-1 (EN60825-1). This device is not considered harmful, but the following precautions are recommended:

- If the unit requires service, contact an authorized HP service center—see the *OmniBook Support and Service* booklet.
- Do not attempt to make any adjustment of the unit.
- Avoid direct eye exposure to the infrared LED beam. Be aware that the beam is invisible light and cannot be seen.
- Do not attempt to view the infrared LED beam with any type of optical device.

Laser Safety

The CD-ROM drive used with the OmniBook is certified as a Class 1 laser device according to the U.S. Department of Health and Human Services (DHHS) Radiation Performance Standard and International Standards IEC 825 / IEC 825-1 (EN60825 / EN60825-1). This device is not considered harmful, but the following precautions are recommended:

- Ensure proper use by reading and following the instructions carefully.
- If the unit requires service, contact an authorized HP service center—see the *OmniBook Support and Service* booklet.
- Do not attempt to make any adjustment of the unit.
- Avoid direct exposure to the laser beam—do not open the unit.

Working in Comfort

Warning

Improper use of keyboards and other input devices has been associated with ergonomic injury. For information about reducing your risk, see *Working in Comfort* shipped with your OmniBook, or visit our ergonomics website, <http://www.hp.com/ergo>.

2. Operating the OmniBook

- [Powering the OmniBook.](#)
- [Starting and Stopping the OmniBook.](#)
- [Using the OmniBook Pointing Devices.](#)
- [Using the OmniBook Display.](#)
- [Adjusting the Sound System.](#)
- [Using the OmniBook Keyboard.](#)
- [Checking the Status of the OmniBook.](#)
- [Protecting the OmniBook.](#)

Powering the OmniBook

To connect ac power

There are two ways to power the OmniBook: by ac adapter and by battery.

Caution

Use only the HP adapter intended for this product, model F1454A. Using any other ac adapter could damage the OmniBook and may void your warranty. Refer to the warranty statement for your product.

1. Connect the power cord to the ac adapter, then plug the cord into an ac outlet. The light on the ac adapter shines when the adapter is powered.
2. Connect the ac adapter to the OmniBook's left side, as shown.

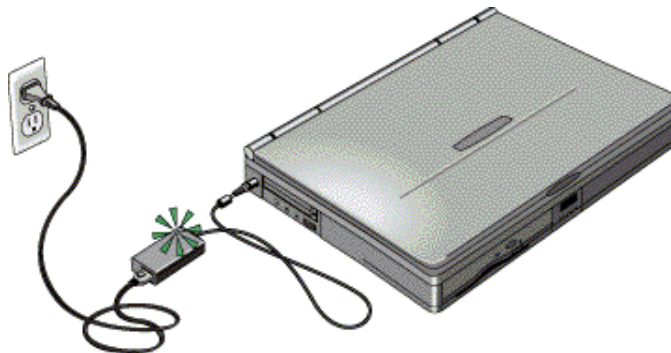

3. Press the blue power button to turn on the OmniBook.

When the OmniBook is plugged into ac power and a battery is installed, it automatically recharges the battery. To check the status of the battery, see [“Checking the Status of the OmniBook.”](#)

Starting and Stopping the OmniBook

- [To start and stop the OmniBook.](#)
- [To reset the OmniBook.](#)
- [To transport the OmniBook.](#)

To start and stop the OmniBook

You can easily start and stop your OmniBook using the [blue power button](#).

However, you may want to take advantage of the power modes, which provide alternative methods for stopping your OmniBook—depending on power considerations, types of active connections, or start-up time.

The OmniBook enters	When you	To exit this mode
Standby mode		
Saves minimal power. Turns off only the display. Restarts quickly. Restores previous session. Maintains network connections.	Press Fn+S –or– allow time-out .	Press any key or move a pointing device to display your current session ("Instant-On").
Suspend mode		
Saves significant power. Turns off the display. Saves current session to RAM. Restarts quickly. Restores previous session. May restore network connections.*	Press blue power button –or– close the lid –or– select Start, Suspend** –or– allow time-out .	Press the blue power button to display your current session ("Instant-On").
Hibernate mode		
Saves maximum power. Saves current session to disk, then shuts down. Restore previous session. May restore network connections.*	Press Fn+F12 –or– allow time-out .	Press the blue power button to restart and restore your previous session.
Off mode		
Saves maximum power. Turns off without saving current session. <i>Unsaved data will be lost.</i> At startup, resets everything, starts a new session, and restores network connections.	Select Start, Shut Down –or– Press and hold the blue power button until the display shuts down.	Press the blue power button to restart with a new session.

* **Preserving network connections.** A plug-and play operating system, such as Windows 95, can restore network connections when you turn on the OmniBook. For Windows NT 4.0 or a different operating system, you may have to reset the OmniBook or restart the operating system to restore them.

** Windows 95 only.

Hint

Time-out settings. In order to save power or, conversely, to increase speed, you can change the [time-out settings](#). Time-out settings specify when to shut down various components after periods of inactivity. There are separate time-out settings for each power mode.

To reset the OmniBook

If Windows or the OmniBook stops responding, you can reset the OmniBook and restart Windows.

1. If possible, shut down Windows.
2. Insert a pen or a straightened paper clip into the system-off button.

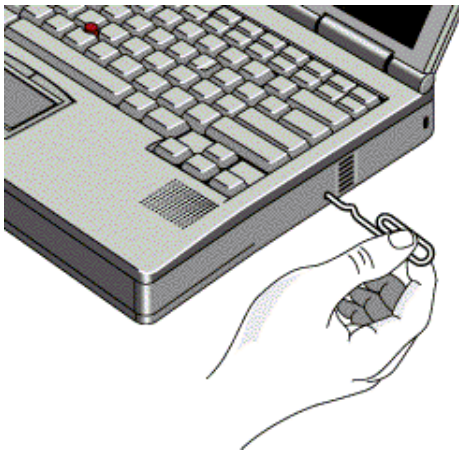

—or, if this fails—

Press and hold the blue power button until the display shuts down.

3. After the computer shuts down, press the blue power button to turn it back on.

To transport the OmniBook

1. Save your work.
2. From the Start menu, click Shut Down.
3. Disconnect all external devices.
4. Close the lid.

Using the OmniBook Pointing Devices

- [To use the built-in pointing devices.](#)
- [To activate full touch pad capabilities.](#)
- [To activate full pointing stick capabilities.](#)
- [To configure pointing devices.](#)

Two pointing devices (pointing stick and touch pad) are built into your OmniBook. By default, drivers for both devices are installed and support the basic features of each pointing device (but not the enhanced features of either).

You can customize the OmniBook to support enhanced touch pad or enhanced pointing stick features. If you do this, keep in mind that you are selecting enhanced features for *either* the touch pad or for the pointing stick. *You cannot activate enhanced features for both simultaneously.*

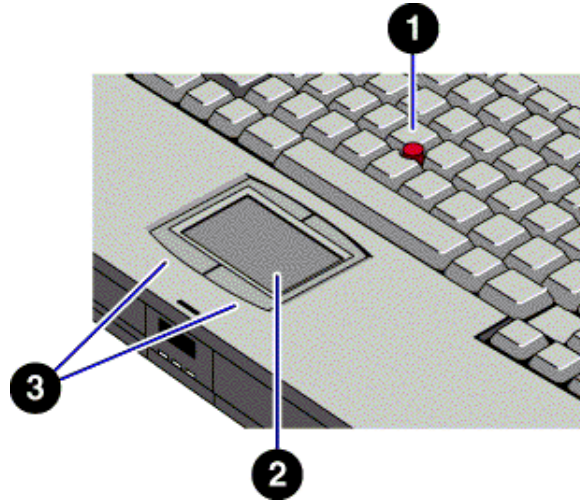

1. Pointing stick (pressure-sensitive pointing device).
2. Touch pad (touch-sensitive pointing device).
3. Click buttons.
Both pointing devices use these click buttons, which work like the left and right buttons on a standard mouse. What the buttons do depends on the software being used.

To use the built-in pointing devices

1. Place your hands in the typing position.
2. **Pointing stick.** With your index finger, press the pointing device in the direction you want the pointer to move. Pressing away from you moves the pointer up the screen; pressing toward you moves the pointer down the screen.
Touch pad. Move a thumb or finger across the touch pad in the direction you want the pointer to move.
3. Use the left and right click buttons, which function like the left and right buttons on a mouse, to make your selection.
 - To open an application, move the pointer over the icon, then press the left button twice rapidly.
 - To make menu selections, move the pointer to the item and press the left button once.
 - To open the shortcut menu for an item, move the pointer over the item and click the right button.

- To drag an item, move the pointer over the item. Press *and hold* the left button while you move the pointer to the new location. Release the button.

To activate full touch pad capabilities

The built-in pointing stick driver supports only basic touch pad features. To activate full touch pad capabilities, you have to

- Remove the pointing stick driver.
- Disable the pointing stick.
- Install touch pad support.

Remove the pointing stick driver

1. From Control Panel, open Mouse, General and change the mouse type to Standard PS/2 Port Mouse.
2. From Control Panel, open Add/Remove Program and remove IBM TrackPoint support.

Disable the pointing stick

1. From the Start menu, shut down, then restart the OmniBook.
2. When you see the HP logo, press F2 to enter the BIOS Setup utility.
3. Select the System Devices menu.
4. Highlight Internal Pointing Devices and select Touch Pad.
5. Press F10 to save and exit.

Install touch pad support

- **For Windows 95**

From the Start menu, run c:\omnibook\drivers\win95\touchpad\setup.exe.

- **For Windows NT 4.0**

From the Start menu, run c:\omnibook\drivers\nt40\touchpad\install.exe.

To activate full pointing stick capabilities

To activate full pointing stick capabilities, you have to

- Remove the touch pad driver.
- Enable the pointing stick.
- Install pointing stick support.

Remove the touch pad driver

- From Control Panel, click Add/Remove Program and remove touch pad support.

Enable the pointing stick

1. From the Start menu, shut down, then restart the OmniBook.
2. When you see the HP logo, press F2 to enter the BIOS Setup utility.

3. Select the System Devices menu.
4. Highlight Internal Pointing Devices and select Pointing Stick. (Choose Both if you want basic touch pad features available.)
5. Press F10 to save and exit.

Install pointing stick support

- From Control Panel, open Mouse, General and change the mouse type--click Have Disk and point to the directory listed below and select PS/2 TrackPoint.

For Windows 95

c:\omnibook\drivers\win95\trackpnt.

For Windows NT 4.0

c:\omnibook\drivers\nt40\ trackpnt.

To configure pointing devices

- To customize the operation of all pointing devices (pointing stick, touch pad, and external PS/2 or serial mouse), use the Windows Control Panel Mouse icon to access Mouse Properties. You can change left and right button actions, double-click speed, pointer speed and tail, and more.
- To customize special pointing stick features, click the pointing stick icon on the taskbar or open TrackPoint in Control Panel.

Using the OmniBook Display

- [To adjust the display.](#)
- [To extend the life of the display.](#)

To adjust the display

The OmniBook uses special key combinations, called [hot keys](#), to control brightness.

- Press Fn+F1 to decrease the brightness.
- Press Fn+F2 to increase the brightness.

Hint

Brightness affects battery life. To maximize your battery operating time, set the brightness to the lowest comfortable setting, so that the internal light uses less power.

To extend the life of the display

Observe the following guidelines to extend the life of the backlight in the OmniBook display.

- Set the brightness to the lowest comfortable setting (Fn+F1).

- When working at your desk, connect an external monitor and turn off the internal display (Fn+F5).
- Avoid using a screen saver or other software that prevents the OmniBook from changing to Suspend or Standby mode after a time-out period.
- Do not disable Suspend and Standby time-outs.

Adjusting the Sound System

- [To adjust the volume manually.](#)
- [To adjust the volume in Windows.](#)

The OmniBook supports Sound Blaster Pro-compatible sound and the Microsoft Windows Sound System.

To adjust the volume manually

- To increase the volume, roll the volume control wheel towards the front of the OmniBook.
- To decrease the volume, roll the wheel towards the rear of the OmniBook.

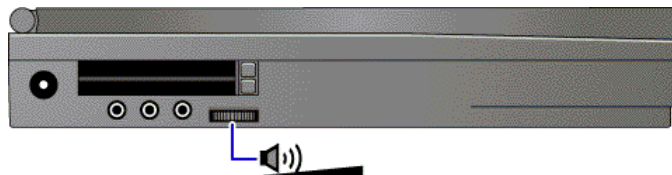

To adjust the volume in Windows

1. Click the speaker symbol in the taskbar.
2. Drag the volume control bar up or down to adjust the volume.

Using the OmniBook Keyboard

- [To use the Fn hot keys.](#)
- [To use the Windows keys.](#)
- [To use the embedded keypad.](#)
- [To use the Alt Gr key.](#)

Warning

Improper use of keyboards and other input devices has been associated with ergonomic injury. For information about reducing your risk, see *Working in Comfort* shipped with your OmniBook, or visit our ergonomics website, <http://www.hp.com/ergo>.

To use the Fn hot keys



The combination of the Fn key plus another key creates a *hot key*—a shortcut key sequence—for various system controls. Press *and hold* Fn while pressing the desired key.

Hot key	Does this
Fn + F1	Decreases the display's brightness.
Fn + F2	Increases the display's brightness.
Fn + F5	Switches among the built-in display, an external display, and simultaneous displays.
Fn + F6 (hold)	For use with two batteries: The battery indicator in the status panel briefly displays the individual battery status for each battery you have installed in the OmniBook.
Fn + F8	Toggles the embedded keypad on and off. Does not affect an external keyboard. If Num Lock is on, then the numeric functions are active; otherwise, cursor control is active.
Fn + F12	Enters Hibernate mode .
Fn + R	Enters Suspend mode .
Fn + S	Enters Standby mode .
Fn + F	Toggles between front and rear infrared ports.
Fn + NmLk	Toggles Scroll Lock on and off.

To use the Windows keys

There are two Windows keys on the keyboard.



The one next to the Fn key brings up the Windows Start menu.



The one at the top center of the keyboard brings up the shortcut menu for the current application. This is the same menu that appears when you click the right mouse button while pointing at the application.

To use the embedded keypad

When the embedded keypad on the OmniBook's built-in keyboard is active, two options are possible.

Num Lock on. Keys change to the numeric or arithmetic designations printed in light gray on the keyboard.

Num Lock off. Keys change to cursor control keys.

1. Press the NmLk key to turn Num Lock on or off.
2. Press Fn+F8 to turn on the embedded keypad.

–or–

To temporarily turn on the embedded keypad, hold Fn while typing a key.

[Status panel icons](#) show the status of the embedded keypad and Num Lock.

Hint

Typing numbers. Consider leaving Num Lock on all the time. Then, when you want to use the embedded keypad on your built-in keyboard, turn it on (by pressing Fn+F8), or press Fn before each keypad key.

To use the Alt Gr key

Non-US keyboards have an Alt Gr key to the right of the spacebar. This is a shift key providing access to certain keyboard characters.

- For a character in the lower-right corner of a key, press and hold the ALT GR to type the character.
- For a character in the upper-right corner of a key, press and hold SHIFT *and* ALT GR to type the character.

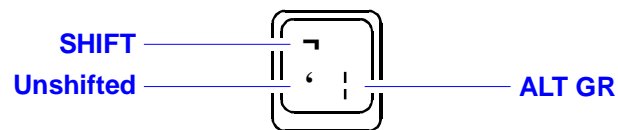

Checking the Status of the OmniBook

- [To interpret the status lights.](#)
- [To interpret the status panel indicators.](#)

To interpret the status lights

The OmniBook also has status lights that report power status and drive activity. When the CD-ROM / floppy disk drive is installed in the module bay, the following lights are present on the front of the OmniBook.

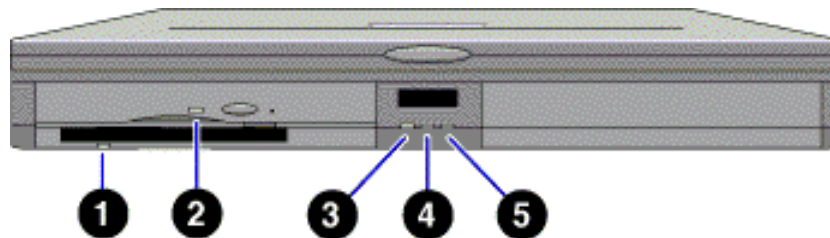

1. Floppy disk drive light

- Steady green light. Floppy disk is being read from or written to.

2. CD-ROM drive light

- Steady green light. CD-ROM disk is being read from.

3. Power status light

- Steady green light. OmniBook on (On or Standby mode).
- Steady amber light. OmniBook suspended (Suspend mode).
- No light. OmniBook off (Off or Hibernate mode).
- Alternating green and amber light. OmniBook failed when resuming.

4. Disk drive activity light

- Steady green light. Hard disk drive is being read from or written to.

5. Charging status light

- Steady green light. AC adapter connected, battery full.
- Blinking green light. AC adapter connected, battery charging.
- No light. AC adapter not connected.

To interpret the status panel indicators

The OmniBook status panel, located above the keyboard, contains indicators that show the current keyboard status, drive activity, and power status of the OmniBook.



Power status indicators



AC power. The ac adapter is connected.



Battery status. Shows the approximate charge level of the battery relative to a full charge. Each bar represents a 10% charge (displayed from right to left).

Battery presence. The upper and lower triangles indicate the presence of main (upper) and second (lower) batteries. A triangle blinks slowly when that battery is charging.

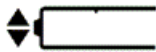

Battery low. No battery bars showing; triangles indicate presence of battery. The OmniBook also beeps.



Defective battery. No battery bars showing and no triangles indicating presence of battery; no charging even though ac power is present.



Overheated battery. The battery is too hot to charge. Not necessarily a defective battery.

Drive status indicators



CD-ROM drive, hard disk drive, or any plug-in module drive. The OmniBook is accessing one of these internal drives.



Floppy disk drive. The OmniBook is accessing the floppy disk drive.



PC Card. There is activity between the PC Card and the computer.

Keyboard status indicators

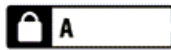

Caps Lock. Caps Lock is active.

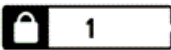

Num Lock. Num Lock is active.



Keypad Lock. The built-in embedded keypad is active (Fn+F8). Num Lock must also be on for the numeric keys. Otherwise, the cursor keys are active. See [“To use the embedded keypad.”](#)



Scroll Lock. Scroll Lock is active (Fn+NmLk).

Protecting the OmniBook

- [To set or change a password.](#)
- [To delete a password.](#)
- [To attach a security cable.](#)
- [To install McAfee VirusScan.](#)

To set or change a password

The OmniBook provides two levels of password protection—user password protection and administrator password protection. *You cannot set the user password until you set an administrator password.*

If password protection is set, then you will be prompted to enter a password whenever you reset or turn on the computer (depending on your setting).

To set, change, or delete password protection for this OmniBook, use the BIOS Setup utility. This program is described fully in the *Reference Guide* that came with your OmniBook.

1. From the Start menu, shut down, then restart the OmniBook.
2. When you see the HP logo, press F2 to enter the BIOS Setup utility.
 - Pointing devices do not work in the BIOS Setup utility.
 - Active keys are described along the bottom of the window.
 - Help information for the highlighted item appears on the right side of the window.

3. Select the Security menu.
4. Select Set Administrator Password, then press ENTER.
5. Type the new password, then press ENTER. *The password can contain up to eight alphanumeric characters, and it is not case-sensitive.*
6. Type the password again to confirm, press ENTER, then press Continue.
7. Under Password Required To, choose when the password will be required.
 - Select Boot to require password when booting the OmniBook.
 - Select Resume to require password when resuming from Suspend or Hibernate mode.
 - Select Undock to require password when undocking the OmniBook.
8. If desired, repeat this procedure for Set User Password.
9. Press F10 to save and exit the BIOS Setup utility.

Note

If an administrator password is set, but Password On Boot is not selected, then the administrator password is still required to get into the BIOS Setup utility.

Caution

Be sure you record your password in a safe place. To restore operation if you forget your password, have your proof-of-purchase available and call Hewlett-Packard at the number in the *Support and Service* booklet.

To delete a password

If you delete an administrator password, the OmniBook automatically deletes the user password as well.

1. From the Start menu, shut down, then restart the OmniBook.
2. When you see the HP logo, press F2 to enter the BIOS Setup utility.
 - Pointing devices do not work in the BIOS Setup utility.
 - Active keys are described along the bottom of the window.
 - Help information for the highlighted item appears on the right side of the window.
3. Select the Security menu.
4. Select Set Administrator Password, then press ENTER.
5. Type the current password, then press ENTER.
6. Press ENTER at the Enter New Password prompt.
7. Press ENTER at the Confirm New Password prompt.
8. Press Continue to save changes.
9. Press F10 to save and exit the BIOS Setup utility.

To attach a security cable

Your OmniBook has a built-in connector that allows you to secure the OmniBook with a cable. The Kensington MicroSaver lock system works with this connector and is available at many computer stores.

1. Wrap the cable around a stationary object, such as a table leg.



2. Loop the cable to create a slip knot around the stationary object—make sure it can't slip off.
3. Insert the lock into the OmniBook security connector and release the key. *Store the key in a safe place away from the OmniBook.*

To install McAfee VirusScan

The OmniBook comes equipped with McAfee VirusScan, which currently detects over 13,500 viruses. As an HP OmniBook owner, you are entitled to 90 days free support from McAfee and one free upgrade to VirusScan. For details, see the Readme file under Start, Programs, McAfee VirusScan.

Before you can use VirusScan, you need to install it.

1. From the Start menu, click Programs, McAfee VirusScan, Setup.
2. Follow the instructions as they appear on the screen.

Once installed, you can get detailed online instructions under VirusScan Help.

3. Managing Battery Power

- [Recharging and Replacing Batteries.](#)
- [Conserving Battery Power.](#)

The primary portable source of power for the OmniBook is its replaceable, rechargeable battery. Your OmniBook accepts a main battery (in the battery bay) and, if desired, a second battery (in the plug-in module bay).

In addition to the replaceable battery, there is a permanent, internal backup battery, which recharges whenever the OmniBook is on or connected to ac. It maintains certain internal settings, such as the clock.

The OmniBook provides several safeguards so that you won't be surprised by a dead-battery condition.

- The [status panel](#) shows the remaining battery charge.
- Built-in warnings alert you to a low battery condition.
- The OmniBook automatically turns off when the battery charge gets too low—your session continues when you start recharging the battery or insert a fresh battery.
- Data on any of the drives is not affected by a low battery. However, unsaved data could be affected if the battery runs down completely while writing data to the drive.

Recharging and Replacing Batteries

- [To respond to a low-battery warning.](#)
- [To recharge the battery.](#)
- [To replace the battery.](#)

To respond to a low-battery warning

When battery power is critically low, you are alerted by one or more of the following.

- The [battery indicator](#) in the status panel appears empty.
- The computer emits a warning beep. This reminds you to save your work.
- If the OmniBook has been off, you will not be able to turn it on.

The OmniBook automatically [hibernates](#) (turns off) to preserve your current session and data. (If Hibernate is disabled in the BIOS Setup utility, then your data are not protected.)

You won't be able to turn the computer on again until you restore power by one of the following actions:

- Plug in the ac adapter. See ["To recharge the battery."](#)

—or—

- Replace the main battery with one that is charged. See ["To replace the battery."](#)
–or–
- Install a charged second battery in the plug-in module bay. See ["To replace a plug-in module."](#)

To recharge the battery

The ac adapter is normally warm to the touch whenever it's plugged into an ac outlet. The OmniBook is normally warm while it's charging. Don't charge it in a briefcase or other small space.

1. Connect the power cord to the ac adapter, then plug the cord into an ac outlet. The light on the ac adapter shines when the adapter is powered.
2. Connect the ac adapter to the ac adapter jack on the left side of the OmniBook.

Charging time. Charging the battery takes about 2 hours when the computer is off or suspended, or about 2.5 hours when the computer is in use.

Battery life. When the computer is in use, typical battery life can range from 3 to 3.5 hours, depending on your level of use and your power management settings. See ["To change a time-out setting."](#)

Optimum charging. To get the longest battery operating time, continue charging until the battery is fully charged as indicated by the following:

- Charging light on the front of the OmniBook stops blinking.
- Status panel battery indicator (up or down triangle) stops blinking.

Because of rounding, a battery indicator can show a full battery *before* it's fully charged. The above indicators stop blinking only when the battery is actually full.

You can continue working while the battery is charging.

To replace the battery

You may never need to replace the rechargeable battery in ordinary use. Typically, you simply connect the ac adapter to the OmniBook and recharge the battery while you work. However, you can replace a low battery with another that is more fully charged.

Caution

If you have any unsaved data, it (and your current work session) will be lost when you remove the battery, unless the computer is connected to ac power, a second battery is installed, or the OmniBook is in Hibernate mode.

1. **Important.** Save your work.
2. Plug in the ac adapter.
–or–
From the Start menu, shut down the OmniBook.
3. Slide *and hold* the release latch, then pull out the battery, as shown.

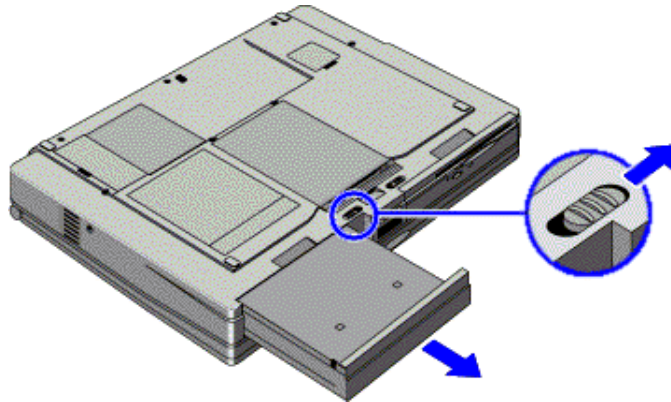

4. Slide the charged battery into the OmniBook until it clicks into place.

Hint

The battery module fits into either the plug-in module bay or the battery bay. Slide the front panel of the battery right or left so that it fits into the desired bay.

Caution

Do not mutilate, puncture, or dispose of the battery in fire. The battery can burst or explode, releasing hazardous chemicals. A rechargeable battery pack must be recycled or disposed of properly. See [“Battery Safety.”](#)

Conserving Battery Power

- [To optimize battery operating time.](#)
- [To get the most from your batteries.](#)
- [To change a time-out setting.](#)

To optimize battery operating time

The OmniBook uses Advanced Power Management (APM) to conserve battery power. You can take steps to optimize your battery operating time.

Follow these suggestions to conserve battery power.

- Plug in the ac adapter, especially while using the CD-ROM drive, the floppy disk drive, or any external connections such as a PC Card.
- Put the OmniBook in [Suspend mode](#) whenever you are not using it for a short while. Press the blue power button (or Start, Suspend).
- Put the OmniBook in [Hibernate mode](#) whenever you want to save your current session, but will not be using the computer for several hours or more (Fn+F12).
- Turn the OmniBook [off](#) whenever you will not be using it for several hours or more. Click Start menu, Shut Down.
- Turn down the brightness of the display to the lowest comfortable level (Fn+F1). This reduces the backlight power and extends the life of your OmniBook display.

- Set the automatic time-out settings to emphasize saving power. See [“To change a time-out setting.”](#)
- If you have an I/O PC Card—that is, a PC Card having an external connection, such as a modem or network card—remove it when you’re not using it. Some I/O cards use significant power, even while they’re inactive.
- If you work with an application that uses the serial port or an I/O PC Card, exit the application when you’re done using it.
- Install a second battery in the plug-in module bay to double the operating time.

To get the most from your batteries

The following are some further suggestions for the best management of your OmniBook batteries.

- Do not leave batteries unused for long periods of time. If you have more than one, rotate them.
- If you normally use ac power, make a practice of at least once a week using the battery as your power source.
- Unplug the ac adapter when the computer is not in use.
- To preserve the life of a battery, be sure to charge the battery regularly.
- For long-term storage, the battery must be charged at 20–50% to minimize capacity loss by self-discharge and to avoid deterioration of battery performance.

To change a time-out setting

The BIOS Setup utility includes settings for automatic time-outs after specified periods of inactivity. (This program is described fully in the *Reference Guide* that came with your OmniBook.) When enabled, these settings save power. There are four time-outs, providing different levels of power conservation.

1. From the Start menu, shut down, then restart the OmniBook.
2. When you see the HP logo, press F2 to enter the BIOS Setup utility.
 - Pointing devices do not work in the BIOS Setup utility.
 - Active keys are described along the bottom of the window.
 - Help information for the highlighted item appears on the right side of the window.
3. Select the Power menu.
4. Select Power Management Mode and use the F5 (or F6) key to move through the list of options and select one *other than* Disabled:
 - Max. Power Savings: The time-out settings are predefined for best power savings (using relatively short time-outs).
 - Max. Performance: The time-out settings are set for fast performance with some power conservation (using relatively long time-outs).

- Customized: You determine each setting for Smart CPU Mode, Standby Time-out, Suspend Time-out, Hibernate Time-out, and Hard Disk Time-out. For definitions of these power modes, see [“To start and stop the OmniBook.”](#)
5. **Optional.** Choose a setting for Time-out on AC. If you want the time-outs to occur even when the OmniBook is connected to ac power, choose Enabled. To prevent time-outs while the OmniBook is plugged in, choose Disabled.
 6. Press F10 to save and exit the BIOS Setup utility.

4. Making Connections

- [Using Plug-In Modules and Storage Media.](#)
- [Connecting External Devices.](#)
- [Using PC Cards.](#)
- [Using Docking Products.](#)

Using Plug-In Modules and Storage Media

- [To replace a plug-in module.](#)
- [To insert or eject a floppy disk.](#)
- [To insert or remove a CD.](#)

The OmniBook *Plug-In Modules User's Guide* describes OmniBook accessory modules and shows you how to install and use them. The OmniBook's module bay accommodates the following:

- CD-ROM / floppy disk drive.
- LS-120 drive.
- DVD drive.
- Second battery.

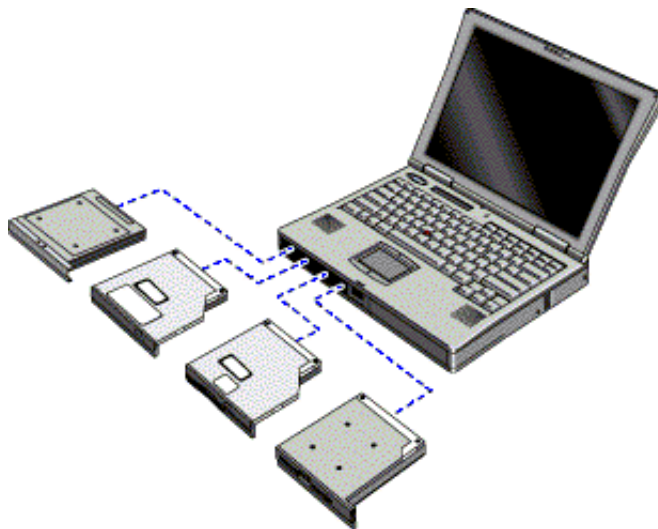

To replace a plug-in module

Caution

If you are inserting or removing a CD-ROM / floppy disk drive, LS-120 drive, or DVD drive, shut down the OmniBook.

1. From the Start menu, shut down the OmniBook. (This is not necessary if you are removing a battery from the plug-in module bay and inserting another battery).
2. Slide and hold the release latch, then pull out the module, as shown.
3. Slide the new plug-in module into the OmniBook until it clicks into place.

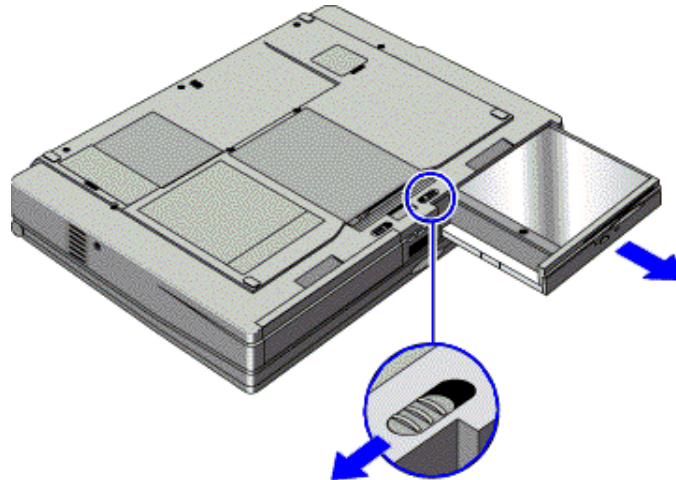

Hint

The battery module fits into either the plug-in module bay or the battery bay. Slide the front panel of the battery right or left so that it fits into the desired bay.

To insert or eject a floppy disk

When the OmniBook is reading or writing data to the floppy drive, the floppy disk indicator appears on the status panel.



Caution

Do not insert or remove a floppy disk while the OmniBook is actively reading or writing data. Wait until the floppy drive is done. Otherwise, you could lose data or the OmniBook could stop responding.

- Hold the disk with its face up, then slide it into the floppy drive slot (on the front of the OmniBook) until it clicks into place.
- To remove the floppy disk, press the eject button next to the slot.

To insert or remove a CD

When the OmniBook is reading data from the CD-ROM drive, the CD-ROM/hard disk drives indicator appears on the status panel.



Caution

Do not insert or remove a CD while the OmniBook is actively reading data. Wait until the CD-ROM drive is done. Otherwise, the OmniBook could stop responding.

1. Press the button on the face of the CD-ROM drive.
2. If you are using this drive for the first time, be sure to remove the cardboard packing insert.

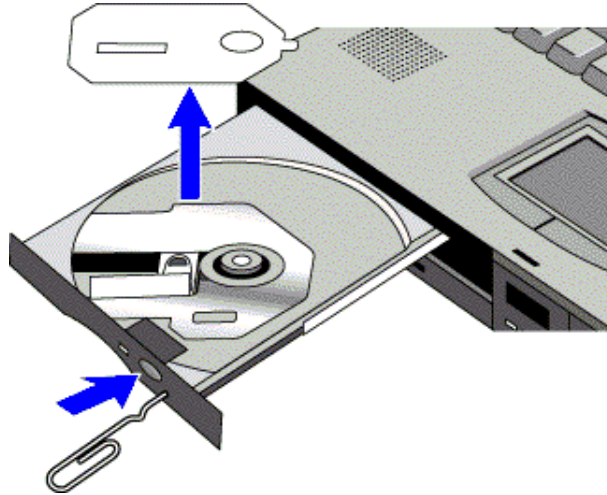

3. Place the CD into the drive (label facing up) and gently press down to seat the CD on the spindle.

–or–

Remove the CD.

4. Slide the CD-ROM tray back into the module to close it.

If the CD-ROM drive has no power and you need to remove a CD from it, you can manually open the CD-ROM drive by inserting a straightened paper clip into the recessed hole (as shown above).

Connecting External Devices

- [To connect an external monitor.](#)
- [To connect a printer or other parallel device.](#)
- [To connect a serial mouse or other serial device.](#)
- [To connect an external PS/2 keyboard or a PS/2 mouse.](#)
- [To connect a universal serial bus device.](#)
- [To connect an audio source, a microphone, or headphones.](#)
- [To connect a television.](#)
- [To make an infrared connection.](#)

To connect an external monitor

1. From the Start menu, shut down the OmniBook.

2. Connect the monitor cable from the monitor to the VGA port on the rear of the OmniBook.
3. Connect the monitor to a power source and turn it on.
4. Press the blue power button to turn on the OmniBook.
5. If the external monitor has a different resolution from the internal display, adjust the display properties (Start, Settings, Control Panel, Display, Settings).

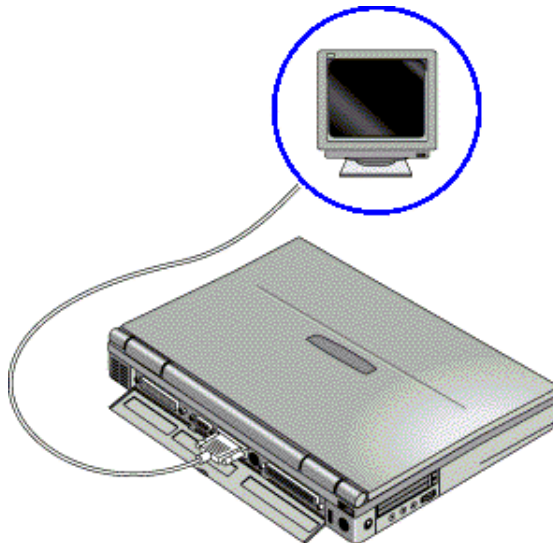

Hint

Switching Displays. Use Fn+F5 to switch among the built-in display, an external display, and simultaneous displays.

To connect a printer or other parallel device

The most common parallel device is a printer.

- Connect the parallel printer cable or other parallel cable to the parallel port.

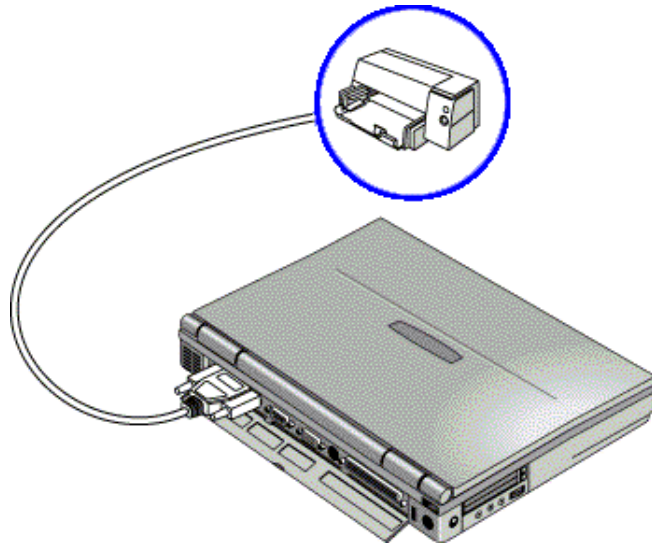

To connect a serial mouse or other serial device

- Connect the serial cable to the serial port.

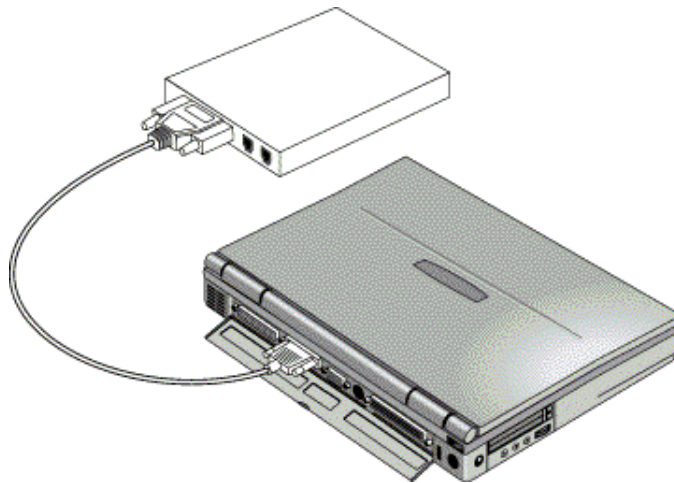

If you are connecting a serial mouse, you need to select Standard Serial Mouse in Control Panel, Mouse, General, Change.

To connect an external PS/2 keyboard or a PS/2 mouse

1. From the Start menu, shut down the OmniBook.
2. Plug the mouse or keyboard PS/2 cable into the PS/2 port on the OmniBook.
 - To connect both a mouse and a keyboard, use the HP F1469A PS/2 Y-adapter.
 - To connect a device that has a PC-type jack, first connect its cable to an adapter cable with a PS/2 jack.

3. Press the blue power button to turn on the OmniBook.

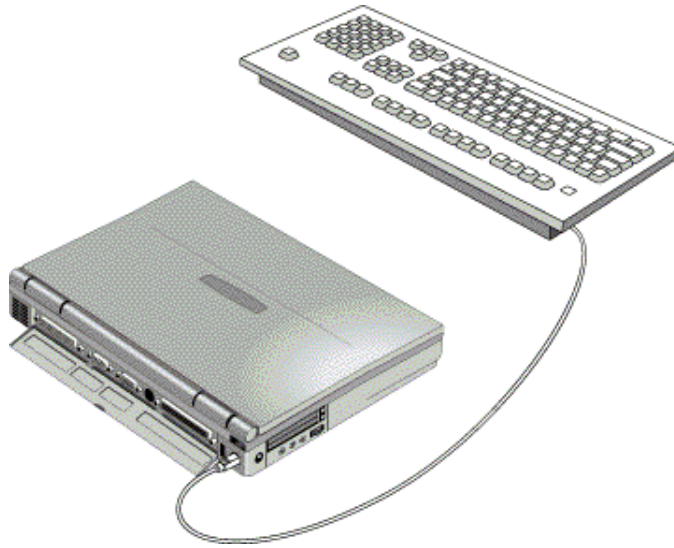

Hint

To use hot keys from an external keyboard, substitute CTRL+ALT for the OmniBook Fn key. For example, to access Fn+F2, press CTRL+ALT+F2. If this does not work, check that the setting for External Fn Key is enabled in the System Devices menu of the [BIOS Setup utility](#).

To connect a universal serial bus device

Note

Windows NT 4.0 does not support universal serial bus (USB) devices.

Universal serial bus (USB) is a new technology that provides a bidirectional serial interface for adding peripheral devices, such as game controllers, scanners, and mice.

- Plug the USB cable into the USB port on the OmniBook. The device is automatically recognized.



Note

If you have problems making this connection, contact the vendor of the peripheral device, as well as Hewlett-Packard, for the latest versions of the USB drivers. The USB technology is new and continues to develop.

To connect an audio source, a microphone, or headphones

Your OmniBook has a built-in microphone above the keyboard and two stereo speakers. The audio jacks allow you to plug in external audio devices:

- Plug a stereo input source (such as a CD player) into the input (left) jack.
- Plug the microphone into the microphone (middle) jack. The built-in microphone turns off.
- Plug devices such as headphones or external (amplified) speakers into the output (right) jack. The built-in speakers turn off.

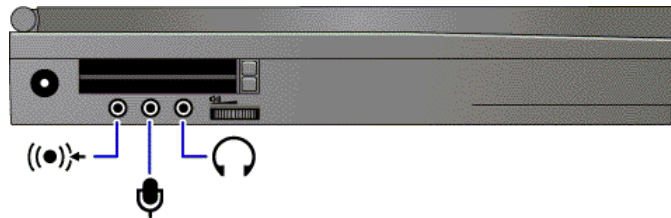

Caution

Do not use mono audio plugs, which can damage the computer.

To connect a television

If your television has an S-video port, you can connect it to the OmniBook and use your television display as a monitor. For complete information about connecting a television, refer to the OmniBook *Reference Guide*.

To make an infrared connection

Note

Windows NT 4.0 does not support infrared communication.

The OmniBook provides two infrared ports—one on the front of the OmniBook (below the latch) and one on the rear panel. These infrared ports provide wireless, serial communication between the OmniBook and other infrared devices such as printers or other OmniBooks.

By default, the infrared ports are *not enabled*. You must install the appropriate infrared driver, enable it in the BIOS Setup utility, and choose to use either the front or rear infrared port. Refer to the *Reference Guide* and the driver's Readme files for complete information about infrared connections.

Front Infrared Port

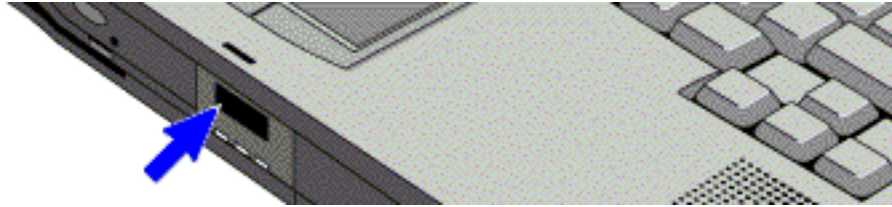

Rear Infrared Port



- Line up the OmniBook's infrared port and the other infrared port in as straight a line as possible. The two ports should be no more than 1 meter apart, with no obstructions in between.
- Check the status of communications (Start, Settings, Control Panel, Infrared Monitor).
- To switch between the front and rear infrared ports, press Fn+F.

Using PC Cards

- [To insert a PC Card.](#)
- [To remove a PC Card.](#)

To insert a PC Card

Caution

Never insert or remove a plug-in card while an OmniBook PC Card drive is actively reading or writing data. Wait until the PC Card drive is done. Otherwise, you could lose data or the OmniBook could stop responding.

The OmniBook PC Card slots are available for storing data and expanding the communication capabilities of the OmniBook. The OmniBook supports standard Type I, II, and III PC Cards (PCMCIA and CardBus). You can use two Type I or II cards or one Type III card. Except in Windows NT 4.0, both slots support Zoomed Video, which allows a zoomed video card to show high-quality multimedia presentations.

For information about compatible cards, visit our website at <http://www.hp.com/omnibook>. Or contact Hewlett-Packard as described in the *Support and Service* booklet.

Note

Do not install Card Services or Socket Services software if it comes with your PC Card.

Windows 95 already includes Card Services and Socket Services, which automatically detect and set up PC Cards you install in the upper and lower card slots. Different versions of this software will disrupt this support.

Windows NT 4.0 requires that you install Phoenix Card Executive drivers. See the *OmniBook Reference Guide* for instructions.

The OmniBook automatically detects and sets up a card when you insert it in a card slot. See the card's instructions for additional information.

1. Hold the card with its face up with its connector holes toward the card slot.
2. Slide the card into a PC Card slot until it won't go any further. A double beep signals that the card has been recognized and is successfully configured by your computer.

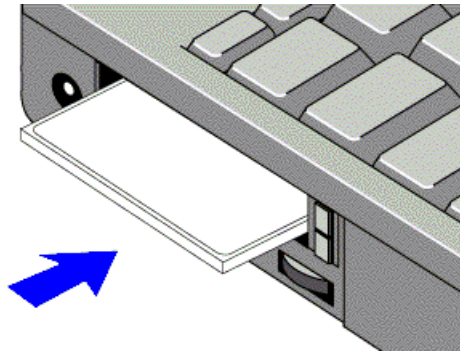

To remove a PC Card

Caution

Never remove an I/O card while an application is open that's set up to use that card. If you remove the card, the application (or the OmniBook) might behave unpredictably or stop responding until you reset the OmniBook. Exit the application first.

Never insert or remove a plug-in card while the PC Card drive is actively reading or writing data. Check the PC Card indicator in the [status panel](#) and wait until the PC Card drive is done. Otherwise, you could lose data or the OmniBook could stop responding.

1. Stop the PC Card by clicking the PC Card indicator in the taskbar, then clicking Stop.

This protects your data and avoids unexpected problems. You can restart the card by removing it, then inserting again.
2. Press the ejector button once to pop the button out.
3. Press the ejector button again to pop the card out.

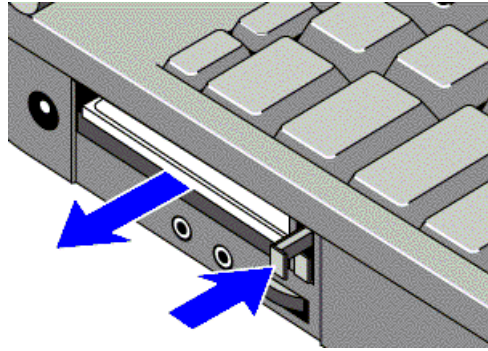

Using Docking Products

- [To install a docking tray.](#)
- [To dock the OmniBook.](#)
- [To undock the OmniBook.](#)

The OmniBook docking products provide external connections for the OmniBook that you can leave in place whenever you remove the OmniBook from your desk. Instead of disconnecting and reconnecting peripheral devices, you simply undock and dock the OmniBook.

Refer to the *User's Guide* for OmniBook docking products for more information.

To install a docking tray

Your dock requires a tray that accommodates your specific OmniBook model. You must ensure that this tray is installed prior to docking the OmniBook.

1. Select the tray labeled with the letter A.
2. Slide the rear of the tray into the dock as shown on the label on the dock.
3. Push down firmly on both sides of the tray until it snaps into place.

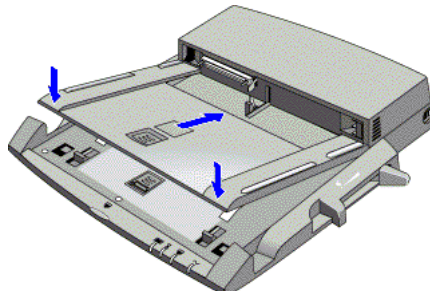

To remove a tray from the dock, pull the latch (near the center front of the dock) towards you until the tray pops free.

To dock the OmniBook

1. From the Start menu, shut down the OmniBook.
If you have a plug-and-play operating system, such as Windows 95, you do *not* need to turn off the OmniBook before inserting it into the dock.

Caution

Use only an HP F1454A ac adapter (the type shipped with your OmniBook). Using any other ac adapter could damage the OmniBook and may void your warranty. Refer to the warranty statement for your product.

2. Plug the power cord into the ac adapter, then into an ac outlet. Plug the ac adapter into the dock.

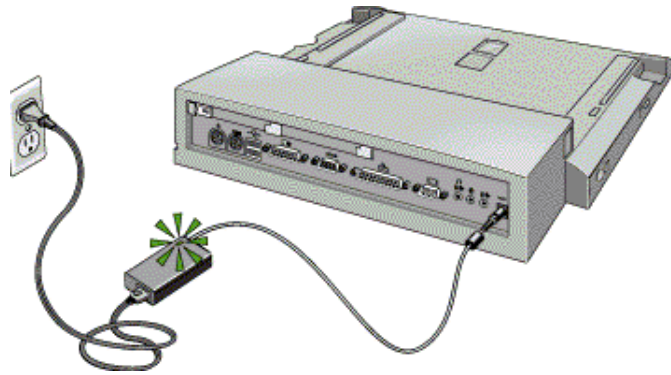

3. On the rear of the OmniBook, slide the docking door to the left.

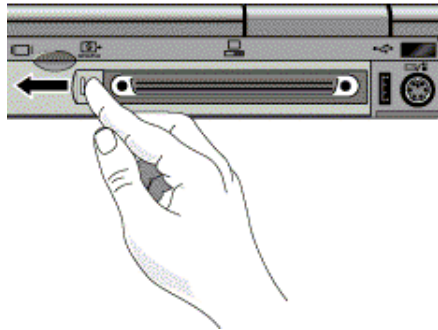

4. Place the OmniBook on the dock platform, with the rear of the computer facing the dock's docking connector.
5. Position your fingers on the platform grips as shown below. Use your thumbs to push the computer into the dock until the computer slides into place.

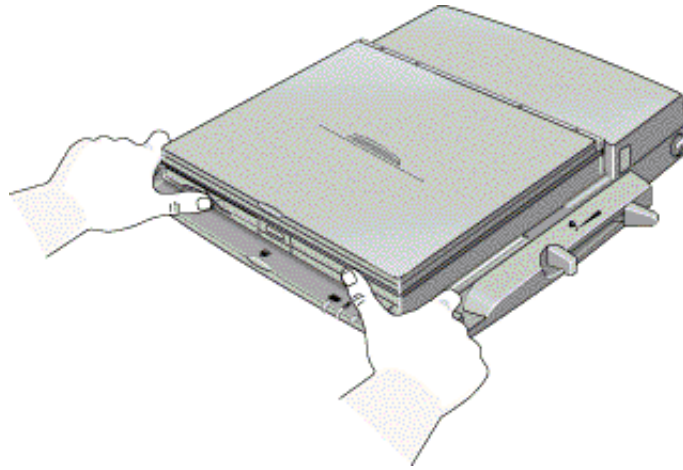

To undock the OmniBook

1. From the Start menu, shut down the OmniBook.
If you have a plug-and-play operating system, such as Windows 95, you do *not* need to turn off the OmniBook before removing it from the dock.
2. Press the undock button on the front of the dock and wait for the undock light to turn green.
3. Position your thumb as shown and pull the release lever forward.

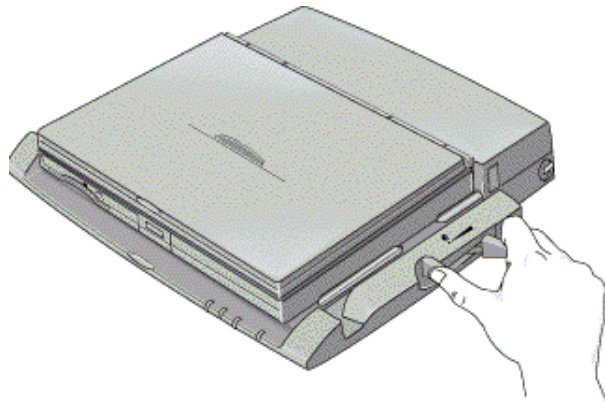

4. Remove the OmniBook from the dock.

5. Maintenance and Troubleshooting

- [Cleaning the Computer.](#)
- [Solving Common Problems.](#)

Cleaning the Computer

- [To clean the case.](#)
- [To clean the display.](#)

To clean the case

Use a soft, lint-free cloth to clean the case. You can use a mild detergent, but *do not use abrasives or solvents*, such as thinner, benzene, or isopropyl alcohol.

Apply the cleaner to the cloth, and *not* directly onto the computer.

To clean the display

Use a soft, lint-free cloth to clean the display glass. You can use a glass cleaner, but avoid ammonia-based cleaners.

Apply the cleaner to the cloth, and *not* directly onto the display.

Solving Common Problems

- [Accessory Problems.](#)
- [Audio Problems.](#)
- [Display Problems.](#)
- [Hard Disk Drive Problems.](#)
- [Infrared Problems.](#)
- [Keyboard and Pointing Device Problems.](#)
- [Memory Problems.](#)
- [PC Card \(PCMCIA\) Problems.](#)
- [Performance Problems.](#)
- [Power and Battery Problems.](#)
- [Printing Problems.](#)
- [Serial, Parallel, and USB Problems.](#)
- [Startup Problems.](#)

If you have troubleshooting questions that this handbook doesn't answer, you can

- See the printed OmniBook *Reference Guide*. You can obtain a backup copy of this guide from the HP website (<http://www.hp.com/omnibook>).
- Check OmniBook Notes for the most current troubleshooting suggestions (Start, Programs, OmniBook Library, OmniBook Notes).
- Look at the online Help for Windows and other applications.
- Check with your computer system administrator, if you have one.
- Check your local library or bookstore for other books about Windows, MS-DOS, and other applications.
- Contact your dealer, or contact Hewlett-Packard. See the OmniBook *Support and Service* booklet or open OmniBook Support in the online OmniBook Library.
- Click Start and Help to use the Windows “troubleshooters” provided for several types of common problems. On the Contents tab, open the Troubleshooting book, then start the desired troubleshooter.

Accessory Problems

If a port on a dock isn't working

- Check that ac power is connected.
- Try using the corresponding OmniBook port while undocked.

If you can't boot from a CD in the CD-ROM drive

- Make sure the CD is a bootable CD, such as the *Recovery CD*.
- Make sure the CD-ROM / floppy disk drive is seated correctly in the OmniBook—remove and reinsert.
- If you always want to boot from a CD, check boot order in the BIOS Setup utility.
 1. From the Start menu, shut down, then restart the OmniBook.
 2. When you see the HP logo, press F2 to enter the BIOS Setup utility.
 3. Open the Boot menu. The default boot order is
 - Diskette Drive
 - Hard Drive
 - CD-ROM Drive
 4. If CD-ROM Drive is not option 1, use the arrow keys to select CD-ROM Drive.
 5. Press F6 to move up (or F5 to move down) in the list.
 6. Press F10 to Save and Exit the BIOS Setup utility.
- Make sure you are using an internal OmniBook CD-ROM / floppy disk drive module. You cannot boot from an external CD-ROM drive, which you can connect to the OmniBook via a PC Card SCSI connection.
- [Reset](#) the OmniBook.

Audio Problems

If sounds aren't audible

- Roll the volume control wheel forward to [increase the volume](#).
- Check settings in BIOS Setup.
 1. From the Start menu, shut down, then restart the OmniBook.
 2. When you see the HP logo, press F2 to enter the BIOS Setup utility.
 3. From the System Devices menu, check that Audio is enabled.

If you hear a loud high-pitched whine (feedback) from the speakers

- Try reducing the Master volume (Start, Programs, Accessories, Multimedia, Volume Control).
- Avoid using both the built-in microphone and the built-in speakers.

If sound doesn't record

- Check settings in the BIOS Setup utility.
 1. From the Start menu, shut down, then restart the OmniBook.
 2. When you see the HP logo, press F2 to enter the BIOS Setup utility.
 3. From the System Devices menu, check that Audio is enabled.
- Check software controls for recording sound (click Start, Program, Accessories, Multimedia, Sound Recorder).

Display Problems

If the OmniBook is on, but the screen is blank

- Press the space bar to see if the computer is in Standby mode.
- Press Fn+F1 or Fn+F2 to adjust the display.
- Press Fn+F5 in case the internal display was disabled. (Do this three times to return to the state you started from.)
- If the OmniBook is cold, allow it to warm up.

If the screen is difficult to read

- Check whether the display resolution is set to its default setting, 1024 x 768 (XGA). Check this in Start, Settings, Control Panel, Display, Settings.
- Check brightness (Fn+F2 to increase brightness).

Hard Disk Drive Problems

If the OmniBook's hard drive doesn't spin

- Check the power source.
- Remove and reinsert the hard drive. If necessary, see the *OmniBook Reference Guide* for instructions.

If the hard disk makes buzzing or whining noise

- Back up the drive immediately.
- Check for alternate noise sources, such as the fan or a PC Card drive.

If files are corrupted

- Run the McAfee VirusScan program; see ["To install McAfee VirusScan."](#)
- Windows 95 only. Run the Scandisk surface scan to check the platter. (This is not available in Windows NT 4.0). From the Start menu, click Programs, Accessories, System Tools, Scandisk.

Infrared Problems

If you have problems with infrared communications

- Windows NT 4.0 does not support infrared devices.
- Make sure the infrared light path is not blocked.
- Press Fn+F to toggle between the front and rear OmniBook infrared ports.
- Check settings in the BIOS Setup utility.
 1. From the Start menu, shut down, then restart the OmniBook.
 2. When you see the HP logo, press F2 to enter the BIOS Setup utility.
 3. From the System Devices menu, check that Infrared Port is enabled.
 4. Check which infrared port you have enabled (front or rear port).
 5. Press F10 to Save and Exit the BIOS Setup utility.
- For infrared communications, an infrared driver must be installed and a BIOS Setup setting must be enabled. For details, refer to the driver's Readme file located in \OmniBook\drivers.
- Check that only one application is using the infrared port.
- If you have Standard IR and Fast IR computers communicating with each other, make sure that they are set to the highest *common speed* (115200 baud).
- Remove any PC Cards. An infrared IRQ conflict is possible if two PC Cards are plugged in at the same time.

If an infrared printer doesn't print

- Make sure the infrared light path is not blocked.
- An infrared driver must be installed and the BIOS Setup setting must be enabled. For details, refer to the driver's Readme file located in \OmniBook\drivers.
- In Windows Help, use the Print Troubleshooter.

Keyboard and Pointing Device Problems

If the embedded numeric keypad doesn't work

- Make sure Num Lock is on.

- Make sure the embedded Keypad Lock (Fn+F8) is on—or that you press and hold the Fn key to temporarily access the embedded keypad.

If the pointer is difficult to control

- To customize all pointing devices, use the Mouse icon in Control Panel to go to Mouse Properties.
- To customize the operation of the pointing stick, use the pointing stick icon available on the taskbar (or in the Windows Control panel) to access TrackPoint Properties.
- [Reset](#) the OmniBook.

If the touch pad or pointing stick doesn't work

- Make sure the touch pad or pointing stick is enabled in the BIOS Setup utility.
 1. From the Start menu, shut down, then restart the OmniBook.
 2. When you see the HP logo, press F2 to enter the BIOS Setup utility.
 3. From the System Devices menu, check Internal Pointing Devices.
 4. Select the desired pointing device.
 5. Press F10 to Save and Exit the BIOS Setup utility.
- [Reset](#) the OmniBook.

Memory Problems

If a message says you are out of memory

- In Windows Help, use the memory troubleshooter.
- If you are having memory problems running MS-DOS programs, in Windows Help use the MS-DOS troubleshooter.

PC Card (PCMCIA) Problems

If the OmniBook doesn't recognize a PC Card

- Remove and reinsert the PC Card.
- If the card requires an IRQ, check that there is one available. Look in Windows Device Manager.
- Check the OmniBook website for information about supported PC Cards.
- Try the card in another computer.

Performance Problems

If the OmniBook gets hot

- It is normal for the computer to get warm.
- Make sure the air vents are clear.

- DOS games and other programs that drive CPU usage toward 100% can contribute to a temperature increase.

If the OmniBook pauses or runs sluggishly

- This may be normal Windows behavior (background processing can affect response time).
- Check the BIOS Setup settings.
 1. From the Start menu, shut down, then restart the OmniBook.
 2. When you see the HP logo, press F2 to enter the BIOS Setup utility.
 3. From the Power menu, set the Power Management Mode to Max. Performance.
 4. Press F10 to Save and Exit the BIOS Setup utility.
- Certain background operations (such as virus scans) can affect performance while they're running.
- Some file browsers may be unresponsive while they're processing a graphic image or waiting for broken network connections to time out.
- Install additional memory if Windows is spending a lot of time swapping to disk.
- Check amount of available free disk space.

Power and Battery Problems

If the OmniBook turns off immediately after it turns on

- Battery power is probably extremely low. Plug in the ac adapter, insert a new charged battery module, or insert a second battery module.

If the OmniBook keeps beeping

- The OmniBook beeps for 15 seconds when the battery is low. Save your work, quit immediately, and insert a charged battery or plug in the ac adapter.

If the OmniBook has a short operating time

- Try conserving power using any of the suggestions listed under ["To optimize battery operating time."](#)
- If the operating time has gotten shorter and the battery is more than a year or two old, you may need to replace the battery.
- Turn down the display brightness (Fn+F1).
- Check the Power Management settings in the BIOS Setup utility.
 1. From the Start menu, shut down, then restart the OmniBook.
 2. When you see the HP logo, press F2 to enter the BIOS Setup utility.
 3. From the Power menu, make sure the Power Management Mode is set to Max. Power Savings.
 4. Press F10 to Save and Exit the BIOS Setup utility.

If battery indicator is inaccurate

- After extended use with ac power, the battery indicator may no longer reliably report the actual charge on the battery. To improve the accuracy of this indicator, use the following procedure to run 2 to 4 cycles of battery charging/discharging.
 1. Connect the ac adapter and charge the battery to full capacity.
 2. Unplug the ac adapter and leave the OmniBook on until the battery is fully discharged and the system turns off. If you are not using the OmniBook during this step, you can temporarily customize the [time-out settings](#) in the BIOS Setup utility to speed up the discharging.

If the battery doesn't charge

- Make sure the ac adapter is plugged into the power source.
- Check that the battery module is fully installed and locked in place.
- Turn off the OmniBook, then check that the battery contacts are clean and that the ac adapter cables are fully plugged in.
- Move the OmniBook away from any nearby heat source. Unplug the ac adapter and allow the battery to cool down. An elevated battery temperature prevents charging.
- If available, try another battery and ac adapter.

If a second battery doesn't charge

- A second battery doesn't charge until the main battery is fully charged.
- Make sure the ac adapter is plugged into the power source.
- Check that a second battery module is fully installed and locked in place.

If the OmniBook stops responding

- Press the blue power button and wait a few moments until the icons on the status panel stabilize. Then press the power button again to turn the OmniBook back on.
- If nothing happens, insert a paper clip into the system-off button; see "[To reset the OmniBook.](#)"

If the OmniBook doesn't suspend as expected

- If you have a connection to another computer, the OmniBook doesn't suspend if the connection is actively in use.
- If the OmniBook is performing an operation, it normally waits for the operation to finish.

Printing Problems

Hint

For most printing problems, use the Print Troubleshooter in Windows Help.

If a serial or parallel printer doesn't print

- Check that you are using a proper cable or cable adapter, and that the printer is on.
- Check for paper in the printer or other printer errors.
- Make sure the printer cable is secure at both ends.

If an infrared printer doesn't print

- Windows NT 4.0 does not support infrared devices.
- Make sure the infrared light path is not blocked.
- Check for paper in the printer or other printer errors.
- Make sure Windows is running—infrared printing is supported only while Windows is running.
- An infrared driver must be installed and the BIOS Setup setting must be enabled. For details, refer to the drivers' Readme files (located in \Omnibook\Drivers).
- In Windows Help, use the Print Troubleshooter.

If the left edge of printed output is missing

- If the printer you are using is a 600-dpi (dots per inch) printer, try selecting a compatible printer driver for a 300-dpi printer. For example, for a 600-dpi HP LaserJet printer, try using the HP LaserJet IIIsi driver (300-dpi). Certain applications may not work properly with 600-dpi printers.

Serial, Parallel, and USB Problems

If the serial mouse doesn't work

- First, confirm that you have followed the manufacturer's installation instructions completely and have installed the mouse properly.
- Check the port connection (may be loose).

If a serial modem doesn't work properly

- In Windows Help use the modem troubleshooter.
- Check the port connection (may be loose).

If an I/O card stops communicating properly

- It may have been reset if the OmniBook suspended or turned off. Exit and restart the application.

If the serial or parallel port is not working

- Check the port connection (may be loose).
- Check settings in BIOS Setup.
 1. From the Start menu, shut down, then restart the OmniBook.
 2. When you see the HP logo, press F2 to enter the BIOS Setup utility.

3. From the System Devices menu, check that Parallel Port or Serial Port is enabled.

If the USB port is not working

- Windows NT 4.0 does not support USB devices.
- Contact the vendor of the peripheral device, as well as Hewlett-Packard, for the latest versions of the USB drivers.

Startup Problems

If the OmniBook doesn't respond at turn-on

- Connect the ac adapter.
- Press blue power to try turning on the unit.
- [Reset](#) the OmniBook.

If you get no response, remove the battery and ac adapter—then plug in the ac adapter and try [resetting](#). If you still get no response, the unit requires service.

If the OmniBook doesn't boot from battery power

- Make sure the battery is properly inserted.
- Check battery level on status panel and battery LEDs.
- Check battery contacts. If available, try another battery.

If the OmniBook doesn't boot from the floppy disk drive

- Check the boot order in the BIOS Setup utility.
 1. From the Start menu, shut down, then restart the OmniBook.
 2. When you see the HP logo, press F2 to enter the BIOS Setup utility.
 3. Open the Boot menu. The default boot order is
 - Diskette Drive
 - Hard Drive
 - CD-ROM Drive
 4. If Diskette Drive is not option 1, use the arrow keys to select Diskette Drive.
 5. Press F6 to move up (or F5 to move down) in the list.
 6. Press F10 to Save and Exit the BIOS Setup utility.

Index

A

- ac adapter
 - charging battery, 24
 - connecting, 10, 24
 - docking product, 37
 - jack, 7
 - safety, 8
 - status, 19
- accessories
 - CD-ROM / floppy disk drive, 28
 - problems, 41
 - second battery, 28
- adjusting
 - brightness, 15
 - volume, 16
- Alt Gr key, 18
- audio
 - adjusting volume, 16
 - connections, 34
 - problems, 41
- audio jacks
 - location, 7
 - using, 34

B

- backlight life, 15
- backup battery, 23
- battery
 - backup, 23
 - brightness affects, 15
 - charging, 24
 - charging time, 24
 - life, 24
 - low warning, 23
 - operating time, 15, 25
 - permanent, 23
 - problems, 45
 - replacing, 24
 - safety, 8
 - saving power, 25
 - status, 19
- beeping, 23
- BIOS Setup utility, 26
- booting
 - from CD-ROM drive, 41
 - from floppy disk drive, 48
- brightness, 15

C

- cable
 - security lock, 21

- Caps Lock, 20
- CardBus, 35
- cards
 - inserting, 35
 - removing, 36
- CD-ROM drive
 - booting from, 41
 - inserting CDs, 29
 - opening manually, 29
 - removing CDs, 29
 - status, 18, 19
- CDs, 29
- charging
 - optimum, 24
 - starting, 24
 - status, 18, 19, 24
 - time, 24
- CHKDSK, 43
- cleaning
 - computer, 40
 - display, 40
- COM1 port, 8
- connecting
 - ac adapter, 24
 - audio source, 34
 - external keyboard or mouse, 32
 - external monitor, 30
 - microphone, 34
 - mouse, 32
 - parallel device, 31
 - printer, 31
 - serial device, 32
 - speakers, 34
 - television, 34
 - USB device, 33
- corrupted files, 43
- CTRL+ALT (external keyboard), 33
- cursor (pointer), 12
- cursor control, 17

D

- data storage device status, 19
- disks
 - CDs, 29
 - floppy, 29
- display
 - activating, 30
 - adjusting, 15
 - extending life, 15
 - external, 30
 - port location, 8
 - problems, 42
 - properties, 30
- docking port, 8

- docking products
 - tray, 37
 - using, 37
- documentation, 4, 40
- dragging items, 13
- drive C
 - booting from, 12
- drive status, 19

E

- embedded keypad
 - problems, 43
 - using, 17
- external
 - keyboard, 32
 - monitor, 30
- external keyboard
 - port location, 8

F

- F1 through F12, 17
- fast infrared, 34
- FIR
 - port location, 8
 - using, 34
- floppy disk drive
 - booting from, 48
 - inserting disks, 29
 - status, 18, 19
- Fn key
 - + F (infrared port selection), 17
 - + F1 (decrease brightness), 17
 - + F12 (Hibernate), 11, 17
 - + F2 (increase brightness), 17
 - + F5 (display selection), 15, 17, 30
 - + F6 (battery status), 17
 - + F8 (keypad lock), 17, 20
 - + NmLk (Scroll Lock), 17, 20
 - + R (Suspend), 11, 17
 - + S (Standby), 11, 17
- external keyboard, 33
- using, 17
- function keys
 - F1 (help), 4
 - F2 (BIOS Setup utility), 20
 - hot keys, 17

G

- getting help
 - information sources, 4
 - online manual, 4

H

- hard disk drive
 - problems, 42

- status, 18
- headphones, 34
- help
 - information sources, 4
 - online manual, 4
 - Windows, 8
- Hibernate mode
 - low battery, 23
 - using, 25
- hot keys
 - using, 17

I

- icons (status panel), 19
- indicators (status panel), 19
- infrared
 - communications, 34
 - light path, 43
 - port location, 8
 - printing problems, 43
 - problems, 43
 - setting up, 34
- installing
 - PC Cards, 35
 - plug-in modules, 28
- instant-on, 11

K

- Kensington lock, 21
- keyboard
 - embedded keypad, 17
 - external, 32
 - port location, 8
 - problems, 43
 - status, 20
- keypad
 - cursor control, 17
 - embedded, 17
 - numeric, 17
- Keypad Lock, 20
- keys
 - Windows, 17

L

- laser safety, 9
- learning Windows, 8
- LED safety, 9
- lid switch, 11
- lights
 - ac adapter, 10
 - infrared, 43
 - status, 18
- lock-up, 12
- low battery
 - charging, 24
 - replacing, 24

warning, 23
LPT1 port, 8

M

maintenance
 computer, 40
 display, 40
McAfee VirusScan, 22
memory problems, 44
microphone
 connecting, 34
 location, 6
MicroSaver lock, 21
monitor
 external, 30
mouse
 (PS/2) port location, 8
 connecting, 32
 serial, 32
moving the pointer, 13

N

Num Lock
 status, 20
 using, 17
numeric keypad, 17

O

on/off button
 action, 11
 location, 6
online User's Handbook, 4

P

parallel port
 connecting device, 31
 location, 8
 problems, 47
password
 clearing, 21
 setting, 20
PC Cards
 inserting, 35
 problems, 44
 removing, 36
 saving power, 25
 slots for, 7, 35, 36
 status, 19
 types, 35
performance problems, 44
plug-in modules
 CD-ROM / floppy disk drive, 28
 location, 6
 replacing, 28
 second battery, 28

pointer
 customizing, 15
 moving, 13
pointing devices
 customizing, 15
 location, 6
 problems, 43
 settings, 15
 using, 12
pointing stick
 full function, 14
 location, 6
 problems, 44
 settings, 15
 using, 13
ports
 ac (docking product), 37
 locations, 8
power
 button, 11
 button location, 6
 connecting ac, 10, 24
 conserving, 26
 cord, 24
 indicator location, 6
 modes, 11
 on and off, 11
 problems, 45
 saving, 25
 status, 18
 suspending, 11
power management
 status, 19
printer
 connecting, 31
 infrared, 43
 problems, 46
protection
 security cable, 21
PS/2
 connection, 32
 mouse port, 8

R

RAM
 troubleshooting, 44
rebooting
 from drive C, 12
rebooting the computer, 12
recharging battery, 24
Reference Guide, 4, 40
removing
 battery, 24
 PC Cards, 36
 plug-in modules, 28
replacing
 battery, 24
 plug-in modules, 28

reset, 12
restart, 12

S

safety information, 8
saving battery power, 25
Scandisk, 43
Scroll Lock, 20
second battery, 25
security cable, 21
selecting
 text, 13
serial port
 connecting device, 32
 conserving power, 25
 location, 8
 problems, 47
service, 9
Setup utility, 26
shift keys, 17, 18, 33
shortcut keys, 17
shut down, 11
slow infrared, 34
sound
 connections, 34
 volume, 16
Sound Blaster Pro, 16
speakers
 connecting, 34
 location, 6
 volume, 16
Start menu, 11
startup
 problems, 48
status
 battery, 19
 drive, 19
 keyboard, 20
 power, 18
status lights
 interpreting, 18
 location, 7
status panel
 indicators, 19
 location, 6
stereo input/output, 34
support, 9
suspending power, 11
system
 password, 20
 status, 18
system-off button
 location, 6
 using, 12

T

technical support, 4

television
 connecting, 34
time-out settings, 26
touch pad
 full function, 14
 location, 6
 problems, 44
 settings, 15
 using, 13
tour of Windows, 8
transporting the computer, 12
tray
 dock, 37
troubleshooting
 accessory problems, 41
 audio problems, 41
 battery problems, 45
 display problems, 42
 embedded keypad, 43
 hard disk drive problems, 42
 infrared problems, 43
 keyboard problems, 43
 memory problems, 44
 no response, 12
 parallel problems, 47
 PC Card problems, 44
 performance problems, 44
 pointing devices, 43
 pointing stick problems, 44
 power problems, 45
 printing problems, 46
 serial problems, 47
 startup problems, 48
 touch pad problems, 44
 USB problems, 47
turning off
 automatically, 23
 manually, 11
turning on, 11
typing numbers, 17

U

undocking, 39
universal serial bus (USB), 33
USB port
 location, 8
 problems, 47

V

VGA output, 8
virus detection, 22, 43
volume
 adjusting in Windows, 16
 control wheel, 7, 16

W

warning (low battery), 23
website, 4
Windows
 keys, 17

learning about, 8

Z

Zoomed Video, 35