HP OmniBook 4150

———— User's Handbook

Notice

This manual and any examples contained herein are provided “as is” and are subject to change without notice. Hewlett-Packard Company makes no warranty of any kind with regard to this manual, including, but not limited to, the implied warranties of merchantability and fitness for a particular purpose. Hewlett-Packard Co. shall not be liable for any errors or for incidental or consequential damages in connection with the furnishing, performance, or use of this manual or the examples herein.

Consumer transactions in Australia and the United Kingdom: The above disclaimers and limitations shall not apply to Consumer transactions in Australia and the United Kingdom and shall not affect the statutory rights of Consumers.

© Copyright Hewlett-Packard Company 1999. All rights reserved. Reproduction, adaptation, or translation of this manual is prohibited without prior written permission of Hewlett-Packard Company, except as allowed under the copyright laws.

The programs that control this product are copyrighted and all rights are reserved. Reproduction, adaptation, or translation of those programs without prior written permission of Hewlett-Packard Co. is also prohibited.

Portions of the programs that control this product may also be copyrighted by Microsoft Corporation, SystemSoft Corp., Phoenix Technologies, Ltd., ATI Technologies Inc., NeoMagic Corporation, and Adobe Systems Incorporated. See the individual programs for additional copyright notices.

Microsoft, MS, MS-DOS, Windows, and Windows NT are registered trademarks of Microsoft Corporation. Pentium and the Intel Inside logo are U.S. registered trademarks of Intel Corporation. TrackPoint is a U.S. registered trademark of International Business Machines, Adobe and Acrobat are trademarks of Adobe Systems Incorporated.

Hewlett-Packard Company
Mobile Computing Division
19310 Pruneridge Ave.
Cupertino, CA 95014

HP Software Product License Agreement

Your HP OmniBook PC contains factory-installed software programs. Please read the Software License Agreement before proceeding.

Carefully read this License Agreement before proceeding to operate this equipment. Rights in the software are offered only on the condition that the customer agrees to all terms and conditions of the License Agreement. Proceeding to operate the equipment indicates your acceptance of these terms and conditions. If you do not agree with the terms of the License Agreement, you must now either remove the software from your hard disk drive and destroy the *Recovery CD*, or return the complete computer and software for a full refund.

Proceeding with configuration signifies your acceptance of the License Terms.

Unless otherwise stated below, this HP Software Product License Agreement shall govern the use of all software that is provided to you, the customer, as part of the HP computer product. It shall supersede any non-HP software license terms that may be found online, or in any documentation or other materials contained in the computer product packaging.

Note: Operating System Software by Microsoft is licensed to you under the Microsoft End User License Agreement (EULA).

The following License Terms govern the use of the software:

Use. Customer may use the software on any one computer. Customer may not network the software or otherwise use it on more than one computer. Customer may not reverse assemble or decompile the software unless authorized by law.

Copies and Adaptations. Customer may make copies or adaptations of the software (a) for archival purposes or (b) when copying or adaptation is an essential step in the use of the software with a computer so long as the copies and adaptations are used in no other manner.

Ownership. Customer agrees that he/she does not have any title or ownership of the software, other than ownership of the physical media. Customer acknowledges and agrees that the software is copyrighted and protected under the copyright laws. Customer acknowledges and agrees that the software may have been developed by a third party software supplier named in the copyright notices included with the software, who shall be authorized to hold the Customer responsible for any copyright infringement or violation of this Agreement.

Product *Recovery CD-ROM*. If your computer was shipped with a product *Recovery CD-ROM*: (i) The product *Recovery CD-ROM* and/or support utility software may only be used for restoring the hard disk of the HP computer with which the product *Recovery CD-ROM* was originally provided. (ii) The use of any operating system software by Microsoft contained in any such product *Recovery CD-ROM* shall be governed by the Microsoft End User License Agreement (EULA).



Transfer of Rights in Software. Customer may transfer rights in the software to a third party only as part of the transfer of all rights and only if Customer obtains the prior agreement of the third party to be bound by the terms of this License Agreement. Upon such a transfer, Customer agrees that his/her rights in the software are terminated and that he/she will either destroy his/her copies and adaptations or deliver them to the third party.

Sublicensing and Distribution. Customer may not lease, sublicense the software or distribute copies or adaptations of the software to the public in physical media or by telecommunication without the prior written consent of Hewlett-Packard.

Termination. Hewlett-Packard may terminate this software license for failure to comply with any of these terms provided Hewlett-Packard has requested Customer to cure the failure and Customer has failed to do so within thirty (30) days of such notice.

Updates And Upgrades. Customer agrees that the software does not include updates and upgrades which may be available from Hewlett-Packard under a separate support agreement.

Export Clause. Customer agrees not to export or re-export the software or any copy or adaptation in violation of the U.S. Export Administration regulations or other applicable regulation.

U.S. Government Restricted Rights. Use, duplication, or disclosure by the U.S. Government is subject to restrictions as set forth in subparagraph (c)(1)(ii) of the Rights in Technical Data and Computer Software clause in DFARS 252.227-7013. Hewlett-Packard Company, 3000 Hanover Street, Palo Alto, CA 94304 U.S.A. Rights for non-DOD U.S. Government Departments and Agencies are as set forth in FAR 52.227-19(c)(1,2).

Edition History

Edition 1	August 1999
Edition 2	December 1999



This manual is printed on recycled paper.

Contents

Introducing the OmniBook.....	9
Getting More Information.....	10
Taking Inventory.....	11
Included in the OmniBook box	11
OmniBook Features	12
OmniBook—Front View.....	12
OmniBook—Side View	13
OmniBook—Back View	14
Setting Up for the First Time.....	15
To set up the OmniBook and Windows	15
Operating the OmniBook.....	17
Starting and Stopping the OmniBook	18
To start and stop the OmniBook	18
To reset the OmniBook.....	19
Checking the Status of the OmniBook.....	20
To check power status and drive activity	20
Using the OmniBook Pointing Devices.....	21
To use the built-in pointing devices	22
Using the OmniBook Display.....	23
To adjust the display brightness	23
To extend the life of the display.....	23
Adjusting the Audio System.....	24
To adjust the volume.....	24
Using the OmniBook Keyboard	25
To use the Fn hot keys	25
To use the embedded keypad	26
Working in Comfort.....	27
About Repetitive Strain Injury	27
Preparing Your Work Environment	29
Setting Up Your HP Computing Equipment.....	31
Comfort and Safety Checklist	36
Your HP OmniBook Computer.....	38
Managing Battery Power	41
How Power is Managed.....	42
Monitoring Battery Power	43
To install APM for Windows NT 4.0.....	43
To check the battery status	44
To respond to a low-battery warning	44
To recharge a battery.....	45

To replace the battery.....	46
To install a second battery.....	47

Expanding the OmniBook..... 49

Using Plug-In Modules.....	50
To install hot-swap support.....	50
To replace a plug-in module	51
Connecting External Devices.....	53
To identify connectors for external devices	53
To connect an external monitor.....	54
To enable the built-in and external displays.....	54
To connect an external keyboard or PS/2 mouse	55
To connect a printer	55
Using PC Cards.....	56
To insert and remove a PC Card	56
To find tested PC Cards	57
To install Card Executive for Windows NT 4.0.....	57
Installing a Hard Disk Drive.....	58
To replace the hard disk drive.....	58
Installing a RAM Expansion Module	59
To install a RAM expansion module	59

Configuring the OmniBook 61

Using BIOS Setup.....	62
To run the BIOS Setup utility	62
Configuring Security Options.....	63
To set or change an OmniBook password.....	63
To delete an OmniBook password	64
To attach a security cable.....	65

Troubleshooting..... 67

Solving Problems.....	68
Accessory Problems.....	68
Audio Problems.....	69
Display Problems	70
Hard Disk Drive Problems	72
Keyboard and Pointing Device Problems	73
Infrared Problems.....	74
Memory Problems.....	75
PC Card (PCMCIA) Problems	75
Performance Problems	77
Power and Battery Problems.....	78
Printing Problems.....	80
Serial, Parallel, and USB Problems.....	81
Startup Problems	82

Testing the Operation.....	84
To run the diagnostic test.....	84
To create a diagnostic floppy disk	85
Recovering Software.....	86
To recover the factory installation of Windows.....	87
Support and Service	89
Getting HP OmniBook Assistance.....	90
Support Assistance	90
Electronic Support Services	90
Repair Assistance.....	91
Customer Support Centers	91
Hewlett-Packard Limited Warranty Statement.....	93
Specifications and Regulatory Information	95
Hardware Specifications	96
Safety Information	99
Power Cords.....	99
Ergonomics	100
Battery Safety.....	100
Laser Safety.....	100
LED Safety.....	101
Regulatory Information.....	102
U.S.A.....	102
Canada.....	103
Japan	103
International	104
Index	105

Introducing the OmniBook

Introducing the OmniBook
Getting More Information

Getting More Information

Congratulations! Your OmniBook sets a new standard in personal computing. Although it's compact and easy to carry, the OmniBook is infused with the quality and attention to detail that are the hallmark of Hewlett-Packard.

The OmniBook *Quick Start* sheet shows how to get your OmniBook up and running quickly. This manual shows how to set up and operate the OmniBook, and it also shows what to do if you run into trouble.

This table lists other sources of supplementary information about OmniBook products.

Source	Description and Location
User's Handbook	This printed manual introduces the OmniBook and shows you the OmniBook basics. It also contains setup instructions, basic operation, troubleshooting, and warranty information.
Online Reference Guide	The full <i>Reference Guide</i> is shipped on the OmniBook hard drive. This manual provides a complete source for operating and maintaining the OmniBook. Look in the OmniBook Library group.
Online OmniBook Notes	For late-breaking information available after the manuals were completed, see OmniBook Notes in the online OmniBook Library.
Microsoft Windows manual	This is shipped with your OmniBook and contains information about using the standard features of the version of Microsoft Windows shipped with your computer.
OmniBook website	http://www.hp.com/omnibook . http://www.europe.hp.com/omnibook (European mirror).
HP Customer Care website	http://www.hp.com/cposupport/eschome.html .
Corporate Evaluator's Guide	This provides information about installing alternate operating systems, as well as how to configure the OmniBook in a corporate, networked environment. Located at the OmniBook website.

Taking Inventory

The HP OmniBook 4150 represents a category of HP notebook computers featuring the latest mobile technologies available. It uses high-speed Intel processors, large TFT displays, and high-capacity hard drives.

Included in the OmniBook box

- HP OmniBook 4150.
- Floppy disk drive.
- CD-ROM or DVD drive.
- AC adapter and power cord.
- Lithium-ion battery.
- The OmniBook *User's Handbook*.
- Quick Start sheet.
- OmniBook *Recovery CD*. Includes Windows recovery and operating system drivers.
- Microsoft Windows manual.

Introducing the OmniBook
OmniBook Features

OmniBook Features

OmniBook—Front View

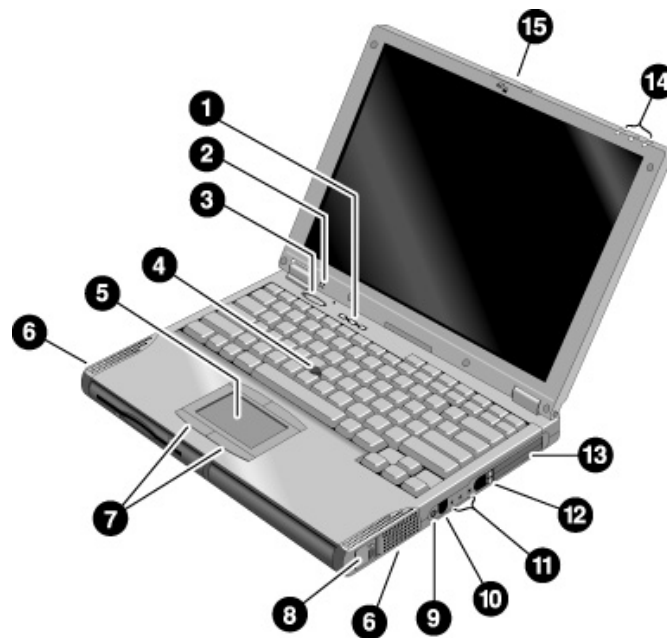

1. Keyboard status lights (left to right: caps lock, keypad lock, num lock).
2. Built-in microphone.
3. Blue power button. Turns the OmniBook on and off.
4. Pointing stick (pointing device).
5. Touch pad (pointing device).
6. Built-in speakers
7. Click buttons (two above and two below touch pad).
8. Main battery release latch.
9. Mute button.
10. AC adapter jack.
11. Audio jacks (left to right): audio line-in, external microphone, audio line-out.
12. PC Card eject buttons (upper and lower PC Card slots).
13. PC Card and CardBus slots (upper and lower). Accepts two Type-II cards or one Type-III card.
14. Main status lights (left to right): power state, hard disk activity, charging status.
15. Latch to open and close the OmniBook.

OmniBook—Side View

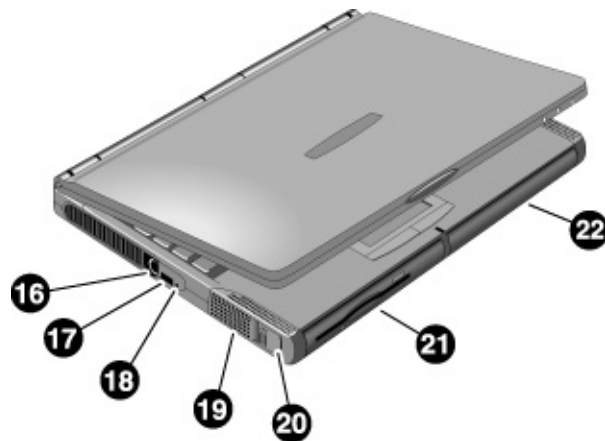

- 16. PS/2 keyboard or PS/2 mouse port (supports Y adapter).
- 17. Universal serial bus port (USB). Windows NT 4.0 does not support USB.
- 18. System-off button (to shut down the OmniBook).
- 19. Built-in speakers.

- 20. Module release latch.
- 21. Plug-in module bay. Can contain a CD-ROM drive, floppy disk drive, LS-120 drive, DVD drive, second hard disk drive, or a second battery.
- 22. Battery bay.

Introducing the OmniBook
OmniBook Features

OmniBook—Back View

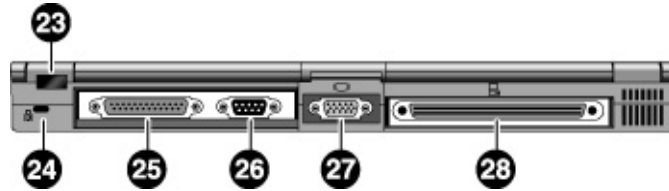

- 23. Infrared port. Windows NT 4.0 does not support infrared communication.
- 24. Kensington lock slot (security connector)
- 25. Parallel port (LPT1). Use this port for a parallel printer, other parallel device, or to connect the floppy disk drive externally.

- 26. Serial port (COM1). Use this port for a serial mouse, a modem, a serial printer, or other serial device.
- 27. External monitor port.
- 28. Docking port.

Setting Up for the First Time

When you set up the OmniBook for the first time, you'll need to install and charge the battery, connect the ac adapter, turn on the OmniBook, and go through the Windows setup program.

To set up the OmniBook and Windows

CAUTION

Use only the HP adapter model F1454A (or other approved adapter) with this product. Using any other ac adapter could damage the OmniBook and may void your warranty. Refer to the warranty statement for your product.

1. If present, remove the “weight-saving” module by sliding the release latch forward, then pushing it back as far as it will go. With the latch open, insert the OmniBook's main battery.
2. Plug in the ac adapter.
3. Connect the ac adapter to the OmniBook's right side, as shown. The OmniBook battery starts charging.

Let the battery charge a full 24 hours to completely charge the internal clock battery. Otherwise, the OmniBook may not keep the correct date and time.

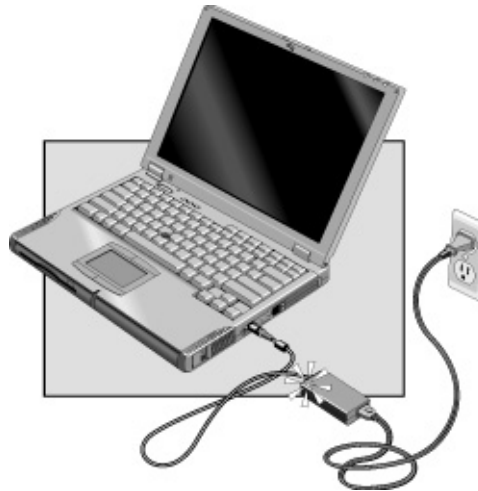

4. Press the blue power button.

Introducing the OmniBook Setting Up for the First Time

5. The Windows Setup program starts automatically. Follow the instructions as they appear on the screen.
6. During setup, you may be prompted to enter the Product Key or Product ID (printed on the Certificate of Authenticity on the Microsoft Windows manual or attached to the bottom of the computer).
7. If you are prompted to set up a user account and password, you can either set up the account or press ESC to skip this step.

Windows NT 4.0

For Windows NT, Card Executive provides support for PC Cards, and Advanced Power Management provides power management. If a PC Card icon and a Power icon are displayed in the taskbar, these utilities are already installed. If these icons are not present, see “To install Card Executive for Windows NT 4.0” on page 57 and “To install APM for Windows NT 4.0” on page 43. You should install Card Executive *before* you install networking support.

For Windows NT, the NT administrator password is initially blank. For system security, you should change the NT administrator password in the Windows NT User Manager.

For Windows NT, the keyboard locale is initially set to match the Windows NT language. For example, French Windows NT uses a French keyboard. If your OmniBook has a different keyboard, such as French-Canadian, you should use Keyboard Control Panel to change the locale and layout under Input Locales.

Year 2000

Hewlett-Packard makes no representation or warranty about the Year 2000 readiness of non-HP products including pre-installed operating systems or application software. Customer should contact the software manufacturer directly to determine if any additional actions by Customer are necessary to ensure compliance.

ATTENTION: MICROSOFT HAS INDICATED MANY OF ITS OPERATING SYSTEM SOFTWARE PRODUCTS AND APPLICATIONS REQUIRE CUSTOMER INSTALLATION OF SOFTWARE PATCHES FOR YEAR 2000 COMPLIANCE AND MAY REQUIRE ADDITIONAL PATCHES IN THE FUTURE. THE NEED FOR SUCH PATCHES MOST LIKELY APPLIES TO THE OPERATING SYSTEM SOFTWARE AND ANY MICROSOFT APPLICATIONS SHIPPED WITH THIS PRODUCT. CUSTOMER IS URGED TO CONTACT MICROSOFT AT <http://www.microsoft.com/y2k>, AT 1-888-MSFTY2K (U.S. AND CANADA ONLY), OR AT THEIR LOCAL MICROSOFT OFFICE.

For suggestions about taking care of your OmniBook, see the chapter titled “Operating the OmniBook” in the online *Reference Guide*.

Operating the OmniBook

Starting and Stopping the OmniBook

You can easily start and stop your OmniBook using the blue power button. However, at certain times, you may want to use other methods for starting and stopping your OmniBook—depending on power considerations, types of active connections, and start-up time.

To start and stop the OmniBook

When you	The OmniBook enters	To turn on again
Press Fn+S.* –or– allow time-out.	Standby Mode Saves minimal power. Turns off the display only. Restarts quickly. Maintains network connections.	Press any key or move a pointing device to display your current session (“Instant-On”).
Press blue power button –or– click Start, Suspend.** –or– allow time-out.	Suspend Mode Saves significant power. Turns off the display. Saves current session to RAM. Restarts quickly. May restore network connections.***	Press the blue power button to display your current session (“Instant-On”).
Press Fn+F12 –or– allow time-out.	Hibernate Mode Saves maximum power. Saves current session to disk, shuts down. May restore network connections.***	Press the blue power button to restart and restore your previous session.
Click Start, Shut Down (recommended) –or– Press and hold the blue power button until the display shuts down.	Off Mode Saves maximum power. Turns off without saving current session. At startup, resets everything, starts a new session, and restores network connections.	Press the blue power button to restart with a new session.

* Windows NT and Windows 95 only. In Windows 98, press Fn+S to suspend. Not supported in Windows 2000.

** Windows 95 only. In Windows 98 and Windows 2000, click Start, Shutdown, Standby to suspend.

*** A plug-and-play operating system, such as Windows 95, Windows 98, or Windows 2000, can restore network connections when you turn on the OmniBook. For Windows NT 4.0 or a different operating system, you may have to reset the OmniBook or restart the operating system to restore them.

To reset the OmniBook

If Windows or the OmniBook stops responding, you can reset the OmniBook and restart Windows.

1. If possible, shut down Windows.
2. Press and hold the blue power button until the display shuts down.

–or, if this fails–

Insert a pen or straightened paper clip into the recess on the left side of the OmniBook, as shown.

3. After the computer shuts down, press the blue power button to turn it on.



Hint

To boot from a CD-ROM or DVD drive in the module bay, press ESC two times during reboot when you see the HP logo. Then select the CD-ROM/DVD drive as the temporary boot device.

Checking the Status of the OmniBook

To check power status and drive activity

The OmniBook has status lights that report power status and drive activity. When the floppy disk drive is installed in the module bay, the following lights are present on the front of the OmniBook and the module bay.

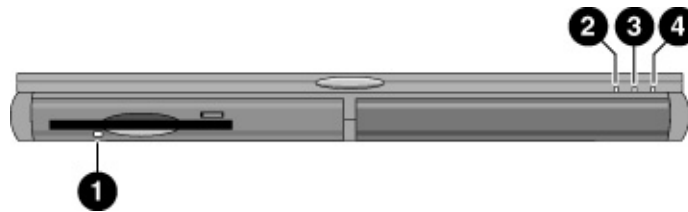

1. Floppy disk drive light.
 - Green light. The OmniBook is accessing the floppy disk drive.
2. Power status light.
 - Green light. OmniBook is on.
 - Amber light. OmniBook is in Standby or Suspend mode.
 - No light. OmniBook is in Off or Hibernate mode.
 - Green and amber light. OmniBook failed when resuming. Reset the OmniBook.
3. Drive activity light.
 - Green light. OmniBook is accessing the hard disk drive or a drive in the module bay.
4. Charging status light.
 - Green light. The ac adapter is connected and battery is full or has stopped charging.
 - Blinking green light. The ac adapter is connected and battery is charging.
 - No light. The ac adapter is not connected or the battery is not installed.

Using the OmniBook Pointing Devices

Two pointing devices (pointing stick and touch pad) are built into your OmniBook.

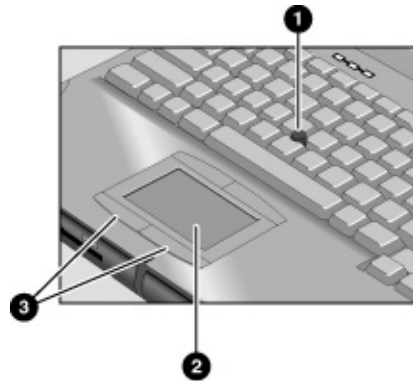

1. Pointing stick (pressure-sensitive pointing device).
2. Touch pad (touch-sensitive pointing device).
3. Click buttons (two above and two below the touch pad).

Both pointing devices use these click buttons, which work like the left and right buttons on a standard mouse. What the buttons do depends on the software being used.

To use the built-in pointing devices

1. Place your hands in the typing position.
2. **Pointing stick.** With your index finger, press the pointing stick in the direction you want the pointer to move. Pressing away from you moves the pointer up the screen; pressing toward you moves the pointer down the screen.
Touch pad. Move a thumb or finger across the touch pad in the direction you want the pointer to move.
3. Use the left and right click buttons, which function like the left and right buttons on a mouse, to make your selection.
 - To open an application, move the pointer over the icon, then press the left button twice rapidly.
 - To make menu selections, move the pointer to the item and press the left button once.
 - To open the shortcut menu for an item, move the pointer over the item and click the right button.
 - To drag an item, move the pointer over the item. Press *and hold* the left button while you move the pointer to the new location. Release the button.

The default pointing device driver (PS/2 TrackPoint) supports the enhanced features of the pointing stick and the *basic* features of the touch pad.

You can customize the OmniBook to support enhanced touch pad features (see the next topic). If you do this, keep in mind that you are selecting enhanced features for the touch pad only. *You cannot activate enhanced features for both simultaneously.*

To customize the operation of the touch pad or pointing stick, see the section “Using the OmniBook Pointing Devices” in the online *Reference Guide*.

Windows 2000

Under Windows 2000, enhanced features for the pointing stick and touch pad are not available at this time. Check the Customer Care website (<http://www.hp.com/cposupport/eschome.html>) for PS/2 TrackPoint and touch pad device drivers for Windows 2000. The default pointing device driver is the standard PS/2 Compatible Mouse driver. To disable either pointing device, see “To run the BIOS Setup utility” on page 62.

Using the OmniBook Display

The OmniBook display normally turns off when you close the display lid. To make the OmniBook suspend instead, see the section “Using the OmniBook Display” in the online *Reference Guide*.

To adjust the display brightness

The OmniBook uses special key combinations, called hot keys, to control brightness.

- Press Fn+F1 to decrease the brightness.
- Press Fn+F2 to increase the brightness.

Hint

To maximize your battery operating time, set the brightness to the lowest comfortable setting, so that the internal light uses less power.

To extend the life of the display

Observe the following guidelines to maximize the life of the backlight in the OmniBook display.

- Set the brightness to the lowest comfortable setting (Fn+F1). If you are using an external keyboard, Fn = left CTRL + left ALT.
- When working at your desk, connect an external monitor and turn off the internal display (Fn+F5).
- Avoid using a screen saver or other software that prevents the OmniBook from changing to Suspend or Standby mode after a time-out period. If you use a screen saver in Windows 95, 98, or 2000, enable the option to shut off the display after a time delay.
- Do not disable Suspend or Standby time-outs.
- If you are using ac power and have no external monitor attached, change to suspend or standby when not in use.

Adjusting the Audio System

The OmniBook supports Sound Blaster Pro-compatible sound and the Microsoft Windows Sound System.

To adjust the volume

On the Keyboard

- To increase the volume, press Fn+UP-ARROW.
- To decrease the volume, press Fn+DOWN-ARROW.
- To temporarily silence the speaker without changing the volume setting, press the mute button on the right side of the OmniBook.

In Windows

- Click the speaker symbol in the taskbar.
- Drag the volume control bar up or down to adjust the volume.
- To temporarily silence the speaker without changing the volume setting, click Mute.

Using the OmniBook Keyboard

WARNING

Improper use of keyboards and other input devices has been associated with ergonomic injury. For information about reducing your risk, see *Working in Comfort* in the online OmniBook Library, or visit our ergonomics website, <http://www.hp.com/ergo>.

If you are using your portable computer as your primary computer, or using it for extended periods, you should use it with a full-size keyboard, monitor, and mouse. This can reduce the risk of ergonomic injury. See *Working in Comfort* in the online OmniBook Library.

To use the Fn hot keys



The combination of the Fn key plus another key creates a *hot key*—a shortcut key sequence—for various system controls. The OmniBook keyboard shows the Fn *hot keys* labeled in gray. If you are using an external keyboard, the Fn key = left CTRL + left ALT.

These keys	Do this
Fn + F1	Decreases the display's brightness.
Fn + F2	Increases the display's brightness.
Fn + F5	Switches among the built-in display, an external display, and simultaneous displays.
Fn + F8	Toggles the built-in keypad on and off. Does not affect an external keyboard. If Num Lock is on, then the numeric functions are active; otherwise, cursor control is active.
Fn + F12	Enters Hibernate mode.
Fn + S	Enters Standby mode in Windows 95 and Windows NT. Enters Suspend mode in Windows 98. Not supported in Windows 2000.
Fn + R	Enters Suspend mode. Not supported in Windows 2000.
Fn + ScrLk	Toggles Scroll Lock on and off.
Fn + UP ARROW	Increases the volume.
Fn + DOWN ARROW	Decrease the volume.

To use the embedded keypad

When the embedded keypad on the OmniBook's built-in keyboard is active, two options are possible.

Num Lock on Keys change to the numeric or arithmetic designations printed in light gray on the keyboard.

Num Lock off Keys change to cursor control keys.

1. Press NmLk to turn Num Lock on or off.
2. Press Fn+F8 to turn on the embedded keypad.

–or–

To temporarily turn on the embedded keypad, hold Fn while typing a key.

Working in Comfort

WARNING

Improper use of keyboards and other input devices has been associated with ergonomic injury. For more information about reducing your risk, visit our ergonomics website at www.hp.com/ergo.

Thank you for selecting HP computing equipment. To optimize your comfort and productivity, it is important that you set up your work area correctly and use your HP equipment properly. With that in mind, we have developed some set-up and use recommendations for you to follow based on established ergonomic principles.

Improper and prolonged use of keyboards and input devices are among those tasks that have been associated with repetitive strain injury (RSI) to soft tissues in the hands and arms. If you experience discomfort or pain while using any computing equipment, discontinue use immediately and consult your physician as soon as possible.

In addition to the information on RSI given in this chapter, you may also consult the online version of Working in Comfort preloaded on the hard disk of the your HP OmniBook, or visit HP's Working in Comfort website.

About Repetitive Strain Injury

Because your comfort and safety are our primary concern, we strongly recommend that you use HP computing equipment in accordance with established ergonomic principles and recommendations.

Scientific literature suggests that there may be a relationship between injury to soft tissues—especially in the hands and arms—and prolonged, improper use of keyboards or other equipment requiring repeated motions of the hands and forearms.

This literature also suggests that there are many other risk factors that may increase the chance of such injury, commonly called Repetitive Strain Injury.

What is RSI?

Repetitive Strain Injury (RSI—also known as cumulative trauma disorder or repetitive motion injury) is a type of injury where soft tissues in the body, such as muscles, nerves, or tendons, become irritated or inflamed.

Operating the OmniBook **Working in Comfort**

RSI has been a reported problem for those who perform repetitive tasks such as assembly line work, meatpacking, sewing, playing musical instruments, and computer work.

RSI also has been observed in those who frequently engage in activities such as carpentry, knitting, housework, gardening, tennis, windsurfing and lifting children.

What causes RSI?

The specific causes of RSI have not been established. Nevertheless, the incidence of RSI has been associated with a variety of risk factors, including:

- Too many uninterrupted repetitions of an activity or motion.
- Performing an activity in an awkward or unnatural posture.
- Maintaining static posture for prolonged periods.
- Failing to take frequent short breaks.
- Other environmental and psychosocial factors.

In addition, there have been reports associating the occurrence of RSI with the use of computer keyboards, mice, and other input devices. Also, certain medical conditions, such as rheumatoid arthritis, obesity and diabetes, may predispose some people to this type of injury.

What can I do to avoid RSI?

Some people who use computers may experience physical discomfort during their use. This discomfort may be a symptom of a repetitive strain injury.

Properly setting up and using computing equipment can help to minimize your chances of experiencing this discomfort. Well-designed and properly adjusted equipment alone may not be sufficient to eliminate all potential problems.

Maintaining good posture and positioning when working on computers also has a significant bearing on your comfort.

What if I experience discomfort?

If you are experiencing any discomfort, seek professional medical advice immediately. Typically, the earlier a problem is diagnosed and treated, the easier it is to resolve.

Preparing Your Work Environment

When using HP computing equipment, it is important that your work environment contribute to your comfort and productivity.

Your Chair

It's very important that your chair provides a comfortable sitting position and offers the following features:



- **A stable base, such as five legs with casters.** Make sure the casters are designed for the type of floor you have in your workspace, whether it is bare or carpeted.
- **A height- and tilt-adjustment feature.** It should be easy to adjust your chair height from 40 cm to 52 cm (15.5 inches to 20.5 inches) as measured from the top of the seat pan to the floor. If you are much taller or shorter than average, you may need a chair that can be adjusted beyond this range. Adjust your chair so that the work surface or keyboard tray is at elbow height and your feet are flat on the floor with your knees slightly bent below your hips. Ideally, the seat pan should be able to tilt both forward (minimum of 5 degrees) and backward (minimum of 10 degrees). If the chair has an adjustable seat pan, inclining the seat slightly forward will transfer some of the pressure from the spine to the thighs and feet. This will relieve pressure on your back.

Operating the OmniBook Working in Comfort

- **A curved seat edge.** The front of the seat should be curved and finished in a “waterfall” edge.
- **An adjustable back support** in both height and forward and backward tilt. It is important that the backrest correctly supports the lower part, or lumbar curve, of the back.
- **A freely rotating swivel** so you can move easily from side-to-side.
- **Fully adjustable and padded armrests.** The chair arms should not interfere with adjusting the chair or moving it close to your work surface.

Your Work Surface

Ideally, you should be able to adjust the height of your work surface.

A simple way to ensure your work surface is at the correct height is to first adjust the height of the seat-pan of your chair. With your chair properly adjusted and your feet firmly on the floor, adjust the work surface height until your forearms are parallel to the floor when you have your fingers on the keyboard or other input device.

Your Work Posture

Sitting in one position for long periods can be uncomfortable. To minimize the potential for physical discomfort or injury, it’s important that you maintain proper posture.



- **Back:** While sitting at your work surface, make sure your back is supported by the chair’s backrest in an erect position or angled slightly backwards.
- **Arms:** Your arms should be relaxed and loose, elbows close to your sides, with forearms and hands approximately parallel to the floor.

- **Wrists:** Your wrists should be as straight as possible while using the keyboard, mouse or trackball. They should not be bent sideways, or more than 10 degrees up or down.
- **Legs:** Your thighs should be horizontal or angled slightly downward. Your lower legs should be near a right angle to your thighs. Your feet should rest flat on the floor. If necessary, use a footrest, but double check that you have your seat height adjusted correctly before getting a footrest.
- **Head:** Your head should be upright or tilted slightly forward. Avoid working with your head or trunk twisted.
- **Overall:** Change your position frequently and take regular breaks to avoid fatigue.

Setting Up Your HP Computing Equipment

Make sure that all the elements of your HP computer system—monitor, document holder, keyboard, mice and other input devices, and headphones and speakers—are optimally arranged and adjusted to meet your personal requirements. The recommendations that follow will help you achieve this.

Your HP Monitor

It is important that your monitor screen be clean and positioned correctly to improve readability and help you work comfortably. Glare, high contrast, reflections, dirt and dust will interfere with what you see on the screen. The recommendations that follow can help you achieve a comfortable arrangement.

Operating the OmniBook Working in Comfort

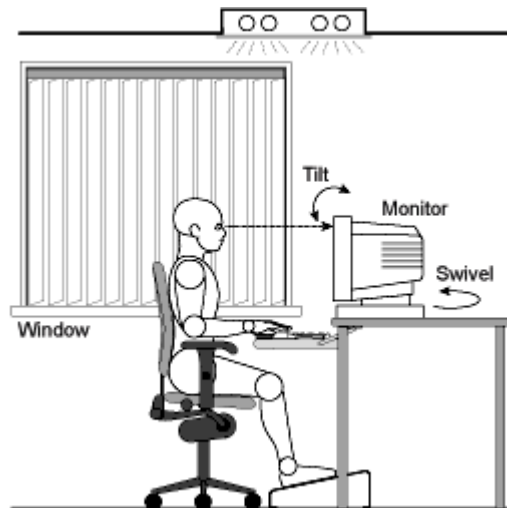

- The top of your monitor screen should be at or slightly below eye level. Most HP monitors come with a tilt-and-swivel feature that makes it easy to adjust the screen position.
- To avoid obscuring your view, the screen should be positioned perpendicular to your line of sight; that is, straight on.
- To avoid glare or reflection, try to position the monitor so the screen is at a right angle to your window rather than in front of it. If reflection or glare persists, tilting the screen forward may help.
- Maintain a comfortable viewing distance to the screen. Most people prefer a viewing distance of approximately 46 to 76 cm (18 to 30 inches), depending on monitor size. Character size and the amount of space available on the work surface can affect this distance.
- Text should be easy to read. To help ease eyestrain, adjust text attributes such as character size, spacing, and color. In addition, you will need to use the controls provided with your monitor to adjust the visual settings so that contrast and brightness levels are comfortable for you. High contrast and low brightness is usually the preferable combination.
- The monitor should be free from flicker. If the image on your screen is not stable, the monitor may require repair or adjustment.
- When possible, use a program that has a simple user interface, such as easily identifiable icons and pull-down menus. Also, screen information should be displayed in a structured and well-organized way.

Monitor Use Specifications

- When viewing your monitor, your head should not be tilted more than 15 degrees forward.
- You should not have to look up more than 5 degrees above horizontal or down more than 30 degrees below horizontal for normal work tasks, such as typing or reading.

Document Holders

When keying in data from a hard-copy document, placing it in a document holder rather than on a flat surface will make it easier to read. The following recommendations should be observed when using a document holder:

- The document holder should be at approximately the same height and distance from your eyes as the screen, and as close to the monitor as possible to prevent neck twisting. Some users prefer a document holder mounted to the monitor while others prefer the document holder positioned between the screen and keyboard.
- If the primary task is to view documents rather than using the monitor, the document holder may be placed directly in front of the keyboard with the monitor slightly to the side.
- To help reduce stress on your neck and prevent eye fatigue, try to minimize the movement of your head and eyes while using a document holder.

Your HP Keyboard

The proper positioning and use of your HP keyboard is important when using HP computing equipment. Be sure to observe the following recommendations to optimize your comfort and safety:

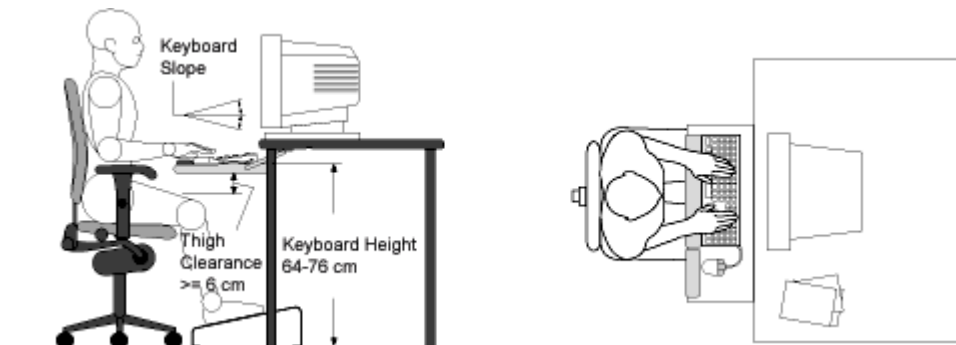

Operating the OmniBook

Working in Comfort

- We recommend you place your keyboard in front of the screen or document holder, whichever is viewed the most. Your HP keyboard has long cables so you can place it in the position that is most comfortable for you while you are using your system.
- Because HP keyboards vary in depth, you'll want to be sure that your work surface or keyboard tray has sufficient room to accommodate your model. The keyboard tray should be wide enough to hold both the keyboard and mouse or trackball: 66 to 71 cm (26 to 28 inches).
- Your HP keyboard may have a kickstand that can be opened or closed to raise or lower the keyboard angle. If you are in the correct sitting position with your elbows at about the same level as the work surface, you may not need to use it. However, if your elbows are below the work surface, you may wish to use the kickstand to raise the back of the keyboard.
- An adjustable keyboard tray may be useful if you cannot adjust your chair or work surface to the proper height for typing. It should adjust in height from 64 to 76 cm (25 to 30 inches) above the floor and tilt forward and backward to help you find the most comfortable position. Note that research has shown that there may be less muscle tension in shoulders and forearms with the keyboard tilted away from you.
- When using your HP keyboard, remember it takes very little pressure or force from your fingers to activate the keys. Improper typing style—the use of too much force—can place unnecessary stress on the tendons and muscles in your hands, wrists, and forearms.
- Make sure that your hands are in a neutral position when you use your keyboard. This means that your forearms, wrists, and hands should be in a straight line.
- The keyboard has a low profile to help prevent excessive bending of your wrists while typing. Literature suggests that you should not bend your wrists sideways or more than 10 degrees up or down. Keep your wrists straight by moving your entire hand and forearm over to use the function keys or numeric keypad.
- You may use a palm rest to help keep your hands and wrists in a comfortable and neutral position when you are not typing. Some HP keyboards come with an integrated palm rest. If you use a palm rest, see that it is rounded and padded, and flush in height with the front edge of the keyboard. Note that your palms—not your wrists—should rest on the palm rest. If you don't have a palm rest, try not to rest your wrists on a sharp edge, such as a work surface edge.

Mice and Other Input Devices

Various aspects of using mice and other input devices may increase your risk of discomfort or injury. If you connect an external mouse to your OmniBook, observing the following recommendations may reduce that risk.

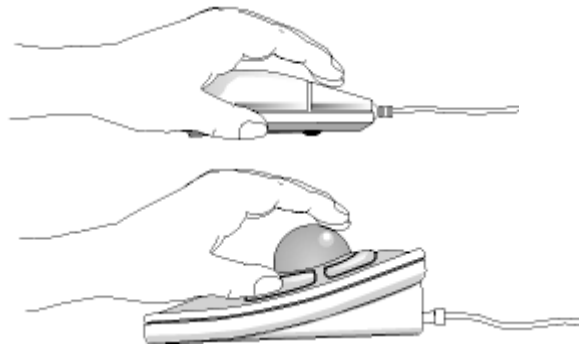

- As with the keyboard, try to keep your hand, wrist, and forearm in a neutral position while using your mouse or other input device.
- When using a stylus or light pen with a graphics tablet, don't grip the stylus tightly. Keep your hand and fingers relaxed and try to maintain a neutral posture in your hand, wrist and forearm.
- If you use your thumb to rotate the ball on a trackball or spaceball, keep it in a relaxed, natural shape, and maintain a neutral posture in your hand, wrist, and forearm.
- Hold the mouse gently by draping your fingers over it. Keep your hand relaxed and fingers loose. Do not grip the mouse tightly.
- It takes very little pressure or force from your fingers to activate the buttons or scroll wheel on your mouse, scrolling mouse, trackball, or other input device. Using too much force can place unnecessary stress on the tendons and muscles in your hands, wrists, and forearms.
- If you are using a scrolling mouse, be sure to keep your fingers and hand in a relaxed, neutral position when activating the scroll wheel. Also, this type of mouse features software that can minimize the number of mouse movements or button clicks.
- When using a mouse, trackball, stylus and graphics tablet, or other input device, position it as close to the keyboard as possible, and keep it at the same level so you do not have to stretch while using it.
- Use a good quality mouse pad to enable the mouse to work most effectively and reduce unnecessary hand and wrist movements.
- Be sure to keep your mouse and trackball clean. Regular removal of accumulated dust and dirt helps ensure proper tracking and reduces unnecessary hand and wrist motions.

Operating the OmniBook Working in Comfort

Headphones and Speakers

Listening to loud sounds for prolonged periods may permanently damage your hearing. To avoid discomfort from unexpected noise, always turn down the volume before connecting headphones or speakers to your HP equipment.

When you put on the headphones, slowly increase the volume until you find a comfortable listening level, then leave the volume control in that position.

Comfort and Safety Checklist

These recommendations are drawn from the latest available international ergonomic standards and recommendations, including ISO 9241 and ANSI/HFS 100-1988.

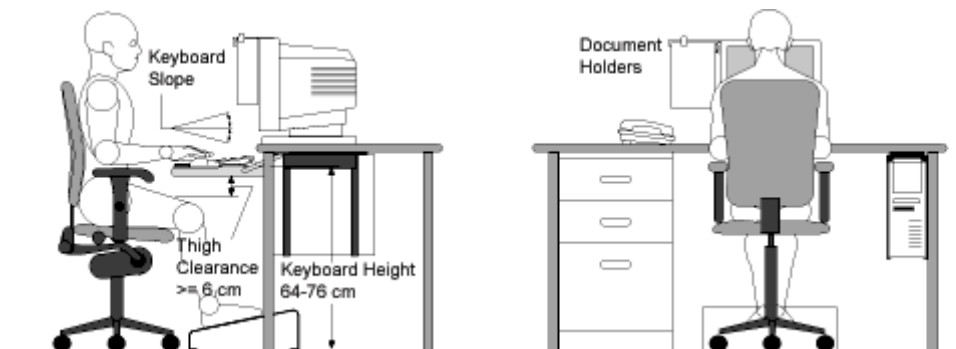

General

- **Work Surface Height:** Adjust either your seat height, work surface, or both, to position the work surface at approximately elbow height.
- **Work Surface Arrangement:** Make sure frequently used equipment is within easy reach. For example, if you are primarily using the keyboard, place it directly in front of you, not to the side. If you are primarily using the mouse, place it in front of your hand or arm. If you are using both a mouse and keyboard, place them both at the same work surface height and close together. If a palm rest is used, the height should be flush with the front edge of the keyboard. Other items, such as your telephone or notepad, also should be considered.
- **Monitor:** Place your monitor so that the top of the screen is at, or slightly below, eye level (up to 15 degrees).

- **Head:** Do not tilt your head forward by more than 15 degrees, and try not to turn your head toward the side.
- **Back:** While sitting at your work surface, make sure your back is supported by the chair's backrest in an erect position or angled slightly backwards.
- **Arms:** Make sure your arms and elbows are relaxed and loose, with your upper arm perpendicular to the floor or slightly forward. Keep your forearms and hands approximately parallel with the floor with elbows bent between 70 and 115 degrees. Keep your elbows close to your sides (less than 20 degrees away from your body).
- **Legs:** Your thighs should be horizontal or angled slightly downward. Your lower legs should be near a right angle to your thighs. Make sure there is sufficient room under the work surface for your legs.
- **Feet:** If after adjusting your chair you cannot rest your feet comfortably on the floor, use a footrest, preferably one that can be adjusted in height and angle.

Overall

- Look away from the screen from time-to-time to help reduce eyestrain. Focus on distant objects briefly, and blink periodically to lubricate your eyes. You also should have your eyes checked on a regular basis and ensure your eyeglass prescription is suitable for working on a monitor screen.
- Remember to occasionally shift position and move your body. Keeping your body in one position for long periods is unnatural and stressful. When prolonged work is required, take frequent short breaks. As a rule of thumb, a five- or ten-minute break every hour is a good idea. Short, frequent breaks are more beneficial than longer less frequent breaks. Data show that people who work for long periods of time without a break may be more prone to injury.
- Changing tasks frequently will help prevent muscle stiffness. Examples: alternating between keyboarding, reading, writing, filing, and moving around in your work environment, helps you maintain a relaxed posture. Occasionally stretch the muscles in your hands, arms, shoulders, neck, and back. You should stretch at least as often as you take brief task breaks—at least once every hour.
- Discomfort may be alleviated by using alternative ergonomic designs and accessories such as ergonomically personalized chairs, palm rests, keyboard trays, alternative input devices, prescription eyeglasses, anti-glare screens, and more. Seek additional information from the sources available to you, including your employer, doctor, local office supply store, and the information sources listed in the online version of Working in Comfort, which is preloaded on the hard disk of your HP computing equipment.

Your HP OmniBook Computer

You can use your HP OmniBook computer virtually anywhere, anytime. The following recommendations should help you work more comfortably.

Note that if you are using your portable computer as your primary computer, or using it for extended periods, you should use it with a full-size keyboard, monitor and mouse. This will give your portable computer the adjustability and comfort features of a desktop unit. HP port replicators offer quick, easy connections to these devices. More information on how to prepare your workspace environment and set up your HP equipment is available in other sections of Working in Comfort, which is preloaded on the hard disk of your HP computing equipment.

Preparing Your Mobile Work Environment

- Use a chair that provides good support for your lower back. If an adjustable chair is not available, you can use a pillow or rolled-up towel to provide lower back support.
- Try to keep your thighs parallel to the floor and your feet flat on the floor. In a mobile environment, you can do this by using a phone book or briefcase to support your feet.
- Adjust the height of either your work surface or chair to keep your arms in a neutral position. Your arms should be relaxed and loose, elbows at your sides, with the forearms and hands parallel with the floor.
- Position your notebook computer display to minimize glare and reflection. For example, on an airplane, lower the window shade, or in a hotel room, draw the curtains. You also should maintain a comfortable viewing distance, approximately 40 to 60 cm (16 to 24 inches). Adjust the angle of your display to help keep your head angled slightly downward in a comfortable position.

Using Your Mobile Computer

- Position the computer so your wrists and hands are in a neutral position. Your wrists should be as straight as possible and should not have to bend sideways or more than 10 degrees up or down. If your notebook computer does not have a built-in palm rest, you can use a rolled-up towel.
- Try to type as lightly as possible. The notebook keyboard requires little force to activate.

- Take frequent, short rest breaks. This is especially important in a mobile computing environment.
- Portable computers weigh between approximately 1.4 and 3.7 kilos (3 and 8 pounds). When traveling, be sure to carry your computer properly to minimize strain on your body. Shift the bag containing your notebook equipment frequently between your left and right hands and shoulders.

Managing Battery Power

How Power is Managed

The OmniBook conserves power by using software that controls battery charging and power drain.

If you're using Windows 95 or Windows 98, Advanced Power Management (APM) is preinstalled on the OmniBook.

If you're using Windows NT 4.0, look for a Power icon in the taskbar. If the icon is present, APM is installed. If not, see "To install APM for Windows NT 4.0" on page 43.

If you're using Windows 2000, power management is built into Windows.

The OmniBook provides several safeguards so you won't be surprised by a dead-battery condition, including the following:

- The status lights on the battery show the remaining battery charge.
- Built-in warnings are displayed for low-battery conditions.
- The OmniBook automatically turns off when the battery charge gets too low—your session continues when you start recharging the battery or insert a fresh battery.

Data on any of the drives is not affected by a low battery—unless the battery runs down completely while writing data to the drive, or if the battery in a PC RAM card is also low.

Monitoring Battery Power

The primary source of power for the OmniBook is its rechargeable battery pack. You can use the ac adapter to recharge the battery—or to run on ac power to preserve the battery.

Important

Running external connections is a power-intensive operation that significantly shortens the length of a battery session. Whenever possible, connect the ac adapter when using external connections.

In addition to the replaceable battery, there is a permanent, internal backup battery, which recharges whenever the OmniBook is on or connected to ac. It maintains certain internal settings, such as the clock.

For suggestions about conserving battery power and storing batteries, see the chapter titled “Managing Battery Power” in the online *Reference Guide*.

To install APM for Windows NT 4.0

If a Power icon (battery or power plug) is present in the taskbar, APM is installed. If the icon is not present, you can install APM using the steps below.

The Advanced Power Management (APM) driver for Windows NT 4.0 is located on the OmniBook’s hard disk drive. You set up APM from the Windows Start menu. (The APM driver is also located on the *Recovery CD* in \OmniBook\Drivers\NT4 or Apm.)

Phoenix APM adds the following capabilities to the OmniBook:

- Improved battery life under Windows NT 4.0.
- PC Card power management.
- Convenient user control and monitoring of power settings and status.

1. To install APM, click Start, Programs, OmniBook, Phoenix Advanced Power Management, Setup.
2. Follow the setup instructions on the screen.

You can download the Phoenix APM documentation from the following website:
<http://www.phoenix.com>.

To check the battery status

From the Windows Taskbar

- Move the pointer onto the power icon at the right end of the taskbar. If you are using Windows NT 4.0, you'll need to install Advanced Power Management to display the power icon (see "To install APM for Windows NT 4.0" on page 43). The approximate battery charge is displayed as a percentage or in hours.
- Double-click the power icon on the taskbar to open the Battery Meter window.

From Windows Control Panel

- Click My Computer, Control Panel, Power. This provides access to all options associated with reporting of power information by Windows.

On the Battery

1. Remove the battery from the OmniBook (see "To replace the battery" on page 46).
2. Press the pad on the back of the battery.

The number of lights that turn on indicates the charge—each light represents 20% of a full charge.

To respond to a low-battery warning

When battery power is critically low, you are alerted by one or more of the following:

- The computer emits a warning beep. This reminds you to save your work.
- If the OmniBook has been off, you will not be able to turn it on.

The OmniBook automatically hibernates to preserve your current session. However, unsaved data could be affected if the battery runs down completely while writing data to the drive. You won't be able to restart until you restore power by one of the following actions:

- Plug in the ac adapter.
–or–
Replace the main battery with one that is charged.
–or–
Install a charged second battery in the plug-in module bay.

To recharge a battery

CAUTION

The ac adapter is normally warm to the touch whenever it's plugged into an ac outlet. The OmniBook is normally warm while it's charging. Don't charge it in a briefcase or other confined space as this may cause the battery to overheat.

1. Connect the power cord to the ac adapter, then plug the cord into an ac outlet. The indicator light on the ac adapter shines when the adapter is on. If the ac adapter does not light, make sure that cord is not damaged.
2. Connect the ac adapter to the OmniBook's right side, as shown.

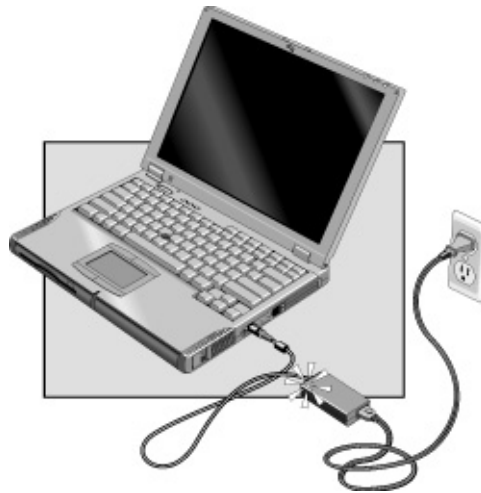

Charging time

Charging the battery takes about 2 hours to fully charge.

Battery life

When the computer is in use, typical battery life can last up to 3-4 hours or more, depending on your level of use, your power management settings, and your computer model.

Optimum Charging

To get the longest battery operating time, wait to recharge until the battery is below 50% charged, then continue charging until the battery is fully charged. The battery charging light stops blinking only when the battery is actually full. You can continue working while the battery is charging.

Managing Battery Power

Monitoring Battery Power

To replace the battery

CAUTION

If you have any unsaved data, it (and your current work session) will be lost when you remove the battery unless the computer is connected to ac power. Also, you should wait at least 3 seconds after inserting the battery before you unplug the ac adapter.

1. **Important.** Save your work.
2. Plug in the ac adapter.

–or–

From the Start menu, shut down the OmniBook.

3. Slide the battery bay release latch forward as far as it will go.
4. Gently pull the release latch back until the battery pops out.

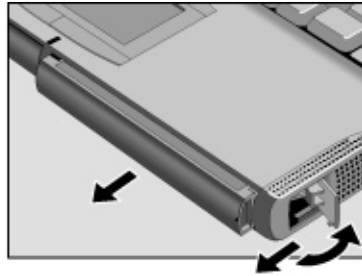

5. Grasp the underside of the battery firmly and pull out.

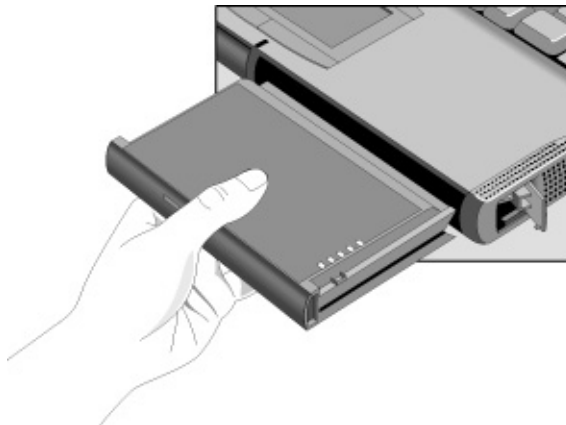

6. With the latch in the open position, slide the charged battery into the OmniBook until it is flush with the unit.
7. Close the battery bay release latch.

WARNING

Do not mutilate, puncture, or dispose of batteries in fire. A battery can burst or explode, releasing hazardous chemicals. A rechargeable battery must be recycled or disposed of properly. For more information about battery safety, see “Battery Safety” on page 100.

To install a second battery

The OmniBook’s plug-in module bay accepts a second battery. See “Using Plug-In Modules” on page 50 for information about installing plug-in modules.

Expanding the OmniBook

Using Plug-In Modules

You can use any compatible plug-in module with the OmniBook module bay, such as those listed below.

- DVD drive module.
- LS-120 SuperDisk drive module.
- Floppy drive module.

You can also attach the floppy disk drive to the parallel port with the optional floppy drive cable. You can then use the module bay for a different plug-in module.

- 24X CD-ROM drive module.
- Second battery.

CAUTION

Do not remove a plug-in module without first notifying Windows. If you do not take proper action, you could lose data.

To install hot-swap support

For Windows 95 or Windows 98, if a plug-in module icon is present in the taskbar, Agaté Tioman “hot-swap” software is installed. If the icon is not present, you can install it using the steps below.

The Agaté Tioman hot-swap software lets you disconnect most modules in the plug-in bay without shutting down the computer and rebooting. (This software does not support Windows NT.)

- Click Start, Programs, Agaté Tioman for HP, Setup, then follow the onscreen instructions.

To replace a plug-in module

For Windows 95 or Windows 98, if Agaté Tioman hot-swap software is installed, a plug-in module icon appears at the right end of the taskbar. This software lets you disconnect most plug-in modules without shutting down the computer. For a hard drive module, you must shut down the computer.

Windows 2000 displays the Unplug or Eject Hardware icon at the right end of the taskbar when a drive module is present.

CAUTION

If you are connecting or disconnecting a CD-ROM drive, DVD drive, or any other type of drive, you must use the icon in the taskbar or shut down the computer—otherwise, you could lose data.

Do not touch the metallic pins in OmniBook connectors, module connectors, or cable connectors. Static electricity can damage internal components.

1. Close all files that are open from the plug-in module.
2. For Windows 95 or 98, if the plug-in module icon is present in the taskbar, right-click the icon, then click Remove Device. When prompted to remove the module, click OK. (You do not have to do this if the bay is empty or contains a battery.)
–or–
For Windows 2000, left-click the Unplug or Eject Hardware icon on the taskbar, and select the module you want to remove. When prompted to remove the module, click OK. (You do not have to do this if the bay is empty or contains a battery.)
–or–
For any version of Windows, including Windows NT, click Start, Shut Down to shut down the computer. (You must do this if you are removing or inserting a hard disk drive in the module bay.)

Note

If you're removing or inserting a battery, you do not have to do step 2.

Expanding the OmniBook Using Plug-In Modules

3. Slide the module release latch forward as far as it will go.
4. Gently move the release latch back until the module pops out.

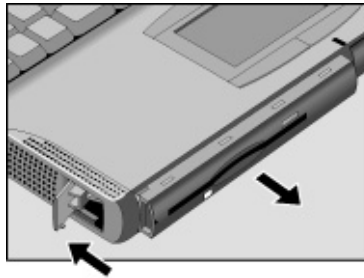

5. Grasp the underside of the module firmly, and pull out.

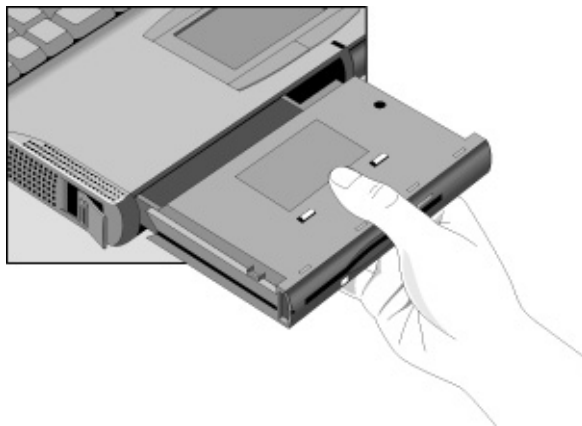

6. With the latch in the open position, slide the new plug-in module into the OmniBook until flush with the unit.
7. Close the module release latch.

If you have a CD-ROM drive or other module in the module bay, you can connect the floppy disk drive to the parallel port. See the section “Using Plug-In Modules” in the online *Reference Guide*.

Connecting External Devices

You can expand the OmniBook's capabilities by connecting other devices.

Note

Before you connect any device, check the documentation that came with the equipment to see if you need to make any settings or adjustments to the equipment before using it. This might include setting switches to configure the equipment so that it will operate properly with the OmniBook and the software you plan to use.

To identify connectors for external devices

The following picture describes the available connectors for external devices. Refer to it, if necessary, when following the procedures in this section.

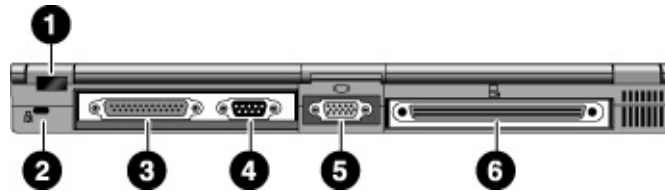

1. Infrared port. Use this port for wireless data transmission between the OmniBook and another computer or a printer with an infrared port. In Windows 95, you must install infrared drivers.
2. Kensington lock slot (security connector).
3. Parallel port (LPT1). Use this port for a parallel printer, other parallel device, or to connect the floppy disk drive externally.
4. Serial port (COM1). Use this port for a serial mouse, a modem, a serial printer, or other serial device.
5. External monitor port.
6. Docking port (for the port replicator or docking system).

Expanding the OmniBook **Connecting External Devices**

These additional connectors are available on the left side of the computer:

- Universal Serial Bus (USB) port.
- PS/2 port. Use this to connect a keyboard or an external PS/2 mouse.

For information about connecting to serial devices, USB devices, audio devices, and infrared devices, see the section “Connecting External Devices” in the online *Reference Guide*.

To connect an external monitor

You can connect a VGA, SVGA, XGA, or SXGA monitor to your OmniBook—or UXGA for a computer with “4150 B” after the serial number. The OmniBook’s internal display supports standard XGA mode (1024 by 768 pixels).

1. Press the blue power button for one second to suspend the OmniBook.
2. Connect the monitor cable to the monitor, then to the monitor port on the back of the OmniBook.
3. Connect the monitor to a power source and turn it on.
4. Press the blue power button to turn on the OmniBook.
5. If the external monitor has a different resolution from the internal display, adjust the display properties (My Computer, Control Panel, Display, Settings).

To enable the built-in and external displays

- For a temporary change, press Fn+F5 to cycle through the display options (Internal, External, Both).
- For a permanent change in which display is active, change the Video Display Device setting in the BIOS Setup utility (see below).
- For a display connected to a video adapter in a docking system, the docking display is automatically selected when it is detected. To change this behavior, change the Primary Video Adapter setting in the BIOS Setup utility (see below).

See “To run the BIOS Setup utility” on page 62.

To connect an external keyboard or PS/2 mouse

The 6-pin PS/2 port allows you to attach an external keyboard or a PS/2-compatible mouse to the OmniBook. While an external PS/2 mouse is connected, the built-in pointing devices are normally disabled.

- Plug the mouse or keyboard PS/2 cable into the PS/2 port on the OmniBook.
- To connect both a mouse and keyboard, use the HP F1469A Y adapter.
- To connect a device that has a PC-type jack, first connect its cable to an adapter cable with a PS/2 jack.

Hint

To use hot keys from an external keyboard, substitute left CTRL + left ALT for the OmniBook Fn key. For example, to access Fn+F2, press left CTRL + left ALT + F2. If this does not work, check that the setting for External Fn Key is enabled in the System Devices menu of the BIOS Setup utility. See “To run the BIOS Setup utility” on page 62.

The built-in pointing device must be disabled for special mouse features to work. In the BIOS Setup utility, check that the PS/2 Pointing Devices option is set to Auto in the System Devices menu.

To connect a printer

The parallel port uses a standard 25-pin connector, most commonly used for connecting a printer. These include dot-matrix, ink-jet, and laser printers. The parallel port supports both EPP and ECP capabilities (if selected in BIOS Setup).

The OmniBook has one parallel port. Its address and properties can be set in the BIOS Setup utility.

- Connect the parallel printer cable or other parallel cable to the parallel port.

Using PC Cards

To insert and remove a PC Card

Note

Windows NT 4.0 does not support zoomed video. If you are using Windows NT 4.0, make sure Card Executive is installed (see “To install Card Executive for Windows NT” on page 57).

The OmniBook PC Card slots are available for storing data and expanding the communication capabilities of the OmniBook. The OmniBook supports standard Type I, II, and III PC Cards (PCMCIA and CardBus). You can use two Type I or II cards or one Type III card. The lower slot supports Zoomed Video, which allows high-quality multimedia presentations.

1. Hold the card with its face up and its connector holes toward the card slot.
2. Slide the PC Card into the slot until it is flush with the OmniBook.
3. Before removing the card, click the PC Card or Eject Hardware icon in the taskbar, then click Stop (for Windows 95, 98, and 2000 only). This protects your data and avoids unexpected problems. You can restart the card by removing it, then reinserting.
4. To remove the card, flip out the hinged eject button next to the PC Card. Push the button to pop out the card, then fold the button closed.

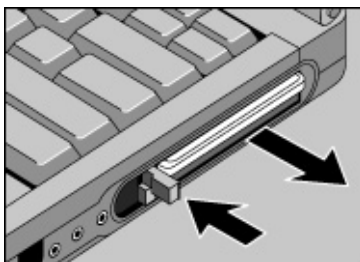

To find tested PC Cards

For the latest information about compatible cards, visit our website at <http://www.hp.com/omnibook> and check the Accessories section. Or contact Hewlett-Packard as described in “Support Assistance” on page 90.

To install Card Executive for Windows NT 4.0

If a PC Card icon is present in the taskbar, Card Executive is installed. If the icon is not present, you can install Card Executive using the steps below.

To take advantage of Card Executive’s plug-and-play for PC network cards, you must install Card Executive before installing Windows NT networking. Card Executive is located on the OmniBook’s hard disk drive.

You set up Card Executive from the Windows Start menu. (The driver is also located on the *Recovery CD* in `OmniBook\Drivers\NT4` or `Pccard`.)

Card Executive adds the following capabilities to your OmniBook:

- Plug and Play for PC Cards using standard Windows NT drivers.
- Plug and Play for supported network PC Cards.
- Automatic configuration of PC Cards using advanced “Wizard” technology to allocate system resources.
- Suspend/Resume functions and simplified administration of PC Cards when integrated with Phoenix Card Executive.

1. Click Start, Programs, OmniBook, Phoenix Card Executive, Setup.
2. Follow the setup instructions on the screen.

You can download the Phoenix Card Executive documentation from the following website: <http://www.phoenix.com>.

Installing a Hard Disk Drive

To replace the hard disk drive

You'll need a small Phillips screwdriver for this procedure.

1. Unplug the ac adapter, if present, and remove the battery.
2. Turn the unit bottom side up and remove the hard drive screw.
3. Pull out the hard drive by its plastic tab.

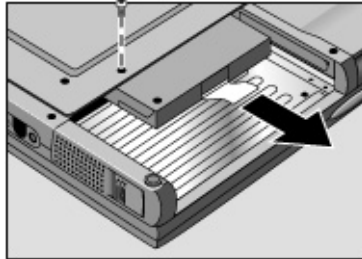

Important

If you are installing a new hard disk drive, you should create a Hibernate partition on the drive before loading any software. See “To recover the factory installation of Windows” on page 87. The online *Reference Guide* shows how to install the holder on a new hard disk drive.

Installing a RAM Expansion Module

The OmniBook has no memory (RAM) built in but has two slots for installing RAM modules. One slot contains a RAM module installed at the factory. You can use both slots to expand your RAM.

To install a RAM expansion module

You'll need a small Phillips screwdriver for these steps.

CAUTION

Your OmniBook's computer chips are extremely static-sensitive. Static electricity can permanently damage computer chips. Handle the RAM module only by its edges. Before installing the memory module, discharge your body's static electricity by touching the metal shielding around the connectors on the rear of the OmniBook.

For a model with "4150 B" after the serial number, you *must* use only PC-100 type RAM modules—other RAM modules will not function.

1. From the Start menu, shut down the OmniBook.
2. **Important.** Unplug the ac adapter, if present, and remove the battery. (Remove a second battery if one is installed.)
3. Turn the unit bottom side up, then remove the two screws from the RAM cover and remove the cover.

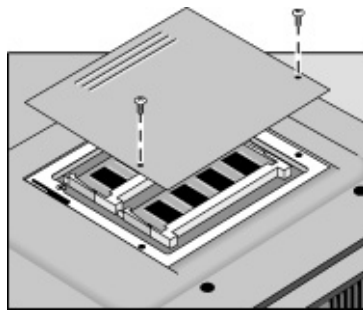

Expanding the OmniBook
Installing a RAM Expansion Module

4. Insert the RAM board into the connector at about a 30° angle until it is fully inserted. Then press down at both sides until both latches snap closed.

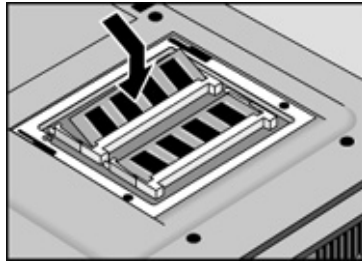

5. Replace the door.
6. Insert the battery.

To remove the RAM board, release the two latches at the sides of the board.

Configuring the OmniBook

Using BIOS Setup

The BIOS (Basic Input and Output System) Setup utility is a menu-driven utility that enables you to make changes to the system configuration and tailor the operation of your OmniBook to your individual work needs.

The settings made in the BIOS Setup utility generally control the hardware and consequently have a fundamental effect on how the OmniBook operates.

For a complete list of BIOS Setup menus, settings, and options, see the online *Reference Guide*.

To run the BIOS Setup utility

1. Close all applications, then shut down Windows and restart the OmniBook.
2. When you see the HP logo, press F2 to enter the BIOS Setup utility.
3. The pointing devices are not active in the BIOS Setup utility. Press the RIGHT and LEFT arrow keys to move among menus. Press the DOWN and UP arrow keys to move among parameters in a menu. Press F5 or F6 to move through values for the current parameter or press ENTER to change a setting. See the tables below for more information.
4. After you select the options you want, press F10 or use the Exit menu to exit the BIOS Setup utility.
5. If the settings cause a conflict between devices during reboot, the system prompts you to run BIOS Setup, and the conflicting settings are marked.

Configuring Security Options

See the chapter titled “Configuring the OmniBook” in the online *Reference Guide* for information about these other security options:

- HP TopTools for system management and protection.
- VirusScan for virus protection.
- Hard disk drive lock for data protection.

To set or change an OmniBook password

The OmniBook provides two levels of password protection—user password protection and administrator password protection. *You cannot set the user password until you set an administrator password.*

If password protection is set, then you will be prompted to enter a password whenever you reset or turn on the computer (depending on your setting). You cannot use the computer until you enter the correct password.

To set, change, or delete password protection for this OmniBook, use the BIOS Setup utility.

1. From the Start menu, shut down, then restart the OmniBook.
2. When you see the HP logo, press F2 to enter the BIOS Setup utility.
3. Select the Security menu.
4. Select Set Administrator Password, then press ENTER.
5. Type the new password, then press ENTER. Password length can be no longer than 8 characters, 0-9, A-Z, and cannot include special or accented characters. Passwords are not case-sensitive.
6. Type the password again to confirm, then press ENTER.

Configuring the OmniBook Configuring Security Options

7. Under Password Required To, choose when the password will be required.

Boot. Requires a password when booting the OmniBook. This option enables the next two options.

Resume. Requires a password when resuming from Suspend.

Undock. Requires a password when undocking the OmniBook.

Windows 2000

Windows 2000 controls resume and undock security, so both the Resume and Undock options are normally ignored. The Undock option is used, though, when the OmniBook is turned off.

8. If desired, repeat this procedure for Set User Password.
9. Press F10 to Save and Exit the BIOS Setup utility.

Note

If you forget a password, call Customer Support at the number listed in “Support Assistance” on page 90 to determine the proper removal procedure.

To delete an OmniBook password

If you delete an administrator password, the OmniBook automatically deletes the user password as well.

1. From the Start menu, shut down, then restart the OmniBook.
2. When you see the HP logo, press F2 to enter the BIOS Setup utility.
3. Select the Security menu.
4. Select Set Administrator Password, then press ENTER.
5. Type the current password, then press ENTER.
6. Press ENTER at the Enter New Password prompt.
7. Press ENTER at the Confirm New Password prompt.
8. Press Continue.
9. Press F10 to Save and Exit the BIOS Setup utility.

To attach a security cable

Your OmniBook has two built-in connectors that allow you to secure the OmniBook with a cable. The Kensington MicroSaver lock system works with these connectors and is available at many computer stores.

1. Wrap the cable around a stationary object, such as a table leg.
2. Loop the cable to create a slip knot around the stationary object—make sure it can't slip off.
3. Insert the lock into one of the OmniBook security connectors and release the key. Store the key in a safe place away from the OmniBook.

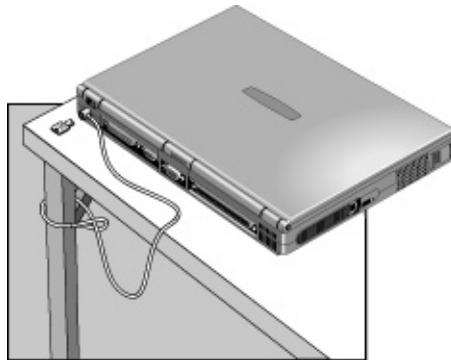

Troubleshooting

Solving Problems

If your OmniBook has a problem, find the symptom below that matches your situation. Try the suggestions one at a time.

Here are some other sources of information:

- Click Start, Help and use the Windows Troubleshooters.
- See the Microsoft Windows manual shipped with the OmniBook.
- For information about system addresses, interrupts, DMA channels, or memory, see the chapter titled “Specifications and Regulatory Information” in the online *Reference Guide*.
- Find technical tips and software updates for the OmniBook at the HP Customer Care website (<http://www.hp.com/cposupport/eschome.html>).
- Test your OmniBook by running the DiagTools test program. See “To run the diagnostic test” on page 84.
- Contact your dealer or Hewlett-Packard—see “Support Assistance” on page 90. Please have your OmniBook with you.

Note

For Windows NT, if you install new services, hardware devices, or applications, you must reinstall the Service Pack from the Recovery CD—see OmniBook Notes in the online OmniBook Library. This ensures that the Service Pack components work properly. It will not write over any applications, settings, or drivers you have installed.

Accessory Problems

If a port on a dock isn't working

- Check that ac power is connected to the dock.
- Try using the corresponding OmniBook port, while undocked.
- Make sure the OmniBook is fully inserted in the dock.
- See the manual for the dock.

If you can't boot from a CD in a CD-ROM drive

- Make sure the CD is a bootable CD, such as the OmniBook *Recovery CD*.

- Make sure you are using a plug-in OmniBook CD-ROM or DVD drive in the module bay. You cannot boot from an external CD-ROM drive, which you can connect to the OmniBook via a PC Card SCSI connection.
- Press ESC twice during bootup to see if the CD-ROM drive is the first boot device.
- Make sure the CD-ROM drive is seated correctly—remove and reinsert.
- If you always want to boot from a CD, check the boot order in BIOS Setup.
 1. From the Start menu, shut down, then restart the OmniBook.
 2. When you see the HP logo, press F2 to enter the BIOS Setup utility.
 3. Open the Boot menu. The default boot order is
Removable Device
Hard Disk
CD-ROM/DVD Drive
 4. If CD-ROM/DVD drive is not option 1, use the arrow keys to select it.
 5. Press F6 to move up (or F5 to move down) in the list.
 6. Press F10 to Save and Exit the BIOS Setup utility.

If a DVD drive locks up the computer in Windows 98

If you're using Windows 98, you may not be able to use a DVD drive with the Agaté Tioman hot-swap software.

- Check the HP Customer Care website (<http://www.hp.com/cposupport/eschome.html>) for updated hot-swap software for Windows 98.
- Try uninstalling the Agaté Tioman software. You'll have to shut down the computer every time you swap modules or the module bay.

Audio Problems

If sound is not audible

- Double-click the speaker icon on the taskbar to ensure that Mute is not checked, or press the Mute button on the right side of the computer to mute or un-mute sound.
- Press Fn+UP-ARROW to increase the volume.

Troubleshooting

Solving Problems

- For a model without “4150” after the serial number, check settings in BIOS Setup.
 1. From the Start menu, shut down, then restart the OmniBook.
 2. When you see the HP logo, press F2 to enter the BIOS Setup utility.
 3. From the System Devices menu, check that Audio is enabled.

If you hear a loud high-pitched whine (feedback) from the speakers

- Try reducing the Master volume (Start, Programs, Accessories, Multimedia or Entertainment, Volume Control).
- Avoid using both the built-in microphone and the built-in speaker at the same time. For example, use an external microphone or external headphones.

If sound doesn't record

- For a model without “4150” after the serial number, check settings in BIOS Setup.
 1. From the Start menu, shut down, then restart the OmniBook.
 2. When you see the HP logo, press F2 to enter the BIOS Setup utility.
 3. From the System Devices menu, check that Audio is enabled.
- Check software controls for recording sound (Start, Programs, Accessories, Multimedia or Entertainment, Sound Recorder).

If sound doesn't play from a CD-ROM drive in a docking system

- Enable the Aux B channel in Volume Control. To do this, double-click the speaker icon in the taskbar, then click Options, Properties. Display the controls for Aux B, then clear the Mute setting.

Display Problems

If the OmniBook is on, but the screen is blank

- Press the space bar or move the pointer to see if the computer is in Standby mode.
- Press Fn+F1 or Fn+F2 to adjust the display brightness. If you are using an external keyboard, Fn=left CTRL + left ALT.
- Press Fn+F5 in case the internal display was disabled. (Do this three times to return to the state you started from.)

- If the OmniBook is cold, allow it to warm up.

If the screen is difficult to read

- Check whether the display resolution is set to its default setting, 1024 × 768 (XGA). Check this in Start, Settings, Control Panel, Display, Settings.
- Check brightness (press Fn+F2 to increase brightness).

If an external monitor doesn't work

- Check the connections.
- Press Fn+F5 in case the external monitor was disabled. (Do this three times to return to the state you started from.)
- The external monitor may not be detected. In the BIOS Setup utility, try setting Video Display Device to Both in the Main menu. See “To run the BIOS Setup utility” on page 62.
- If the monitor is connected to a video adapter in a docking system, in BIOS Setup make sure the Primary Video Adapter is set to Auto in the Main menu.

If the image on an external monitor or projector is unstable

- Press Fn+F5 to turn off the built-in display. (Do this three times to return to the state you started from.)
- Change the display properties of the OmniBook display to match the resolution of the monitor or projector. In Control Panel, open Display, Settings and change the Desktop Area or Screen Area setting.
- Use a monitor or projector that matches the resolution of the OmniBook display.

If multiple display support doesn't work in Windows 98

In Windows 98, the computer supports multiple independent displays using the built-in display and an external monitor connected to the monitor port. You can also add an independent display using a video adapter in a docking system.

- Check the monitor connections.
- If the monitor is connected to the OmniBook monitor port, you might have to reduce the resolution and number of colors for the built-in display to make more memory available for the external monitor. See the section “Connecting External Devices” in the online *Reference Guide*.

Troubleshooting **Solving Problems**

- If the monitor is connected to a video adapter in a docking system, in BIOS Setup make sure the Primary Video Adapter is set to Internal in the Main menu. See “To run the BIOS Setup utility” on page 62.
- See Windows 98 Help for information about setting up and using multiple displays.

Hard Disk Drive Problems

If the OmniBook’s hard drive doesn’t spin

- Check the power source.
- Remove and reinsert the hard drive. See “To replace the hard disk drive” on page 58.

If the hard disk makes buzzing or whining noise

- Back up the drive immediately.
- Check for alternate noise sources, such as the fan or a PC Card drive.

If files are corrupted

- Run the VirusScan program. See the section “Configuring Security Options” in the online *Reference Guide*.
- For Windows 95 or Windows 98, you can run the Scandisk surface scan to check the platter. (This is not available in Windows NT 4.0). From the Start menu, click Programs, Accessories, System Tools, Scandisk.
- For Windows 2000, open My Computer, select the disk you want to scan, click File, Properties, and use the Tools tab.
- For Windows NT 4.0, right click on the drive, then click Properties, Tools, Error Checking.
- If necessary, you can format the hard disk and reinstall the original factory software. See “To recover the factory installation of Windows” on page 87.

Keyboard and Pointing Device Problems

If the pointer is difficult to control

- To customize all pointing devices, use the Mouse icon in Control Panel.
- To customize the operation of the pointing stick, use the pointing stick icon available on the taskbar (or in the Windows Control panel) to access TrackPoint Properties. This is not yet available in Windows 2000.

If the touch pad or pointing stick doesn't work

- Do not move the pointer while the OmniBook is resuming from Suspend or rebooting. If you moved the pointer, try pressing a key on the keyboard. You may have to suspend and resume using the power button, or you may have to shut down and restart Windows.
- Make sure the touch pad or pointing stick is enabled in the BIOS Setup utility.
 1. From the Start menu, shut down, then restart the OmniBook.
 2. When you see the HP logo, press F2 to enter the BIOS Setup utility.
 3. From the System Devices menu, check Internal Pointing Devices.
 4. Select the desired pointing device or both devices.
 5. Press F10 to Save and Exit the BIOS Setup utility.
- Reset the OmniBook. See “To reset the OmniBook” on page 19.

If the embedded numeric keypad doesn't work

- Make sure the embedded Keypad Lock (Fn+F8) is on—or that you press and hold the Fn key to temporarily access the embedded keypad.
- To type numbers, make sure Num Lock is on.

If a special feature on the PS/2 mouse doesn't work

- The built-in pointing devices must be disabled for special mouse features to work. In the BIOS Setup utility, check that the PS/2 Pointing Devices option is set to Auto in the System Devices menu. See “To run the BIOS Setup utility” on page 62.
- Press the blue power button to suspend the OmniBook, then press it again to resume.
- Make sure you installed any drivers shipped with the mouse.

Troubleshooting Solving Problems

If left CTRL + left ALT doesn't work on an external keyboard

- Left CTRL + left ALT should work like the Fn key on an external keyboard. In BIOS Setup, check that External Fn Key is enabled in the System Devices menu. See “To run the BIOS Setup utility” on page 62.

If you can't type the euro symbol

- Hold ALT GR when you press the marked key.
- The euro symbol is not on the U.S. English keyboard. Make sure the embedded keypad is active (Fn+F8) and Num Lock is on, then hold ALT while typing 0128 on the numeric keypad.
- For Windows NT, if you select a different keyboard layout in Control Panel, you must reinstall the euro software. In Explorer, double-click `\Omnibook\Drivers\Euro\Nt4_euro.exe` on drive C or on the *Recovery CD*.
- Support for the euro symbol requires software available from Microsoft. This software is installed in the factory software, but may not be included with retail Windows.

Infrared Problems

Hint

Windows NT 4.0 does not support infrared communication.

If you have problems with infrared communications

- Windows NT 4.0 does not support infrared devices.
- Make sure the infrared light path is not blocked. The infrared port is located on the back of the computer.
- Line up the OmniBook's infrared port and the other infrared port in as straight a line as possible. The two ports should be no more than 1 meter apart, with no obstructions in between. Noise from nearby equipment can cause transmission errors.
- Check settings in BIOS Setup utility.
 1. From the Start menu, shut down, then restart the OmniBook.
 2. When you see the HP logo, press F2 to enter the BIOS Setup utility.
 3. From the System Devices menu, check that Infrared Port is enabled and the desired mode is selected.

4. Press F10 to Save and Exit the BIOS Setup utility.
- For infrared communications under Windows 95, you must install an infrared driver that matches the mode selected in BIOS Setup. For details, refer to the driver's Readme file located in \OmniBook\Drivers.
 - Check that only one application is using the infrared port.
 - Standard IrDA and fast-IrDA are incompatible (they use different drivers).
 - For fast-IrDA, check for DMA conflict with ECP parallel port.
 - Remove any PC Cards. An infrared IRQ conflict is possible if two PC Cards are present at the same time.
-

Memory Problems

If a message says you are out of memory

- If you're using Windows 95, Windows 98, or Windows NT, click Start, Help and use the Memory Troubleshooter.
- If you are having memory problems running MS-DOS programs, in Windows click Start, Help and use the MS-DOS Troubleshooter.
- Not all 3rd party memory cards have been tested with the OmniBook. Please check the OmniBook website (<http://www.hp.com/omnibook>) for a list of approved and tested memory cards.

If memory doesn't increase after adding RAM

- Use the correct type of memory (RAM) modules for your computer. For a model with "4150 B" after the serial number, use only PC-100 modules.
-

PC Card (PCMCIA) Problems

If the OmniBook doesn't recognize a PC Card

- For Windows NT, make sure Card Executive is installed. See "To install Card Executive for Windows NT" on page 57.
 - Remove and reinsert the PC Card.
-

Troubleshooting

Solving Problems

- Insert the PC Card in a different slot.
- Press the blue power button to suspend the OmniBook, then press it again to resume.
- If the card requires an IRQ, check that there is one available. If necessary, set the IRQ to an unused value manually.

If you're using Windows 95 or Windows 98, look in Device Manager under Properties, Interrupt Request (IRQ).

If you're using Windows NT, click Start, Programs, Administrative Tools, Windows NT Diagnostics.

- Check the HP Customer Care website (<http://www.hp.com/cposupport/eschome.html>) for information about installing certain PC Cards.
- Reboot the OmniBook.
- Zoomed Video is supported in the lower card slot only.
- Windows NT does not support Zoomed Video.
- Try the card in another computer.
- Not all 3rd party PC cards have been tested with the OmniBook. Please check the OmniBook website (<http://www.hp.com/omnibook>) for a list of approved and tested PC Cards.
- For a Xircom CE2 (IIPs) LAN card, certain of these cards conflict with the game port device in Windows 2000. Contact Xircom to see if your card is one of these.
- When using a PC card in a docking system, insert or remove the card while the system is turned on.

If an I/O card stops communicating properly

- It may have been reset if the OmniBook suspended or turned off. Exit and restart the application.
- Check settings in Control Panel (and in Windows NT Diagnostics).

Performance Problems

If the OmniBook gets hot

- It is normal for the computer to get warm.
- Make sure the air vents on the back and side are clear.
- DOS games and other programs that drive CPU usage toward 100% can contribute to a temperature increase.

If the OmniBook pauses or runs sluggishly

- Press CTRL+ALT+DEL to see if an application is not responding.
- Reboot the OmniBook.
- Delete temporary and unneeded files.
- This may be normal Windows behavior. Background processing can affect response time.
- Certain background operations (such as VirusScan) can affect performance while they're running.
- Some file browsers may be unresponsive while they're processing a graphic image or waiting for broken network connections to time out.
- Install additional memory if Windows is spending a lot of time swapping to disk.
- Check amount of available free disk space.
- Check the BIOS Setup settings.
 1. From the Start menu, shut down, then restart the OmniBook.
 2. When you see the HP logo, press F2 to enter the BIOS Setup utility.
 3. From the Power menu, set the Power Management Mode to Max. Performance.
 4. Press F10 to Save and Exit the BIOS Setup utility.

Power and Battery Problems

If the OmniBook turns off immediately after it turns on

- Battery power is probably extremely low. Plug in the ac adapter or insert a charged battery.

If the OmniBook keeps beeping

- The OmniBook beeps for 15 seconds when the battery is low. Save your work, quit immediately, and insert a charged battery or plug in the ac adapter.

If the OmniBook has a short operating time

- Try conserving power using any of the suggestions listed in the chapter titled “Managing Battery Power” in the online *Reference Guide*.
- If you are running any applications with an automatic save feature, such as MS Word for Windows, disable this feature.
- If the operating time has gotten shorter and the battery is more than a year or two old, you may need to replace the battery.
- Turn down the display brightness (Fn+F1).
- Heavy modem use can affect battery operating time.
- For Windows 95, 98, and NT, check the Power Management settings in BIOS Setup.
 1. From the Start menu, shut down, then restart the OmniBook.
 2. When you see the HP logo, press F2 to enter the BIOS Setup utility.
 3. From the Power menu, make sure the Power Management Mode is set to Maximum Power Savings.
 4. Press F10 to Save and Exit the BIOS Setup utility.
- For Windows 2000, check the settings in Control Panel, Power Options, on the Power Schemes tab.

If the battery doesn't charge

- Make sure the ac adapter is plugged into the power source.
- If you're using a power strip, remove the ac adapter from the power strip and plug it directly into a wall outlet.

- Check that the light on the ac adapter is on.
- Check that the battery is fully installed and locked in place.
- Turn off the OmniBook, then remove the battery and check that the battery contacts are clean.
- Check that the ac adapter cables are fully plugged in.
- Move the OmniBook away from any nearby heat source. Unplug the ac adapter and allow the battery to cool down. An elevated battery temperature prevents charging.
- If available, try another battery and ac adapter.

If the second battery doesn't charge

- The OmniBook's second battery doesn't charge until the main battery is fully charged.
- Make sure the ac adapter is plugged into the power source.
- Check that the light on the ac adapter is on.
- Check that the second battery module is fully installed and locked in place.

If the OmniBook stops responding

- Press CTRL+ALT+DEL and end an application that is not responding.
- Press the blue power button to suspend the OmniBook. Then press the blue button again to turn the OmniBook back on.
- If nothing happens, insert a straightened paper clip into the system-off button on the left side of the OmniBook. Then press the blue power button to turn on the OmniBook.

If the OmniBook doesn't suspend as expected

- If you have a connection to another computer, the OmniBook doesn't suspend if the connection is actively in use.
- If the OmniBook is performing an operation, it normally waits for the operation to finish.
- For Windows 95, 98, or NT, if a CD-ROM drive is present, make sure auto insert notification is disabled. This is the default factory setting. (This is not required for Windows 2000.)

In Windows 95 or Windows 98, view the CD-ROM drive properties in Device Manager.

Troubleshooting

Solving Problems

If retail Windows NT 4.0 is installed, you must edit the Registry to change this setting:

CAUTION: Incorrect editing of the Registry can make the system unbootable.

1. Log in as administrator.
2. Click Start, Run, type REGEDIT, and click OK.
3. Select HKEY_LOCAL_MACHINE\System\CurrentControlSet\Services\Cdrom.
4. Double-click AutoRun, change the value from 1 to 0, and click OK.
5. Exit the Registry Editor, then shut down and restart Windows.

If the OmniBook doesn't automatically hibernate as expected

- For Windows NT, certain point-enabled PC Cards and possibly other cards may prevent automatic hibernation when battery power is low. This may cause a drained battery and data loss. When leaving the computer unattended, either connect the ac adapter or shut down the computer.
- For Windows 2000, check to see that hibernate support is enabled. From Control Panel, open Power Options, and then click the Hibernate tab.

Also, check the Power Schemes tab. Make sure the Hibernate time-outs for both ac power and battery power are not set to Never.

If the battery doesn't finish charging in an external charger

- If you charge the battery in an HP external battery charger, the battery is finished charging when the charger's orange light turns off. It doesn't matter whether the green light turns on or stays off—the battery will be at least 90% full.

Printing Problems

Hint

For most printing problems, click Start, Help and use the Print Troubleshooter. If you're using Windows 2000, click Start, Help, Troubleshooting, and Print.

If a serial or parallel printer doesn't print

- Check that you are using a proper cable or cable adapter, and that the printer is turned on.
- Check for paper in the printer or other printer errors.
- Make sure the printer cable is secure at both ends.

If an infrared printer doesn't print

- Windows NT 4.0 does not support infrared devices.
- Make sure the infrared light path is not blocked.
- Check for paper in the printer or other printer errors.
- Make sure Windows is running—infrared printing is supported only while Windows is running.
- In BIOS Setup the infrared port must be enabled and the mode selected. The mode must match the driver. In Windows 95, an infrared driver must be installed. For details, refer to the driver's Readme file located in \Omnibook\Drivers.
- Click Start, Help and use the Print Troubleshooter. If you're using Windows 2000, click Start, Help, Troubleshooting, and Print.
- See "Infrared Problems" on page 74.

If the left edge of printed output is missing

- If the printer you are using is a 600-dpi (dots per inch) printer, try selecting a compatible printer driver for a 300-dpi printer. For example, for a 600-dpi HP LaserJet printer, try using the HP LaserJet IIIsi driver (300-dpi). Certain applications may not work properly with 600-dpi printers.

Serial, Parallel, and USB Problems

If the serial mouse doesn't work

- First, make certain you followed the manufacturer's installation instructions completely and have installed the mouse properly.
- Check that the cable is properly connected.
- Check settings in Control Panel (and in Windows NT Diagnostics).
- Make sure the serial port is working—see the next heading.

If the serial or parallel port is not working

- Check that the cable is properly connected.
- Check settings in Control Panel (and in Windows NT Diagnostics).
- Check settings in BIOS Setup.

Troubleshooting

Solving Problems

1. From the Start menu, shut down, then restart the OmniBook.
2. When you see the HP logo, press F2 to enter the BIOS Setup utility.
3. From the System Devices menu, check that Parallel and Serial are enabled.

If a serial modem doesn't work properly

- Click Start, Help and use the Modem Troubleshooter. If you're using Windows 2000, click Start, Help, Troubleshooting, and Modem.
- Check that the cables are properly connected.
- Check settings in Control Panel (and in Windows NT Diagnostics).
- Make sure the serial port is working—see the previous heading.

If the USB port is not working

- Windows NT 4.0 does not support USB devices.
- Check settings in Control Panel.
- Contact the vendor of the peripheral device, as well as the OmniBook website, for the latest versions of the USB drivers.

Startup Problems

If the OmniBook doesn't respond at turn-on

- Connect the ac adapter.
- Press blue power button to try turning on the unit.
- Reset the OmniBook. See “To reset the OmniBook” on page 19.
- If you get no response, remove the battery and ac adapter—then plug in the ac adapter and try resetting. If you still get no response, the unit requires service.

If the OmniBook doesn't boot from battery power

- Make sure the battery is properly inserted.
- Remove the battery and check its charge level by pressing the pad on the back of the battery. The lights show the charge level.
- Check battery contacts. If available, try another battery.

If the OmniBook doesn't boot from the floppy disk drive

After checking all connections, check the boot order and setup in BIOS Setup utility.

1. From the Start menu, shut down, then restart the OmniBook.
2. When you see the HP logo, press F2 to enter the BIOS Setup utility.
3. Open the Boot menu. The default boot order is
Removable Device
Hard Disk
CD-ROM/DVD Drive
4. If Removable Device is not option 1, use the arrow keys to select Removable Device.
5. Press F6 to move up (or F5 to move down) in the list.
6. If an LS-120 drive is also installed, expand the Removable Device category and move the floppy drive to the first position.
7. In the Security menu, make sure the Floppy Boot setting is Enabled.
8. Press F10 to Save and Exit the BIOS Setup utility.

Testing the Operation

The DiagTools hardware diagnostic program provides two levels of testing:

- Automated testing using the basic hardware test.
- Advanced testing using the individual hardware tests.

The tests are designed to run after the system reboots. This ensures that the computer will be in a predictable state, so the diagnostic program can properly test the hardware components. The tests are non-destructive and are intended to preserve the state of the computer. The OmniBook reboots when you exit the program so drivers can be loaded.

To run the diagnostic test

Note

If the computer does not display the F10 diagnostics prompt while rebooting, you must run the diagnostics from a diagnostic floppy disk. See “To create a diagnostic floppy disk” on page 85.

1. Reboot the OmniBook. When you see the HP logo and the F10 prompt, press F10 to start the diagnostic test.
2. Go through the first several screens.
3. When the hardware detection finishes, check the list of detected hardware.

Hint

If a device is not detected or fails its test below, it may be configured incorrectly in the BIOS Setup utility. You can confirm the problem by running BIOS Setup and checking the settings. See “To run the BIOS Setup utility” on page 62.

4. **Run the basic test.** Press F2 to start the basic hardware test.
5. If you intend to exit without running the advanced tests, press F4 to save system and test information in the Support Ticket log file, HPSUPPT.TXT. Then press F3 to exit.
6. **Optional: Run the advanced tests.** Press F2 to open the advanced test screen.

7. Select and run the appropriate tests. Tests are not listed if no such hardware is detected. Press the following keys to run tests:

ENTER	Runs the highlighted test.
F5 or SPACE	Marks or unmarks the highlighted test.
F6	Marks or unmarks all tests in the current menu.
F7	Marks or unmarks all tests in all menus.
F10	Runs all marked tests.

8. When you are finished running tests, press ESC to exit the advanced tests.
9. **Optional: Save the Support Ticket.** Press F4 to save system and test information in the Support Ticket log file, HPSUPPT.TXT.
10. **Exit.** Press F3 to exit and reboot.
11. **Optional: Check the log.** The log file contains a list of all test results and errors. Run C:\Dmi\Hpdiags\Hpsuppt.exe to retrieve the log file to this directory and open it in Notepad. (If Hpsuppt.exe is not on your hard disk, you can download it from the OmniBook website.)

To create a diagnostic floppy disk

If your computer doesn't support running the diagnostics by pressing F10 during reboot, you can run the diagnostics by booting from a diagnostic floppy disk.

After inserting a formatted floppy disk in the floppy drive, do one of the following to create a diagnostic floppy disk:

- Check the C:\Dmi\Hpdiags directory. If **diaginst** is in this directory, double-click it.
–or–
If HP TopTools is installed, check the DiagTools page to see if it can create the disk.
- On any computer with World Wide Web access, download the diagnostic software package from the HP Customer Care website (<http://www.hp.com/cposupport/eschome.html>), and follow the instructions.

To run the diagnostics from the floppy disk, insert the disk in the floppy drive and reboot the OmniBook. If you create a Support Ticket, it is saved on the diagnostic floppy disk. Remove the floppy disk just before you exit the diagnostics program.

Recovering Software

You can use the OmniBook *Recovery CD* to reinstall the original factory software on your hard disk drive.

If you need to configure a custom system, you can get OmniBook-specific drivers from these locations:

- On the *Recovery CD* ROM, under \Omnibook\Drivers.
- On the OmniBook hard drive under C:\Omnibook\Drivers.
- On the HP Customer Care website at <http://www.hp.com/cposupport/eschome.html>. This website contains the latest updates of software drivers.

Detailed instructions for installing the drivers are contained in the Drivers\Readme file.

Note

You'll find drivers for the operating system that was shipped with your OmniBook on the hard drive and on the *Recovery CD*. If you want drivers for a different operating system, see the HP Customer Care website.

To recover the factory installation of Windows

Use the *Recovery CD* to reinstall the original factory software on the hard disk. You use the same process to create a larger Hibernate/diagnostics partition on your hard disk or to create a Hibernate partition on a new hard disk.

CAUTION

This procedure will format the hard disk drive. After the hard disk drive is formatted, you'll need to reinstall any applications. Reformatting the hard disk drive will erase all data on the disk.

Do not interrupt the following process or unplug the ac adapter until the process is complete.

1. **Important.** Back up all data from your hard disk. The following steps delete all data from the disk.
2. Plug in the ac adapter.
3. Insert the *Recovery CD* in the CD-ROM drive.
4. Shut down and restart the computer—when you see the HP logo, press ESC two times.
5. Select the CD-ROM drive as the boot device.
6. When the Recovery CD dialog box appears, follow the displayed instructions. If prompted, accept the recommended partition size. If you install the factory software, the recovery process can take up to 10 minutes.

If you want to create the Hibernate/diagnostics partition without installing the factory software, click Advanced and select the option to not install the operating system. If you intend to install Windows NT, you should choose the FAT16 option or the Hibernate-only option.

Note

If, instead, you see an MS-DOS menu of options, select “Recover...” to create the Hibernate partition and install the factory software, which can take up to 60 minutes. Or select “Create Hibernate Partition” to not install the software. Accept the recommended partition size.

7. When prompted to reboot the computer, press CTRL+ALT+DEL and follow any displayed instructions.

Support and Service

Getting HP OmniBook Assistance

Support Assistance

If you need assistance with your HP OmniBook or accessory, use any of the following support services:

Provider Type	Type of Assistance
1. Electronic Support Services (see below)	HP self-help tools, information and software. Approved and Tested Solutions.
2. Customer Support Centers (see below)	Email and telephone support assistance. In and out of warranty repair processes.
3. HP-authorized resellers	Local support assistance. Referral to Customer Support Center or HP-approved support provider.

Electronic Support Services

- **HP OmniBook World Wide Web:** Download technical information, drivers and software from the web at <http://www.hp.com/omnibook>.
- **HP PC & Peripheral Self-Help and Direct-Help Tools:** Visit the web <http://www.hp.com/cps-support/guide/home.html>.

Choose Self-Help Tools to use a number of services that offer information and software that will help you make the most of your HP products:

- Bulletin Boards.
- Commercial Online Services.
- CD-ROM Subscriptions.
- Service Parts Information.

Repair Assistance

Warranty. You must contact one of the participating support providers listed in item 3 in “Support Assistance” above, or an HP Service Center to receive warranty service. The support provider will help qualify your unit for warranty repair based on the warranty applicable to your unit and original purchase date, and will provide you with repair processes in your area. Warranty service includes the cost of shipping, handling, duties, taxes, freight or fees to or from the service location.

Out of Warranty. Contact one of the support providers listed in items 2 or 3 in “Support Assistance” above, or an HP Service Center. The support provider will provide you with repair charges and processes in your area.

Customer Support Centers

HP Customer Support Centers, will assist you for free (you are responsible for the telephone charges) during the term of the warranty.

During the free assistance period, HP will assist with questions about:

- Included applications and operating systems.
- HP-described operation environments and conditions.
- HP accessories, HP upgrades, and basic operation and troubleshooting.

HP will not be able to help with questions about:

- Non-HP hardware, software, operating systems, or usage not intended for or included (by HP) with the product.
- How to repair the product yourself.
- Product development, custom installations.
- Consulting.

Support and Service
Getting HP OmniBook Assistance

To contact the Customer Support Center by email, visit the HP Customer Care website at <http://www.hp.com/cposupport/eschome.html>.

For the latest list of phone numbers, see the OmniBook website under Support, <http://www.hp.com/omnibook>.

<p>North America United States: (970) 635-1000 Canada (English): (970) 635-1000 Canada (French): (800) 387-3867 Mexico: 326 4600, Guadalejara 669 9500, Monterrey 378 4240</p> <p>Central/South America Argentina: 541781 4061 69 Brazil: 5511 709 1444 Venezuela: 58 2 239 5664</p> <p>Europe Austria (German): 0660.6386 Belgium (Dutch): 02.626.8806 Belgium (French): 02.626.8807 Czech Republic: 42 2 471 7321 Denmark (Danish/Swedish): 3929.4099 Finland (Swedish/English): 0203.47.288 France (French): 01.43.62.34.34 Germany (German): 0180.52.58.143 Greece: 301 689 6411 Hungary: 36(1) 252 4505 Netherlands (Dutch): 020.606.8751 Ireland (English): 01.662.5525 Italy (Italian): 02.264.10350 Norway (Norwegian/Swedish): 22.11.6299 Poland 4822 37 50 65 Portugal: 01.441.7199</p>	<p>Russia 7095 797 3500 Spain (Spanish): 902.321.123 Sweden (Swedish): 08.619.2170 Switzerland (German/French): 0848.80.11.11 Turkey: 90 212 224 59 25 UK (English): 0171.512.52.02 English (non-UK): 44 171 512 52 02</p> <p>Asia and Australia Australia: 03.9272.8000 China: 010 6505 3888 Hong Kong: 800 967-729 India: 011 682 6035 Indonesia: 021 350 3408 Japan: 03 3235 8333 Korea: Seoul 02.3270.0700, outside Seoul 080 999-0700 Malaysia: Penang 1300 88 0028, outside Penang 03 295 2566 New Zealand: 0800 445 543 Philippines: 02 867 3551 Singapore: 65 272 5300 Taiwan: 02 717 0055 Thailand: 02 661 4011 Vietnam: 08823 4530</p> <p>Africa/Middle East 41 22 780 71 11</p>
--	--

Hewlett-Packard Limited Warranty Statement

1. HP warrants to you, the end-user customer, that HP hardware, accessories and supplies will be free from defects in materials and workmanship after the date of purchase, for the period specified in the Warranty Duration sheet included with your OmniBook. If HP receives notice of such defects during the warranty period, HP will, at its option, either repair or replace products which prove to be defective. Replacement products may be either new or equivalent in performance to new.
2. HP warrants to you that HP software will not fail to execute its programming instructions after the date of purchase, for the period specified in the Warranty Duration sheet included with your OmniBook, due to defects in material and workmanship when properly installed and used. If HP receives notice of such defects during the warranty period, HP will replace software which does not execute its programming instructions due to such defects.
3. HP does not warrant that the operation of HP products will be uninterrupted or error free. If HP is unable, within a reasonable time, to repair or replace any product to a condition as warranted, you will be entitled to a refund of the purchase price upon prompt return of the product.
4. HP products may contain remanufactured parts equivalent to new in performance or may have been subject to incidental use.
5. Warranty does not apply to defects resulting from (a) improper or inadequate maintenance or calibration, (b) software, interfacing, parts or supplies not supplied by HP, (c) unauthorized modification or misuse, (d) operation outside of the published environmental specifications for the product, or (e) improper site preparation or maintenance.
6. TO THE EXTENT ALLOWED BY LOCAL LAW, THE ABOVE WARRANTIES ARE EXCLUSIVE AND NO OTHER WARRANTY OR CONDITION, WHETHER WRITTEN OR ORAL, IS EXPRESSED OR IMPLIED AND HP SPECIFICALLY DISCLAIMS ANY IMPLIED WARRANTIES OR CONDITIONS OF MERCHANTABILITY, SATISFACTORY QUALITY, AND FITNESS FOR A PARTICULAR PURPOSE. Some countries, states or provinces do not allow limitations on the duration of an implied warranty, so the above limitation or exclusion might not apply to you. This warranty gives you specific legal rights and you might also have other rights that vary from country to country, state to state, or province to province.
7. TO THE EXTENT ALLOWED BY LOCAL LAW, THE REMEDIES IN THIS WARRANTY STATEMENT ARE YOUR SOLE AND EXCLUSIVE REMEDIES.

Support and Service

Hewlett-Packard Limited Warranty Statement

EXCEPT AS INDICATED ABOVE, IN NO EVENT WILL HP OR ITS SUPPLIERS BE LIABLE FOR LOSS OF DATA OR FOR DIRECT, SPECIAL, INCIDENTAL, CONSEQUENTIAL (INCLUDING LOST PROFIT OR DATA), OR OTHER DAMAGE, WHETHER BASED IN CONTRACT, TORT, OR OTHERWISE. Some countries, states or provinces do not allow the exclusion or limitation of incidental or consequential damages, so the above limitation or exclusion may not apply to you.

THE WARRANTY TERMS CONTAINED IN THIS STATEMENT, EXCEPT TO THE EXTENT LAWFULLY PERMITTED, DO NOT EXCLUDE, RESTRICT OR MODIFY AND ARE IN ADDITION TO THE MANDATORY STATUTORY RIGHTS APPLICABLE TO THE SALE OF THIS PRODUCT TO YOU.

Specifications and Regulatory Information

Specifications and Regulatory Information
Hardware Specifications

Hardware Specifications

In a continuing effort to improve our products, the specifications shown below are subject to change. For the latest specifications, see the OmniBook website, <http://www.hp.com/omnibook>.

Physical Attributes	Size: 330.5mm×256.9mm×35-36.5mm (13.0"×10.1"×1.3-1.4"). Weight: 2.9 kg (6.4 lb).
Processor and Bus Architecture	300-MHz Intel Mobile Pentium II processor with 512-KB pipeline-burst-synchronous L2 cache. –or– 400-, 366- or 300-MHz Intel Mobile Pentium II processor with 256-KB four-way set-associative L2 cache. –or– 650/500-, 500-, or 450-MHz Intel Mobile Pentium III processor with 256-KB four-way set-associative L2 cache. 1.6-V core, 2.5-V external, low-power processor. 32-KB (16-KB instruction, 16-KB data) L1 cache. 32-bit PCI bus.
Graphics	14.1- or 13.3-inch XGA active-matrix (TFT) display (1024 × 768 × 16M colors). Zoomed Video support for lower PC Card slot. Models without "4150" after serial number 256-bit NeoMagic MagicGraph graphics accelerator with 2.5-MB video RAM, 1x AGP graphics capability. Models with "4150 B" after serial number ATI Mobility-M or -M1 graphics accelerator with 4- or 8-MB video RAM, 2x AGP graphics capability.
Power	Rechargeable 9-cell lithium ion battery with LED charge-level gauge (10.8 Vdc). Battery life (one battery): up to 3-4 hours typical (varies with type of usage and model). Fast battery recharge: 80% in 1.5 hour, 100% in 2 hours. Low-battery warning. Suspend/resume capability. 60-watt ac adapter: 100 to 240 Vac (50 to 60 Hz) input, 19 Vdc, 3.16 A output.
Mass Storage	12-, 10-, 6-, or 4-GB removable hard drive. 1.44-MB floppy drive module. CD-ROM or DVD drive module. Optional LS-120 storage module. Second hard disk drive module.

Specifications and Regulatory Information
Hardware Specifications

RAM	64 or 128 MB RAM in first RAM slot. Two slots for RAM expansion up to 256 MB (using 128-MB modules). 66-MHz RAM bus, or 100-Mhz RAM bus for models with "4150 B" after serial number.
Audio System	16-bit Sound Blaster Pro-compatible stereo sound. Stereo sound via two built-in speakers. 3D-enhanced PCI bus audio with Zoomed Video support. Built-in microphone. Line-in, headphone-out, and microphone-in.
Keyboard and Pointing Device	87/88-key touch-type QWERTY keyboard with 101/102 key emulation. Embedded numeric keypad. 12 function (Fn) keys. Two pointing devices: pointing stick (TrackPoint technology licensed from IBM) and touch pad.
Input/Output	Universal serial bus (USB). 9-pin, 115,200-bps serial (16550 UART). 25-pin bi-directional ECP/EPP parallel. Video-out. (Resolution up to 1280×1024×256 colors, or up to 1600×1200×64K or 16M colors for models with "4150 B" after serial number. Refresh rate 60 to 85 Hz.) Dual display. PS/2 keyboard/mouse. 4-Mbps IrDA-compliant infrared port.
Expandability	One Type III or two Type II 16-/32-bit PC Card slots (3.3- and 5-V support). CardBus enabled. External plug-in module bay for accessory modules. Optional port replicator, mini dock, and docking system.
Software	Microsoft Windows 95/98, Windows NT 4.0, or Windows 2000. Windows 95/98/2000-compatible Plug-and-Play. Windows NT 4.0 and PC Card Plug-and-Play. Advanced Power Management (APM). DMI with HP TopTools. Adobe Acrobat Reader. Agaté Tioman for HP (Hot Swap). DiagTools. VirusScan. Online <i>Reference Guide</i> . OmniBook <i>Recovery CD</i> included. Centralized worldwide BIOS and driver update service.
Security Features	User and administrator passwords. System, hard drive, and docking passwords. PC identification displayed at boot. DMI-accessible electronic serial number. Kensington MicroSaver lock slot.

Specifications and Regulatory Information
Hardware Specifications

Environmental Limits	Operating temperature: 5 to 35 °C (41 to 95 °F). Operating humidity: 20 to 90 percent RH (5 to 35 °C). Storage temperature: -20 to 50 °C (-4 to 122 °F).
Major ICs	Models without “4150” after serial number CPU: Intel Mobile Pentium II or Pentium III processor. South Bridge: PIIX4E. Video: NeoMagic MagicGraph NM2200 (NMG5). Audio: NeoMagic MagicGraph NM2200 (NMG5) and NeoMagic Audio NMA2. CardBus: TI PCI 1220A. Keyboard controller: National PC87570. Super I/O: SMC 769. Models with “4150 B” after serial number CPU: Intel Mobile Pentium II processor. South Bridge: PIIX4M. Video: ATI Mobility-M or -M1. Audio: ESS ES1978 Maestro-2E and ESS ES1921. CardBus: TI PCI 1225. Keyboard controller: National PC87570. Super I/O: SMC 869.

Safety Information

Power Cords

The power cord supplied with the OmniBook ac adapter should match the plug and voltage requirements for your local area. Regulatory approval for the ac adapter has been obtained using the power cord for the local area. However, if you travel to a different area and need to connect to a different outlet or voltage, you should use one of the power cords listed below. To purchase a power cord (including one for a country not listed below) or a replacement ac adapter (HP part number F1454A), contact your local Hewlett-Packard dealer or Sales and Service office.

Country	Rated Voltage and Current	HP Part Number
Canada Mexico Philippines Taiwan United States	125 Vac (3 A)	8120-6313
East and West Europe Egypt Saudi Arabia	250 Vac (2.5 A)	8120-6314
Hong Kong Singapore United Kingdom	250 Vac (2.5 A)	8120-8699
Australia New Zealand	250 Vac (2.5 A)	8120-6312
Japan	125 Vac (3 A)	8120-6316
India South Africa	250 Vac (2.5 A)	8120-6317
Argentina	250 Vac (2.5 A)	8120-8367
Chile	250 Vac (2.5 A)	8120-8452
People's Republic of China	250 Vac (2.5 A)	8120-8373

Ergonomics

WARNING

Improper use of keyboards and other input devices has been associated with ergonomic injury. For information about reducing your risk, see Working in Comfort in the online OmniBook Library, or visit our ergonomics website, <http://www.hp.com/ergo>.

Battery Safety

- To avoid risk of fire, burns, or damage to your battery pack, do not allow a metal object to touch the battery contacts.
- The battery pack is suitable for use only with compatible OmniBook models. Check “Support Assistance” on page 90 for your local HP contact.
- Do not disassemble the battery. There are no serviceable parts inside. Do not dispose of the battery pack in fire or water.
- Handle a damaged or leaking battery with extreme care. If you come in contact with the electrolyte, wash the exposed area with soap and water. If it contacts the eye, flush the eye with water for 15 minutes and seek medical attention.
- Do not expose the battery pack to high storage temperatures (above 60 °C, 140 °F).
- When the battery is not in use, store it in the battery pouch provided.
- When discarding a battery pack, contact your local waste disposal provider regarding local restrictions on the disposal or recycling of batteries.
- To obtain a replacement battery, contact your local dealer or HP sales office.
- Do not charge the battery pack if the ambient temperature exceeds 45 °C (113 °F).

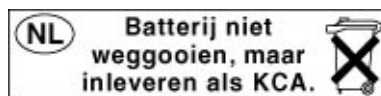

Laser Safety

The CD-ROM and DVD drives used with the OmniBook are certified as a Class 1 laser devices according to the U.S. Department of Health and Human Services (DHHS)

Radiation Performance Standard and International Standards IEC 825 / IEC 825-1 (EN60825 / EN60825-1). These devices are not considered harmful, but the following precautions are recommended:

- Ensure proper use by reading and following the instructions carefully.
- If the unit requires service, contact an authorized HP service center—see “Support Assistance” on page 90.
- Do not attempt to make any adjustment of the unit.
- Avoid direct exposure to the laser beam—do not open the unit.

CLASS 1 LASER PRODUCT
LASER KLASSE 1

LED Safety

The infrared port located on the back of the OmniBook is classified as a Class 1 LED (light-emitting diode) device according to International Standard IEC 825-1 (EN60825-1). This device is not considered harmful, but the following precautions are recommended:

- If the unit requires service, contact an authorized HP service center—see “Support Assistance” on page 90.
- Do not attempt to make any adjustment of the unit.
- Avoid direct eye exposure to the infrared LED beam. Be aware that the beam is invisible light and cannot be seen.
- Do not attempt to view the infrared LED beam with any type of optical device.

CLASS 1 LED PRODUCT
LEDSCHÜTZKLASSE 1 PRODUKT

Regulatory Information

This section presents information that shows how the OmniBook complies with regulations in certain regions. Any modifications to the OmniBook not expressly approved by Hewlett-Packard could void the authority to operate the OmniBook in these regions.

U.S.A.

The OmniBook generates and uses radio frequency energy and may interfere with radio and television reception. The OmniBook complies with the limits for a Class B computing device as specified in Part 15 of FCC Rules, which provide reasonable protection against such interference in a residential installation. In the unlikely event that there is interference to radio or television reception (which can be determined by removing the unit's batteries and ac adapter), try the following:

- Reorienting or relocating the receiving antenna.
- Relocating the OmniBook with respect to the receiver.
- Connecting the OmniBook ac adapter to another power outlet.

Connections to Peripheral Devices

To maintain compliance with FCC Rules and Regulations, use properly shielded cables with this device.

For more information, consult your dealer, an experienced radio/television technician, or the following booklet, prepared by the Federal Communications Commission: *How to Identify and Resolve Radio-TV Interference Problems*. This booklet is available from the U.S. Government Printing Office, Washington, DC 20402, Stock Number 004-000-00345-4. At the first printing of this manual, the telephone number was (202) 512-1800.

Declaration of Conformity

Responsible Party: Hewlett-Packard Company
Manager of Corporate Product Regulations
3000 Hanover Street
Palo Alto, CA 94304
(415) 857-1501

declares that the product(s)

Trade name: Hewlett-Packard Company

Product name: HP OmniBook 4150

Complies with Part 15 of the FCC Rules. Operation is subject to the following two conditions:

1. This device may not cause harmful interference, and
2. This device must accept any interference received, including interference that may cause undesired operation.

Canada

This digital apparatus does not exceed the Class B limits for radio noise emissions from digital apparatus as set out in the radio interference regulations of the Canadian Department of Communications.

Le présent appareil numérique n'émet pas de bruits radioélectriques dépassant les limites applicables aux appareils numériques de Classe B prescrites dans le règlement sur le brouillage radioélectrique édicté par le Ministère des Communications du Canada.

Japan

この装置は、情報処理装置等電波障害自主規制協議会（VCCI）の基準に基づくクラスB情報技術装置です。この装置は、家庭環境で使用することを目的としていますが、この装置がラジオやテレビジョン受信機に近接して使用されると受信障害を引き起こすことがあります。

取り扱い説明書に従って正しい取り扱いをして下さい。

Specifications and Regulatory Information

Regulatory Information

International

Products sold internationally by Hewlett-Packard and its authorized dealers meet the specifications listed below.

Declaration of Conformity (according to ISO/IEC Guide 22 and EN 45014)

Address:	Hewlett-Packard Company Mobile Computing Division 19310 Pruneridge Ave. Cupertino, CA 95014 declares that the following product
Product name:	HP OmniBook 4150
Options:	All conforms to the following product specifications
Safety:	IEC 950:1991+A1,A2,A3,A4 / EN 60950 (1992)+A1,A2,A3,A4,A11 GB4943-1995 IEC 825-1:1993 / EN 60825-1:1994, Class 1
EMC:	CISPR 22:1993+A1,A2 / EN 55022 (1994)+A1,A2: Class B [1] GB9254-1988 EN 50082-1:1992 IEC 801-2:1991 / prEN 55024-2 (1992): 4kV CD, 8kV AD IEC 801-3:1984 / prEN 55024-3 (1991): 3V/m IEC 801-4:1988 / prEN 55024-4 (1992): 0.5 kV signal lines, 1.0kV power lines FCC Title 47 CFR, Part 15 Class B Ansi C63.4:1992 AS/NZS 3548:1995 Rules and Regulations of Class B
Supplementary Information:	<p>The product herewith complies with the requirements of the Low Voltage Directive 73/23/EEC and EMC Directive 89/336/EEC and carries the CE mark accordingly.</p> <p>This device complies with Part 15 of FCC Rules. Operation is subject to the following two conditions: (1) this device may not cause harmful interference, and (2) this device must accept any interference received, including interference that may cause undesired operation.</p> <p>The HP F1454A ac adapter used with this product is designed to operate on all power systems, other than IT power systems.</p>

[1] The product was tested in a typical configuration with Hewlett-Packard personal computer peripherals.

Quality Department,
Hewlett-Packard Company
Mobile Computing Division

Index

A

- ac adapter
 - charging battery, 45
 - connecting, 15, 45
 - jack, 12
 - part number, 15
- accessories
 - plug-in modules, 51
 - troubleshooting, 68
- adding RAM, 59
- adjusting
 - brightness, 23
 - volume, 24
- administrator password, 63
- Advanced Power Management (APM)
 - preinstalled for Windows 95/98, 42
 - Windows NT 4, 43
- Agaté Tioman hot-swap
 - installing, 50
 - troubleshooting, 69
 - using, 51
- antistatic precautions, 59
- audio
 - adjusting volume, 24, 69
 - connecting devices, *See Reference Guide*
 - muting, 24
 - troubleshooting, 69
- audio jacks
 - location, 12

B

- battery
 - charging, 45
 - checking level, 44
 - for clock, 43
 - installing, 46
 - installing secondary, 47
 - location, 13
 - low-power warnings, 42, 44
 - operating time, 78
 - release latch, 12
 - removing, 46
 - safety, 47, 100
 - saving power, *See Reference Guide*

- status lights, 44
- troubleshooting, 78
- bay (module), 51
- BIOS Setup utility
 - deleting passwords, 64
 - menus, *See Reference Guide*
 - setting passwords, 63
 - using, 62
- boot device order, 19, 69
- brightness
 - adjusting, 23
 - affects display life, 23

C

- Caps Lock, 12
- Card Executive, 57
- Cardbus cards, 56
- cards (PCMCIA), 56
- CD-ROM drive
 - installing, 51
 - troubleshooting, 68
- charging battery, 45
- clicking items, 22
- COM1 port, 14, 53
- configuring
 - BIOS settings, 62
- connecting
 - ac adapter, 45
 - external display, 54
 - parallel device, 55
 - plug-in modules, 51
- Corporate Evaluator's Guide, 10
- creating
 - diagnostic disk, 85
- cursor (pointer), 22
- Customer Care website, 10

D

- deleting password, 64
- devices, *See also Reference Guide*
 - boot order, 69
 - drivers, 86
 - external display, 25, 26, 54
 - parallel, 55
 - ports for, 53
 - printers, 55
 - PS/2, 55
 - temporary boot order, 19
- diagnostics

- floppy disk, 85
 - running, 84
- DiagTools, 84
- disks
 - diagnostic, 85
- display
 - brightness, 23
 - connected to dock, 54
 - connecting external, 54
 - extending life, 23
 - multiple (Windows 98), 71
 - port, 14, 53
 - switching to external, 25, 26, 54
 - troubleshooting, 70
- DMA channels, 68
- docking port, 14, 53
- docking system
 - display, 54
 - multiple displays, 71
 - troubleshooting, 68
- dot matrix printer, 55
- dragging items, 22
- drive lock, *See Reference Guide*
- drivers
 - APM (Windows NT), 43
 - Card Executive (Windows NT), 57
 - on Recovery CD, 86
 - on web, 86
- drives
 - creating Hibernate partition, 87
 - plug-in modules, 51
 - replacing hard disk, 58
- DVD drive
 - installing, 51
 - troubleshooting, 69

E

- ECP, 55
- enabling
 - external display, 25, 54
- EPP, 55
- ergonomics, 25, 27
- euro symbol, 74
- external
 - display, 25, 54
 - keyboard, 13, 55

- F
- F1 through F12, 25
- F10 (diagnostics), 84
- F1454A (ac adapter), 15
- files
 - recovering, 87
- FIR port, 53
- floppy drive
 - connecting, 51
- Fn key
 - + F1 (decrease brightness), 23
 - + F12 (Hibernate), 25
 - + F2 (increase brightness), 23
 - + F5 (display options), 54
 - + F8 (keypad), 26
 - + R (Suspend), 25
 - + S (Standby), 25
 - external keyboard, 55
 - temporary keypad, 26
- function keys, 25
- H
- hard disk drive
 - creating Hibernate partition, 87
 - Hibernate partition, *See Reference Guide*
 - locking, *See Reference Guide*
 - replacing, 58
 - troubleshooting, 72
- hardware specifications, 96
- Hewlett-Packard support, 68
- hibernate
 - at low battery, 44
 - creating partition, 87
 - mode, 18, 25
 - status lights, 20
- Hibernate partition, *See Reference Guide*
- hot computer, 77
- hot keys, 25
- hot swapping
 - installing software, 50
 - swapping modules, 51
 - troubleshooting, 69
- HP Customer Care website, 10
- I
- I/O addresses, 68
- infrared port
 - connecting, *See Reference Guide*
 - location, 14, 53
 - safety, 101
 - troubleshooting, 74
- InkJet printer, 55
- installing
 - battery, 46
 - hard disk drive, 58
 - hot-swap software, 50
 - plug-in modules, 51
 - RAM, 59
 - secondary battery, 47
- installing original software, 87
- instant-on, 18
- interrupts (system), 68
- K
- Kensington lock, 65
- keyboard
 - connecting external, 55
 - embedded keypad, 26
 - ergonomic precautions, 25
 - euro symbol, 74
 - external Fn key, 55
 - Fn hot keys, 25
 - NT language, 56
 - num lock, 26
 - opening, 59
 - port location, 13
 - status lights, 12
 - troubleshooting, 73
- keypad (embedded), 26
- Keypad Lock, 12
- L
- laser printer, 55
- laser safety, 101
- Library (OmniBook), 10
- license agreement, 3
- lights (status), 12, 20
- locking (cable), 65
- low battery
 - charging, 45
 - warning, 44
- LPT1 port, 14, 53
- M
- memory
 - adding, 59
 - PC-100, 59, 75
 - system, 68
 - troubleshooting, 75
- microphone
 - location, 12
- mini dock, 68
- modes
 - power, 18
- module bay, 51
- modules (plug-in), 51
- monitor
 - connecting, 54
 - multiple (Windows 98), 71
 - port, 14, 53
 - switching to, 25, 26, 54
 - troubleshooting, 70
- mouse
 - connecting, 55
 - PS/2 port, 13
- multiple displays (Windows 98), 71
- mute, 12, 24
- N
- Num Lock, 12, 26
- O
- off
 - button location, 12
 - status lights, 20
 - turning off, 18
- OmniBook
 - changing BIOS settings, 62
 - locking, 65
 - reinstalling Windows, 87
 - resetting, 19
 - starting and stopping, 18
 - testing, 84
 - websites, 10
- OmniBook Library, 10
- OmniBook Notes, 10
- on
 - button location, 12
 - status lights, 20
 - turning on, 18
- overheating, 77
- P
- parallel port
 - connecting, 55
 - location, 14, 53
 - troubleshooting, 81
- passwords
 - deleting, 64
 - forgotten, 64
 - NT administrator, 16
 - setting, 63
- PC Cards
 - installing, 56
 - plug and play, 57
 - slots for, 12
 - stopping, 56
 - tested, 57
 - troubleshooting, 75

- Windows NT support, 57
- PC-100 RAM, 59, 75
- PCMCIA cards, 56
- plug requirements, 99
- plug-in modules
 - location, 13
 - swapping, 51
- pointing devices
 - location, 12
- pointing stick
 - configuring, *See Reference Guide*
 - location, 12
 - troubleshooting, 73
 - using, 22
- port locations, 14, 53
- port replicator, 68
- power
 - checking battery, 44
 - connecting ac, 15, 45
 - low-battery warnings, 42, 44
 - modes, 18
 - saving, *See Reference Guide*
 - troubleshooting, 78
- power button
 - location, 12
 - resetting with, 19
 - turning on and off, 18
- power cords, 99
- printers
 - connecting, 55
 - troubleshooting, 80
- protection
 - Kensington lock, 65
 - passwords, 63, 64
- PS/2 devices
 - connecting, 55
- PS/2 port, 13, 53

R

RAM

- adding, 59
- PC-100, 59, 75
- troubleshooting, 75

rebooting

- after shutdown, 18
- boot device, 69
- temporary boot device, 19
- troubleshooting, 82

recharging battery, 45

recovering original software, 87

Recovery CD

- contents, 86

regulatory information, 102

removing

- battery, 46
 - hard disk drive, 58
 - PC Card, 56
 - secondary battery, 47
- repair service, 68
- resetting, 19

S

safety

- battery use, 100
- infrared port, 101
- laser, 101
- power cords, 99

security

- Kensington lock, 65
- passwords, 63, 64

selecting items, 22

serial port

- connecting, *See Reference Guide*
- location, 14, 53
- troubleshooting, 81

service (repair), 68

Service Pack (Windows NT), 68

shortcut keys, 25

software

- license, 3

speakers

- location, 12, 13

specifications

- hardware, 96

standby

- and display life, 23
- mode, 18
- status lights, 20

starting OmniBook, 18

static electricity, 59

status lights

- keyboard, 12
- location, 12
- meanings, 20

stopping OmniBook, 18

Support Ticket, 84

suspend

- and display life, 23
- mode, 18
- status lights, 20

swapping modules, 51, 69

system resources

- interrupts, 68

system-off button

- location, 13
- resetting, 19

T

taskbar

- battery, 44
- PC Card, 56
- volume, 24

temperature

- limits, 98
- overheating, 77

testing the OmniBook, 84

TopTools, *See Reference Guide*

touch pad

- configuring, *See Reference Guide*
- location, 12
- troubleshooting, 73
- using, 22

track point, *See pointing stick*

troubleshooting

- audio, 69
- battery, 78
- CD-ROM drive, 68, 69
- display, 70
- dock, 68
- DVD drive, 69
- hard disk drive, 72
- infrared port, 74
- keyboard, 73
- memory, 75
- parallel devices, 81
- PC Cards, 75
- performance, 77
- pointing stick, 73
- power, 78
- printing, 80
- serial devices, 81
- startup, 82
- touch pad, 73
- USB devices, 81

turning off

- OmniBook, 18

U

URLs, 10

USB

- connecting, *See Reference Guide*
- port location, 13, 53
- troubleshooting, 81
- user password, 63

V

VGA output, 14. *See display*

VirusScan, *See Reference Guide*

voltage requirements, 99

volume

adjusting, 24
troubleshooting, 69

W

warning (low battery), 44
websites, 10

Windows

documentation, 10
installing drivers, 86
reinstalling, 87
Y2K, 16

Windows 2000

enhanced pointing features, 22
undock security, 64

Windows NT 4

adding APM, 43
adding Card Executive, 57
administrator password, 16
euro symbol, 74
keyboard language, 16
Service Pack, 68

zoomed video not supported, 56
working in comfort, 27

Y

Y2K, 16
Y-adapter (PS/2), 55

Z

zoomed video, 56