

---

# HP OmniBook Plug-In Modules



---

## User's Guide

---

## Notice

This manual and any examples contained herein are provided “as is” and are subject to change without notice. Hewlett-Packard Company makes no warranty of any kind with regard to this manual, including, but not limited to, the implied warranties of merchantability and fitness for a particular purpose. Hewlett-Packard Co. shall not be liable for any errors or for incidental or consequential damages in connection with the furnishing, performance, or use of this manual or the examples herein.

Consumer transactions in Australia and the United Kingdom: The above disclaimers and limitations shall not apply to Consumer transactions in Australia and the United Kingdom and shall not affect the statutory rights of Consumers.

© Copyright Hewlett-Packard Company 1997. All rights reserved. Reproduction, adaptation, or translation of this manual is prohibited without prior written permission of Hewlett-Packard Company, except as allowed under the copyright laws.

The programs that control these products are copyrighted and all rights are reserved. Reproduction, adaptation, or translation of those programs without prior written permission of Hewlett-Packard Co. is also prohibited.

Portions of the programs that control these products may also be copyrighted by Microsoft Corporation, SystemSoft Corp., Crystal Semiconductor Corporation, Phoenix, and Neo Magic. See the individual programs for additional copyright notices.

Microsoft, MS, MS-DOS, and Windows are registered trademarks of Microsoft Corporation.

For warranty information, see the *Support and Service* booklet.

Hewlett-Packard Company  
Mobile Computing Division  
19310 Pruneridge Ave.  
Cupertino, CA 95014, U.S.A.

---

## Edition History

Edition 1 ..... September 1997



This manual is printed on recycled paper.

---

# Contents

<b>1. Using OmniBook Plug-In Modules .....</b>	<b>1-5</b>
Replacing a Plug-In Accessory Module.....	1-7
To replace a plug-in module.....	1-7
Using the Floppy Drive .....	1-9
To install the floppy drive externally .....	1-9
To insert or eject a floppy disk .....	1-10
Using the CD-ROM Drive.....	1-11
To insert or remove a CD.....	1-11
To use the CD-ROM drive safely .....	1-12
To open the CD-ROM drive manually .....	1-12
Using the Zip Drive.....	1-13
To install the Zip drive software .....	1-13
To insert or eject a Zip disk .....	1-14
To eject a Zip disk manually.....	1-15
Using the Secondary Battery.....	1-16
To handle and store the battery safely .....	1-16
To maintain and preserve battery life.....	1-17
<b>2. Troubleshooting .....</b>	<b>1-19</b>
Solving Problems with Plug-In Accessories.....	1-21
Floppy disk drive problems .....	1-21
Zip drive problems .....	1-22
CD-ROM drive problems.....	1-22
Battery problems.....	1-22
<b>3. Specifications and Regulatory Information.....</b>	<b>1-25</b>
Hardware Specifications .....	1-27
Regulatory Information .....	1-28
U.S.A. ....	1-28
Canada .....	1-29
Japan .....	1-29
Declarations of Conformity.....	1-30



---

**Using OmniBook  
Plug-In Modules**

---

## Using OmniBook Plug-In Modules

The *OmniBook Plug-in Modules User's Guide* describes OmniBook plug-in accessory modules and shows you how to install and use them. For complete information about operating the OmniBook, consult the *OmniBook Reference Guide* and the online *User's Handbook*.

This manual explains how to

- ◆ Replace a plug-in module in the OmniBook.
- ◆ Use the floppy disk drive.
- ◆ Use the CD-ROM drive.
- ◆ Use the Zip drive.
- ◆ Use the secondary battery.

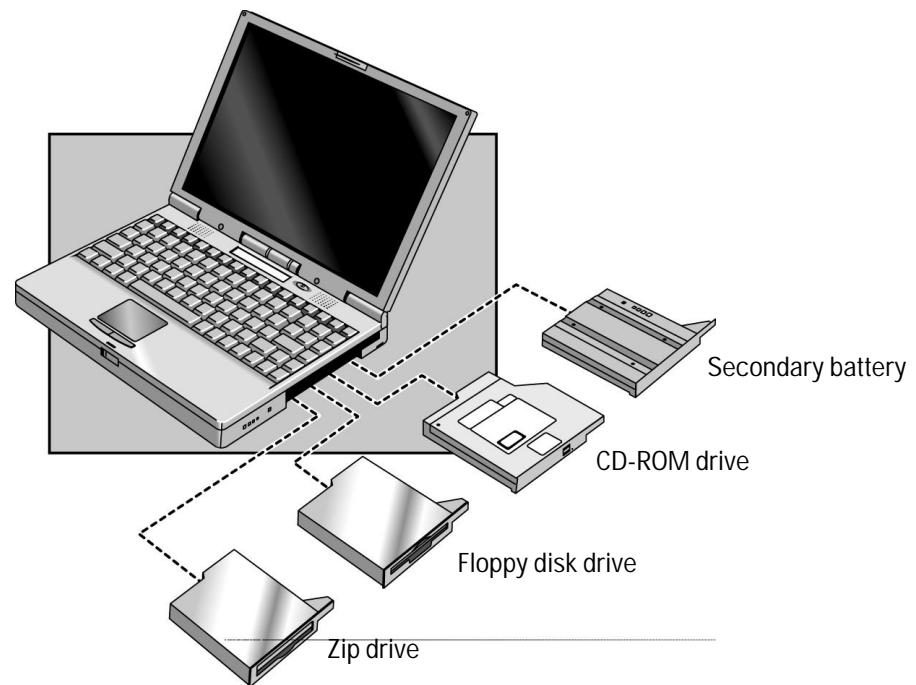

---

## Replacing a Plug-In Accessory Module

---

### Important

If you are inserting or removing a CD-ROM or Zip drive, turn the OmniBook off before removing or inserting the plug-in module (shut down the computer using the Start menu or press the power button for 4 or more seconds). This is not necessary if you are inserting or removing a floppy disk drive or secondary battery.

---

### To replace a plug-in module

1. From the Start menu, shut down Windows 95 (for CD-ROM drive or Zip drive only).
2. Slide the safety latch for the plug-in slot into its recess.
3. Slide *and hold* the release latch, then pull out the module, as shown.

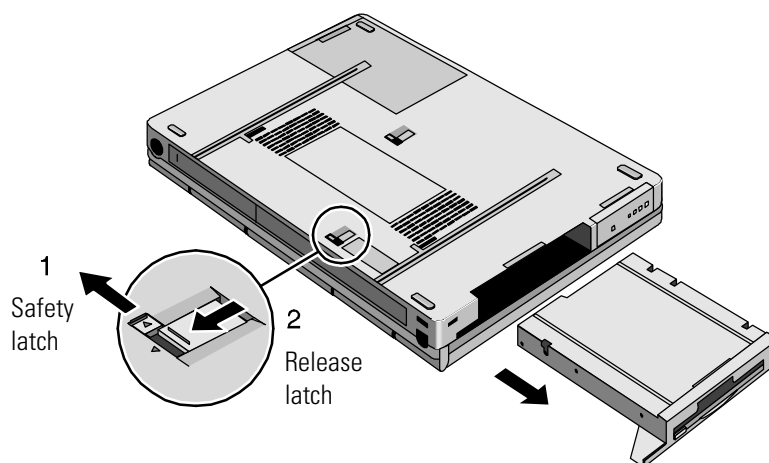

Using OmniBook Plug-In Modules  
Replacing a Plug-In Accessory Module

CAUTION

4. Slide the plug-in module into the OmniBook until it clicks into place.

Be sure the safety latch is open. Otherwise you could damage the module or your OmniBook.

5. Slide the safety latch back to its original position (in the direction of the arrow).

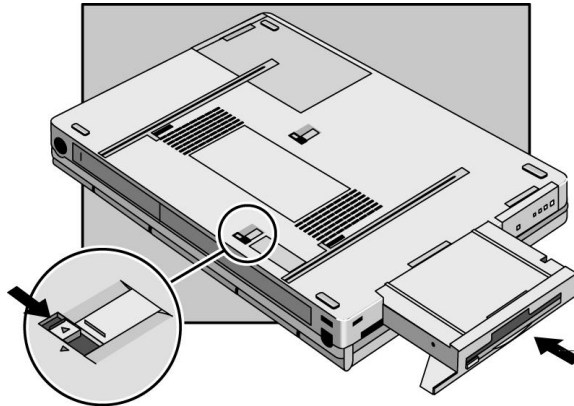



---

## Using the Floppy Drive

You can install the floppy drive in the plug-in module bay or attach it externally to the parallel port.

This section describes how to

- ◆ Install the floppy disk drive externally.
- ◆ Insert or eject a floppy disk.

---

### To install the floppy drive externally

- Connect the external floppy-drive cable to the OmniBook's parallel port.

If you remove the plug-in floppy drive and use it externally, you can use the module bay for another plug-in module, such as a CD-ROM drive, Zip drive, or secondary battery.

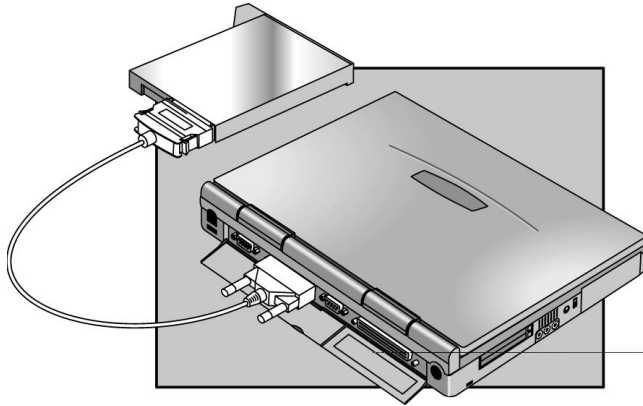

---

## To insert or eject a floppy disk

---

### CAUTION

---

Do not insert or remove a floppy disk while the OmniBook is actively reading or writing data. Otherwise, you could lose data or the OmniBook could stop responding.

1. Hold the disk with its face up, then slide it into the floppy drive slot until it clicks into place.
2. To remove the floppy disk, press the eject button on the front of the drive.

---

## Using the CD-ROM Drive

To use both the CD-ROM drive and the floppy disk drive, connect the floppy disk drive to the OmniBook's parallel port.

This section describes how to

- ◆ Insert or remove a CD.
- ◆ Use the CD-ROM drive safely.
- ◆ Open the CD-ROM drive manually.

---

### To insert or remove a CD

---

#### CAUTION

---

Do not insert or remove a CD while the OmniBook is actively reading data. Otherwise, the OmniBook could stop responding and you could lose data.

1. Press the button on the face of the CD-ROM drive.
  2. Place the CD into the drive (label facing up) and gently press down to seat the CD on the spindle.
- or-
- Remove the CD.
3. Close the door to the drive.

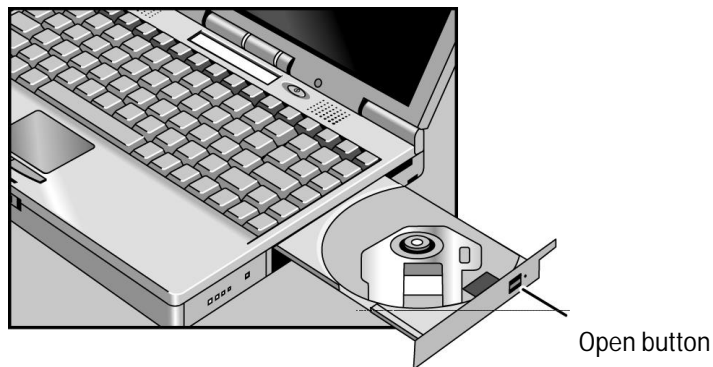

---

## To use the CD-ROM drive safely

- If the unit requires service, contact an authorized HP service center—see the *OmniBook Support and Service* booklet.
- Do not attempt to make any adjustment of the unit.
- Avoid direct exposure to the laser beam—do not open the unit.

CLASS 1 LASER PRODUCT  
LASER KLASSE 1

---

## To open the CD-ROM drive manually

If you lose power to the OmniBook, or if you've removed the CD-ROM module from the OmniBook, you can manually open the CD-ROM drive to remove a CD.

- Insert a paper clip into the recessed hole shown below.

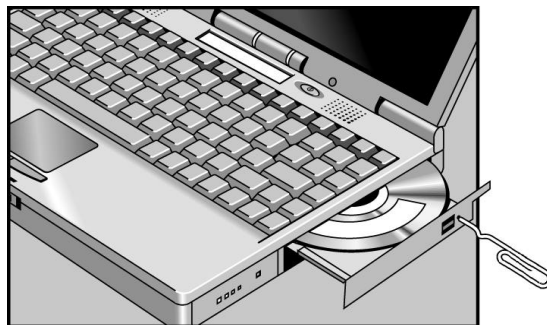

---

## Using the Zip Drive

To use both the Zip drive and the floppy disk drive, connect the floppy disk drive to the OmniBook's parallel port.

This section describes how to

- ◆ Install the drivers and software for the Zip drive.
- ◆ Insert or eject a zip disk.
- ◆ Eject a Zip disk manually.

---

### To install the Zip drive software

The Zip drive comes with a CD containing drivers and software for the Zip drive. Follow these steps to set up this software.

1. Set up a CD-ROM drive for your OmniBook. (The Zip drive does not have to be installed at this time.)
2. Insert the Zip CD in the CD-ROM drive.
3. Click Start, Run, then type *drive*:\install and click OK, where *drive* is the drive letter of the CD-ROM drive. For example, type d:\install if the CD-ROM is drive D. This installs the Zip software so it's ready whenever you insert the Zip drive.

To obtain the latest versions of Zip drivers and software, access the Iomega website at <http://www.iomega.com/>.

---

## To insert or eject a Zip disk

When the OmniBook is reading or writing data to the Zip drive, the Zip disk indicator appears on the OmniBook status panel (above the function keys).

---

### CAUTION

Always turn on power to the OmniBook before inserting a Zip disk. When you insert a Zip Disk, the green busy light will flash momentarily and go out. (If the light continues to blink slowly, push the disk eject button to eject the Zip disk, then insert it again.)

Do not insert or remove a Zip disk while the OmniBook is actively reading or writing data. Otherwise, the OmniBook could stop responding and you could lose data.

---

1. To insert the Zip disk, hold the disk with its face up and then gently insert it into the Zip drive.
2. To remove the Zip disk, gently press the eject button on the front of the Zip disk drive. Do not use excessive force. The green busy light blinks as the disk spins down. The drive takes a few seconds to eject the disk.

The Zip drive automatically ejects the disk when you shut down your OmniBook. Store all your Zip disks in their protective case when not in use.

---

## To eject a Zip disk manually

The OmniBook must be powered on for normal disk ejection from the Zip drive. If you need to remove a Zip disk from the drive when power is off, carefully push a straightened paper clip into the emergency eject hole located on the eject button.

---

### CAUTION

---

Use the manual disk eject procedure only when OmniBook power is off. Do not try to forcibly remove a Zip disk from the drive. If the disk does not eject immediately, repeat the manual disk eject procedure.

---

## Using the Secondary Battery

To increase the time you can work on battery power, you can install a secondary battery in the OmniBook's plug-in module bay.

The Battery gauge shows the combined charge level of the both the primary and secondary battery.

---

### To handle and store the battery safely

To safely use the battery, follow these instructions:

- To avoid risk of fire, burns, or damage to your battery pack, do not allow metal objects to touch the battery contacts.
- The battery pack is suitable for use only with compatible OmniBook models. Check the *Support and Service* booklet for your local HP contact.
- Do not disassemble. There are no serviceable parts inside.
- Handle a damaged or leaking lithium-ion battery with extreme care. If you come in contact with the electrolyte, wash the exposed area with soap and water. If it contacts the eye, flush the eye with water for 15 minutes and seek medical attention.
- Do not expose the battery pack to high storage temperatures (above 60 °C, 140 °F).
- When the battery is not in use, store it in the battery pouch provided.
- Do not dispose of the battery pack in fire or water.
- When discarding a battery pack, contact your local waste disposal provider regarding local restrictions on the disposal or recycling of batteries.
- To obtain a replacement battery, contact your local dealer or HP sales office.
- Do not charge the battery pack if the ambient temperature exceeds 45 °C (113 °F).



---

## To maintain and preserve battery life

To preserve the life of your battery, be sure to charge the battery regularly. In cases of long-term storage, the battery must be charged at 20-50% to save capacity loss by self-discharge and to avoid deterioration of battery performance.

In a discharge condition, the battery voltage decreases faster. Storage in a 100% charged condition can cause higher self-discharge and deterioration of discharge capacity—even after recharging compared to storage in a 20-50% charged condition.





---

**Troubleshooting**

---

## Troubleshooting



If you run into problems installing your OmniBook accessories, you can use the suggestions in this chapter to correct the problems.

If you have questions that this manual doesn't answer, you can

- If you have problems, see the problem-solving suggestions and references listed in the troubleshooting section of this manual, the OmniBook *Reference Guide*, and the online *User's Handbook*.
- Check with your computer system administrator, if you have one.
- Contact your dealer, or contact Hewlett-Packard—see the OmniBook *Support and Service* booklet or OmniBook Support in the online OmniBook Library.

---

## Solving Problems with Plug-In Accessories

If your OmniBook accessory doesn't seem to work properly, find the symptom below that matches your situation. Try the suggestions one at a time.

This section separates problems into the following categories:

- ◆ Floppy disk drive problems.
- ◆ CD-ROM drive problems.
- ◆ Zip drive problems
- ◆ Battery problems.

---

### Floppy disk drive problems

#### **If a floppy drive doesn't work**

- Remove and reinsert the floppy disk.
- Check the floppy drive cable connection.
- Try using an alternate connection (internal or external connection)
- Check to see that the floppy disk drive configuration is correct in the BIOS Setup utility. See the *OmniBook Reference Guide* for instructions on running the BIOS Setup utility.

#### **If the OmniBook doesn't boot successfully from the floppy disk drive**

- Check the floppy drive cable connection.
- Try using an alternate connection (internal or external connection).
- Run the BIOS Setup utility make sure that the floppy drive is the first boot device. See the *OmniBook Reference Guide* for instructions on running the BIOS Setup utility.
- Check if the floppy disk is a bootable disk.

---

## Zip drive problems

### **If a Zip drive doesn't work**

- Remove and reinsert the Zip disk.
- Remove and insert the Zip drive again.
- Restart the OmniBook.

---

## CD-ROM drive problems

### **If the CD-ROM drive stops responding**

- Restart the OmniBook.
- If restarting the OmniBook does not solve the problem, remove and insert the CD-ROM drive again.

### **If you cannot boot from a CD in the CD-ROM drive**

- Check that the CD is bootable.
- Remove and insert the CD-ROM drive again.
- Restart the OmniBook.
- Run the BIOS Setup utility to make sure that the CD-ROM drive is the first boot device. See the OmniBook *Reference Guide* for instructions on running the BIOS Setup utility.

---

## Battery problems

### **If the OmniBook doesn't turn on with a fresh battery**

- The new battery pack may be low. Plug in the ac adapter.

- If nothing happens, press the blue power button for four seconds, then wait 10 seconds and press the power button again.

**If the battery pack doesn't charge or stops charging**

- Check that the battery is fully installed and locked in place with the safety latch.
- Shut down the OmniBook and remove the battery, then check that the battery contacts are clean. Make sure that the ac adapter cables are fully plugged in.
- Move the OmniBook away from any nearby heat source. Unplug the ac adapter and allow the battery to cool down. An elevated battery temperature prevents charging.

**If the battery runs down too fast**

- If the operating time has gotten shorter and the battery pack is more than a year or two old, you may need a new battery.

**If the OmniBook turns off immediately after it turns on**

- Battery power is probably extremely low. Plug in the ac adapter, or turn off the OmniBook and insert a fresh battery.

**If the OmniBook stops responding**

- Try waiting a few minutes for a response. If after a few minutes there is no response, press CTRL+ALT+DEL to close the non-responding application.
- If nothing happens, press the blue power button for 4 seconds., After the computer turns off, press the power button again.
- Use a paper clip to depress the reset button of the back of the unit, then press the blue power button.





---

**Specifications and Regulatory  
Information**

---

## Specifications and Regulatory Information

Your OmniBook accessories are designed to provide trouble-free operation. The following suggestions can help you while working with your OmniBook:

- ◆ Observe the temperature limits and other specifications listed in the next section.
- ◆ If you think your OmniBook might need repair service, see the warranty and service information in the *Support and Service* booklet.

### **To contact Hewlett-Packard**

If you have questions that the OmniBook manuals don't answer (even after looking in the contents and index), you can contact Hewlett-Packard at the address or phone number listed in the *Support and Service* booklet or in OmniBook Support in the online OmniBook Library.

Please have your OmniBook with you when you call for support.

---

## Hardware Specifications

Floppy disk drive	Modular 3.5-inch 1.44-MB floppy disk drive with parallel cable for internal or external use.
Zip drive	Modular 3.5-inch 100-MB Zip drive.
Hard disk drive	Modular 2.5-inch IDE drive. Available capacities: 2.1 GB and 4.0 GB.
CD-ROM drive	Modular 20x maximum speed drive. Photo-CD and CD-plus multi-session specification compliant, multimedia PC-3 specification compliant, supports 20x rotational speed, 20x sampling and digital filter for CD audio, software and manual eject.
Lithium battery	Capacity: 39 watt-hours Charging time: 4 hours with unit on, 1.5 hours with unit off or suspended Operating hours: 2-3.5 hours typical (varies with type of usage) for one battery.
Environmental Limits	Operating temperature: 5 to 35 °C (41 to 95 °F), Operating humidity: 20 to 90 percent (5 to 35 °C). Storage temperature: -20 to 50 °C (-40 to 122 °F).

---

## Regulatory Information

This section presents information that shows how the OmniBook plug-in modules comply with regulations in certain regions. Any modifications to the OmniBook or plug-in modules not expressly approved by Hewlett-Packard could void the authority to operate the OmniBook in these regions.

---

### U.S.A.

The HP F1384A floppy drive generates and uses radio frequency energy and may interfere with radio and television reception. The floppy drive complies with the limits for a Class B computing device as specified in Part 15 of FCC Rules, which provide reasonable protection against such interference in a residential installation. In the unlikely event that there is interference to radio or television reception (which can be determined by removing the unit's batteries and ac adapter), try the following:

- Reorienting or relocating the receiving antenna.
- Relocating the floppy drive with respect to the receiver.
- Connecting the OmniBook ac adapter to another power outlet.

### Connections to Peripheral Devices

To maintain compliance with FCC Rules and Regulations, use properly shielded cables with this device.

For more information, consult your dealer, an experienced radio/television technician, or the following booklet, prepared by the Federal Communications Commission: How to Identify and Resolve Radio-TV Interference Problems. This booklet is available from the U.S. Government Printing Office, Washington, DC 20402, Stock Number 004-000-00345-4. At the first printing of this manual, the telephone number was (202) 512-1800.

### Declaration of Conformity

Responsible Party: Hewlett-Packard Company  
Manager of Corporate Product Regulations  
3000 Hanover Street  
Palo Alto, CA 94304  
(415) 857-1501  
declares that the product(s)  
Trade name: Hewlett-Packard Company  
Product name: F1384A floppy drive  
Complies with Part 15 of the FCC Rules. Operation is subject to the following two conditions:  
1. This device may not cause harmful interference, and  
2. This device must accept any interference received, including interference that may cause undesired operation.

---

### Canada

This digital apparatus does not exceed the Class B limits for radio noise emissions from digital apparatus as set out in the radio interference regulations of the Canadian Department of Communications.

Le présent appareil numérique n'émet pas de bruits radioélectriques dépassant les limites applicables aux appareils numériques de Classe B prescrites dans le règlement sur le brouillage radioélectrique édicté par le Ministère des Communications du Canada.

---

### Japan

この装置は、情報処理装置等電波障害自主規制協議会（VCCI）の基準に基づく第二種情報技術装置です。この装置は、家庭環境で使用することを目的としていますが、この装置がラジオやテレビジョン受信機に近接して使用されると、受信障害を引き起こすことがあります。

取扱説明書に従って正しい取り扱いをして下さい。

---

## Declarations of Conformity

Products sold in Europe by Hewlett-Packard and its authorized dealers meet the specifications listed below.

### **Declaration of Conformity (according to ISO/IEC Guide 22 and EN 45014)**

Manufacturer:	Hewlett-Packard Company
Address:	Hewlett-Packard Co. Mobile Computing Division 19310 Pruneridge Ave. Cupertino, CA 95014
Product name:	declares that the following products HP F1384A internal/external floppy disk drive
Options:	All
Safety:	conforms to the following product specifications
EMC:	IEC 950:1991+A1,A2 / EN 60950 (1992)+A1,A2 CISPR 22:1993 / EN 55022 (1994): Class B [1 ] EN 50082-1:1992 IEC 1000-4-2:1995 / prEN 55024-2 (1992): 4kV CD, 8kV AD IEC 1000-4-3:1995 / prEN 55024-3 (1991): 3V/m IEC 1000-4-4:1995 / prEN 55024-4 (1992): 0.5 kV signal lines, 1.0kV power lines
Supplementary Information:	The product herewith complies with the requirements of the Low Voltage Directive 73/23/EEC and the EMC Directive 89/336/EEC and carries the CE mark accordingly.  The HP F1377A ac adapter used with this product is disconnected from the power by unplugging the power cord from the power outlet or from the ac adapter. Therefore, the power outlet should be located close to the product and be easily accessible.

[1] The product was tested in a typical configuration with Hewlett-Packard personal computer peripherals.

Quality Department  
Hewlett-Packard Company  
Mobile Computing Division

**Declaration of Conformity (according to ISO/IEC Guide 22 and EN 45014)**

Manufacturer: Hewlett-Packard Company  
Address: Hewlett-Packard Co.  
Mobile Computing Division  
19310 Pruneridge Ave.  
Cupertino, CA 95014  
declares that the following products

Product name: HP F1387A CD-ROM drive  
Options: All  
conforms to the following product specifications

Safety: IEC 950:1991+A1,A2 / EN 60950 (1992)+A1,A2  
IEC 825/IEC 825-1 (EN60825/EN60825-1:1994):class1

EMC: CISPR 22:1993 / EN 55022 (1994): Class B [1 ]  
EN 50082-1:1992  
IEC 1000-4-2:1995 / prEN 55024-2 (1992): 4kV CD, 8kV AD  
IEC 1000-4-3:1995 / prEN 55024-3 (1991): 3V/m  
IEC 1000-4-4:1995 / prEN 55024-4 (1992): 0.5 kV signal lines, 1.0kV  
power lines

Supplementary Information: The product herewith complies with the requirements of the Low Voltage Directive 73/23/EEC and the EMC Directive 89/336/EEC and carries the CE mark accordingly.

The HP F1377A ac adapter used with this product is disconnected from the power by unplugging the power cord from the power outlet or from the ac adapter. Therefore, the power outlet should be located close to the product and be easily accessible.

[1] The product was tested in a typical configuration with Hewlett-Packard personal computer peripherals.

Quality Department  
Hewlett-Packard Company  
Mobile Computing Division

Specifications and Regulatory Information  
Regulatory Information

**Declaration of Conformity (according to ISO/IEC Guide 22 and EN 45014)**

Manufacturer: Hewlett-Packard Company  
Address: Hewlett-Packard Co.  
Mobile Computing Division  
19310 Pruneridge Ave.  
Cupertino, CA 95014  
declares that the following products

Product name: HP F1388A Zip drive  
Options: All  
conforms to the following product specifications

Safety: IEC 950:1991+A1,A2 / EN 60950 (1992)+A1,A2  
EMC: CISPR 22:1993 / EN 55022 (1994): Class B [1 ]  
EN 50082-1:1992  
IEC 1000-4-2:1995 / prEN 55024-2 (1992): 4kV CD, 8kV AD  
IEC 1000-4-3:1995 / prEN 55024-3 (1991): 3V/m  
IEC 1000-4-4:1995 / prEN 55024-4 (1992): 0.5 kV signal lines, 1.0kV  
power lines

Supplementary Information: The product herewith complies with the requirements of the Low Voltage Directive 73/23/EEC and the EMC Directive 89/336/EEC and carries the CE mark accordingly.

The HP F1377A ac adapter used with this product is disconnected from the power by unplugging the power cord from the power outlet or from the ac adapter. Therefore, the power outlet should be located close to the product and be easily accessible.

[1] The product was tested in a typical configuration with Hewlett-Packard personal computer peripherals.

Quality Department  
Hewlett-Packard Company  
Mobile Computing Division