HP OmniBook 2100/3100

Reference Guide

Notice

This manual and any examples contained herein are provided “as is” and are subject to change without notice. Hewlett-Packard Company makes no warranty of any kind with regard to this manual, including, but not limited to, the implied warranties of merchantability and fitness for a particular purpose. Hewlett-Packard Co. shall not be liable for any errors or for incidental or consequential damages in connection with the furnishing, performance, or use of this manual or the examples herein.

Consumer transactions in Australia and the United Kingdom: The above disclaimers and limitations shall not apply to Consumer transactions in Australia and the United Kingdom and shall not affect the statutory rights of Consumers.

© Copyright Hewlett-Packard Company 1998. All rights reserved. Reproduction, adaptation, or translation of this manual is prohibited without prior written permission of Hewlett-Packard Company, except as allowed under the copyright laws.

The programs that control this product are copyrighted and all rights are reserved. Reproduction, adaptation, or translation of those programs without prior written permission of Hewlett-Packard Co. is also prohibited.

Portions of the programs that control this product may also be copyrighted by Microsoft Corporation, SystemSoft Corp., Crystal Semiconductor Corporation, Phoenix Technologies, Ltd., and NeoMagic Corporation. See the individual programs for additional copyright notices.

Microsoft, MS, MS-DOS, and Windows are registered trademarks of Microsoft Corporation. Pentium and the Intel Inside logo are U.S. registered trademarks and MMX is a U.S. trademark of Intel Corporation.

For warranty information, see the *Support and Service* booklet.

Hewlett-Packard Company
Mobile Computing Division
19310 Pruneridge Ave.
Cupertino, CA 95014

HP Software Product License Agreement

Your HP OmniBook PC contains factory-installed software programs. Please read the Software License Agreement before proceeding.

Carefully read this License Agreement before proceeding to operate this equipment. Rights in the software are offered only on the condition that the customer agrees to all terms and conditions of the License Agreement. Proceeding to operate the equipment indicates your acceptance of these terms and conditions. If you do not agree with the terms of the License Agreement, you must now either remove the software from your hard disk drive and destroy the master diskettes, or return the complete computer and software for a full refund.

Proceeding with configuration signifies your acceptance of the License Terms.

Unless otherwise stated below, this HP Software Product License Agreement shall govern the use of all software that is provided to you, the customer, as part of the HP computer product. It shall supersede any non-HP software license terms that may be found online, or in any documentation or other materials contained in the computer product packaging.

Note: Operating System Software by Microsoft is licensed to you under the Microsoft End User License Agreement (EULA) contained in the Microsoft documentation.

The following License Terms govern the use of the software:

Use. Customer may use the software on any one computer. Customer may not network the software or otherwise use it on more than one computer. Customer may not reverse assemble or decompile the software unless authorized by law.

Copies and Adaptations. Customer may make copies or adaptations of the software (a) for archival purposes or (b) when copying or adaptation is an essential step in the use of the software with a computer so long as the copies and adaptations are used in no other manner.

Ownership. Customer agrees that he/she does not have any title or ownership of the software, other than ownership of the physical media. Customer acknowledges and agrees that the software is copyrighted and protected under the copyright laws. Customer acknowledges and agrees that the software may have been developed by a third party software supplier named in the copyright notices included with the software, who shall be authorized to hold the Customer responsible for any copyright infringement or violation of this Agreement.

Product Recovery CD-ROM. If your computer was shipped with a product recovery CD-ROM: (i) The product recovery CD-ROM and/or support utility software may only be used for restoring the hard disk of the HP computer with which the product recovery CD-ROM was originally provided. (ii) The use of any operating system

software by Microsoft contained in any such product recovery CD-ROM shall be governed by the Microsoft End User License Agreement (EULA).

Transfer of Rights in Software. Customer may transfer rights in the software to a third party only as part of the transfer of all rights and only if Customer obtains the prior agreement of the third party to be bound by the terms of this License Agreement. Upon such a transfer, Customer agrees that his/her rights in the software are terminated and that he/she will either destroy his/her copies and adaptations or deliver them to the third party.

Sublicensing and Distribution. Customer may not lease, sublicense the software or distribute copies or adaptations of the software to the public in physical media or by telecommunication without the prior written consent of Hewlett-Packard.

Termination. Hewlett-Packard may terminate this software license for failure to comply with any of these terms provided Hewlett-Packard has requested Customer to cure the failure and Customer has failed to do so within thirty (30) days of such notice.

Updates And Upgrades. Customer agrees that the software does not include updates and upgrades which may be available from Hewlett-Packard under a separate support agreement.

Export Clause. Customer agrees not to export or re-export the software or any copy or adaptation in violation of the U.S. Export Administration regulations or other applicable regulation.

U.S. Government Restricted Rights. Use, duplication, or disclosure by the U.S. Government is subject to restrictions as set forth in subparagraph (c)(1)(ii) of the Rights in Technical Data and Computer Software clause in DFARS 252.227-7013. Hewlett-Packard Company, 3000 Hanover Street, Palo Alto, CA 94304 U.S.A. Rights for non-DOD U.S. Government Departments and Agencies are as set forth in FAR 52.227-19(c)(1,2).

Edition History

Edition 1 June 1998



This manual is printed on recycled paper

Contents

1. Introducing the OmniBook	1-1
Taking Inventory	1-3
Included in the OmniBook 2100/3100 box	1-3
To buy OmniBook accessories	1-4
OmniBook features	1-5
Setting Up Windows	1-8
To set up the OmniBook for the first time	1-9
Configuring the OmniBook with the BIOS Setup utility	1-10
To run the BIOS Setup utility	1-10
Configuring the OmniBook with TopTools	1-16
To install TopTools	1-16
To run TopTools	1-16
To get more information about TopTools	1-16
2. Operating the OmniBook	2-1
Starting and Stopping the OmniBook	2-3
To start and stop the OmniBook	2-3
To reset the OmniBook	2-4
Using the OmniBook Touch Pad	2-5
To use the touch pad	2-5
To configure the touch pad	2-6
Using the OmniBook Display	2-7
To adjust the display brightness and contrast	2-7
To extend the life of the display	2-7
Adjusting the Audio System	2-8
To adjust the volume manually	2-8
To adjust the volume in Windows	2-8
Using the OmniBook Keyboard	2-9
To use the Fn hot keys	2-10
To use the Windows keys	2-11
To use the embedded keypad	2-11
To use the ALT GR key	2-12
Checking the Status of the OmniBook	2-13
To interpret the status lights	2-13
To interpret the status panel indicators	2-14
Protecting the OmniBook	2-16
To set or change a password	2-17
To delete a password	2-18

To install McAfee VirusScan	2-18
To attach a security cable	2-19
To set PC identification	2-20
To enable hard disk drive lock	2-20
3. Managing Battery Power	3-1
Monitoring Battery Power	3-3
To check the battery status	3-4
To respond to a low-battery warning	3-5
To recharge a battery	3-5
To replace the main battery	3-7
To install a secondary battery	3-8
Conserving Battery Power	3-9
To optimize battery life	3-9
To set time-outs	3-10
To get the most from your battery	3-11
4. Making Connections	4-1
Using OmniBook Plug-In Modules	4-3
To replace a plug-in module	4-4
To connect the floppy disk drive externally	4-5
To insert or eject a floppy disk	4-5
To insert or remove a CD	4-6
To insert or eject a Zip disk	4-7
Connecting External Devices	4-8
To identify the external ports	4-9
To connect an external display	4-10
To enable the built-in and external displays	4-10
To change display settings in the BIOS Setup utility	4-10
To connect a parallel device	4-11
To connect a serial device	4-11
To connect an external keyboard or PS/2 mouse	4-11
To connect USB devices	4-12
To connect audio devices	4-13
To make an infrared connection	4-14
Using PC Cards	4-15
To insert a PC Card	4-15
To remove a PC Card	4-16
To find tested PC Cards	4-16
Using Docking Products	4-17
To install a docking tray	4-17
To dock the OmniBook	4-18
To undock the OmniBook	4-19

5. Expanding the OmniBook	5-1
Installing a Hard Disk Drive	5-3
To replace the hard disk drive	5-3
To replace the hard disk drive holder	5-4
To create a Hibernate partition	5-5
Installing a RAM Expansion Module	5-6
To install a RAM expansion module	5-7
To remove a RAM expansion module	5-8
6. Using the <i>Recovery CD</i>	6-1
Recovering a Factory Software Installation	6-3
To recover the Windows 95 factory installation	6-4
To recover the Windows NT factory installation	6-5
Installing Retail Windows 95	6-6
To install a retail version of Windows 95	6-7
To install video support for retail Windows 95	6-9
To install audio support for retail Windows 95	6-10
To install PC Card support for retail Windows 95	6-11
To install infrared support for retail Windows 95	6-12
To install touch pad support for retail Windows 95	6-13
To disable automatic CD-ROM detection	6-14
Installing Retail Windows NT 4.0	6-15
To install a retail version of Windows NT 4.0	6-16
To install Service Pack 3 for retail Windows NT 4.0	6-17
To install video support for retail Windows NT 4.0	6-18
To install audio support for retail Windows NT 4.0	6-19
To install APM for Windows NT 4.0	6-20
To install Card Executive 2.x for retail Windows NT 4.0	6-21
To disable automatic CD-ROM detection	6-22
Recovering OmniBook Files	6-23
To install the online <i>User's Handbook</i>	6-23
To replace a damaged <i>Recovery CD</i>	6-23
To update the OmniBook BIOS	6-24
7. Troubleshooting	7-1
Solving Problems	7-3
Accessory Module Problems	7-3
Audio Problems	7-5
Display Problems	7-6
Hard Disk Drive Problems	7-7
Infrared Problems	7-8
Keyboard and Pointing Device Problems	7-9
Memory Problems	7-10
PC Card (PCMCIA) Problems	7-11

Performance Problems	7-12
Power and Battery Problems	7-13
Printing Problems	7-15
Serial, Parallel, and USB Problems	7-16
Startup Problems	7-17
Testing the Operation	7-18
To create a diagnostic floppy disk	7-18
To run the diagnostic test	7-19
8. Specifications and Regulatory Information	8-1
Hardware Specifications	8-3
Software System Resources	8-6
Safety Information	8-8
Regulatory Information	8-11
U.S.A.	8-11
Canada	8-12
Japan	8-12
Europe	8-13

Introducing the OmniBook

Introducing the OmniBook

Congratulations! Your OmniBook sets a new standard in personal computing. Although it's compact and easy to carry, the OmniBook is infused with the quality and attention to detail that are the hallmark of Hewlett-Packard.

The OmniBook *Quick Start* sheet shows how to get your OmniBook up and running quickly. This *Reference Guide* shows how to set up and operate the OmniBook and it also shows what to do if you run into trouble.

This table lists other sources of supplementary information about OmniBook products.

Source	Address or Number
Online <i>User's Handbook</i>	This introduces the OmniBook and shows you the OmniBook basics. It also contains troubleshooting information (Start, Programs, OmniBook Library).
Online <i>OmniBook Notes</i>	For late-breaking information available after the manual print date, see OmniBook Notes (Start, Programs, OmniBook Library).
The introductory Microsoft manual for Windows 95 or Windows NT.	This ships with your OmniBook and contains information about using the standard features of Windows 95 or Windows NT 4.0.
HP website	http://www.hp.com/omnibook (http://www2.hp.com/omnibook , European mirror)
<i>Corporate Evaluator's Guide</i>	The provides information about installing alternate operating systems, as well as how to configure the OmniBook in a corporate, networked environment. Located at the HP external website.
HP Support Assist CD-ROM	See the <i>Support and Service</i> booklet for telephone numbers.

Taking Inventory

The HP OmniBook 2100/3100 represents a new category of HP notebook computers featuring the latest mobile technologies available. It uses high-speed Intel Pentium and Pentium II processors with MMX technology, large TFT and DSTN displays, and high-capacity hard drives.

This chapter describes

- ◆ What's included in the OmniBook shipment.
- ◆ Available OmniBook accessories.
- ◆ Description of OmniBook features.

Included in the OmniBook 2100/3100 box

- HP OmniBook 2100 or OmniBook 3100.
- Floppy disk drive, installed in OmniBook (HP F1384A).
- 24× CD-ROM drive (HP F1587A).
- AC adapter (HP F1454A) and power cord.
- Main battery, nickel metal hydride (HP F1589A) or lithium ion (HP F1382A).
- This OmniBook *Reference Guide*.
- Quick Start sheet.
- *Support and Service* booklet.
- *Working in Comfort* booklet.
- List of optional OmniBook accessories.
- OmniBook *Recovery CD*, which includes Windows recovery, operating system drivers, and online *User's Handbook*.
- Microsoft Windows 95 manual and CD.

–or–

Microsoft Windows NT 4.0 manual.

To buy OmniBook accessories

Buy OmniBook accessories online! For the latest accessories and options, visit us at <http://www.hp.com/omnibook>. As new accessories become available, you'll find them listed here.

At the time of this printing, HP offers a variety of docking solutions and the following accessories and plug-in modules:

- Docking system and monitor stand (HP F1477A).
- Mini dock (HP F1452A).
- Port replicator (HP F1451A).
- 24 × CD-ROM drive (HP F1587A).
- Floppy disk drive and external cable (HP F1384A).
- Zip drive (HP F1388A).
- Secondary battery (HP F1383A).
- PC Cards.
- SmartCard.
- Auto / airline adapter.
- OmniBook carrying case.

OmniBook features

OmniBook—Front View

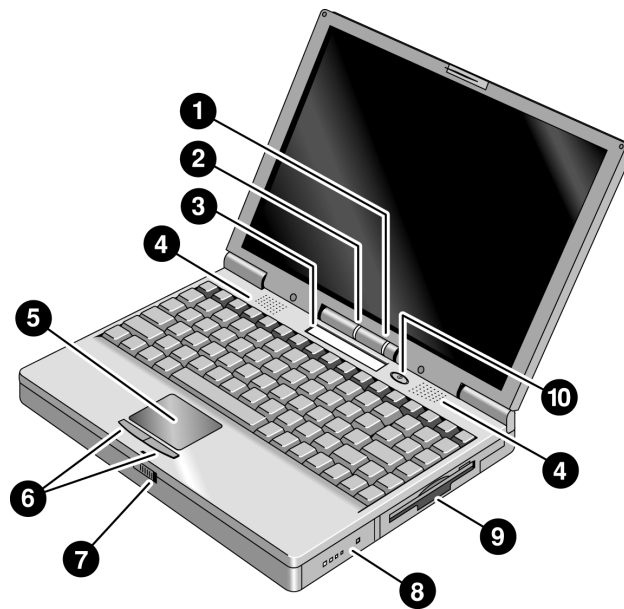

1. Power status light.
2. Built-in microphone.
3. Status panel.
4. Built-in speakers.
5. Touch pad (pointing device).
6. Click buttons.
7. Latch to open and close the OmniBook.
8. Main battery module.
9. Plug-in module bay (can contain floppy disk drive, CD-ROM drive, Zip drive, or secondary battery).
10. Blue power button (suspends or shuts down the OmniBook).

Introducing the OmniBook
Taking Inventory

OmniBook—Side View

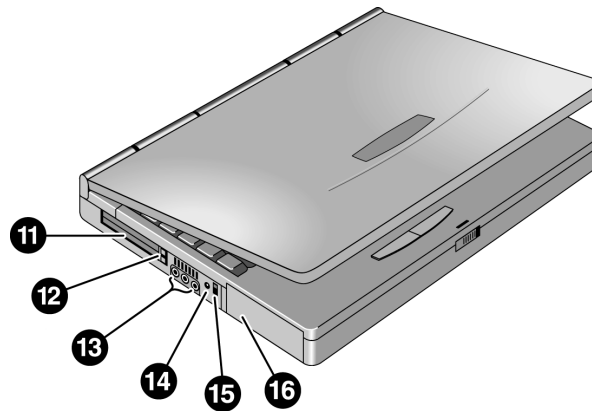

- 11. PC Card slots (upper and lower). Accepts two Type II cards or one Type III card.
- 12. PC Card eject buttons (upper and lower PC Card slots).
- 13. Audio jacks (left to right): audio line-in, external microphone, audio line-out.
- 14. AC adapter jack.
- 15. Kensington lock slot (security connector).
- 16. Hard disk drive.

OmniBook—Rear View

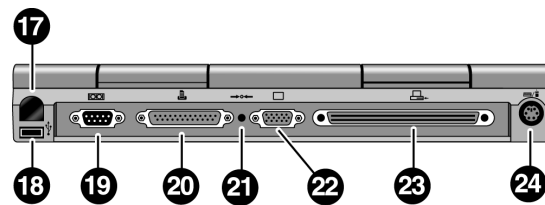

17. Infrared port. Use this port for wireless data transmission between the OmniBook and another computer or a printer with an infrared port. You must install infrared drivers. Windows NT 4.0 does not support infrared communication.
18. Universal Serial Bus port (USB). Windows NT 4.0 does not support USB.
19. Serial port (COM1). Use this port for a serial mouse, a modem, or a serial printer.
20. Parallel port (LPT1). Use this port for a parallel printer.
21. System-off button (to shut down the OmniBook).
22. External monitor port.
23. Docking port.
24. PS/2 keyboard or PS/2 mouse port. Supports a Y adapter for both keyboard and mouse.

Setting Up Windows

The OmniBook has either Windows 95 or Windows NT 4.0 factory-installed on the hard disk drive. When your OmniBook starts up the first time, it takes you through a series of setup screens, including installation of the operating system.

This section describes how to set up the OmniBook with the factory-installed Windows operating system.

- ◆ Setting up the OmniBook for the first time.

To set up the OmniBook for the first time

CAUTION

Use only the HP adapter model F1454A with this product. Using any other ac adapter could damage the OmniBook and may void your warranty. Refer to the warranty statement for your product.

1. Connect the power cord to the ac adapter, then plug the cord into an ac outlet. The indicator light on the ac adapter shines when powered.
2. Connect the ac adapter to the OmniBook's left side, as shown.

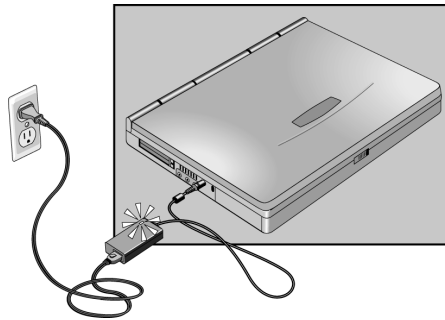

3. Press the blue power button.
The Windows 95 or Windows NT Setup program starts automatically.
4. Follow the instructions as they appear on the screen.
During setup, you will be prompted to accept the License Agreement and enter the Product ID (printed on the Certificate of Authenticity on the Microsoft Windows manual). If you are prompted to set up a user account and password, you can either set up the account, or press ESC to skip this step.

Note

If you installed Windows NT 4.0, see page 6-20 to install Advanced Power Management (APM).

Configuring the OmniBook with the BIOS Setup utility

The BIOS (Basic Input and Output System) Setup utility is a menu-driven utility that enables you to make changes to the system configuration and tailor the operation of your OmniBook to your individual work needs.

The settings made in the BIOS Setup utility generally control the hardware and consequently have a fundamental effect on how the OmniBook operates.

This section describes the BIOS Setup utility menus and options in detail.

To run the BIOS Setup utility

1. Close all applications.
2. From the Start menu, click Shut Down, Restart the Computer.
3. When you see the HP logo, press F2 to enter the BIOS Setup utility.
4. Pointing devices are not active in the BIOS Setup utility. Press the RIGHT and LEFT arrow keys to move among menus. Press the DOWN and UP arrow keys to move among parameters in a menu. Press F5 or F6 to move through values for the current parameter or press ENTER to change a setting. See the following tables for more information.
5. After you select the options you want, press F10 or use the Exit menu to exit the BIOS Setup utility.

If the settings cause a conflict between devices during reboot, the system prompts you to run BIOS Setup and marks the conflicting settings.

Introducing the OmniBook
Configuring the OmniBook with the BIOS Setup utility

Main Menu		Default
Language	Sets the language for this utility and for BIOS messages.	Same as operating system.
BIOS Revision	Shows the current BIOS version.	Detected automatically.
System Time	Sets the time using 24-hour format. Values set take effect immediately.	
System Date	Sets the date using dd/mm/yy format (except English, which is mm/dd/yy format).	
Floppy Drive	Sets the floppy drive type.	Floppy disk drive type detected and set automatically.
Hard Disk	Sets the hard disk drive type and various parameters.	Hard disk drive detected and set automatically.
Quiet Boot	When enabled, hides summary of power-on self-test and messages during boot.	Enabled
Video Display Device	Sets whether the built-in display automatically detects and switches to an external display.	Auto
System Memory	Shows the system memory size.	640KB
Extended Memory	Shows the extended memory size.	Detected automatically.
* Setting Video Display Device to Both will prevent the OmniBook from suspending when you close the lid.		

Configuring the OmniBook with the BIOS Setup utility

System Devices Menu		Default
External Fn Key	Sets whether left-CTRL + left-ALT on an external keyboard is interpreted as the Fn key.	Enabled
IDE Controller	Enables the primary (hard drive) and secondary (optional CD-ROM drive) controllers.	Both
FDD Controller	Enables the floppy disk drive.	Enabled
Serial Port	Sets how the BIOS configures the serial port (user specified or automatic).	Enabled
Base I/O address	Sets the I/O address and interrupt.	3F8h, IRQ4
Infrared Port	Sets how the BIOS configures the infrared port (user specified or automatic).	Disabled
Mode	Sets the hardware to support SIR (Standard IR), ASK IR (amplitude shift keyed IR), or FIR (Fast IR) infrared communications. (Driver installation required.)	SIR
Base I/O address	Sets the I/O address and interrupt.	2F8h, IRQ3
DMA channel	For Fast Ir mode, sets the DMA channel.	DMA3
Parallel Port	Sets how the BIOS configures the parallel port (specified or automatic).	Enabled
Mode	Sets the port to normal, bi-directional, EPP, or ECP.	ECP
Base I/O address	Sets the I/O address.	378h
Interrupt	Sets the interrupt.	IRQ7
DMA channel	For ECP mode, sets the DMA channel.	DMA3
Audio	Sets how the BIOS configures the audio system (specified or automatic).	Enabled
SB I/O address	Sets the Sound Blaster I/O address.	220h

Introducing the OmniBook
Configuring the OmniBook with the BIOS Setup utility

WSS I/O address	Sets the Windows Sound System I/O address.	530h
AdLib I/O address	Sets the AdLib synthesizer I/O address.	388h
Interrupt	Sets the interrupt.	IRQ5
1st DMA channel	Sets the DMA channel for playback.	DMA1
2nd DMA channel	Sets the DMA channel for recording.	DMA0

Security Menu		Default
User Password Is	Shows if a user password is set. You must set an administrator password before you can set a user password.	Clear
Administrator Password Is	Shows if an administrator password is set.	Clear
Set User Password	Press ENTER to set, change, or clear user password. Password length can be no longer than 8 characters, 0-9, A-Z.	
Set Administrator Password	Press ENTER to set, change, or clear administrator password. This password protects BIOS Setup settings.	
Password Required To		
Boot	Sets whether a user password is required when the computer boots.	Enabled
Resume*	Sets whether a user password is required when resuming from a suspended state.	Enabled
Undock*	Sets whether a user password is required when undocking the OmniBook.	Disabled
Hard Disk Drive Lock	Encodes the current user password (or administrator password if that is the only password set), on the hard disk drive.	Disabled
Floppy Boot	Sets whether the floppy drive is a boot device.	Enabled
* Resume and Undock options are available only if Boot option is enabled.		

Configuring the OmniBook with the BIOS Setup utility

Power Menu		Default
Power Management Mode	Disables time-outs, selects a combination of time-outs, or allows customized time-outs.	Max Power Savings
Smart CPU Mode	Enables automatic CPU power savings. Absence of keyboard, mouse, and hard disk activity could cause slower CPU response.	Off
Standby Time-out	Sets the period of inactivity after which the computer goes from On to Standby power mode.	2 minutes
Suspend Time-out	Sets the period of inactivity after which the computer goes from Standby to Suspend power mode. (Skips Standby mode if that time-out is disabled.)	4 minutes
Hibernate Time-out	Sets whether the computer goes from Suspend to Hibernate power mode after the indicated period of inactivity. (Skips Suspend mode if that time-out is disabled.)	4 hours
Hard Disk Time-out	Sets the period of hard disk inactivity after which the hard disk stops spinning.	2 minutes
Time-out on AC	Sets whether power management time-outs occur while the ac adapter is connected.	Disabled
Power Button Mode	Sets the action of the blue power button when pressed for less than 4 seconds.	Suspend
Resume on Modem Ring	Sets whether the system resumes from Suspend if a ring signal is received.	Enabled
Resume on Time of Day	Sets whether the system resumes from Suspend at a defined time of day.	Disabled
Resume Time	Sets the 24-hour time when the system resumes from Suspend if enabled.	00:00:00
Auto Suspend on Undock	Sets whether the OmniBook suspends after undocking.	When Lid Closed

Introducing the OmniBook
Configuring the OmniBook with the BIOS Setup utility

Boot Menu

Default

Diskette Drive Hard Drive CD-ROM Drive	Shows the order of boot devices. Move the entries to change the order.	1. Diskette drive 2. Hard drive 3. CD-ROM drive
--	--	---

Exit Menu

Save Changes and Exit	Saves Setup changes, exits, and reboots.	
Discard Changes and Exit	Discards Setup changes since last save, exits, and reboots. Does not affect Security, date, or time changes.	
Get Default Values	Restores default settings, stays in Setup. Does not affect Security, date, or time changes.	
Load Previous Values	Discards Setup changes since last save, stays in Setup. Does not affect Security, date, or time changes.	
Save Changes	Saves Setup changes, and stays in Setup. Security settings are saved when changed.	

Configuring the OmniBook with TopTools

HP TopTools is for network managers and administrators with responsibilities for computer system management. It offers additional configuration and security options that allow you to check what hardware and software components are installed on your computer and access how well they are working. This section describes how to

- ◆ Install and run TopTools.
- ◆ Get more information about TopTools.

To install TopTools

The TopTools package is included with the OmniBook, but you must install it before you can use it. *On Windows NT systems you will need Administrator privileges to install TopTools software.*

1. Start Windows, if it is not already running.
2. Click Start, Programs, HP DMI, Setup.

To run TopTools

TopTools may be run locally on a PC or remotely by a network administrator.

- To run TopTools locally, click Start, Programs, HP DMI, HP TopTools.

To get more information about TopTools

For information on manageable HP PCs, HP TopTools, DMI, and how they lower PC operating costs, see the HP website at <http://www.hp.com/toptools>.

Operating the OmniBook

Operating the OmniBook

This chapter introduces the OmniBook and helps you get familiar with basic operation including

- ◆ Starting and stopping the OmniBook.
- ◆ Using the OmniBook touch pad.
- ◆ Using the OmniBook display.
- ◆ Adjusting the audio system.
- ◆ Using the OmniBook keyboard.
- ◆ Checking the status of the OmniBook.
- ◆ Protecting the OmniBook.

Starting and Stopping the OmniBook

You can easily start and stop your OmniBook using the blue power button. However, at certain times, you may want to use other methods for starting and stopping your OmniBook—depending on power considerations, types of active connections, and start-up time.

To start and stop the OmniBook

When you	The OmniBook enters	To exit this mode
Press Fn + S —or— allow time-out.	Standby Mode Saves minimal power. Turns off the display only. Restarts quickly. Maintains network connections.	Press any key or move a pointing device to display your current session (“Instant-On”).
Press blue power button —or— click Start, Suspend** —or— close the lid*** —or— allow time-out.	Suspend Mode Saves significant power. Turns off the display. Saves current session to RAM. Restarts quickly. May restore network connections.*	Press the blue power button to display your current session (“Instant-On”).
Press Fn + F12 —or— allow time-out.	Hibernate Mode Saves maximum power. Saves current session to disk, shuts down. May restore network connections.*	Press the blue power button to restart and restore your previous session.
Click Start, Shut Down (recommended) —or— Press and hold the blue power button until the display shuts down.	Off Mode Saves maximum power. Turns off without saving current session. At startup, resets everything, starts a new session, and restores network connections.	Press the blue power button to restart with a new session.
<p>* A plug-and-play operating system, such as Windows 95, can restore network connections when you turn on the OmniBook. For Windows NT 4.0 or a different operating system, you may have to reset the OmniBook or restart the operating system to restore them.</p> <p>** Windows 95 only.</p> <p>*** If you set the Video Display Device to Both (in BIOS Setup), the OmniBook will not suspend when you close the lid.</p>		

To reset the OmniBook

If Windows or the OmniBook stops responding, you can reset the OmniBook.

1. If possible, from the Start menu, shut down the OmniBook.
2. Insert a pen or straightened paper clip into the recess on the rear of the OmniBook, as shown.

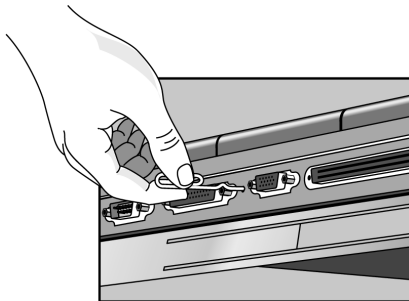

–or, if this fails–

Press and hold the blue power button until the display shuts down.

3. After the computer shuts down, press the blue power button to turn it on.

Using the OmniBook Touch Pad

The touch pad, a touch-sensitive pointing device which controls the motion and speed of the pointer on the screen, is built into your OmniBook.

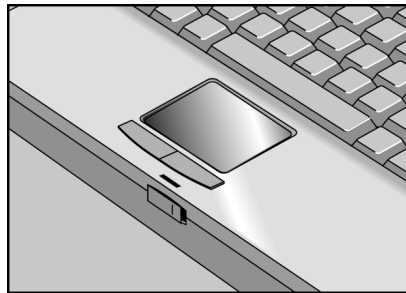

This section describes how to

- ◆ Use the touch pad.
- ◆ Configure the touch pad.

To use the touch pad

1. Move a thumb or finger across the touch pad in the direction you want the pointer to move.
2. Use the left and right click buttons, which work like the left and right buttons on a mouse, to make your selection. You can also tap on the touch pad instead of clicking a button.
 - To open an application, move the pointer over the icon, then press the left button twice rapidly.
 - To make menu selections, move the pointer to the item and press the left button once.
 - To open the shortcut menu for an item, move the pointer over the item and click the right button.
 - To drag an item, move the pointer over the item. Press *and hold* the left button while you move the pointer to the new location. Release the button.

To configure the touch pad

To customize the operation of the touch pad (and an external PS/2 or serial mouse, if installed), use the Windows Control Panel Mouse icon to access Mouse Properties. Select the tab corresponding to the item you wish to configure. Among the items that can be configured are

- Button configuration for right or left handed operation.
- Double-click speed, pointer speed, and pointer tail.
- Touch threshold. Click Help for more information on the use of the touch pad.

Note

The touch pad's enhanced features are not available when an external mouse is installed.

Using the OmniBook Display

This section describes how to

- ◆ Adjust the display brightness and contrast.
- ◆ Extend the life of the display.

To adjust the display brightness and contrast

Brightness affects battery time. To maximize your battery operating time, set the brightness to the lowest comfortable setting.

Brightness

- Press Fn+F1 to decrease the brightness.
- Press Fn+F2 to increase the brightness.

Contrast (for DSTN displays only)

- Press Fn+F3 to decrease the contrast.
- Press Fn+F4 to increase the contrast.

To extend the life of the display

Observe the following guidelines to maximize the life of the backlight in the OmniBook display.

- Set the brightness to the lowest comfortable setting (Fn+F1).
- When working at your desk, connect an external monitor and turn off the internal display (Fn+F5).
- Avoid using a screen saver or other software that prevents the OmniBook from changing to Suspend or Standby mode after a time-out period.
- Do not disable Suspend or Standby time-outs.
- If you are using ac power and have no external monitor attached, change to suspend or standby when not in use.

Adjusting the Audio System

The OmniBook supports Sound Blaster Pro-compatible sound and the Microsoft Windows Sound System. This section describes how to

- Adjust the volume manually.
- Adjust the volume in Windows.

To adjust the volume manually

- To increase the volume, press Fn+UP-ARROW.
- To decrease the volume, press Fn+DOWN-ARROW.
- To temporarily silence the speaker without changing the volume setting, press Fn+F7. Press again to restore the speaker output.

To adjust the volume in Windows

1. Click the speaker symbol in the taskbar.
2. Drag the volume control bar up or down to adjust the volume.
3. To temporarily silence the speaker without changing the volume setting, click Mute.

Using the OmniBook Keyboard

WARNING

Improper use of keyboards and other input devices has been associated with ergonomic injury. For information about reducing your risk, see the “Working in Comfort” document shipped with your OmniBook, or visit our ergonomics website, <http://www.hp.com/ergo>.

This section describes the OmniBook’s keyboard features including how to

- ◆ Use the Fn hot keys.
- ◆ Use the Windows keys.
- ◆ Use the embedded keypad.
- ◆ Use the ALT GR key on a non-US keyboard.

To use the Fn hot keys



The combination of the Fn key plus another key creates a *hot key*—a shortcut key sequence—for various system controls. The OmniBook keyboard shows the Fn *hot keys* labeled in gray.

Pressing these keys	Does this
Fn + F1	Decreases the display's brightness.
Fn + F2	Increases the display's brightness.
Fn + F3	Decreases the display's contrast (DSTN displays only).
Fn + F4	Increases the display's contrast (DSTN displays only).
Fn + F5	Toggles between auto detecting an external display and simultaneous displays.
Fn + F6 (hold)	For use with two batteries: Briefly displays the individual battery status for each battery, then resumes displaying the combined battery status. For complete information about battery status, see page 2-14.
Fn + F7	Toggles the sound on and off (mutes sound).
Fn + F8	Toggles the built-in keypad on and off. Does not affect an external keyboard. If Num Lock is on, then the numeric functions are active; otherwise, cursor control is active.
Fn + F9	Toggles Num Lock (numeric functions for the keypad) on and off.
Fn + F10	Toggles Scroll Lock on and off.
Fn + F12	Enters Hibernate mode.
Fn + S	Enters Standby mode.
Fn + R	Enters Suspend mode.
Fn + Up-Arrow	Increases volume.
Fn + Down-Arrow	Decreases volume.

To use the Windows keys

Windows keys are located on the keyboard to the left and right of the spacebar.



Brings up the Windows Start menu. There are two of these, one to each side of the spacebar.



Brings up the shortcut menu for the current application. This is the same menu that appears when you click the right mouse button while pointing at the application.

To use the embedded keypad

When the embedded keypad on the OmniBook's built-in keyboard is active, two options are possible.

Num Lock on Keys change to the numeric or arithmetic designations printed on the slanted faces of the keys.

Num Lock off Keys change to cursor control keys.

To identify the icons that show the status of Num Lock and the embedded keypad, go to page 2-14.

1. Press Fn+F9 to turn Num Lock on or off.
2. Press Fn+F8 to turn on the embedded keypad.

–or–

To temporarily turn on the embedded keypad, hold Fn while typing a key.

To use the ALT GR key

Non-U.S. keyboards have an ALT GR key to the right of the spacebar. This is a shift key providing access to certain keyboard characters.

- For a character in the lower-right corner of a key, press and hold ALT GR to type the character.
- For a character in the upper-right corner of a key, press and hold SHIFT *and* ALT GR to type the character.

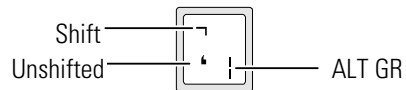

Checking the Status of the OmniBook

This section describes how to

- ◆ Interpret the status lights.
- ◆ Interpret the status panel indicators.

To interpret the status lights

The OmniBook has a power status light on the hinge, which is visible even when the OmniBook is closed.





- Steady green light. OmniBook is on.
- Blinking green light. OmniBook is in Standby or Suspend mode.
- No light. OmniBook is Off or in Hibernate mode.

The battery itself has four lights that indicate charge status when you press the square button on the battery. Each light represents a 25% charge.



To interpret the status panel indicators

The OmniBook status panel, located above the keyboard, contains indicators that show the current power status, drive status, and keyboard status.



Power Status Icons

Indicator	Meaning
	AC power. The ac adapter is connected.
	<p>Battery status. Shows the approximate charge level of the battery relative to a full charge. Each bar represents a 10% charge (displayed from right to left).</p> <p>Battery presence. The upper and lower triangles indicate the presence of main (upper) and secondary (lower) batteries. A triangle blinks slowly when that battery is charging. The main battery charges first, discharges last.</p> <p>If two batteries are installed, the gauge reports the percent of total charge, where both batteries are included. For example, if the main battery is 50% and the secondary battery is empty then the gauge would read 25%. You can press <i>and hold</i> Fn + F6 at any time to see the status of each individual battery.</p>
	Battery low. No battery bars showing; the triangles indicate the presence of battery. The OmniBook also beeps.
	Defective battery. No battery bars showing and no triangles indicating presence of battery. No charging even though ac power is present.
	Overheated battery. The battery is too hot to charge. Not necessarily a defective battery.

Drive Status Icons.

Indicator	Meaning
	Hard disk drive or plug-in drive. The OmniBook is accessing the hard disk drive or one of the plug-in accessory drives.
	Floppy disk drive. The OmniBook is accessing the floppy disk drive.
	PC Card. There is activity between the PC Card and the computer.

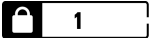
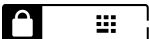
Keyboard Status Icons

Indicator	Meaning
	Caps Lock. Caps Lock is active.
	Num Lock. Num Lock is active (Fn + F9).
	Keypad Lock. The built-in embedded keypad is active (Fn + F8). Num Lock must also be on for the numeric keys. Otherwise, cursor keys are active.
	Scroll Lock. Scroll Lock is active (Fn + F10).

Protecting the OmniBook

Your OmniBook provides several ways for you to identify and protect your computer.

This section describes how to

- Set or change a password.
- Delete a password.
- Install McAfee VirusScan.
- Attach a security cable.
- Set a PC identification number.
- Enable hard disk drive lock.

To set or change a password

The OmniBook provides two levels of password protection—user password protection and administrator password protection. *You cannot set the user password until you set an administrator password.*

If password protection is set, then you will be prompted to enter a password whenever you reset or turn on the computer (depending on your setting). You cannot use the computer until you enter the correct password.

To set, change, or delete password protection for this OmniBook, use the BIOS Setup utility.

1. From the Start menu, shut down, then restart the OmniBook.
2. When you see the HP logo, press F2 to enter the BIOS Setup utility.
3. Select the Security menu.
4. Select Set Administrator Password, then press ENTER.
5. Type the new password, then press ENTER. The password can contain up to eight alphanumeric characters, and it is not case-sensitive.
6. Type the password again to confirm, then press ENTER.
7. Under Password Required To, choose when the password will be required.
 - Select Boot to require password when booting the OmniBook.
 - Select Resume to require password when resuming from Suspend.
 - Select Undock to require password when undocking the OmniBook.
8. If desired, repeat this procedure for Set User Password.
9. Press F10 to Save and Exit the BIOS Setup utility.

Note

If you forget a password, call Customer Support at the number listed in the *Support and Service* booklet to determine the proper removal procedure.

To delete a password

You can use this procedure to delete either a User or an Administrator password. If you delete an administrator password, the OmniBook automatically deletes the user password as well.

1. From the Start menu, shut down, then restart the OmniBook.
2. When you see the HP logo, press F2 to enter the BIOS Setup utility.
3. Select the Security menu.
4. Select Set Administrator Password, then press ENTER.
5. Type the current password, then press ENTER.
6. Press ENTER at the Enter New Password prompt.
7. Press ENTER at the Confirm New Password prompt.
8. Press Continue.
9. Press F10 to Save and Exit the BIOS Setup utility.

To install McAfee VirusScan

The OmniBook comes equipped with McAfee VirusScan, which currently detects over 13,500 viruses. As an HP OmniBook owner, you are entitled to 90 days free support from McAfee and one free upgrade to VirusScan. For details, click Start, Programs, McAfee VirusScan, Readme.

Before you can use VirusScan, you need to install it.

1. From the Start menu, click Programs, McAfee VirusScan, Setup.
2. Follow the instructions as they appear on the screen.

Once installed, you can get detailed online instructions under VirusScan Help. (Click Start, Programs, McAfee VirusScan, VirusScan, Help.)

To attach a security cable

Your OmniBook has a built-in connector that allows you to secure the OmniBook with a cable. The Kensington MicroSaver lock system works with this connector and is available at many computer stores.

1. Wrap the cable around a stationary object, such as a table leg.

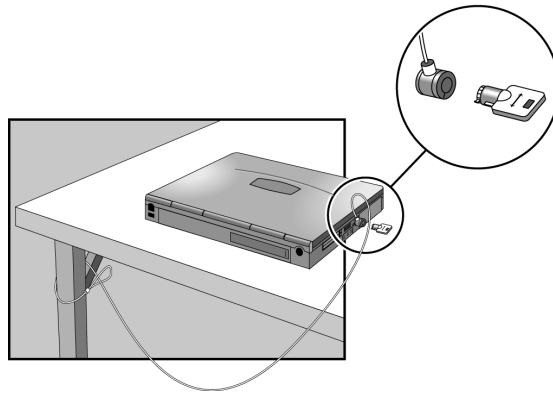

2. Loop the cable to create a slip knot around the stationary object—make sure it can't slip off.
3. Insert the lock into the OmniBook security connector and release the key. Store the key in a safe place away from the OmniBook.

To set PC identification

You must have administrator password authority to set a PC identification number.

1. If you have not already installed HP TopTools, do so now (page 1-16).
2. Click Start, then click HP TopTools.
3. Click Tools, then click Protect Tools.
4. Type your administrator password.
5. Click Security.
6. In the "Tattooing String" box, type the unique set of characters which will identify your PC.

You can type up to 80 characters including spaces and special characters. Do not press ENTER when typing. The string wraps automatically.

To enable hard disk drive lock

Hard disk drive lock helps you keep your information secure.

C A U T I O N

When you enable hard disk drive lock, the current user password (or administrator password if that is the only password set) is encoded on the hard disk drive.

If you move the hard disk drive to another OmniBook, you can't access the drive until you set the user (or administrator) password to match the drive's password. After you match the drive's password, you can change the OmniBook (and drive) password. If you forget the password, you cannot recover your data.

1. From the Start menu, shut down, then restart the OmniBook.
2. When you see the HP logo, press F2 to enter the BIOS Setup utility.
3. From the Security menu, enable Password Required To Boot.
4. From the Security menu, enable Hard Disk Drive Lock.
5. Press F10 to save and exit the BIOS Setup utility.

Managing Battery Power

Managing Battery Power

The OmniBook conserves power by using Advanced Power Management (APM), software that controls battery charging and power drain.

The OmniBook provides several safeguards so you won't be surprised by a dead-battery condition, including the following:

- ◆ The battery status indicator shows the remaining battery charge.
- ◆ Built-in warnings are displayed for low-battery conditions.
- ◆ The OmniBook automatically turns off when the battery charge gets too low—your session continues when you start recharging the battery or insert a fresh battery.
- ◆ Data previously saved on any of the drives is not affected by a low battery. However, unsaved data could be affected if the battery runs down completely while writing data to the drive.

Monitoring Battery Power

The primary source of power for the OmniBook is its rechargeable battery pack. You can use the ac adapter to recharge the battery—or to run on ac power to preserve the battery.

Important

Running external connections is a power-intensive operation that significantly shortens the length of a battery session. Whenever possible, connect the ac adapter when using external connections.

In addition to the replaceable battery, there is a permanent, internal backup battery, which recharges whenever the OmniBook is on or connected to ac. It maintains certain internal settings, such as the clock.





This section describes how to

- ◆ Check the battery status.
- ◆ Respond to a low-battery warning.
- ◆ Recharge a battery.
- ◆ Replace the main battery.
- ◆ Install a secondary battery.

To check the battery status

From the Status Panel

The following table explains the OmniBook status panel battery icons.

 Full battery	<p>Shows the approximate charge level of the battery relative to a full charge. Each bar (displayed from right to left), represents a 10% charge.</p> <p>The upper and lower triangles indicate the presence of main (upper) and secondary (lower) batteries. A triangle blinks when that battery is charging. The main battery charges first, discharges last.</p> <p>See "Battery Status" on page 2-14 for more information about the battery indicators.</p>
 Low battery	<p>The outline blinks when the battery charge is critically low. The OmniBook also beeps.</p>
 Defective battery	<p>No battery activity; no charging. If a left bar appears in the far left of the battery cell, the battery is overheated, so charging stops.</p>
 Overheated battery	<p>The battery is too hot to charge. Not necessarily a defective battery.</p>

From the Windows Taskbar

- Move the pointer onto the power icon at the right end of the taskbar. The approximate battery charge is displayed either as a percentage or in hours.
- Double-click the power icon on the taskbar to open the Battery Meter window.

From Windows

- Click My Computer, Control Panel, Power. This provides access to all options associated with reporting of power information by Windows.

On the Battery

- Press the button on the battery. The lights show the approximate charge level—each light representing 25% of a full charge.

To respond to a low-battery warning

When battery power is critically low, you are alerted by one or more of the following:

- The battery indicator in the status panel appears empty.
- The computer emits a warning beep. This reminds you to save your work.
- If the OmniBook has been off, you will not be able to turn it on.

The OmniBook automatically hibernates to preserve your current session. (If Hibernate is disabled in the BIOS Setup utility, then your data is not protected.) However, unsaved data could be affected if the battery runs down completely while writing data to the drive.

You won't be able to restart until you restore power by one of the following actions:

- Plug in the ac adapter.
–or–
- Replace the main battery with one that is charged.
–or–
- Install a charged secondary battery in the plugin module bay.

To recharge a battery

CAUTION

The ac adapter is normally warm to the touch whenever it's plugged into an ac outlet. The OmniBook is normally warm while it's charging. Don't charge it in a briefcase or other confined space as this may cause the battery to overheat.

1. Connect the power cord to the ac adapter, then plug the cord into an ac outlet. The indicator light on the ac adapter shines when the adapter is powered. If the ac adapter does not light, make sure the cord is not damaged.
2. Connect the ac adapter to the OmniBook's left side, as shown in the following illustration.

Managing Battery Power

Monitoring Battery Power

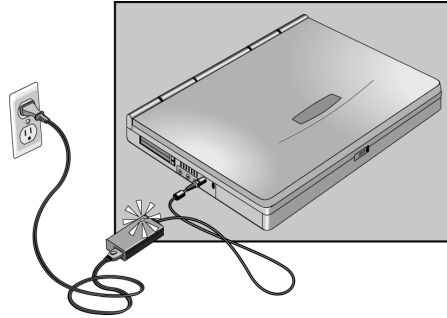

Charging time

Charging the battery takes about 1.5 hours.

Battery life

When the computer is in use, typical battery life can last up to 2 to 3 hours, depending on your level of use and your power management settings (see page 1-14).

Optimum Charging

To get the longest battery operating time, continue charging until the OmniBook battery is fully charged. Because of rounding, a battery indicator can show a full battery *before* it's fully charged. The status panel battery indicator (up or down triangle) stops blinking only when the battery is actually full.

You can continue working while the battery is charging.

To replace the main battery

W A R N I N G

Do not mutilate, puncture, or dispose of batteries in fire. A battery can burst or explode, releasing hazardous chemicals. A rechargeable battery must be recycled or disposed of properly.

1. **Important.** Save your work.
2. Plug in the ac adapter.
or
From the Start menu, shut down the OmniBook.
3. Slide the safety latch for the battery compartment into its recess.
4. Slide the release latch forward, then pull out the battery, as shown.

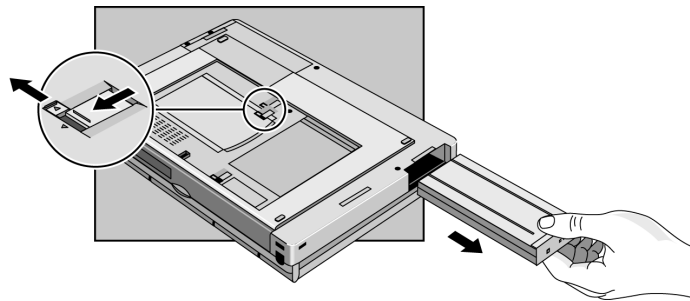

5. Slide the charged battery into the OmniBook until it clicks into place.

C A U T I O N

Be sure the safety latch is open before you insert the battery. Otherwise, the release latch could break if you force the battery in.

6. Close the safety latch.

To install a secondary battery

The OmniBook's plug-in module bay accepts a secondary battery. See page 4-4 for more information about plug-in modules.

When a secondary battery is installed, a lower triangle appears next to the battery icon in the status panel.

1. From the Start menu, shut down the OmniBook. (This is not necessary if you are removing a battery from the plug-in module bay and inserting another battery.)
2. Slide the safety latch for the plug-in module into its recess.
3. Slide *and hold* the release latch, then pull out the module, as shown.

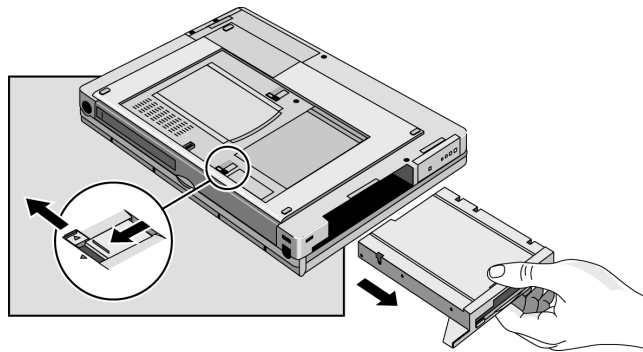

4. Slide the secondary battery into the module bay until it clicks into place.

CAUTION

Be sure the safety latch is open before you insert the battery. Otherwise, the release latch could break if you force the battery in.

5. Close the safety latch.

Conserving Battery Power

The OmniBook uses Advanced Power Management (APM) to conserve battery power. You can take steps to optimize your battery operating time. This section describes how to

- ◆ Optimize battery life.
- ◆ Set time-outs.
- ◆ Handle and store the battery safely.
- ◆ Get the most from your battery.

To optimize battery life

Follow these suggestions to optimize your battery life (operating time).

- Plug in the ac adapter, especially while using the floppy disk drive, the CD-ROM drive, or any external connections.
- Put the OmniBook in Suspend mode whenever you are not using it for a short time. Press the blue power button for approximately 1 second, or (from Windows 95), select Start menu, Suspend.
- Put the OmniBook in Hibernate mode whenever you want to save your current session, but will not be using the computer for several hours or more (Fn+F12).
- Turn the OmniBook off whenever you will not be using it for several hours or more: press the blue and hold the blue power button until the display shuts down *or* select Start menu, Shut Down. The current session is *not* saved.
- Turn the brightness of the display down to lowest comfortable level. This reduces backlight power, *which can increase operating time by as much as 15%*.
- Set the automatic time-out settings to emphasize saving power (page 3-10).
- If you have an I/O PC Card—that is, a PC Card having an external connection, such as a modem or network card—remove it when you are not using it. Some I/O cards use significant power, even while they're inactive.
- If you work with an application that uses the serial port or a PC Card, exit the application when you are done using it.
- Install a secondary battery in the plug-in module bay to double the operating time.

To set time-outs

The BIOS Setup utility includes settings for automatic time-outs at specified periods of inactivity. There are four different time-outs for different levels of power and conservation.

1. From the Start menu, shut down then restart the OmniBook.
2. When you see the HP logo, press F2 to enter the BIOS Setup utility. Active keys are described along the bottom of the screen. (The touch pad does not work in Setup.) Help information for the highlighted item appears in the right-hand sidebar in the display.
3. Select the Power menu.
4. Select Power Management Mode. (Press the spacebar, F5, or F6 to pick an option *other than* Disabled.)

Maximum Power Savings: The time-out settings are defined for best power savings (relatively short time-outs).

Maximum Performance: The time-out settings are set for fast performance with some power conservation (relatively long time-outs).

Customized: You determine each setting for Smart CPU Mode, Standby Time-out, Suspend Time-out, Hibernate Time-out, and Hard Disk Time-out. For definitions of these power modes, see page 2-3.

5. Optional. Choose a setting for Time-Out On AC. If you want the time-outs to occur even when the OmniBook is connected to ac power, choose Enabled. To prevent time-outs while the OmniBook is plugged in, choose Disabled (default setting).
6. Press F10 to save and exit the BIOS Setup utility.

To get the most from your battery

The following are some further suggestions for the best management of your OmniBook batteries.

- Do not leave batteries unused for long periods of time. If you have more than one, rotate them.
- If you normally use ac power, make a practice of at least once a week using the battery as your power source.
- Unplug the ac adapter when the computer is not in use.
- To preserve the life of your battery, be sure to charge the battery regularly.
- For long-term storage, the battery must be charged at 20-50% to save capacity loss by self-discharge and to avoid deterioration of battery performance. In a discharged condition, the battery voltage decreases faster. Storage in a 100% charged condition can cause higher self-discharge and deterioration of discharge capacity—even after recharging—compared to storage in a 20-50% charged condition.



Making Connections

Making Connections

This chapter describes procedures to expand the capabilities of your OmniBook, including

- ◆ Using OmniBook plug-in modules.
- ◆ Connecting external devices.
- ◆ Using PC Cards.
- ◆ Using docking products.

Using OmniBook Plug-In Modules

The plug-in module bay can hold a CD-ROM drive, floppy disk drive, Zip drive, or a secondary battery.

This section describes how to

- ◆ Replace a plug-in module.
- ◆ Install the floppy disk drive externally.
- ◆ Insert or eject a floppy disk.
- ◆ Insert or remove a CD.
- ◆ Insert or eject an Zip disk.

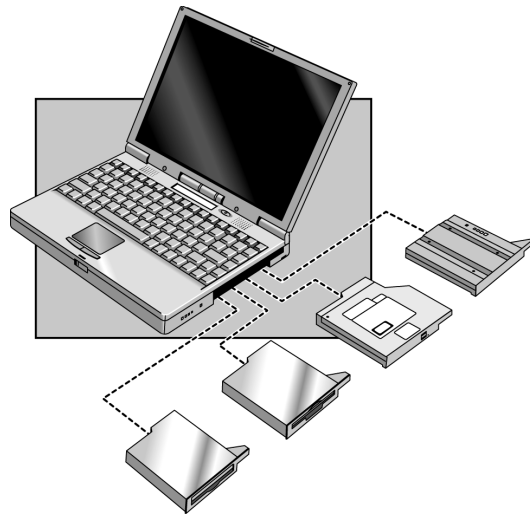

Hint

The floppy drive module can also be connected externally via the parallel port. If you want to do this, you'll need to order the external floppy cable (HP F1380A). You can order this online at <http://www.hp.com/omnibook>.

To replace a plug-in module

Important

If you are inserting or removing a CD-ROM drive, floppy drive, or Zip drive, shut down the OmniBook.

1. From the Start menu, shut down the OmniBook. (This is not necessary if you are removing a battery from the plug-in module bay and inserting another battery.)
2. Slide the safety latch for the plug-in module bay into its recess.
3. Slide *and hold* the release latch, then pull out the module, as shown.

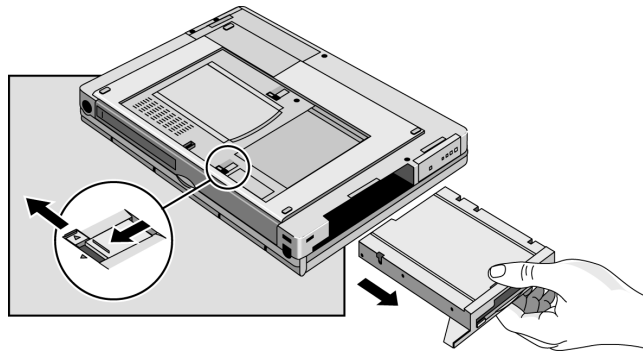

4. Slide the new plug-in module into the OmniBook until it clicks into place.

CAUTION

Be sure the safety latch is open before you insert the module. Otherwise, the release latch could break if you force the module in.

5. Close the safety latch.

To connect the floppy disk drive externally

When using the plug-in floppy disk drive externally, the plug-in module bay can be used by another plug-in module—such as a CD-ROM drive, a Zip drive, or a secondary battery.

- Connect the external floppy disk drive cable (optional accessory, HP F1380A) to the OmniBook parallel port.

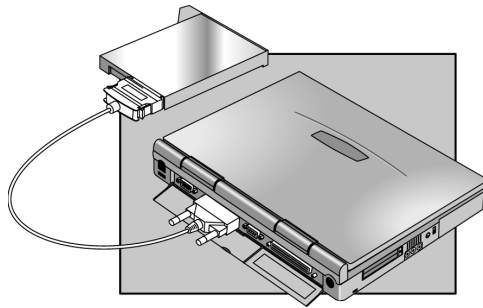

Note

Only one floppy disk drive is supported on the OmniBook. *You cannot use both an external floppy disk drive and a plug-in floppy disk drive.*

To insert or eject a floppy disk

CAUTION

Do not insert or remove a floppy disk while the OmniBook is actively reading or writing data. Otherwise, you could lose data or the OmniBook could stop responding.

- Hold the disk with its face up, then slide it into the floppy disk drive slot until it clicks into place.
- To remove the floppy disk, press the eject button on the front of the drive.

To insert or remove a CD

CAUTION

Do not remove a CD while the OmniBook is actively reading data. Otherwise, the OmniBook could stop responding and you could lose data.

1. Press the button on the face of the CD-ROM drive.
2. If one is present, remove the cardboard shipping insert.
3. Place the CD into the drive (label facing up) and gently press down to seat the CD on the spindle.

-or-

Remove the CD.

4. Close the door to the drive.

If you lose power to the OmniBook, or if you have removed the CD-ROM module from the OmniBook, you can manually open the CD-ROM drive to remove a CD.

- Carefully, insert a straightened paper clip into the recessed hole on the front of the CD-ROM drive.

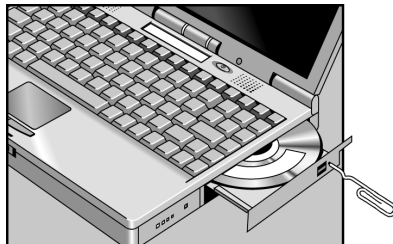

To insert or eject a Zip disk

CAUTION

Do not remove a Zip disk while the OmniBook is actively reading or writing data. Wait until the Zip drive is done. Otherwise, the OmniBook could stop responding and you could lose data.

- Always turn on power to the OmniBook before inserting a Zip disk.
- To insert the Zip disk, hold the disk with its face up, then gently slide it into the Zip drive.
- To remove the Zip disk, press the eject button on the front of the Zip drive. Do not use force. It takes a few seconds to eject the disk and the green busy light blinks during this process.
- The Zip drive automatically ejects the disk when you shut down your OmniBook.
- Store all Zip disks in their protective cases when not in use.

If the Zip drive has no power and you need to remove a disk from it, carefully push a straightened paper clip into the emergency eject hole located on the eject button.

CAUTION

Use the manual disk eject procedure only when OmniBook power is off. Do not try to forcibly remove a Zip disk from the drive. If the disk does not eject immediately, repeat the manual disk eject procedure.

Connecting External Devices

Your OmniBook is a powerful computer in its own right—but you can greatly expand its capabilities by connecting other devices.

Note

Before you connect any device, check the documentation that came with the equipment to see if you need to make any settings or adjustments to the equipment before using it. This might include setting switches to configure the equipment so that it will operate properly with the OmniBook and the software you plan to use.

This section describes how to

- ◆ Identify the external ports.
- ◆ Connect an external monitor.
- ◆ Enable the built-in and external displays.
- ◆ Change display settings in the BIOS Setup utility.
- ◆ Connect a parallel device.
- ◆ Connect a serial device.
- ◆ Connect an external PS/2 keyboard or PS/2 mouse.
- ◆ Connect universal serial bus (USB) devices.
- ◆ Connect audio devices.
- ◆ Make an infrared connection.

To identify the external ports

The following graphic describes the available connectors for external devices. Refer to it, if necessary, when following the procedures in this section.

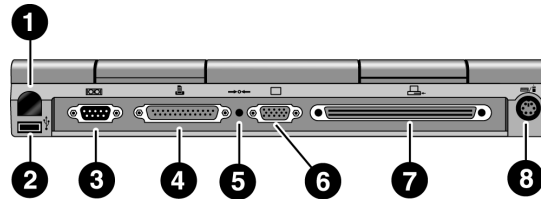

1. Infrared port. Use this port for wireless data transmission between the OmniBook and another computer or a printer with an infrared port. You must install infrared drivers. Windows NT 4.0 does not support infrared communication.
2. Universal Serial Bus port (USB).
3. Serial port (COM1).
Use this port for a serial mouse, a modem, or a serial printer.
4. Parallel port (LPT1).
Use this port for a parallel printer.
5. System-off button (to reset the OmniBook).
6. External monitor port.
7. Docking port.
8. PS/2 keyboard or PS/2 mouse port.

To connect an external display

You can connect a VGA, SVGA, or XGA monitor to your OmniBook. OmniBook VGA port supports standard XGA mode (1024 by 768 pixels).

1. From the Start menu, shut down the OmniBook.
2. Connect the monitor cable to the monitor, then to the VGA port on the back of the OmniBook.
3. Connect the monitor to a power source and turn it on.
4. Press the blue power button to turn on the OmniBook.
5. If the external monitor has a different resolution from the internal display, adjust the display properties (My Computer, Control Panel, Display, Settings).

To enable the built-in and external displays

- For a temporary change, press Fn+F5 to cycle through the display options (Internal, External, Both).

–or–

For a permanent change, change the settings in the BIOS Setup utility (see the following topic).

To change display settings in the BIOS Setup utility

1. From the Start menu, shut down, then restart the OmniBook.
2. When you see the HP logo, press F2 to enter the BIOS Setup utility.
3. From the Main menu, use the down arrow to highlight Video Display Device.
4. Press ENTER to view choices.
5. Select Auto or Both.
6. Press F10 to save settings and exit Setup.

To connect a parallel device

The parallel port uses a standard 25-pin connector, most commonly used for connecting printers. These include dot matrix, ink-jet, and laser printers. The parallel port supports either EPP or ECP.

The OmniBook has one parallel port. Its address and properties can be set in the BIOS Setup utility.

- Connect the parallel printer cable or other parallel cable to the parallel port.

To connect a serial device

The OmniBook's serial port uses a standard 9-pin serial port. Serial connections typically are to external modems and fax modems.

The OmniBook has one serial port. Its address can be set in the BIOS Setup utility.

- Connect the serial cable to the serial port.
For a serial mouse, you need to select Standard Serial Mouse in Control Panel, Mouse, General, Change.

To connect an external keyboard or PS/2 mouse

The 6-pin PS/2 port allows you to attach an external keyboard or a PS/2-compatible mouse to the OmniBook.

1. From the Start menu, shut down the OmniBook.
2. Plug the mouse or keyboard PS/2 cable into the PS/2 port on the OmniBook.
 - To connect both a mouse and a keyboard, use the HP F1469A PS/2 Y adapter.
 - To connect a device that has a PC-type jack, first connect its cable to an adapter cable with a PS/2 jack.
3. Press the blue power button to turn on the OmniBook.

To connect USB devices

Note

Windows NT 4.0 does not support universal serial bus (USB) devices.

Universal serial bus (USB) provides a bi-directional serial interface for adding peripheral devices such as game controllers, serial and parallel ports, and scanners on a single bus. The OmniBook provides one USB port; the OmniBook docking products provide two USB ports.

- Attach the USB cable to the USB port. Windows 95 automatically recognizes the USB device. Some USB devices can be connected to the OmniBook in series with other USB devices—this is called a “daisy-chain” connection.

Note

If you have problems making this connection, contact the vendor of the peripheral device, as well as Hewlett-Packard, for the latest versions of the USB drivers. The USB technology is dynamic and continues to develop.

USB is disabled by default in the BIOS Setup utility.

To connect audio devices

Your OmniBook has a built-in microphone and two stereo speakers. The audio jacks allow you to plug in external audio devices.

- Plug a stereo input source (such as a CD player) into the input (left) jack.
- Plug the microphone into the microphone (middle) jack. The built-in microphone turns off.
- Plug devices such as headphones or external (amplified) speakers into the output (right) jack. The built-in speakers turn off.

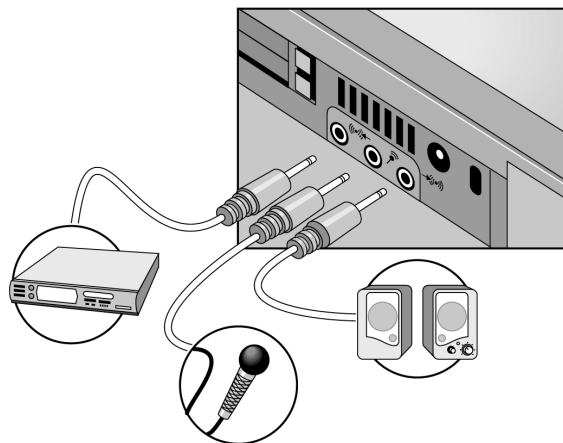

CAUTION

Connecting a mono plug into the speaker-out jack may damage the OmniBook. The audio jacks are three-terminal stereo jacks. They are not compatible with two-terminal mono plugs.

To make an infrared connection

Note

Windows NT 4.0 does not support infrared communication.

By default, the infrared port is *not enabled*. You must enable it in the BIOS Setup utility and then install the appropriate infrared driver. For details, refer to the driver's Readme file located in \OmniBook\drivers\Win95.

The infrared port is on the back panel. It provides wireless, serial communication between the OmniBook and other infrared devices such as printers or other OmniBooks.

- Line up the OmniBook's infrared port and the other infrared port in as straight a line as possible. The two ports should be no more than 1 meter apart, with no obstructions in between. Noise from nearby equipment can cause transmission errors.
- To check the status of communications, go to Infrared Monitor (Start, Settings, Control Panel).

Printing to an Infrared Printer

- Install your printer and assign it to the OmniBook's IR port. You can then print from your applications as you would to any other printer. Be sure the OmniBook and printer infrared ports are properly aligned.

Transferring Files with an Infrared Connection

To transfer files, you can use the Direct Cable Connection software built into Windows 95. You need to install it first.

1. From Control Panel, click Add/Remove Programs.
2. Click Windows Setup, Communications, and select Direct Cable Connection.
See the Windows 95 online help for instructions about how to use Direct Cable Connection.

Using PC Cards

This section describes how to

- ◆ Insert a PC Card.
- ◆ Remove a PC Card.
- ◆ Find a list of tested PC Cards.

To insert a PC Card

Note

Windows NT 4.0 does not support zoomed video. If you are using Windows NT 4.0, make sure you've installed Card Executive (see page 6-21 for instructions).

The OmniBook PC Card slots are available for storing data and expanding the communication capabilities of the OmniBook. You can use two Type II cards or one Type III card. The lower card slot (slot zero) supports zoomed video, which allows high-quality multimedia presentations.

1. Be sure the eject buttons have been pushed in, flush with the case of the OmniBook.
2. Hold the card with its face up and its connector holes toward the card slot.
3. Slide the PC Card into the slot until it is flush with the OmniBook.

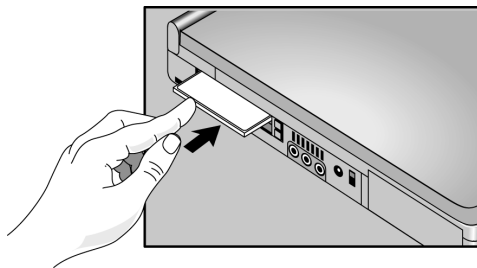

To remove a PC Card



PC Card indicator

Do not remove a PC Card while the OmniBook is actively reading or writing data. Otherwise, you could lose data or the OmniBook could stop responding. When the card is active, the PC Card indicator appears on the status panel.

1. To remove the card, click the PC Card indicator in the taskbar, then click Stop (for Windows 95 only). This protects your data and avoids unexpected problems. You can restart the card by removing it, then inserting it again.
2. Press the ejector button once to pop the button out.
3. Press the ejector button again to eject the PC Card.

The OmniBook beeps twice when the card pops out.

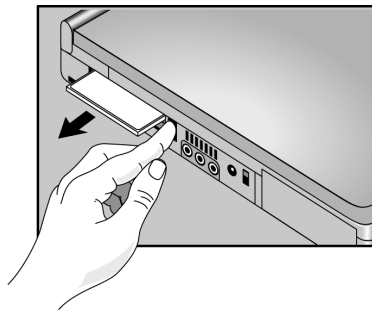

4. Push in the ejector button until it is flush with OmniBook case.

To find tested PC Cards

For the latest information about compatible cards, visit our website at <http://www.hp.com/omnibook> and check the Accessories section. Or contact Hewlett-Packard as described in the *Support and Service* booklet.

Using Docking Products

A docking product provides external connections for the OmniBook that you can leave in place whenever you remove the OmniBook from your desk. Instead of disconnecting and reconnecting peripheral devices, simply undock and dock the OmniBook. This section describes how to

- Install a docking tray.
- Dock the OmniBook.
- Undock the OmniBook.

For more information about using docking products, see the *User's Guide* that shipped with your dock.

To install a docking tray

Your dock requires a tray that accommodates your specific OmniBook model. Install this tray prior to connecting the OmniBook to the dock.

1. Select the tray labeled for the OmniBook 2100 or 3100.
2. Slide the rear of the tray into the dock as shown on the dock label.
3. Push down firmly on both sides of the tray until it snaps into place.

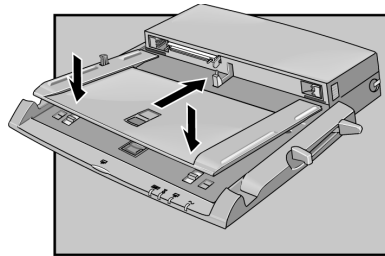

To remove a tray from the dock, pull the latch (near the center front of the dock) towards you until the tray pops free.

To dock the OmniBook

CAUTION

Use only an HP F1454A ac adapter. This is the same adapter that the OmniBook uses. Using any other ac adapter could damage the OmniBook and may void your warranty. Refer to the warranty statement for your product.

1. If you're using Windows NT, click Start, Shut Down.
2. Plug the power cord into the ac adapter, then into an ac outlet. Plug the ac adapter into the dock.

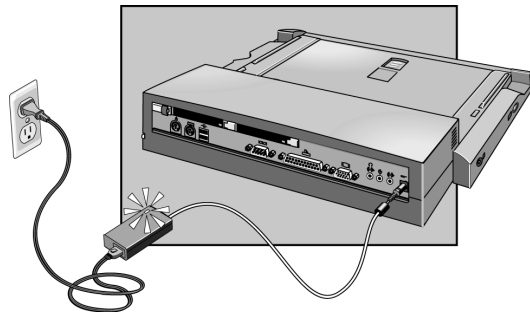

3. On the rear of the OmniBook, slide the docking door to the left.
4. Place the OmniBook on the dock platform, with the rear of the computer facing the dock's docking connector.
5. Position your fingers on the platform grips as shown below. Use your thumbs to push the computer into the dock until the computer slides into place.

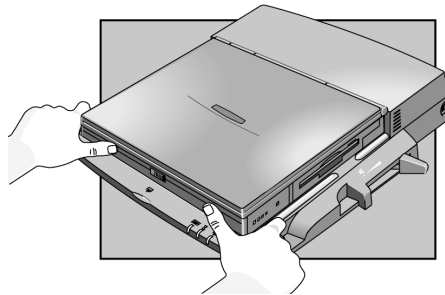

To undock the OmniBook

1. If you're using Windows NT, click Start, Shut Down.
2. Press the undock button on the front of the dock and wait for the undock light to turn green. Then position your thumb as shown and pull the release lever forward.

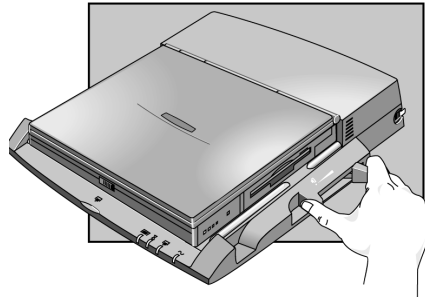

3. Remove the OmniBook from the dock.

Expanding the OmniBook

Expanding the OmniBook

This chapter describes some of the optional equipment that can be added to the OmniBook—components installed inside the computer rather than connected to the computer's I/O ports.

This chapter describes procedures to expand or update the capabilities of your OmniBook, including

- ◆ Installing a hard disk drive.
- ◆ Installing a RAM expansion module.

Installing a Hard Disk Drive

This section describes how to

- ◆ Replace the hard disk drive.
- ◆ Replace the hard disk drive holder.
- ◆ Create a hibernate partition for a new hard disk drive.

To replace the hard disk drive

CAUTION

You must shut down the OmniBook, unplug the ac adapter, and remove the battery before replacing the hard disk drive.

You'll need a small Phillips screwdriver to remove the hard disk drive.

1. From the Start menu, shut down the OmniBook.
2. Unplug the ac adapter, if present, and remove the battery.
3. Remove the two screws from the bottom of the hard disk drive.

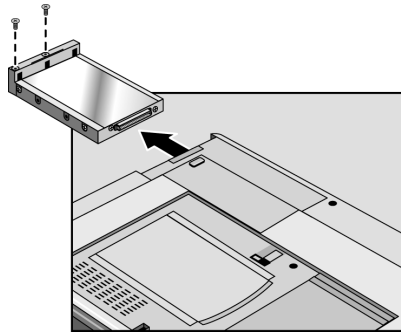

4. Pull out the hard disk drive.
5. Insert the new drive and replace the hard disk drive screws.
6. Insert the battery.

Important

If you are installing a new hard disk drive, you should create a Hibernate partition on the drive before loading any software—see page 5-5 for instructions.

To replace the hard disk drive holder

If you are installing a new hard drive that does not have a plastic holder, you can remove the holder from the old hard drive.

You'll need a small Phillips screwdriver for this procedure.

1. Remove the four screws from the sides of the case.
2. Remove the top shield (if present) and swing out the free end of the hard drive about 90°, then gently pry off the connector from the hard drive.

CAUTION

Work the connector off the hard drive evenly, without pulling on the flex cable. Otherwise you may bend connector pins or the hard drive or damage the flex cable.

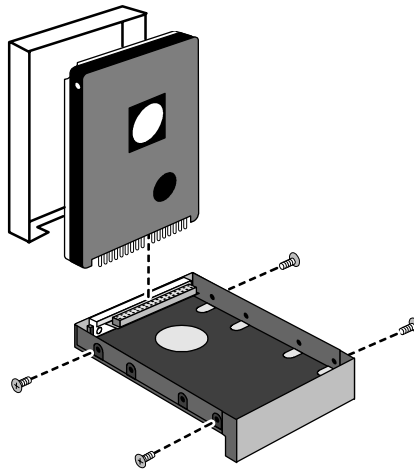

Note

Depending on the form factor of the replacement drive, the following hard disk drive variations may exist:

- The hole placement for the four screws may vary.
- The hard drive may have either a one- or two-piece shield.
- If your original drive was a 9.5mm and you are replacing it with a 12.7mm, remove the rubber spacers from the upper half of the hard disk drive shield before installing the new drive.

To create a Hibernate partition

If you do not have an OmniBook Support Utility floppy disk, create one now. After inserting a formatted floppy disk in the floppy drive, do one of the following:

- On a factory software installation, click Start, Programs, OmniBook, Create support utility disk.
- On any computer with a CD-ROM drive, run **makesupp.bat** from the \Omnibook\Drivers\Hputils directory on the OmniBook *Recovery CD*. (Note: Use the \Omnibook\Drivers\Hputils directory, not \OmniBook \Hputils).
- On any computer, download the Support Utility software package from the OmniBook website (<http://www.hp.com/omnibook>). Follow the instructions provided.

1. Connect the ac adapter to the OmniBook.
2. Insert the Support Utility disk in the floppy disk drive or insert the bootable *Recovery CD* in your CD-ROM drive.
3. Reboot, press ESC twice and select the CD-ROM as the boot device.
4. Reset the OmniBook. The DOS Startup menu appears.
5. Choose option 3:
Create Hibernate Partition (erases Hard Disk).
6. Choose Y to Continue.
7. When prompted for “Hibernate” partition size, we recommend that you select the default, which varies depending on whether your OmniBook has one or two RAM slots.

Do not interrupt the Hibernate partition process or unplug the ac adapter until complete.

Installing a RAM Expansion Module

CAUTION

Your OmniBook's computer chips are extremely static-sensitive. Static electricity can permanently damage computer chips. Handle the RAM module only by its edges. Before installing the memory module, discharge your body's static electricity by touching the metal shielding around the connectors on the rear of the OmniBook.

You must shut down the OmniBook, unplug the ac adapter, and remove the battery before removing a RAM expansion module.

Hint

Depending on the OmniBook model, your computer has either one or two RAM expansion slots. The following restrictions apply:

- If you have one RAM expansion slot, you can install either an SDRAM module (such as F1456A, ...) or an EDORAM module (such as F1363A, ...).
- If you have two RAM expansion slots and a Pentium II processor, you can install only SDRAM modules (F1456A, ...) in the slots.
- If you have two RAM expansion slots and a Pentium processor, you can install either SDRAM modules (F1456A, ...) or EDORAM modules (F1363A, ...) in the slots—but do not put a module larger than 32 MB in the slot nearest the corner of the computer.

The easiest way to avoid RAM configuration problems is to use HP SDRAM modules exclusively.

This section describes how to

- ◆ Install a RAM expansion module.
- ◆ Remove a RAM expansion module.

To install a RAM expansion module

Your OmniBook's computer chips are extremely static-sensitive. Static electricity can permanently damage computer chips. Before starting, reading the caution on page 5-6 about how to handle RAM expansion modules.

You'll need a small Phillips screwdriver to complete this procedure.

1. From the Start menu, shut down the OmniBook.
2. **Important.** Unplug the ac adapter, if present, and remove the battery.
3. Remove the hard disk drive (see page 5-3).
4. Slide the RAM cover about 3 mm toward the hard disk drive opening, then lift off the cover.

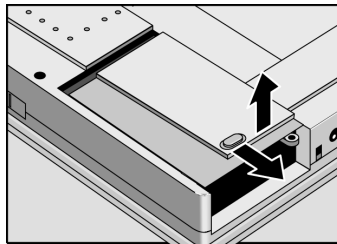

5. Insert the RAM board into the connector at about a 30° angle, then press down at both sides until it latches. Make sure it is properly seated.

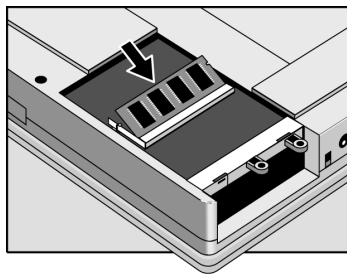

See the Hint about RAM size and type on previous page.

6. Place the RAM cover about 3 mm from its closed position, then slide it closed.
7. Insert the hard disk drive and battery.

To remove a RAM expansion module

Your OmniBook's computer chips are extremely static-sensitive. Static electricity can permanently damage computer chips. Before starting, reading the caution on page-5-6 about how to handle RAM expansion modules.

You'll need a small Phillips screwdriver to complete this procedure.

1. From the Start menu, shut down the OmniBook.
2. **Important.** Unplug the ac adapter, if present, and remove the battery.
3. Remove the hard disk drive (see page 5-3).
4. Slide the RAM cover about 3 mm toward the hard disk drive opening, then lift off the cover.

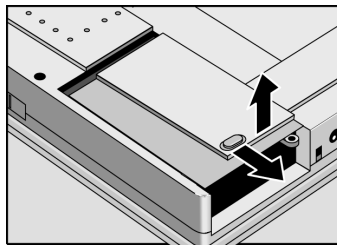

5. Release the two latches at the sides of the RAM board by pushing them outward and away from the sides of the module. When you release the latches, the free edge of the board pops up.
6. Pull the board out of the connector.

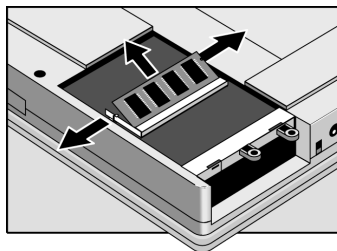

7. Insert the hard disk drive and battery.

Using the *Recovery CD*

Using the *Recovery CD*

You can use the OmniBook *Recovery CD* to recover an original OmniBook build, or you can use it to install the HP custom software over a user-installed alternate operating system.

The *Recovery CD* provides the OmniBook-specific drivers to configure your custom system. The drivers for Windows 95, Windows NT 4.0, and Windows for Workgroups are located in these places:

- On the *Recovery CD* ROM, under \Omnibook\Drivers.
- On the OmniBook hard drive under C:\Omnibook\Drivers.
- On the OmniBook website at <http://www.hp.com/omnibook>. This website contains the latest updates of software drivers.

The OmniBook *Recovery CD* contains the following:

Directory	Contains
README.TXT text file	Instructions for using the <i>Recovery CD</i> .
RECOVER\	
ENC	Encoded image of the factory load—either Windows 95 or Windows NT 4.0.
BOOTDISK	For creating your own copy of a boot disk (like the <i>Support Utility</i> disk).
FILE.CHK	Checksum list. Used to verify that software recovery was successful.
OMNIBOOK\	
HPUTILS	Use this to install the online <i>User's Handbook</i> or to copy the OmniBook Notes and Support files to the \OmniBook directory on your hard drive.
DRIVERS	Use this to manually install individual audio, video, infrared, and PC-Card (PCMCIA) drivers for Windows NT 4.0, Windows 95, and Windows for Workgroups. Look for the specific driver for the specific version of your operating system. Each driver has a README file with instructions.
MANUALS	Use this for viewing of the online <i>User's Handbook</i> from the CD, not for its installation.

Recovering a Factory Software Installation

If you've deleted or lost files on the OmniBook, causing the system to work improperly, you may need to recover the original factory build.

This section describes how to

- ◆ Recover the OmniBook factory installation of Windows 95.
- ◆ Recover the OmniBook factory installation of Windows NT 4.0.

To recover the Windows 95 factory installation

The following procedure describes how to recover the original Windows 95 operating system that came with your OmniBook.

Requirements

- ◆ OmniBook 2100/3100.
- ◆ OmniBook 2100/3100 *Recovery CD*.

Hint

This procedure will format the hard disk drive. If possible, *back up any files you would like to save before installing Windows 95.*

1. Shut down the OmniBook and insert the CD-ROM drive in the module bay.
2. Connect the ac adapter and turn on the OmniBook.
3. When you see the HP logo, press F2 to enter the BIOS Setup utility.
4. Open the Boot menu and select CD-ROM as the first boot device. (*You may want to change the boot order back to Diskette Drive after completing this procedure.*)
5. Insert the *Recovery CD* into the CD-ROM drive.
6. Press F10, then press Yes to save and exit the BIOS Setup utility.
7. When the menu appears, choose "Recover Windows 95."
8. When prompted, select Y to erase the hard disk and continue.
9. When prompted, select a file system (FAT16 or FAT32).

FAT 32 is the factory default. After the hard drive is erased and partitioned, the OmniBook reboots and begins copying files from the *Recovery CD*.

The recovery process can take up to an hour. *Do not interrupt the recovery process or unplug the ac adapter until recovery is completed.*

10. When the Recovery process is complete, reset the OmniBook. See page 2-4.

To recover the Windows NT factory installation

The following procedure describes how to use the *Recovery CD* to recover the original Windows NT 4.0 factory-installation that came with your OmniBook.

Requirements

- ◆ OmniBook 2100/3100.
- ◆ OmniBook 2100/3100 *Recovery CD*.

Hint

This procedure will format the hard disk drive. *Back up any files you would like to save before installing Windows NT 4.0.*

1. Shut down the OmniBook and insert the CD-ROM drive in the module bay.
2. Connect the ac adapter and turn on the OmniBook.
3. When you see the HP logo, press F2 to enter the BIOS Setup utility.
4. Open the Boot menu and select CD-ROM as the first boot device. (*You may want to change the boot order back to Diskette Drive after completing this procedure.*)
5. Insert the *Recovery CD* into the CD-ROM drive.
6. Press F10, then press Yes to save and exit the BIOS Setup utility.
7. When the menu appears, choose "Recover Windows NT."
8. When prompted, select Y to erase the hard disk and continue.

After the hard drive is erased and partitioned, the OmniBook reboots and begins copying files from the *Recovery CD*.

The recovery process can take up to an hour. *Do not interrupt the recovery process or unplug the ac adapter until recovery is completed.*

9. When the Recovery process is complete, reset the OmniBook. See page 2-4.

Installing Retail Windows 95

If you install a *retail* version of Windows 95, you'll also need to manually install video, audio, touch pad, PC Card, and infrared drivers.

This section describes how to

- ◆ Install a retail version of Windows 95.
- ◆ Install video support for retail Windows 95.
- ◆ Install audio support for retail Windows 95.
- ◆ Install PC Card support for retail Windows 95.
- ◆ Install infrared support for retail Windows 95.
- ◆ Install touch pad support for retail Windows 95.

To install a retail version of Windows 95

Requirements

- OmniBook 2100/3100 with internal CD-ROM drive.
 - OmniBook *Recovery CD*.
 - Retail *Windows 95 CD*.
1. Shut down the OmniBook and insert the CD-ROM drive in the module bay.
 2. Connect the ac adapter and turn on the OmniBook.
 3. When you see the HP logo, press F2 to enter the BIOS Setup utility.
 4. Open the Boot menu and select CD-ROM as the first boot device. (You may want to change the boot order back to Diskette Drive after completing this procedure.)
 5. Insert the *Recovery CD* into the CD-ROM drive.
 6. Press F10, then select Yes to save and exit the BIOS Setup utility.
 7. From the menu, select Create Hibernation Partition and select 'Y' to options.
 8. From the A drive, type FDISK.
 9. When prompted to enable large disk support, choose N for FAT16.
 10. Press Enter to continue.
 11. When prompted, create Primary DOS partition (and Extended DOS partition, if needed). You will need at least 300 MB for the Primary Partition.
 12. Make the C drive an active partition.
 13. Press ESC to exit FDISK.
 14. Press CTRL+ALT+ DEL.
 15. Choose Exit to MS-DOS.
 16. From the A: prompt, type Format C:, then type SYS C:.
 17. Create a C:\Windows\Options\Cabs directory by typing the following:
Mkdir C:\Windows
Mkdir C:\Windows\Options
Mkdir C:\Windows\Options\Cabs

Installing Retail Windows 95

18. Insert the Windows 95 CD into the CD-ROM drive.
19. Copy the Windows 95 installation files to your hard drive by typing:
C:
Copy D:\Win95*. * C:\Windows\Options\Cabs
20. Restart the OmniBook, then begin the installation by typing:
C:\Windows\Options\Cabs\Setup
21. Press Enter to begin a routine check of the system.
22. When the following error appears, press the ESC key to continue.
This version of Microsoft Scandisk will work only with MS-DOS version 5.0 and later. Setup found a compressed volume or a disk-cache utility on your computer. Quit setup and check your compressed volume with your disk compression software or remove the disk cache utility. Then run setup again or choose Esc to continue with setup.
23. Click Yes to accept the license.
24. When prompted, select Other Directory and click Next. Enter C:\Windows for the path, click Next, and then click Yes to continue with the specified directory.
25. Choose Portable on the Setup Options screen, then click Next.
26. Enter the appropriate User Information, then click Next.
27. Enter the Product Identification Number, then click Next. The Product Identification Number is located on the Certificate of Authenticity that you received with your retail version of Windows 95.
28. *Do not* detect any Network, Sound, MIDI, or Video Capture Card devices, then click Next.
29. Follow the prompts until the end of the installation, and then reboot.
30. Copy the files in D:\OmniBook from the OmniBook 2100/3100 *Recovery CD* to C:\OmniBook.
31. Insert the OmniBook Recovery CD.
32. Open Windows Explorer.
33. Click View, then Options.
34. Select Show all files, uncheck Hide MS-DOS extensions, then click OK.
35. Copy the files from the Recovery CD in \OMNIBOOK\DRIVERS\WIN95\PIIX4UPD to C:\WINDOWS\INF. (If prompted, click Yes to All to replace all files.)
36. From Control Panel, double-click System, then click Device Manager.

37. Remove any PCI devices (Cards or Bridges) from the Other devices category.
38. Close the System Properties window.
39. Shut down and restart Windows 95.
40. If you are prompted for a PCI Card driver, select Do Not Install A Driver, then click OK.

To install video support for retail Windows 95

If you've installed a *retail* version of Windows 95, you'll need to install video support. The driver is located on the OmniBook's hard drive or on the *Recovery CD* in the \Omnibook\Drivers\Win95\Video directory.

1. From Control Panel, double-click Display, then click Settings.
2. Click Change Display Type.
3. Under Adapter Type, click Change.
4. Click Have Disk.
5. Enter the directory of the video drivers, then click OK.
6. Click OK to select NeoMagic MagicGraph 128XD.
7. Under Monitor Type, click Change.
8. Choose Laptop Display Panel.
For 2100, choose 800 x 600.
For 3100, choose 1024 x 768.
9. Click OK, then Close.
10. Set the Desktop Area.
For 2100, True Color (24 Bit).
For 3100, choose High Color (16 Bit).
11. Click Close in Display Properties, then click Yes to restart the computer now.

To install audio support for retail Windows 95

If you've installed a *retail* version of Windows 95, you'll need to install audio support. This driver is located on the OmniBook's hard drive or on the *Recovery CD* in `\Omnibook\Drivers\Win95\Audio`.

1. From Control Panel, double-click Systems, then click Device Manager.
2. Open the MS Windows Sound System Compatible device under Sound, Video, and Game Controllers, and confirm the following resources in the Resource tab:

Direct Memory Access	01
Direct Memory Access	00
Interrupt Request	05
Input/Output Range	0530-0537
Input/Output Range	0388-038B
Input/Output Range	0220-022F

3. Click Driver, then click Change Driver.
4. Click Have Disk.
5. Enter the directory of the audio drivers (`Omnibook\Drivers\Win95\Audio`), then click OK.
6. Click OK to accept Crystal PnP Audio System CODEC.
7. Click OK to close the Unknown Device Properties window.
8. When prompted to shut down, click No.
9. Open the Unknown device under Other devices.
10. Click on the Driver tab, then click Change Driver.
11. Select Other detected devices then click OK.
12. Click OK to accept Crystal PnP Audio System Control Registers.
13. Click OK to close the Unknown Device Properties window.
14. Click Yes to shut down and restart Windows 95.

To install PC Card support for retail Windows 95

If you've installed a *retail* version of Windows 95, you'll need to install PC Card support. This driver is located on the OmniBook's hard drive or on the *Recovery CD* in \Omnibook\Drivers\Win95\Pccard\950aonly.

1. From Control Panel, double-click System.
2. Click Device Manager.
3. Under PCMCIA Socket, double-click on the device with the red X.
4. Under General, Properties, check Device Usage to enable this device in the current profile called Original Configuration (Current).
5. Click OK.
6. The PCMCIA Installation Wizard starts.
7. Follow the on-screen instructions.
8. From Control Panel, double-click System, then click Device Manager.
9. Open PCMCIA socket then PCIC or compatible PCMCIA controller.
10. Click Resources.
11. Uncheck Use automatic settings.
12. Change the Setting based on to Basic configuration 1.
13. Confirm the Input/Output Range is 03E0 - 03E1 and there is no Interrupt setting.
14. Click OK then click Yes to confirm the manual setting.
15. Close the System Properties window.
16. From the Start menu, shut down and restart the OmniBook.

To install infrared support for retail Windows 95

If you've installed a *retail* version of Windows 95, you'll need to install infrared support. This drivers are located on the OmniBook's hard drive or on the *Recovery CD* in \Omnibook\Drivers\Win95\Irda and in \Omnibook\Drivers\Win95\Fastir.

1. Go to the infrared drivers directory (\Omnibook\Drivers\Win95\Irda) and copy the .INF files to C:\Windows\Inf.
2. If prompted to overwrite old files, click Yes.
3. Reboot the OmniBook.
4. When you see the HP logo, press F2 to enter the BIOS Setup utility.
5. Go to the System Devices menu.
6. Set the Infrared Port to Enabled.
7. Set the Mode to FIR.
8. Set the Base I/O address to either 2F8 IRQ3 or 3F8 IRQ4.
9. If necessary, set the DMA Channel to DMA 3.
10. For best performance, set the Parallel Port Mode to EPP.
11. Save and exit the BIOS Setup utility.
12. When prompted for a driver disk, select the driver disk provided by the hardware manufacturer, then click OK.
13. Enter the directory of the infrared drivers (\Omnibook\Drivers\Win95\Fastir) and click OK.
14. Go to \Omnibook\Drivers\Win95\Irda and run SETUP.
15. Click Next to run the Add Infrared Device Wizard.
16. Click Next to accept the built-in infrared port on laptop.
17. Select SMC IrCC (Fast Infrared) Hardware and Driver, then click Next.
18. Click Next to accept the default ports (COM4 and LPT3).
19. Click Finish.
20. Run Windows Explorer.
21. From the View menu click Options.

22. Select Show all Files and deselect Hide MS-DOS file extensions for file types that are registered, then click OK.
23. Right-click on SMCIRLAP.INF in the \Omnibook\Drivers\Win95\Fastir directory.
24. Click Install off the pop-up menu.
25. If prompted for the location of SMCIRLAP.INF enter \Omnibook\Drivers\Win95\Fastir, then click OK.
26. Shut down and restart Windows 95.

To install touch pad support for retail Windows 95

The touch pad works with the built-in Windows 95 mouse driver. This driver supports the basic features of the touch pad, but not the enhanced features. To activate full touch pad capabilities, you'll need to install touch pad support.

1. Shut down any programs that are currently open.
2. Click Start, Run, enter the path of SETUP.EXE (for example, C:\Omnibook\Drivers\Win95\Touchpad\Setup.Exe).
3. Click Next, and then next again to continue.
4. Click Next to select the recommended installation directory.
5. Click Next to verify current settings.
6. Shut down and restart Windows 95 to activate the touch pad driver. (If you need to install other components, do not restart at this time.)

To disable automatic CD-ROM detection

Windows 95 automatically detects a CD when you insert it. However, this prevents the OmniBook from automatically turning off after a period of inactivity if the CD-ROM drive is installed. You can disable this feature with the following procedure.

1. From Control Panel, double-click System, then click Device Manager.
2. Double-click CD-ROM drive.
3. Select the CD-ROM driver displayed, then click Properties.
4. Click Settings, then uncheck Auto Insert Notification.
5. Click OK to close the CD-ROM Properties window.
6. Click OK to close the System Properties window.
7. Click Yes to restart Windows 95.

Installing Retail Windows NT 4.0

If you install a *retail* version of Windows NT 4.0 you'll also need to manually install video, audio, touch pad, Advanced Power Management (APM), and Card Executive drivers.

This section describes how to

- ◆ Install a retail version of Windows NT 4.0.
- ◆ Install Service Pack 3 for Windows NT 4.0.
- ◆ Install video support for retail Windows NT 4.0.
- ◆ Install audio support for retail Windows NT 4.0.
- ◆ Install Phoenix Advanced Power Management for Windows NT 4.0.
- ◆ Install Phoenix Card Executive 2.x for retail Windows NT 4.0.

To install a retail version of Windows NT 4.0

If you are installing Windows NT networking, install it *after* fully installing Windows NT. Follow the instructions in the application note for the network card you are using. The application notes are available on the OmniBook website: <http://www.hp.com/omnibook>.

Requirements

- OmniBook 2100/3100 with internal CD-ROM drive.
- 32 MB memory (64 MB recommended).
- OmniBook *Recovery CD*.
- Retail *Windows NT Workstation CD*.

1. Shut down the OmniBook and insert the CD-ROM drive in the module bay.
2. Connect the ac adapter and turn on the OmniBook.
3. When you see the HP logo, press F2 to enter the BIOS Setup utility.
4. From the Boot menu, select CD-ROM as the first boot device. (*You may want to change the boot order back to Diskette Drive after completing this procedure.*)
5. Insert the *Recovery CD* into the CD-ROM drive.
6. Press F10, then ENTER to save and exit the BIOS Setup utility.
7. When prompted, select "Create Hibernate Partition."
8. Select "Y" to erase the hard disk and create a hibernate partition.
9. When prompted for "Hibernate" partition size, we recommend that you select the default, which varies depending on whether your OmniBook has one or two RAM slots.
10. When finished, removed the *Recovery CD* and insert the *Windows NT Workstation CD* in the CD-ROM drive.
11. Press CTRL+ALT+DEL to reboot the OmniBook.
12. Follow the on-screen instructions. Select the setup defaults unless this procedure notes otherwise.

Important

When choosing a file system, refer to the *Windows NT Resource Kit* for a detailed discussion of FAT and NTFS file systems.

13. When prompted, choose No, Do Not Create An Emergency Repair Disk, then click Next.

If is more useful to create a repair disk after installation is complete and after you have installed your drivers and other applications.

14. When prompted, choose Do Not Connect The Computer To A Network At This Time,” then click Next.

Connect to a network after initial installation is complete.

15. Continue following the Window NT setup instructions.

To install Service Pack 3 for retail Windows NT 4.0

If you've installed a *retail* version of Windows NT 4.0, you'll need to install Service Pack 3. This is located on *Recovery CD* in the root directory \NT4_SP3.

1. Connect the ac adapter and turn on the OmniBook.
2. From the Start menu, click Run.
3. From the CD-ROM drive, run \NT4_SP3\i386\UPDATE, for example, D:\NT4_SP3\i386\Update.

To install video support for retail Windows NT 4.0

If you've installed a *retail* version of Windows NT 4.0, you'll need to install video support. The driver is located on the *Recovery CD* in \Omnibook\Drivers\Nt40\Video.

1. Insert the *Recovery CD* into the CD-ROM drive.
2. From Control Panel, double-click Display, then click Settings.
3. Click Display Type, then click Change.
4. Click Have Disk in the Change Display window.
5. Type the CD-ROM drive letter followed by \Omnibook\Drivers\Nt40\Video, then click OK.

For example: D:\Omnibook\Drivers\Nt40\Video.

6. Select NeoMagic MagicGraph 128XD, then click OK.
7. Click Yes to proceed.
8. Click OK to accept that the driver was installed correctly.
9. Click Close in the Display Type window. (The new driver will not take effect until after Windows NT has restarted.)
10. Click Close in the Display Properties window.
11. Click Yes to restart the computer (If you need to install other components, do not restart at this time).
12. When Windows NT restarts, it displays a message that a new graphics driver has been installed. When you see this message, click OK.
13. Select the following resolution, click Test, click OK.
1024 x 768 for OmniBook 3100
800 x 600 for OmniBook 2100
14. If the graphic is correctly displayed, click Yes, otherwise click No and change the setting.
15. Click OK.

To install audio support for retail Windows NT 4.0

If you've installed a *retail* version of Windows NT 4.0, you'll need to install audio support. The driver is located on the *Recovery CD* in \Omnibook\Drivers\Nt40\Audio.

1. Insert the *Recovery CD* into the CD-ROM drive.
2. From Control Panel, double-click Multimedia, then click Devices.
3. Select Audio Devices, then click Add.
4. Select Unlisted or Updated Driver, then click OK.
5. Type the CD-ROM drive letter followed by \Omnibook\Drivers\Nt40\Audio, then click OK.

For example: D:\Omnibook\Drivers\Nt40\Audio.

6. When prompted to install the CrystalWare Audio Driver, then click OK.
7. If prompted that a driver exists, choose New to install the new driver.
8. Click OK to close the CrystalWare Audio Driver window.
9. When prompted, restart Windows NT to activate the sound driver. (If you need to install other components, do not restart at this time.)

Using the Recovery CD

Installing Retail Windows NT 4.0

To install APM for Windows NT 4.0

You need to install Advanced Power Management for Windows NT 4.0 for both the retail *and* factory-installation. The driver is located on the *Recovery CD* in \Omnibook\Drivers\Nt40\Apm.

Phoenix APM 2.0 adds the following capabilities to the OmniBook:

- Improved battery life under Windows NT 4.0.
- PC Card power management.
- Convenient user control and monitoring of power settings and status.

For Retail Windows NT 4.0

1. Insert the *Recovery CD* into the CD-ROM drive.
2. From the Start menu, click Run.
3. From the CD-ROM drive, run \Omnibook\Drivers\Nt40\Apm\Setup.exe.
For example: D:\Omnibook\Drivers\Nt40\Apm\Setup.exe.
4. Click the APM button to start installation.
5. Follow the setup instructions on the screen.

For Windows NT 4.0 Factory Installation

1. Click Start, Programs, OmniBook, Phoenix Advanced Power Management, Setup.
2. Follow the setup instructions on the screen.

You can download the Phoenix APM documentation from the following website:
<http://www.phoenix.com/notebook/addinfo.html>.

To install Card Executive 2.x for retail Windows NT 4.0

To take advantage of Card Executive's plug-n-play for PCMCIA network cards, you must install Card Executive before installing Windows NT networking. The driver is located on the *Recovery CD* in \Omnibook\Drivers\Nt40\Pccard.

Card Executive adds the following capabilities to your OmniBook:

- Plug and Play for PC Cards using standard Windows NT drivers.
- Plug and Play for supported network PC Cards.
- Automatic configuration of PC Cards utilizing advanced "Wizard" technology to allocate system resources.
- Suspend/Resume functions and simplified administration of PC Cards when integrated with Phoenix Card Executive.

1. Insert the *Recovery CD* into the CD-ROM drive.
2. From the Start menu, click Run.
3. From the CD-ROM drive, run \Omnibook\Drivers\Nt40\Pccard\Setup.exe.
For example: D:\Omnibook\Drivers\Nt40\Pccard\Setup.exe.
4. Click the button to begin the installation process.
5. Click OK.
6. Click Restart Now.
7. After reboot, click Next to run the PC Card Diagnostics.
8. Click Next to start the Diagnostics.
9. Click Finish to reboot.

The PC Card icon appears on the Taskbar.

You can download the Phoenix Card Executive documentation from the following website: <http://www.phoenix.com/notebook/addinfo.html>.

To disable automatic CD-ROM detection

Windows NT automatically detects a CD when you insert it. However, this prevents the OmniBook from automatically turning off after a period of inactivity if the CD-ROM drive is installed. You can disable this feature with the following procedure.

1. From Start Menu, click Run.
2. Enter REGEDT32, then click OK.
3. Select the HKEY_LOCAL_MACHINE window and go to
System\CurrentControlSet\Services\Cdrom
4. Double click Autorun.
5. Enter 0 and click OK.
6. Close the Registry Editor and restart Windows NT 4.0.

Recovering OmniBook Files

This section describes how to

- ◆ Install the OmniBook online *User's Handbook*.
- ◆ Recover a damaged *Recovery CD* or hard disk drive.
- ◆ Update the OmniBook BIOS.

To install the online *User's Handbook*

You can install the online *User's Handbook* from the *Recovery CD*. This also installs OmniBook Notes and Support files to your hard drive.

1. Connect the ac adapter to the OmniBook.
2. Install the CD-ROM drive in the OmniBook.
3. Insert the *Recovery CD* in the CD-ROM drive.
4. From the \OmniBook\Hputils\Disk1 directory on the CD, double-click SETUP.EXE. The OmniBook Application Software Setup screen appears.
5. Click Next.
6. Click "OmniBook Online Documentation."
7. Click Install Now.

To replace a damaged *Recovery CD*

If you lose or damage the *Recovery CD*, take your OmniBook and Certificate of Authenticity to an HP Service Center to be replaced. If you mail your OmniBook for this service, you *must* provide a photocopy of the Certificate of Authenticity along with payment.

To update the OmniBook BIOS

Hewlett-Packard may update the BIOS to enhance the capabilities of the OmniBook. Updates will be available from HP Electronic Support Services.

CAUTION

Because a BIOS update replaces the previous version, it is very important you follow these instructions exactly. Otherwise, the OmniBook may be damaged.

The BIOS update process resets the configuration settings in the BIOS Setup utility except for the PC Identification and Password.

1. From the Start menu, shut down the OmniBook.
2. Connect the ac adapter to the OmniBook.
3. Remove any PC Cards.
4. Insert the BIOS Update disk in the floppy disk drive.
5. Press the blue power button.
6. If prompted, choose the correct language.
7. When prompted, press C. This starts a process that takes approximately 1 minute.
8. When prompted, insert a paperclip into the system-off recess. This starts the update process. *Once it begins, do not interrupt the update process.*

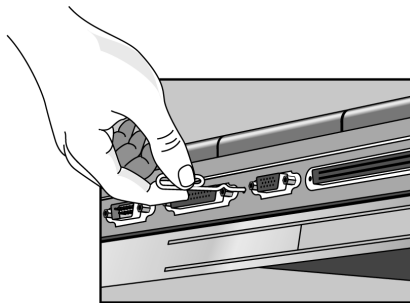

———— Troubleshooting

Troubleshooting

If you run into problems with your OmniBook, you can use the suggestions in this chapter for getting back on track.

If you have questions that this manual doesn't answer, you can

- Look at the online Help for Windows and other applications.
- Find technical information about the OmniBook on the Internet—visit the Support website at <http://www.hp.com/omnibook>.
- See other books about Windows, MS-DOS, and other applications. Check your local library or bookstore.
- Contact your dealer, or contact Hewlett-Packard—see the *OmniBook Support and Service* booklet or OmniBook Support in the online OmniBook Library.
- Get information about system resources (interrupts, addresses, and memory), see “Software System Resources” on page 8-6.

Solving Problems

If your OmniBook has a problem, find the symptom below that matches your situation. Try the suggestions one at a time.

Accessory Module Problems

If a port on a dock isn't working

- Check that ac power is connected.
- Try using the corresponding OmniBook port, while undocked.

If you can't boot from a CD in the CD-ROM drive

- Make sure the CD is a bootable CD, such as the *OmniBook Recovery CD*.
- Press ESC twice during bootup to see if the CD-ROM drive is the first boot device.
- Make sure the CD-ROM drive is seated correctly—remove and reinsert.
- If you always want to boot from a CD, check the boot order in BIOS Setup.
 1. From the Start menu, shut down, then restart the OmniBook.
 2. When you see the HP logo, press F2 to enter the BIOS Setup utility.
 3. Open the Boot menu. The default boot order is
 - Diskette Drive
 - Hard Drive
 - CD-ROM Drive
 4. If CD-ROM Drive is not option 1, use the arrow keys to select CD-ROM Drive.
 5. Press F6 to move up (or F5 to move down) in the list.
 6. Press F10 to Save and Exit the BIOS Setup utility.
- Make sure you are using an internal OmniBook CD-ROM drive. You cannot boot from an external CD-ROM drive, which you can connect to the OmniBook via a PC Card SCSI connection.
- Reset the OmniBook.

Troubleshooting
Solving Problems

If you can't boot from a floppy in the floppy disk drive

- Make sure the floppy drive is seated correctly—remove and reinsert.
- Check the boot order in BIOS Setup.
 1. From the Start menu, shut down, then restart the OmniBook.
 2. When you see the HP logo, press F2 to enter the BIOS Setup utility.
 3. Open the Boot menu. The default boot order is
 - Diskette Drive
 - Hard Drive
 - CD-ROM Drive
 4. If Diskette Drive is not option 1, use the arrow keys to select Diskette Drive.
 5. Press F6 to move up (or F5 to move down) in the list.
 6. Press F10 to Save and Exit the BIOS Setup utility.
- Check that the Floppy Boot option in the BIOS Setup utility is enabled.
- Reset the OmniBook.

If the Zip drive isn't working

- Make sure the Zip disk is inserted correctly.
- Reset the OmniBook.
- Make sure the Zip drive module is seated correctly—remove and reinsert.

Audio Problems

If sounds aren't audible

- Check that the volume is not muted. Press Fn + F7 to toggle muting on and off.
- Press Fn + UP-ARROW to increase the volume.
- Double-click the speaker icon on the taskbar to ensure that Mute is not checked.
- Check settings in BIOS Setup.
 1. From the Start menu, shut down, then restart the OmniBook.
 2. When you see the HP logo, press F2 to enter the BIOS Setup utility.
 3. From the System Devices menu, check that Audio is enabled.

If you hear a loud high-pitched whine (feedback) from the speakers

- Press Fn+F7 to stop the noise.
- Try reducing the Master volume (Start, Programs, Multimedia, Volume Control).

If sound doesn't record

- Check settings in BIOS Setup.
 1. From the Start menu, shut down, then restart the OmniBook.
 2. When you see the HP logo, press F2 to enter the BIOS Setup utility.
 3. From the System Devices menu, check that Audio is enabled.
- Check software controls for recording sound (Start, Programs, Accessories, Multimedia, Sound Recorders).

Display Problems

If the OmniBook is on, but the screen is blank

- Press the space bar to see if the computer is in Standby mode.
- Press Fn+F1 or Fn+F2 to adjust the display.
- Press Fn+F5 in case the internal display was disabled. (Do this three times to return to the state you started from.)
- If the OmniBook is cold, allow it to warm up.

If the screen is difficult to read

- Check whether the display resolution is set to its default setting, 1024 × 768 (XGA) or 800 × 600 (SVGA). Check this in Start, Settings, Control Panel, Display, Settings.
- Check brightness (Fn+F2 to increase brightness).

Hard Disk Drive Problems

If the OmniBook's hard drive doesn't spin

- Check the power source.
- Remove and reinsert the hard drive. See page 5-3 for instructions.

If the hard disk makes buzzing or whining noise

- Back up the drive immediately.
- Check for alternate noise sources, such as the fan or a PC Card drive.

If files are corrupted

For Windows 95 and Windows NT 4.0

- Run the McAfee VirusScan program (see page 2-18 for instructions).
- For Windows 95

If you're using Windows 95, you can run the Scandisk surface scan to check the platter. (This is not available in Windows NT 4.0). From the Start menu, click Programs, Accessories, System Tools, Scandisk.

- For Windows NT 4.0

Right click on the drive, then click Properties, Tools, Error Checking.

Infrared Problems

If you have problems with infrared communications

- Windows NT 4.0 does not support infrared devices.
- Make sure the infrared light path is not blocked.
- Line up the OmniBook's infrared port and the other infrared port in as straight a line as possible. The two ports should be no more than 1 meter apart, with no obstructions in between. Noise from nearby equipment can cause transmission errors.
- Check settings in BIOS Setup utility.
 1. From the Start menu, shut down, then restart the OmniBook.
 2. When you see the HP logo, press F2 to enter the BIOS Setup utility.
 3. From the System Devices menu, check that Infrared Port is enabled.
 4. Press F10 to save and exit the BIOS Setup utility.
- For infrared communications, an infrared driver must be installed and a BIOS Setup setting must be enabled. See page 4-14.
- Check that only one application is using the infrared port.
- Standard IrDA and fast-IrDA are incompatible (they use different drivers).
- For fast-IrDA, check for DMA conflict with ECP parallel port.
- Remove any PC Cards. An infrared IRQ conflict is possible if two PC Cards are plugged in at the same time.

If an infrared printer doesn't print

- Windows NT 4.0 does not support infrared printing.
- Make sure the infrared light path is not blocked.
- An infrared driver must be installed and the BIOS Setup setting must be enabled. For details, refer to the driver's Readme file located in \OmniBook\Drivers.
- In Windows Help, use the Print Troubleshooter.

Keyboard and Pointing Device Problems

If the embedded numeric keypad doesn't work

- Make sure Num Lock is on (Fn+F9).
- Make sure the embedded Keypad Lock (Fn+F8) is on—or that you press and hold the Fn key to temporarily access the embedded keypad.
- Don't touch the pointing stick or the touch pad while booting or resuming.

If the pointer is difficult to control

- To customize all pointing devices, use the Mouse icon in Control Panel to go to Mouse Properties.
- If the touch pad driver has been installed, Mouse Properties includes a tab that allows you to customize the operation of the touch pad.
- Reset the OmniBook.

If the touch pad doesn't work

- Make sure that there is not an external mouse connected to the OmniBook.
- If you just disconnected an external mouse, try exiting and restarting Windows to make the internal touch pad active again.
- Press the blue power button to turn off the OmniBook, then turn it on again without moving the pointer.
- Reset the OmniBook.

Memory Problems

If a message says you are out of memory

- In Windows Help, use the memory troubleshooter.
- If you are having memory problems running MS-DOS programs, in Windows Help search for MS-DOS troubleshooter.

If memory is less than expected

The maximum supported amount of RAM using HP memory modules is

- 288 MB if your OmniBook has two expansion slots and a Pentium II processor.
- 192 MB if it has two expansion slots and a Pentium processor.
- 160 MB if it has one expansion slot and a Pentium processor.

Check your Intel label to see if your processor is Pentium or Pentium II.

- You may have exceeded the 32 MB RAM size restriction in the RAM slot nearest to the corner of the computer. This restriction applies to OmniBooks with Pentium processors. This restriction does *not* apply to Pentium II processors. Use a smaller RAM module in this slot.
- Pentium II models cannot detect EDO RAM modules. Use only SDRAM modules with this processor.

PC Card (PCMCIA) Problems

If the OmniBook doesn't recognize a PC Card

- Make sure Card Executive is installed for Windows NT.
- Remove and reinsert the PC card.
- If the card requires an IRQ, check that there is one available.
 - If you're using Windows 95, look in Device Manager, Properties, Interrupt Request (IRQ).
 - If you're using Windows NT, click Start, Programs, Administrative Tools, Windows NT Diagnostics.
- Check the OmniBook website for information about supported PC Cards.
- Try the card in another computer.
- Reboot the OmniBook.
- Windows NT 4.0 requires that you install Phoenix Card Executive drivers. See page 6-21 for instructions.

Performance Problems

If the OmniBook gets hot

- It is normal for the computer to get warm.
- Make sure the air vents are clear.
- DOS games and other programs that drive CPU usage toward 100% can contribute to a temperature increase.

If the OmniBook pauses or runs sluggishly

- Press CTRL+ALT+DEL to see if an application is not responding.
- Reboot the OmniBook.
- Delete temporary and unneeded files.
- This may be normal Windows behavior (background processing can affect response time).
- Check the BIOS Setup settings.
 1. From the Start menu, shut down, then restart the OmniBook.
 2. When you see the HP logo, press F2 to enter the BIOS Setup utility.
 3. From the Power menu, set the Power Management Mode to Max. Performance.
 4. Press F10 to Save and Exit the BIOS Setup utility.
- Certain background operations (such as virus scans) can affect performance while they're running.
- Some file browsers may be unresponsive while they're processing a graphic image or waiting for broken network connections to time out.
- Install additional memory if Windows is spending a lot of time swapping to disk.
- Check amount of available free disk space.
- Try disabling Advanced Power Management.

Power and Battery Problems

If the OmniBook turns off immediately after it turns on

- Battery power is probably extremely low. Plug in the ac adapter, insert a new charged battery module, or insert a secondary battery in the plug-in module bay.

If the OmniBook keeps beeping

- The OmniBook beeps for 15 seconds when the battery is low. Save your work, quit immediately, and insert a charged battery or plug in the ac adapter.

If the OmniBook has a short operating time

- Try conserving power using any of the suggestions listed under “To save battery power” on page 3-9.
- If you are running any applications with an automatic save feature, such as MS Word for Windows, disable this feature.
- If the operating time has gotten shorter and the battery is more than a year or two old, you may need to replace the battery.
- Turn down the display brightness (Fn+F1).
- Heavy modem use can affect battery operating time.
- Check the Power Management settings in BIOS Setup.
 1. From the Start menu, shut down, then restart the OmniBook.
 2. When you see the HP logo, press F2 to enter the BIOS Setup utility.
 3. From the Power menu, make sure the Power Management Mode is set to Maximum Power Savings.
 4. Press F10 to Save and Exit the BIOS Setup utility.

If the battery doesn't charge

- Make sure the ac adapter is plugged into the power source.
- Check that the light on the ac adapter is on.
- Check that the battery is fully installed and locked in place.

Solving Problems

- Turn off the OmniBook, then check that the battery contacts are clean and that the ac adapter cables are fully plugged in.
- Move the OmniBook away from any nearby heat source. Unplug the ac adapter and allow the battery to cool down. An elevated battery temperature prevents charging.
- If available, try another battery and ac adapter.

If the secondary battery doesn't charge

- The OmniBook's secondary battery doesn't charge until the main battery is fully charged.
- Make sure the ac adapter is plugged into the power source.
- Check that the light on the ac adapter is on.
- Check that the secondary battery module is fully installed and locked in place.

If the OmniBook stops responding

- Press CTRL+ALT+DEL to end the application that is not responding.
- Press the blue power button to suspend the OmniBook. Then press the blue button again to turn the OmniBook back on.
- If nothing happens, insert a paper clip into the system-off button. Press the blue power button to turn the OmniBook on.

If the OmniBook doesn't suspend as expected

- If you have a connection to another computer, the OmniBook doesn't suspend if the connection is actively in use.
- If the OmniBook is performing an operation, it normally waits for the operation to finish.
- Check the Power Button Mode in the BIOS Setup utility (Power menu). You can configure the power button to either suspend or shut down the OmniBook.

Printing Problems

Hint

For most printing problems, use the Print Troubleshooter in Windows Help.

If a serial or parallel printer doesn't print

- Check that you are using a proper cable or cable adapter, and that the printer is on.
- Check for paper in the printer or other printer errors.
- Make sure the printer cable is secure at both ends.

If an infrared printer doesn't print

- Windows NT 4.0 does not support infrared devices.
- From Control Panel, Infrared, check that your infrared printer is detected.
- Make sure the infrared light path is not blocked.
- Check for paper in the printer or other printer errors.
- Make sure Windows is running—infrared printing is supported only while Windows is running.
- An infrared driver must be installed and the BIOS Setup setting must be enabled. For details, refer to the driver's Readme file (located in \Omnibook\Drivers).
- In Windows Help, use the Print Troubleshooter.

If the left edge of printed output is missing

- If the printer you are using is a 600-dpi (dots per inch) printer, try selecting a compatible printer driver for a 300-dpi printer. For example, for a 600-dpi HP LaserJet printer, try using the HP LaserJet IIIsi driver (300-dpi). Certain applications may not work properly with 600-dpi printers.

Serial, Parallel, and USB Problems

If the serial mouse doesn't work

- First, confirm that you have followed the manufacturer's installation instructions completely and have installed the mouse properly.
- Check the port connection (may be loose).

If a serial modem doesn't work properly

- In Windows Help use the modem troubleshooter.
- Check the port connection (may be loose).

If an I/O card stops communicating properly

- It may have been reset if the OmniBook suspended or turned off. Exit and restart the application.

If the serial or parallel port is not working

- Check the port connection (may be loose).
- Check settings in BIOS Setup.
 1. From the Start menu, shut down, then restart the OmniBook.
 2. When you see the HP logo, press F2 to enter the BIOS Setup utility.
 3. From the System Devices menu, check that Parallel and Serial are enabled.

If the USB port is not working

- Windows NT 4.0 does not support USB devices.
- Contact the vendor of the peripheral device, as well as Hewlett-Packard, for the latest versions of the USB drivers.

Startup Problems

If the OmniBook doesn't respond at turn-on

- Connect the ac adapter.
- Press blue power button to try turning on the unit.
- Reset the OmniBook.

If you get no response, remove the battery and ac adapter—then plug in the ac adapter and try resetting. If you still get no response, the unit requires service.

If the OmniBook doesn't boot from battery power

- Make sure the battery is properly inserted.
- Check battery level on status panel.
- Check battery contacts. If available, try another battery.

If the OmniBook doesn't boot from the floppy disk drive

- Check settings in BIOS Setup utility.
 1. From the Start menu, shut down, then restart the OmniBook.
 2. When you see the HP logo, press F2 to enter the BIOS Setup utility.
 3. Open the Boot menu. The default boot order is
 - Diskette Drive
 - Hard Drive
 - CD-ROM Drive
 4. If Diskette Drive is not option 1, use the arrow keys to select Diskette Drive.
 5. Press F6 to move up (or F5 to move down) in the list.
 6. Press F10 to Save and Exit the BIOS Setup utility.
 7. From the Security menu, check the Floppy Boot is enabled.

Testing the Operation

The OmniBook hardware diagnostic program provides two levels of testing:

- Automated testing using the basic hardware test.
- Advanced testing using the individual hardware tests.

The tests are designed to run after the system reboots. This ensures that the computer will be in a predictable state, so the diagnostic program can properly test the hardware components. The tests are non-destructive and are intended to preserve the state of the computer. The OmniBook reboots when you exit the program so drivers can be loaded.

To create a diagnostic floppy disk

After inserting a formatted floppy disk in the floppy drive, do one of the following to create a diagnostic floppy disk:

- On an OmniBook with a factory software installation, run **diaginst** from the `\Dmi\Hpdiags` directory on the hard disk.
–or–
If HP TopTools is installed, use the DiagTools page to create the disk.
- On any computer with a CD-ROM drive, run **diaginst** from the `\Omnibook\Drivers\Hputils` directory on the OmniBook *Recovery CD*.
- On any computer with World Wide Web access, download the diagnostic software package from the OmniBook website at <http://www.hp.com/omnibook>. Run this file to unpack the files, then run **diaginst** to create the diagnostic disk.

To run the diagnostic test

1. Insert the diagnostic disk in the floppy drive.
2. Reboot the OmniBook.
3. Go through the first several screens.
4. When the hardware detection finishes, check the list of detected hardware.

Hint

If a device is not detected or fails its test below, it may be configured incorrectly in the BIOS Setup utility. You can confirm the problem by running BIOS Setup and checking the settings.

5. **Run the basic test.** Press F2 to start the basic hardware test.
6. If you intend to exit without running advanced tests, press F4 to save system and test information in the Support Ticket log file, HPSUPPT.TXT. Then remove the diagnostic disk and press F3 to exit.
7. **Optional: Run the advanced tests.** Press F2 to open the advanced test screen.
8. Select and run the appropriate tests. Tests are not listed if no such hardware is detected. Press the following keys to run tests:

ENTER	Runs the highlighted test.
F5 or SPACE	Marks or unmarks the highlighted test.
F6	Marks or unmarks all tests in the current menu.
F7	Marks or unmarks all tests in all menus.
F10	Runs all marked tests.
9. When you are finished running tests, press ESC to exit the advanced tests.
10. **Optional:** Press F4 to save system and test information in the Support Ticket log file, HPSUPPT.TXT.
11. **Exit.** Press F3 to exit and reboot.
12. **Optional: Check the log.** On any computer, open the HPSUPPT.TXT log file on the diagnostic disk using Notepad or other text editor. It contains a list of all test results and errors.

**Specifications and Regulatory
Information**

Specifications and Regulatory Information

Your OmniBook is designed to provide trouble-free operation. The following suggestions can help you maintain its dependability:

- Observe the temperature limits and other specifications listed in the next section.
- If you have problems, see the problem-solving suggestions in chapter 7 of this manual.
- If you think your OmniBook might need repair service, see the warranty and service information in the *Support and Service* booklet.

To contact Hewlett-Packard

If you have questions that this manual and the online OmniBook manuals don't answer (even after looking in the contents and index), you can contact Hewlett-Packard at the address or phone number listed in the *Support and Service* booklet or in OmniBook Support in the online OmniBook Library. Please have your OmniBook with you.

To clean the OmniBook

You can clean the OmniBook with a soft cloth dampened either in clean water or in water containing a mild detergent. Do not use an excessively wet cloth nor allow water inside the case. Do not use any abrasive cleaners, especially on the display. Do not apply any cleaner directly to the display. Instead, apply the cleaner to a soft cloth and then gently wipe the display. You can clean the keyboard with a vacuum cleaner to remove accumulated dust.

Hardware Specifications

Physical Attributes	<p>OmniBook 2100 Size: 29.9 × 23.7 × 4.6 cm (11.75 × 9.2 × 1.8 in) closed. Weight: 2.9 kg (6.4 lb).</p> <p>OmniBook 3100 Size: 30.3 × 23.7 × 4.9 cm (11.9 × 9.2 × 1.9 in) closed. Weight: 3.0 kg (6.7 lb).</p>
Processor and Bus Architecture	<p>Intel Mobile Pentium or Pentium II processor with MMX technology. Intel sub-2V low-power processor. 512-KB burst-synchronous L2 cache. 32-bit PCI bus.</p>
Graphics	<p>OmniBook 2100 12.1-inch SVGA active matrix (TFT) display (800 × 600 × 16M colors). –or– 12.1-inch SVGA dual-scan (DSTN) display (800 × 600 × 16M colors).</p> <p>OmniBook 3100 13.3-inch XGA active-matrix (TFT) display (1024 × 768 × 64K colors). PCI local bus video; 128-bit NeoMagic NM 2160 (NMG4) graphics controller with 2-MB video RAM integrated.</p>
Power	<p>Rechargeable Lithium Ion or Nickel Metal Hydride battery with built-in four-level fuel gauge. Secondary Lithium Ion battery for use in module bay. Advanced Power Management (APM 1.2) and ACPI 1.0 ready. Low-battery warning. Suspend/resume capability. Battery life: up to 3 hours (varies with type of usage) for one battery; up to 6 hours with dual battery operation. AC adapter 100 to 240 Vac (50 to 60 Hz) input; 19 Vdc, 3.16 A output.</p>
Mass Storage	<p>4.0-, 3.2-, or 2.1-GB removable hard drive. 1.44-MB internal/external floppy drive (swap with secondary battery and other drives below). Removable 24 x CD-ROM drive (24 x maximum). Optional removable Zip drive. Optional removable DVD drive.</p>
RAM	<p>32-MB RAM on board. The maximum supported amount of RAM using HP memory modules is 288 MB if your OmniBook has two expansion slots and a Pentium II processor, 192 MB if it has two expansion slots and a Pentium processor, or 160 MB if it has one expansion slot and a Pentium processor. <i>Check your Intel label to see if your processor is Pentium or Pentium II.</i></p>

Specifications and Regulatory Information

Hardware Specifications

Audio System	16-bit, Sound Blaster Pro-compatible. Stereo sound via two built-in speakers. Built-in microphone. Line-in, speaker-out, and microphone-in. 3D enhanced audio.
Keyboard and Pointing Device	87/88-key touch-type full-size keyboard. Embedded keypad. Touch pad.
Input/Output	Universal serial bus (USB). 9-pin, 115,200-bps serial (16550 UART). 25-pin bi-directional ECP/EPP parallel. Video-out (up to 1024 × 768 × 64K colors) at up to 85-Hz refresh rate. PS/2 keyboard/mouse. 4-Mbps IrDA-compliant infrared. Docking connector.
Expandability	One Type III or two Type II 16-/32-bit PC Card slots. CardBus enabled. Zoomed video enabled in one slot. Plug-in module bay for accessory modules. Full line of optional docking products: port replicator, mini dock, and docking system.
Preinstalled Software	Microsoft Windows 95 or Windows NT 4.0. Advanced Power Management (APM 1.2). DMI 2.0 with HP TopTools. Online documentation. OmniBook <i>Recovery CD</i> included. Centralized worldwide BIOS and driver update service. Windows 95-compatible Plug and Play. Windows NT 4.0 PC Card Plug-and-Play.
Security Features	Two-level password protection. Drive lock. Password for docking eject. DMI-accessible electronic serial number. Kensington MicroSaver lock slot.
Environmental Limits	Operating temperature: 5 to 35 °C (41 to 95 °F). Operating humidity: 20 to 90 percent RH (5 to 35 °C). Storage temperature: -20 to 50 °C (-4 to 122 °F).

Specifications and Regulatory Information
Hardware Specifications

Major ICs	CPU: Intel Mobile Pentium or Pentium II. South Bridge: PIIX4. Video: NeoMagic NM2160 (NMG4). Audio: Crystal CS4237B. CardBus: TI PCI1220. Keyboard controller: National PC87570. Super I/O: SMC 669FR.
------------------	--

Software System Resources

Below are default values for the system resources. To see other, non-default possibilities, refer to the BIOS Setup utility, which lists port and audio device configurations in the System Devices menu.

System Resources

The tables in this section show typical resource usage as set up by the OmniBook BIOS. Plug-and-play operating systems, drivers, and BIOS setup settings may change some of the entries.

System Interrupts

0	System timer
1	Keyboard
2	Cascade to IRQ 9
3	Free (or COM2 infrared port, if enabled)
4	COM1 (serial port)
5	Crystal sound
6	Floppy drive
7	LPT1 (ECP parallel port)
8	Real-time clock
9	Free
10	Universal Serial Bus (USB) and CardBus- assigned by Windows driver
11	Free
12	Touch pad
13	Numeric data processor
14	Internal hard disk (primary IDE controller)
15	Internal CD-ROM drive (secondary IDE controller)

System Memory

00000 - 9FFFF	System memory
A0000 - BFFFF	Video
C0000 - CBFFF	VGA BIOS
CC000 - DBFFF	Free
DC000 - FFFFF	System BIOS

Valid uses for memory addresses CC000-DBFFF:

- Upper memory blocks (UMBs).
- PC Card memory windows.

System Input/Output Addresses (100-3FF)

170-177	Secondary HDD controller (internal CD-ROM)
1F0-1F7	Internal hard disk
220-22F	Crystal sound
376	Secondary HDD controller (internal CD-ROM)
378-37F	LPT1 (printer port)
388-38B	Sound
3B0-3BB	VGA adapter
3C0-3DF	VGA adapter
3E0-3E1	PCMCIA controller
3F0-3F5	Floppy controller
3F6	Primary HDD controller
3F7	Floppy controller
3F8-3FF	COM1 (serial port)

DMA Channels

0	Sound record
1	Sound playback
2	Floppy drive
3	LPT1 (ECP parallel port)
4	Cascade
5	Free
6	Free
7	Free

Safety Information

Power Cords

The power cord supplied with the OmniBook ac adapter should match the plug and voltage requirements for your local area. Regulatory approval for the ac adapter has been obtained using the power cord for the local area. However, if you travel to a different area and need to connect to a different outlet or voltage, you should use one of the power cords listed below. To purchase a power cord (including one for a country not listed below) or a replacement ac adapter (HP part number F1454A), contact your local Hewlett-Packard dealer or Sales and Service office.

Power Cords

Country	Rated Voltage and Current	HP Part Number
Canada Mexico Philippines Taiwan United States	125 Vac (3 A)	8120-6313
East and West Europe Egypt Saudi Arabia	250 Vac (2.5 A)	8120-6314
Singapore United Kingdom	250 Vac (2.5 A)	8120-6315
Australia New Zealand	250 Vac (2.5 A)	8120-6312
Japan	125 Vac (3 A)	8120-6316
India South Africa	250 Vac (2.5 A)	8120-6317
People's Republic of China	250 Vac (2.5 A)	8120-8373
Hong Kong	250 Vac (2.5 A)	8120-8699

Working In Comfort

W A R N I N G

Improper use of keyboards and other input devices has been associated with ergonomic injury. For information about reducing your risk, see the “Working in Comfort” document shipped with your OmniBook, or visit our ergonomics website, <http://www.hp.com/ergo>.

Battery Safety

- To avoid risk of fire, burns, or damage to your battery pack, do not allow a metal object to touch the battery contacts.
- The battery pack is suitable for use only with compatible OmniBook models. Check the *Support and Service* booklet for your local HP contact.
- Do not disassemble. There are no serviceable parts inside. Do not dispose of the battery pack in fire or water.
- Handle a damaged or leaking battery with extreme care. If you come in contact with the electrolyte, wash the exposed area with soap and water. If it contacts the eye, flush the eye with water for 15 minutes and seek medical attention.
- Do not expose the battery pack to high storage temperatures (above 60 °C, 140 °F).
- When the battery is not in use, store it in the battery pouch provided.
- When discarding a battery pack, contact your local waste disposal provider regarding local restrictions on the disposal or recycling of batteries.
- To obtain a replacement battery, contact your local dealer or HP sales office.
- Do not charge the battery if the ambient temperature exceeds 45 °C (113 °F).

Safety Information

Laser Safety

The CD-ROM drive used with the OmniBook is certified as a Class 1 laser device according to the U.S. Department of Health and Human Services (DHHS) Radiation Performance Standard and International Standards IEC 825 / IEC 825-1 (EN60825 / EN60825-1). This device is not considered harmful, but the following precautions are recommended:

- Ensure proper use by reading and following the instructions carefully.
- If the unit requires service, contact an authorized HP service center—see the *OmniBook Support and Service* booklet.
- Do not attempt to make any adjustment of the unit.
- Avoid direct exposure to the laser beam—do not open the unit.

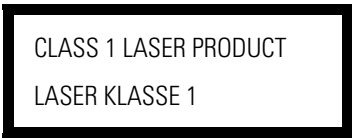

LED Safety

The infrared port located on the back panel of the OmniBook is classified as a Class 1 LED (light-emitting diode) device according to International Standard IEC 825-1 (EN60825-1). This device is not considered harmful, but the following precautions are recommended:

- If the unit requires service, contact an authorized HP service center—see the *OmniBook Support and Service* booklet.
- Do not attempt to make any adjustment of the unit.
- Avoid direct eye exposure to the infrared LED beam. Be aware that the beam is invisible light and cannot be seen.
- Do not attempt to view the infrared LED beam with any type of optical device.

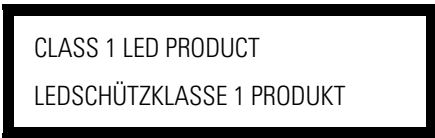

Regulatory Information

This section presents information that shows how the OmniBook complies with regulations in certain regions. Any modifications to the OmniBook not expressly approved by Hewlett-Packard could void the authority to operate the OmniBook in these regions.

U.S.A.

The OmniBook generates and uses radio frequency energy and may interfere with radio and television reception. The OmniBook complies with the limits for a Class B computing device as specified in Part 15 of FCC Rules, which provide reasonable protection against such interference in a residential installation. In the unlikely event that there is interference to radio or television reception (which can be determined by removing the unit's batteries and ac adapter), try the following:

- Reorienting or relocating the receiving antenna.
- Relocating the OmniBook with respect to the receiver.
- Connecting the OmniBook ac adapter to another power outlet.

Connections to Peripheral Devices

To maintain compliance with FCC Rules and Regulations, use properly shielded cables with this device.

For more information, consult your dealer, an experienced radio/television technician, or the following booklet, prepared by the Federal Communications Commission: *How to Identify and Resolve Radio-TV Interference Problems*. This booklet is available from the U.S. Government Printing Office, Washington, DC 20402, Stock Number 004-000-00345-4. At the first printing of this manual, the telephone number was (202) 512-1800.

Specifications and Regulatory Information

Regulatory Information

Declaration of Conformity

Responsible Party: Hewlett-Packard Company
Manager of Corporate Product Regulations
3000 Hanover Street
Palo Alto, CA 94304
(415) 857-1501

declares that the product(s)

Trade name: Hewlett-Packard Company

Product name: HP OmniBook 2100/3100

Complies with Part 15 of the FCC Rules. Operation is subject to the following two conditions:

1. This device may not cause harmful interference, and
2. This device must accept any interference received, including interference that may cause undesired operation.

Canada

This digital apparatus does not exceed the Class B limits for radio noise emissions from digital apparatus as set out in the radio interference regulations of the Canadian Department of Communications.

Le présent appareil numérique n'émet pas de bruits radioélectriques dépassant les limites applicables aux appareils numériques de Classe B prescrites dans le règlement sur le brouillage radioélectrique édicté par le Ministère des Communications du Canada.

Japan

この装置は、情報処理装置等電波障害自主規制協議会（VCCI）の基準に基づくクラスB情報技術装置です。この装置は、家庭環境で使用することを目的としていますが、この装置がラジオやテレビジョン受信機に近接して使用されると受信障害を引き起こすことがあります。

取り扱い説明書に従って正しい取り扱いをして下さい。

Europe

Products sold in Europe by Hewlett-Packard and its authorized dealers meet the specifications listed below.

Declaration of Conformity (according to ISO/IEC Guide 22 and EN 45014)

Manufacturer:	Hewlett-Packard Company
Address:	Hewlett-Packard Company Mobile Computing Division 19310 Pruneridge Ave. Cupertino, CA 95014 declares that the following product
Product name:	HP OmniBook 2100/3100
Options:	All
Safety:	conforms to the following product specifications IEC 950:1991+A1,A2 / EN 60950 (1992)+A1,A2 IEC 825-1:1993/EN60825-1:1994, Class 1
EMC:	EN 50082-1:1992 CISPR 22:1993 / EN 55022 (1994): Class B ^[1] IEC 801-2:1991 / prEN 55024-2 (1992): 4kV CD, 8kV AD IEC 801-3:1984 / prEN 55024-3 (1991): 3V/m IEC 801-4:1988 / prEN 55024-4 (1992): 0.5 kV signal lines, 1.0kV power lines
Supplementary Information:	The product herewith complies with the requirements of the Low Voltage Directive 73/23/EEC and the EMC Directive 89/336/EEC, and carries the EC mark accordingly. The HP F1454A ac adapter used with this product is designed to operate on all power systems, other than IT power systems. [1] The product was tested in a typical configuration with Hewlett-Packard personal computer peripherals.

Quality Department
Hewlett-Packard Company
Mobile Computing Division

Index

A

- ac (time-out), 1-14, 3-10
- ac adapter
 - charging battery, 3-5
 - connecting, 1-9, 3-5
 - part number, 1-3, 1-9
- accessories
 - CD-ROM drive, 4-6
 - docking products, 4-17
 - floppy drive cable, 4-5
 - ordering online, 1-4
 - plug-in, 4-3, 4-4
 - SmartCard, 1-4
 - Zip drive, 4-7
- address
 - Hewlett-Packard, 8-2
 - HP website, 1-2
 - Input/Output, 8-7
- Advanced Power Management (APM)
 - features, 3-2
 - optimizing battery life, 3-9
 - Windows NT 4.0, 6-20
- anti-static devices, 5-6
- APM. *See* Advanced Power Management
- audio
 - adjusting volume, 2-8, 7-5
 - devices (connecting), 4-8, 4-13
 - mono plugs, 4-13
 - muting, 4-13
 - troubleshooting, 7-5
- audio drivers

- Windows 95, 6-10
- Windows NT 4.0, 6-2, 6-19

B

- battery
 - charging, 3-5
 - charging light, 1-5
 - defective, 3-4
 - disposal, 8-9
 - installing secondary, 3-8
 - lights, 2-13
 - low warning, 3-5
 - operating time, 3-9
 - overheated, 3-4
 - replacement, 8-9
 - safeguards, 3-2
 - safety, 3-7
 - saving power, 3-9
 - secondary, 3-9
 - troubleshooting, 7-13
- BIOS
 - resources, 8-6
 - updating, 6-24
- BIOS Setup utility, 1-10
 - Boot menu, 1-15
 - deleting passwords, 2-18
 - Exit menu, 1-15
 - Main menu, 1-11
 - Power menu, 1-14
 - Security menu, 1-13
 - setting passwords, 2-17
 - setting time-outs, 3-10

System Devices menu, 1-12
Boot menu (BIOS), 1-15

C

cable
floppy drive, 4-5
power, 1-3
Card Executive, 6-21
cards. *See* PC Cards
CD-ROM drive
inserting CD, 4-6
opening manually, 4-6
removing CD, 4-6
channels (DMA), 8-7
charging battery, 3-5
cleaning the OmniBook, 8-2
click buttons, 1-5
clicking items, 2-5
configuring
audio devices, 8-6
BIOS settings, 1-10
system resources, 8-6
TopTools, 1-16
connecting
ac adapter, 3-5
audio devices, 4-13
external display, 4-10
external keyboard or mouse, 4-11
infrared device, 4-14
parallel device, 4-11
PS/2 device, 4-11
serial device, 4-11
serial mouse, 4-11
USB device, 4-12
copyrights, ii
cords (power), 8-8
Corporate Evaluator's Guide, 1-2
corrupted files, 7-7
creating
hibernate partition, 5-5
support utility disk, 5-5

cursor (pointer), 2-5

D

default values, 8-6
deleting password, 2-18, 3-10
destop management, 1-16
devices
anti-static, 5-6
boot order, 1-15
conflicts, 1-10
devices (external)
audio, 4-13
connecting, 4-8
display, 4-10
docking, 4-17
infrared, 4-14
parallel, 4-11
ports, 4-9
PS/2, 4-11
serial, 4-11
USB, 4-12
devices (plug-in)
CD-ROM drive, 4-6
floppy disk drive, 4-5
installing, 4-4
PC Cards, 4-15
Zip drive, 4-7
disks
CD-ROM, 4-6
floppy, 4-5
Zip, 4-7
display
DSTN, 1-3
external, 4-10
impact on operating time, 3-9
options, 4-10
TFT, 1-3
troubleshooting, 7-6
using, 2-7
DMA channels, 8-7
DMI, 1-16

- docking
 - products, 4-17
 - tray, 4-17
- documentation, 1-2
- dot matrix printer, 4-11
- dragging items, 2-5
- drive
 - CD-ROM, 4-6
 - floppy disk, 4-5
 - status icons, 2-15
 - Zip, 4-7
- drivers
 - audio, 6-10, 6-19
 - Card Executive, 6-21
 - infrared, 6-12
 - PC Card, 6-11
 - touch pad, 6-13
 - video, 6-9, 6-18
- DSTN display, 1-3
- E**
- ECP, 4-11
- enabling
 - built-in keypad, 2-10
 - display device, 4-10
 - external display, 2-10
- EPP, 4-11
- ergonomics, 8-9
- Exit menu (BIOS), 1-15
- expansion
 - hard disk drive, 5-3
 - memory, 5-7, 5-8
- extended memory, 1-11
- external
 - connections, 4-8
 - display, 2-10
 - keyboard, 2-10
- F**
- F1 through F12, 2-10
- F1454A (ac adapter), 1-3, 1-9
- factory installed operating systems, 1-8, 6-3
- FAT32, 6-2
- FDD controller, 1-12
- files
 - infrared transfer, 4-14
 - protecting, 2-20
 - recovering, 6-2
- floppy disk drive
 - connecting externally, 4-5
 - inserting/removing disk, 4-5
 - status panel icon, 2-15
- Fn key
 - + F1 (decrease brightness), 2-7
 - + F12 (hibernate), 2-10
 - + F2 (increase brightness), 2-7
 - + F3 (decrease contrast), 2-7
 - + F4 (increase contrast), 2-7
 - + F5 (display options), 4-10
 - + F6 (battery status), 2-10, 2-14
 - + F8 (keypad), 2-11
 - + R (suspend), 2-10
 - + S (standby), 2-10
- function keys, 2-10
- H**
- hard disk drive
 - hibernate partition, 5-5
 - installing, 5-3
 - lock, 2-20
 - removing, 5-4
 - replacing, 5-3
 - security, 2-20
 - time-out, 1-14
 - troubleshooting, 7-7
- hibernate
 - hot keys, 2-10
 - mode, 2-3, 2-10
 - partition, 5-5
 - status lights, 2-13
 - time-out, 1-14, 3-10
- holder (HDD), 5-4

hot keys, 2-10
HP applications, 6-23

I

icons
 drive, 2-15
 keyboard, 2-15
 power, 2-14
IDE controller, 1-12
infrared
 1/0 address, 1-12
 DMA channel, 1-12
 drivers (Windows 95), 6-12
 light path, 7-8
 mode, 1-12
 port (connecting), 4-14
 printing, 7-8
InkJet printer, 4-11
inserting
 CD, 4-6
 floppy disk, 4-5
 PC Card, 4-15
 RAM expansion module, 5-7
 Zip disk, 4-7
installing
 docking tray, 4-17
 hard disk drive, 5-3
 main battery, 3-7
 McAfee VirusScan, 2-18
 operating systems, 6-2
 PC Cards, 4-15
 plug-in modules, 4-3
 RAM, 5-7
 secondary battery, 3-8
 Windows 95 (factory build), 6-4
 Windows NT 4.0 (factory build), 6-5
 Windows NT 4.0 (retail), 6-16
instant-on, 2-3
internal microphone, 1-5
internal speaker, 1-5
interrupts (system), 8-6

K

Kensington lock, 2-19
keyboard
 embedded keypad, 2-11
 Fn hot keys, 2-10
 non US, 2-12
 num lock, 2-11
 numeric keypad, 2-10
 status icons, 2-15
 troubleshooting, 7-9
 Windows keys, 2-11
keypad (embedded), 2-11

L

laser
 printer, 4-11
 safety, 8-10
LED safety, 8-10
license agreement, iii
lights
 ac adapter, 1-9
 battery, 2-13
 battery charge remaining, 2-13
 infrared, 7-8
 power, 2-13
low battery
 charging, 3-5
 condition, 3-2
 warning, 3-5

M

main battery
 installing, 3-7
 location, 1-5
Main menu (BIOS), 1-11
McAfee VirusScan, 2-18
memory. *See* RAM
modes
 power, 2-3
 Smart CPU, 1-14, 3-10
mono plugs, 4-13

- mouse
 - PS/2, 4-11
 - serial, 4-11
- moving the pointer
 - touch pad, 2-5
- N**
- notice (legal), ii
- O**
- off
 - button, 1-5, 2-3
 - status lights, 2-13
- OmniBook
 - cleaning, 8-2
 - documentation, 1-2
 - features, 1-5
 - starting and stopping, 2-3
- OmniBook Notes, 1-2
- on button, 1-5
- P**
- parallel device
 - connecting, 4-11
 - troubleshooting, 7-16
- part numbers
 - ac adapter, 1-3
 - battery, 1-3
- partition (hibernate), 5-5
- PC Cards
 - inserting, 4-15
 - plug and play, 6-21
 - removing, 4-16
 - saving power, 3-9
 - troubleshooting, 7-11
 - types, 4-15
 - Windows 95 drivers, 6-11
 - Windows NT drivers, 6-21
- PC identification number, 2-20
- performance, 7-12
- plug requirements, 8-8
- pointing device
 - external, 4-11
 - settings, 2-6
 - using, 2-5
- port replicator
 - troubleshooting, 7-3
 - USB ports, 4-12
- ports
 - external devices, 4-9
 - locations, 1-5
- power
 - Advanced Power Management, 3-2
 - button, 1-5
 - connecting ac, 1-9, 3-5
 - conserving, 3-10
 - cords, 8-8
 - managing, 3-2
 - modes, 2-3
 - saving, 3-9
 - status icons, 2-14
- Power menu (BIOS), 1-14
- printing
 - compatible printers, 4-11
 - infrared, 4-14, 7-8
 - parallel connection, 4-11
 - troubleshooting, 7-15
- product specifications, 8-2
- protection
 - file, 2-20
 - hard drive, 2-20
 - Kensington lock, 2-19
 - McAfee VirusScan, 2-18
 - password, 2-17
 - PC identification, 2-20
- PS/2 mouse (connecting), 4-11
- R**
- RAM
 - installing, 5-7
 - system resource, 8-7
 - troubleshooting, 7-10

- recharging battery, 3-5
- recovering Windows, 6-2
- Recovery CD*
 - contents, 6-2
 - replacing, 6-23
- recycling battery, 8-9
- regulatory information, 8-11
- reinstalling
 - HP applications, 6-23
 - OmniBook BIOS, 6-24
 - Windows 95, 6-4
 - Windows NT 4.0, 6-5
- removing
 - CD, 4-6
 - hard disk drive, 5-3, 5-4
 - PC Cards, 4-16
 - RAM expansion module, 5-8
 - secondary battery, 3-8
- replacing
 - hard disk drive, 5-3
 - hard disk drive holder, 5-4

S

- safety
 - battery, 8-9
 - ergonomics, 8-9
 - laser, 8-10
 - LED, 8-10
 - power, 8-8
 - voltage, 8-8
- saving battery power, 3-9
- Scandisk, 7-7
- security
 - BIOS menu, 1-13
 - hard drive lock, 2-20
 - Kensington lock, 2-19
 - McAfee VirusScan, 2-18
 - passwords, 2-17, 2-18
 - PC identification, 2-20
- Security menu (BIOS), 1-13
- selecting items (touch pad), 2-5
- serial device
 - connecting, 4-11
 - conserving power, 3-9
 - troubleshooting, 7-16
 - USB, 4-12
- serial mouse, 4-11
- service
 - booklet, 1-2, 1-3
 - HP service center, 8-10
- setting up
 - McAfee VirusScan, 2-18
 - OmniBook BIOS, 1-10
 - retail Windows 95, 6-6
 - retail Windows NT 4.0, 6-15
 - Windows, 1-8
- settings
 - pointing device, 2-6
 - touch pad, 2-6
- shortcut keys, 2-10
- Smart CPU, 1-14
 - time-out, 3-10
- SmartCard, 1-4
- software
 - license, iii
 - resources, 8-6
- sound. *See* audio
- speakers (internal), 1-5
- specifications, 8-2
 - software system, 8-6
- standby
 - and display life, 2-7
 - hot keys, 2-10
 - mode, 2-3, 2-10
 - status lights, 2-13
 - time-out, 1-14, 3-10
- starting OmniBook, 2-3
- status panel
 - battery status indicators, 3-4
 - icons, 2-14, 2-15
 - location, 1-5

- stopping OmniBook, 2-3
- support, 8-10
- support utility disk, 5-5, 6-2
- suspend
 - and display life, 2-7
 - hot keys, 2-10
 - mode, 2-3, 2-10
 - on undock, 1-14
 - status lights, 2-13
 - time-out, 1-14, 3-10
- System Devices menu (BIOS), 1-12
- system resources
 - DMA channels, 8-7
 - Input/Output addresses, 8-7
 - memory, 8-7
 - system interrupts, 8-6

T

- taskbar
 - PC Card, 4-16
- tattooing, 2-20
- technical support, 1-2
- TFT display, 1-3
- time-outs, 1-14, 3-9, 3-10
- TopTools, 1-16
- touch pad
 - drivers, 6-13
 - location, 1-5
 - moving, 2-5
 - settings, 2-6
 - using, 2-5
- tray (docking), 4-17
- troubleshooting
 - audio devices, 7-5
 - battery, 7-13
 - CD-ROM drive, 7-3, 7-4
 - display, 7-6
 - hard disk drive, 7-7
 - memory, 7-10
 - parallel device, 7-16
 - PC Cards, 7-11

- performance, 7-12
- port replicator, 7-3
- power, 7-13
- printing, 7-15
- serial device, 7-16
- startup, 7-17
- universal serial bus (USB), 7-16
- Zip drive, 7-4

U

- universal serial bus (USB)
 - connecting, 4-12
 - troubleshooting, 7-16
- User's Handbook (online)
 - in OmniBook Library group, 1-2

V

- video drivers
 - Windows 95, 6-9
 - Windows NT 4.0, 6-18
- virus scan, 7-7
- voltage requirements, 8-8
- volume
 - adjusting, 2-8
 - control, 7-5

W

- warning (low battery), 3-5
- website, 1-2
- Windows
 - documentation, 1-2
 - license agreement, 1-9
- Windows 95
 - documentation, 1-2
 - factory build, 6-4
 - setting up, 1-8
- Windows 95 (retail)
 - audio drivers, 6-10
 - infrared drivers for, 6-12
 - PC Card drivers for, 6-11
 - touch pad drivers, 6-13

- video drivers, 6-9
- Windows keys, 2-11
- Windows NT 4.0
 - documentation, 1-2
 - factory build, 6-5
 - setting up, 1-8
- Windows NT 4.0 (retail)
 - APM drivers, 6-20
 - audio drivers, 6-19

- Card Executive, 6-21
 - installing, 6-16
 - video drivers, 6-18
- Working in Comfort, 8-9

Z

- Zip disk, 4-7
- zoomed video, 4-15, 8-4