



Gateway 901 Series
Family Room Media Center
replacementguide



Gateway®

Thank you for purchasing this Factory Service Manual CD/DVD from servicemanuals4u.com.

Please check out our eBay auctions for more great deals on Factory Service Manuals:

servicemanuals4u

1	Replacing Gateway Family Media Center Components	1
	Identifying the model	2
	Preparing your work space	2
	Preventing static electricity discharge	3
	Preparing the Family Room Media Center	4
	Opening the Family Media Center case	5
	Closing the Family Media Center case	7
	Replacing the front bezel	8
	Replacing the DVD drive	10
	Replacing the DVD drive bezel	14
	Replacing the processor duct	16
	Replacing the hard drive duct	17
	Removing the hard drive module	18
	Replacing the hard drive	20
	Replacing the power supply	23
	Replacing the modem card	27
	Replacing the video card	29
	Replacing the audio card (for FMC-901X model only)	31
	Replacing the TV/FM tuner card	34
	Replacing memory	36
	Replacing the housing fan	38
	Replacing the front I/O board	40
	Replacing the input board	42
	Replacing the battery	44
	Replacing the fan sink module	46
	Replacing the system board	48
2	Contacting Gateway	53
	Telephone support	54
	Before calling Gateway Technical Support	54
	Telephone support	55
	Tutoring and training	56
	Self-help	56
	Tutoring	56
	Training	57



Replacing Gateway Family Media Center Components

1

Use this service guide to help plan your maintenance tasks for the Gateway 901 Family Room Media Center.

For information on the Family Room Media Center's safety notices and regulatory notices, see the user guide.

© 2003 Gateway, Inc. All rights reserved. Gateway, Gateway Country, the Gateway stylized logo, and the black-and-white spot design are trademarks or registered trademarks of Gateway, Inc. in the United States and other countries. All other brands and product names are trademarks or registered trademarks of their respective companies.



Identifying the model

The label on the bottom of the Family Media Center contains information that identifies the Family Media Center model and its features.



Preparing your work space

Before performing maintenance on the Family Room Media Center, make sure that your work space and the Family Room Media Center are correctly prepared.

- Wear a grounding (ESD) wrist strap, and use a grounded or dissipative work mat.
- Use a stable and strong table, and make sure that the table top is large enough to hold each component as you remove it.
- Use bright lighting to make part identification easier.
- Keep your work surface free from clutter and dust that may damage components.
- Use a magnetized screwdriver for removing screws.
- When removing components that are attached to the Family Room Media Center by a cable, unplug the cable before removing the screws, when possible, to avoid damaging the cable.
- As you remove components and screws, lay them toward the rear of your work surface (behind the Family Room Media Center) or far enough to the side that your arms do not accidentally brush them onto the floor.

- To help keep track of screws, try the following:
 - Place each component's screws in their own section of a parts sorter.
 - Place each component's screws next to the component on your work surface.
 - After loosening screws that are deeply recessed in a hole, you can leave the screws in the holes if you place small pieces of masking tape over the hole openings. When reassembling the component, just remove the tape and tighten the screws.
 - When you place flat-headed screws on your work surface, stand them on their heads to prevent the screws from rolling off the table.

Preventing static electricity discharge

The components inside the Family Room Media Center are extremely sensitive to static electricity, also known as *electrostatic discharge* (ESD).

Warning



ESD can permanently damage electrostatic discharge-sensitive components in the Family Room Media Center. Prevent ESD damage by following ESD guidelines every time you open the Media Center case.

Warning



To avoid exposure to dangerous electrical voltages and moving parts, turn off the Family Room Media Center and unplug the power cord and modem and network cables before opening the case.

Before replacing components, follow these guidelines:

- Turn off the Family Room Media Center.
- Wear a grounding wrist strap (available at most electronics stores) and attach it to a bare metal part of your workbench or other grounded connection.

Warning



To prevent risk of electric shock, do not insert any object into the vent holes of the Family Room Media Center.

- Touch a bare metal surface on your workbench or other grounded object.
- Unplug the power cord and the modem and network cables.
- Disconnect all peripheral devices and remove any PC Cards.

Before working with Family Room Media Center components, follow these guidelines:

- Avoid static-causing surfaces such as carpeted floors, plastic, and packing foam.
- Remove components from their antistatic bags only when you are ready to use them. Do not lay components on the outside of antistatic bags because only the inside of the bags provide electrostatic protection.
- Always hold components by their edges. Avoid touching the edge connectors. Never slide components over any surface.

Preparing the Family Room Media Center

Warning



To avoid exposure to dangerous electrical voltages and moving parts, turn off the Family Room Media Center, and unplug the power cord, modem, and network cables before opening the case. Reinstall the cover before you restore power or reconnect the modem and network cables.

To prepare the Family Room Media Center for maintenance:

- Disconnect all peripheral devices.
- Turn off the Family Room Media Center and unplug the power cord and modem and network cables (if attached).

Opening the Family Media Center case

Use the following instructions to remove Family Media Center components and replace them with replacement parts.

Warning



To avoid exposure to dangerous electrical voltages and moving parts, turn off your Family Media Center, then unplug the power cord and modem cable before opening the case.



To open the Family Media Center case:

- 1** Follow the instructions in “Preventing static electricity discharge” on page 3.
- 2** Shut down your Family Media Center, then disconnect the power cord and modem, network, and all peripheral device cables.
- 3** Press the power button to drain any residual power from your Family Media Center.
- 4** Remove the three cover screws.

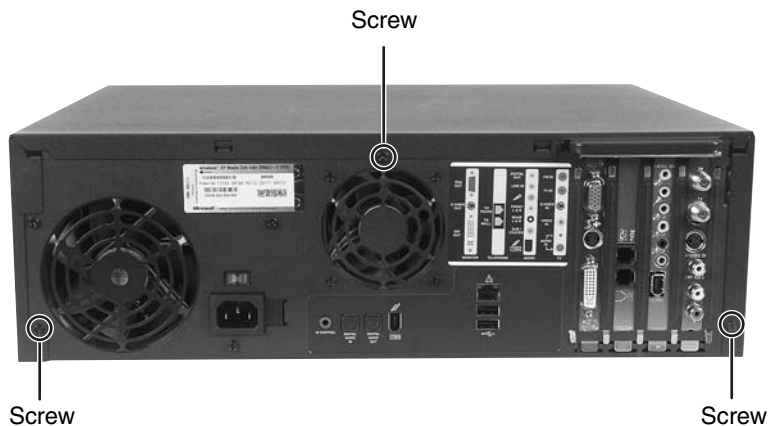

- 5 Slide the cover about 1 inch toward the back of the case, then lift the cover from the case.

Tips & Tricks



If the cover is difficult to remove, press down on the front corners of the cover, then slide the cover toward the back of the case.



Closing the Family Media Center case

▶ **To close the Family Media Center case:**

- 1** Make sure that all of the internal cables are arranged inside the case so they will not be pinched when you close the case.
- 2** Set the cover on the case with about a 1-inch gap between the cover and the front bezel.



- 3** Slide the cover toward the front of the case until it is closed.



- 4** Reinstall the three cover screws.
- 5** Reconnect the cables and power cord.

Replacing the front bezel



To replace the front bezel:

- 1** Follow the instructions in “Preventing static electricity discharge” on page 3.
- 2** Shut down your Family Media Center, then disconnect the power cord and modem, network, and all peripheral device cables.
- 3** Press the power button to drain any residual power from your Family Media Center.
- 4** Remove the case cover by following the instructions in “Opening the Family Media Center case” on page 5.

- 5 Press the five latches inside the front of the case.

Tips & Tricks



It may be helpful to release the two tabs on the left side first, then release the three tabs on right side.

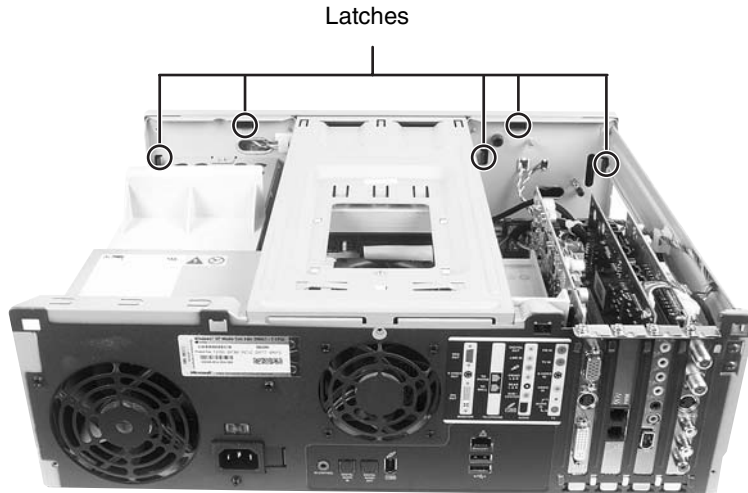

- 6 Release the three latches on the bottom of the front bezel, then remove the front bezel.

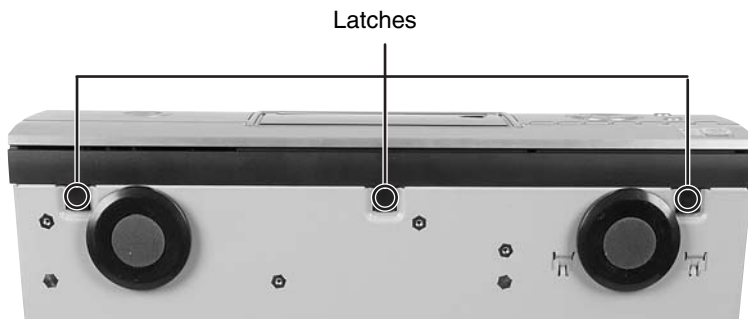

- 7 Align the three latches on the bottom of the replacement front bezel with the latch slots on the bottom of the case.

- 8** Align the five latches with the latch slots on the inside front of the case, then press in on the front bezel to snap the latches into place.
- 9** Reinstall the case cover by following the instructions in “Closing the Family Media Center case” on page 7.
- 10** Reconnect the power cord and modem, network, and all peripheral device cables.

Replacing the DVD drive



To replace the DVD drive:

- 1** Follow the instructions in “Preventing static electricity discharge” on page 3.
- 2** Shut down your Family Media Center, then disconnect the power cord and modem, network, and all peripheral device cables.
- 3** Press the power button to drain any residual power from your Family Media Center.
- 4** Remove the case cover by following the instructions in “Opening the Family Media Center case” on page 5.
- 5** Remove the front bezel by following the instructions in “Replacing the front bezel” on page 8.

- 6 Remove the two screws that secure the DVD drive bracket in the case.

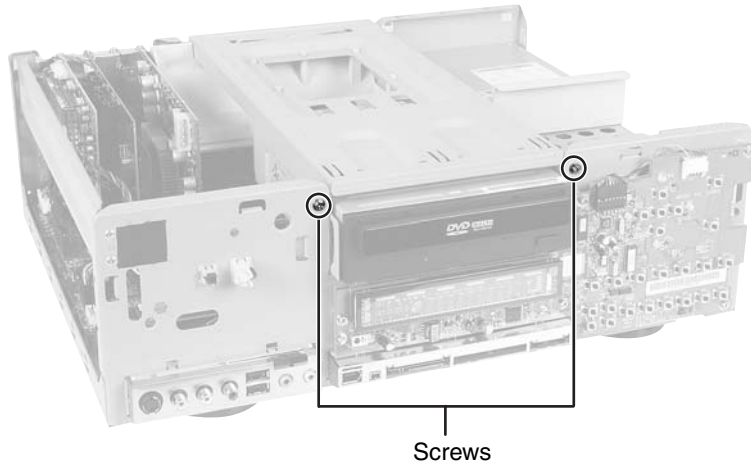

- 7 Lift the DVD drive bracket away from the case.

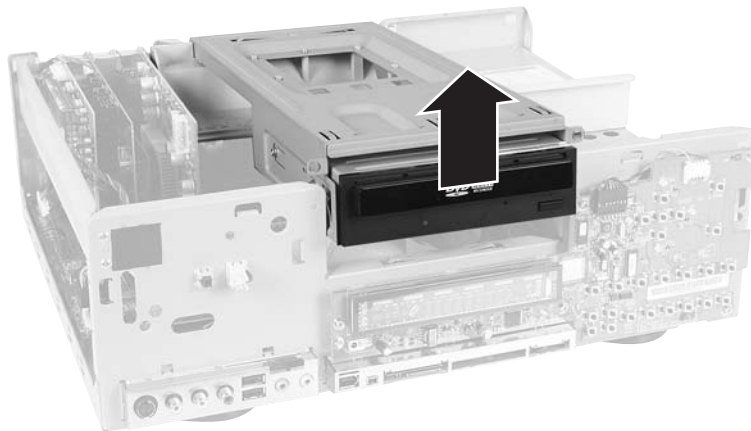

- 8 Turn the bracket over, then disconnect the IDE cable and power cable.

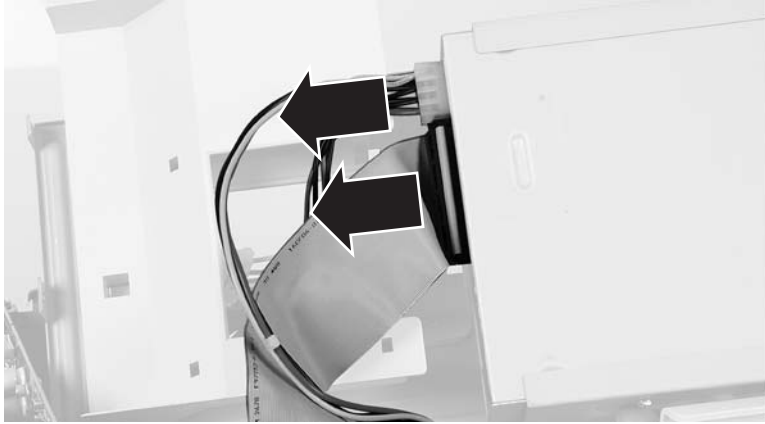

- 9 Remove the four screws that secure the DVD drive in the bracket. There are two screws on each side of the bracket.

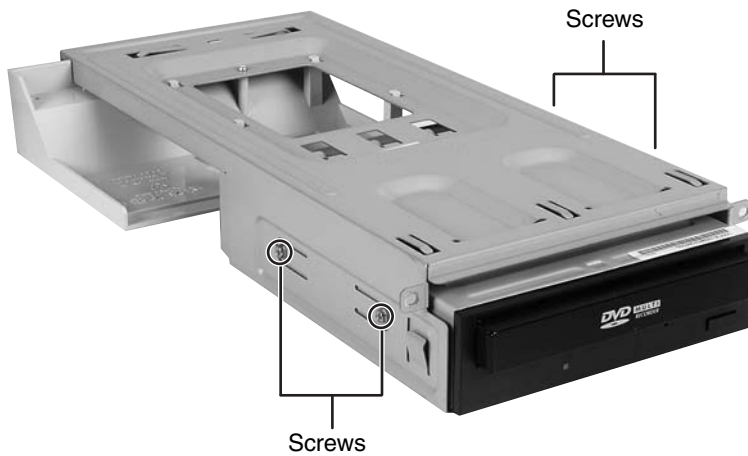

- 10** Slide the DVD drive out of the bracket.



- 11** Slide the replacement DVD drive into the DVD drive bracket.
- 12** Secure the drive in the bracket with the four screws you removed in Step 9.
- 13** Reconnect the IDE cable and power cable.
- 14** Reinstall the two screws that secure the DVD drive bracket in the case.
- 15** Reinstall the front bezel by following the instructions in “Replacing the front bezel” on page 8.
- 16** Reinstall the case cover by following the instructions in “Closing the Family Media Center case” on page 7.
- 17** Reconnect the power cord and modem, network, and all peripheral device cables.

Replacing the DVD drive bezel



To replace the DVD drive bezel:

- 1** Follow the instructions in “Preventing static electricity discharge” on page 3.
- 2** Shut down your Family Media Center, then disconnect the power cord and modem, network, and all peripheral device cables.
- 3** Press the power button to drain any residual power from your Family Media Center.
- 4** Remove the case cover by following the instructions in “Opening the Family Media Center case” on page 5.
- 5** Remove the front bezel by following the instructions in “Replacing the front bezel” on page 8.
- 6** Remove the DVD drive by following the instructions in “Replacing the DVD drive” on page 10.
- 7** Insert a straightened paper clip into the DVD manual eject hole to release the DVD drive.



Manual eject hole

- 8 Pull the DVD drive tray out.



- 9 Slightly rotate the DVD drive bezel out and lift up from the DVD tray.



- 10 Slide the replacement DVD drive bezel onto the front of the DVD drive tray and snap into place.
- 11 Close the DVD drive tray.
- 12 Reinstall the DVD drive by following the instructions in “Replacing the DVD drive” on page 10.
- 13 Reinstall the front bezel by following the instructions in “Replacing the front bezel” on page 8.
- 14 Reinstall the case cover by following the instructions in “Closing the Family Media Center case” on page 7.
- 15 Reconnect the power cord and modem, network, and all peripheral device cables.

Replacing the processor duct



To replace the processor duct:

- 1** Follow the instructions in “Preventing static electricity discharge” on page 3.
- 2** Shut down your Family Media Center, then disconnect the power cord and modem, network, and all peripheral device cables.
- 3** Press the power button to drain any residual power from your Family Media Center.
- 4** Remove the case cover by following the instructions in “Opening the Family Media Center case” on page 5.
- 5** Remove the front bezel by following the instructions in “Replacing the front bezel” on page 8.
- 6** Remove the DVD drive bracket by following the instructions in “Replacing the DVD drive” on page 10. You do not need to remove the DVD drive from the DVD drive bracket.
- 7** Remove the screw, release the latch, then slide the processor duct forward to remove.

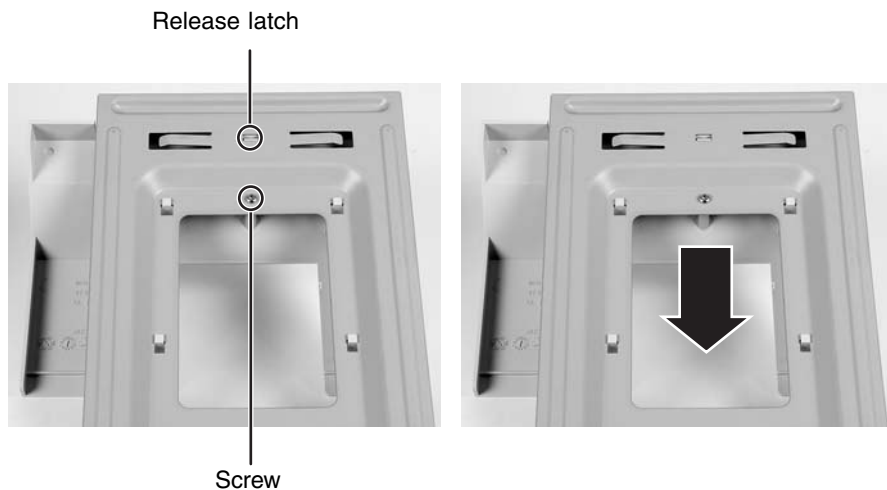

- 8** Slide the replacement processor duct on the DVD drive bracket, then secure the duct with the screw.
- 9** Reinstall the DVD drive bracket by following the instructions in “Replacing the DVD drive” on page 10.
- 10** Reinstall the front bezel by following the instructions in “Replacing the front bezel” on page 8.
- 11** Reinstall the case cover by following the instructions in “Closing the Family Media Center case” on page 7.
- 12** Reconnect the power cord and modem, network, and all peripheral device cables.

Replacing the hard drive duct



To replace the hard drive duct:

- 1** Follow the instructions in “Preventing static electricity discharge” on page 3.
- 2** Shut down your Family Media Center, then disconnect the power cord and modem, network, and all peripheral device cables.
- 3** Press the power button to drain any residual power from your Family Media Center.
- 4** Remove the case cover by following the instructions in “Opening the Family Media Center case” on page 5.

- 5 Lift the hard drive duct up and toward the front of the case.

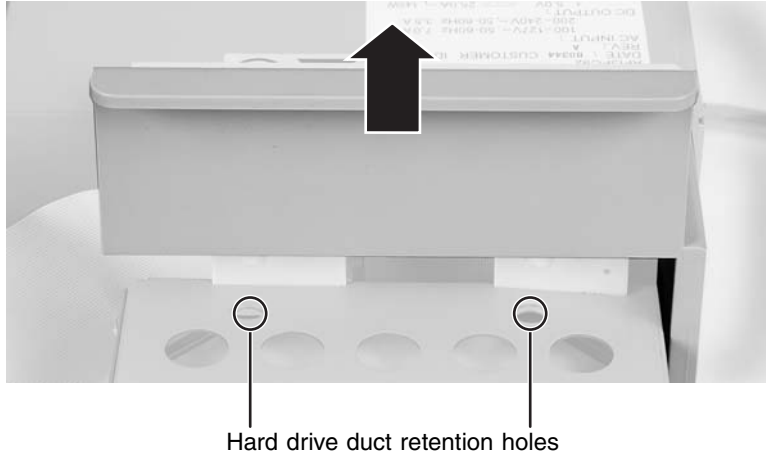

- 6 Install the replacement hard drive duct. Make sure that the plastic pins fit firmly in the retention holes in the hard drive module.
- 7 Reinstall the case cover by following the instructions in “Closing the Family Media Center case” on page 7.
- 8 Reconnect the power cord and modem, network, and all peripheral device cables.

Removing the hard drive module

To replace the hard drive module:

- 1 Follow the instructions in “Preventing static electricity discharge” on page 3.
- 2 Shut down your Family Media Center, then disconnect the power cord and modem, network, and all peripheral device cables.
- 3 Press the power button to drain any residual power from your Family Media Center.
- 4 Remove the case cover by following the instructions in “Opening the Family Media Center case” on page 5.

- 5 Remove the hard drive duct by following the instructions in “Replacing the hard drive duct” on page 17.
- 6 Disconnect the power cable and IDE cable.



- 7 Remove the two screws located on the top and side of the drive module.

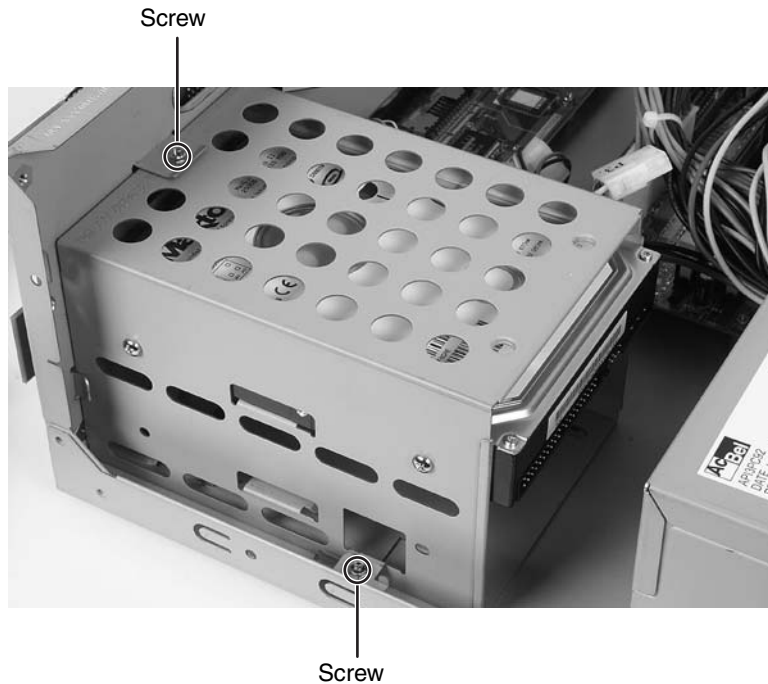

- 8 Slide the drive module toward the back of the case, then lift the module out of the case.



- 9 Slide the replacement drive module into the case.
- 10 Reinstall the hard drive duct by following the instructions in “Replacing the hard drive duct” on page 17.
- 11 Reinstall the case cover by following the instructions in “Closing the Family Media Center case” on page 7.
- 12 Reconnect the power cord and modem, network, and all peripheral device cables.

Replacing the hard drive

To replace the hard drive:

- 1 Follow the instructions in “Preventing static electricity discharge” on page 3.
- 2 Shut down your Family Media Center, then disconnect the power cord and modem, network, and all peripheral device cables.

- 3** Press the power button to drain any residual power from your Family Media Center.
- 4** Remove the case cover by following the instructions in “Opening the Family Media Center case” on page 5.
- 5** Remove the hard drive duct by following the instructions in “Replacing the hard drive duct” on page 17.
- 6** Remove the hard drive module following the instructions in “Removing the hard drive module” on page 18.
- 7** Remove the four screws that secure the hard drive in the drive module. There are two screws on each side of the drive module.

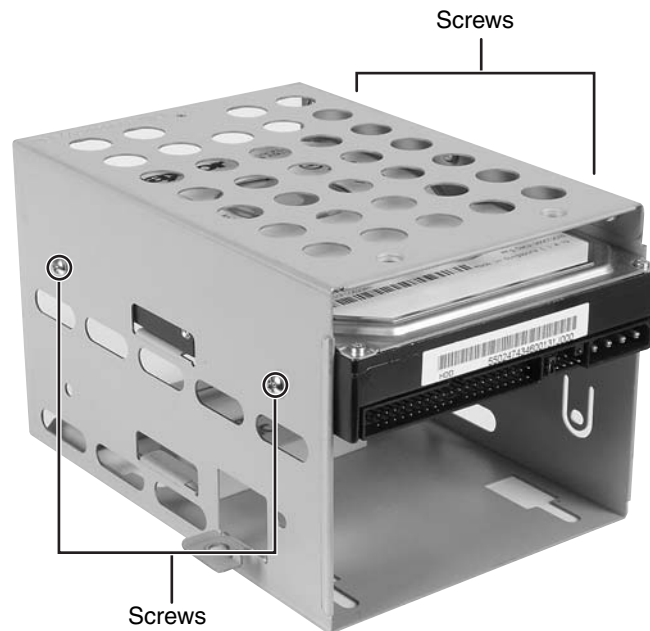

- 8 Slide the hard drive out of the drive module.

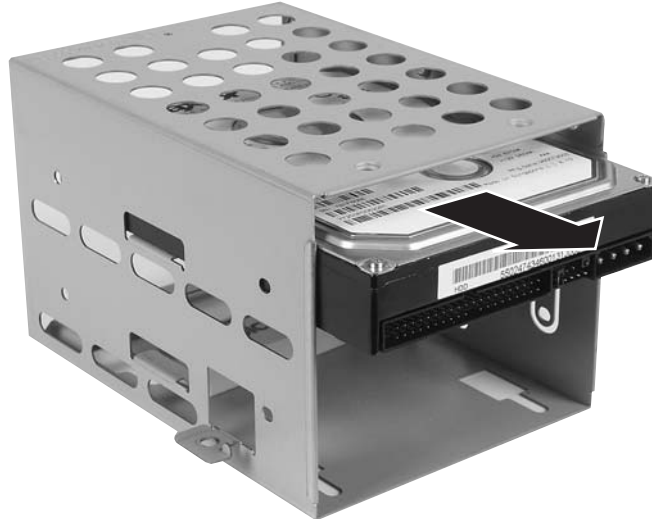

- 9 Slide the replacement hard drive into the drive module.
- 10 Secure the hard drive in the drive module with four screws.
- 11 Reinstall the hard drive module by following the instructions in “Removing the hard drive module” on page 18.
- 12 Reinstall the hard drive duct by following the instructions in “Replacing the hard drive duct” on page 17.
- 13 Reinstall the case cover by following the instructions in “Closing the Family Media Center case” on page 7.
- 14 Reconnect the power cord and modem, network, and all peripheral device cables.

Replacing the power supply



To replace the power supply:

- 1** Follow the instructions in “Preventing static electricity discharge” on page 3.
- 2** Shut down your Family Media Center, then disconnect the power cord and modem, network, and all peripheral device cables.
- 3** Press the power button to drain any residual power from your Family Media Center.
- 4** Remove the case cover by following the instructions in “Opening the Family Media Center case” on page 5.
- 5** Remove the front bezel by following the instructions in “Replacing the front bezel” on page 8.
- 6** Disconnect the power cable connected to the DVD drive by following the instructions in “Replacing the DVD drive” on page 10.
- 7** Remove the hard drive duct by following the instructions in “Replacing the hard drive duct” on page 17.
- 8** Disconnect the power cable connected to the hard drive by following the instructions in “Removing the hard drive module” on page 18.

- 9 Disconnect the power cables connected to the system board.

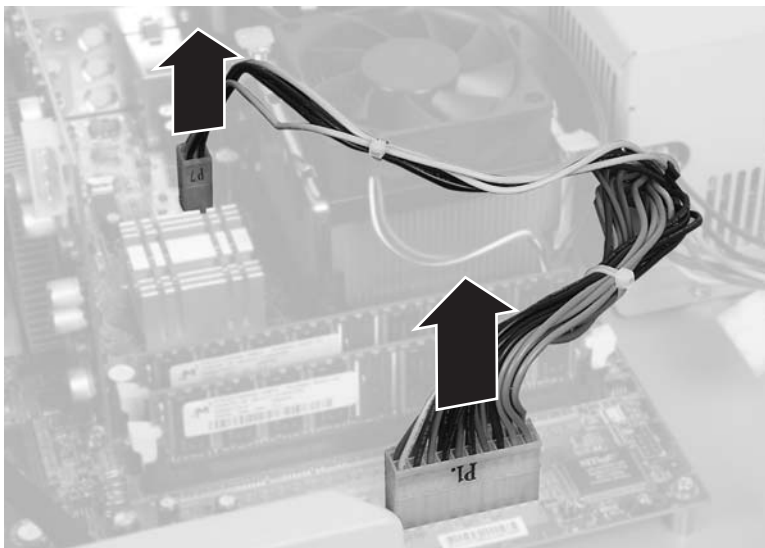

- 10 Disconnect the video card power cable.

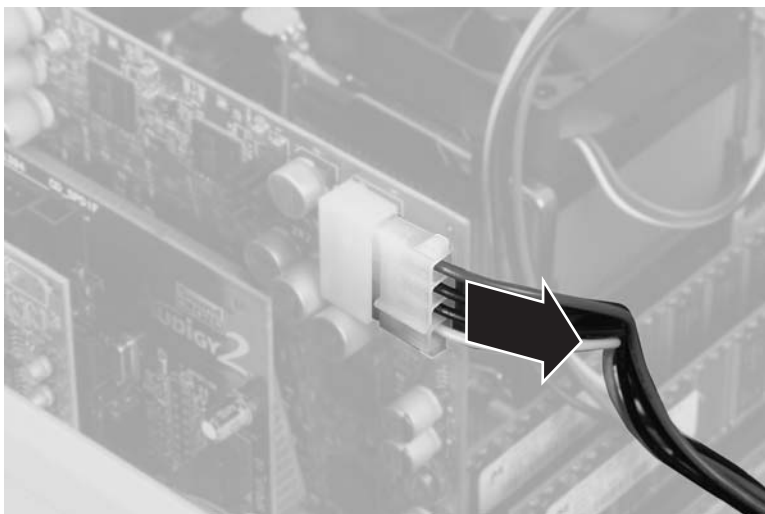

- 11 If there are other power cables that have not been disconnected, disconnect them.

- 12** Remove the two screws that secure the power supply to the bottom of the case.

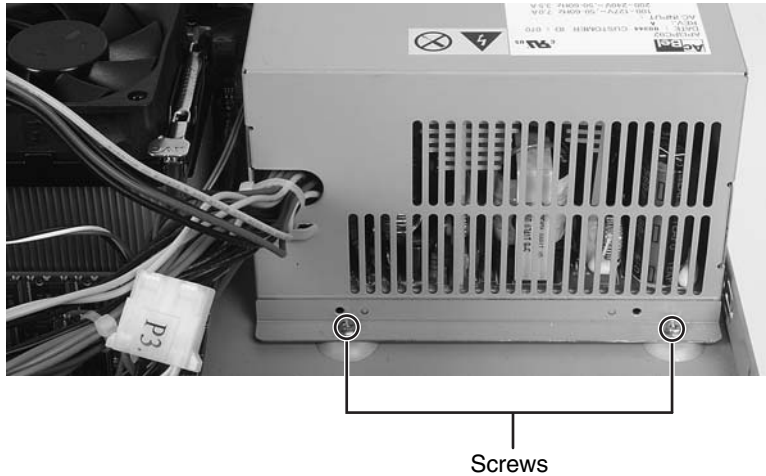

- 13** Remove the three screws that secure the power supply to the back of the case.

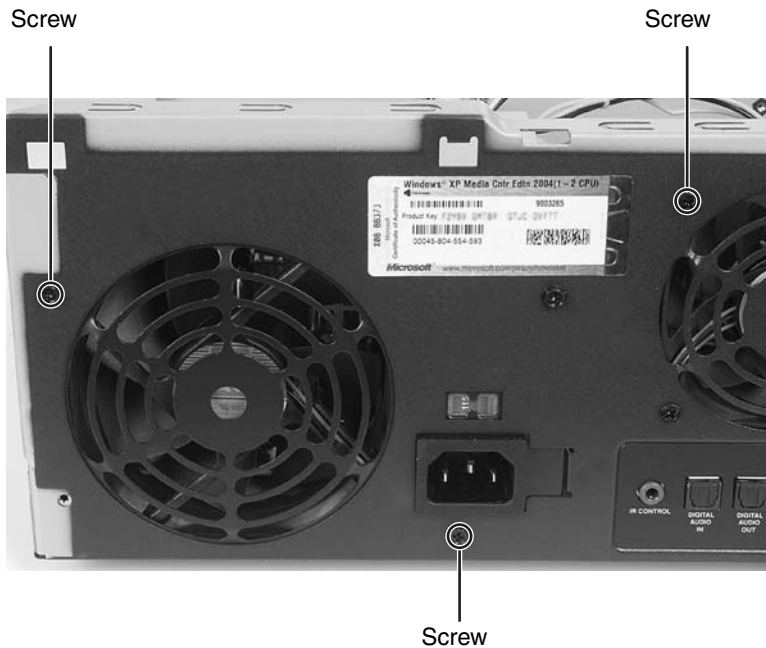

- 14** Slide the power supply toward the front of the case and lift it out of the case.



- 15** Slide the replacement power supply in the case.
- 16** Reinstall the three screws that secure the power supply to the back of the case.
- 17** Reinstall the two screws that secure the power supply to the bottom of the case.
- 18** Connect the power cables to the system board.
- 19** Connect the power cable to the hard drive by following the instructions in “Removing the hard drive module” on page 18.
- 20** Reinstall the hard drive duct by following the instructions in “Replacing the hard drive duct” on page 17.
- 21** Connect the power cable connected to the DVD drive by following the instructions in “Replacing the DVD drive bezel” on page 14.
- 22** Reinstall the front bezel by following the instructions in “Replacing the front bezel” on page 8.

- 23** Reinstall the case cover by following the instructions in “Closing the Family Media Center case” on page 7.
- 24** Reconnect the power cord and modem, network, and all peripheral device cables.

Replacing the modem card

To replace the modem card:

- 1** Follow the instructions in “Preventing static electricity discharge” on page 3.
- 2** Shut down your Family Media Center, then disconnect the power cord and modem, network, and all peripheral device cables.
- 3** Press the power button to drain any residual power from your Family Media Center.
- 4** Remove the case cover by following the instructions in “Opening the Family Media Center case” on page 5.
- 5** Remove the screw that secures the modem card to the case.

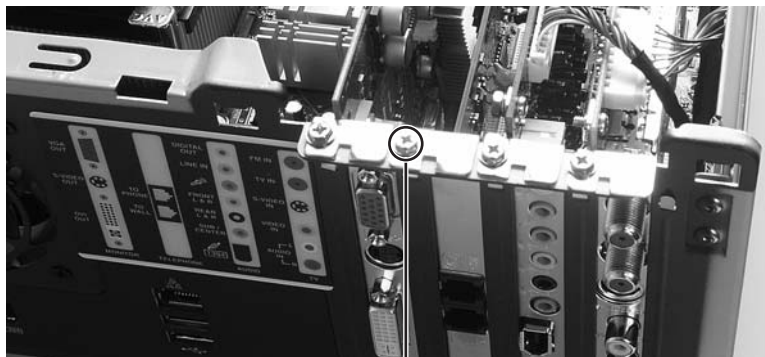

Screw

- 6 Remove the modem card. You can slightly seesaw the card end-to-end to loosen the card, but do not bend the card sideways.

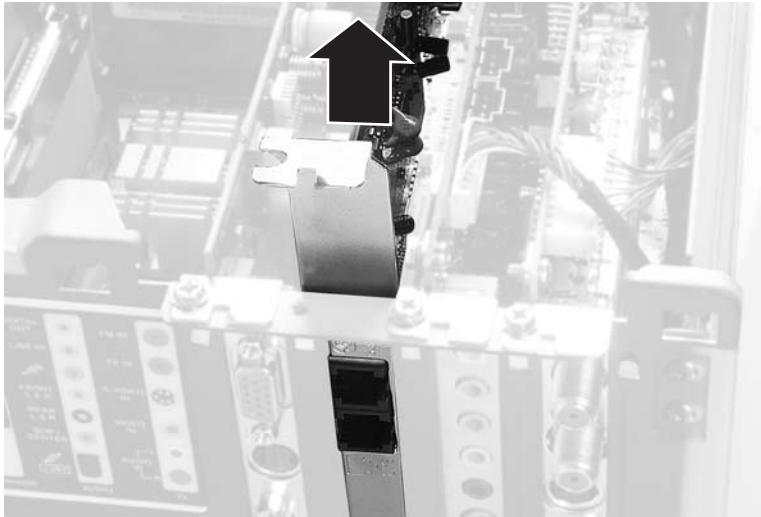

Warning



Do not touch the contacts on the bottom part of the modem card. Touching the contacts can cause electrostatic damage to the card.

- 7 Install the replacement modem card into the slot. You can slightly seesaw the card end-to-end to help insert the card, but do not bend the card sideways.
- 8 Secure the modem card with the screw you removed in Step 5.
- 9 Reinstall the case cover by following the instructions in “Closing the Family Media Center case” on page 7.
- 10 Reconnect the power cord and modem, network, and all peripheral device cables.

Replacing the video card

▶ To replace the video card:

- 1** Follow the instructions in “Preventing static electricity discharge” on page 3.
- 2** Shut down your Family Media Center, then disconnect the power cord and modem, network, and all peripheral device cables.
- 3** Press the power button to drain any residual power from your Family Media Center.
- 4** Remove the case cover by following the instructions in “Opening the Family Media Center case” on page 5.
- 5** Remove the modem card by following the instructions in “Replacing the modem card” on page 27.
- 6** Disconnect the video card power cable.

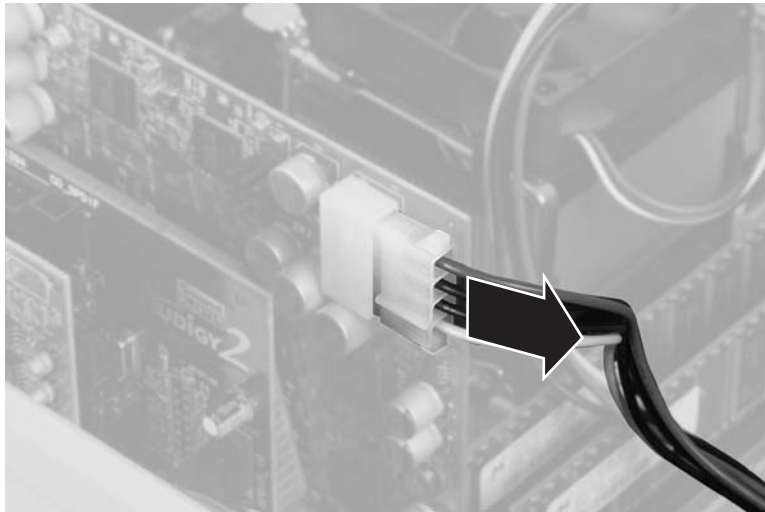

- 7 Remove the screw that secures the video card to the case.

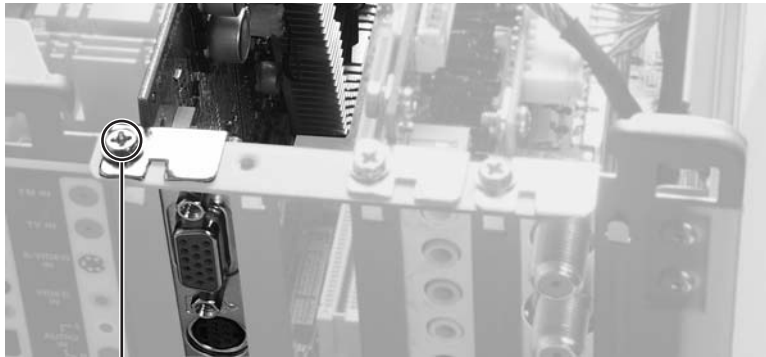

Screw

- 8 Remove the video card. You can slightly seesaw the card end-to-end to loosen the card, but do not bend the card sideways.

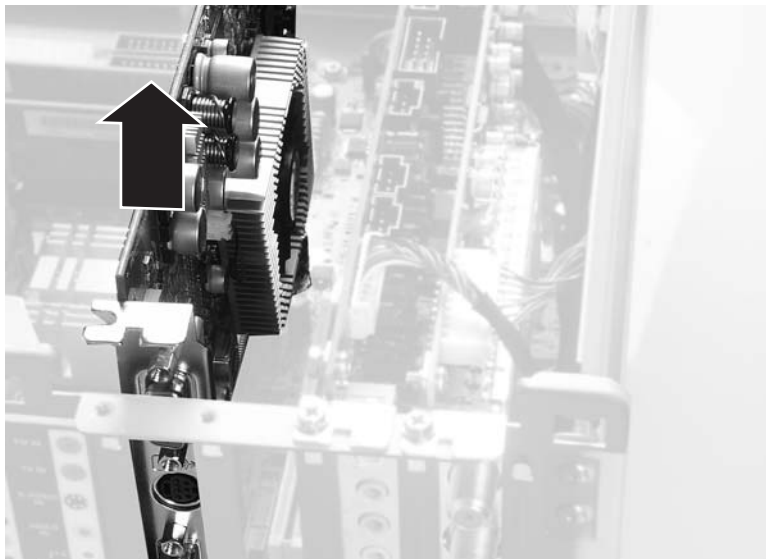

Warning



Do not touch the contacts on the bottom part of the video card. Touching the contacts can cause electrostatic damage to the card.

- 9** Install the replacement video card into the slot. You can slightly seesaw the card end-to-end to help insert the card, but do not bend the card sideways.
- 10** Connect the video card power cable.
- 11** Secure the video card with the screw you removed in Step 7.
- 12** Reinstall the modem card by following the instructions in “Replacing the modem card” on page 27.
- 13** Reinstall the case cover by following the instructions in “Closing the Family Media Center case” on page 7.
- 14** Reconnect the power cord and modem, network, and all peripheral device cables.

Replacing the audio card (for FMC-901X model only)



To replace the audio card:

- 1** Follow the instructions in “Preventing static electricity discharge” on page 3.
- 2** Shut down your Family Media Center, then disconnect the power cord and modem, network, and all peripheral device cables.
- 3** Press the power button to drain any residual power from your Family Media Center.
- 4** Remove the case cover by following the instructions in “Opening the Family Media Center case” on page 5.

- 5 Disconnect the two audio cables on the audio card.

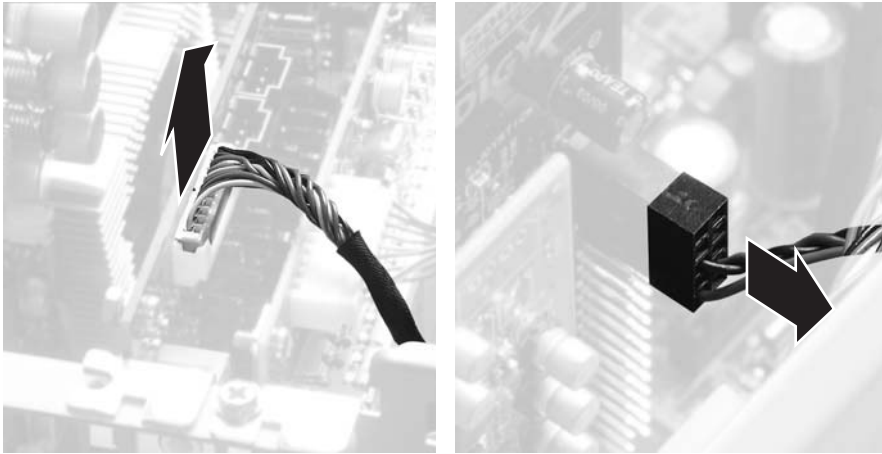

- 6 Remove the screw that secures the audio card to the case.

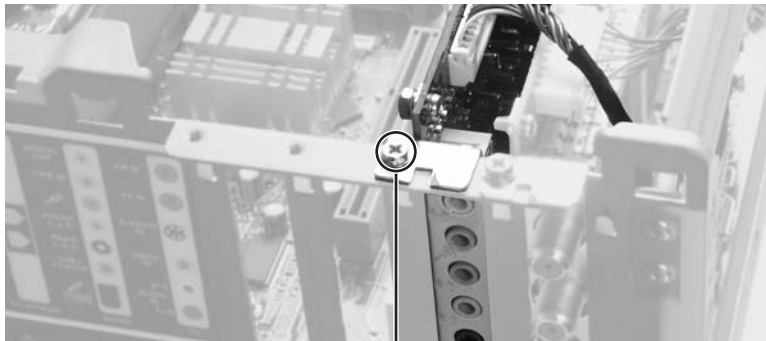

Screw

- 7 Remove the audio card. You can slightly seesaw the card end-to-end to loosen the card, but do not bend the card sideways.



Warning



Do not touch the contacts on the bottom part of the audio card. Touching the contacts can cause electrostatic damage to the card.

- 8 Install the replacement audio card into the slot. You can slightly seesaw the card end-to-end to help insert the card, but do not bend the card sideways.
- 9 Connect the two audio cables on the audio card.
- 10 Secure the audio card with the screw you removed in Step 6.
- 11 Reinstall the case cover by following the instructions in “Closing the Family Media Center case” on page 7.
- 12 Reconnect the power cord and modem, network, and all peripheral device cables.

Replacing the TV/FM tuner card



To replace the TV/FM tuner card:

- 1** Follow the instructions in “Preventing static electricity discharge” on page 3.
- 2** Shut down your Family Media Center, then disconnect the power cord and modem, network, and all peripheral device cables.
- 3** Press the power button to drain any residual power from your Family Media Center.
- 4** Remove the case cover by following the instructions in “Opening the Family Media Center case” on page 5.
- 5** Disconnect the cable on the TV/FM tuner card.

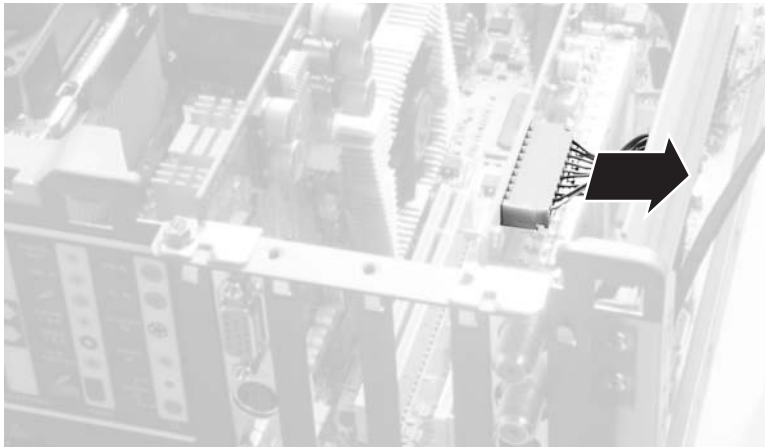

- 6 Remove the screw that secures the TV/FM tuner card to the case.

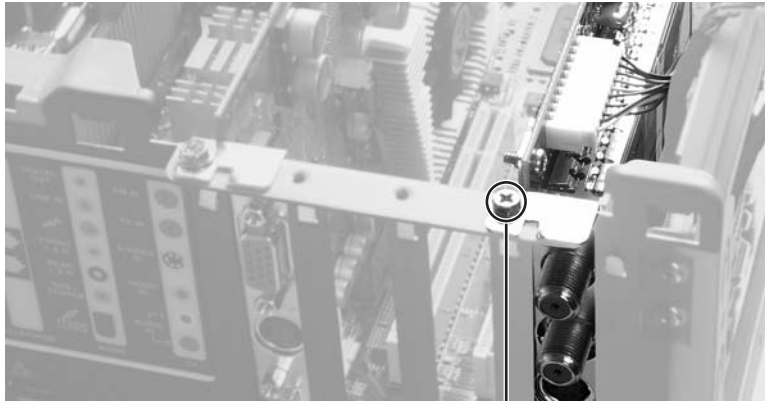

Screw

- 7 Remove the TV/FM tuner card. You can slightly seesaw the card end-to-end to loosen the card, but do not bend the card sideways.

Tips & Tricks



The tuner card has long connectors on the back of the card that may make it difficult to remove. After the card is out of the card slot, move the card to the side of the card slot, tilt the front of the card down, slide the card toward the front of the case, then lift up.



Warning



Do not touch the contacts on the bottom part of the tuner card. Touching the contacts can cause electrostatic damage to the card.

- 8** Install the replacement TV/FM tuner card into the slot. You can slightly seesaw the card end-to-end to help insert the card, but do not bend the card sideways.
- 9** Connect the cable on the TV/FM tuner card.
- 10** Secure the TV/FM tuner card with the screw you removed in Step 6.
- 11** Reinstall the case cover by following the instructions in “Closing the Family Media Center case” on page 7.
- 12** Reconnect the power cord and modem, network, and all peripheral device cables.

Replacing memory

When you replace or upgrade the Family Media Center memory, make sure that you install the correct type of memory module for your Family Media Center. Your Family Media Center uses DIMM memory.



To replace the memory:

- 1** Follow the instructions in “Preventing static electricity discharge” on page 3.
- 2** Shut down your Family Media Center, then disconnect the power cord and modem, network, and all peripheral device cables.
- 3** Press the power button to drain any residual power from your Family Media Center.
- 4** Remove the case cover by following the instructions in “Opening the Family Media Center case” on page 5.
- 5** Remove the front bezel by following the instructions in “Replacing the front bezel” on page 8.

- 6 Remove the DVD drive bracket by following the instructions in “Replacing the DVD drive” on page 10. You do not need to remove the DVD drive from the DVD drive bracket.
- 7 Remove the modem card by following the instructions in “Replacing the modem card” on page 27.
- 8 Remove the video card by following the instructions in “Replacing the video card” on page 29.
- 9 Gently pull the plastic tabs away from the sides of the memory module and remove it.

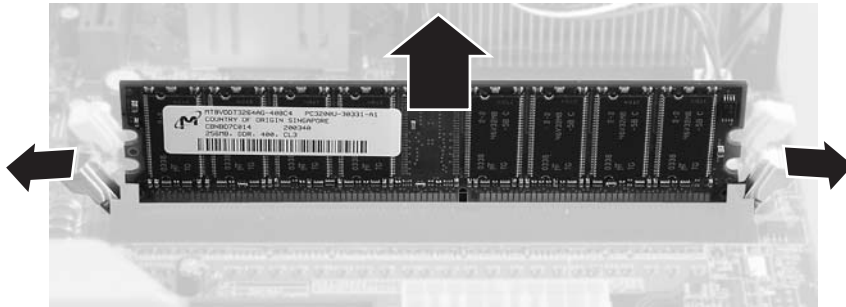

- 10 Align the notches on the new DIMM with the notches on the memory module bank and press the module firmly into the bank. The tabs on the sides of the memory module should secure the memory module automatically. When the module is secure, you hear a click.

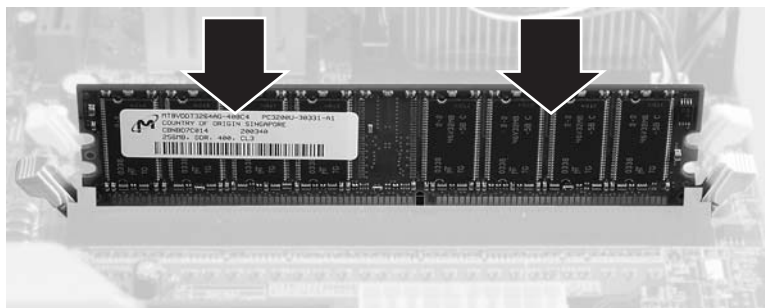

- 11 Reinstall the DVD drive bracket by following the instructions in “Replacing the DVD drive” on page 10.

- 12** Reinstall the front bezel by following the instructions in “Replacing the front bezel” on page 8.
- 13** “Replacing the DVD drive” on page 10.
- 14** Reinstall the video card by following the instructions in “Replacing the video card” on page 29.
- 15** Reinstall the modem card by following the instructions in “Replacing the modem card” on page 27.
- 16** Reinstall the case cover by following the instructions in “Closing the Family Media Center case” on page 7.
- 17** Reconnect the power cord and modem, network, and all peripheral device cables.

Replacing the housing fan



To replace the housing fan:

- 1** Follow the instructions in “Preventing static electricity discharge” on page 3.
- 2** Shut down your Family Media Center, then disconnect the power cord and modem, network, and all peripheral device cables.
- 3** Press the power button to drain any residual power from your Family Media Center.
- 4** Remove the case cover by following the instructions in “Opening the Family Media Center case” on page 5.
- 5** Remove the front bezel by following the instructions in “Replacing the front bezel” on page 8.
- 6** Remove the DVD drive bracket by following the instructions in “Replacing the DVD drive” on page 10. You do not need to remove the DVD drive from the DVD drive bracket.

- 7 Disconnect the housing fan cable from the system board.

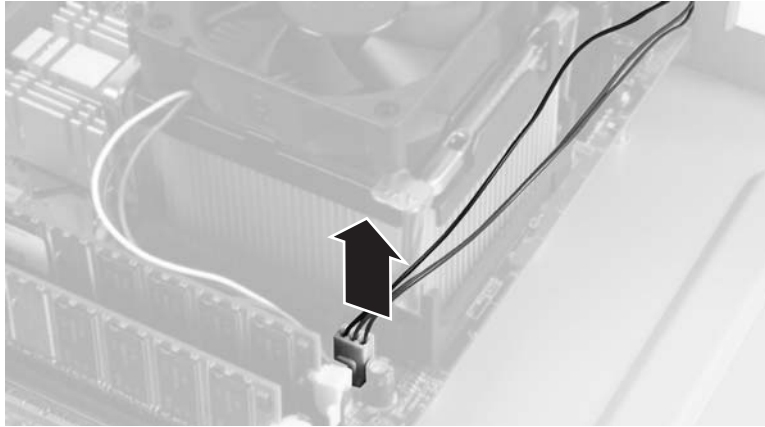

- 8 Remove the four housing fan screws.

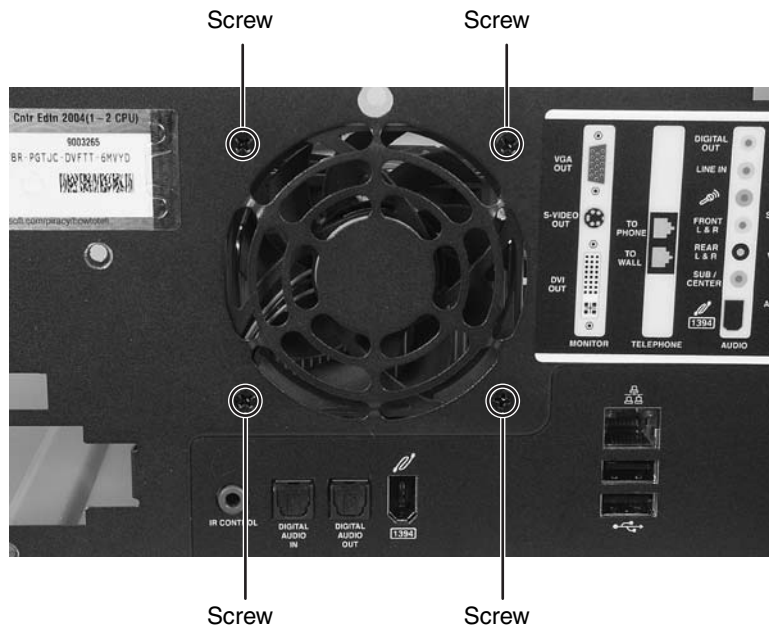

- 9 Remove the housing fan.

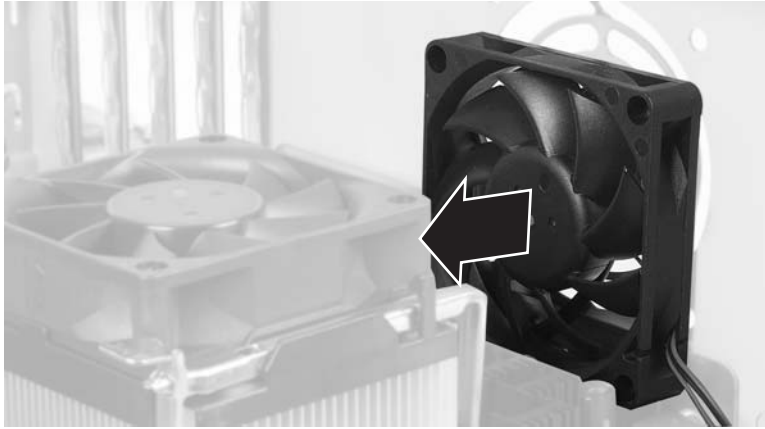

- 10 Install the replacement housing fan, then secure the fan with the four housing fan screws you removed in Step 8.
- 11 Reinstall the DVD drive bracket by following the instructions in “Replacing the DVD drive” on page 10.
- 12 Reinstall the front bezel by following the instructions in “Replacing the front bezel” on page 8.
- 13 Reinstall the case cover by following the instructions in “Closing the Family Media Center case” on page 7.
- 14 Reconnect the power cord and modem, network, and all peripheral device cables.

Replacing the front I/O board



To replace the front I/O board:

- 1 Follow the instructions in “Preventing static electricity discharge” on page 3.
- 2 Shut down your Family Media Center, then disconnect the power cord and modem, network, and all peripheral device cables.

- 3** Press the power button to drain any residual power from your Family Media Center.
- 4** Remove the case cover by following the instructions in “Opening the Family Media Center case” on page 5.
- 5** Remove the front bezel by following the instructions in “Replacing the front bezel” on page 8.
- 6** Remove the DVD drive bracket by following the instructions in “Replacing the DVD drive” on page 10. You do not need to remove the DVD drive from the DVD drive bracket.
- 7** Disconnect the three cables connected to the front I/O board.

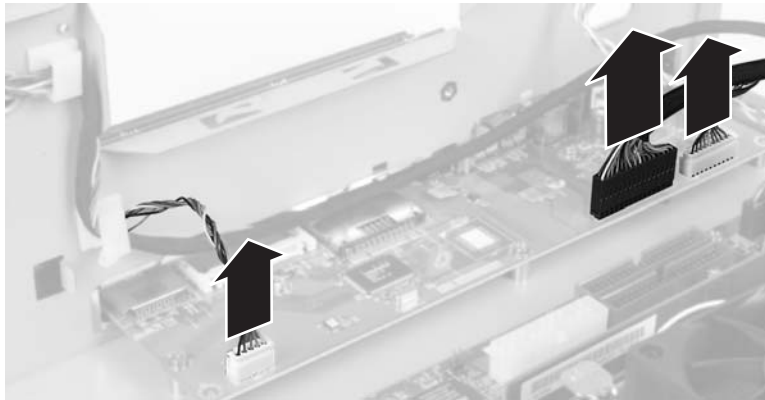

- 8** Remove the five screws that secure the front I/O board to the case.

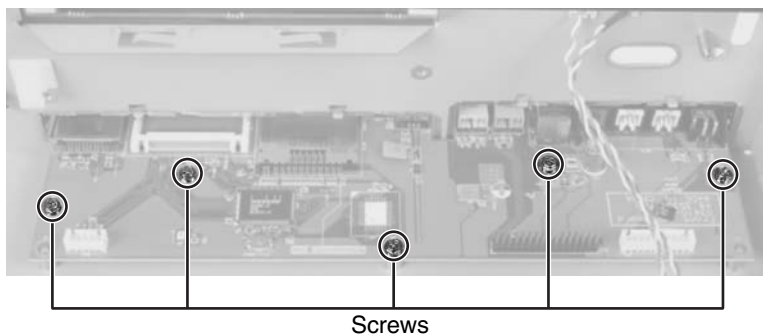

- 9 Slide the front I/O board toward the back of the case, then lift it out of the case.

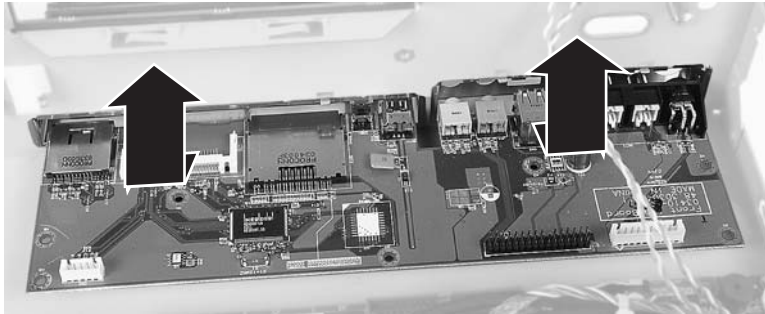

- 10 Install the replacement front I/O board into the case and align the screw holes with the I/O board standoffs.
- 11 Secure the front I/O board with the five screws you removed in Step 8.
- 12 Connect the cables you disconnected from the front I/O board in Step 7.
- 13 Reinstall the DVD drive bracket by following the instructions in “Replacing the DVD drive” on page 10.
- 14 Reinstall the front bezel by following the instructions in “Replacing the front bezel” on page 8.
- 15 Reinstall the case cover by following the instructions in “Closing the Family Media Center case” on page 7.
- 16 Reconnect the power cord and modem, network, and all peripheral device cables.

Replacing the input board



To replace the input board:

- 1 Follow the instructions in “Preventing static electricity discharge” on page 3.
- 2 Shut down your Family Media Center, then disconnect the power cord and modem, network, and all peripheral device cables.

- 3 Press the power button to drain any residual power from your Family Media Center.
- 4 Remove the case cover by following the instructions in “Opening the Family Media Center case” on page 5.
- 5 Remove the front bezel by following the instructions in “Replacing the front bezel” on page 8.
- 6 Disconnect the two cables connected to the input board.

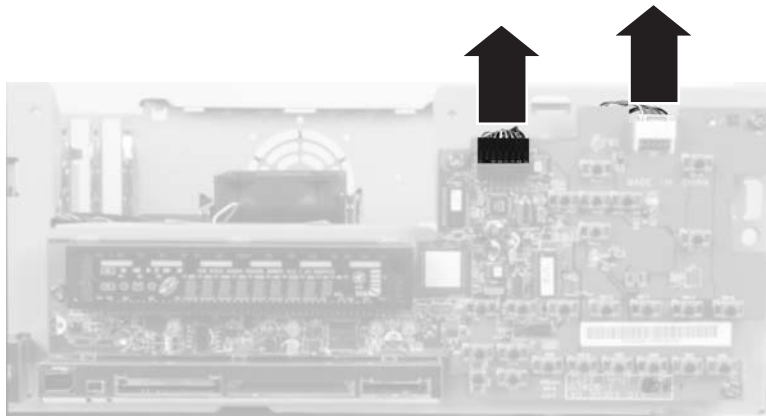

- 7 Remove the five screws that secure the input board to the case.

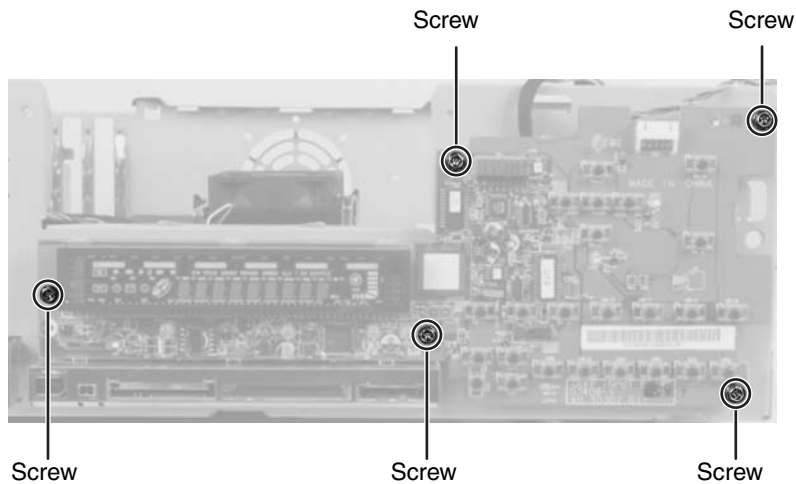

- 8 Remove the input board.

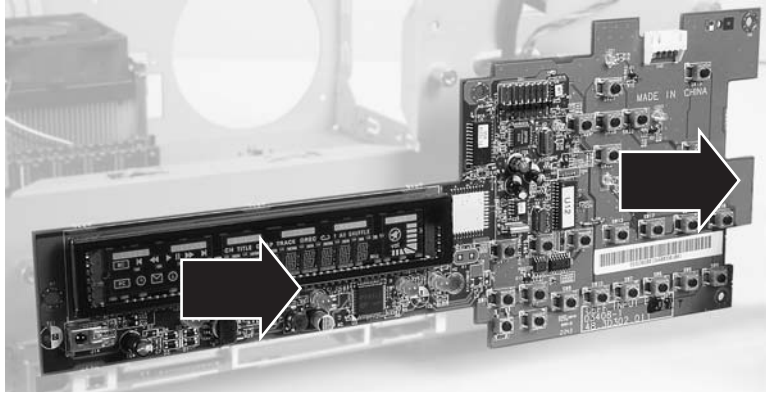

- 9 Install the replacement input board on the case and align the screw holes with the input board standoffs.
- 10 Secure the input board with the five screws you removed in Step 7.
- 11 Connect the cables you disconnected from the input board in Step 6.
- 12 Reinstall the front bezel by following the instructions in “Replacing the front bezel” on page 8.
- 13 Reinstall the case cover by following the instructions in “Closing the Family Media Center case” on page 7.
- 14 Reconnect the power cord and modem, network, and all peripheral device cables.

Replacing the battery

If the Family Media Center clock does not keep time, replace the system battery. Use a battery of the same size and voltage as the original battery that was in your Family Media Center.

Warning



Danger of explosion if battery is incorrectly replaced. Replace only with the same or equivalent type recommended by the manufacturer. Dispose of used batteries following the manufacturer's instructions.

To replace the battery:

- 1** Restart your Family Media Center, then press F2 when the Gateway logo appears. The BIOS Setup utility opens.
- 2** Write down all the values in the menus and submenus, then exit from the utility.
- 3** Shut down your Family Media Center.
- 4** Follow the instructions in “Preventing static electricity discharge” on page 3.
- 5** Disconnect the power cord and modem, network, and all peripheral device cables.
- 6** Press the power button to drain any residual power from your Family Media Center.
- 7** Remove the case cover by following the instructions in “Opening the Family Media Center case” on page 5.
- 8** Locate the old battery on the system board and note its orientation. You will need to install the new battery the same way.
- 9** Slide the metal tab toward the back of the case and lift the battery up out of the battery slot.



- 10** Make sure that the positive (+) side of the new battery is facing toward the back of the case, then press the battery into the slot until the metal tab snaps over the battery.
- 11** Reinstall the case cover by following the instructions in “Closing the Family Media Center case” on page 7.
- 12** Reconnect the power cord and modem, network, and all peripheral device cables.
- 13** Turn on your Family Media Center.
- 14** Open the BIOS Setup utility.
- 15** In the BIOS Setup utility, restore any settings that you wrote down in Step 2.
- 16** Save all your settings and exit the BIOS Setup utility.

Replacing the fan sink module



To replace the fan sink module:

- 1** Follow the instructions in “Preventing static electricity discharge” on page 3.
- 2** Shut down your Family Media Center, then disconnect the power cord and modem, network, and all peripheral device cables.
- 3** Press the power button to drain any residual power from your Family Media Center.
- 4** Remove the case cover by following the instructions in “Opening the Family Media Center case” on page 5.
- 5** Remove the front bezel by following the instructions in “Replacing the front bezel” on page 8.
- 6** Remove the DVD drive bracket by following the instructions in “Replacing the DVD drive” on page 10. You do not need to remove the DVD drive from the DVD drive bracket.

- 7 Disconnect the processor fan.

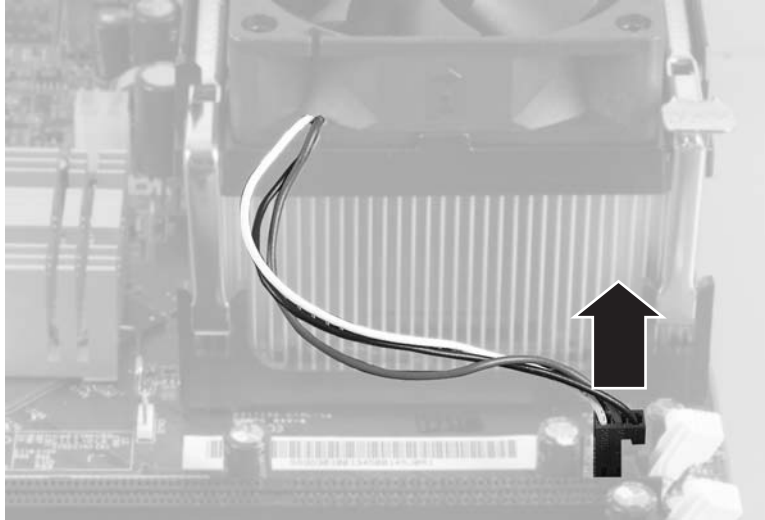

- 8 Press one of the processor fan clips down, then outward to release the processor fan and heat sink. Repeat for the other processor fan clip.

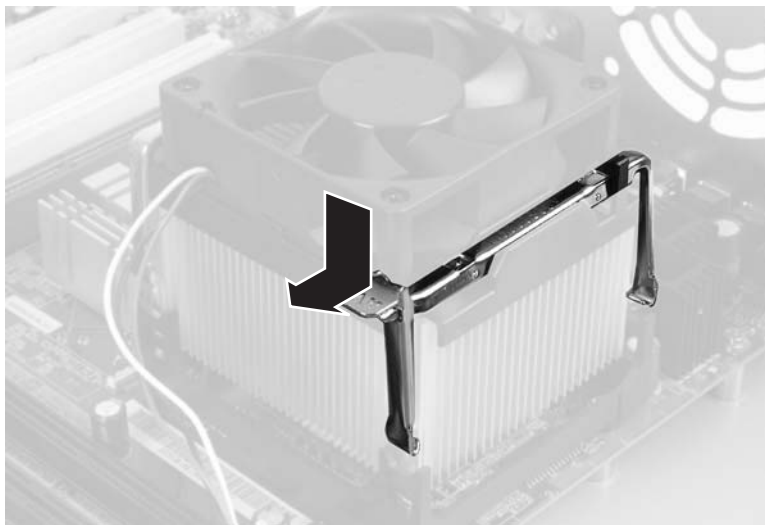

- 9 Lift the fan sink module off of the processor.

- 10** Remove the plastic cover that covers the heat sink grease on the bottom of the replacement fan sink module.
- 11** Align the replacement fan sink module to fit inside the retention module, then set the fan sink module on the processor.
- 12** Secure the fan sink module with the processor fan clips. Make sure that the clips are correctly aligned and secured to hold the fan sink module in place.
- 13** Reinstall the DVD drive bracket by following the instructions in “Replacing the DVD drive” on page 10.
- 14** Reinstall the front bezel by following the instructions in “Replacing the front bezel” on page 8.
- 15** Reinstall the case cover by following the instructions in “Closing the Family Media Center case” on page 7.
- 16** Reconnect the power cord and modem, network, and all peripheral device cables.

Replacing the system board



To replace the system board:

- 1** Follow the instructions in “Preventing static electricity discharge” on page 3.
- 2** Shut down your Family Media Center, then disconnect the power cord and modem, network, and all peripheral device cables.
- 3** Press the power button to drain any residual power from your Family Media Center.
- 4** Remove the case cover by following the instructions in “Opening the Family Media Center case” on page 5.
- 5** Remove the front bezel by following the instructions in “Replacing the front bezel” on page 8.
- 6** Remove the DVD drive bracket by following the instructions in “Replacing the DVD drive” on page 10. You do not need to remove the DVD drive from the DVD drive bracket.

- 7** Remove the modem card by following the instructions in “Replacing the modem card” on page 27.
- 8** Remove the video card by following the instructions in “Replacing the video card” on page 29.
- 9** Remove the audio card by following the instructions in “Replacing the video card” on page 29.
- 10** Remove the TV/FM tuner card by following the instructions in “Replacing the TV/FM tuner card” on page 34.
- 11** Remove the memory by following the instructions in “Replacing memory” on page 36.
- 12** Remove the fan sink module by following the instructions in “Replacing the fan sink module” on page 46.
- 13** Disconnect the front I/O cable, input board cable, and LED cables.

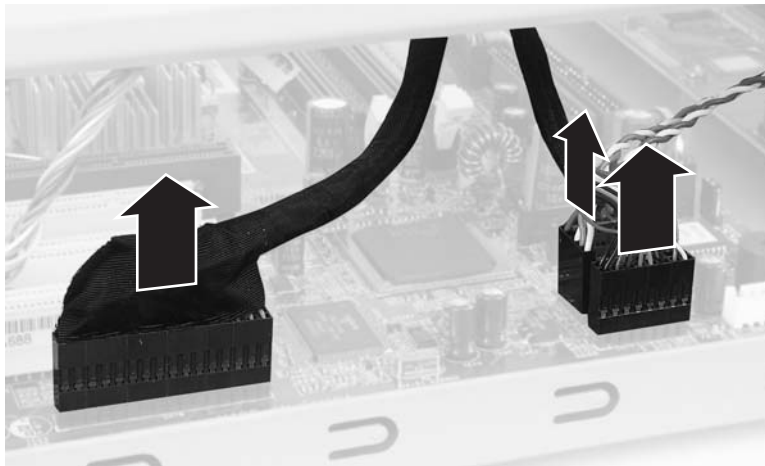

- 14** Remove the nine screws that secure the system board to the case.

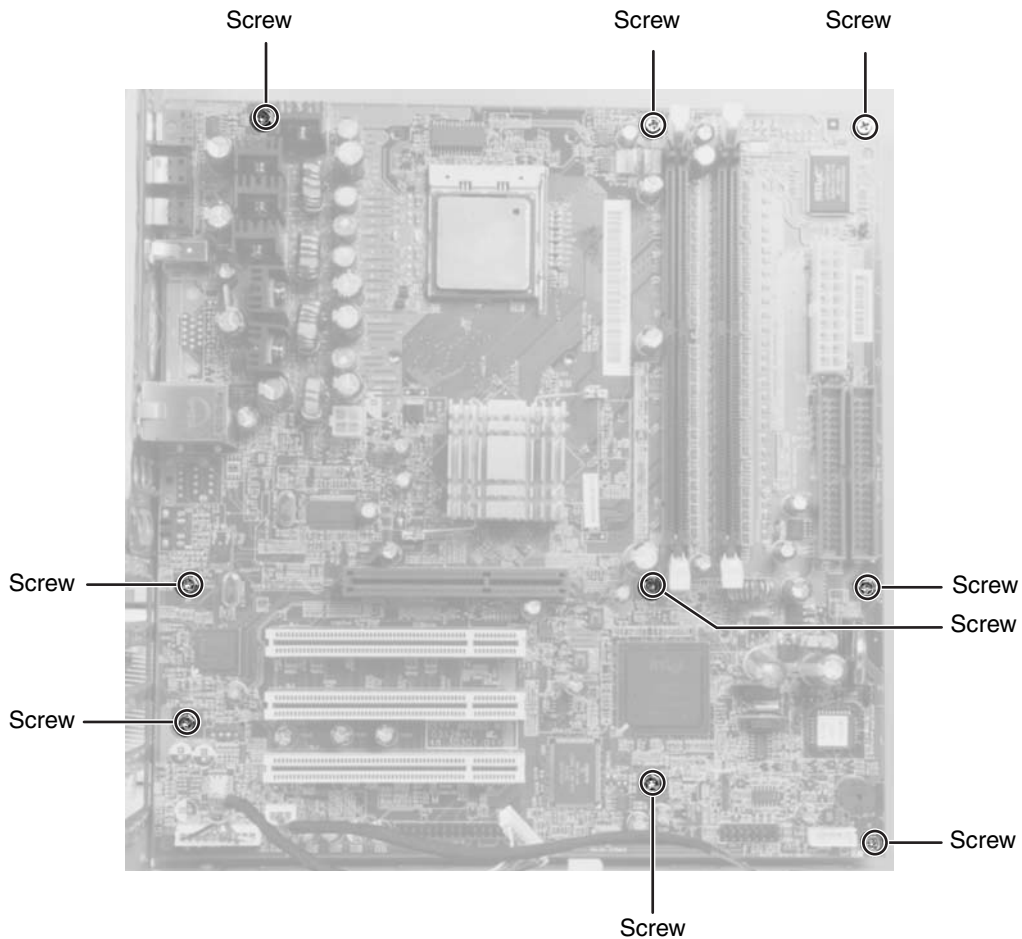

- 15** Lift the system board out of the case.
- 16** Install the replacement system board in the case. Align the system board mounting holes with the standoffs in the case.
- 17** Secure the system board with the nine screws you removed in Step 14.
- 18** Connect the front I/O cable, input board cable, and LED cables.
- 19** Reinstall the fan sink module by following the instructions in "Replacing the fan sink module" on page 46.

- 20** Reinstall the memory by following the instructions in “Replacing memory” on page 36.
- 21** Reinstall the TV/FM tuner card by following the instructions in “Replacing the TV/FM tuner card” on page 34.
- 22** Reinstall the audio card by following the instructions in “Replacing the video card” on page 29.
- 23** Reinstall the video card by following the instructions in “Replacing the video card” on page 29.
- 24** Reinstall the modem card by following the instructions in “Replacing the modem card” on page 27.
- 25** Reinstall the DVD drive bracket by following the instructions in “Replacing the DVD drive” on page 10.
- 26** Reinstall the front bezel by following the instructions in “Replacing the front bezel” on page 8.
- 27** Reinstall the case cover by following the instructions in “Closing the Family Media Center case” on page 7.
- 28** Reconnect the power cord and modem, network, and all peripheral device cables.



Contacting Gateway

2

Use this section to learn how to:

- Get telephone support
- Use automated troubleshooting systems
- Get tutoring and training



Telephone support

Before calling Gateway Technical Support

If you have a technical problem with your Family Media Center, follow these recommendations before contacting Gateway Technical Support:

- Make sure that your Family Media Center is connected correctly to a grounded AC outlet that is supplying power. If you use a power strip, make sure that it is switched on.
- If a peripheral device, such as a keyboard or mouse, does not appear to work, make sure that all cables are plugged in securely.
- If you have recently installed hardware or software, make sure that you have installed it according to the instructions provided with it. If you did not purchase the hardware or software from Gateway, see the manufacturer's documentation and technical support resources.
- If you have "how to" questions about using a program, check:
 - Online Help
 - Printed documentation
 - The Microsoft Windows documentation
- See the troubleshooting section of this chapter.

Warning



To avoid bodily injury, do not attempt to troubleshoot your Family Media Center problem if:

- Power cords or plugs are damaged
- Liquid has been spilled into your Family Media Center
- Your Family Media Center was dropped
- The case was damaged

Instead, unplug your Family Media Center and contact a qualified Family Media Center technician.

- Have your client ID, serial number, and order number available, along with a detailed description of your problem, including the exact text of any error messages, and the steps you have taken. For more information, see "Identifying the model" on page 2.
- Make sure that your Family Media Center is nearby at the time of your call. The technician may have you follow appropriate troubleshooting steps.

Telephone support

Gateway offers a wide range of customer service, technical support, and information services.

Automated troubleshooting system

Service description	How to reach
Use an automated menu system and your telephone keypad to find answers to common problems.	800-846-2118 (US) 877-709-2945 (Canada)

Telephone numbers

You can access the following services through your telephone to get answers to your questions:

Resource	Service description	How to reach
Fax on demand support	Order a catalog of documents on common problems, then order documents by document numbers. The documents will be faxed to you.	800-846-4526 (US) 877-709-2951 (Canada)
Gateway's fee-based software tutorial service	Get tutorial assistance for software issues billed by the minute.	800-229-1103 (charged to your credit card) 900-555-4695 (charged to your telephone bill)
Gateway Technical Support	Talk to a Gateway Technical Support representative about a non-tutorial technical support question. (See "Before calling Gateway Technical Support" on page 54 before calling.) TDD Technical Support (for hearing impaired) is available: Weekdays 6:00 a.m. - 8:00 p.m. Central Time Weekends 6:00 a.m. - 5:00 p.m. Central Time	800-846-2301 (US) 800-846-3609 (Canada and Puerto Rico) 605-232-2191 (all other countries) 800-846-1778 (TDD)
America Online	Get support for your America Online ISP account.	800-827-6364 (US) 888-265-4357 (Canada)
CompuServe	Get support for your CompuServe ISP account.	800-848-8990 (US)
Sales, accounting, and warranty	Get information about available systems, pricing, orders, billing statements, warranty service, or other non-technical issues.	800-846-2000 (US) 888-888-2037 (Canada)

Tutoring and training

Gateway's Technical Support professionals cannot provide hardware and software training or tutorial services. Instead, Gateway recommends the following tutoring and training resources.

Self-help

If you have *how-to* questions about using your Gateway-supplied hardware or software, see the following resources:

- The printed or online documentation that came with your hardware or software. In many cases, additional product information and online documents for Gateway-supplied hardware can be found in our Web site's Documentation Library.
- This user's guide.
- The software publisher's Web site.
- The hardware manufacturer's Web site.

Help and Support



For more how-to information about Windows XP Media Center 2004, click **Start**, then click **Help and Support**.

Type the keyword **practice** in the HelpSpot **Search** box
Search , then click the arrow.

Tutoring

For help on using hardware or software that came with your Gateway Family Media Center, contact Gateway's fee-based tutorial hotline:

- 800-229-1103 (rate charged per minute; charged to a major credit card)
- 900-555-4695 (rate charged per minute; charged to your telephone bill)

Training

Gateway provides the following in-person and computerized training:

Resource	Service description	For more information
In-Store Training at Gateway stores	Our friendly and knowledgeable software trainers can teach you how to use the Internet and the most popular software programs, including Microsoft Word, Excel, and PowerPoint.	www.gateway.com/country
Gateway Learning Libraries	A variety of courses and tutorials are available on CD. Select from several easy-to-use learning libraries.	www.gateway.com/training
Online Training from Learn@Gateway	More than 450 online courses are available from Learn@Gateway. All you have to do is go online and log in. You select the subject matter, and the learning format (self-paced tutorials or virtual classrooms), all from the comfort of your Family Media Center.	www.learnatgateway.com/

MAN FMC 901 ASP RPL GDE R0 12/03



8509776