

# Dell™ Latitude™ V710/V740 Service Manual

## [Before You Begin](#)

[Preparing to Work Inside the Computer](#)

[Recommended Tools](#)

[Computer Orientation](#)

[Screw Identification](#)

## [System Components](#)

[Back-Panel Fan \(V740 Only\)](#)

[Hard Drive](#)

[Memory Module, Modem, Optical Drive, and Floppy Drive](#)

[Memory Module](#)

[Modem](#)

[Optical Drive](#)

[Floppy Drive](#)

[Keyboard](#)

[Display Assembly and Display Latch](#)

[Display Assembly](#)

[Display Latch](#)

[EMI Shield, Video Board, and Palm Rest](#)

[EMI Shield](#)

[Video Board](#)

[Palm Rest](#)

[Microprocessor Thermal-Cooling Assembly](#)

[Microprocessor Module](#)

[Flashing the BIOS](#)

[Speakers](#)

[System Board](#)

[Base Plastics](#)

[Battery Latch Assembly](#)

[Pin Assignments for I/O Connectors](#)

[USB Connector](#)



[PS/2 Connector](#)

[Video Connector](#)

## [Parallel Connector](#)

---

# Notes, Notices, and Cautions

-  **NOTE:** A NOTE indicates important information that helps you make better use of your computer.
  -  **NOTICE:** A NOTICE indicates either potential damage to hardware or loss of data and tells you how to avoid the problem.
  -  **CAUTION: A CAUTION indicates a potential for property damage, personal injury, or death.**
- 

Trademarks used in this text: *Dell*, the *DELL* logo, and *Latitude* are trademarks of Dell Computer Corporation; *Intel* is a registered trademarks of Intel Corporation; *Microsoft* and *Windows* are registered trademarks of Microsoft Corporation.

Other trademarks and trade names may be used in this document to refer to either the entities claiming the marks and names or their products. Dell Computer Corporation disclaims any proprietary interest in trademarks and trade names other than its own.

**April 2002 Rev. A01**

[Back to Contents Page](#)

# Before You Begin

## Dell™ Latitude™ V710/V740 Service Manual

- [Preparing to Work Inside the Computer](#)
  - [Recommended Tools](#)
  - [Computer Orientation](#)
  - [Screw Identification](#)
- 

## Preparing to Work Inside the Computer

 **CAUTION:** Only a certified service technician should perform repairs on your computer. Damage due to servicing that is not authorized by Dell is not covered by your warranty. Read and follow applicable instructions in "Safety and EMC Instructions: Portable Computers" in the Latitude™ *System Information Guide* that came with the computer.

 **NOTICE:** To avoid damaging the computer, perform the following steps before you begin working inside the computer.

1. Ensure that the work surface is flat and clean to prevent scratching the computer cover.
2. Save any work in progress and exit all open programs.
3. Turn off the computer and all attached devices.

 **NOTE:** Ensure that the computer is off and not in a power management mode. If you cannot shut down the computer using the computer operating system, press and hold the power button for 4 seconds.

4. Disconnect the computer from the electrical outlet.
5. To avoid possible damage to the system board, wait 10 to 20 seconds and then

disconnect any attached devices.

6. Disconnect all other external cables from the computer.
7. Remove any installed PC Cards from the PC Card slot.
8. Close the display and turn the computer upside down on a flat work surface.

 **NOTICE:** To avoid damaging the system board, you must remove the main battery before you service the computer.

 **CAUTION:** When you remove the battery, ensure that the computer is upside down on a flat work surface so that the battery does not fall out of the computer.

9. Remove the battery:
  - a. Unlock the battery.
  - b. Slide and hold the battery latch release all the way up until the left edge of the battery pops up.
  - c. Remove the battery.

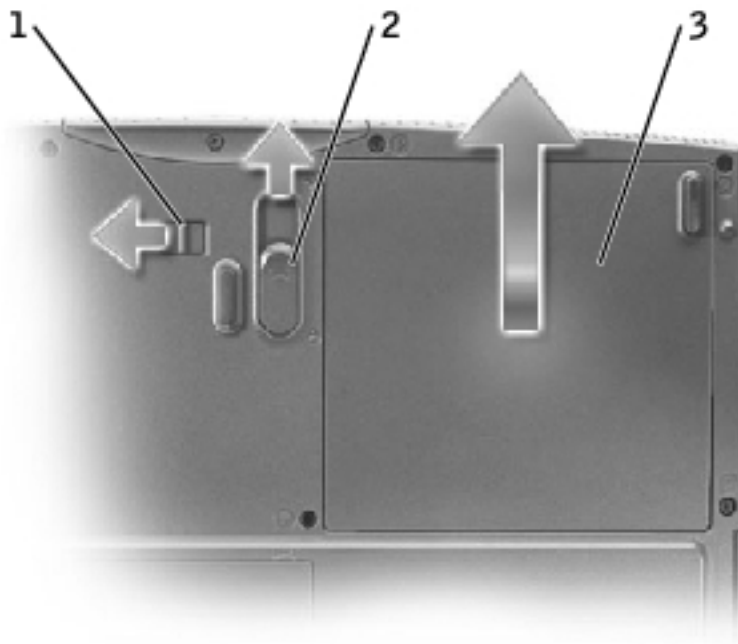

1	battery lock
2	battery latch release
3	battery

10. To dissipate any static electricity while you work, use a wrist grounding strap or periodically touch an unpainted metal surface.
  11. Handle components and cards with care. Do not touch the components or contacts on a card. Hold a card by its edges or by its metal mounting bracket. Hold a component such as a microprocessor by its edges, not by its pins.
- 

## Recommended Tools

The procedures in this manual require the following tools:

- #1 magnetized Phillips screwdriver
  - ¼-inch flat-blade screwdriver
  - Nut driver
  - Small plastic scribe
  - Microprocessor extractor
  - Flash BIOS update program floppy disk or CD
- 

## Computer Orientation

1

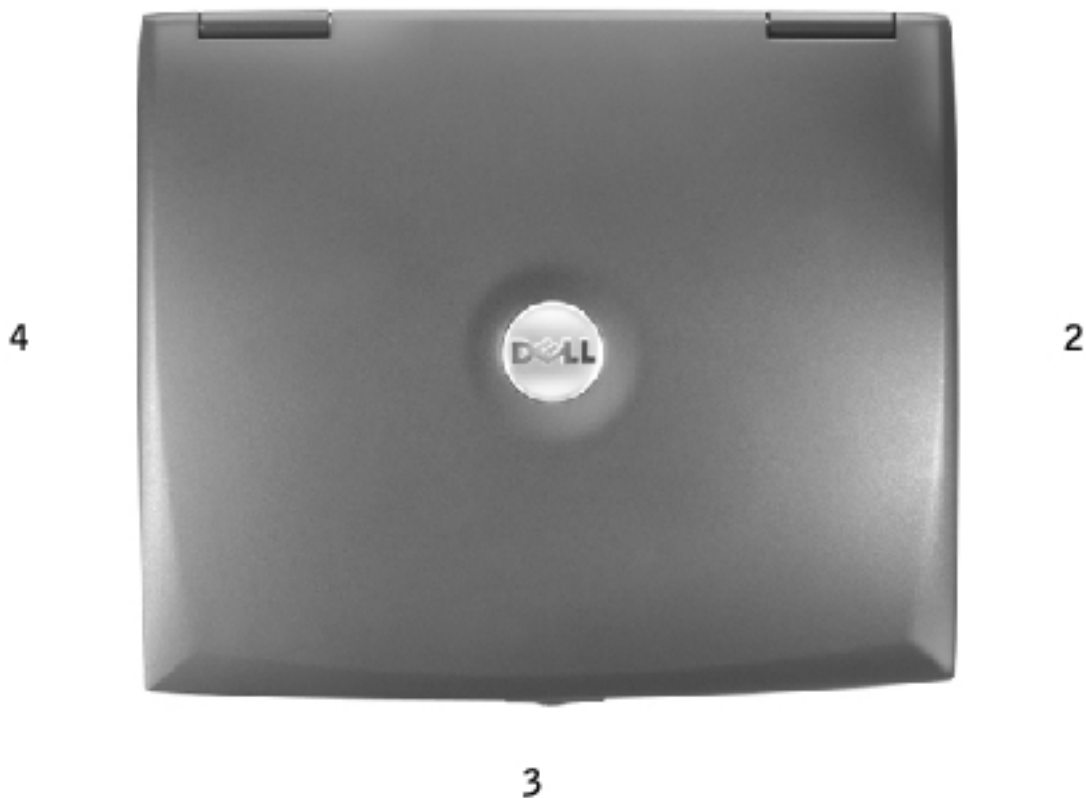

1	back
2	right
3	front
4	left



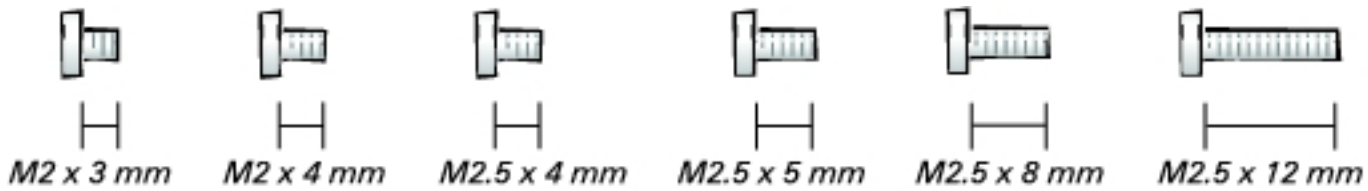

## Screw Identification

When you are removing and replacing components, photocopy "[Screw Identification](#)" as a tool to lay out and keep track of the screws. The placemat provides the number of screws and their sizes.

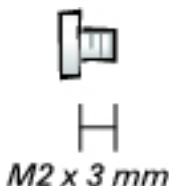

**NOTICE:** When reinstalling a screw, you must use a screw of the correct diameter and length. Ensure that the screw is properly aligned with its corresponding hole, and avoid overtightening.

**NOTE:** All M2.5 x 4 screws are silver, and all other screws are black.

<p><b>Back-Panel Fan:</b></p> <p>(2 each)</p>  <p>M2.5 x 5 mm</p>	<p><b>Hard Drive Door:</b></p> <p>(1 each)</p>  <p>M2.5 x 5 mm</p>
<p><b>Memory Module/ Modem Cover:</b></p> <p>(1 each)</p>  <p>M2.5 x 5 mm</p>	<p><b>Modem to System Board:</b></p> <p>(2 each)</p>  <p>M2 x 3 mm</p>
<p><b>Optical Drive:</b></p> <p>(1 each)</p>  <p>M2.5 x 8 mm</p>	<p><b>Floppy Drive:</b></p> <p>(2 each)</p>  <p>M2.5 x 5 mm</p>

**Keyboard Assembly to Hinges:**

(2 each)



**Keyboard to Bottom Case:**

(4 each; silver screws)



**Display Assembly to Back Panel:**

(2 each)



**Display-Feed Flex Cable to System Board:**

(2 each)



**Hinge Bracket to Bottom Case:**

(4 each)



**Display Bezel:**

(5 each)



**Screw Covers (5 each)**



**Display Panel:**

(4 each)



**Display-Feed Flex Cable to Display Assembly:**

(1 each)



**Display Latch:**

(2 each)



**EMI Shield:**

(3 each)



**Top of Palm Rest to Bottom Case:**

(2 each)



**Video Board to Bottom Case:**

(1 each)

V710

V740



**Palm Rest to Bottom Case:**

(12 each)



**Floppy Drive Cage to Bottom Case:**

(2 each)



**Hard Drive Cage to  
Bottom Case:**

(2 each)



**System Board to  
Bottom Case:**

(6 each; silver screws)

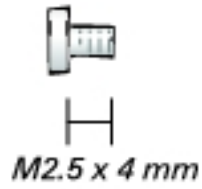

**Battery Latch Assembly  
to Bottom Case:**

(1 each)



---

[Back to Contents Page](#)

[Back to Contents Page](#)

# System Components

## Dell™ Latitude™ V710/V740 Service Manual

- ➔ **NOTICE:** Only a certified service technician should perform repairs on your computer. Damage due to servicing that is not authorized by Dell is not covered by your warranty.
- ➔ **NOTICE:** Unless otherwise noted, each procedure in this document assumes that a part can be replaced by performing the removal procedure in reverse order.

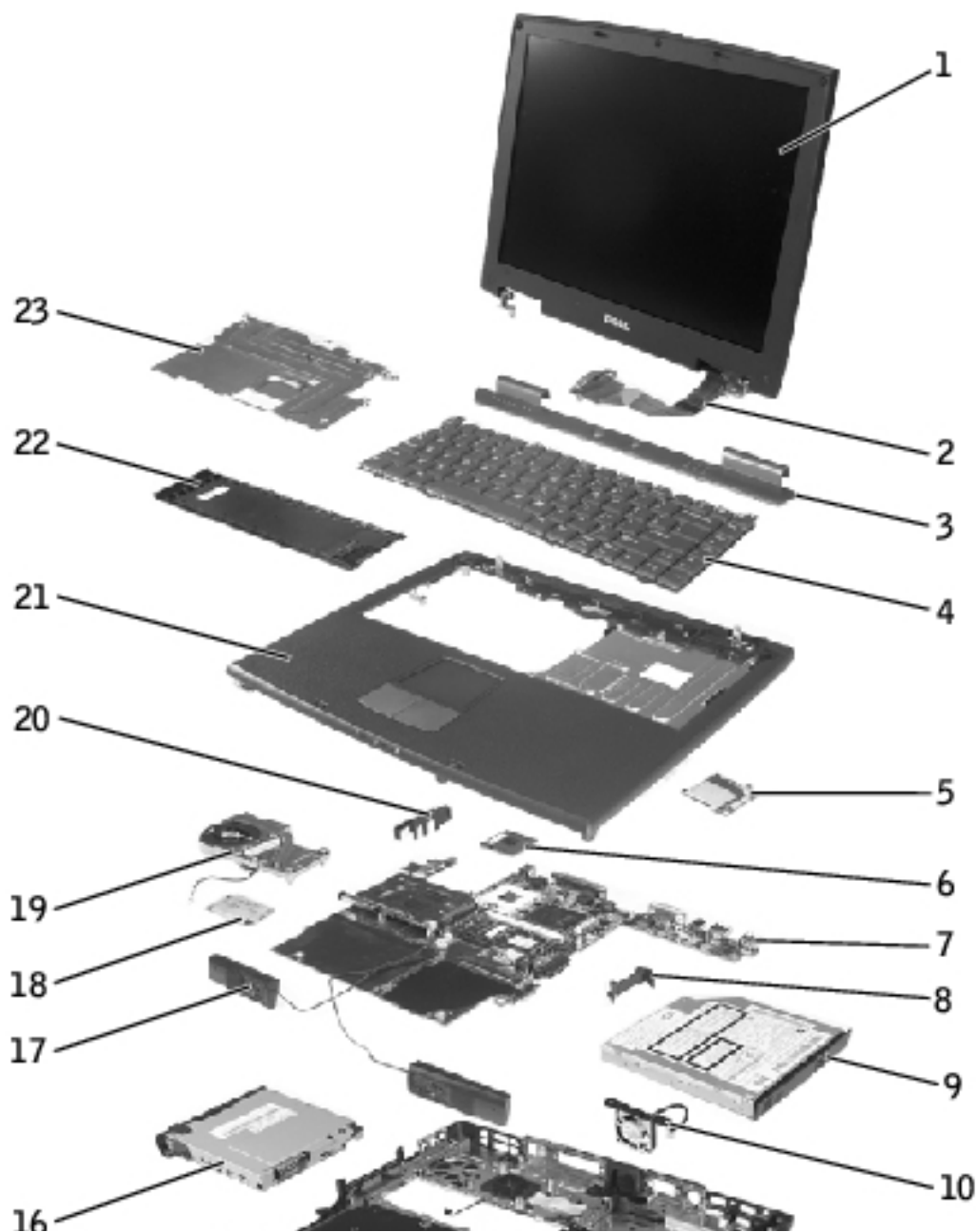

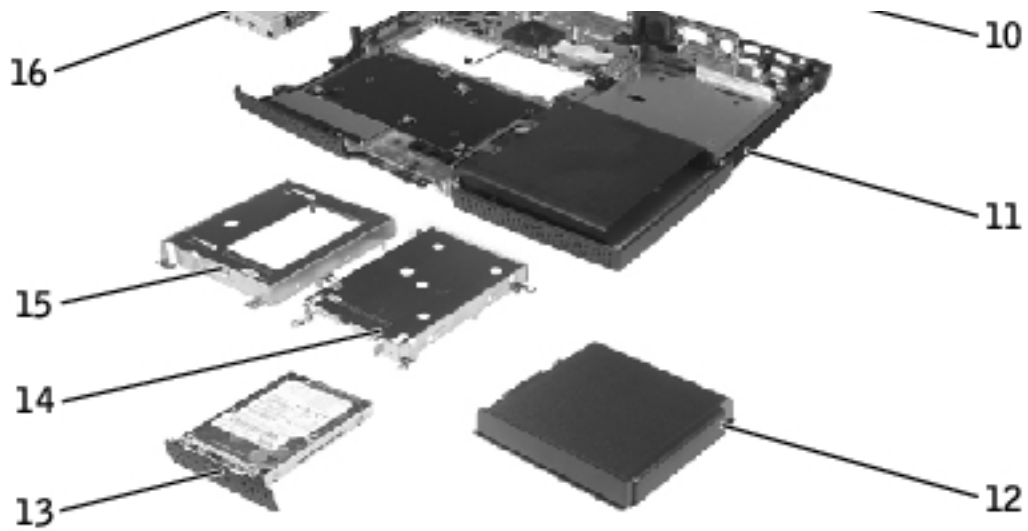

1	display assembly	13	hard drive
2	display-feed flex cable	14	hard drive cage
3	center control cover	15	floppy drive cage
4	keyboard	16	floppy drive
5	video board	17	speaker
6	microprocessor	18	modem
7	system board	19	microprocessor thermal-cooling assembly
8	battery connector cover	20	headphone/microphone bridge
9	optical drive	21	palm rest
10	back-panel fan (V740 only)	22	memory module/modem cover
11	bottom case	23	EMI shield
12	battery		

[Back to Contents Page](#)



[Back to Contents Page](#)

# Back-Panel Fan (V740 Only)

Dell™ Latitude™ V710/V740 Service Manual

## Removing the Back-Panel Fan

➡ **NOTICE:** To prevent data loss, turn off the computer before removing the back-panel fan. Do not remove the fan while the computer is on or in a power management mode.

➡ **NOTICE:** Read "[Preparing to Work Inside the Computer](#)" before performing the following procedure.

1. Ensure that the work surface is flat and clean to prevent scratching the computer cover.
2. Save and close any open files, exit any open programs, and shut down the computer.

➡ **NOTICE:** Disconnect the computer and any attached devices from electrical outlets, and remove any installed batteries.

➡ **NOTICE:** To avoid ESD, ground yourself by using a wrist grounding strap or by touching an unpainted metal surface on the computer.

3. Turn the computer over. Use a #1 Phillips screwdriver to remove the two M2.5 x 5-mm screws from the fan cover, and place the screws in a safe location.

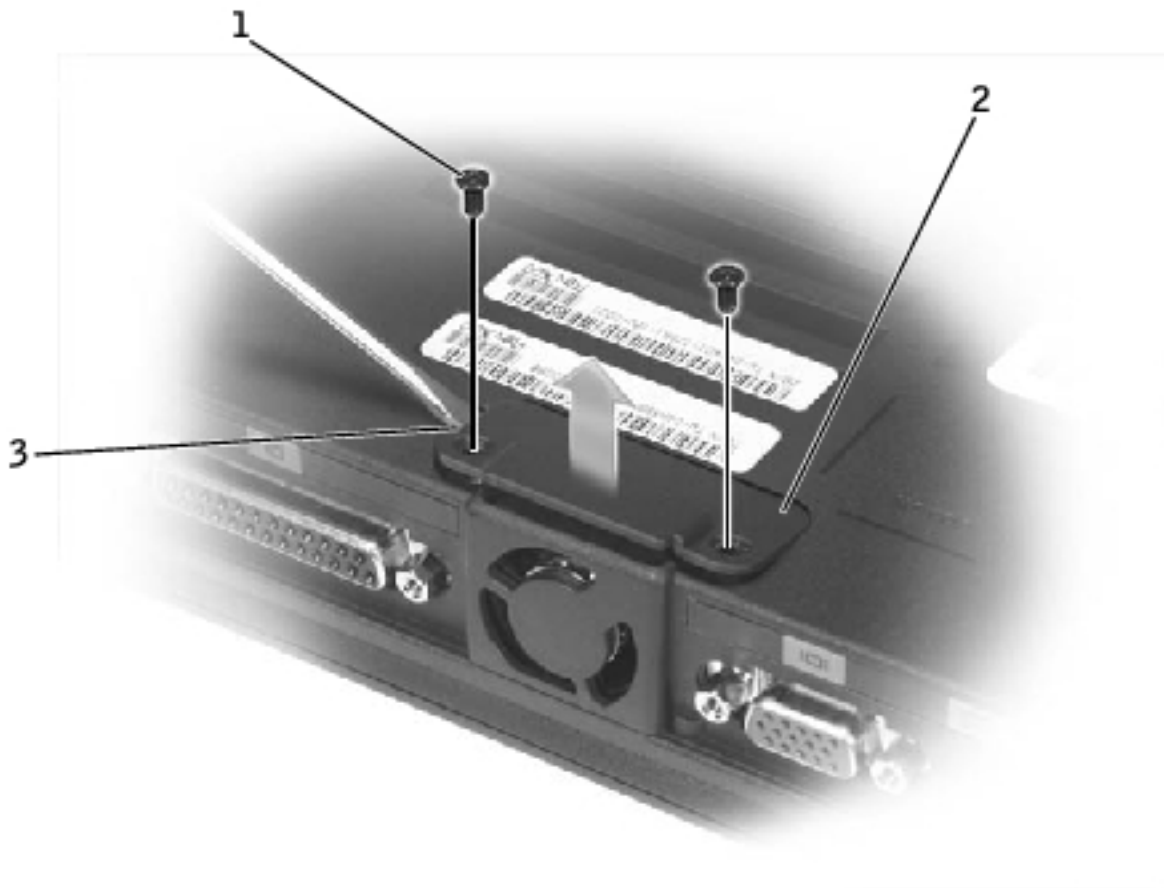

1	M2.5 x 5-mm screws (2)
2	fan cover
3	scalloped left edge of fan cover

4. Use a small flat-blade screwdriver or plastic scribe to lift the scalloped left edge of the fan cover, and pry the cover loose from the bottom case.
5. Lift the fan cover up and away from the bottom case.
6. Disconnect the fan cable connector from the system board.
7. Lift the fan out of the bottom case.

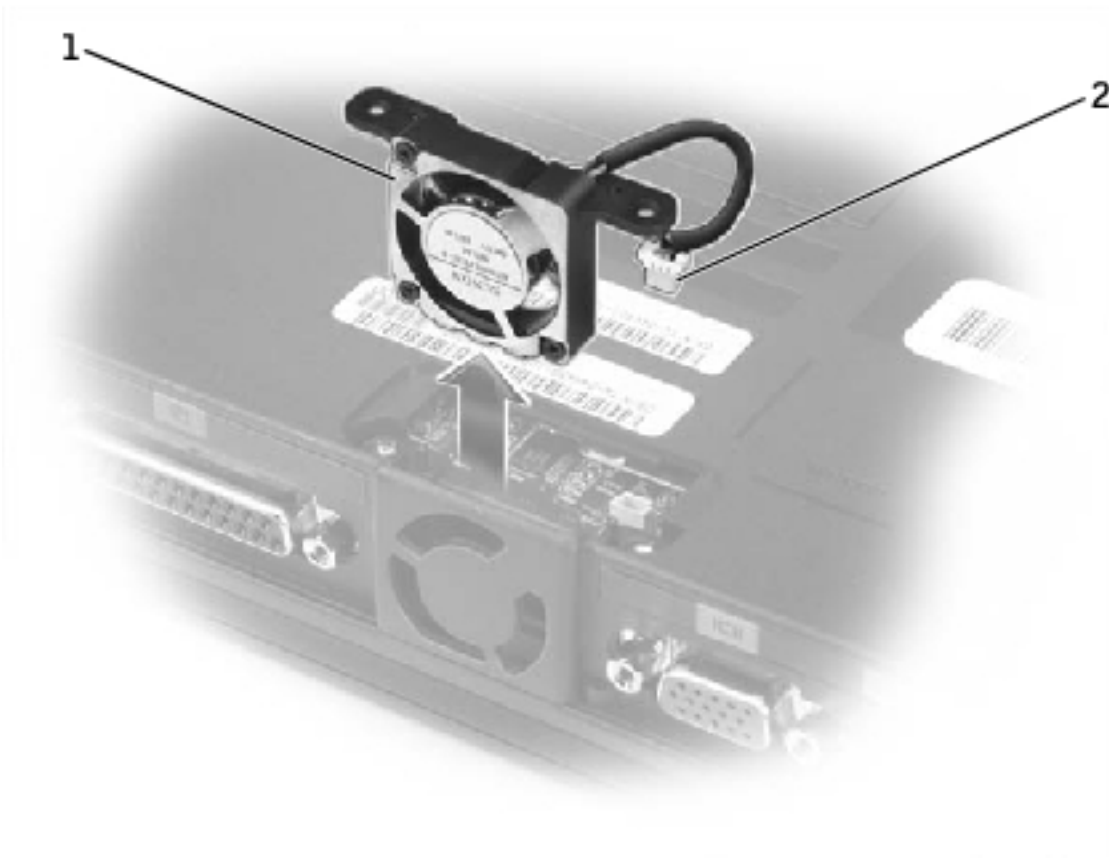

1	fan
2	fan cable connector

## Replacing the Back-Panel Fan

1. Slide the fan into the bottom case.
2. Tuck the fan cable under the bottom case, and connect the cable to the system board.





1	fan cable
---	-----------

3. Replace the fan cover, and reinstall the two M2.5 x 5-mm screws that secure the cover to the bottom case.

---







[Back to Contents Page](#)

[Back to Contents Page](#)

# Hard Drive

## Dell™ Latitude™ V710/V740 Service Manual

### Removing the Hard Drive

-  **NOTICE:** To prevent data loss, turn off the computer before removing the hard drive. Do not remove the hard drive while the computer is on or in a power management mode.
-  **NOTICE:** Hard drives are extremely fragile; even a slight bump can damage the drive.
-  **CAUTION:** If you remove the hard drive from the computer when the drive is hot, *do not touch the metal housing of the hard drive.*
-  **NOTICE:** Read "[Preparing to Work Inside the Computer](#)" before performing the following procedure.
  1. Ensure that the work surface is flat and clean to prevent scratching the computer cover.
  2. Save and close any open files, exit any open programs, and shut down the computer.
-  **NOTICE:** Disconnect the computer and any attached devices from electrical outlets, and remove any installed batteries.
-  **NOTICE:** To avoid ESD, ground yourself by using a wrist grounding strap or by touching an unpainted metal surface on the computer.
  3. Turn the computer over. Use a #1 Phillips screwdriver to remove the M2.5 x 5-mm screw from the hard drive door, and place the screw in a safe location.

- NOTICE:** When the hard drive is not in the computer, store it in protective antistatic packaging.

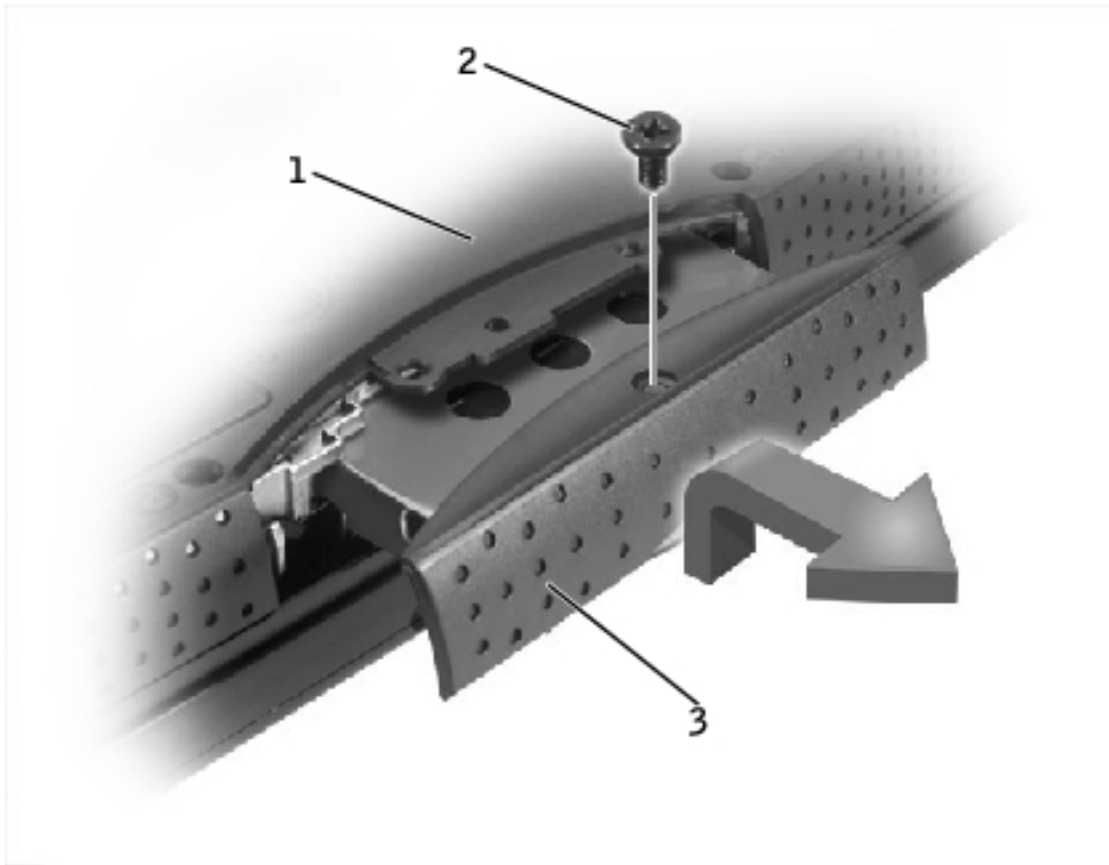

1	bottom of computer
2	M2.5 x 5-mm screw
3	hard drive door

- Lift the hard drive door to release it, and slide the hard drive out of the computer.

## Replacing the Hard Drive

- Remove the new drive from its packaging.

Save the original packaging to use when storing or shipping the hard drive.

-  **NOTICE:** Use firm and even pressure to slide the drive into place. If you force the hard drive into place using excessive force, you may damage the connector.
2. Slide the hard drive into the bay, and press down on the hard drive door until it is fully seated.
  3. Replace and tighten the M2.5 x 5-mm screw in the hard drive door.
  4. Use the *Operating System* CD to install the operating system for your computer.
  5. Use the *Drivers and Utilities* CD to install the drivers and utilities for your computer.
- 

[Back to Contents Page](#)

[Back to Contents Page](#)

# Memory Module, Modem, Optical Drive, and Floppy Drive



## Dell™ Latitude™ V710/V740 Service Manual

- [Memory Module](#)
  - [Modem](#)
  - [Optical Drive](#)
  - [Floppy Drive](#)
- 

## Memory Module

### Removing the Memory Module/Modem Cover

 **NOTE:** This procedure covers removing and replacing the memory module located under the memory module/modem cover on the bottom of the computer. A second memory module resides on the upper surface of the system board under the EMI shield. To replace the memory module under the EMI shield, perform the procedure for [removing the EMI shield](#). Then replace the memory module.

-  **NOTICE:** Disconnect the computer and any attached devices from electrical outlets, and remove any installed batteries.
-  **NOTICE:** To avoid ESD, ground yourself by using a wrist grounding strap or by touching an unpainted metal surface on the computer.
-  **NOTICE:** Read "[Preparing to Work Inside the Computer](#)" before performing the following procedure.

1. Turn the computer over, and remove the memory module/modem cover:
  - a. Remove the M2.5 x 5-mm screw from the memory module/modem cover.

- b. Slide the cover out approximately 10 mm, and lift it away from the computer.

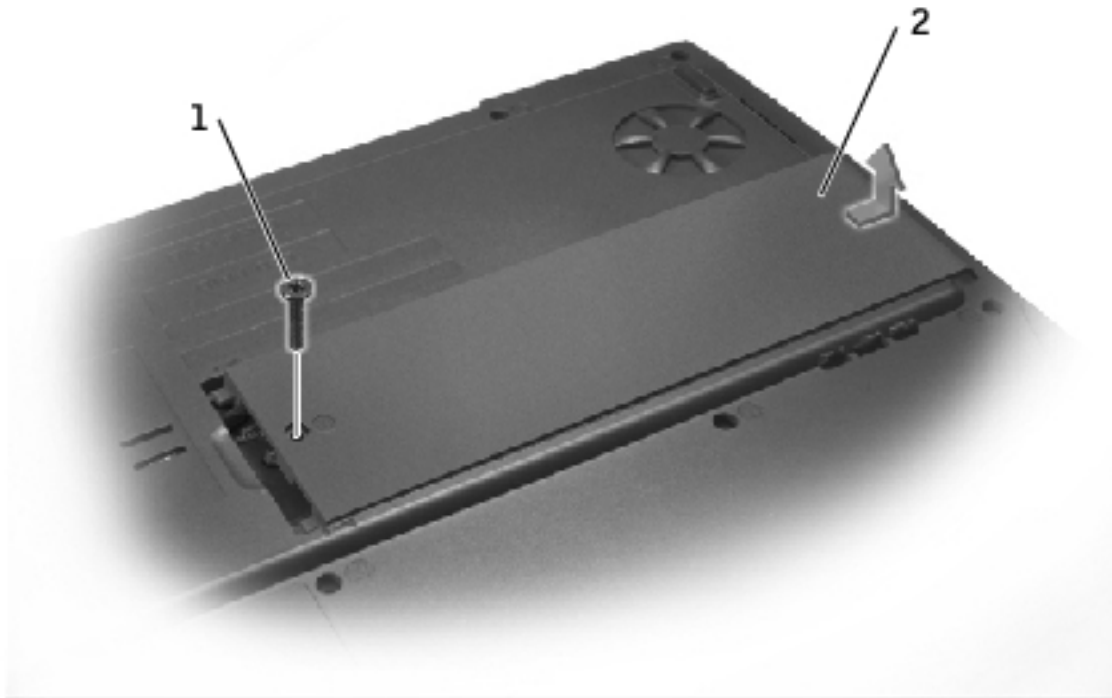

1	M2.5 x 5-mm screw
2	memory module/modem cover

➔ **NOTICE:** To prevent damage to the memory module connector, do not use tools to spread the inner metal tabs that secure the memory module.

2. If you are replacing a memory module, remove the existing module.

➔ **NOTICE:** Handle memory modules by their edges, and do not touch the components on a module.

- a. Use your fingertips to carefully spread apart the securing clips on each end of the memory module connector.

The module should pop up.

**b. Remove the module from the connector.**

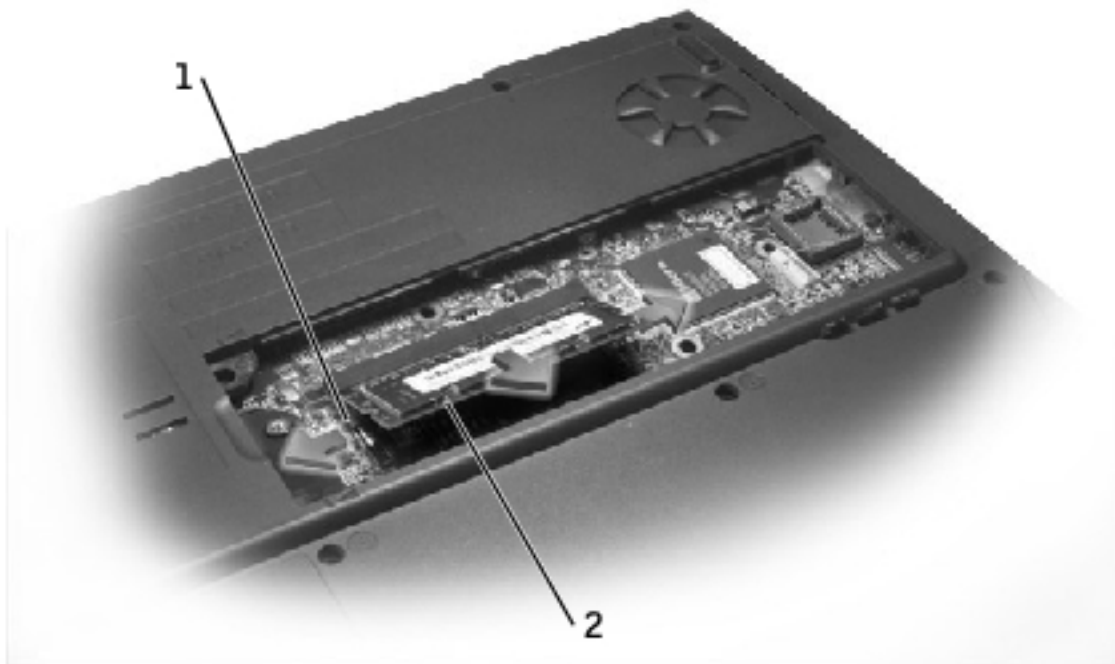

1	securing clip
2	memory module

**3. Ground yourself and install the new memory module:**

- a. Align the notch in the module with the slot in the center of the connector.
- b. Slide the edge of the module firmly into the connector, and rotate the module down until you hear a click. If you do not hear the click, remove the module and reinstall it.

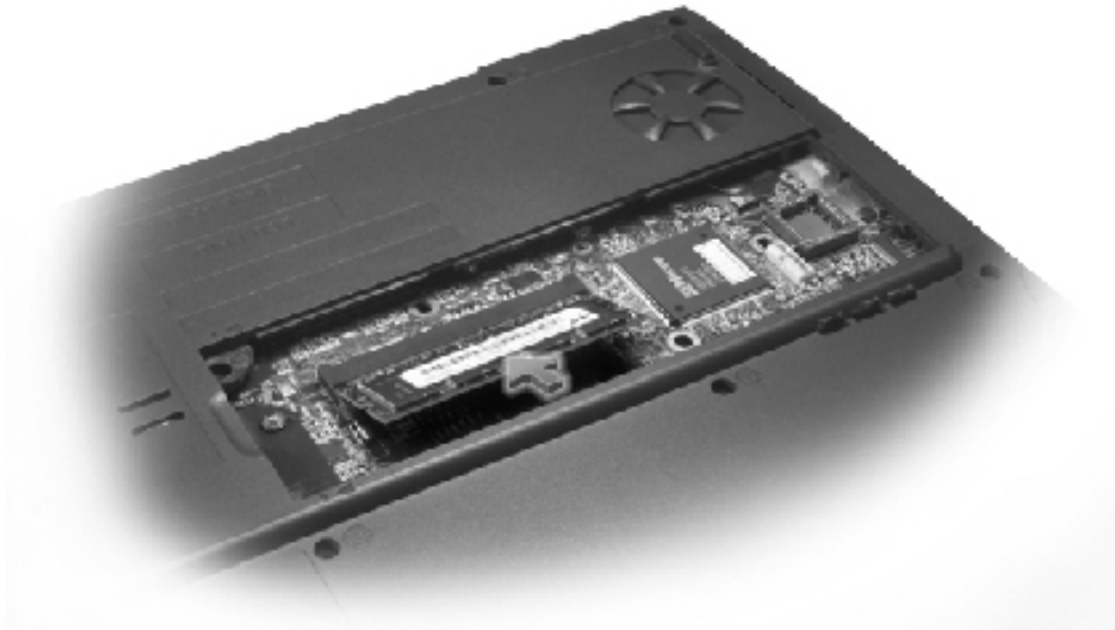

4. Replace the cover and screw:

- a. Place the memory module/modem cover over the memory module/modem compartment so that the end of the cover with the screw hole is lined up with the lines and arrows on the bottom of the computer.
- b. Press down on the center of the memory module/modem cover, and slide the cover until it is secured.
- c. Replace and tighten the M2.5 x 5-mm screw.

➔ **NOTICE:** If the memory module/modem cover is difficult to close, remove the module and reinstall it. Forcing the cover to close may damage your computer.



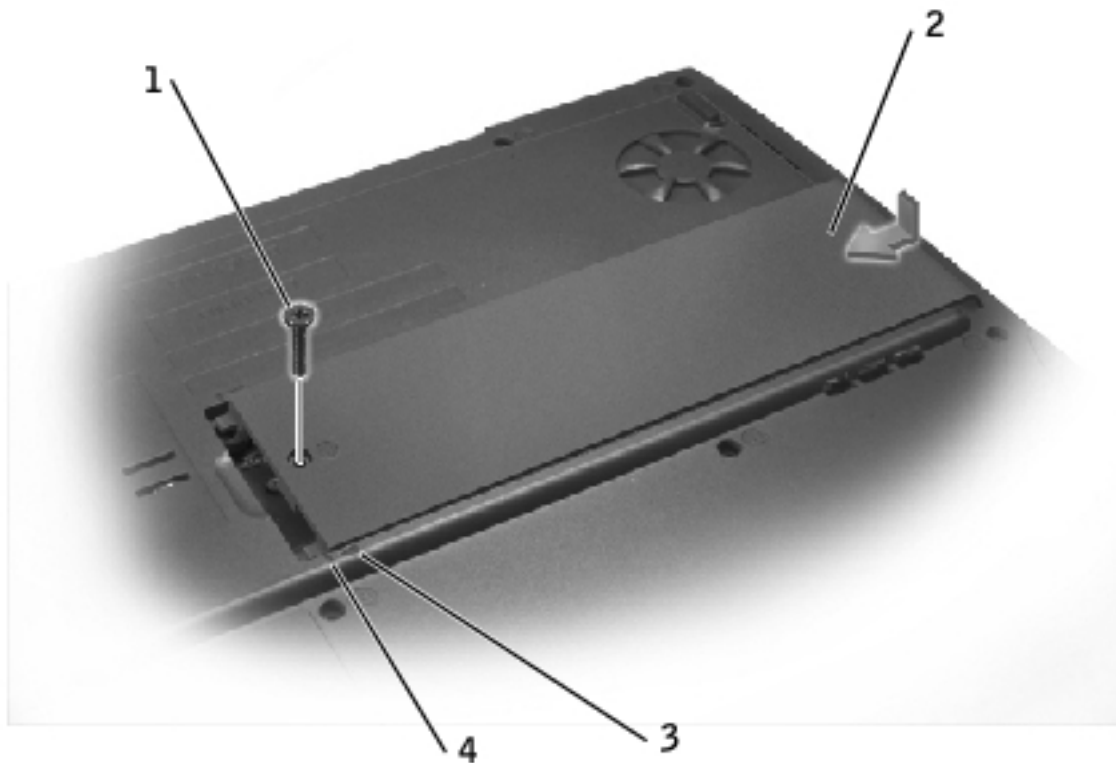

1	M2.5 x 5-mm screw
2	memory module/modem cover
3	arrows (2)
4	lines (2)

5. Insert the battery into the battery bay, or connect the AC adapter to your computer and an electrical outlet.
6. Turn on the computer.

As the computer boots, it detects the additional memory and automatically updates the system configuration information.

## Modem

**⚠ CAUTION:** Before performing these procedures, turn off the computer, disconnect it from the electrical outlet, and disconnect the modem from the telephone wall jack.

**➡ NOTICE:** Disconnect any attached devices from electrical outlets, and remove any installed batteries.

**➡ NOTICE:** To avoid ESD, ground yourself by using a wrist grounding strap or by touching an unpainted metal surface on the computer.

**➡ NOTICE:** Read "[Preparing to Work Inside the Computer](#)" before performing the following procedure.

1. Turn the computer over, and remove the memory module/modem cover:
  - a. Remove the M2.5 x 5-mm screw from the memory module/modem cover.
  - b. Slide the cover out approximately 10 mm, and lift it away from the computer.

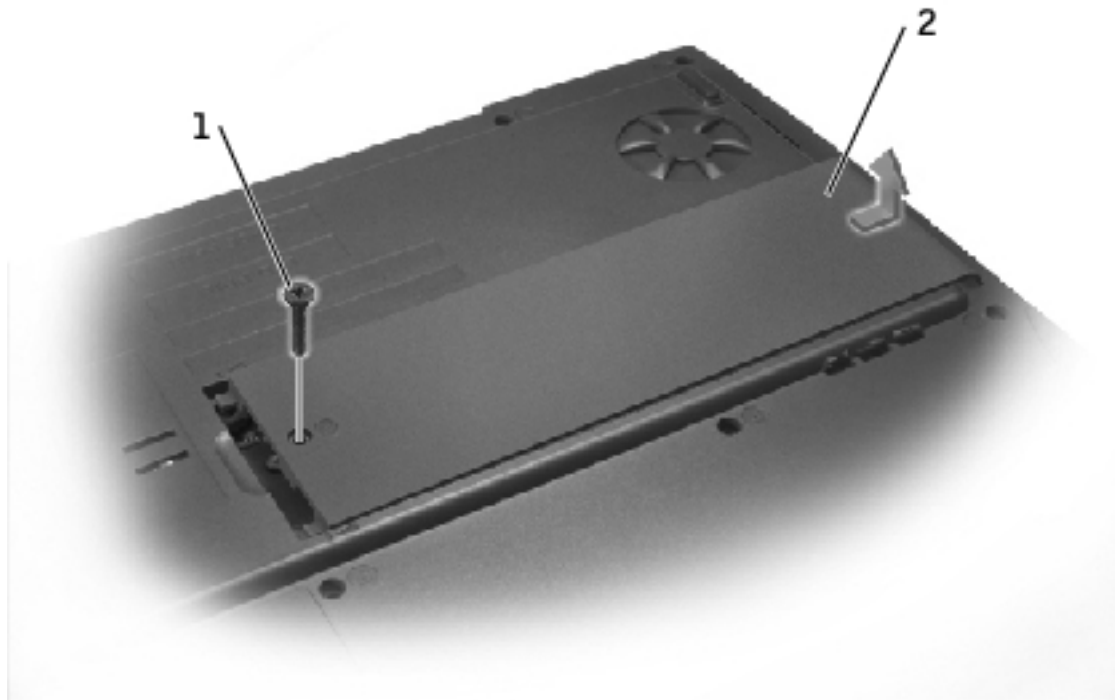

1	M2.5 x 5-mm screw
2	memory module/modem cover

2. If a modem is not already installed, go to [step 3](#). If you are replacing a modem, remove the existing modem:
  - a. Remove the two M2 x 3-mm screws that secure the modem to the system board, and set them aside.
  - b. Pull the modem straight up by the pull tab to lift the modem out of its connector, and disconnect the modem cable.

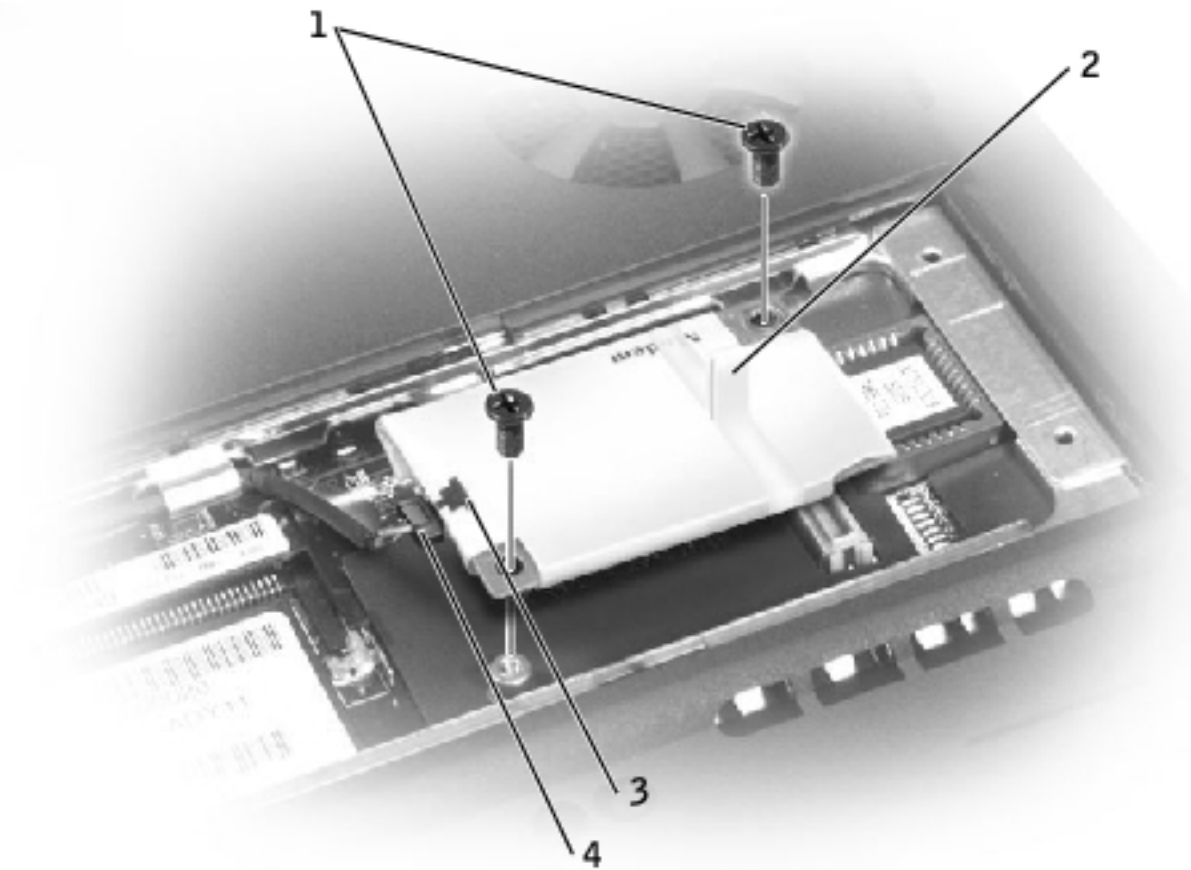

1	M2 x 3-mm screws (2)
2	pull tab
3	modem cable connector
4	modem cable

3. Connect the modem cable to the new modem.

 **NOTICE:** The cable connectors are keyed for correct insertion; do not force the connections.

4. Align the modem with the screw holes and press the modem into its connector on the system board.

Install the two M2 x 3-mm screws to secure the modem to the system board.

5. Replace the memory module/modem cover and screw:
  - a. Place the memory module/modem cover over the memory module/modem compartment so that the end of the cover with the screw hole is lined up with the lines and arrows on the bottom of the computer.
  - b. Press down on the center of the memory module/modem cover, and slide the cover until it is secured.
  - c. Replace and tighten the M2.5 x 5-mm screw.

 **NOTICE:** Replace the memory module/modem cover so that it is seated properly around the edges and does not bulge near the center of the cover. Tightening the memory-module/modem cover screw when the cover is improperly seated can damage your computer.

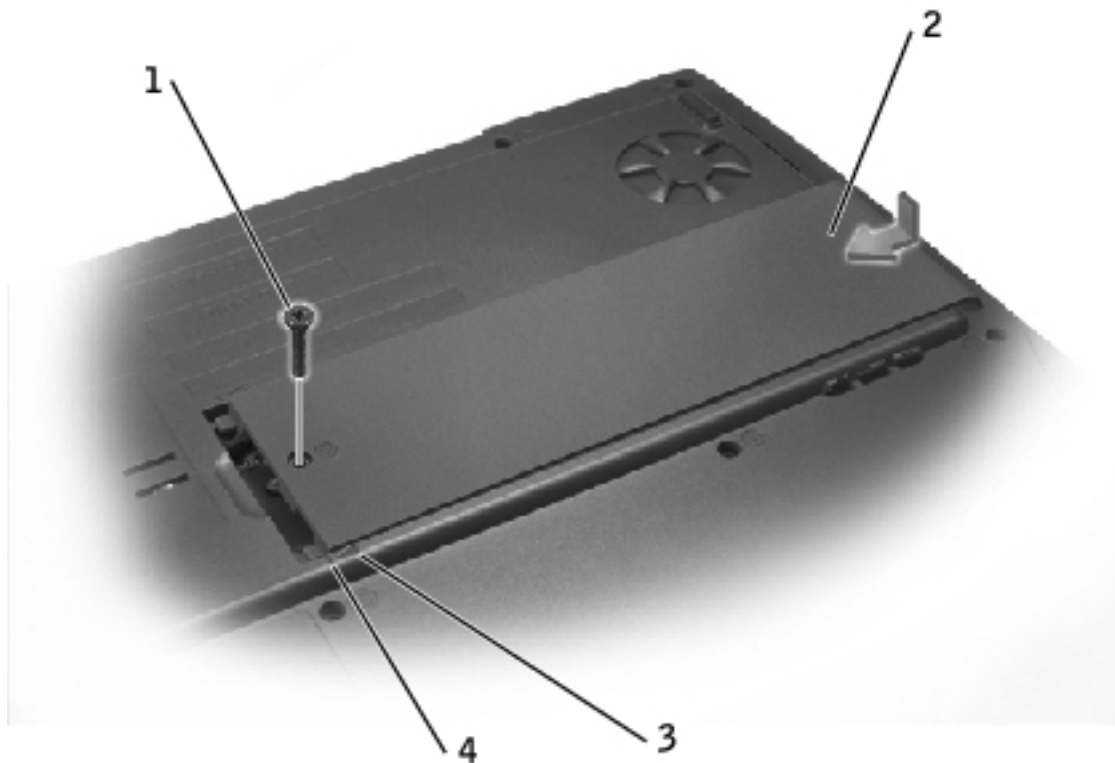

1	M2.5 x 5-mm screw
2	memory module/modem cover
3	arrows (2)
4	lines (2)

## Optical Drive

### Removing an Installed Optical Drive

- ➡ **NOTICE:** To avoid ESD, ground yourself by using a wrist grounding strap or by touching an unpainted metal surface on the computer.
- ➡ **NOTICE:** Read "[Preparing to Work Inside the Computer](#)" before performing the following procedure.

1. If a disc is in the optical drive, remove the disc.

**⬅ NOTICE:** Disconnect the computer and attached devices from electrical outlets, and remove any installed batteries.

2. Remove the memory module/modem cover:
  - a. Remove the M2.5 x 5-mm screw from the memory module/modem cover.
  - b. Slide the cover out approximately 10 mm, and lift it away from the computer.

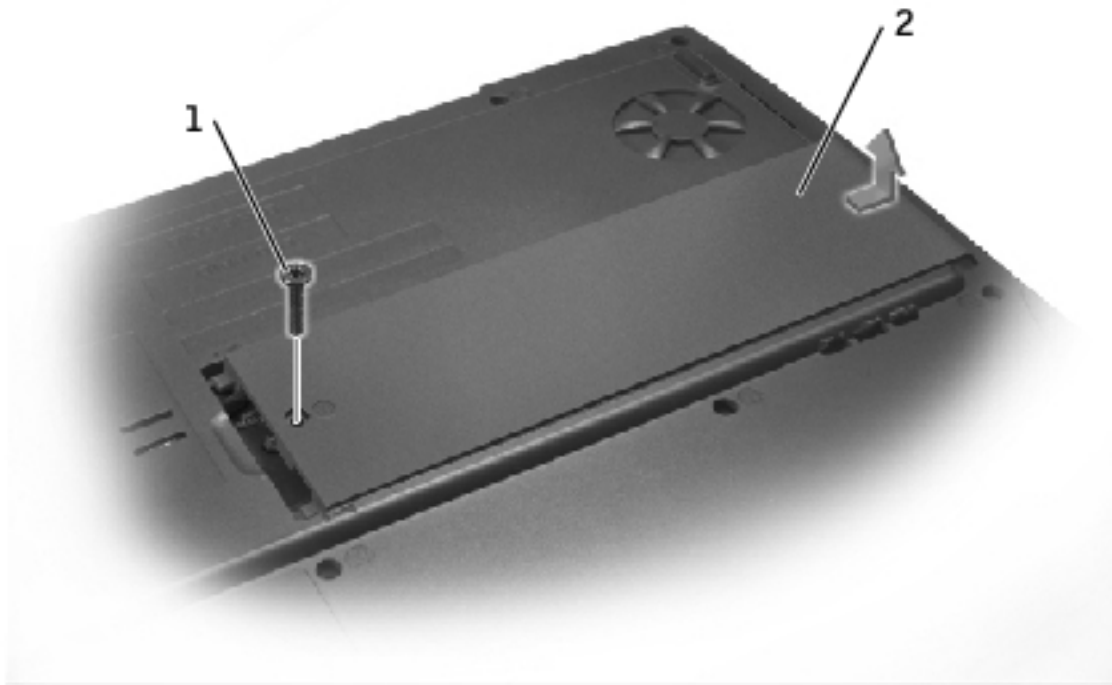

1	M2.5 x 5-mm screw
2	memory module/modem cover

3. Remove the M2.5 x 8-mm screw from the optical drive.
4. Press the optical-drive release button, and pull the optical drive out of the computer.

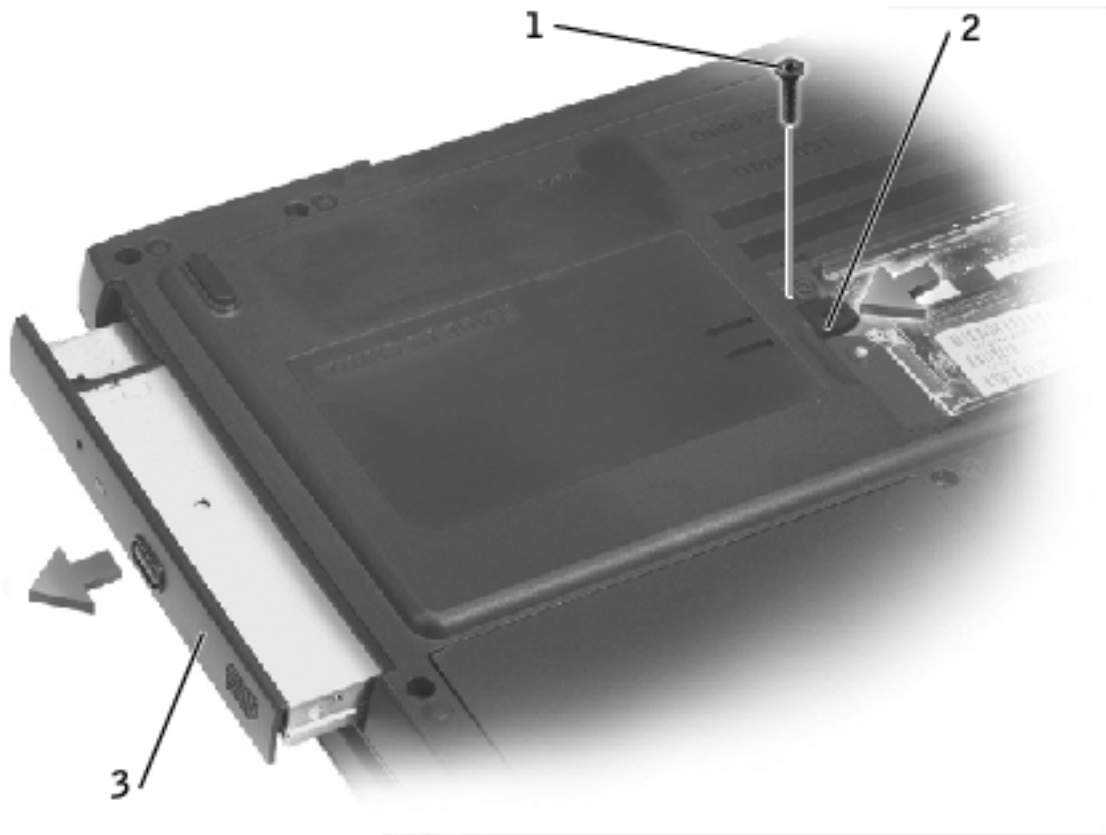

1	M2.5 x 8-mm screw
2	optical-drive release button
3	optical drive

## Installing an Optical Drive

1. Slide the optical drive into the bay until the optical drive is fully seated.
2. Replace and tighten the M2.5 x 8-mm screw.

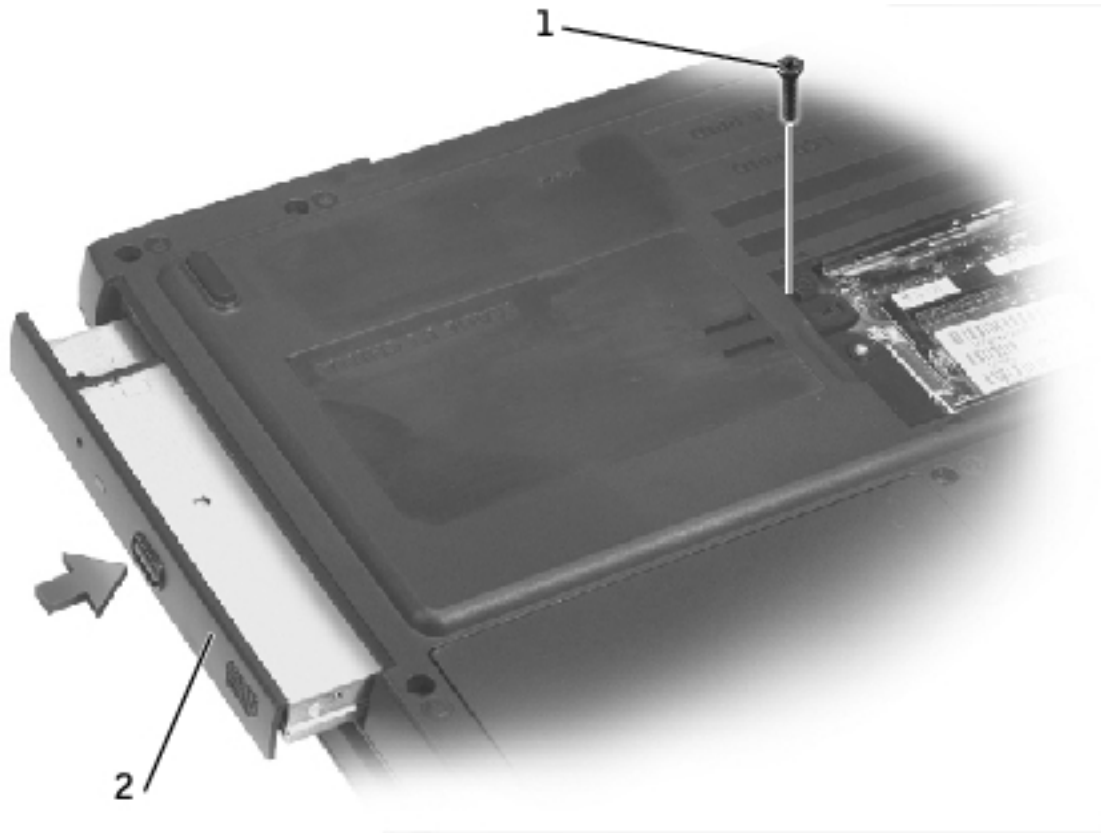

1	M2.5 x 8-mm screw
2	optical drive

➔ **NOTICE:** Replace the memory module/modem cover so that it is seated properly around the edges and does not bulge near the center of the cover. Tightening the memory-module/modem cover screw when the cover is improperly seated can damage your computer.

### 3. Replace the memory module/modem cover and screw:

- a. Place the memory module/modem cover over the memory module compartment so that the end of the cover with the screw hole is lined up with the lines and arrows on the bottom of the computer.
- b. Press down on the center of the memory module/modem cover, and slide the memory module/modem cover until it is secured.
- c. Replace and tighten the M2.5 x 5-mm screw.



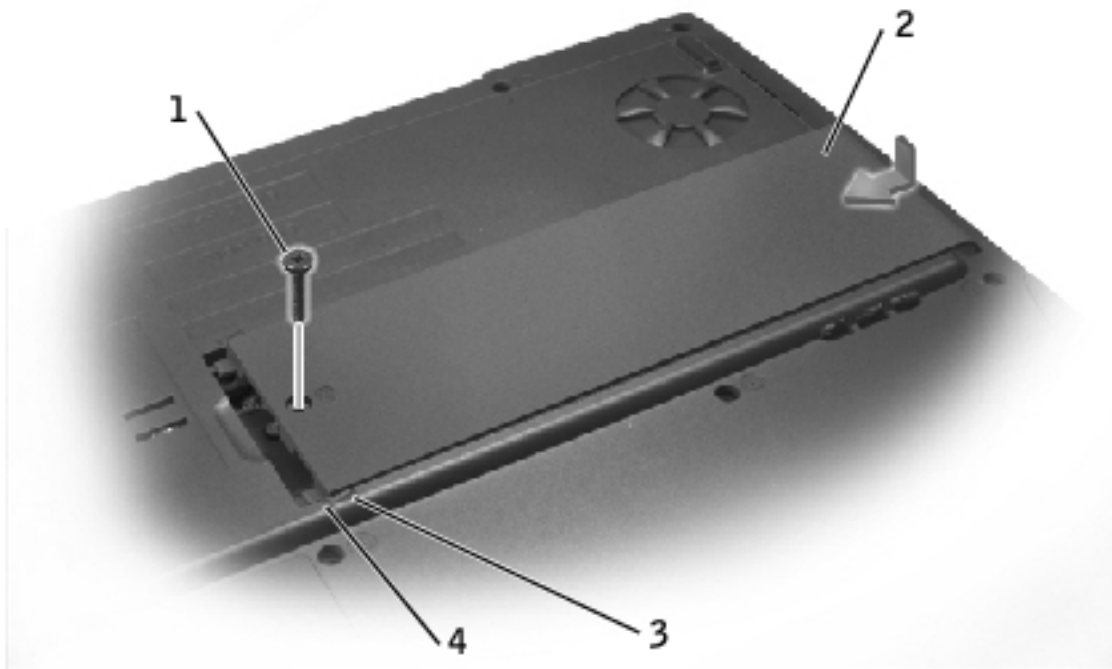

1	M2.5 x 5-mm screw
2	memory module/modem cover
3	arrows (2)
4	lines (2)

## Floppy Drive

### Removing an Installed Floppy Drive

- ➔ **NOTICE:** To avoid ESD, ground yourself by using a wrist grounding strap or by touching an unpainted metal surface on the computer.
- ➔ **NOTICE:** Read "[Preparing to Work Inside the Computer](#)" before performing the following procedure.

1. If a disk is in the floppy drive, remove the disk.

➡ **NOTICE:** Disconnect the computer and attached devices from electrical outlets, and remove any installed batteries.

➡ **NOTICE:** Ensure that you disconnect the flex cable from the ZIF connector before you remove the floppy drive from the computer. See [step 3](#) for further instructions.

2. Remove the two M2.5 x 5-mm screws from the floppy drive, and partially pull the drive out of the computer.

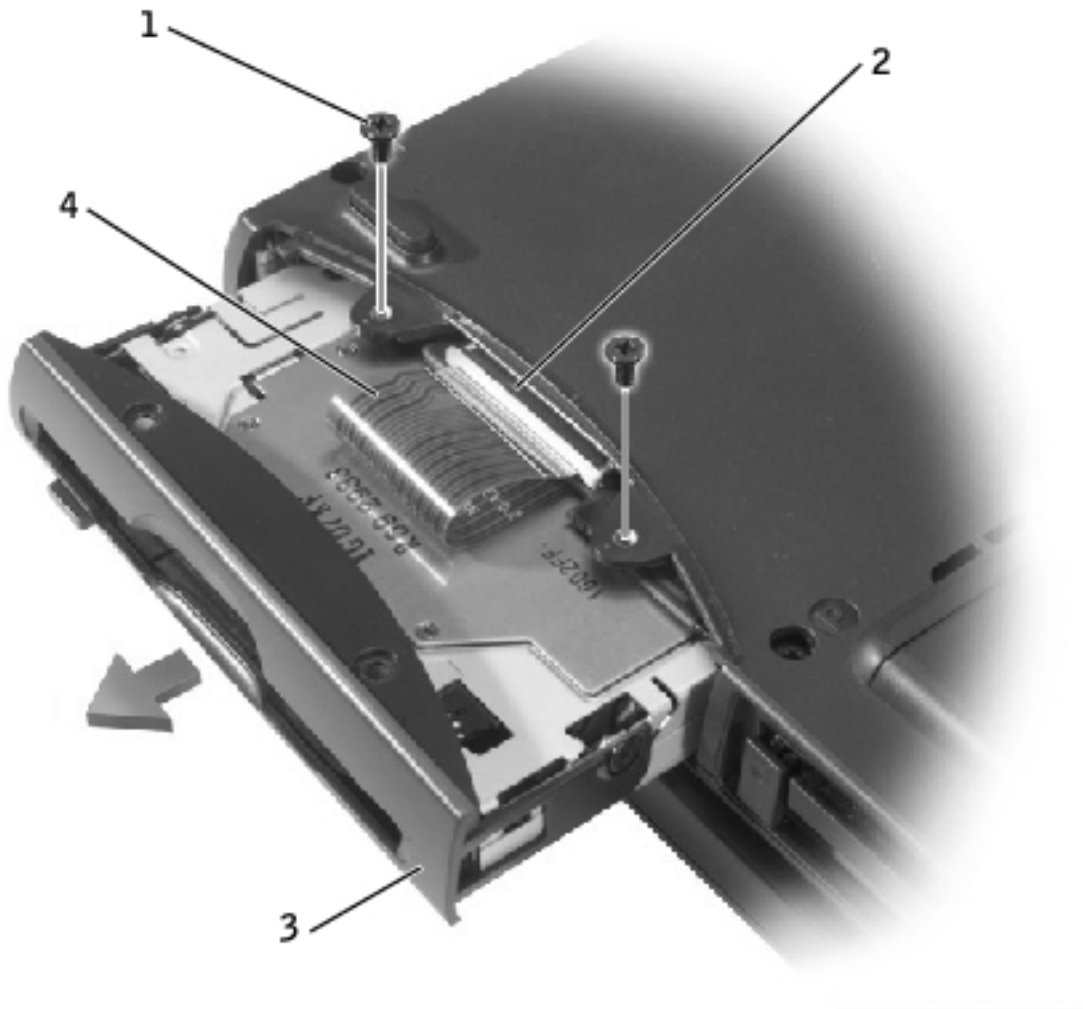

1	M2.5 x 5-mm screws (2)
2	ZIF connector
3	floppy drive
4	flex cable

**➔ NOTICE:** Release the securing tab before you disconnect the flex cable from the ZIF connector. Failure to do so can damage the ZIF connector.

3. Disconnect the flex cable from the ZIF connector:
  - a. Pull the securing tab away from the ZIF connector.
  - b. Gently pull the flex cable out of the ZIF connector.

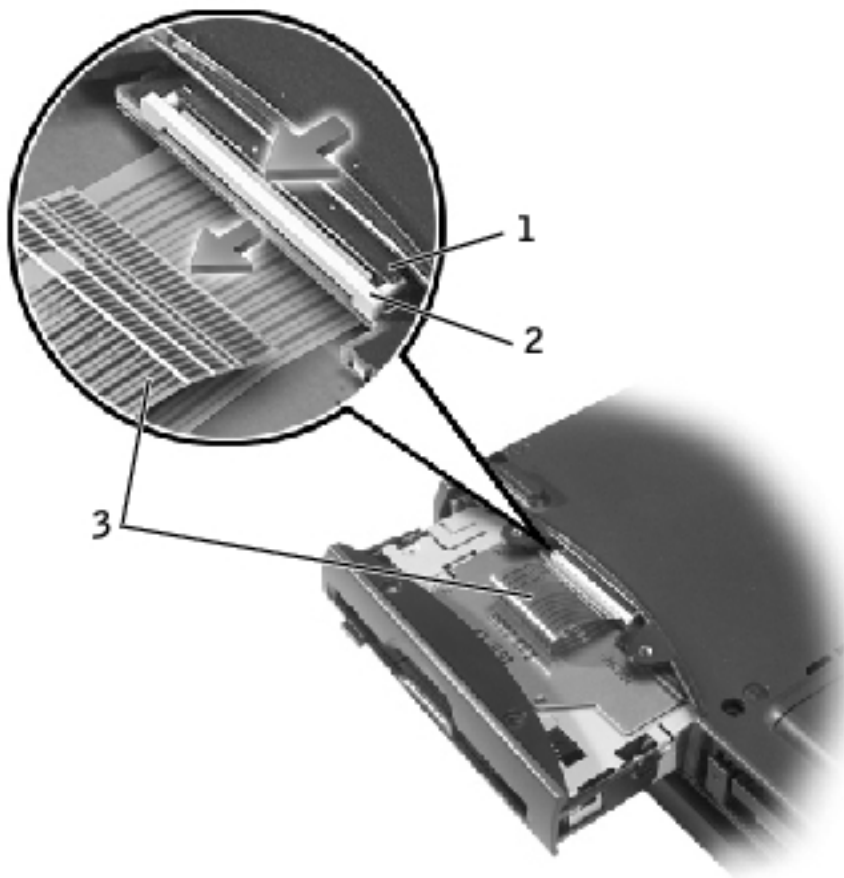

1	ZIF connector
2	securing tab
3	flex cable

## Installing a Floppy Drive

1. Slide the floppy drive partially into the bay.

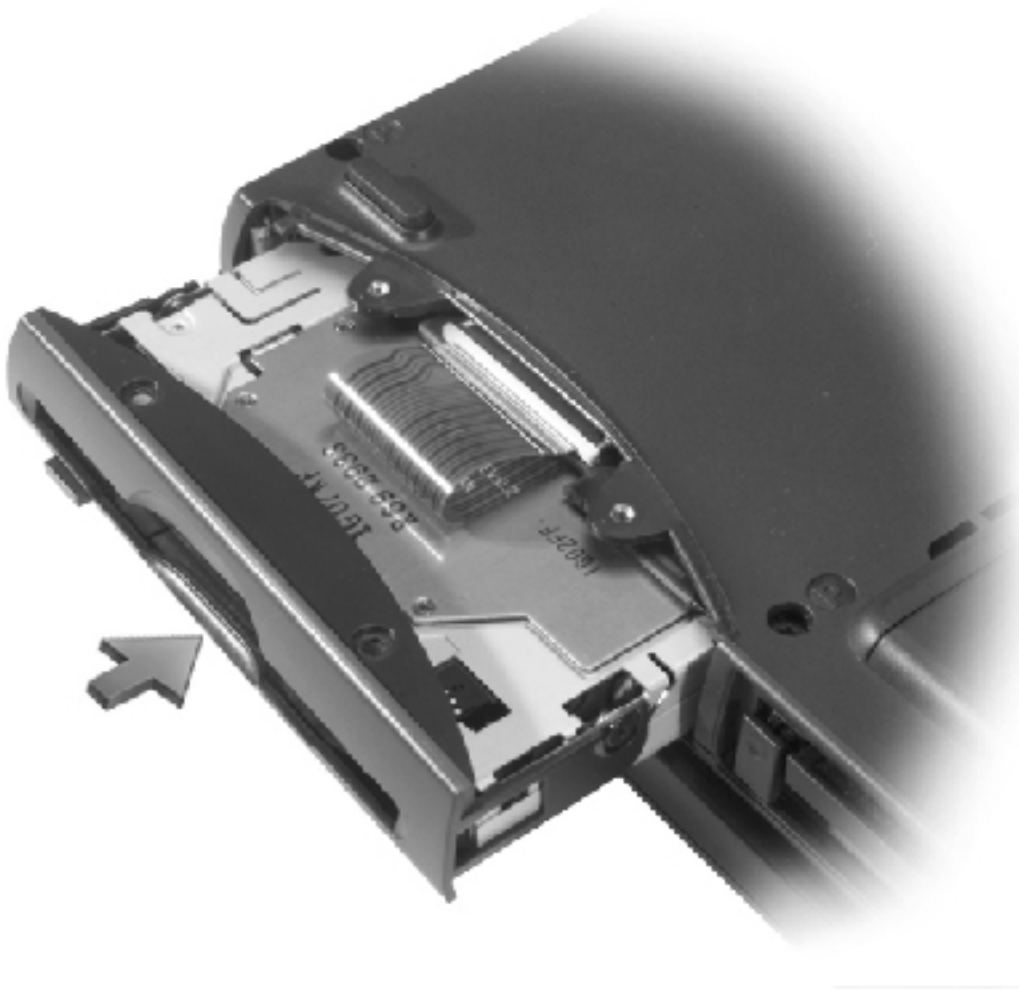

 **NOTE:** If you do not connect the flex cable to the ZIF connector properly, your floppy drive will not function properly.

2. Reconnect the flex cable to the ZIF connector:

- a. Pull and hold the securing tab away from the ZIF connector.
- b. While holding the securing tab, insert the flex cable into the ZIF connector.

Ensure that you insert the flex cable *into* the ZIF connector and not below the ZIF connector.

- c. Hold the flex cable in place and push the securing tab toward the ZIF connector.

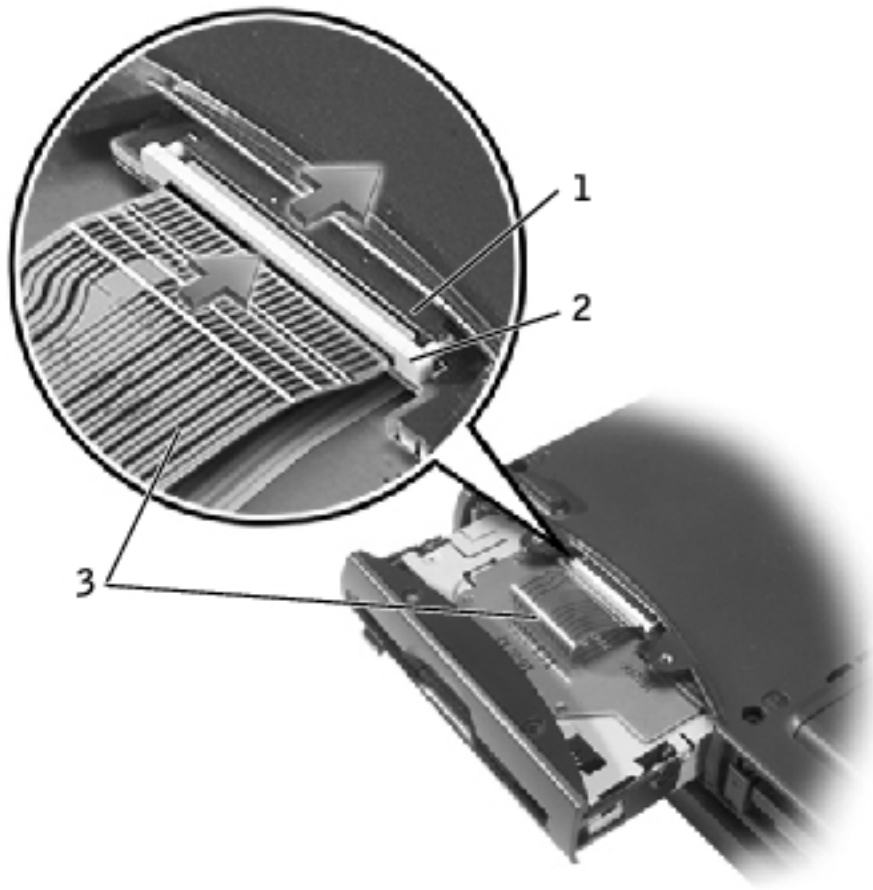

1	ZIF connector
2	securing tab
3	flex cable

3. Slide the floppy drive into the bay until the drive is fully seated.
4. Replace and tighten the two M2.5 x 5-mm screws.
5. Install the battery.
6. Turn on the computer and try using the floppy drive.

If the computer does not detect the floppy drive, you may have improperly inserted the flex cable. If so, disconnect the flex cable and reconnect it to the ZIF connector.

[Back to Contents Page](#)

[Back to Contents Page](#)

# Keyboard

## Dell™ Latitude™ V710/V740 Service Manual

### Removing the Keyboard

- ➔ **NOTICE:** Disconnect the computer and any attached devices from electrical outlets, and remove any installed batteries.
- ➔ **NOTICE:** To avoid ESD, ground yourself by using a wrist grounding strap or by touching an unpainted metal surface on the computer.
- ➔ **NOTICE:** Read "[Preparing to Work Inside the Computer](#)" before performing the following procedure.

1. Remove the center control cover:

- a. Remove the two M2.5 x 5-mm screws in the back of the hinges.

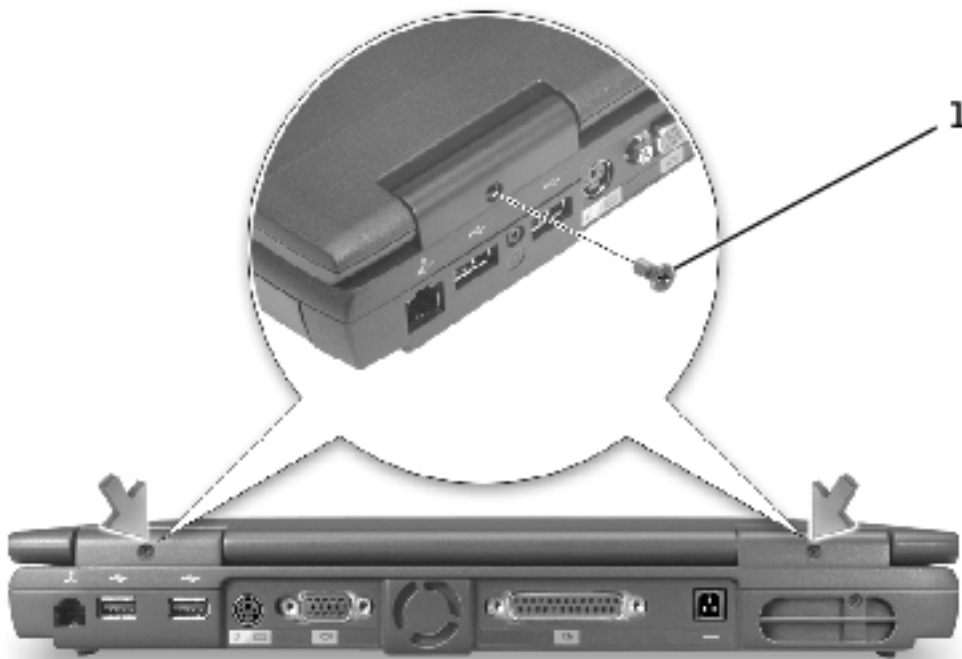

<b>1</b>	<b>M2.5 x 5-mm screws (2)</b>
----------	-------------------------------

- b. Open the display assembly at an angle of approximately 180 degrees and support the display assembly so that it does not open past this position.
- c. Use a small flat-blade screwdriver or plastic scribe to lift the scalloped right edge of the center control cover and pry the cover loose from the hinges and bottom case.
- d. Lift the center control cover up and away from the hinges and bottom case.

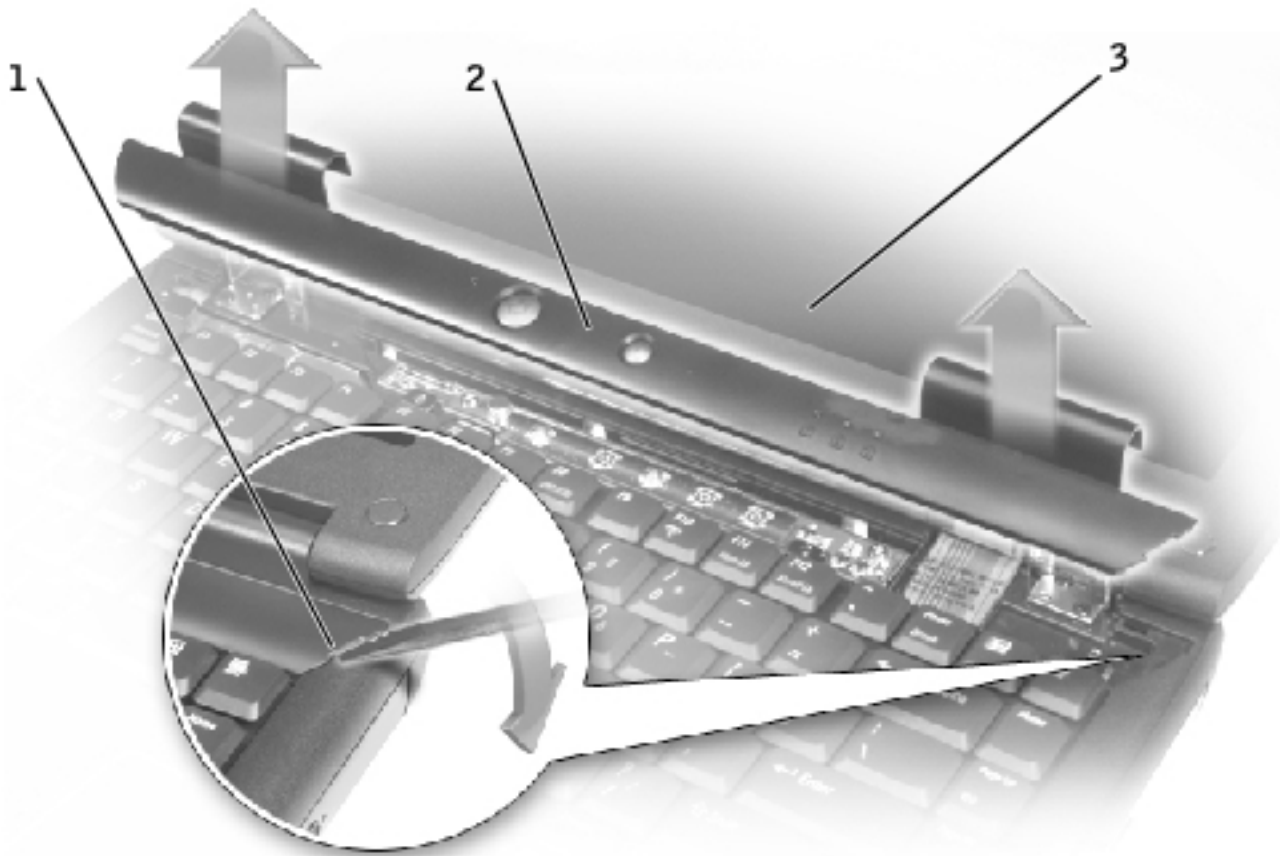

<b>1</b>	<b>scalloped edge of center control cover</b>
----------	---

<b>2</b>	<b>center control cover</b>
----------	-----------------------------

<b>3</b>	<b>display assembly</b>
----------	-------------------------



 **NOTE:** The M2.5 x 4 screws are silver.

2. Remove the four M2.5 x 4-mm screws across the top of the keyboard.

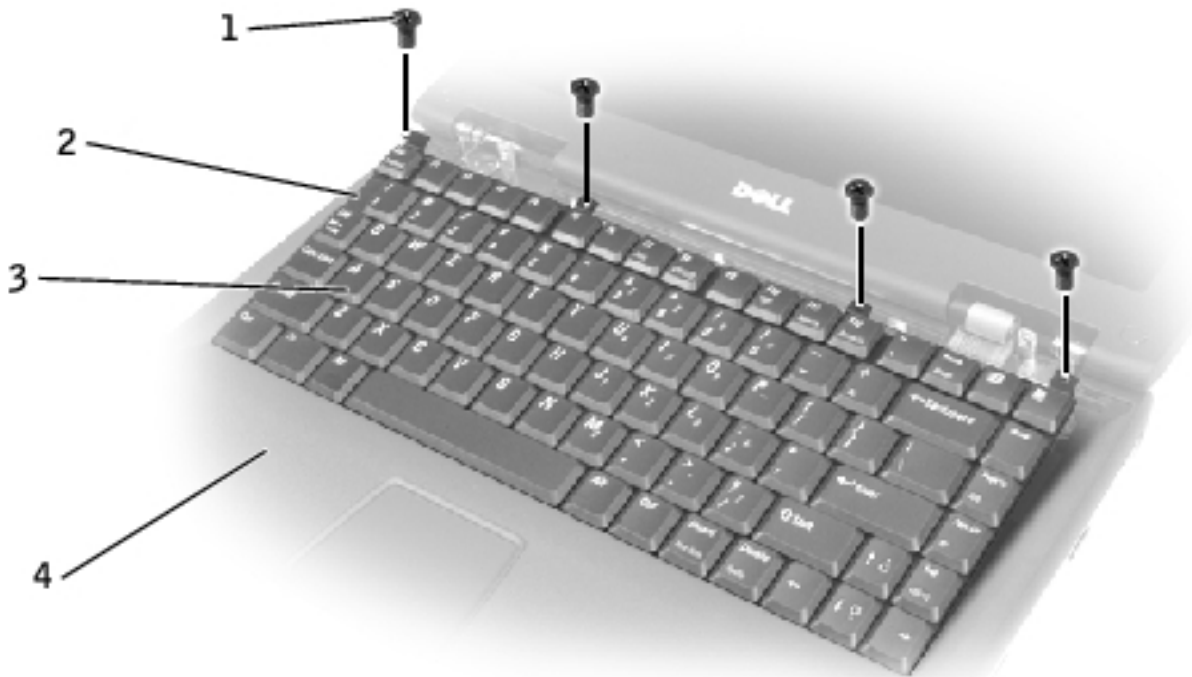

1	M2.5 x 4-mm screws (4)
2	scalloped edge of blank key
3	keyboard
4	palm rest

 **NOTICE:** The keycaps on the keyboard are fragile, easily dislodged, and time-consuming to replace. Be careful when removing and handling the keyboard.

3. Lift the keyboard straight up until it clears the top of the bottom case.
4. Rotate the keyboard forward toward the front of the computer.
5. Rest the key face of the keyboard on the palm rest.

**→ NOTICE:** Do not pull on the keyboard flex cable.

6. Pull up on the keyboard connector to disconnect it from the interface connector on the system board.

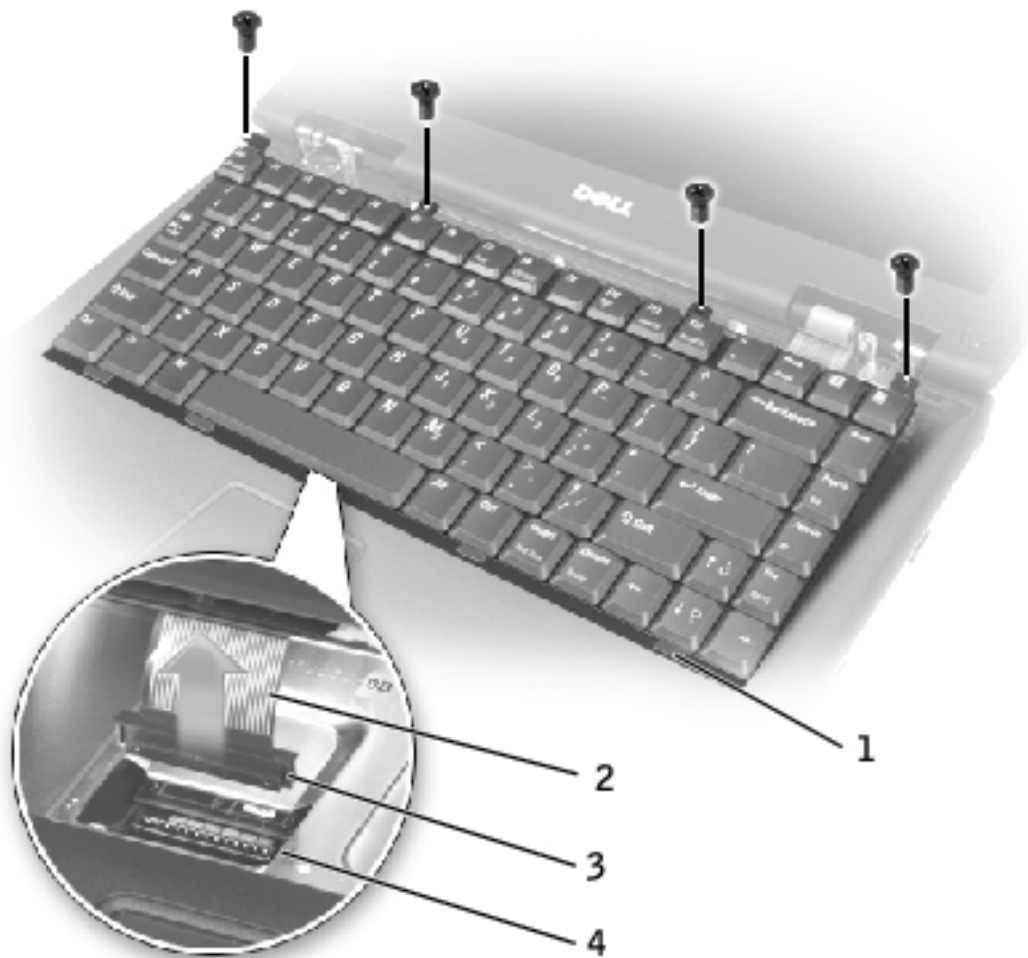

1	keyboard securing tabs (4)
2	keyboard flex cable
3	keyboard connector
4	interface connector on system board

7. Remove the keyboard from the bottom case.

# Replacing the Keyboard

➔ **NOTICE:** The keycaps on the keyboard are fragile, easily dislodged, and time-consuming to replace. Be careful when handling and replacing the keyboard.

1. Place the keyboard on the palm rest at the front of the computer with the keys face down and the connector toward the back of the computer.

➔ **NOTICE:** To avoid damage to the connector pins, press the keyboard connector evenly into the interface connector on the system board, and do not reverse the keyboard connector.

2. Connect the keyboard connector to the interface connector on the system board.

The keyboard connector may have a label on it that shows the correct orientation of the keyboard connector to the interface connector on the system board.

➔ **NOTICE:** Position the keyboard flex cable so that it is not pinched when you replace the keyboard in the bottom case.

3. Rotate the keyboard back and fit it into the bottom case.

Ensure that all four securing tabs are engaged in their respective slots before trying to completely seat the keyboard. Fitting the tabs to the slots may be easiest when viewed from above and slightly behind the front edge of the

keyboard. Press down on the left and right  keys to help control tab/slot alignment.

When the keyboard appears to be completely seated, confirm that the front edge of the keyboard is aligned with the edge of the palm rest before proceeding.

4. Check that the keyboard is correctly installed. The keys should be flush with the left and right surfaces of the palm rest.

 **NOTE:** The M2.5 x 4 screws are silver.

5. Replace the four M2.5 x 4-mm screws at the top of the keyboard.
6. Replace the center control cover.

Ensure that the center control cover is snapped in properly so that it is flush with the keyboard.

7. Replace the two M2.5 x 5-mm screws in the back of the hinges.
- 

[Back to Contents Page](#)

[Back to Contents Page](#)

# Display Assembly and Display Latch

## Dell™ Latitude™ V710/V740 Service Manual

- [Display Assembly](#)
  - [Display Latch](#)
- 

## Display Assembly

- ➔ **NOTICE:** You must remove the display assembly before you remove the palm rest.
- ➔ **NOTICE:** Disconnect the computer and any attached devices from electrical outlets, and remove any installed batteries.
- ➔ **NOTICE:** To avoid ESD, ground yourself by using a wrist grounding strap or by touching an unpainted metal surface on the computer.
- ➔ **NOTICE:** Read "[Preparing to Work Inside the Computer](#)" before performing the following procedure.

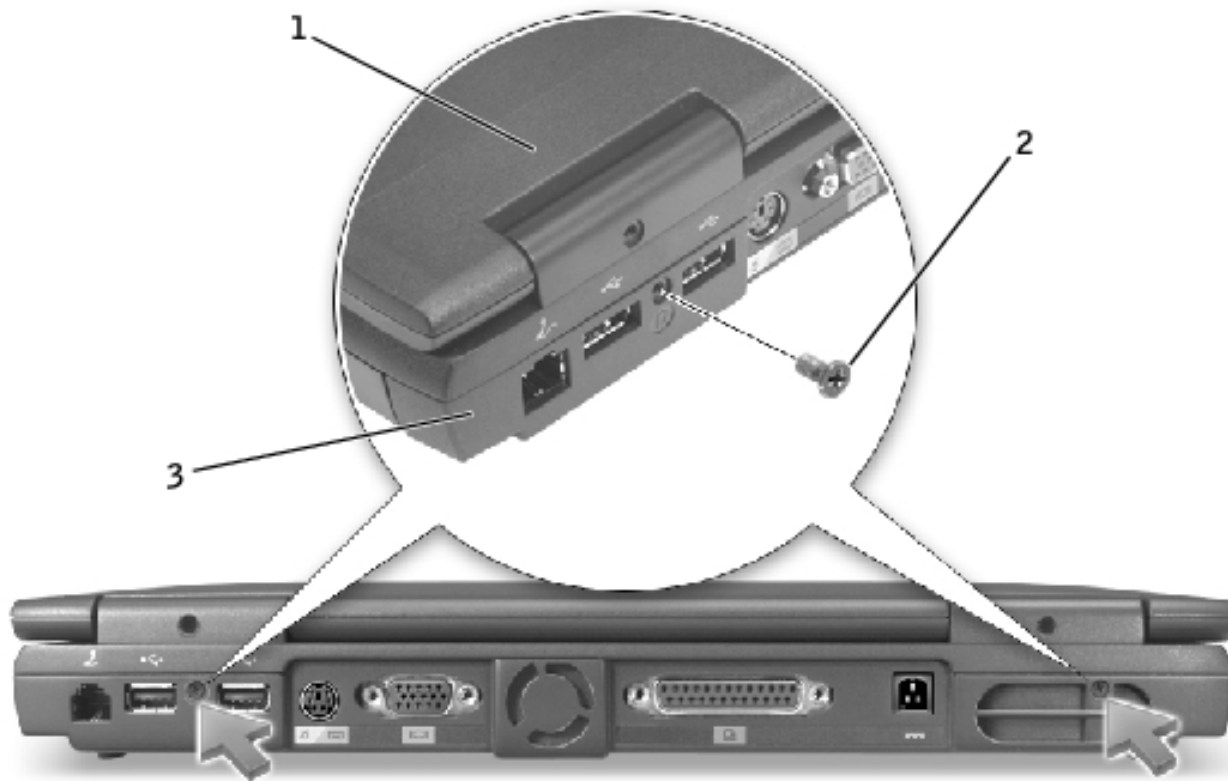

1	top cover
2	M2.5 x 5-mm screws (2)
3	bottom case

1. Remove the [keyboard](#).
2. Close the display assembly.
3. From the back of the computer, remove the two M2.5 x 5-mm screws labeled "circle D."
4. Open the display assembly approximately 180 degrees and support the display assembly so that it does not open past this position.
5. Remove the two M2.5 x 5-mm screws that secure the display-feed flex cable to the system board.

➔ **NOTICE:** When reconnecting the display-feed flex cable connector to the system board, push down on the top left and right ends of the connector. Pressing on the center of the connector may damage resistors and compromise EMI protection in the computer.

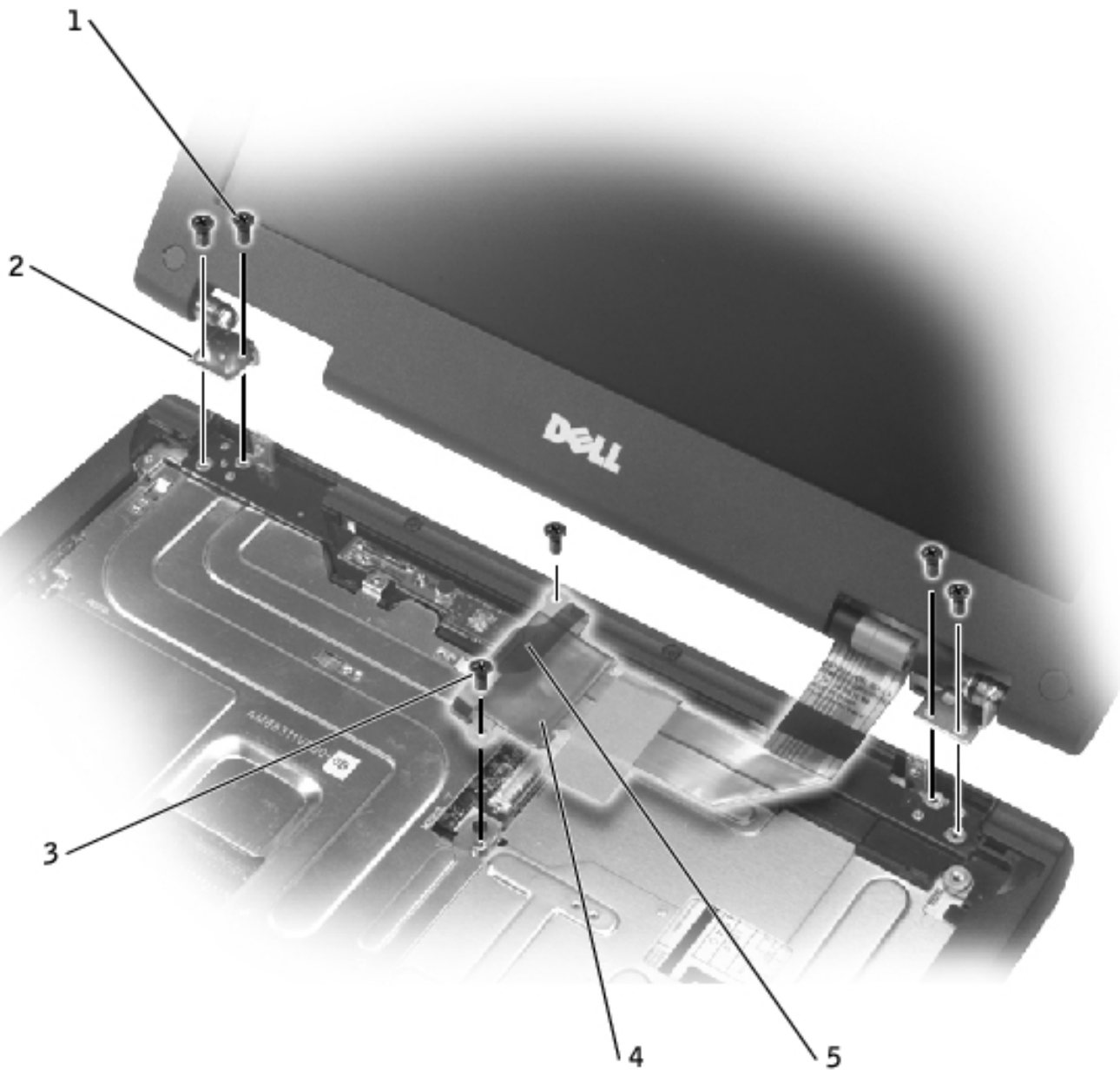

1	M2.5 x 5-mm screws (4)
2	hinge blocks (2)
3	M2.5 x 5-mm screws (2)
4	display-feed flex cable
5	pull tab

6. Pull up on the pull tab that is attached to the display-feed flex cable connector to remove the connector from the system board.

7. Remove the two M2.5 x 5-mm screws from each hinge block.

8. Lift the display assembly up and out of the bottom case.

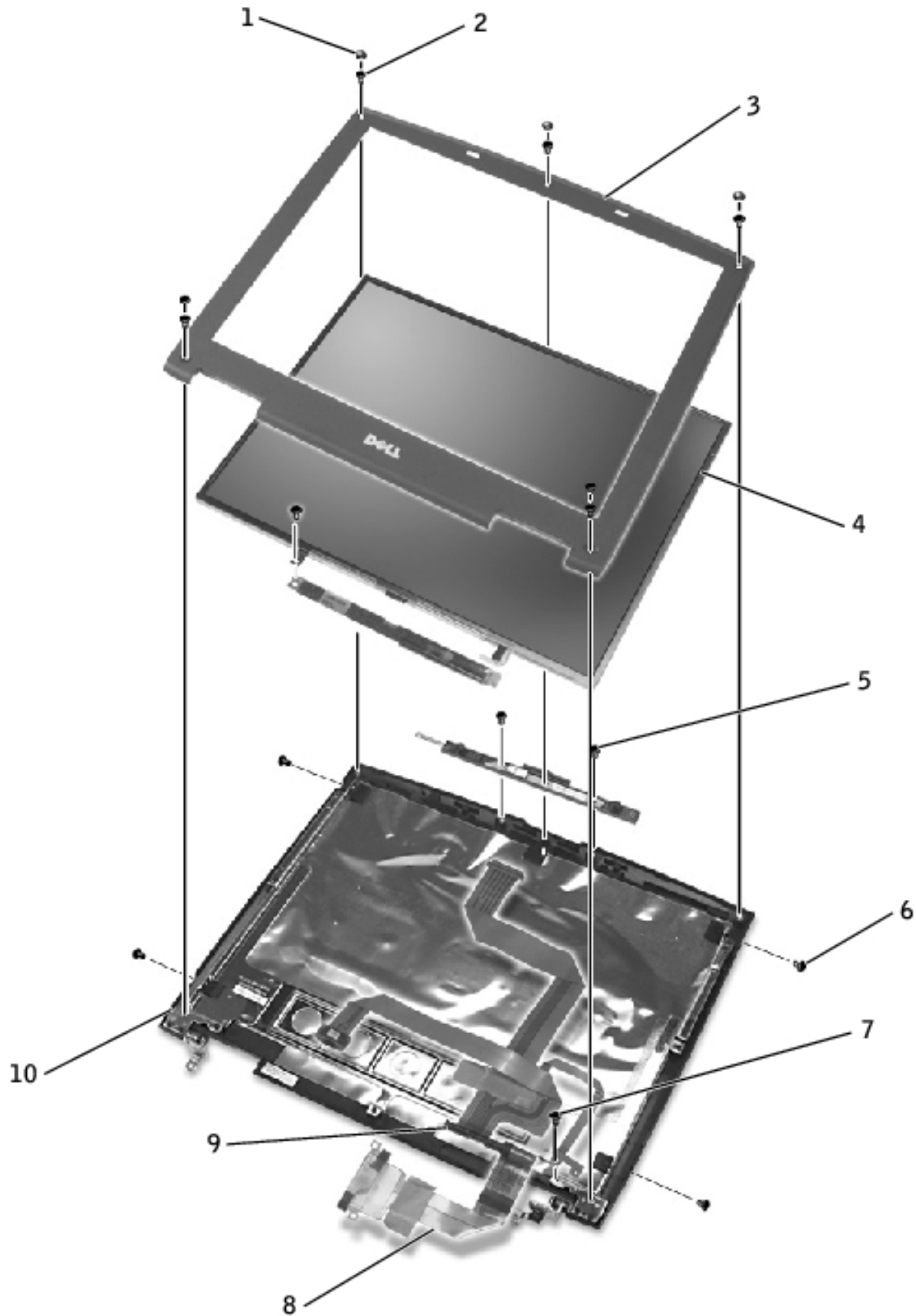



1	screw covers (5)	6	M2 x 3-mm screws (4)
2	M2.5 x 5-mm screws (5)	7	M2.5 x 5-mm screw (1)
3	display bezel	8	display-feed flex cable
4	display panel	9	flex-cable retention bracket
5	M2.5 x 5-mm screws (2)	10	top cover

## Removing the Display Bezel

- ➡ **NOTICE:** Disconnect the computer and any attached devices from electrical outlets, and remove any installed batteries.
- ➡ **NOTICE:** To avoid ESD, ground yourself by using a wrist grounding strap or by touching an unpainted metal surface on the computer.
- ➡ **NOTICE:** Read "[Preparing to Work Inside the Computer](#)" before performing the following procedure.

1. Remove the [keyboard](#).
2. Remove the [display assembly](#).
3. Use a plastic scribe to pry the five screw covers out of the screw holes located on the front of the bezel.
4. Remove the five M2.5 x 5-mm screws located on the front of the bezel.

- ➡ **NOTICE:** Carefully separate the bezel from the top cover to avoid damage to the bezel.

5. Starting at the bottom of the display panel (by the Dell™ logo), use your fingers to separate the bezel from the top cover by lifting the inside of the bezel while pushing in on the outside.

## Removing the Display Panel

- ➡ **NOTICE:** Disconnect the computer and any attached devices from electrical outlets, and remove any installed batteries.

- ➔ **NOTICE:** To avoid ESD, ground yourself by using a wrist grounding strap or by touching an unpainted metal surface on the computer.
  - ➔ **NOTICE:** Read "[Preparing to Work Inside the Computer](#)" before performing the following procedure.
1. Remove the [keyboard](#).
  2. Remove the [display assembly](#).
  3. Remove the [display bezel](#).
  4. Remove the two M2 x 3-mm screws on the left side of the display panel.
  5. Remove the two M2 x 3-mm screws on the right side of the display panel.
  6. Remove the M2.5 x 5-mm screw that secures the display-feed flex cable to the display assembly.
  7. Unsnap the flex-cable retention bracket from the top cover, and lift the bracket out of the display assembly.

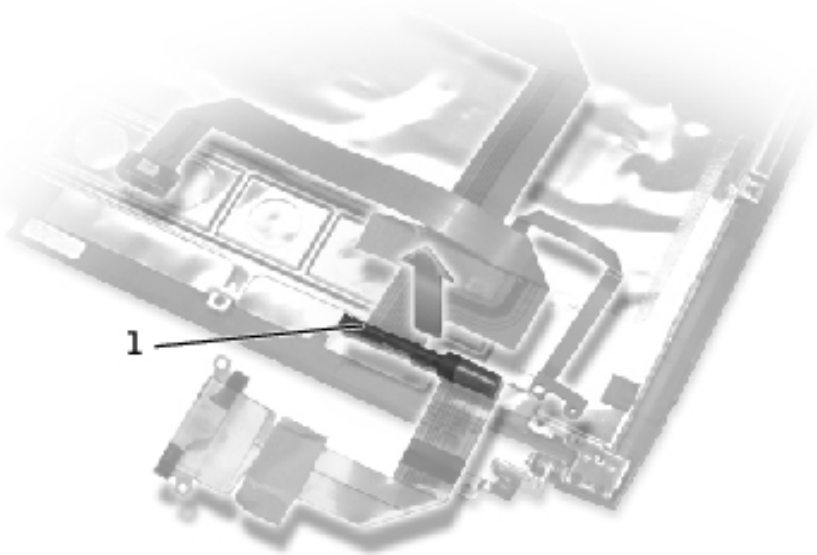

1	flex-cable retention bracket
---	------------------------------

8. Lift the display panel from the top, and rotate the display panel out of the top cover.

9. Disconnect the bottom flex cable connector from the inverter connector on the system board by pulling on the attached pull tab away from the inverter connector.

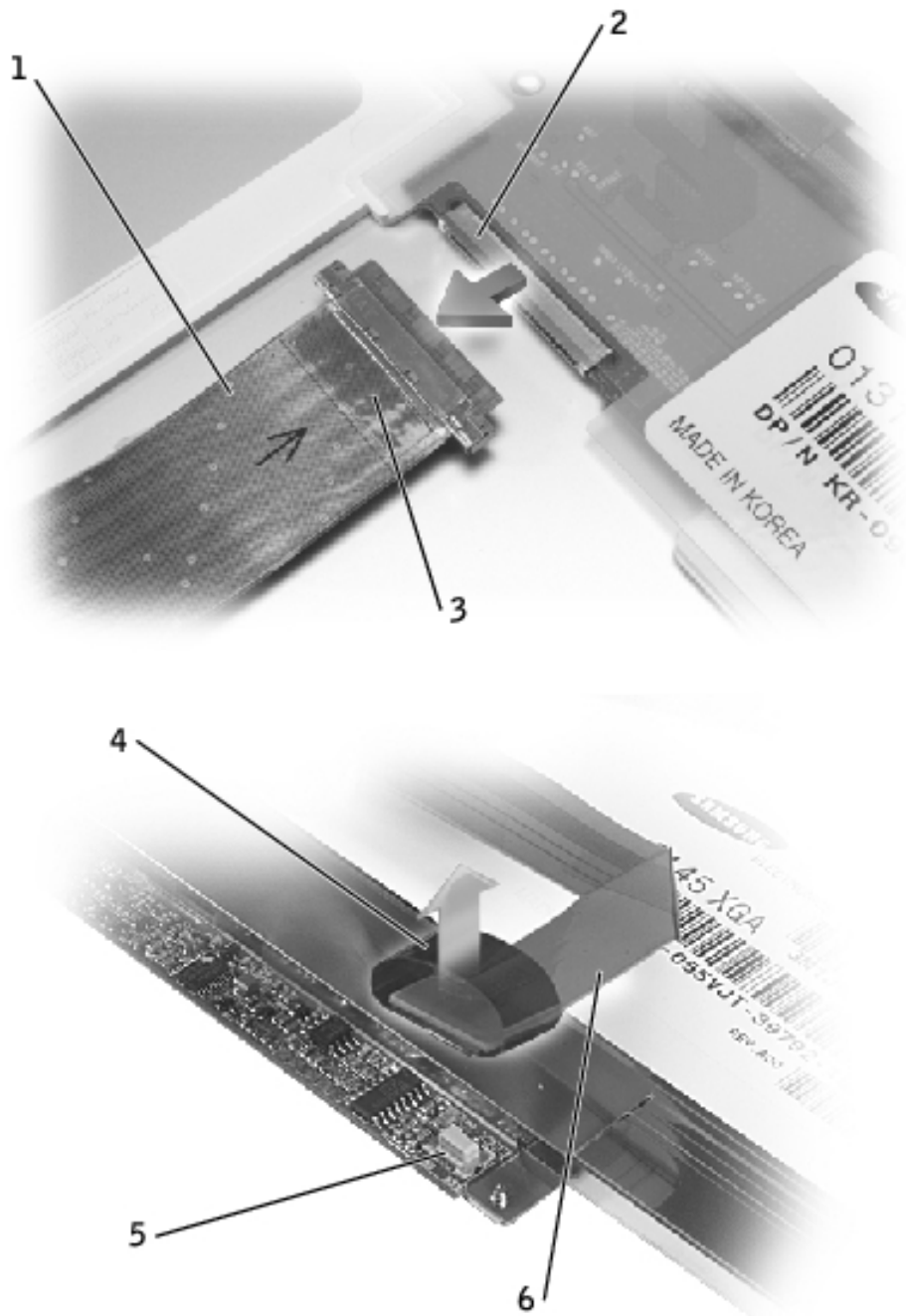

1	top flex cable connector
2	display panel connector
3	pull tab
4	pull tab
5	inverter connector on system board

6	bottom flex cable connector
---	-----------------------------

10. Remove the tape that secures the display panel connector and the tape that secures the middle of the display-feed flex cable to the display panel.
11. Pull the top flex cable connector down and away to remove it from the display panel connector.

## Replacing the Display Panel

1. Reconnect the top flex cable connector to the display panel connector.
2. Reconnect the bottom flex cable connector to the inverter connector on the system board.
3. Replace the tape that secures the display panel connector and the tape that secures the middle of the display-feed flex cable to the display panel.
4. Place the bottom edge of the display panel in the bottom of the top cover and elevate the top of the panel with your hand.
5. Lay the display panel in the top cover.
6. Reinstall the four M2 x 3-mm screws that secure the display panel to the top cover.
7. Reinstall the M2.5 x 5-mm screw that secures the display-feed flex cable to the display assembly.

---

## Display Latch

- ➡ **NOTICE:** Disconnect the computer and any attached devices from electrical outlets, and remove any installed batteries.
- ➡ **NOTICE:** To avoid ESD, ground yourself by using a wrist grounding strap or by touching an unpainted metal surface on the computer.

## Removing the Display Latch

1. Remove the [keyboard](#).
2. Remove the [display assembly](#).

3. Remove the [display bezel](#).
4. Remove the two M2.5 x 5-mm screws that secure the display latch and bracket to the top cover.
5. Lift the display latch, bracket, and spring up and out of the top cover.

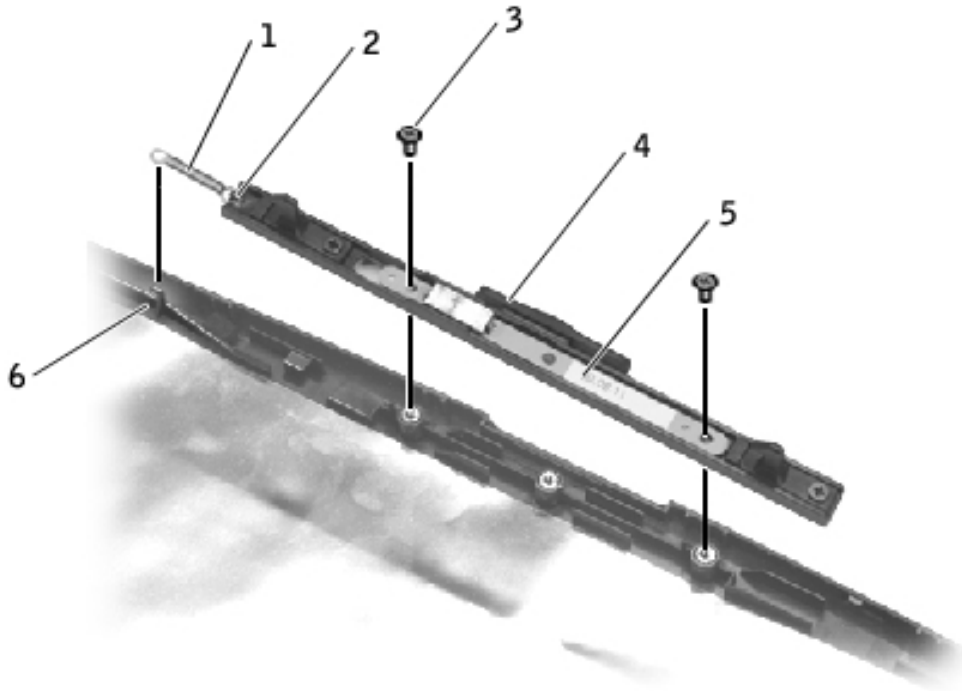

1	spring
2	spring hook (display latch)
3	M2.5 x 5-mm screws (2)
4	display latch
5	bracket
6	spring hook (top cover)

## Replacing the Display Latch

1. Attach one end of the spring to the spring hook on the left edge of the display latch, and attach the other end of the spring to the spring hook in the top cover.
2. Place the display latch on top of its screw holes, and then place the bracket on top of the display latch, aligning the bracket and display latch screw holes.

- 3. Replace the two M2.5 x 5-mm screws that secure the display latch and bracket to the top cover.**
- 

[Back to Contents Page](#)

[Back to Contents Page](#)

# EMI Shield, Video Board, and Palm Rest

## Dell™ Latitude™ V710/V740 Service Manual

- [EMI Shield](#)
  - [Video Board](#)
  - [Palm Rest](#)
- 

## EMI Shield

- ➔ **NOTICE:** Disconnect the computer and any attached devices from electrical outlets, and remove any installed batteries.
  - ➔ **NOTICE:** To avoid ESD, ground yourself by using a wrist grounding strap or by touching an unpainted metal surface on the computer.
  - ➔ **NOTICE:** Read "[Preparing to Work Inside the Computer](#)" before performing the following procedure.
1. Remove the [keyboard](#).
  2. Remove the two M2.5 x 5-mm screws that secure the display-feed flex cable to the system board.
- ➔ **NOTICE:** When reconnecting the display-feed flex cable connector to the system board, push down on the top left and right ends of the connector. Pressing on the center of the connector may damage resistors and compromise EMI protection in the computer.
3. Pull up on the pull tab that is attached to the display-feed flex cable connector to remove the connector from the system board.
  4. Remove the three M2.5 x 12-mm screws that secure the EMI shield to the bottom case, and pull the EMI shield out of the bottom case.

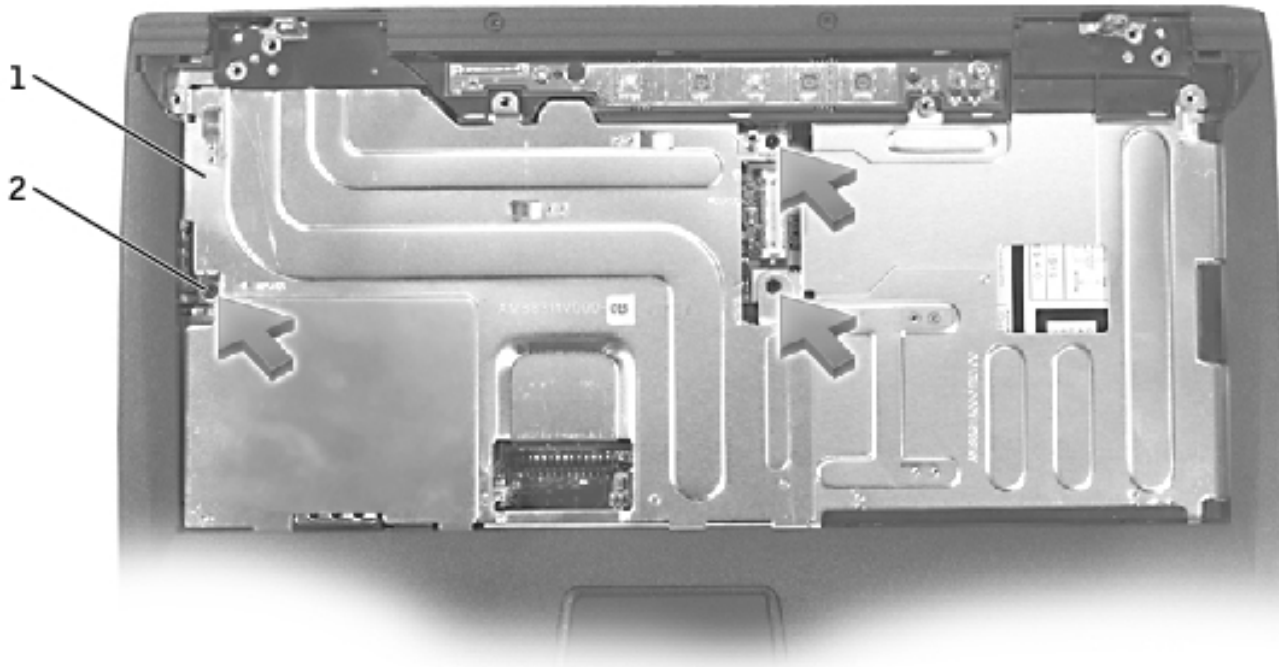

1	EMI shield
2	M2.5 x 12-mm screws (3)

## Video Board

### Removing the Video Board

- ➔ **NOTICE:** Disconnect the computer and any attached devices from electrical outlets, and remove any installed batteries.
- ➔ **NOTICE:** To avoid ESD, ground yourself by using a wrist grounding strap or by touching an unpainted metal surface on the computer.
- ➔ **NOTICE:** Read "[Preparing to Work Inside the Computer](#)" before performing the following procedure.

1. Remove the [keyboard](#).
2. Remove the [EMI Shield](#).
3. Remove the screw that secures the video board to the system board:



- For V710, the screw is M2.5 x 5 mm.
- For V740, the screw is M2.5 x 8mm.

4. Pull the video board out of the bottom case:

- For V710, pull the video board by the edges toward the front of the computer.
- For V740, pull the video board by the pull tab toward the front of the computer.

## V710 Video Board

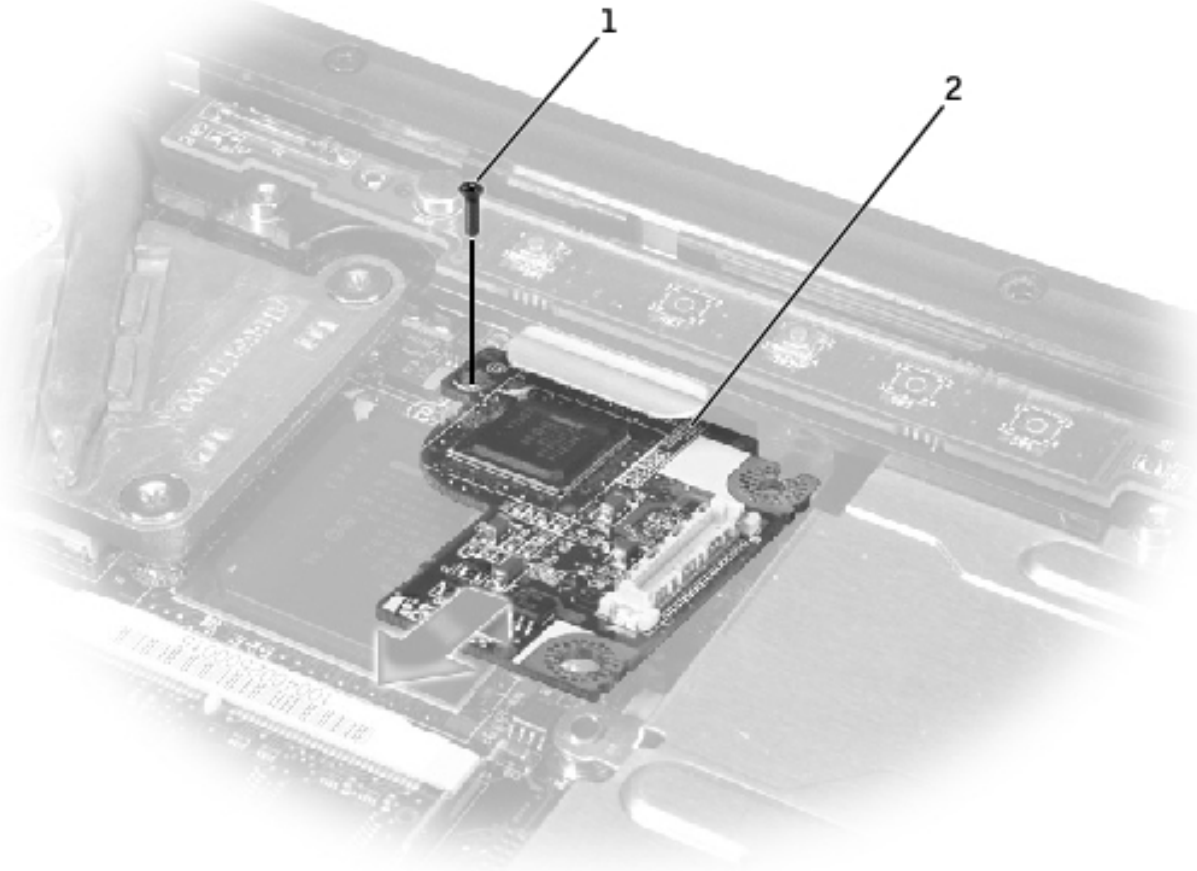

1	M2.5 x 5-mm screw (1)
2	V710 video board

## V740 Video Board

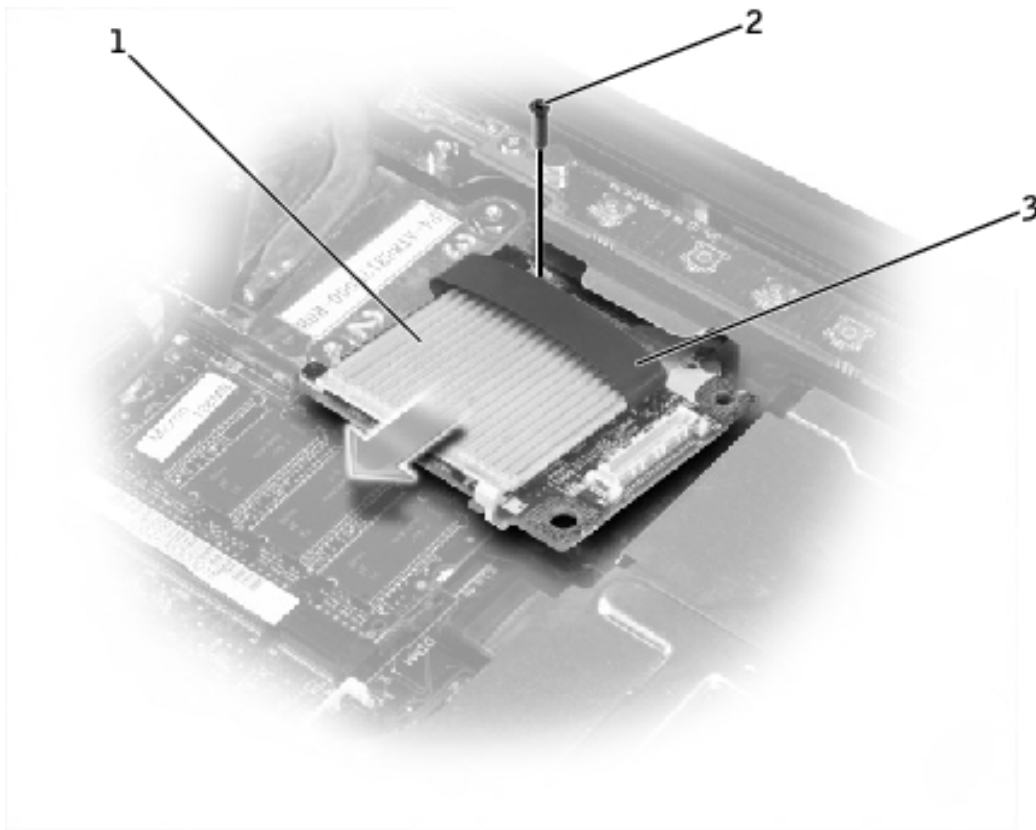

1	V740 video board
2	M2.5 x 8-mm screw (1)
3	pull tab

## Replacing the Video Board

1. Align the top right corner of the video board with the guide on the system board, and slide the top edge of the video board under the palm rest.

### V710 Video Board

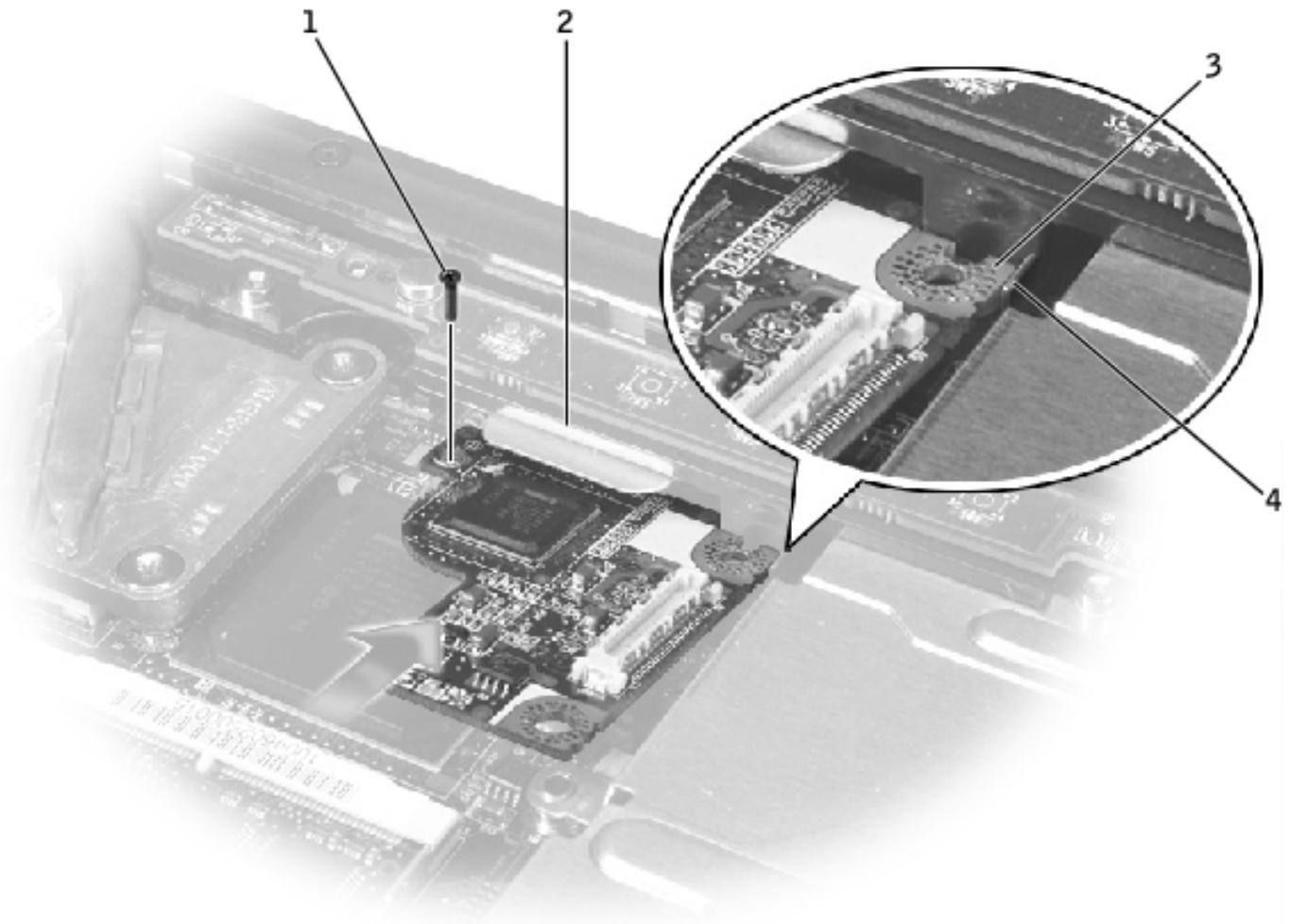

1	M2.5 x 5-mm screw (1)
2	palm rest
3	top right corner of the V710 video board
4	guide

## V740 Video Board

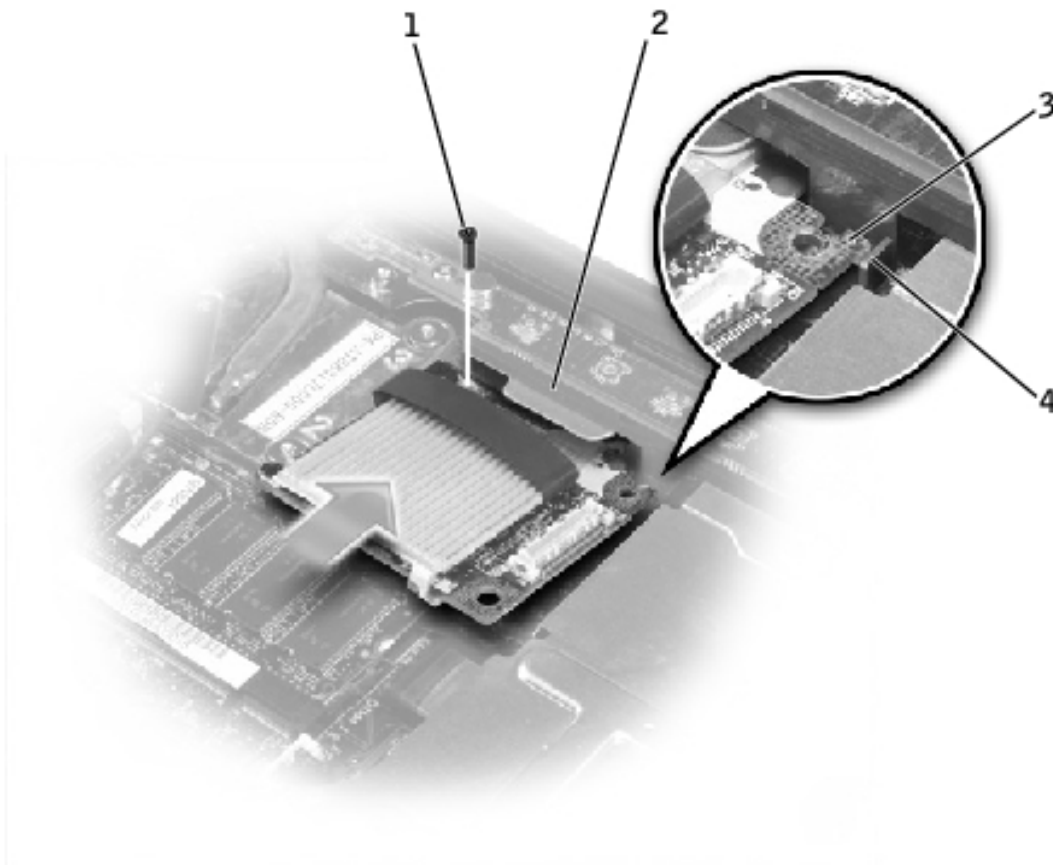

1	M2.5 x 8-mm screw (1)
2	palm rest
3	top right corner of the V740 video board
4	guide

**NOTICE:** For V740 only, before you connect the video board to the system board, ensure that you route the power-board flex cable under the memory module.

2. Lay the video board flat on the system board, and connect the video board connector to the interface connector on the system board.

## V710 Video Board Connector

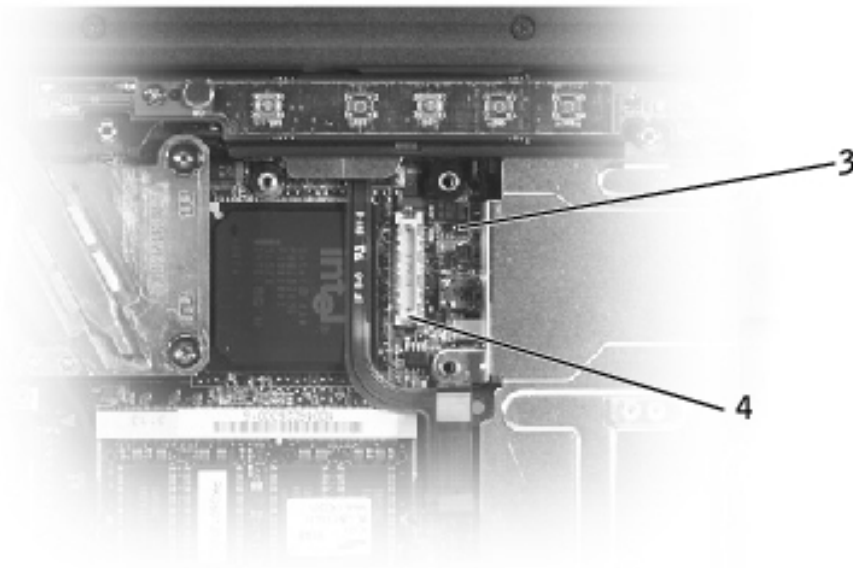
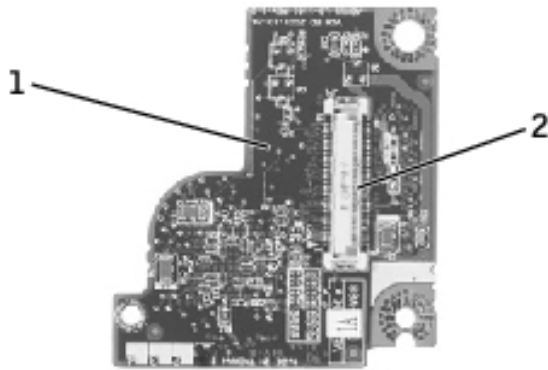

1	bottom of V710 video board
2	video board connector
3	system board
4	interface connector

➡ **NOTICE:** For V740 only, before you connect the video board to the system board, ensure that you route the power-board flex cable under the memory module.

## V740 Video Board Connector

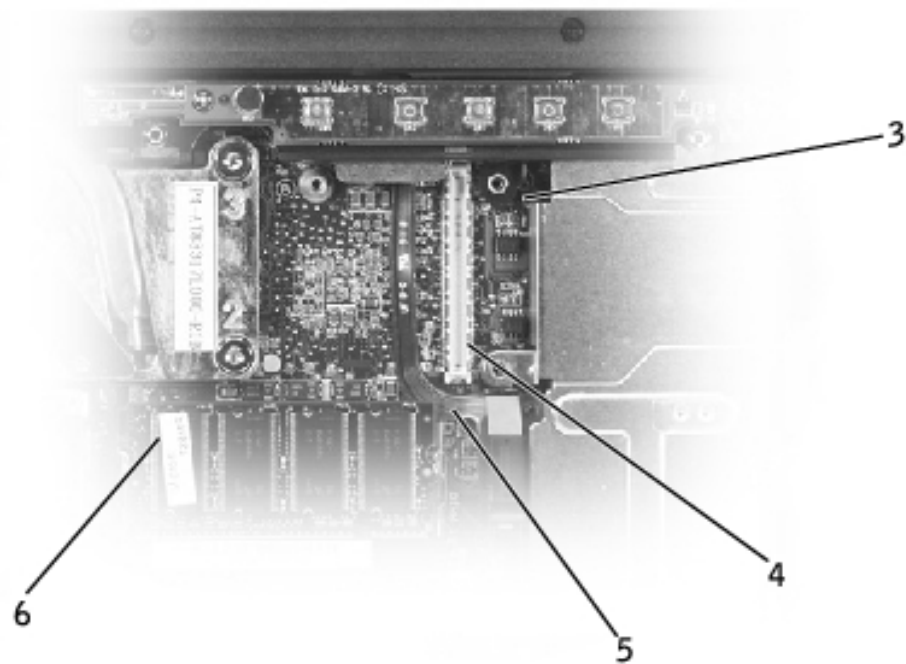
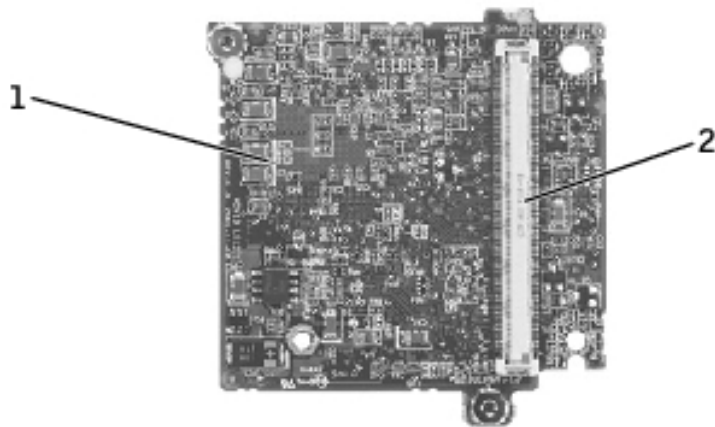

1	bottom of V740 video board
2	video board connector
3	system board
4	interface connector
5	power-board flex cable
6	memory module

3. Reinstall the screw that secures the video board to the bottom case:

- For V710, reinstall the M2.5 x 5-mm screw.
- For V740, reinstall the M2.5 x 8-mm screw.

4. Replace the [EMI Shield](#).

5. Replace the [keyboard](#).
- 

## Palm Rest

- ➔ **NOTICE:** Disconnect the computer and any attached devices from electrical outlets, and remove any installed batteries.
- ➔ **NOTICE:** To avoid ESD, ground yourself by using a wrist grounding strap or by touching an unpainted metal surface on the computer.
- ➔ **NOTICE:** Read "[Preparing to Work Inside the Computer](#)" before performing the following procedure.

1. Remove the [keyboard](#).

- ➔ **NOTICE:** You must remove the display assembly before you remove the palm rest; the display hinges pass through the back of the palm rest.

2. Remove the [display assembly](#).
3. Remove the [EMI Shield](#).
4. Remove the [video board](#).
5. Remove the two M2.5 x 5-mm screws from the top of the palm rest.

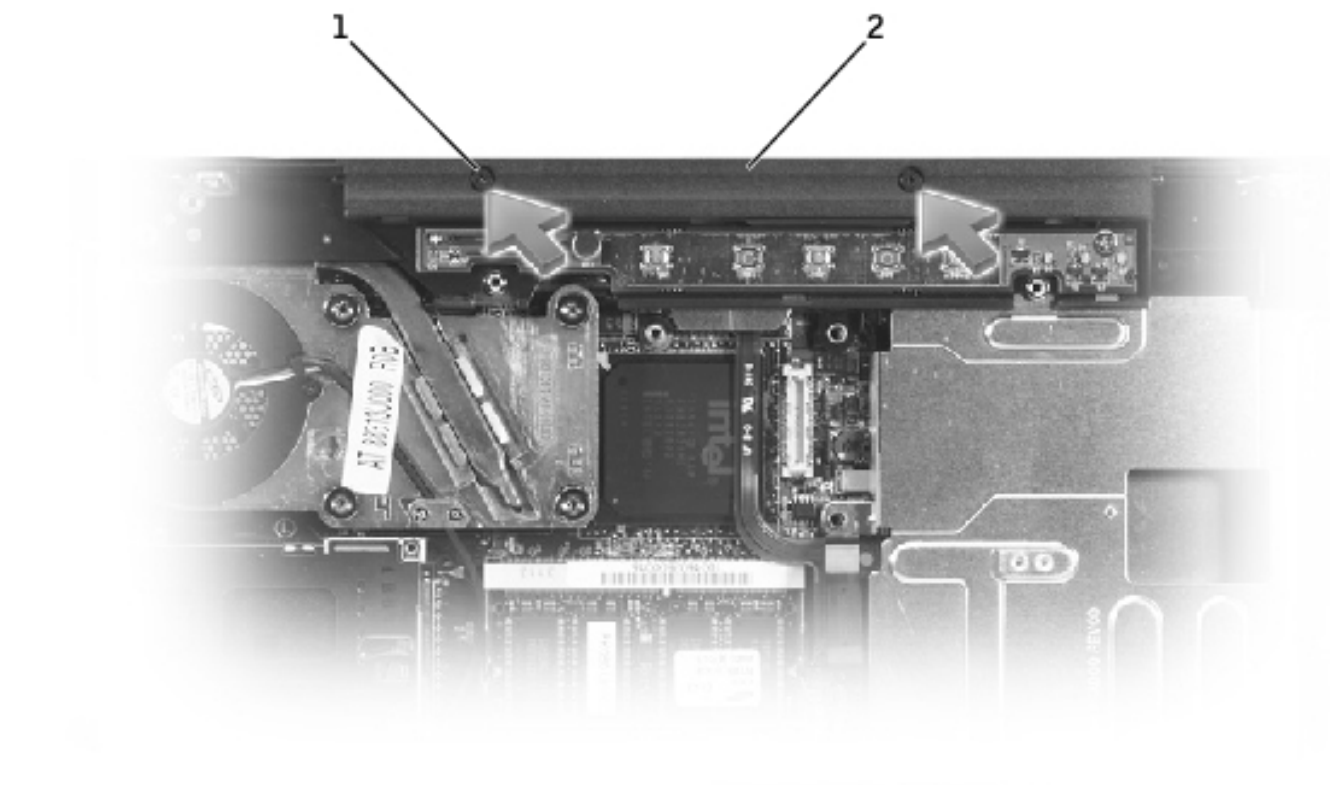

1	M2.5 x 5-mm screws (2)
2	top of the palm rest

6. Turn the computer over and remove the twelve M2.5 x 8-mm screws labeled "circle P."



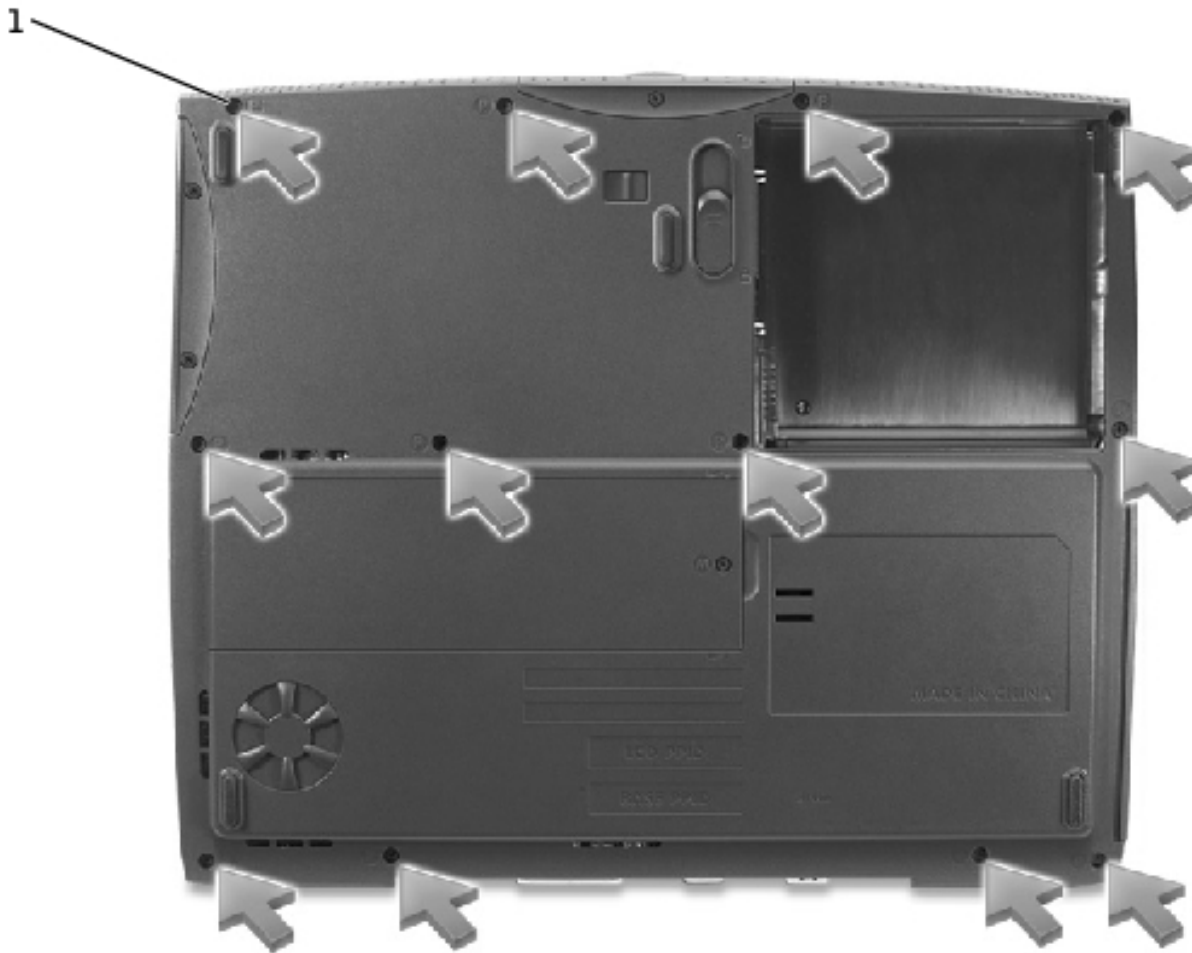

1	M2.5 x 8-mm screws (12)
---	----------------------------

7. Turn the computer over, and disconnect the touch pad connector and power board connector from the system board.

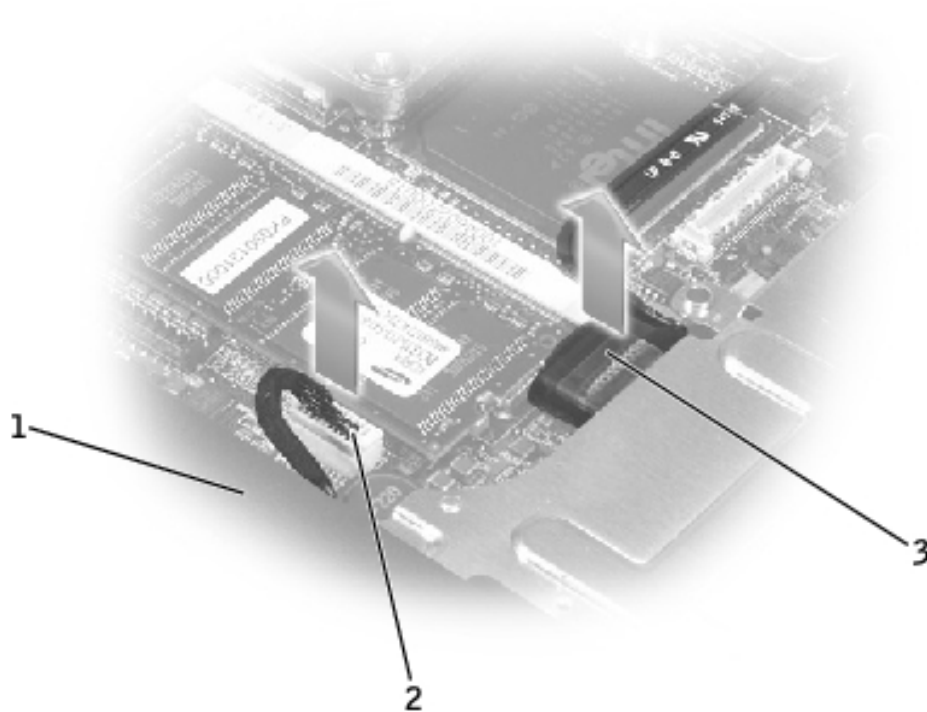

1	back center of the palm rest
2	touch pad connector
3	power board connector

➡ **NOTICE:** Carefully separate the palm rest from the bottom case to avoid damage to the palm rest.

8. Starting at the back center of the palm rest, use your fingers to separate the palm rest from the bottom case by lifting the inside of the palm rest while pushing in on the outside.

---



[Back to Contents Page](#)

[Back to Contents Page](#)

# Microprocessor Thermal-Cooling Assembly

Dell™ Latitude™ V710/V740 Service Manual

## Removing the Microprocessor Thermal-Cooling Assembly

-  **NOTICE:** Disconnect the computer and any attached devices from electrical outlets, and remove any installed batteries.
-  **NOTICE:** To avoid ESD, ground yourself by using a wrist grounding strap or by touching an unpainted metal surface on the computer.
-  **NOTICE:** Read "[Preparing to Work Inside the Computer](#)" before performing the following procedure.

1. Remove the [keyboard](#).
2. Remove the [EMI Shield](#).

 **NOTE:** You can remove the microprocessor thermal-cooling assembly with the fan attached.

3. Disconnect the fan power cable from the system board.
4. Loosen in consecutive order the four captive screws, labeled 1 through 4, that secure the microprocessor thermal-cooling assembly to the system board.

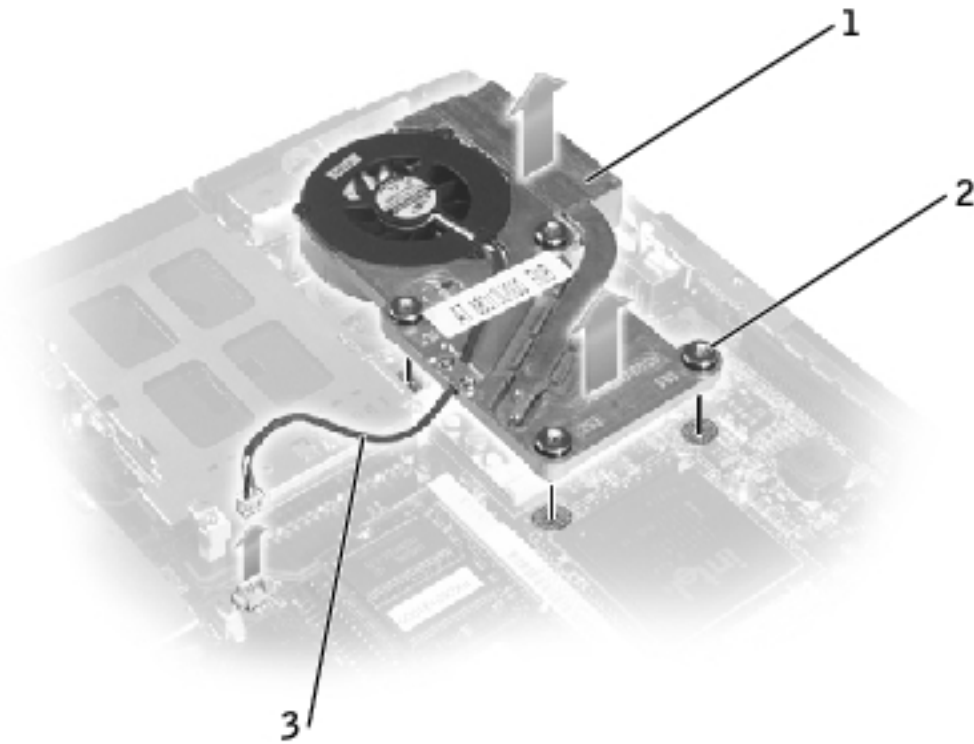

1	microprocessor thermal-cooling assembly
2	captive screws (4)
3	fan power cable

5. Lift the microprocessor thermal-cooling assembly up toward the front of the computer and out of the system board.

## Replacing the Microprocessor Thermal-Cooling Assembly

1. Place the back of the microprocessor thermal-cooling assembly under the palm rest and lower the assembly onto the system board.
2. Tighten the four captive screws, labeled 1 through 4, in consecutive order.

---

[Back to Contents Page](#)



[Back to Contents Page](#)

# Microprocessor Module

## Dell™ Latitude™ V710/V740 Service Manual

### Removing the Microprocessor Module

- ➔ **NOTICE:** Disconnect the computer and any attached devices from electrical outlets, and remove any installed batteries.
- ➔ **NOTICE:** To avoid ESD, ground yourself by using a wrist grounding strap or by touching an unpainted metal surface on the computer.
- ➔ **NOTICE:** Read "[Preparing to Work Inside the Computer](#)" before performing the following procedure.
- ➔ **NOTICE:** Do not touch the processor die. Press and hold the microprocessor down on the substrate on which the die is mounted while turning the cam screw to prevent intermittent contact between the cam screw and microprocessor.
- ➔ **NOTICE:** To avoid damage to the microprocessor, hold the screwdriver so that it is perpendicular to the microprocessor when turning the cam screw.

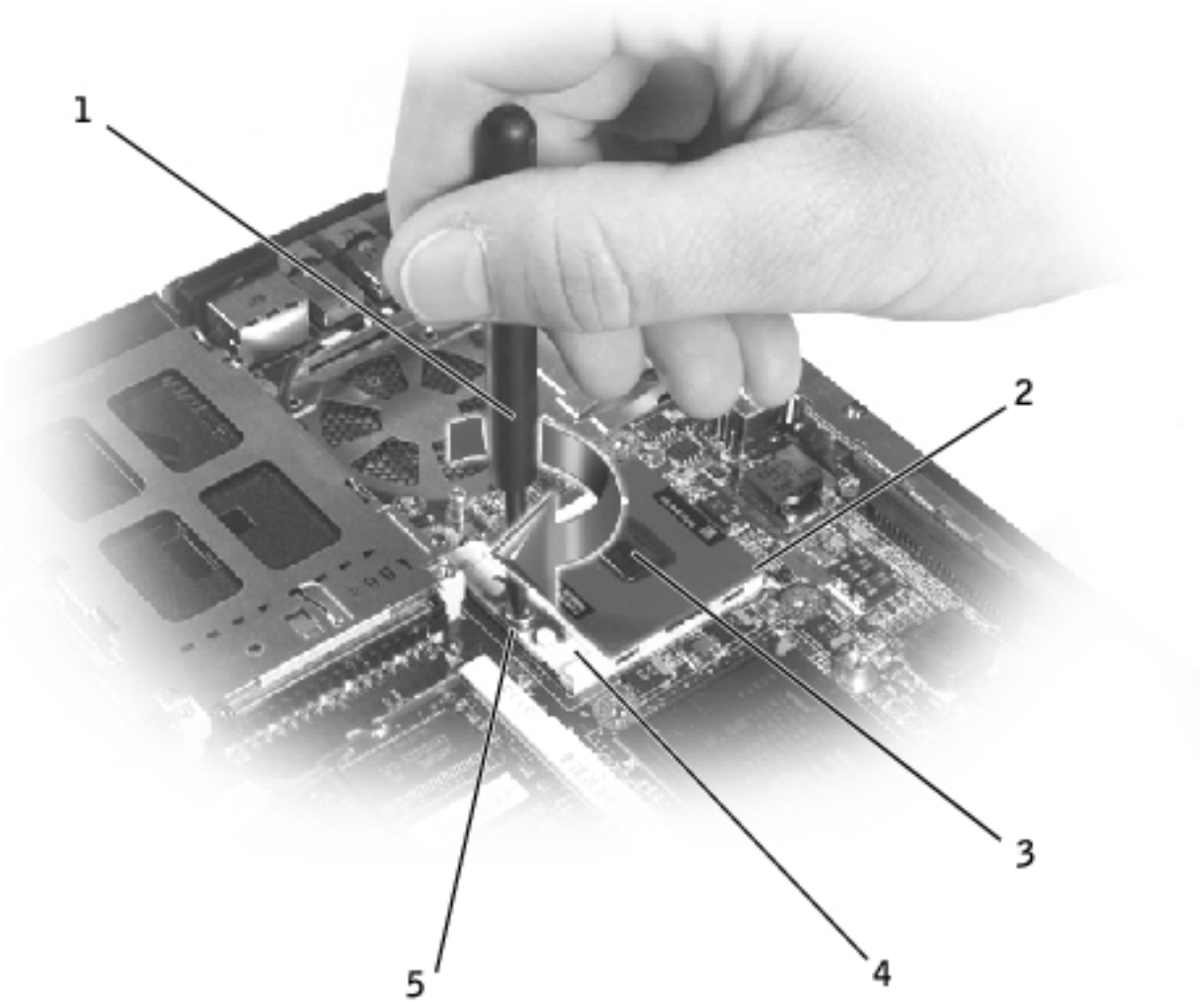

1	screwdriver (perpendicular to microprocessor)
2	pin-1 corner
3	processor die (do not touch)
4	ZIF socket
5	ZIF-socket cam screw

1. Remove the [keyboard](#).
2. Remove the [EMI Shield](#).

 **NOTICE:** To ensure maximum cooling for the microprocessor, do not touch the heat transfer areas on the microprocessor thermal-cooling assembly. The oils in your skin reduce the heat transfer capability of the thermal pads.

3. Remove the [microprocessor thermal-cooling assembly](#).

 **NOTICE:** When removing the microprocessor module, pull the module straight up. Be careful not to bend the pins on the microprocessor module.

4. To loosen the ZIF socket, use a small, flat-blade screwdriver and rotate the ZIF-socket cam screw counterclockwise until it comes to the cam stop.

The ZIF-socket cam screw secures the microprocessor to the system board. Take note of the arrow on the ZIF-socket cam screw.

5. Use a microprocessor extraction tool to remove the microprocessor module.

## Replacing the Microprocessor Module

 **NOTICE:** Ensure that the cam lock is in the fully open position before seating the microprocessor module. Seating the microprocessor module properly in the ZIF socket does not require force.

 **NOTICE:** A microprocessor module that is not properly seated can result in an intermittent connection, or permanent damage to the microprocessor and ZIF socket.

1. Align the pin-1 corner of the microprocessor module with the pin-1 corner of the ZIF socket, and insert the microprocessor module.

 **NOTE:** The pin-1 corner of the microprocessor module has a triangle that aligns with the triangle on the pin-1 corner of the ZIF socket.

 **NOTICE:** You must position the microprocessor module correctly in the ZIF socket to avoid permanent damage to the module and the socket.



When the microprocessor module is correctly seated, all four corners are aligned at the same height. If one or more corners of the module are higher than the others, the module is not seated correctly.

 **NOTICE:** Hold the microprocessor down while turning the cam screw to prevent intermittent contact between the cam screw and microprocessor.

2. Tighten the ZIF socket by turning the cam screw clockwise to secure the microprocessor module to the system board.
3. Update the BIOS using a flash BIOS update program floppy disk or CD. For instructions on how to flash the BIOS, see "[Flashing the BIOS](#)."

---

[Back to Contents Page](#)



[Back to Contents Page](#)

# Flashing the BIOS

## Dell™ Latitude™ V710/V740 Service Manual

1. Ensure that the AC adapter is plugged in and that the main battery is installed properly.
2. Turn on the computer.

Follow the instructions that appear on the screen. The computer continues to boot and updates the new BIOS. When the flash update is complete, the computer will automatically reboot.

3. Press  during POST to enter the system setup program.
4. Press  to reset the computer defaults.
5. Press  to save configuration changes and exit the system setup program.
6. Remove the flash BIOS update program floppy disk or CD from the drive and restart the computer.

---

[Back to Contents Page](#)

[Back to Contents Page](#)

# Speakers

## Dell™ Latitude™ V710/V740 Service Manual

### Removing the Speakers

- ➔ **NOTICE:** Disconnect the computer and any attached devices from electrical outlets, and remove any installed batteries.
- ➔ **NOTICE:** To avoid ESD, ground yourself by using a wrist grounding strap or by touching an unpainted metal surface on the computer.
- ➔ **NOTICE:** Read "[Preparing to Work Inside the Computer](#)" before performing the following procedure.

The speakers are located on the left and right corners of the front of the bottom case. Take note of the speaker cable routing so that you can replace the cables properly under or between their routing clips.

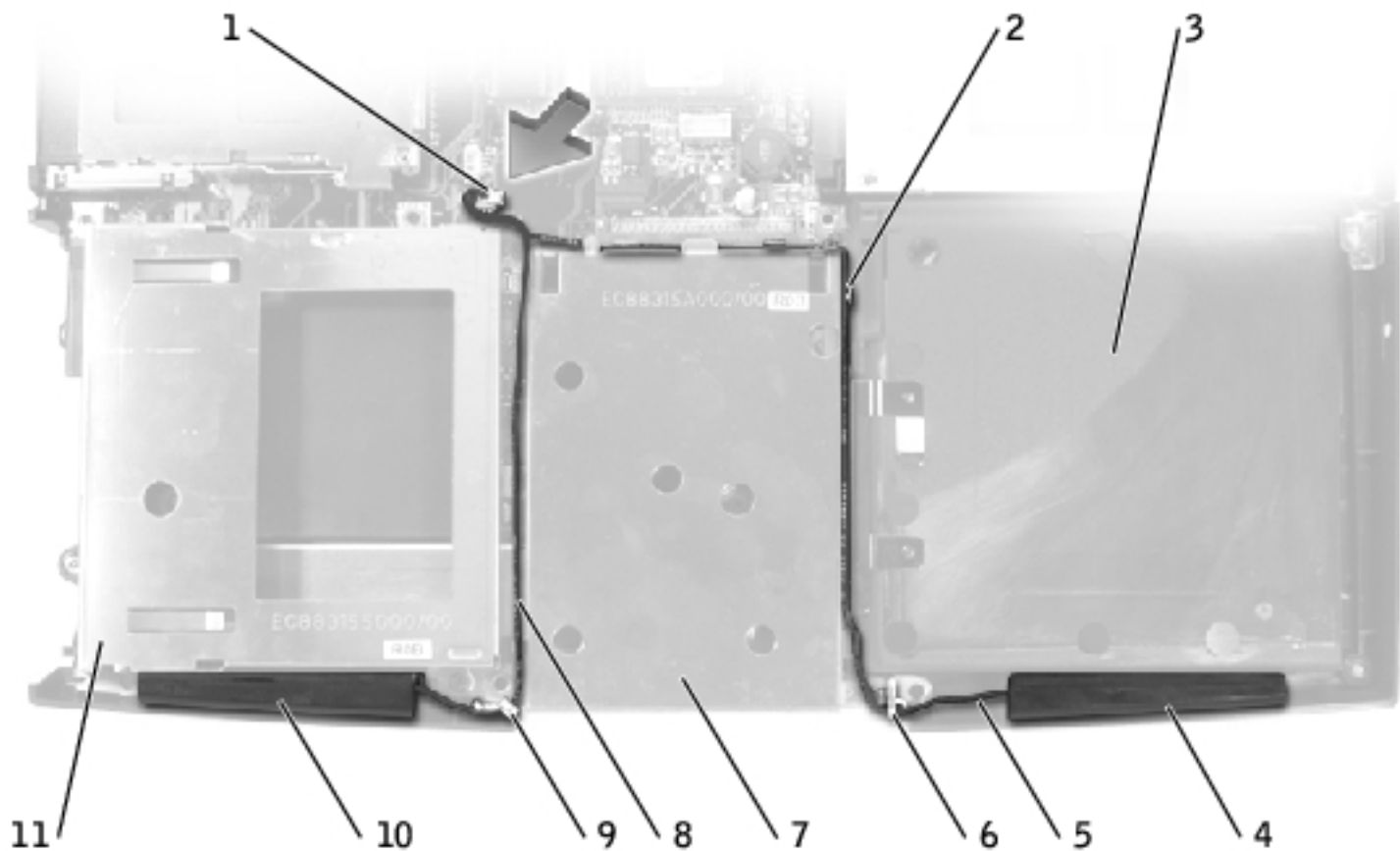

1	speaker connector	7	hard drive cage
2	routing clips (10)	8	left speaker cable
3	battery bay	9	left die casting
4	right speaker	10	left speaker
5	right speaker cable	11	floppy drive cage
6	right die casting		

1. Remove the [hard drive](#).
2. Remove the [floppy drive](#).
3. Remove the [keyboard](#).
4. Remove the [display assembly](#).
5. Remove the [EMI Shield](#).
6. Remove the [video board](#).

7. Remove the [palm rest](#).

8. Disconnect the speaker connector from the system board.

➡ **NOTICE:** Remove the speaker cables from their routing clips and die casting with care to avoid damaging the cables.

9. Remove the speaker cables from under or between their routing clips and die casting.

➡ **NOTICE:** Handle the speakers with care to avoid damaging them.

10. Remove the speakers by pulling them straight up and out of the bottom case.

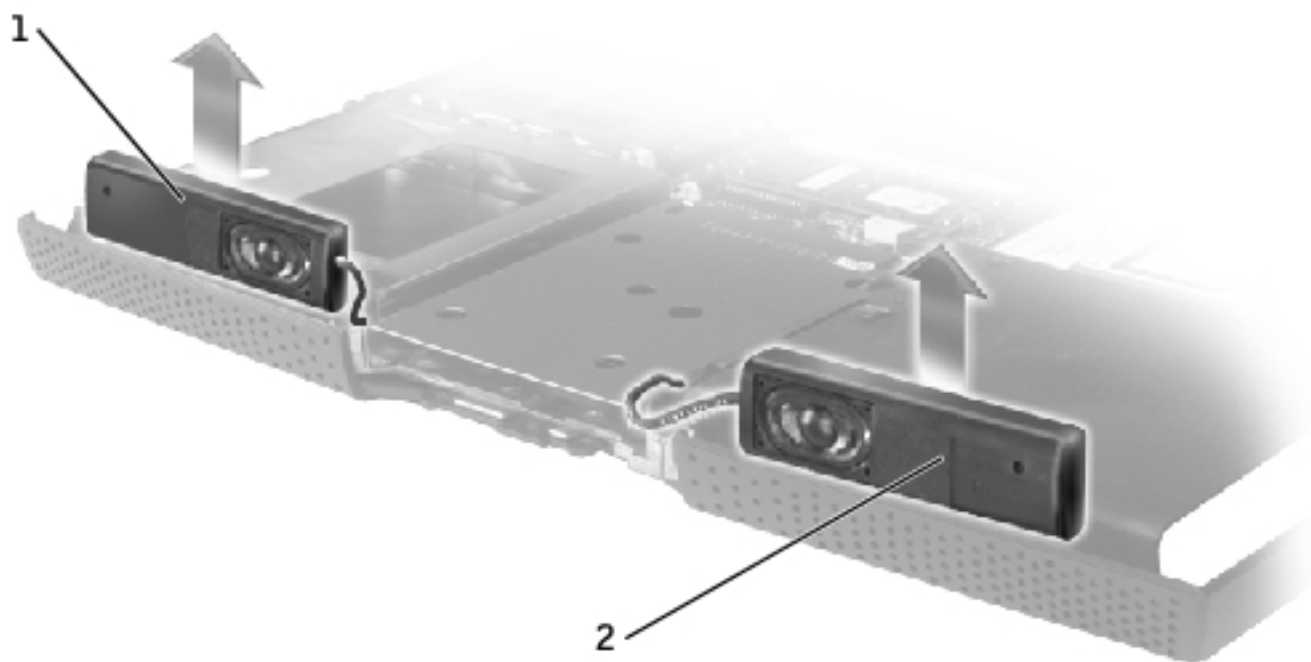

1	left speaker
2	right speaker

## Replacing the Speakers

 **NOTE:** The right speaker cable is longer than the left speaker cable.

 **NOTE:** Speakers face out in the bottom case holders.

1. Slide the speakers down into the bottom case.

 **NOTICE:** Ensure that the speaker cables are under or between their routing clips, and route the left and right speaker cables properly beneath the die casting.

 **NOTICE:** Route the speaker cables with care to avoid damaging them.

2. Route the speaker cables under or between their routing clips and die casting.

3. Connect the speaker connector to the system board.

---

[Back to Contents Page](#)

[Back to Contents Page](#)

# System Board

## Dell™ Latitude™ V710/V740 Service Manual

### Removing the System Board

- ➔ **NOTICE:** For V740 only, prior to replacing the system board, ensure that a [thermal pad](#) is present on the Memory Controller Hub (MCH) heat-sink, located on the base plastics. If a thermal pad is already present, you do not need to replace it.

The system board's BIOS chip contains the service tag sequence, which is also visible on a barcode label on the bottom of the computer. The replacement kit for the system board includes a CD that provides a utility for transferring the service tag sequence to the replacement system board.

- ➔ **NOTICE:** Disconnect the computer and any attached devices from electrical outlets, and remove any installed batteries.
- ➔ **NOTICE:** To avoid ESD, ground yourself by using a wrist grounding strap or by touching an unpainted metal surface on the computer.
- ➔ **NOTICE:** Read "[Preparing to Work Inside the Computer](#)" before performing the following procedure.

1. Remove the [hard drive](#).
2. Remove the [optical drive](#).
3. Remove the [floppy drive](#).
4. Remove the [memory module](#).
5. Remove the [modem](#).
6. Remove the [keyboard](#).
7. Remove the [display assembly](#).
8. Remove the [EMI Shield](#).
9. Remove the [video board](#).

10. Remove the [palm rest](#).
11. Remove the [microprocessor thermal-cooling assembly](#).
12. Remove the [microprocessor](#).
13. Remove the [speakers](#).

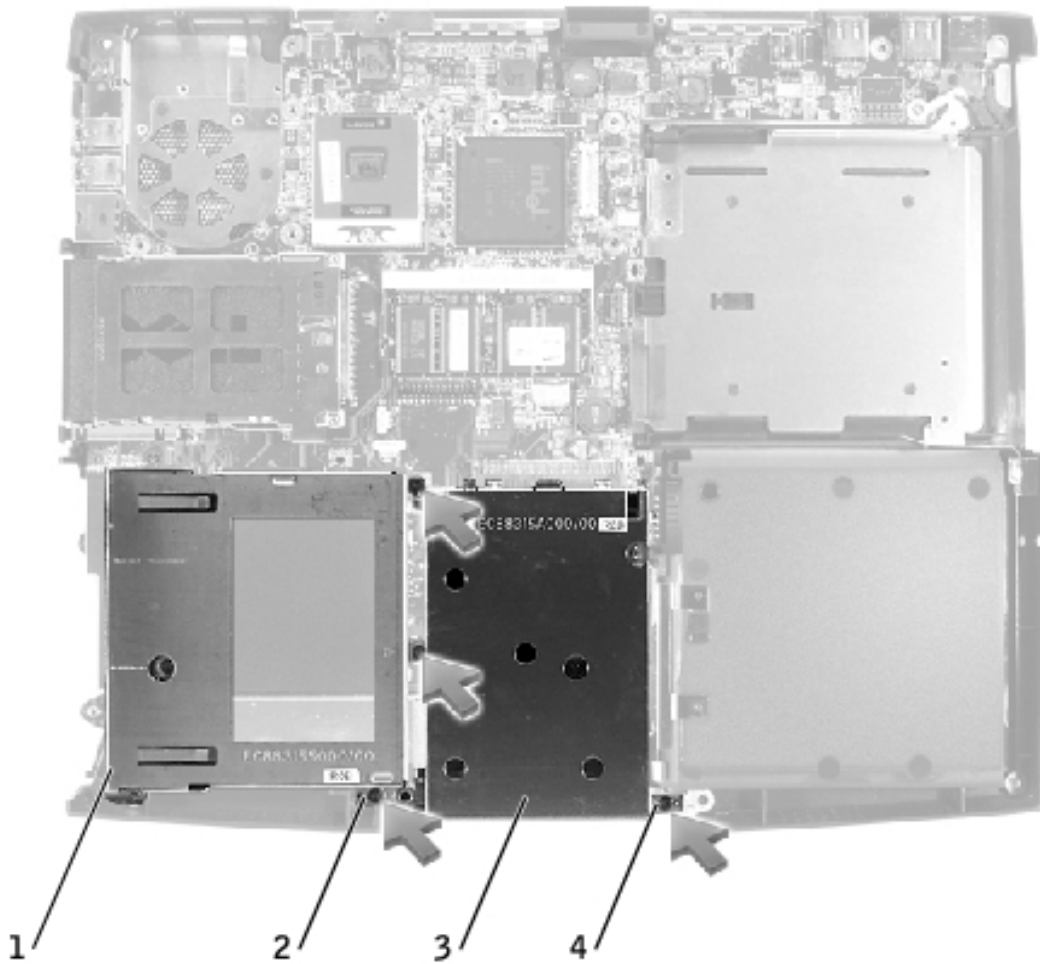

1	floppy drive cage
2	M2.5 x 5-mm screws (2)
3	hard drive cage
4	M2.5 x 5-mm screws (2)

14. Remove the two M2.5 x 5-mm screws that secure the floppy drive cage to the system board, and lift the floppy drive cage out of the bottom case.
15. Remove the two M2.5 x 5-mm screws that secure the hard drive cage to the system board, and lift the hard drive cage out of the bottom case.



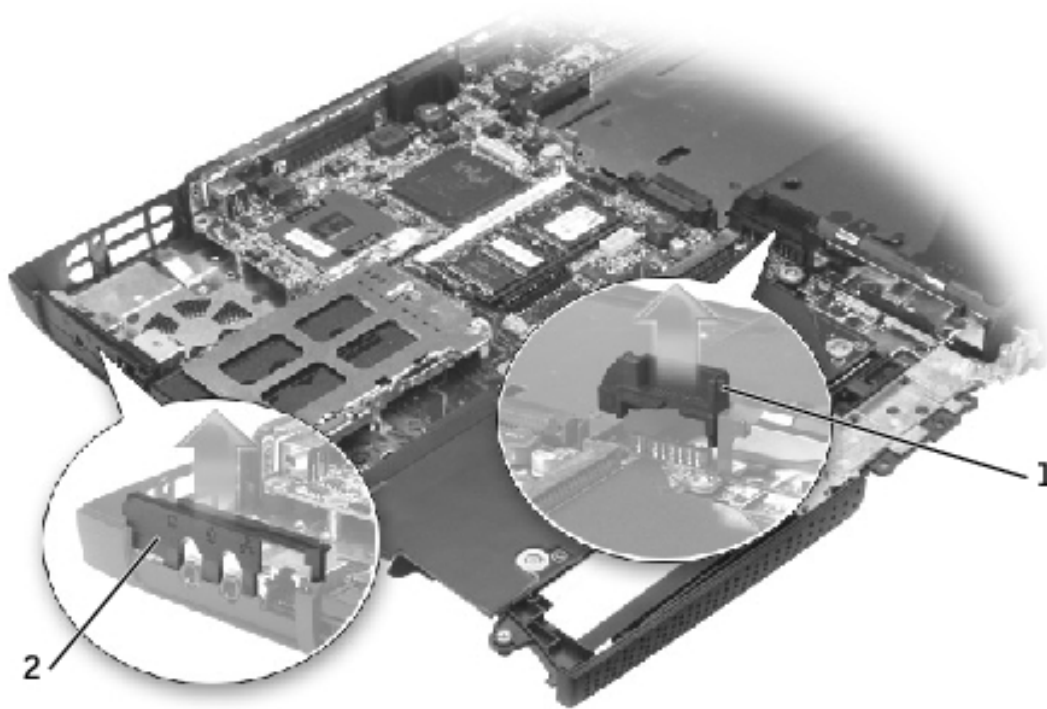



1	battery connector cover
2	headphone/microphone bridge

16. Remove the battery connector cover by lifting the cover out of the bottom case.

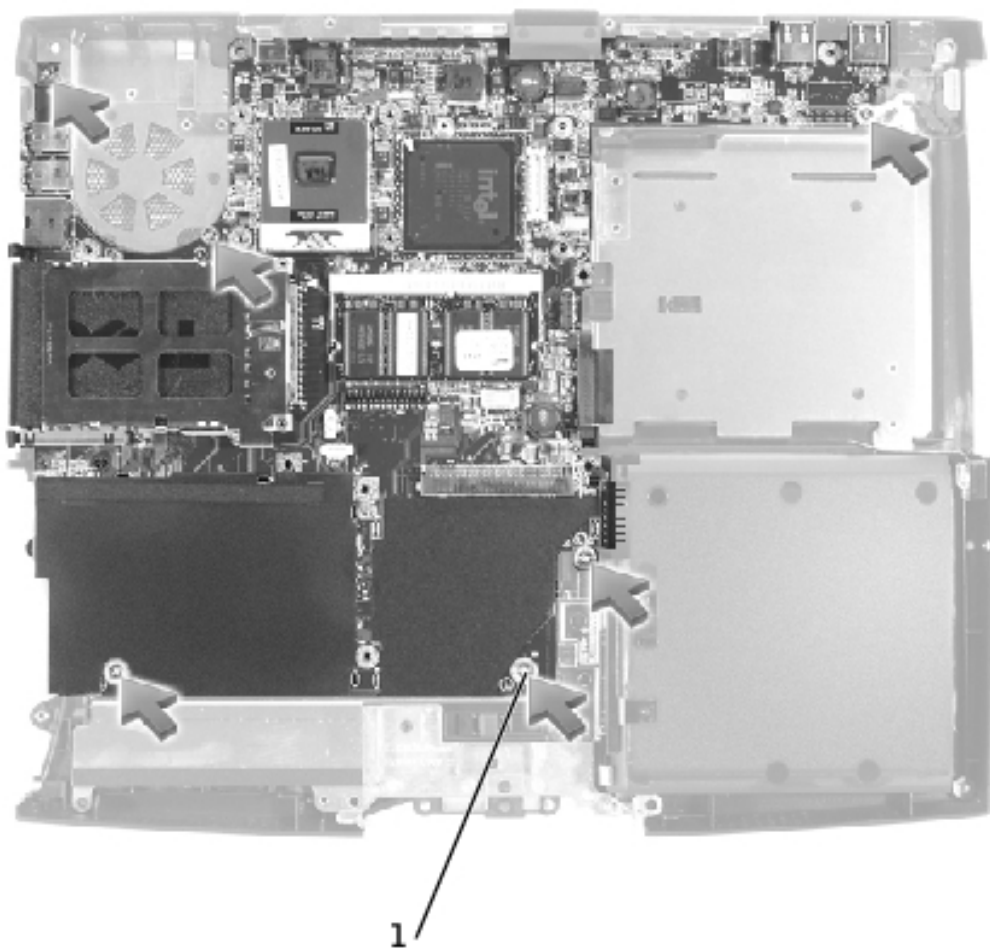
17. Remove the headphone/microphone bridge by lifting the cover out of the bottom case.



1	M2.5 x 4-mm screws (6)
---	------------------------

 **NOTE:** The M2.5 x 4 screws are silver.

18. Remove the six M2.5 x 4-mm screws labeled "circle L" that secure the system board to the bottom case.

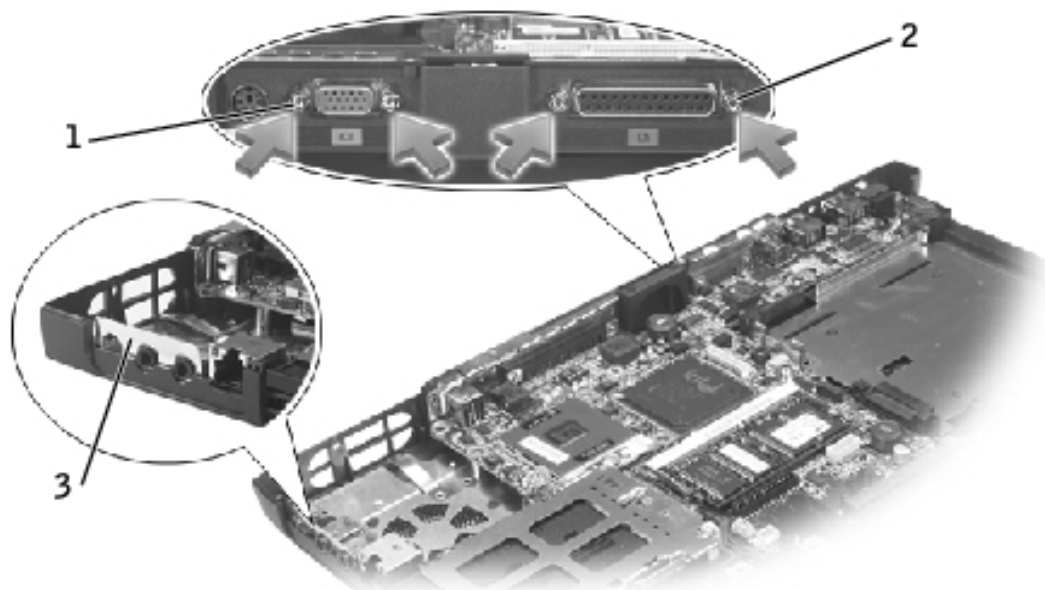

1	video-connector hex nuts
2	parallel-connector hex nuts
3	headphone/microphone flex-panel

19. Remove the two hex nuts that secure the video connector to the bottom case.
20. Remove the two hex nuts that secure the parallel connector to the bottom case.
21. Pull the headphone/microphone flex-panel away from the system board as you simultaneously lift the front of the system board out and away from the bottom case.

## Replacing the System Board

➔ **NOTICE:** For V740 only, prior to replacing the system board, ensure that a [thermal pad](#) is present on the Memory Controller Hub (MCH) heat-sink, located on the base plastics. If a thermal pad is already present, you do not need to replace it.

1. Install the replacement system board:
  - a. Insert the video connector through the back of the bottom case.
  - b. Pull the headphone and microphone flex-panel away from the system board as you simultaneously lower the front of the system board into the bottom case.

- c. Press the flex panel toward the headphone and microphone connectors, and insert the bridge into the bottom case.
- d. Reinstall the two hex nuts that secure the parallel connector to the bottom case.
- e. Reinstall the two hex nuts that secure the video connector to the bottom case.

**➔ NOTICE:** Secure the modem-cable grounding terminal to the system board with one of the six M2.5 x 4-mm screws labeled "circle L." Failure to do so may result in damage to the computer.

**🔪 NOTE:** The M2.5 x 4 screws are silver.

- f. Reinstall the six M2.5 x 4-mm screws labeled "circle L," starting on the right side of the bottom case.

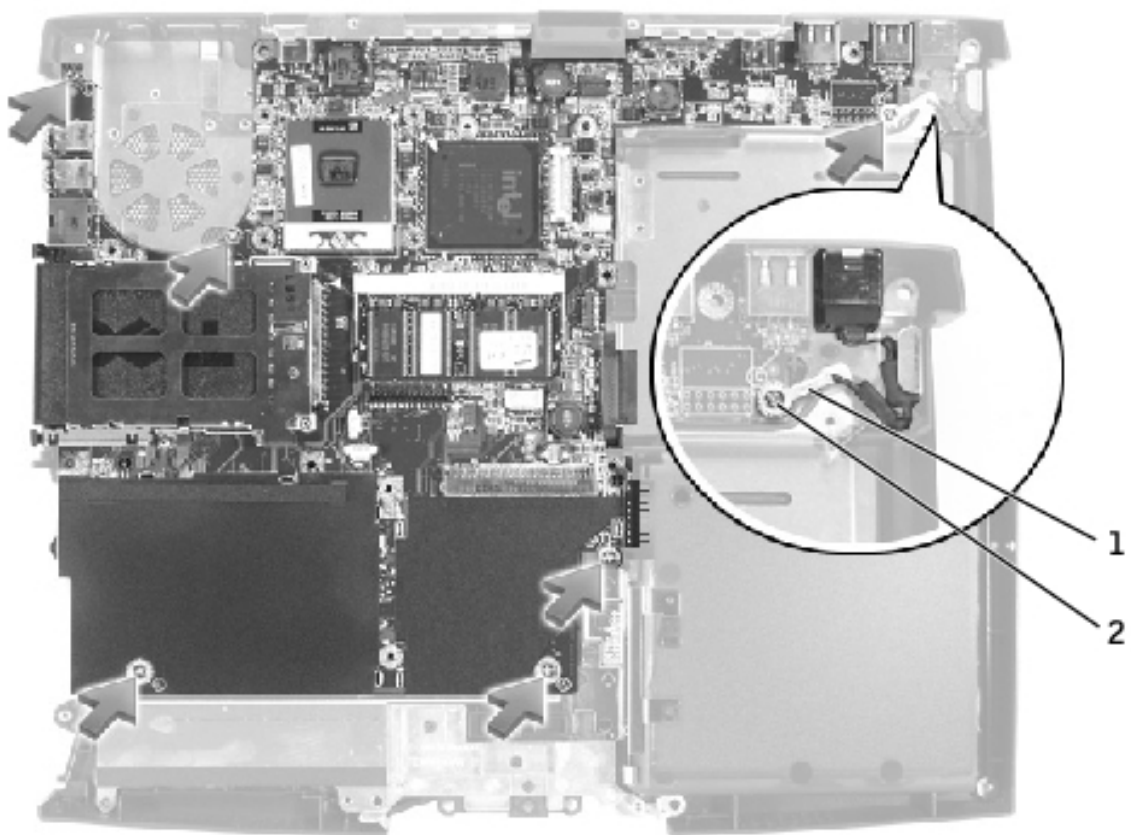

1	modem-cable grounding terminal
2	M2.5 x 4-mm screws (6)

- g. Reinstall the hard drive cage, and reinstall the two M2.5 x 5-mm screws that secure the hard drive cage to the system board.
- h. Reinstall the floppy drive cage, and reinstall the two M2.5 x 5-mm screws that secure the floppy drive cage to the system board.

2. Replace the [speakers](#).

3. Replace the [microprocessor](#) and the [microprocessor thermal-cooling assembly](#) that you removed from the old system board.

 **NOTICE:** Route cables so that they will not be crimped or pinched when the complete assembly is put back together.

4. Replace the [palm rest](#).

5. Replace the [video board](#) and the [EMI shield](#) that you removed from the old system board.

6. Replace the [display assembly](#) and the [keyboard](#).

7. Replace the [floppy drive](#), [optical drive](#), [modem](#), [memory module](#), and [hard drive](#).

8. If applicable, replace the PC Card in the PC Card slot.

9. Replace the battery.

10. Connect the AC adapter to your computer and to an electrical outlet.

 **NOTICE:** Before turning on the computer, replace all screws and ensure that no stray screws remain inside the computer. Failure to do so may result in damage to the computer.

11. Turn on the computer.

12. Insert the floppy disk or CD that accompanied the replacement system board into the appropriate drive, and turn on the computer. Follow the instructions on the screen.

 **NOTE:** After replacing the system board, enter the computer service tag sequence into the BIOS of the replacement system board.



[Back to Contents Page](#)

# Base Plastics

## Dell™ Latitude™ V710/V740 Service Manual

### Removing the Base Plastics

- ➔ **NOTICE:** Disconnect the computer and any attached devices from electrical outlets, and remove any installed batteries.
- ➔ **NOTICE:** To avoid ESD, ground yourself by using a wrist grounding strap or by touching an unpainted metal surface on the computer.
- ➔ **NOTICE:** Read "[Preparing to Work Inside the Computer](#)" before performing the following procedure.

1. Remove the [hard drive](#).
2. Remove the [optical drive](#).
3. Remove the [floppy drive](#).
4. Remove the [modem](#).
5. Remove the [keyboard](#).
6. Remove the [display assembly](#).
7. Remove the [EMI Shield](#).
8. Remove the [video board](#).
9. Remove the [palm rest](#).
10. Remove the [microprocessor thermal-cooling assembly](#).
11. Remove the [speakers](#).
12. Remove the [system board](#).

**➡ NOTICE:** For V740 only, prior to replacing the base plastics, ensure that a thermal pad is present on the Memory Controller Hub (MCH) heat-sink. If a thermal pad is already present, you do not need to replace it.

## Replacing the Thermal Pad (V740 Only)

Attach a new thermal pad inside the square etching on the MCH heat-sink, located on the inside of the base plastics.

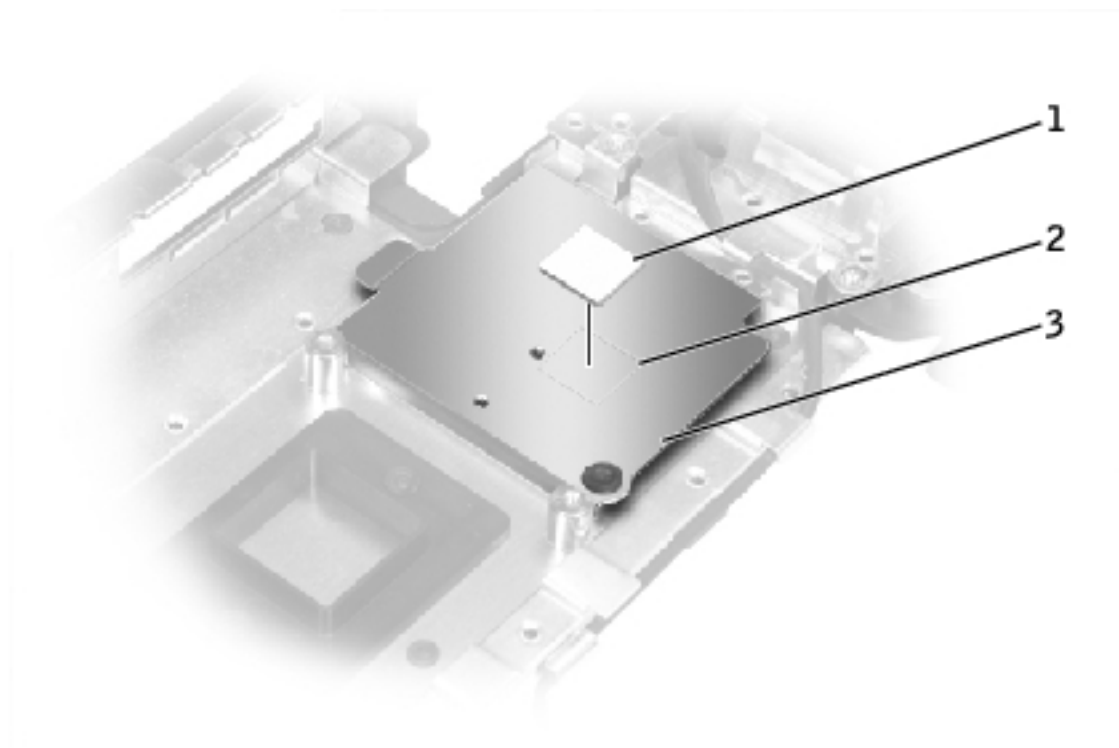

1	thermal pad
2	square etching on MCH heat-sink
3	MCH

[Back to Contents Page](#)





[Back to Contents Page](#)

# Battery Latch Assembly

## Dell™ Latitude™ V710/V740 Service Manual

### Removing the Battery Latch Assembly

- ➔ **NOTICE:** Disconnect the computer and any attached devices from electrical outlets, and remove any installed batteries.
- ➔ **NOTICE:** To avoid ESD, ground yourself by using a wrist grounding strap or by touching an unpainted metal surface on the computer.
- ➔ **NOTICE:** Read "[Preparing to Work Inside the Computer](#)" before performing the following procedure.

1. Remove the [hard drive](#).
2. Remove the [optical drive](#).
3. Remove the [floppy drive](#).
4. Remove the [modem](#).
5. Remove the [keyboard](#).
6. Remove the [display assembly](#).
7. Remove the [EMI Shield](#).
8. Remove the [video board](#).
9. Remove the [palm rest](#).
10. Remove the [microprocessor thermal-cooling assembly](#).
11. Remove the [speakers](#).
12. Remove the [system board](#).

13. Remove the M2 x 4-mm screw from the battery latch assembly.

14. Remove the latch spring and plate from the bottom case.

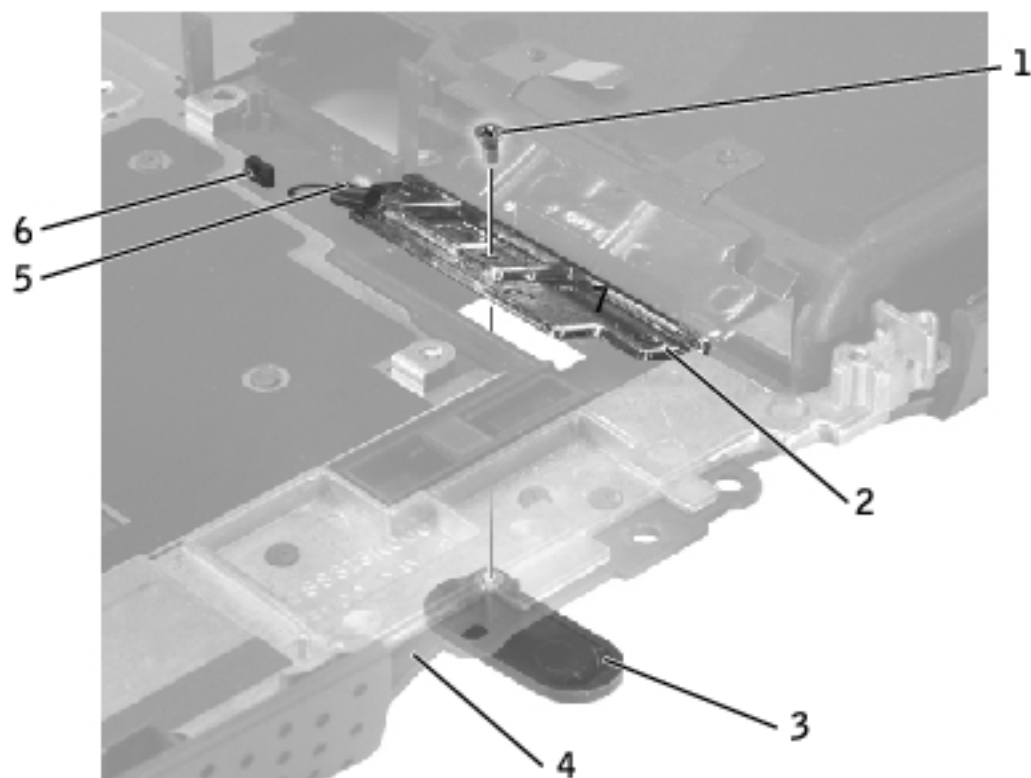

1	M2 x 4-mm screw (1)
2	latch plate
3	latch button
4	bottom case
5	latch spring
6	latch spring connector

## Replacing the Battery Latch Assembly

1. Attach the latch spring to the latch spring connector in the bottom case.
2. Insert the latch plate in the bottom case.
3. Install the new latch button from behind the bottom case, ensuring that the latch button and latch plate screw holes are properly aligned.

To prevent the latch assembly from coming loose, apply pressure to the latch plate and spring while replacing the latch button.

4. Replace and tighten the M2 x 4-mm screw that secures the latch button to the bottom case.

Ensure that the newly installed latch moves smoothly and freely when pushed and released.

---

[Back to Contents Page](#)

[Back to Contents Page](#)

# Pin Assignments for I/O Connectors

## Dell™ Latitude™ V710/V740 Service Manual

- [USB Connector](#)
  - [PS/2 Connector](#)
  - [Video Connector](#)
  - [Parallel Connector](#)
- 

## USB Connector

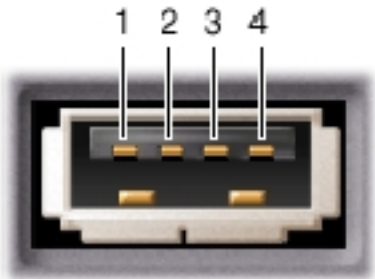

Pin	Signal
1	USB5V+
2	USBP-
3	USBP+
4	GND

---

# PS/2 Connector

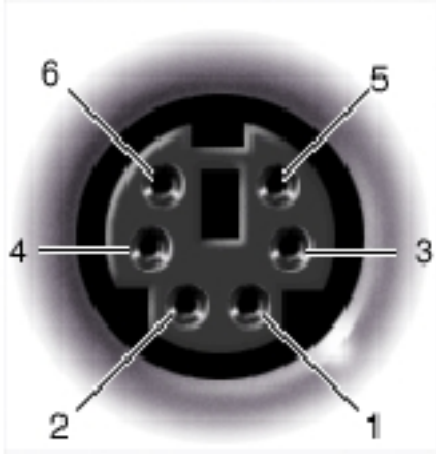

Pin	Signal
1	KBDATA
2	PS2DATA
3	GND
4	VCC
5	KBCLK
6	PS2CLK

# Video Connector



5 4 3 2 1  
 10 9 8 7 6  
 15 14 13 12 11

Pin	Signal	Pin	Signal
1	CRT_R	9	5V+
2	CRT_G	10	GND
3	CRT_B	11	MONITOR_DETECT-
4	NC	12	DDC_DATA
5	GND	13	CRT_HS
6	GND	14	CRT_VS
7	GND	15	DDC_CLK
8	GND		

## Parallel Connector



13 12 11 10 9 8 7 6 5 4 3 2 1  
 25 24 23 22 21 20 19 18 17 16 15 14

<b>Pin</b>	<b>Signal</b>	<b>Pin</b>	<b>Signal</b>
1	STROBE-	10	ACK-
2	PD0	11	BUSY
3	PD1	12	PE
4	PD2	13	SLCT
5	PD3	14	AFD/3M-
6	PD4	15	ERROR-
7	PD5	16	INIT-
8	PD6	17	SLIN-
9	PD7	18-25	GND

---

[Back to Contents Page](#)