

# Dell™ Latitude™ C840 Service Manual

## [Before You Begin](#)

[Preparing to Work Inside the Computer](#)

[Recommended Tools](#)

[Computer Orientation](#)

[Screw Identification](#)

## [System Components](#)

### [Hard Drive and Fixed Optical Drive](#)

[Hard Drive](#)

[Fixed Optical Drive](#)

### [System Upgrades](#)

[Memory Modules](#)

[Modem Daughter Card](#)

[Mini PCI Card](#)

## [Keyboard](#)

## [Display](#)

[Display Overview](#)

[Hinge Cover](#)

[Display Assembly](#)

[Display Bezel](#)

[Display Panel](#)

[Display Latch](#)

## [Microprocessor Thermal-Cooling Assembly](#)

## [Microprocessor Module](#)

## [Video Graphics Board](#)

## [Palm Rest](#)

## [Reserve Battery](#)

## [System Board](#)

## [Battery and Module Bay Latches](#)

## [Battery Charger Board](#)

## [LED Board](#)

## [Fan](#)

## [RJ-11/RJ-45 Module](#)

## [Pin Assignments for I/O Connectors](#)

[Back to Contents Page](#)

# Before You Begin

## Dell™ Latitude™ C840 Service Manual

- [Preparing to Work Inside the Computer](#)
  - [Recommended Tools](#)
  - [Computer Orientation](#)
  - [Screw Identification](#)
- 

## Preparing to Work Inside the Computer

 **CAUTION:** Only a certified service technician should perform repairs on your computer. Damage due to servicing that is not authorized by Dell is not covered by your warranty. Read and follow all safety instructions in "Safety and EMC Instructions: Portable Computers" in your *System Information Guide*.

 **NOTICE:** To avoid damaging the computer, perform the following steps before you begin working inside the computer.

1. Ensure that the work surface is flat and clean to prevent scratching the computer cover.
2. Save any work in progress and exit all open programs.
3. Turn off the computer and all attached devices.

 **NOTE:** Before turning off the computer, ensure that the computer is not in a power-management mode.

4. Ensure that the computer is undocked.
5. Disconnect the computer from the electrical outlet.

6. To avoid possible damage to the system board, wait 10 to 20 seconds and then disconnect any attached devices.
7. Disconnect all other external cables from the computer.
8. Remove any installed PC Cards or plastic blanks from the PC Card slot.
9. Close the display and turn the computer upside down on a flat work surface.
10. Remove the battery from the battery bay.

 **NOTICE:** To avoid component damage, always remove any installed batteries before you service the computer.

11. Remove any device installed in the module bay.
12. To dissipate static electricity while you work, periodically touch an unpainted metal surface on the computer chassis.
13. Handle components and cards by their edges, and avoid touching pins and contacts.

---

## Recommended Tools

The procedures in this document require the following tools:

- #1 magnetized Phillips screwdriver
- Small flat-blade screwdriver
- Microprocessor extractor
- Nonmarring plastic scribe
- Flash BIOS update floppy disk or CD (provided when needed to upgrade the BIOS)

# Computer Orientation

back of computer

left

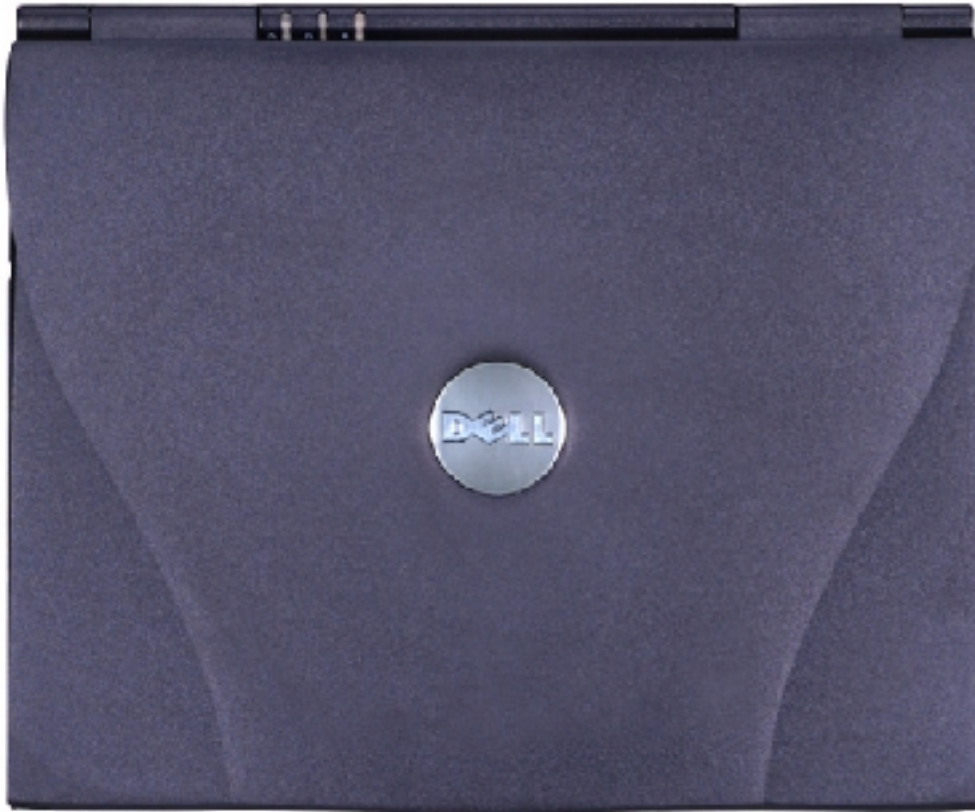

right

front of computer

---





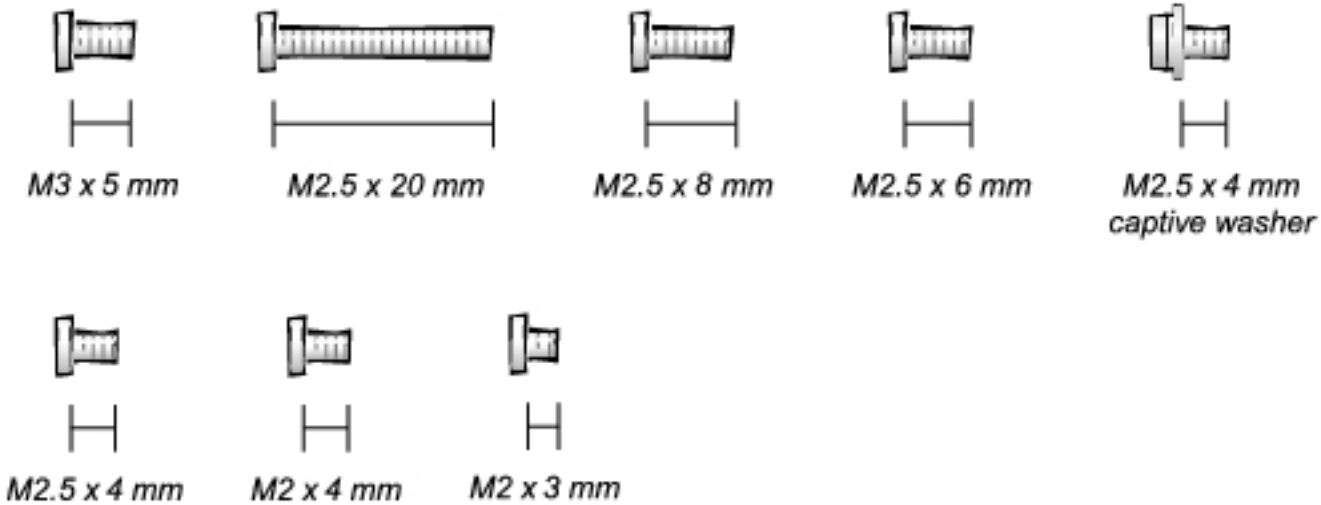

## Screw Identification











When you are removing and replacing components, photocopy the placemat as a tool to lay out and keep track of the component screws. The placemat provides the number of screws and the sizes.

### Screw Identification



**➔ NOTICE:** When reinstalling a screw, you must use a screw of the correct diameter and length. Ensure that the screw is properly aligned with its corresponding hole, and avoid overtightening.

<p><b>Hard-Drive Door Security:</b></p> <p>M3 x 5 mm (1 each)</p> 	<p><b>Keyboard to Bottom Case:</b></p> <p>M2.5 x 20 mm (4 each; one in memory door and one in Mini PCI door)</p> 	<p><b>Display to Bottom Case:</b></p> <p>M2.5 x 6 mm (3 each; 2 at back of computer; 1 at display flex-cable strain relief)</p> 
<p><b>Display Bezel:</b></p> <p>Rubber screw covers (4 each)</p> <p>Plastic screw covers (2 each)</p> <p>M2.5 x 4 mm (6 each)</p> 	<p><b>Display Panel to Display Mounting Bracket:</b></p> <p>M2 x 3 mm (6 each)</p>  <p><b>Flex-Cable Mounting Bracket to Top Cover:</b></p>	<p><b>Video Graphics Board:</b></p> <p>M2.5 x 8 (3 each)</p> 

	<p><b>M2.5 x 4 mm (1 each)</b></p> 	
<p><b>Palm Rest to Bottom Case:</b></p> <p><b>M2.5 x 20 mm (9 each)</b></p>  <p><b>Palm Rest Bracket:</b></p> <p><b>M2.5 x 4 mm (4 each)</b></p> 	<p><b>System Board:</b></p> <p><b>M2.5 x 4 mm captive washer (3 each)</b></p>  <p><b>M2.5 x 20 mm (1 each)</b></p> 	<p><b>LED Board:</b></p> <p><b>M2 x 4 mm (2 each)</b></p> 
<p><b>Fan:</b></p> <p><b>M2 x 4 mm (3 each)</b></p> 	<p><b>Memory Module/Modem Cover:</b></p> <p><b>M2.5 x 20 mm (1 each)</b></p> 	<p><b>Modem Daughter Card:</b></p> <p><b>M2 x 3 mm (1 each)</b></p> 
<p><b>Mini PCI Card:</b></p> <p><b>M2.5 x 20 mm (1 each)</b></p> 		

[Back to Contents Page](#)



[Back to Contents Page](#)

# System Components

## Dell™ Latitude™ C840 Service Manual

➔ **NOTICE:** Unless otherwise noted, each procedure in this document assumes that a part can be replaced by performing the removal procedure in reverse order.

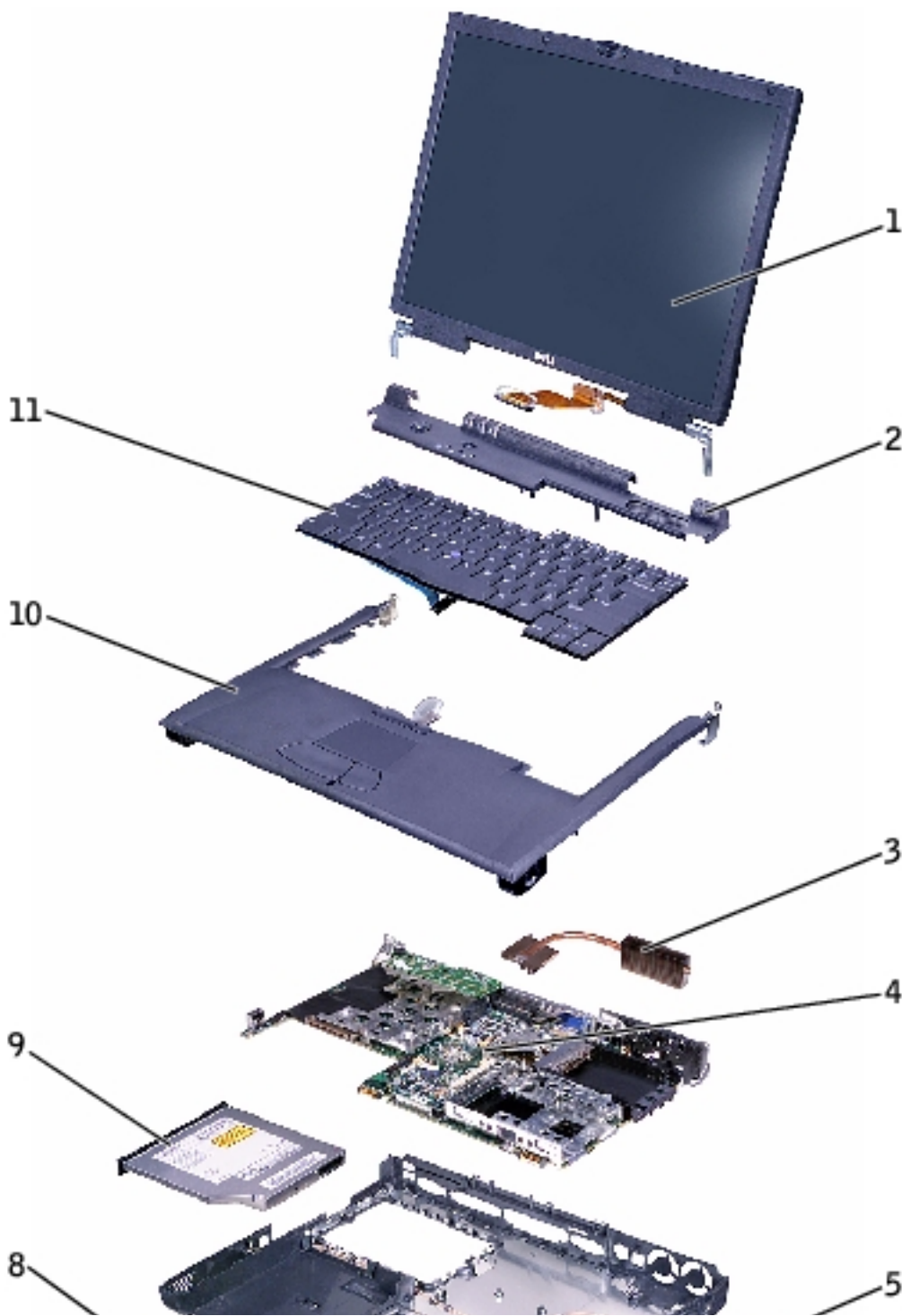



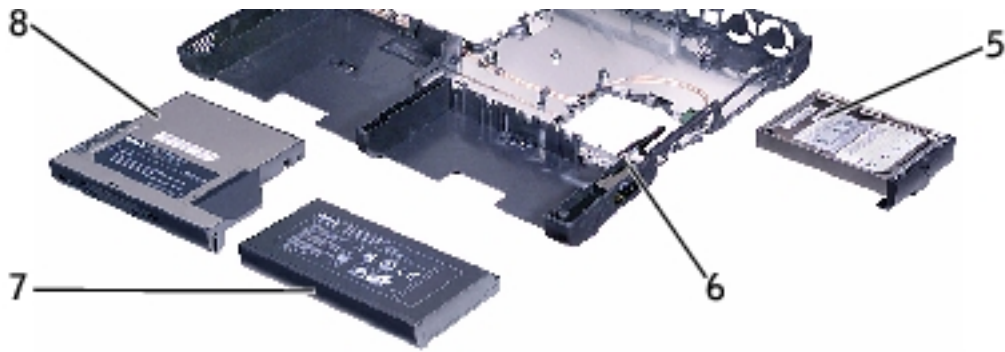

1	display assembly	7	main battery
2	hinge cover	8	device in module bay
3	microprocessor thermal-cooling assembly	9	fixed optical drive
4	system board	10	palm rest
5	hard drive	11	keyboard
6	bottom case		

[Back to Contents Page](#)

[Back to Contents Page](#)

# Hard Drive and Fixed Optical Drive

## Dell™ Latitude™ C840 Service Manual

• [Hard Drive](#)

• [Fixed Optical Drive](#)

- ➔ **NOTICE:** Only a certified service technician should perform repairs on your computer. Damage due to servicing that is not authorized by Dell is not covered by your warranty.
- 

## Hard Drive

- ➔ **NOTICE:** Disconnect the computer and attached devices from the electrical outlet and remove any installed batteries.
- ➔ **NOTICE:** To avoid ESD, ground yourself by using a wrist grounding strap or by periodically touching unpainted metal on the computer.
- ➔ **NOTICE:** The hard drive is very sensitive to shock. Handle the drive by its edges (do not squeeze the top of the case), and avoid dropping it.

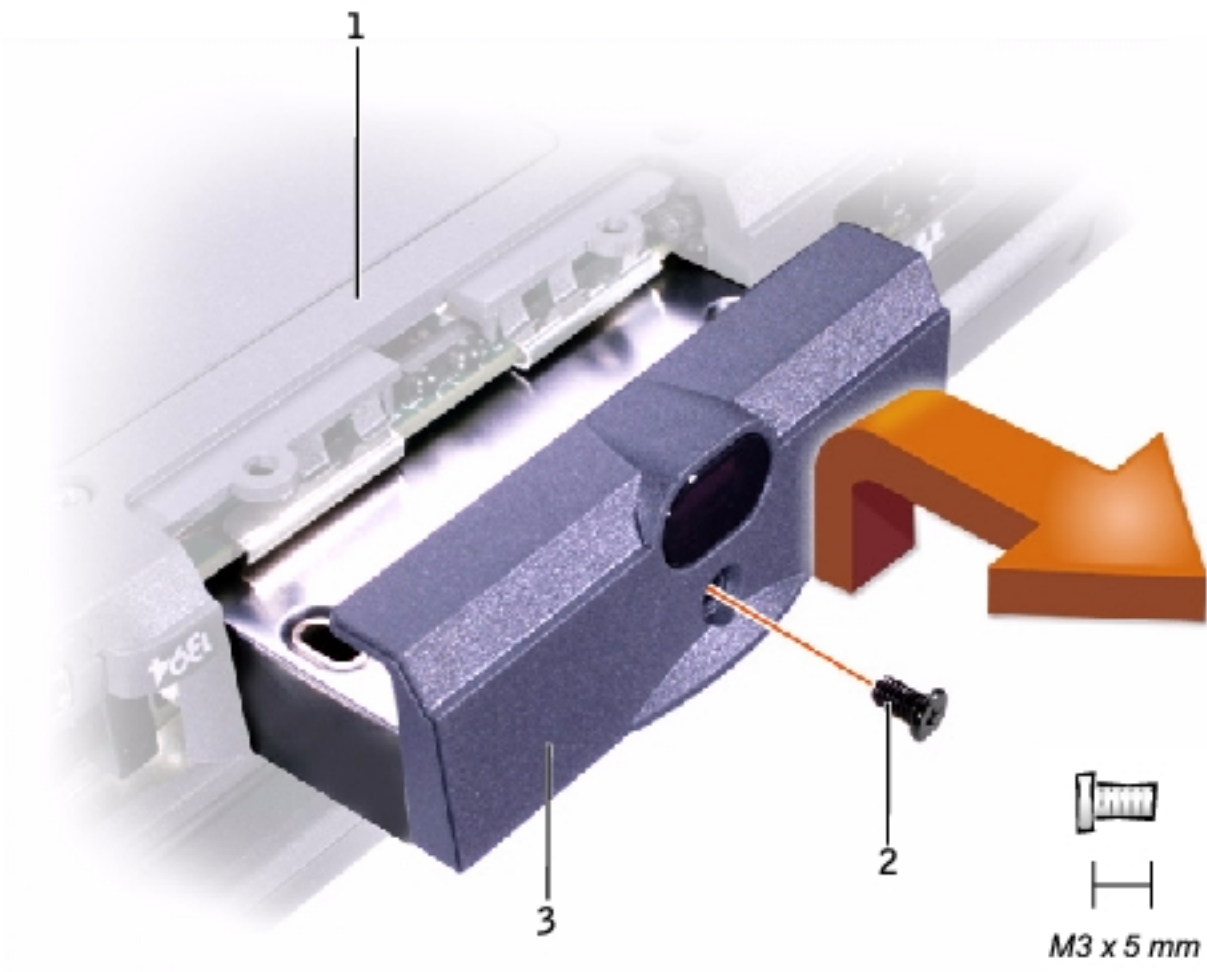

1	bottom of computer
2	M3 x 5-mm screw
3	hard drive door

## Removing the Hard Drive

1. Follow the instructions in "[Preparing to Work Inside the Computer.](#)"
2. Remove the M3 x 5-mm screw.
3. Pull the hard drive out.

## Replacing the Hard Drive

1. Push the hard drive into the drive bay until the drive door is flush with the computer case.

2. Push down on the drive until it snaps into place.
3. Replace the M3 x 5-mm screw in the hard drive door.

---

## Fixed Optical Drive

- ➔ **NOTICE:** Disconnect the computer and attached devices from the electrical outlet and remove any installed batteries.
- ➔ **NOTICE:** To avoid ESD, ground yourself by using a wrist grounding strap or by periodically touching unpainted metal on the computer.

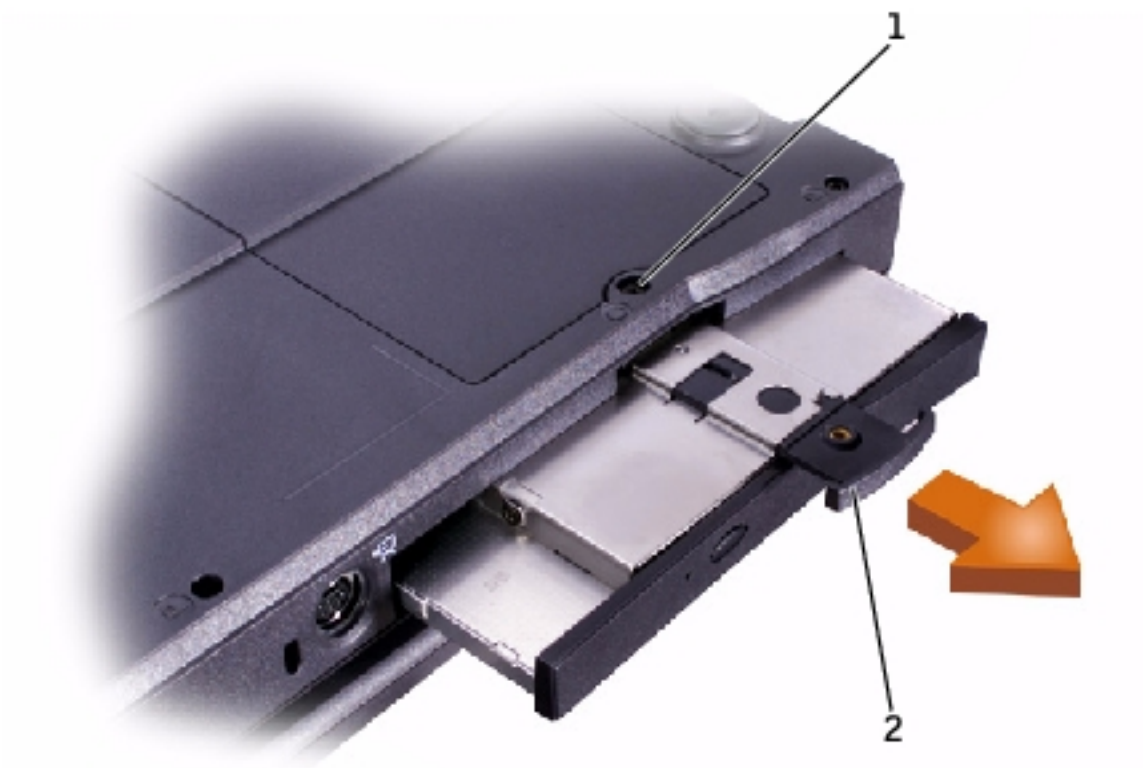

1	captive screw
2	pull tab

# Removing the Fixed Optical Drive

1. Follow the instructions in "[Preparing to Work Inside the Computer.](#)"
  2. Loosen the captive screw on the bottom of the computer.
  3. Turn the computer over (to keep the captive screw from interfering with the pull tab) and pull out the pull tab.
  4. Use the pull tab to remove the fixed optical drive.
- 

[Back to Contents Page](#)

[Back to Contents Page](#)

# System Upgrades

## Dell™ Latitude™ C840 Service Manual

- [Memory Modules](#)
  - [Modem Daughter Card](#)
  - [Mini PCI Card](#)
- 

## Memory Modules

- ➔ **NOTICE:** Disconnect the computer and any attached devices from electrical outlets and remove any installed batteries.
- ➔ **NOTICE:** To avoid ESD, ground yourself by using a wrist grounding strap or by periodically touching unpainted metal on the computer.

## Removing the Memory Module/Modem Cover

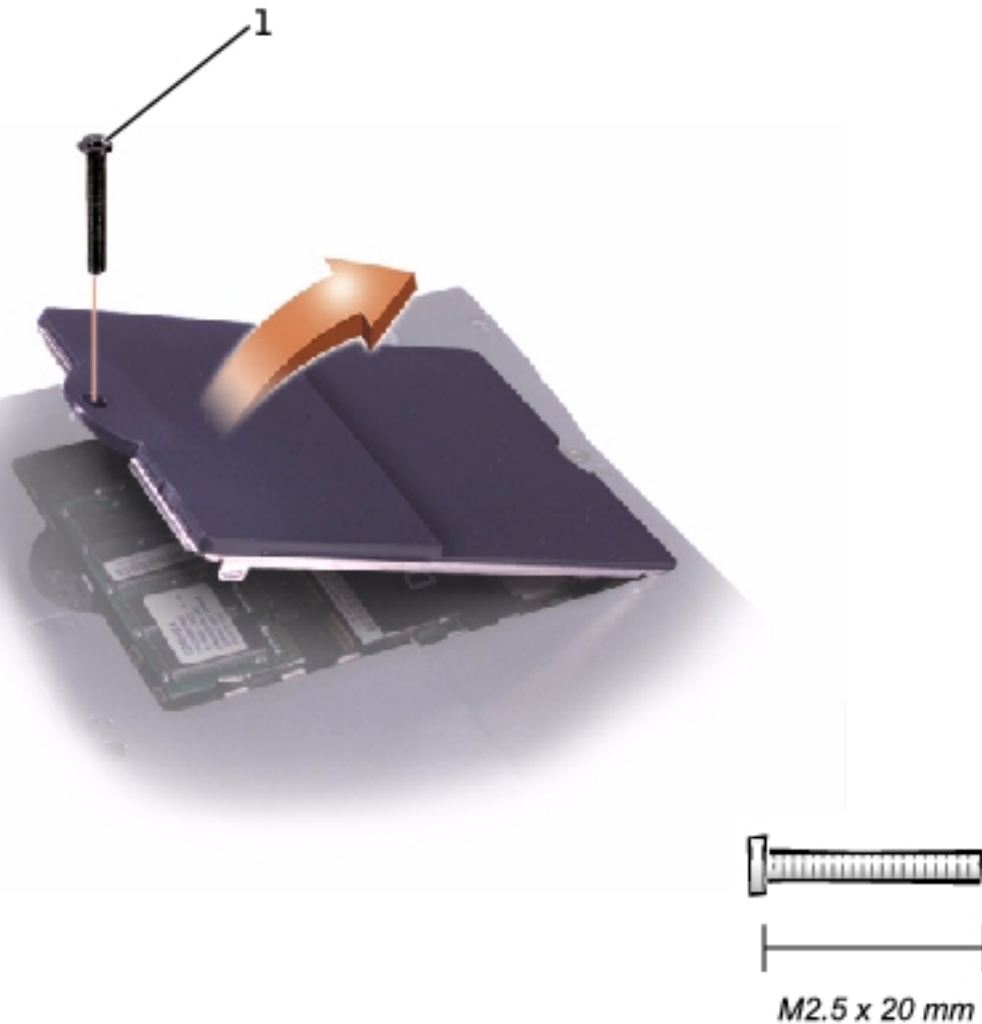

1	M2.5 x 20-mm screw
---	--------------------

1. Follow the instructions in "[Preparing to Work Inside the Computer.](#)"
2. Remove the M2.5 x 20-mm screw from the memory module/modem cover.
3. Disengage the metal tabs at the opposite end of the cover.

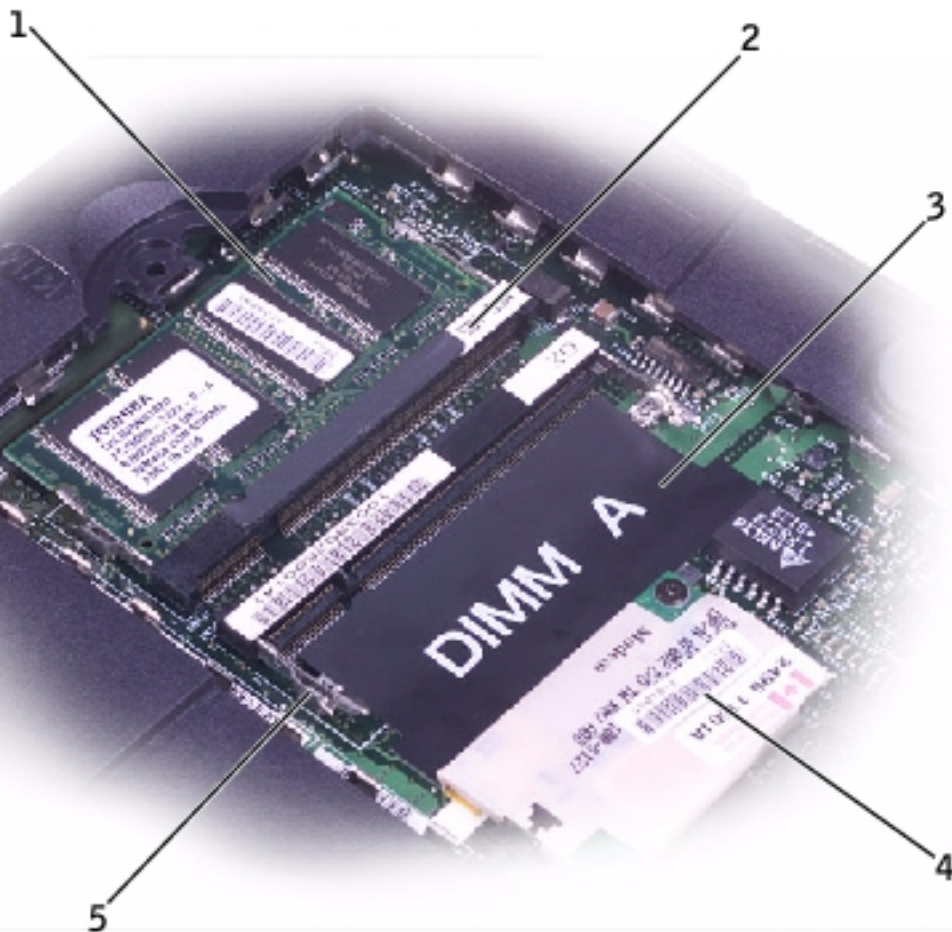

1	DIMM B
2	memory module sockets (2)
3	DIMM A socket
4	modem daughter card
5	metal tabs (2 per socket)

## Removing the Memory Modules

1. Remove the [memory module/modem cover](#).
2. To release a memory module from its socket, spread apart the tabs at each side of the module until the module pops up slightly.
3. Lift the memory module out of its socket.



## Replacing the Memory Modules

1. If you only have one memory module, install it in the socket labeled "DIMM A." Install a second memory module in the socket labeled "DIMM B."



**NOTE:** Memory modules are keyed to fit into their sockets in only one direction.

2. Insert the memory-module edge connector into the socket slot at a 45-degree angle and press the module firmly into the slot.
  3. Pivot the module down until it clicks into place. If you do not hear a click, remove the module and reinstall it.
  4. Insert the metal tabs on the memory module/modem cover into the bottom case, rotate the cover down, and replace the M2.5 x 20-mm screw.
- 

## Modem Daughter Card

### Removing the Modem Daughter Card



**NOTICE:** Disconnect the computer and any attached devices from electrical outlets and remove any installed batteries.



**NOTICE:** To avoid ESD, ground yourself by using a wrist grounding strap or by periodically touching unpainted metal on the computer.

1. Follow the instructions in "[Preparing to Work Inside the Computer](#)."
2. Turn the computer over and remove the [memory module/modem cover](#).

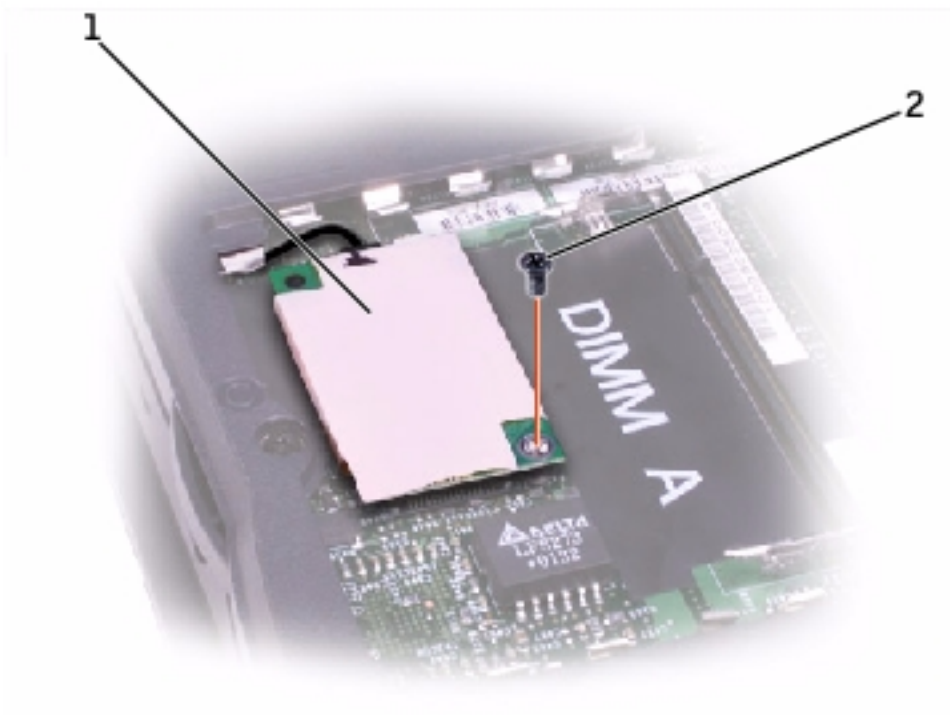

1	modem daughter card
2	M2 x 3-mm screw

3. Remove the M2 x 3-mm screw that secures the modem daughter card to the system board.
4. Use the pull tab to pull the modem daughter card straight up out of its connector.

➡ **NOTICE:** Do not pull on the modem cable. Pull the connector on the end of the cable to disconnect the cable.

5. Disconnect the modem cable from the modem daughter card.

## Replacing the Modem Daughter Card

➡ **NOTICE:** The cable connectors are keyed for correct insertion. Do not force the connections.

1. Connect the modem cable to the modem daughter card.

2. Use the screw and boss holes at opposite corners of the modem daughter card to align the card, and press the card into its connector on the system board.
  3. Install the M2 x 3-mm screw that secures the card to the system board.
  4. Replace the memory module/modem cover.
- 

## Mini PCI Card

You must remove the optional Mini PCI wireless modem (if installed) before the system board can be removed. A wireless modem card must be connected to the internal antenna of the computer.

- ➔ **NOTICE:** Disconnect the computer and attached devices from electrical outlets and remove any installed batteries.
- ➔ **NOTICE:** To avoid ESD, ground yourself by using a wrist grounding strap or by periodically touching unpainted metal on the computer.

## Mini PCI Card Cover

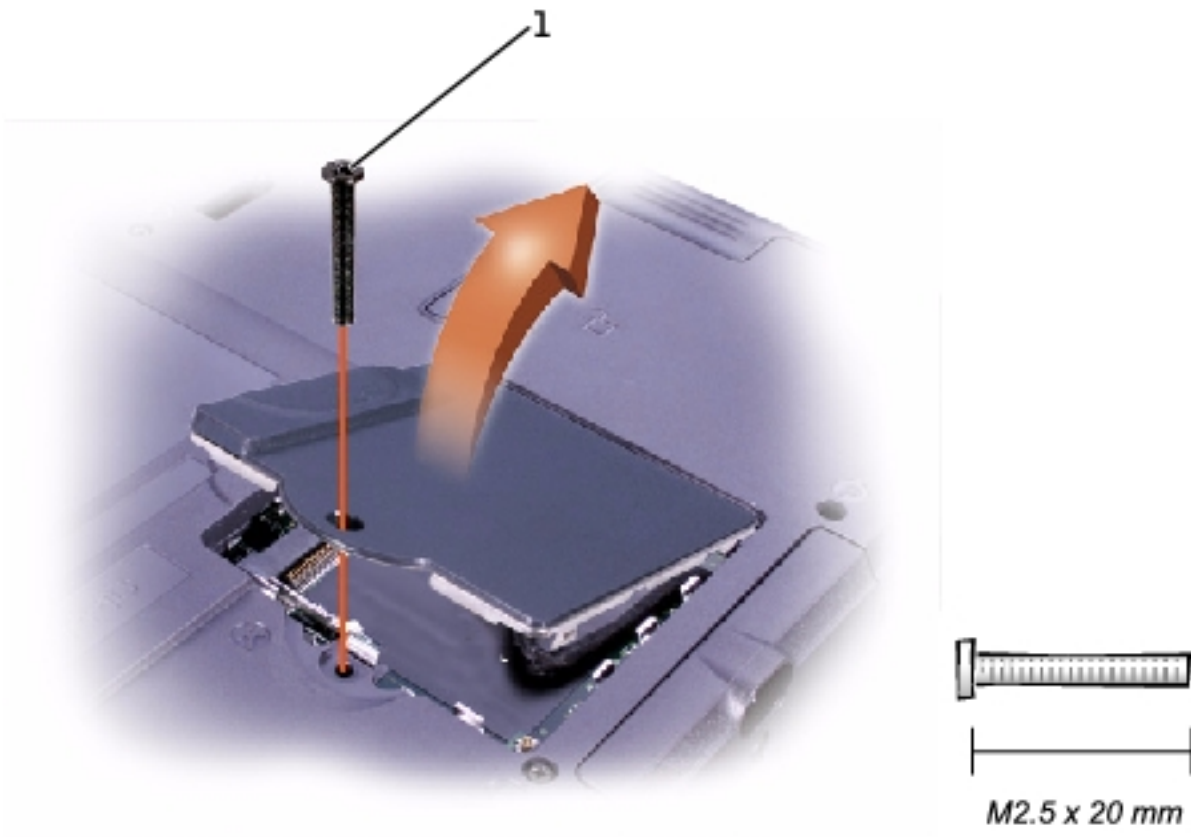

1	M2.5 x 20-mm screw
---	--------------------

## Removing the Mini PCI Card

1. Follow the instructions in "[Preparing to Work Inside the Computer.](#)"
2. Remove the M2.5 x 20-mm screw and then remove the Mini PCI card cover.
3. To release the Mini PCI card, spread the metal securing tabs until the card pops up slightly.
4. Disconnect the card from the internal antenna.
5. Lift out the card and disconnect any attached cables.

## Replacing the Mini PCI Card

1. Align the Mini PCI card with the socket at a 45-degree angle, and press the Mini PCI card into the socket.

2. Connect the internal-antenna cable to the primary-antenna connector on the card.

**➔ NOTICE:** The connectors are keyed for correct insertion; do not force the connections.

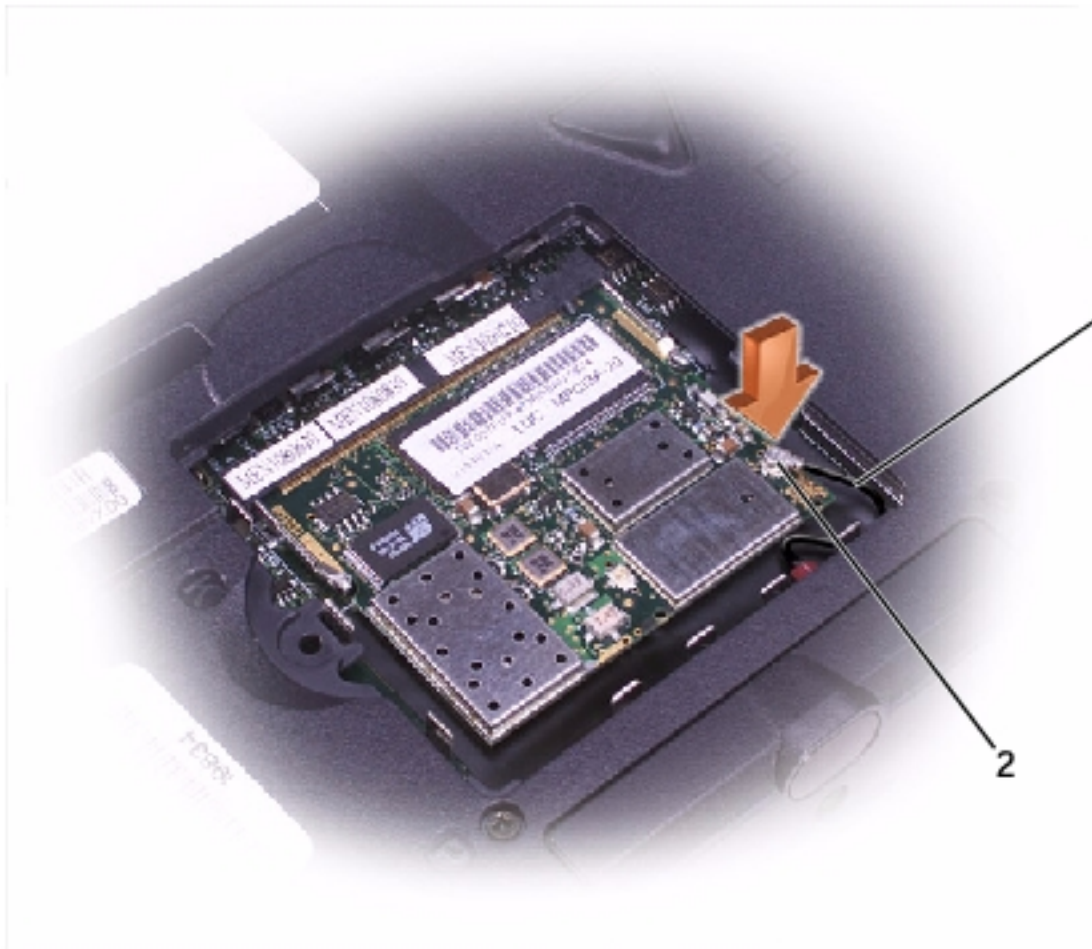

1	internal-antenna cable
2	primary-antenna connector on card

3. Pivot the Mini PCI card down until it clicks into place.
4. Replace the Mini PCI card cover and the M2.5 x 20-mm screw.

[Back to Contents Page](#)

[Back to Contents Page](#)

# Keyboard

## Dell™ Latitude™ C840 Service Manual

- ➔ **NOTICE:** Disconnect the computer and attached devices from electrical outlets and remove any installed batteries.
- ➔ **NOTICE:** To avoid ESD, ground yourself by using a wrist grounding strap or by periodically touching unpainted metal on the computer.

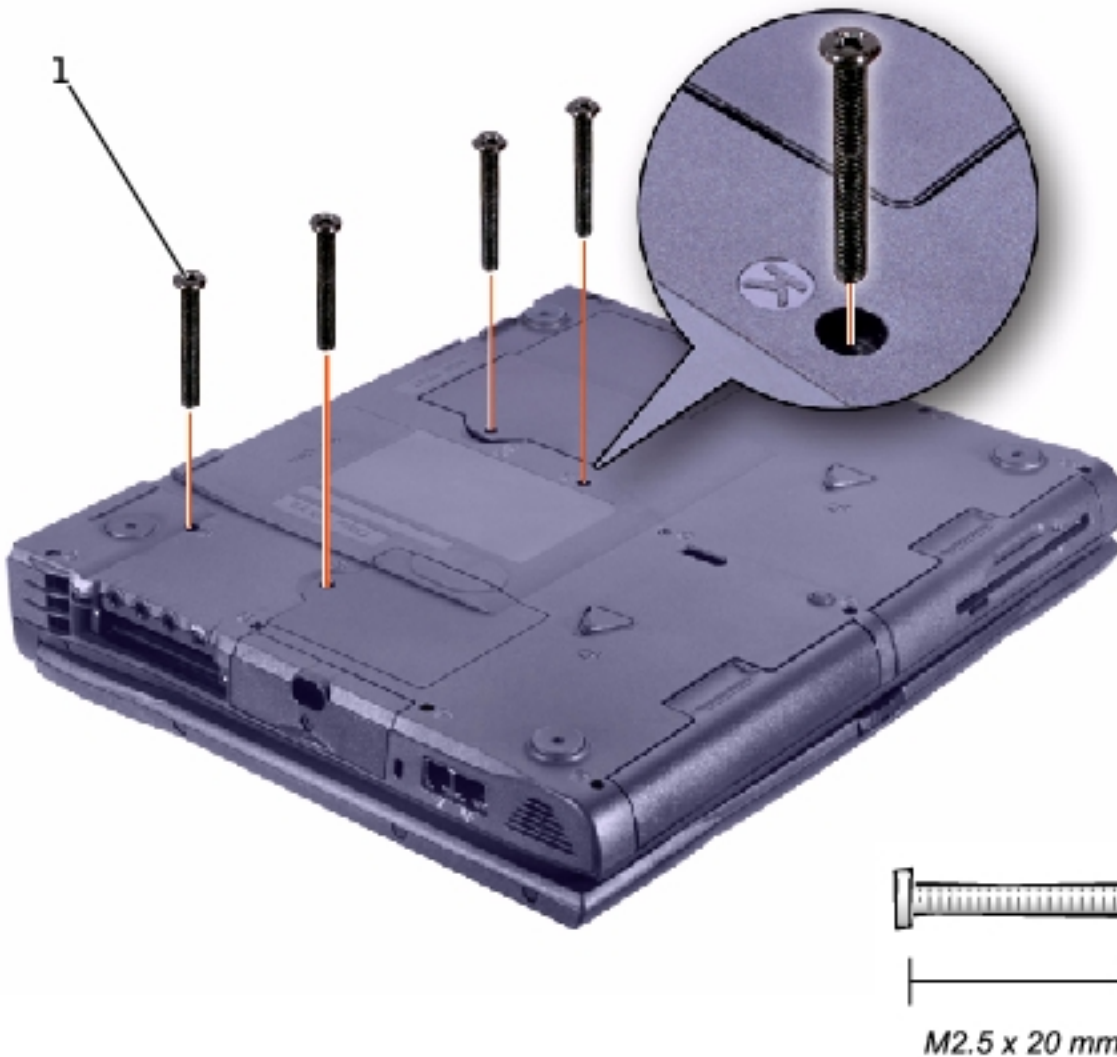

1	M2.5 x 20-mm screws (4)
---	----------------------------

## Removing the Keyboard

1. Follow the instructions in "[Preparing to Work Inside the Computer.](#)"
2. Turn the computer over and remove the four M2.5 x 20-mm screws (three labeled "circle K" and one labeled "circle K/M").
3. Turn the computer over and open the display.

 **NOTICE:** Be careful when handling the keyboard. The keycaps are fragile, easily dislodged, and time-consuming to replace.

4. Use a nonmarring plastic scribe under the blank key to pry up the keyboard.



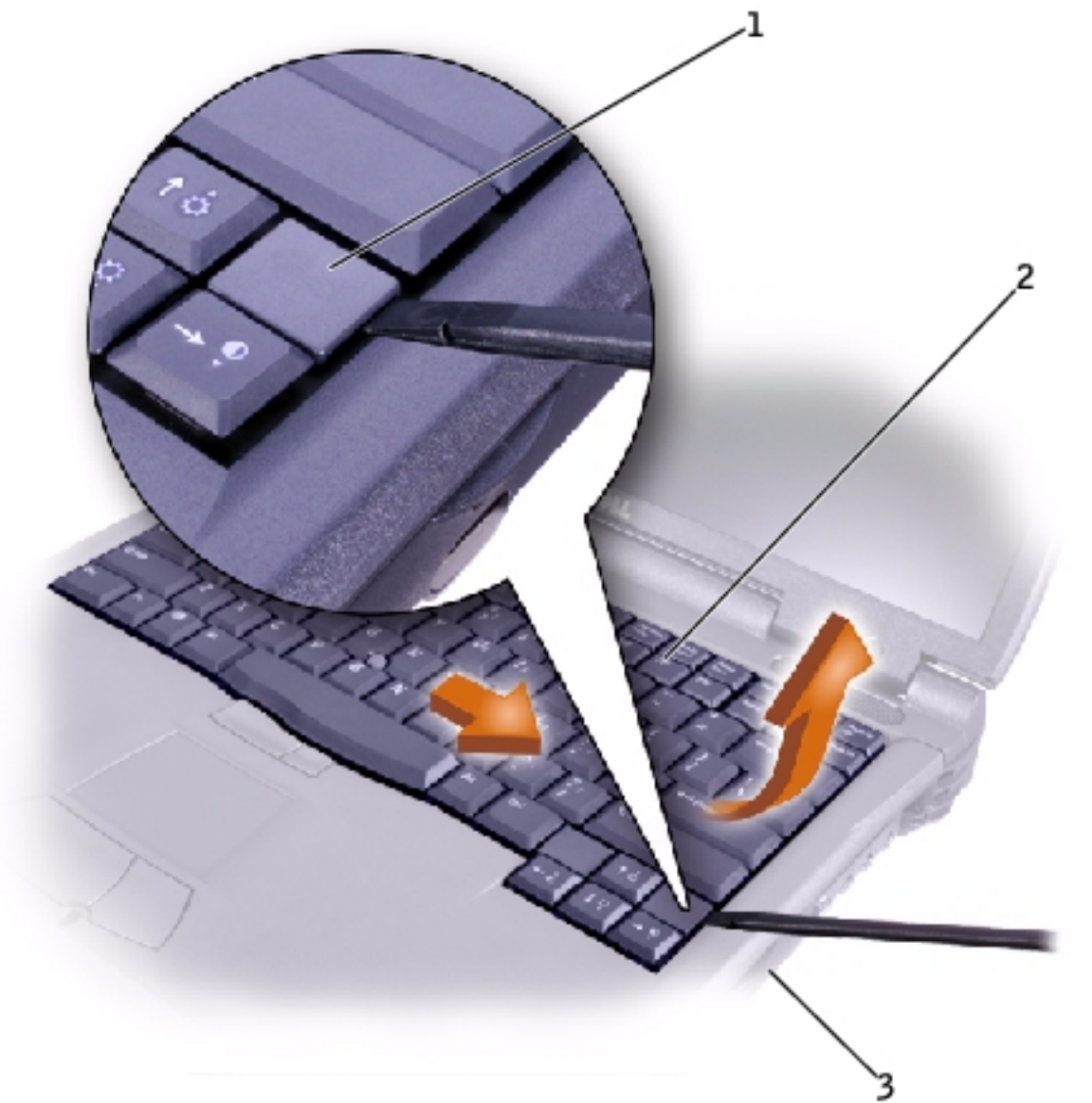

1	blank key
2	keyboard
3	right side of computer

5. Lift the right end of the keyboard and slide it slightly toward the right side of the computer to disengage the tabs at the left end.
6. Pivot the keyboard and balance it upright on the left side of the computer.

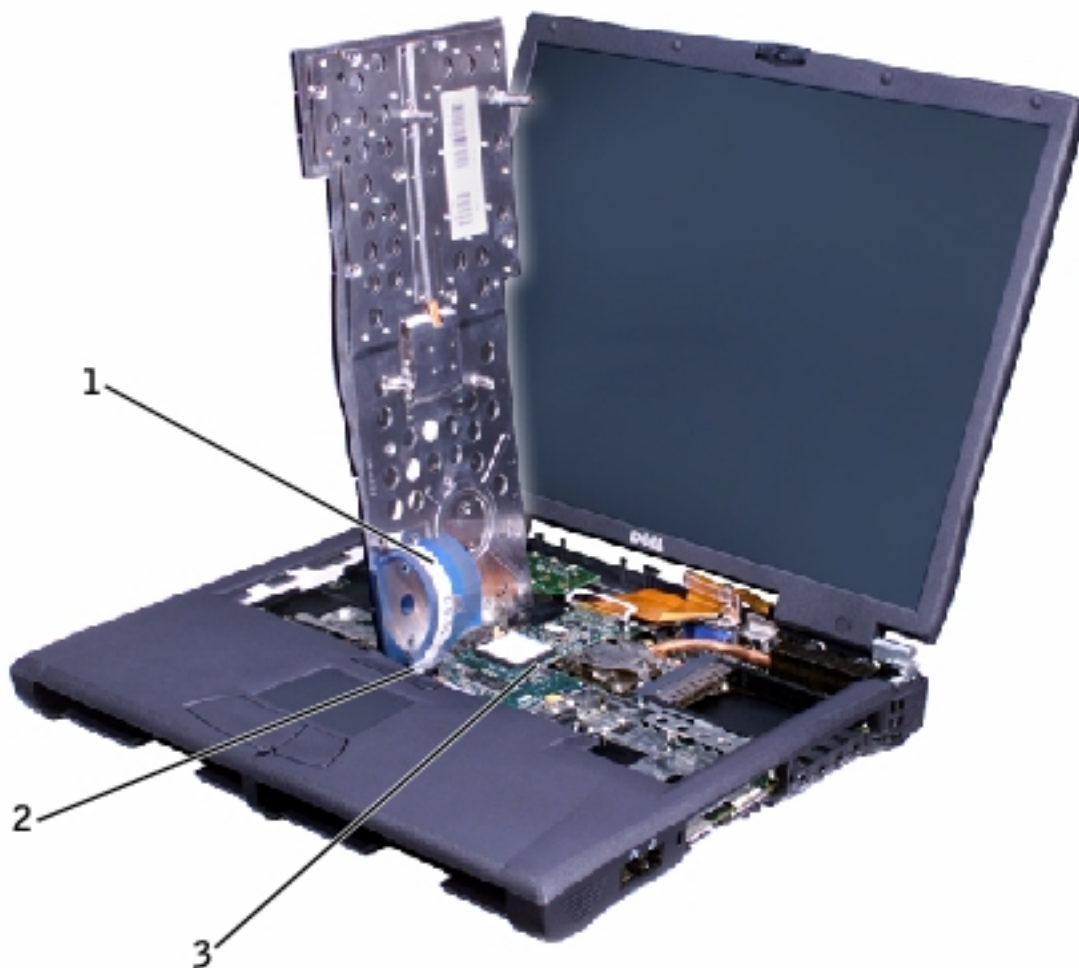

1	keyboard cable
2	keyboard interface connector
3	system board

7. Disconnect the keyboard cable and lay the keyboard aside.

## Replacing the Keyboard

1. While bracing the keyboard upright on its left end, connect the keyboard cable to the keyboard interface connector on the system board.

 **NOTICE:** Position the keyboard/track-stick flex cable so that it is not pinched when you replace the keyboard in the bottom case.

2. Insert the metal tabs at the left end of the keyboard under the edge of the bottom case, and fit the keyboard into place.
3. Check that the keyboard is correctly installed. The keys should be flush with the left and right surfaces of the palm rest.
4. Turn the computer over and reinstall the four M2.5 x 20-mm screws. For extra stability, you can open the computer slightly and brace the keyboard under each screw as you install the screw.

---

[Back to Contents Page](#)

[Back to Contents Page](#)

# Display

## Dell™ Latitude™ C840 Service Manual

- [Display Overview](#)
  - [Hinge Cover](#)
  - [Display Assembly](#)
  - [Display Bezel](#)
  - [Display Panel](#)
  - [Display Latch](#)
- 

## Display Overview

- ➔ **NOTICE:** Disconnect the computer and attached devices from electrical outlets and remove any installed batteries.
- ➔ **NOTICE:** To avoid ESD, ground yourself by using a wrist grounding strap or by periodically touching unpainted metal on the computer.

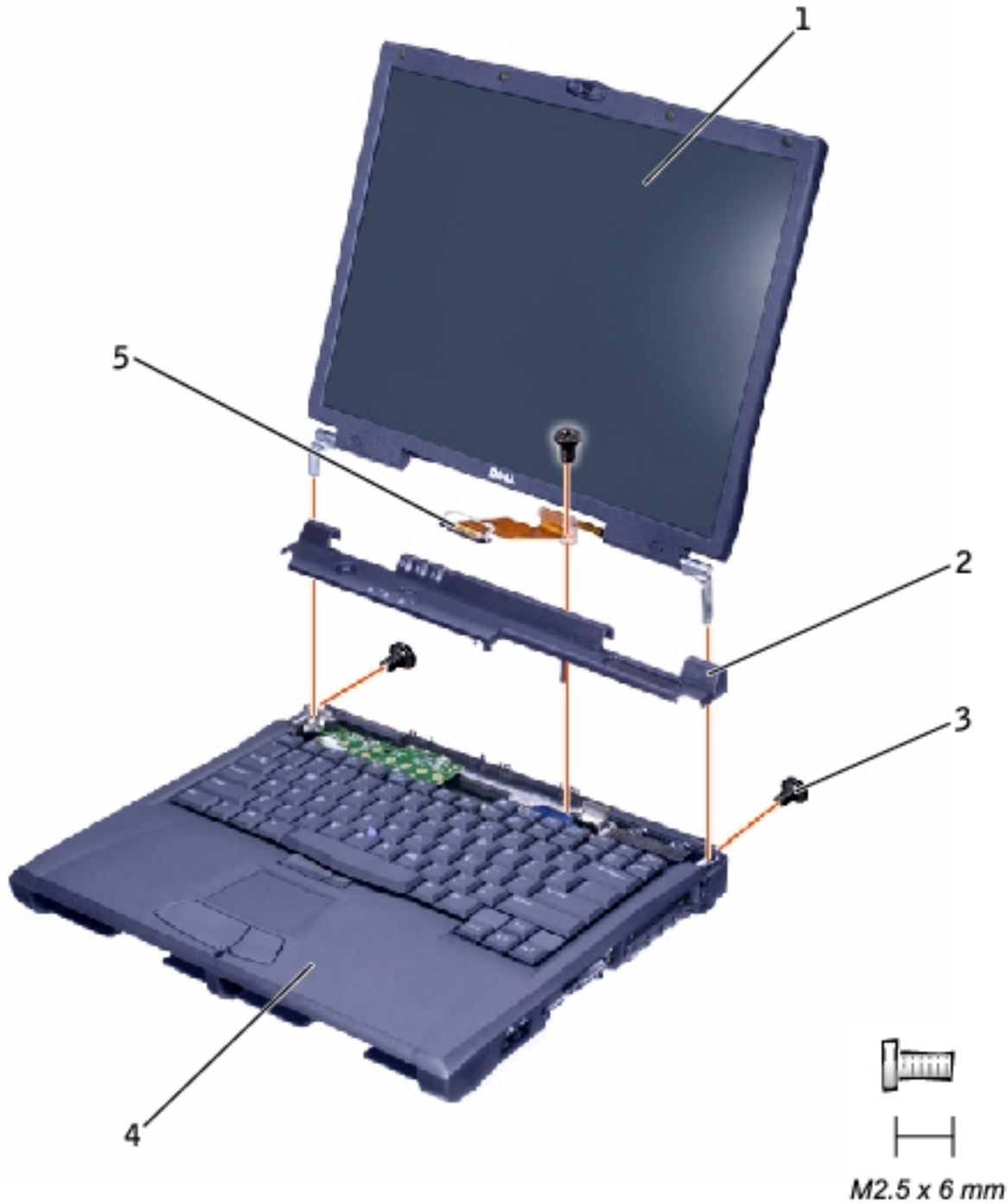

1	display
2	hinge cover
3	M2.5 x 6-mm screws (3)
4	bottom case
5	display flex cable

# Hinge Cover



1	hinge cover
---	-------------

1. Follow the instructions in "[Preparing to Work Inside the Computer.](#)"
2. Use a nonmarring plastic scribe to loosen the hinge cover at the back and at each side of the computer.
3. Open the computer and use the scribe to pry between the  key and the hinge cover until the hinge cover pops off.
4. Open the display and lift off the hinge cover.

---

# Display Assembly



1 M2.5 x 6-mm screws (2)

1. Remove the [hinge cover](#).

➔ **NOTICE:** Remove the display flex cable before you remove the display assembly.

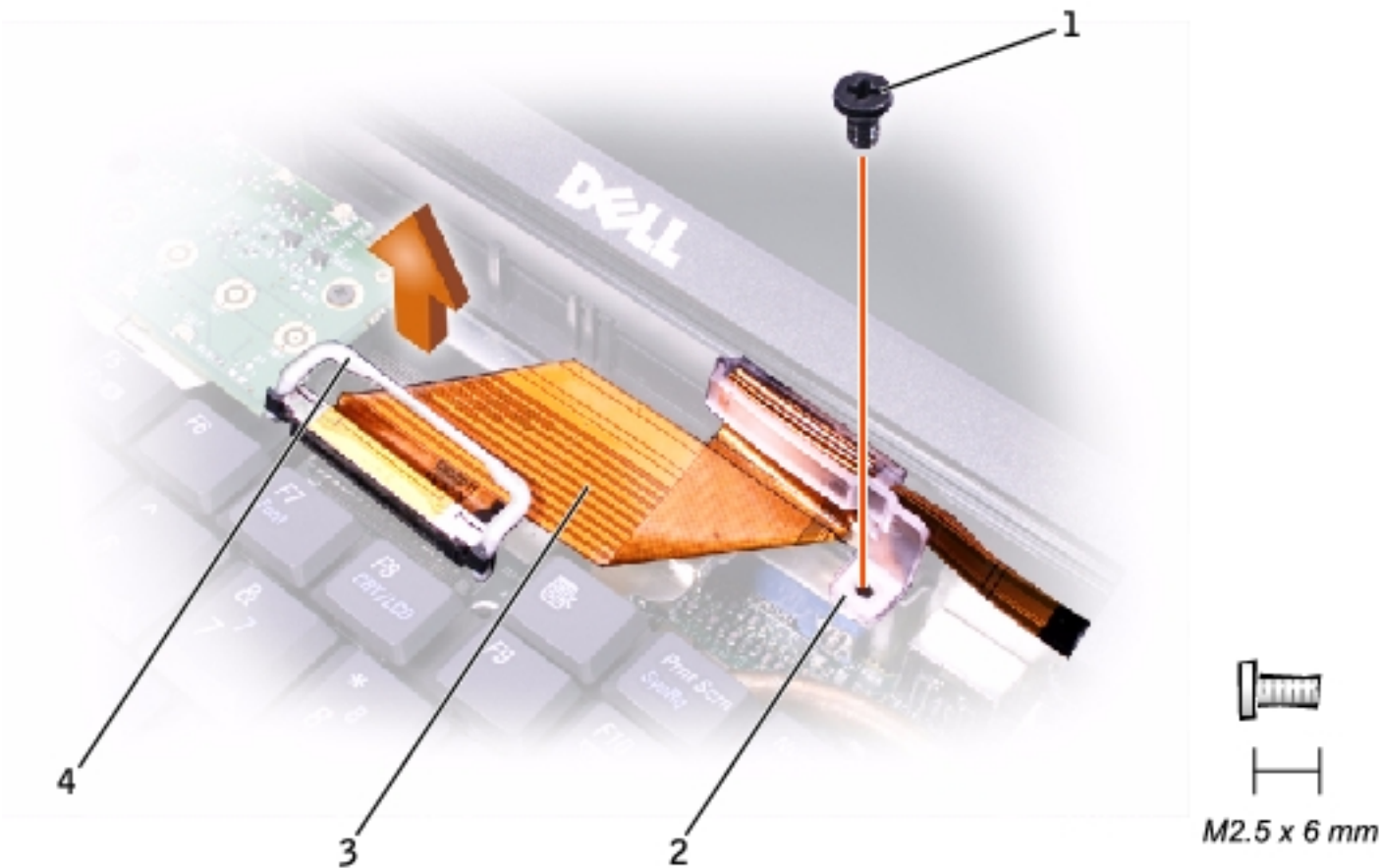

1	M2.5 x 6-mm screw
2	strain relief
3	display flex cable
4	pull loop

- Remove the M2.5 x 6-mm flex-cable strain relief screw, and then use the pull loop to remove the display flex cable from the graphics card.

**NOTICE:** When reconnecting the flex cable, press down on both ends of the connector, not in the middle. Pressing the middle of the connector can damage fragile components.

- Open the display and, from the back of the computer, remove the two M2.5 x 6-mm screws labeled "circle D" that secure the display assembly to the bottom case.
- With the display in an upright position, lift the display assembly from the bottom case.



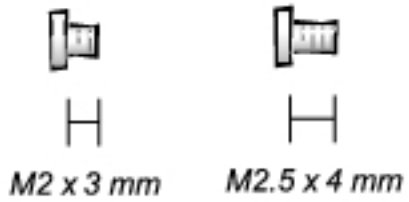
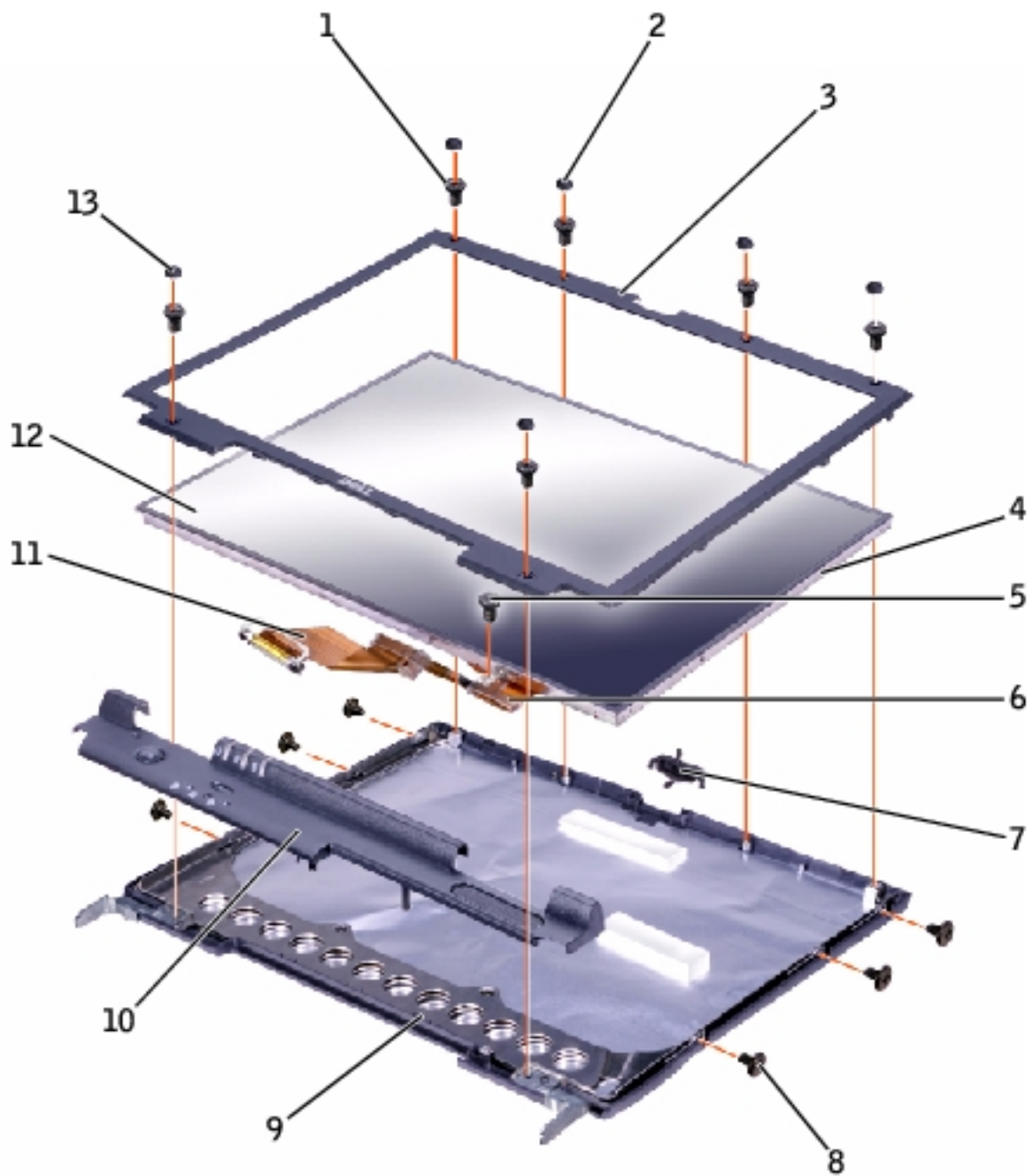

1	M2.5 x 4-mm screws (6)	8	M2 x 3-mm screws (6)
2	rubber screw covers (4)	9	top cover
3	display bezel	10	hinge cover
4	plastic tabs (6)	11	display flex cable
5	M2.5 x 4-mm screw	12	display panel
6	flex-cable mounting bracket	13	plastic screw covers (2)
7	display latch		

## Display Bezel

1. Use a scribe to pry out the four rubber screw covers located across the top of the bezel.
2. Remove the four M2.5 x 4-mm screws located across the top of the bezel.
3. Use a scribe at the indentations to pry out the two plastic screw covers located at the bottom of the bezel.
4. Remove the two M2.5 x 4-mm screws located at the bottom of the bezel.
5. Separate the bezel from the top cover.

The bezel is secured to the top cover with plastic tabs around the sides. Use a plastic scribe to help separate the bezel from the top cover.

## Display Panel

### Removing the Display Panel

1. Remove the [hinge cover](#).

2. Detach the [display flex cable](#) from the strain relief and the graphics card.
3. Remove the [display bezel](#).
4. Remove the M2.5 x 4-mm screw that secures the plastic flex-cable mounting bracket to the top cover.
5. Remove the six M2 x 3-mm screws (three on each side) from the right and left sides of the panel.
6. Lift the display panel and flex cable out of the top cover.
7. Disconnect the flex cable from the two connectors (one ZIF and one standard connector) on the display panel.

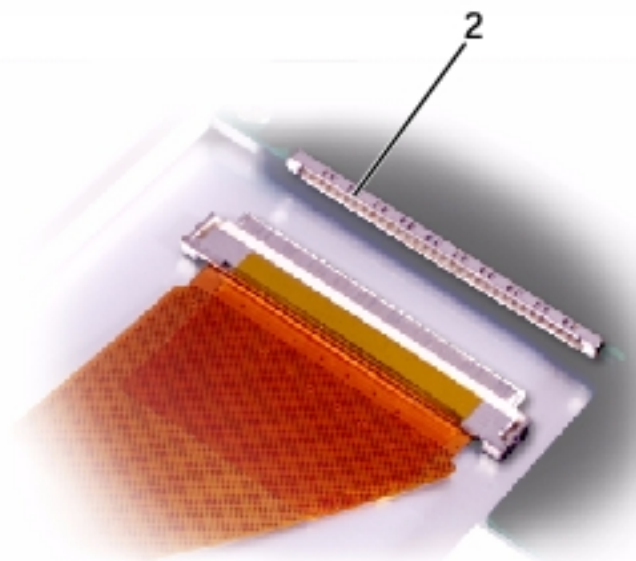
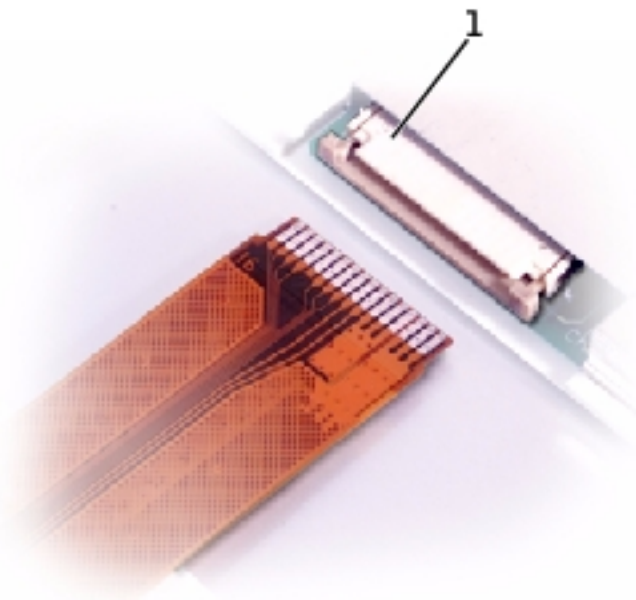

1	ZIF connector
2	standard connector

## Replacing the Display Panel



**NOTE:** Use a magnetic screwdriver to reassemble the display panel in the display.

1. Connect the flex cable to the two connectors on the back of the display panel.
2. Place the display panel in the top cover, taking care that the flex cable is in place and is not crushed or crimped.
3. Reinstall the M2.5 x 4-mm screw that secures the flex-cable mounting bracket to the top cover.
4. Starting on the left side, use a magnetic screwdriver to reinstall the six M2 x 3-mm screws that secure the display panel in the top cover.
5. Reinstall the M2.5 x 6-mm flex-cable strain relief screw, and reconnect the flex cable to the graphics card.
6. Reinstall the display bezel.

---

## Display Latch



1. Remove the [hinge cover](#).
2. Detach the [display flex cable](#) from the strain relief and the graphics card.
3. Remove the [display bezel](#).
4. Remove the [display panel](#) from the top cover.
5. Remove the display latch by disengaging the latch and captive spring.

---

[Back to Contents Page](#)

[Back to Contents Page](#)

# Microprocessor Thermal-Cooling Assembly

## Dell™ Latitude™ C840 Service Manual

- ➔ **NOTICE:** Disconnect the computer and attached devices from electrical outlets and remove any installed batteries.
- ➔ **NOTICE:** To avoid ESD, ground yourself by using a wrist grounding strap or by periodically touching unpainted metal on the computer.

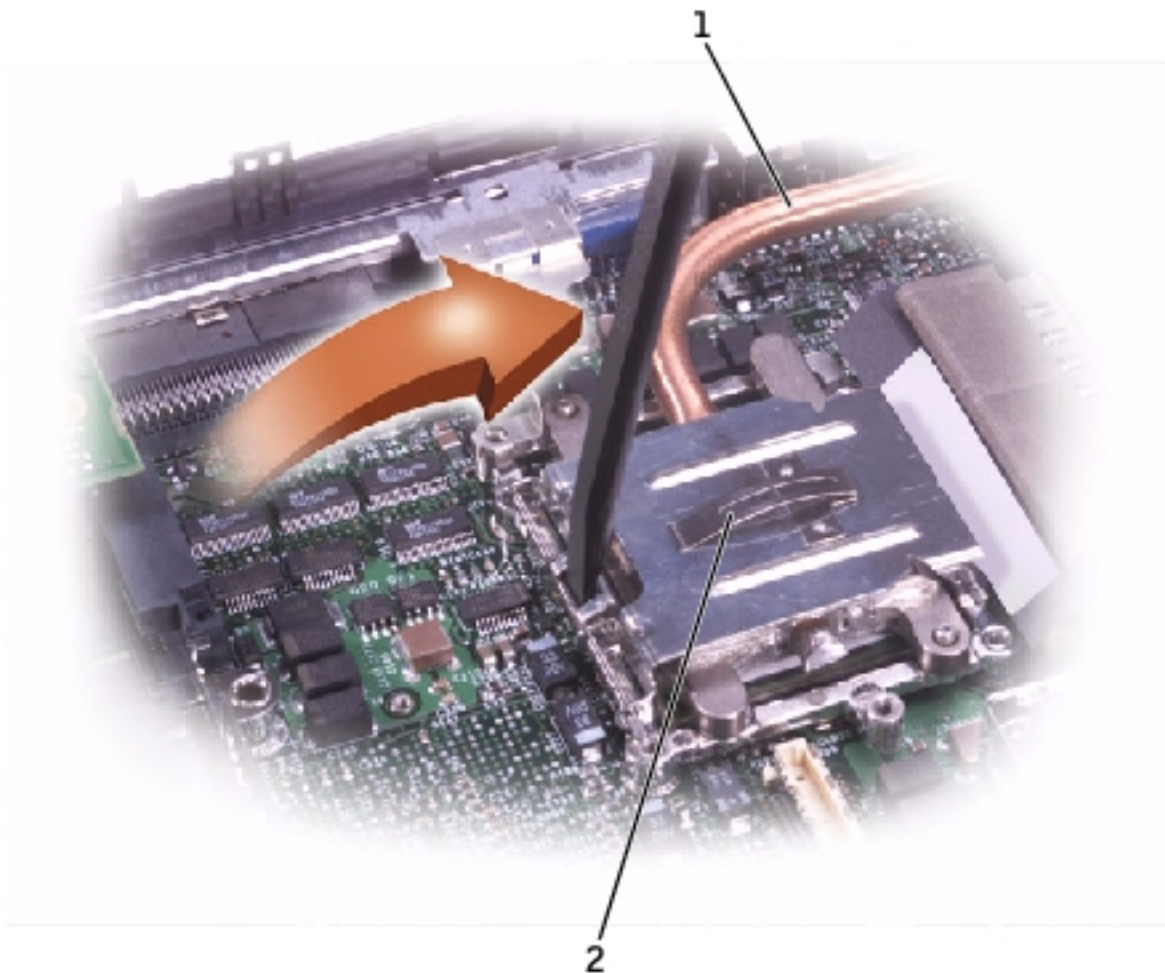

1	microprocessor thermal-cooling assembly
---	---

2	microprocessor retaining clip
---	-------------------------------

## Removing the Microprocessor Thermal-Cooling Assembly

1. Follow the instructions in "[Preparing to Work Inside the Computer.](#)"
2. Remove the [keyboard.](#)
3. Remove the [hinge cover.](#)
4. Insert a non-marring plastic scribe into the latch mechanism at the left side of the microprocessor retaining clip. Pry open the clip by pivoting the top of the screwdriver toward the right side of the computer.

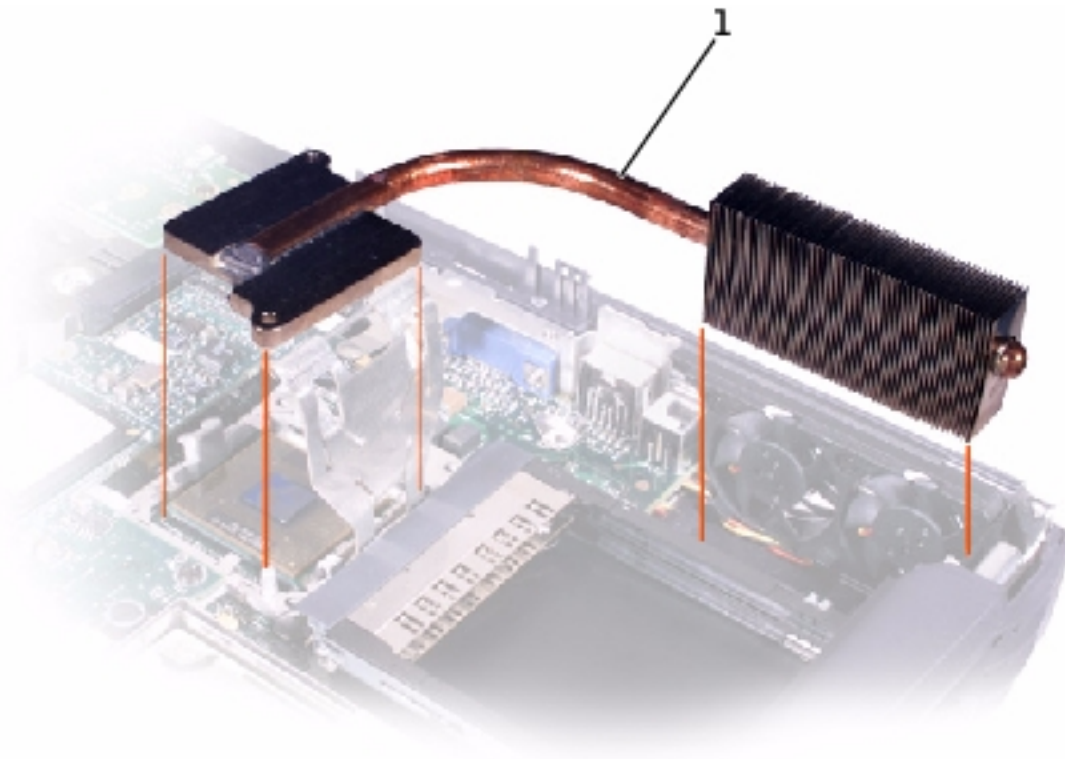

1	microprocessor thermal-cooling assembly
---	---

 **NOTICE:** To ensure maximum cooling for the microprocessor, do not touch the heat transfer areas on the microprocessor thermal-cooling assembly. The oils in your skin reduce the heat transfer capability of the thermal pads.

5. Lift out the thermal-cooling assembly.

---

[Back to Contents Page](#)



[Back to Contents Page](#)

# Microprocessor Module

## Dell™ Latitude™ C840 Service Manual

- ➔ **NOTICE:** Disconnect the computer and attached devices from electrical outlets and remove any installed batteries.
- ➔ **NOTICE:** To avoid ESD, ground yourself by using a wrist grounding strap or by periodically touching unpainted metal on the computer.



## Removing the Microprocessor Module

1. Follow the instructions in "[Preparing to Work Inside the Computer.](#)"
2. Remove the [keyboard](#).
3. Remove the [hinge cover](#).

➡ **NOTICE:** To ensure maximum cooling for the microprocessor, do not touch the heat transfer areas on the microprocessor thermal-cooling assembly. The oils in your skin reduce the heat transfer capability of the thermal pads.

4. Remove the [microprocessor thermal-cooling assembly](#).

➡ **NOTICE:** When removing the microprocessor module, pull the module straight up. Do not bend the pins.

5. Remove the microprocessor module.

➡ **NOTICE:** To avoid damage to the microprocessor, hold the screwdriver so that it is perpendicular to the microprocessor when loosening the cam screw (see "[Microprocessor Cam Screw](#)").

- a. Loosen the cam screw that secures the microprocessor module. The location of the screw and the rotation direction may vary with the socket manufacturer; look for small icons indicating open and locked positions.

### **Microprocessor Cam Screw (Example)**

➡ **NOTICE:** Hold the microprocessor down while turning the cam screw to prevent intermittent contact between the cam screw and microprocessor.

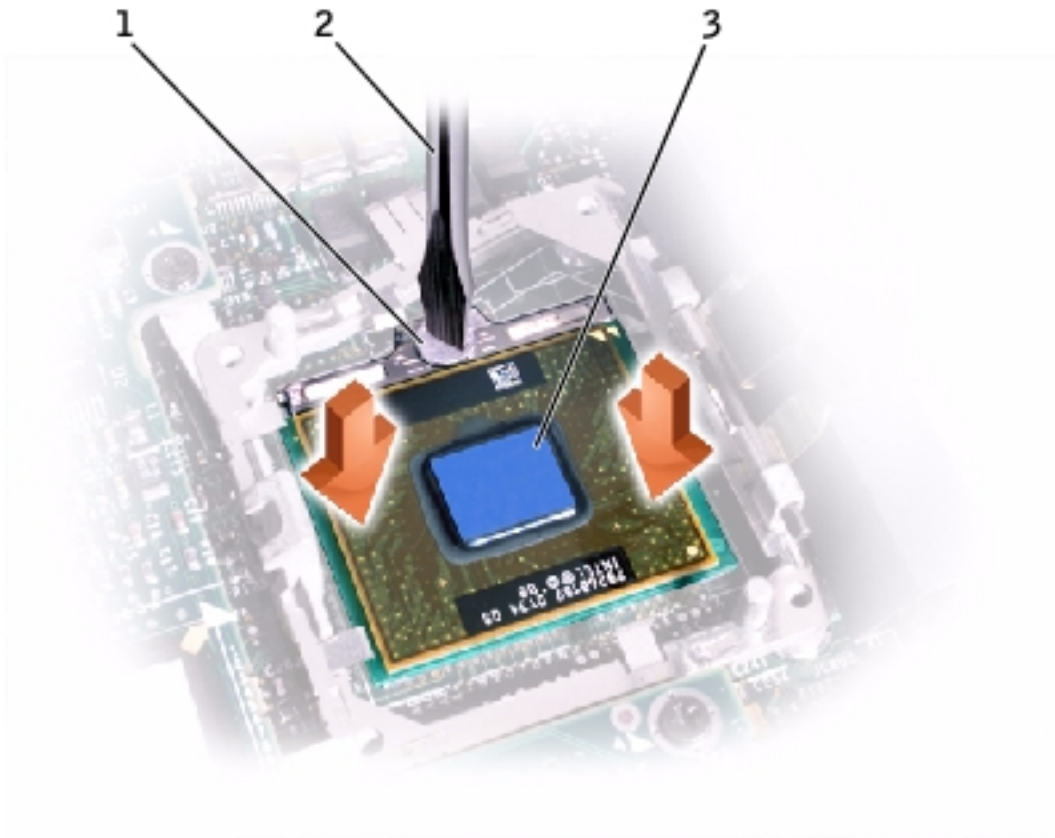

1	cam screw
2	perpendicular screwdriver
3	processor die (do not touch)

- b. Use the microprocessor extraction tool to remove the microprocessor module.

## Replacing the Microprocessor Module

- ➡ **NOTICE:** If you received a flash BIOS update floppy disk or CD with the replacement microprocessor, you must update the BIOS after replacing the microprocessor module.
- ➡ **NOTICE:** Proper seating of the microprocessor module does not require force.
- ➡ **NOTICE:** A microprocessor module that is not properly seated can result in an intermittent connection and subsequent failures.

1. Align the pin-1 triangle on the microprocessor with the pin-1 triangle in the socket, insert the microprocessor into the socket, and move the microprocessor around slightly until you feel it settle into the socket.

When the microprocessor module is correctly seated, all four corners are aligned to the same height. If one or more corners of the module are higher than the others, the module is not seated correctly.

 **NOTICE:** Hold the microprocessor down while turning the cam screw to prevent intermittent contact between the cam screw and microprocessor (see "[Microprocessor Cam Screw](#)").

2. Tighten the cam screw.

 **NOTICE:** Do not over- or undertighten the screw. Tighten the screw until the screw indicator points to the "closed" or "locked" indicator on the socket.

3. Replace the microprocessor thermal-cooling assembly.

## Closing the Microprocessor Retaining Clip

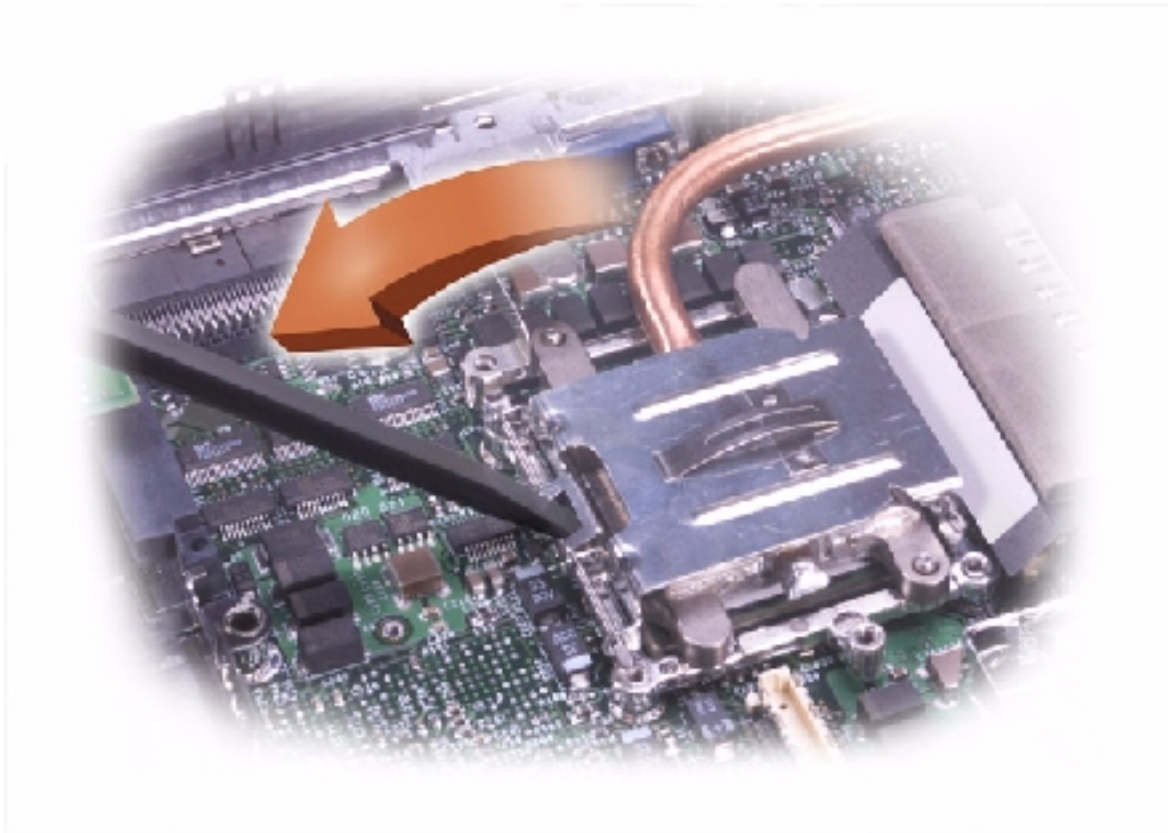

4. Close the microprocessor retaining clip.
5. To latch the clip, insert a flat-blade scribe into the latch mechanism and pivot the top of the scribe away from the clip.

---

[Back to Contents Page](#)

[Back to Contents Page](#)

# Video Graphics Board

## Dell™ Latitude™ C840 Service Manual

- ➔ **NOTICE:** Disconnect the computer and attached devices from electrical outlets and remove any installed batteries.
- ➔ **NOTICE:** To avoid ESD, ground yourself by using a wrist grounding strap or by periodically touching unpainted metal on the computer.

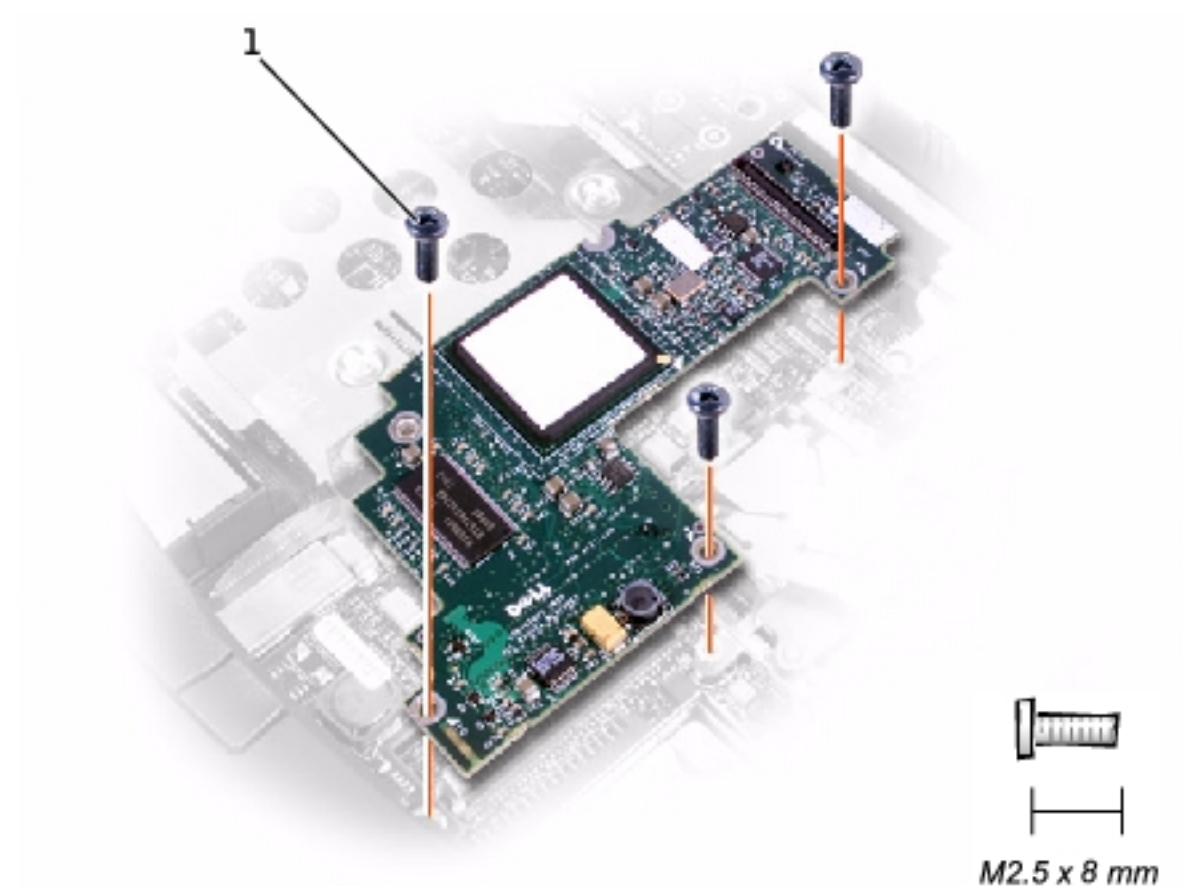

1	M2.5 x 8-mm screws (3)
---	------------------------

## Removing the Video Graphics Board

1. Follow the instructions in "[Preparing to Work Inside the Computer.](#)"
2. Remove the [keyboard](#).

3. Remove the [hinge cover](#).

 **NOTICE:** The video graphics board may have a metallic or cardboard-like EMI shield attached to the top. If present, the EMI shield is removed with the board. Do not reuse the EMI shield on the replacement video board. Newer versions of the board may not require the shield; if a shield is required, it is already attached to the replacement board.

4. Detach the [display flex cable](#) from the graphics card.
5. Remove the three M2.5 x 8-mm screws that secure the video graphics board.
6. Separate the video graphics board from the system board connector.

## Replacing the Video Graphics Board

1. Align the three screw holes and press down firmly on the word "Dell" to seat the board in its connector.

 **NOTICE:** Ensure that the board is correctly and firmly seated before continuing. Failure to do so will cause intermittent video failures.

2. Replace the three M2.5 x 8-mm screws.

---

[Back to Contents Page](#)

[Back to Contents Page](#)

# Palm Rest

## Dell™ Latitude™ C840 Service Manual

- ➔ **NOTICE:** Disconnect the computer and attached devices from electrical outlets and remove any installed batteries.
- ➔ **NOTICE:** To avoid ESD, ground yourself by using a wrist grounding strap or by periodically touching unpainted metal on the computer.

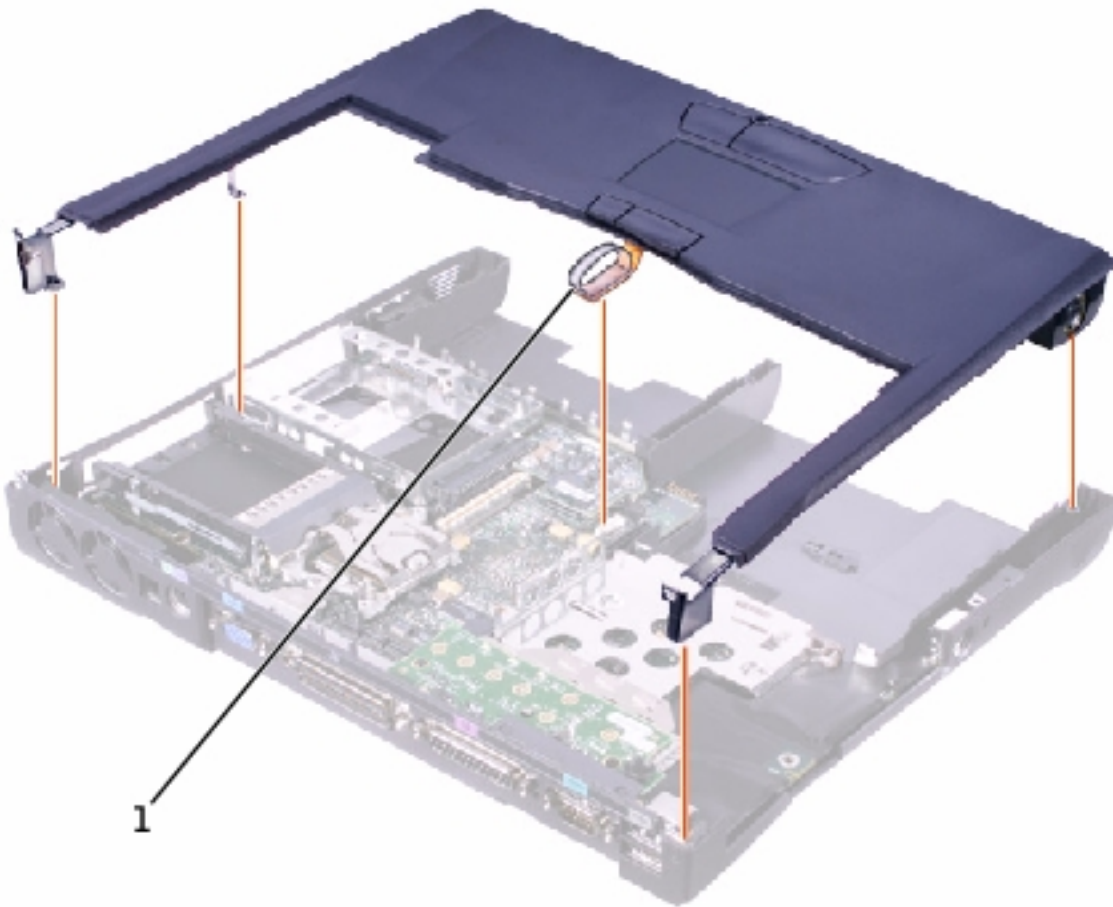

1	pull loop
---	-----------



-  **NOTICE:** The reserve battery provides power to the computer's time RTC and NVRAM when the computer is turned off. Removing the palm rest disconnects the reserve battery and causes the computer to lose the date and time information as well as all user-specified parameters in NVRAM. If possible, copy the information before you disconnect the reserve battery.

## Removing the Palm Rest

1. Follow the instructions in "[Preparing to Work Inside the Computer](#)."
2. Remove the [hard drive](#) and the [fixed optical drive](#).
3. Remove the [keyboard](#).
4. Remove the [hinge cover](#).
5. Remove the [display assembly](#).

-  **NOTICE:** To avoid damaging the palm rest, you must first remove the display assembly.

6. Turn the computer over.
7. Remove the nine M2.5 x 20-mm screws (labeled "circle P") that secure the palm rest to the computer.

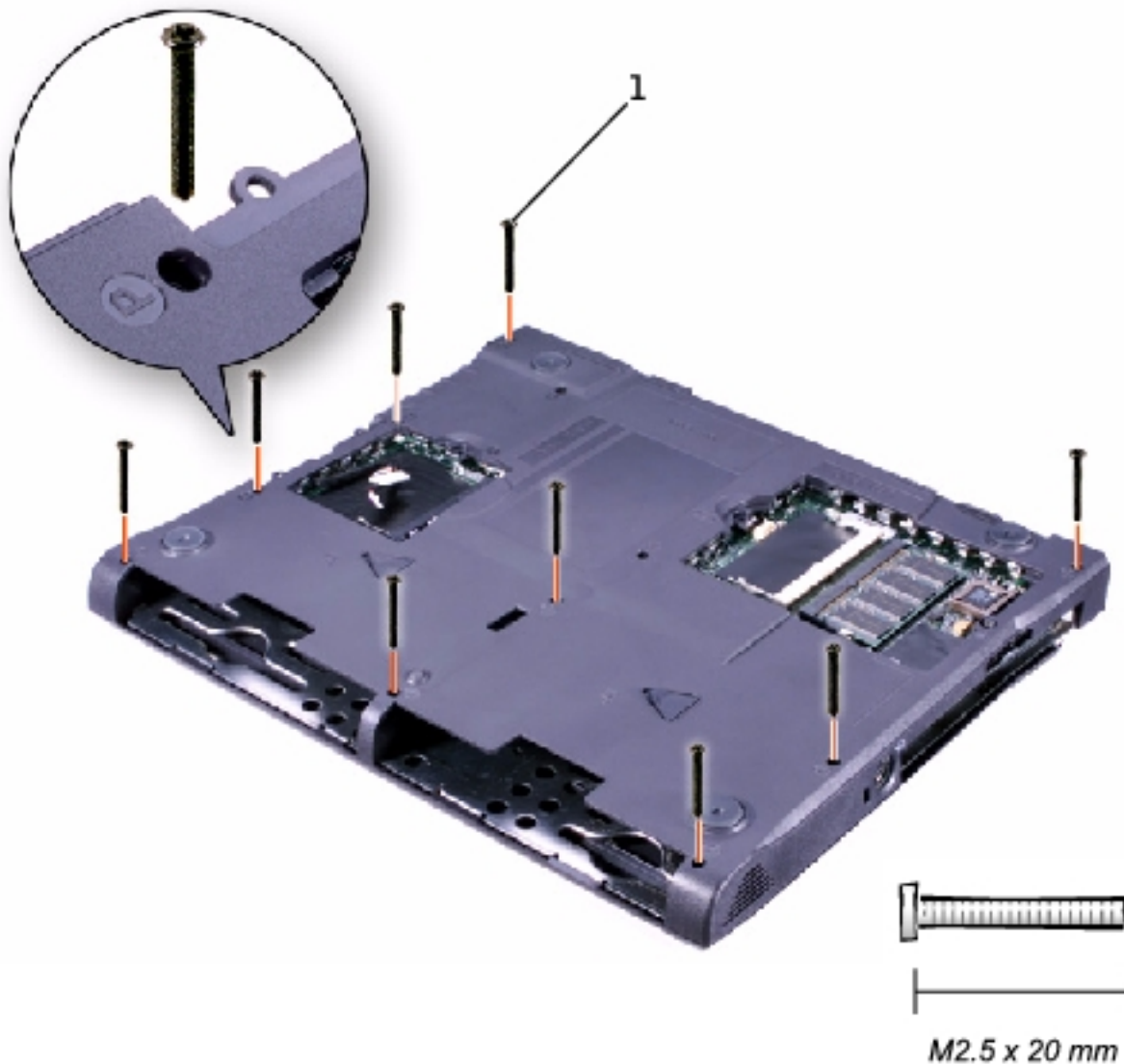

- |   |                            |
|---|----------------------------|
| 1 | M2.5 x 20-mm screws<br>(9) |
|---|----------------------------|

8. Turn the computer over.
9. Use the pull loop to disconnect the palm-rest flex cable from the touch-pad connector on the system board.
10. On the left and right sides of the palm rest, use a flat-blade scribe between the palm rest and the bottom case of the computer to separate the snaps that secure the palm rest to the bottom case.
11. Lift out the palm rest.

# Replacing the Palm Rest

When replacing the palm rest screws, install the two screws at the back corners of the computer first to help align the palm rest correctly.

---

[Back to Contents Page](#)

[Back to Contents Page](#)

# Reserve Battery

## Dell™ Latitude™ C840 Service Manual

- ➔ **NOTICE:** Disconnect the computer and attached devices from electrical outlets and remove any installed batteries.
- ➔ **NOTICE:** To avoid ESD, ground yourself by using a wrist grounding strap or by periodically touching unpainted metal on the computer.

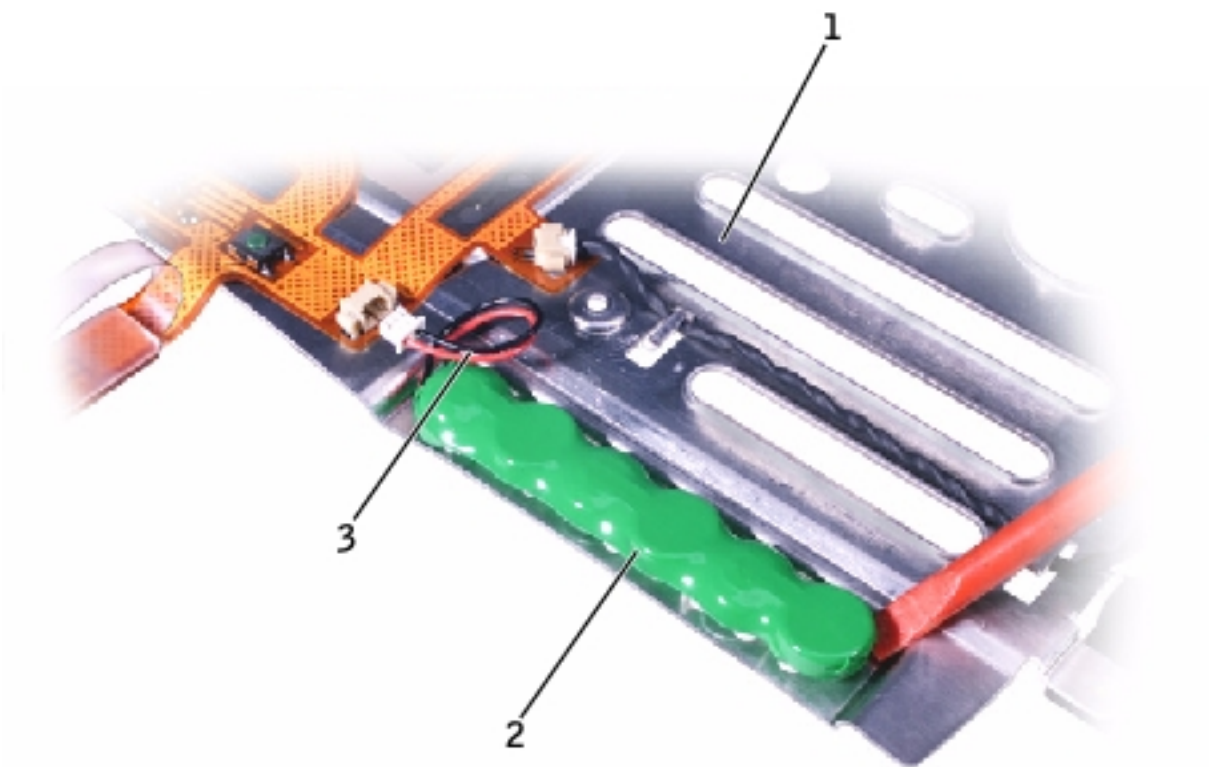

1	palm rest bracket
2	reserve battery
3	reserve battery cable

- ➔ **NOTICE:** The reserve battery provides power to the computer's RTC and NVRAM when the computer is turned off. Removing the battery causes the computer to lose the date and time information as well as all user-specified parameters in NVRAM. If possible, copy the information before you remove the reserve battery.

## Removing the Reserve Battery

1. Follow the instructions in "[Preparing to Work Inside the Computer.](#)"
2. Remove the [keyboard](#).
3. Remove the [hinge cover](#).
4. Remove the [display assembly](#).
5. Remove the [palm rest](#).
6. On the underside of the palm rest, disconnect the palm-rest flex cable from the ZIF connector.

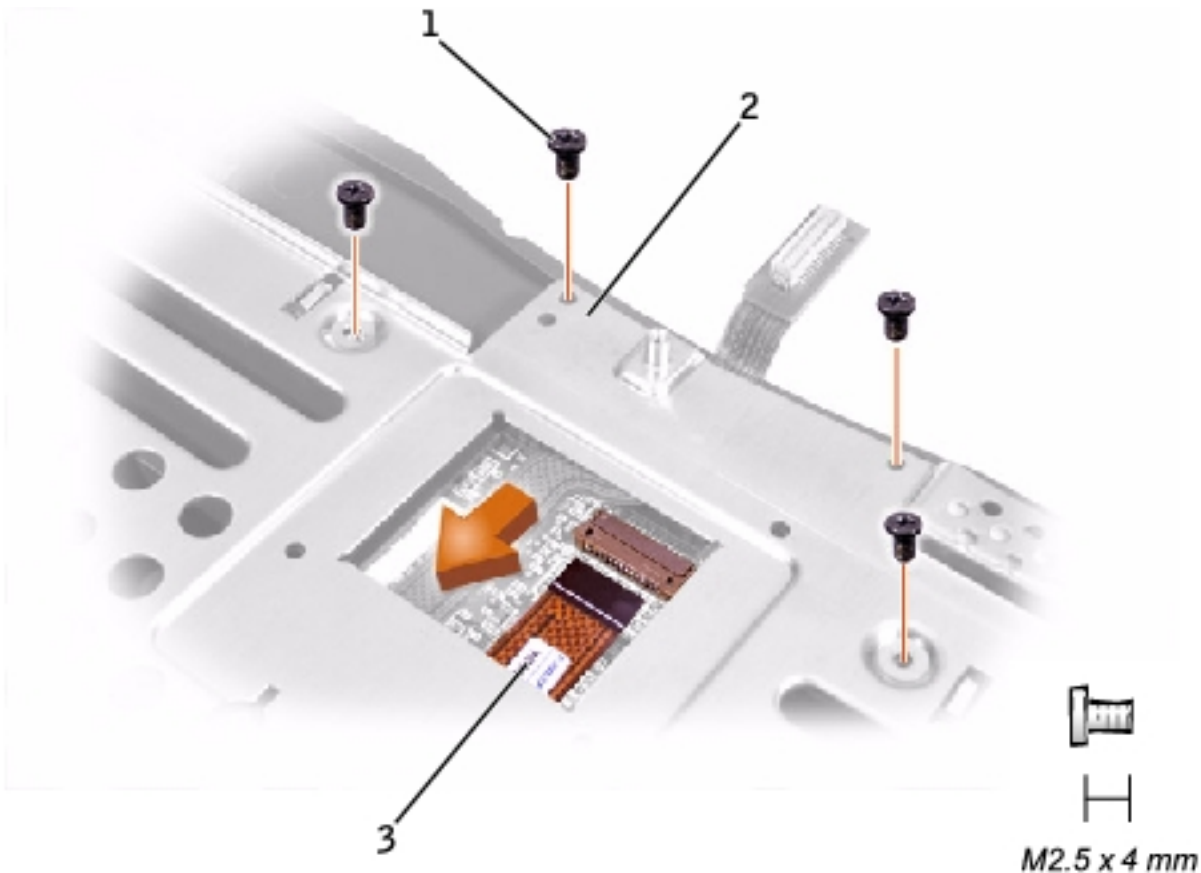

1	M2.5 x 4-mm screws (4)
2	palm rest bracket
3	palm-rest flex cable

7. Remove the four M2.5 x 4-mm screws that secure the palm rest bracket.
8. While supporting the palm-rest flex cable, lift out the palm rest bracket and turn it over.
9. Disconnect the reserve battery cable.
10. Remove the reserve battery:
  - a. Pry the reserve battery free from the metal palm rest bracket.
  - b. Remove the foam-pad remnants from the palm rest bracket.

## Replacing the Reserve Battery

1. Seat the reserve battery and press it into place.
2. Connect the reserve battery cable.
3. Place the palm rest bracket loosely in the palm rest, and connect the palm-rest flex cable to the ZIF connector.
4. Replace the four M2.5 x 4-mm screws that secure the palm rest bracket to the palm rest.

---

[Back to Contents Page](#)

[Back to Contents Page](#)

# System Board

## Dell™ Latitude™ C840 Service Manual

- ➔ **NOTICE:** Disconnect the computer and attached devices from electrical outlets and remove any installed batteries.
- ➔ **NOTICE:** To avoid ESD, ground yourself by using a wrist grounding strap or by periodically touching unpainted metal on the computer.

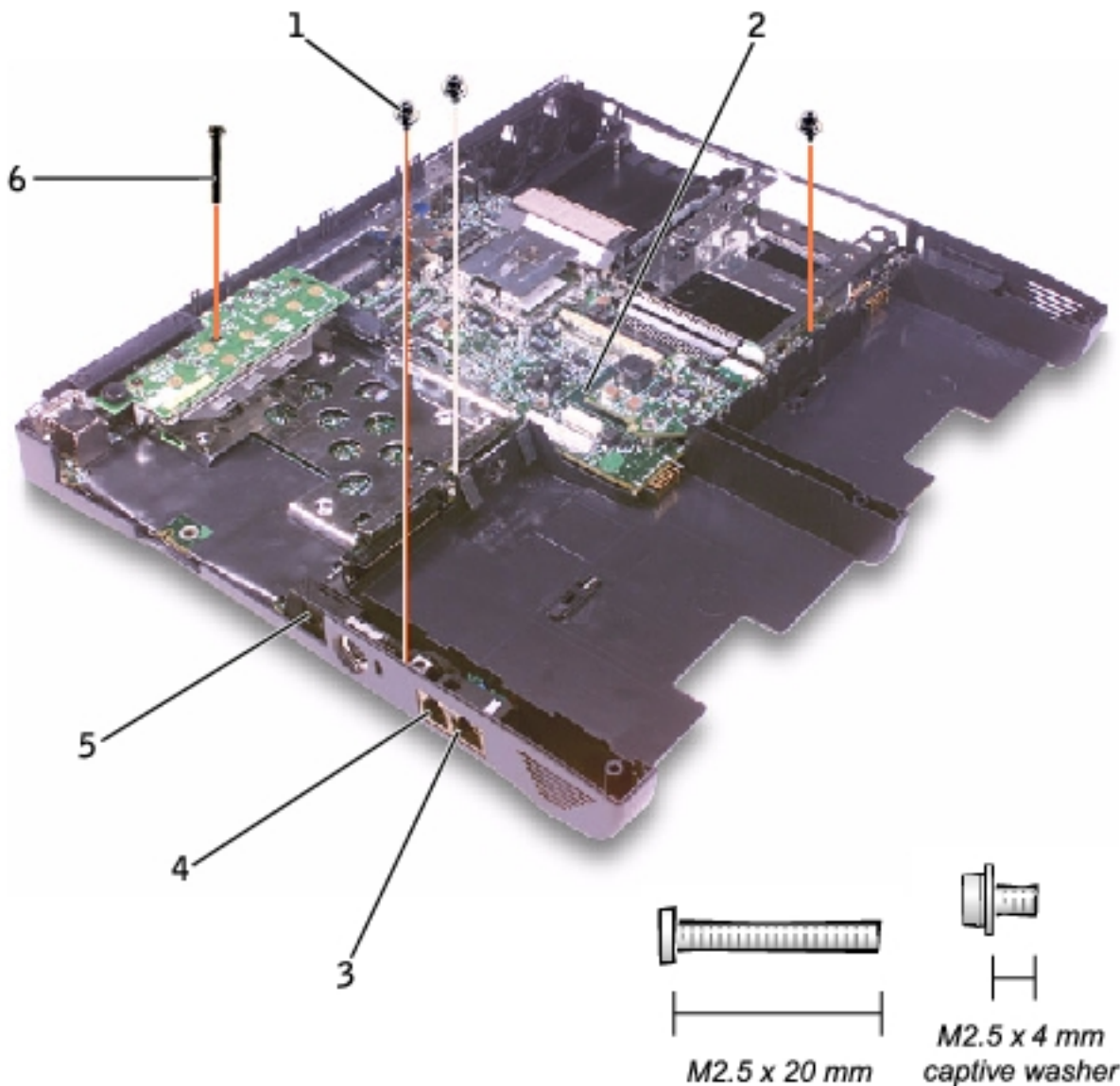

1	M2.5 x 4-mm captive-washer screws (3)
---	---------------------------------------

2	system board
3	network connector
4	modem connector
5	network cable cover
6	M2.5 x 20-mm screw

The BIOS chip on the system board contains the service tag sequence, which is also visible on a bar code label on the bottom of the computer.

The replacement kit for the system board includes a floppy disk or CD that provides a utility for transferring the service tag sequence to the replacement system board.

 **NOTICE:** If you received a flash BIOS update floppy disk or CD with the replacement microprocessor, you must update the BIOS after replacing the microprocessor module.

## Removing the System Board

1. Follow the instructions in "[Preparing to Work Inside the Computer](#)."
2. Remove the [hard drive](#) and the [fixed optical drive](#).
3. Remove any installed [Mini PCI Cards](#).
4. If migrating the memory, remove all installed [memory modules](#).
5. Remove (if migrating) or disconnect the [modem daughter card](#).
6. Remove the [keyboard](#).
7. Remove the [hinge cover](#).
8. Remove the [display assembly](#).
9. Remove the [palm rest](#).
10. Remove the [video graphics board](#).
11. Remove the [microprocessor thermal-cooling assembly](#).



12. If migrating the microprocessor, remove the [microprocessor module](#).
13. Separate the network cable from the system board:
  - a. First remove the network cable cover: Insert a narrow plastic scribe or small screwdriver just barely into the slot that faces the back of the computer (do not insert the scribe far enough to catch on the wires inside), press down on the cover lightly to secure it, and pry upward to release the cover.

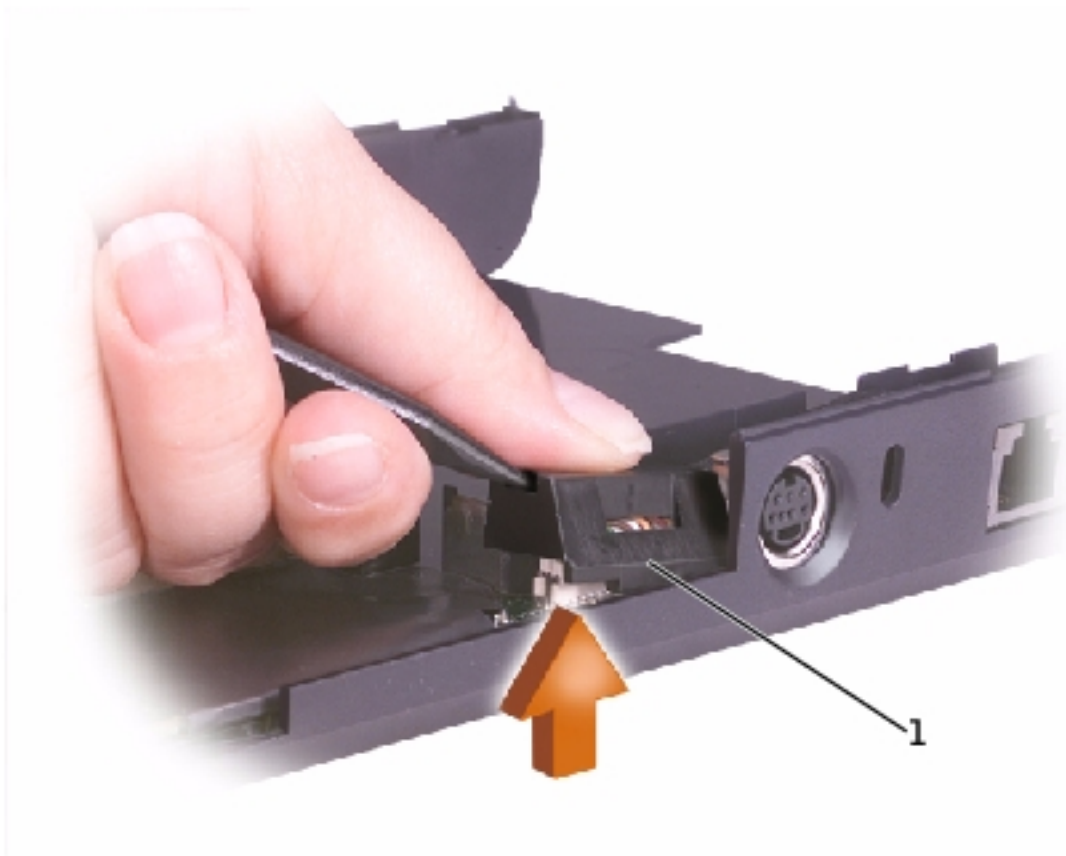

1	network cable cover
---	---------------------

- b. Disconnect the network cable. Do not pull on the cable wires. Instead, pry up the outer corner of the upper connector until the connectors start to separate.

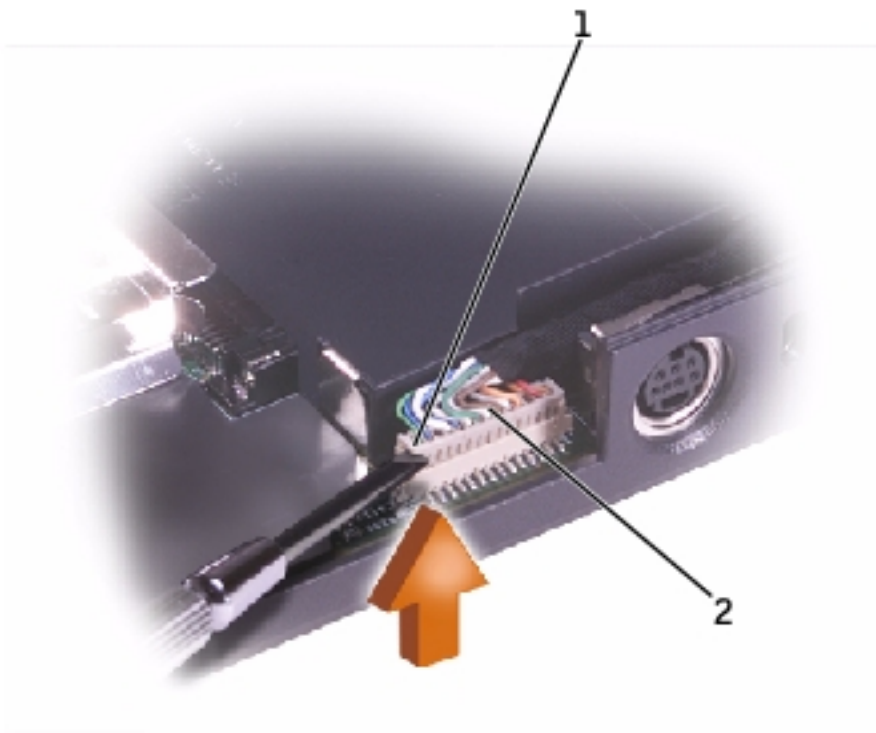

1	outer corner of upper connector
---	---------------------------------

2	network cable
---	---------------

14. Remove the three M2.5 x 4-mm captive-washer screws from the system board.
15. Remove the M2.5 x 20-mm screw from the center of the LED board.
16. Lift the front of the system board and work it out of the back panel.

If necessary to help release the system board, pull outward on the top of the plastic near the back left corner of the bottom case (see the small arrow at the far left in the following figure).

## System Board



---

[Back to Contents Page](#)

[Back to Contents Page](#)

# Battery and Module Bay Latches

## Dell™ Latitude™ C840 Service Manual

- ➔ **NOTICE:** Disconnect the computer and attached devices from electrical outlets and remove any installed batteries.
- ➔ **NOTICE:** To avoid ESD, ground yourself by using a wrist grounding strap or by periodically touching unpainted metal on the computer.

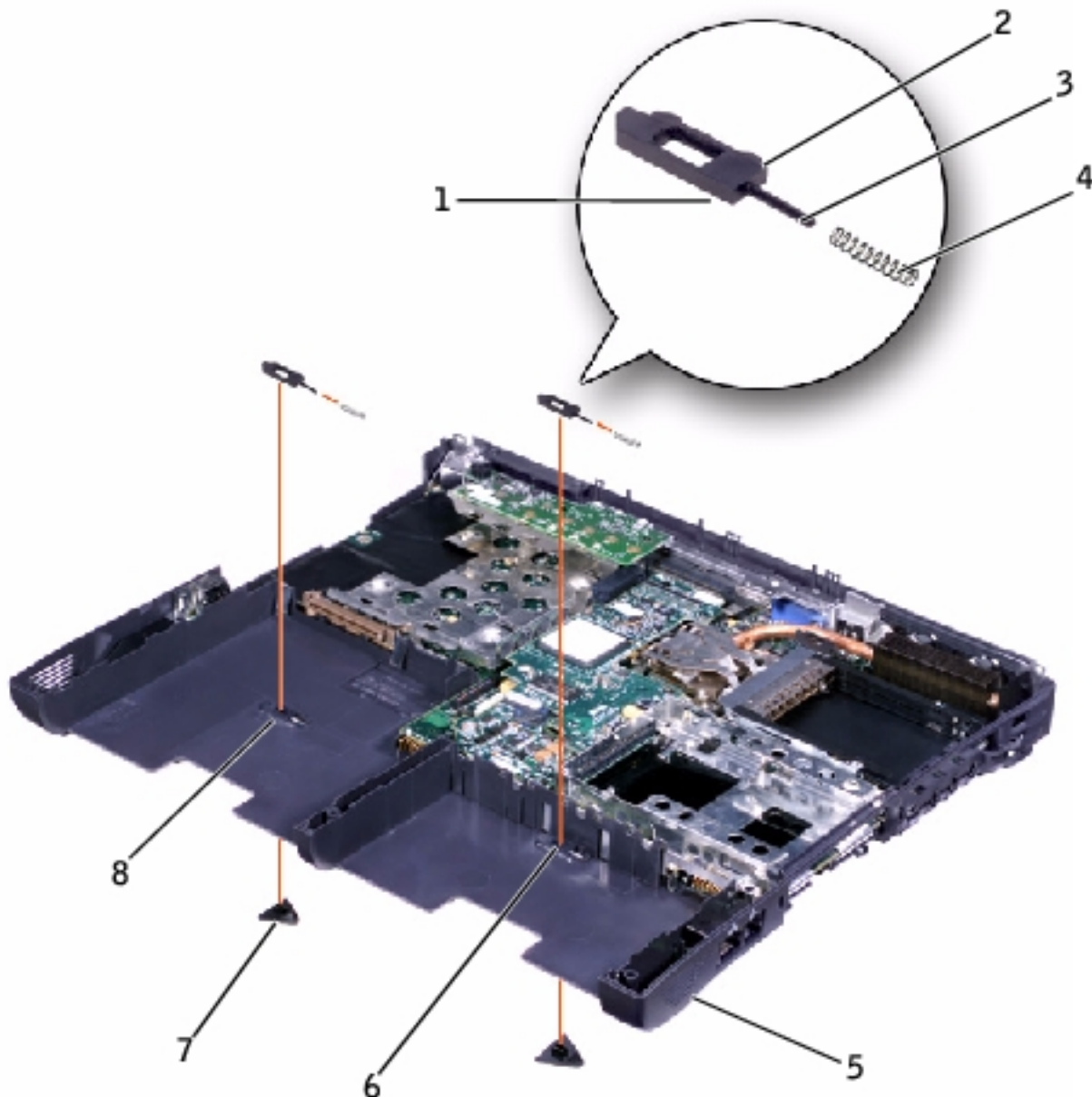

1	wear ribs (2 on underside)
2	bumps
3	slider
4	spring
5	bottom case
6	latch housing (2)
7	latch buttons (2)
8	location of snap tabs (2)

## Removing and Replacing the Battery and Module Bay Latches

1. Follow the instructions in "[Preparing to Work Inside the Computer](#)."
2. Remove the [keyboard](#).
3. Remove the [hinge cover](#).
4. Remove the [display assembly](#).
5. Remove the [palm rest](#).
6. Remove a latch button from the bottom case by squeezing the snap tabs in the center of the latch.

Tape over or hold down the upper latch assembly (spring and slider) to hold the assembly in place. Apply downward pressure to the snap tabs while squeezing them together (tweezers work well) to eject the latch button from the underside of the bottom case without loosening the upper latch assembly. If the upper latch assembly does come loose:

- a. Slide the spring onto the slider, and reinstall both pieces in the latch housing on the inside of the bottom case.

- b. Ensure that the slider is inserted so that the side with the two bumps is facing the back of the bottom case, and the surface with the wear ribs lies against the upper surface of the bottom case.**
  
- 7. Hold the upper latch assembly in place while you snap the new latch button in from underneath the bottom case, making certain the snap tabs are fully engaged in the slider.**

**Ensure that the newly installed latch assembly moves smoothly and freely when pushed and released.**

---

[Back to Contents Page](#)

[Back to Contents Page](#)

# Battery Charger Board

## Dell™ Latitude™ C840 Service Manual

- ➔ **NOTICE:** Disconnect the computer and attached devices from electrical outlets and remove any installed batteries.
- ➔ **NOTICE:** To avoid ESD, ground yourself by using a wrist grounding strap or by periodically touching unpainted metal on the computer.

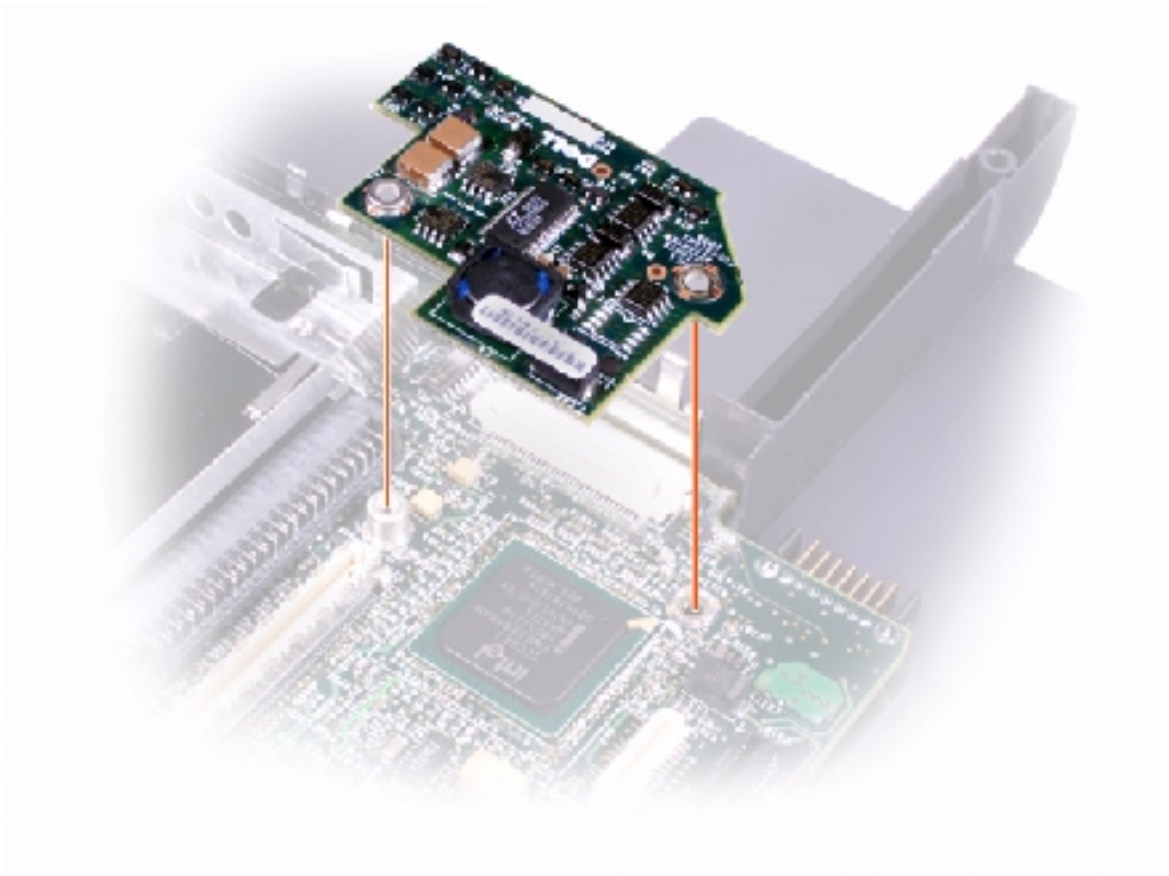

## Removing the Battery Charger Board

1. Follow the instructions in "[Preparing to Work Inside the Computer.](#)"
2. Remove the [keyboard](#).
3. Remove the [hinge cover](#).

4. Remove the [display assembly](#).
5. Remove the [palm rest](#).
6. Remove the [video graphics board](#).
7. Lift the battery charger board out of the system board connector.

## **Replacing the Battery Charger Board**

Align the screw holes on the battery charger board with the screw holes on the bottom case, and then press the battery charger board down into its connector.

---

[Back to Contents Page](#)



[Back to Contents Page](#)

# LED Board

## Dell™ Latitude™ C840 Service Manual

- ➔ **NOTICE:** Disconnect the computer and attached devices from electrical outlets and remove any installed batteries.
- ➔ **NOTICE:** To avoid ESD, ground yourself by using a wrist grounding strap or by periodically touching unpainted metal on the computer.

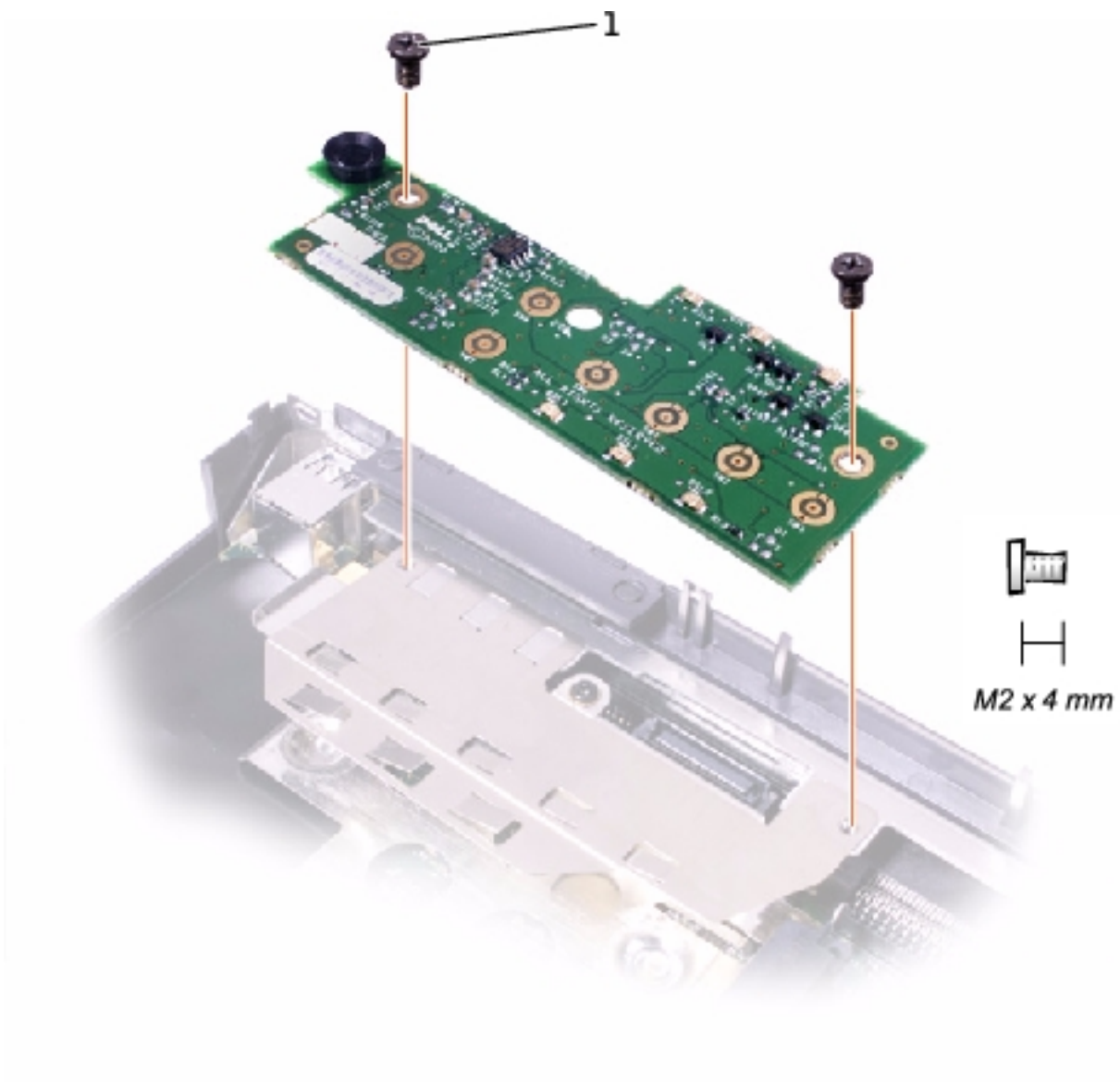

1	M2 x 4-mm screws (2)
---	----------------------

## Removing the LED Board

1. Follow the instructions in "[Preparing to Work Inside the Computer.](#)"
2. Remove the [hinge cover](#).
3. Remove the two M2 x 4-mm screws.
4. Lift the LED board away from its connector.

## Replacing the LED Board

1. Align the two screw holes with the two mounting holes on the bottom case, and press the board into its connector.
  2. Replace the two M2 x 4-mm screws.
- 

[Back to Contents Page](#)

[Back to Contents Page](#)

# Fan

## Dell™ Latitude™ C840 Service Manual

- ➔ **NOTICE:** Disconnect the computer and attached devices from electrical outlets and remove any installed batteries.
- ➔ **NOTICE:** To avoid ESD, ground yourself by using a wrist grounding strap or by periodically touching unpainted metal on the computer.

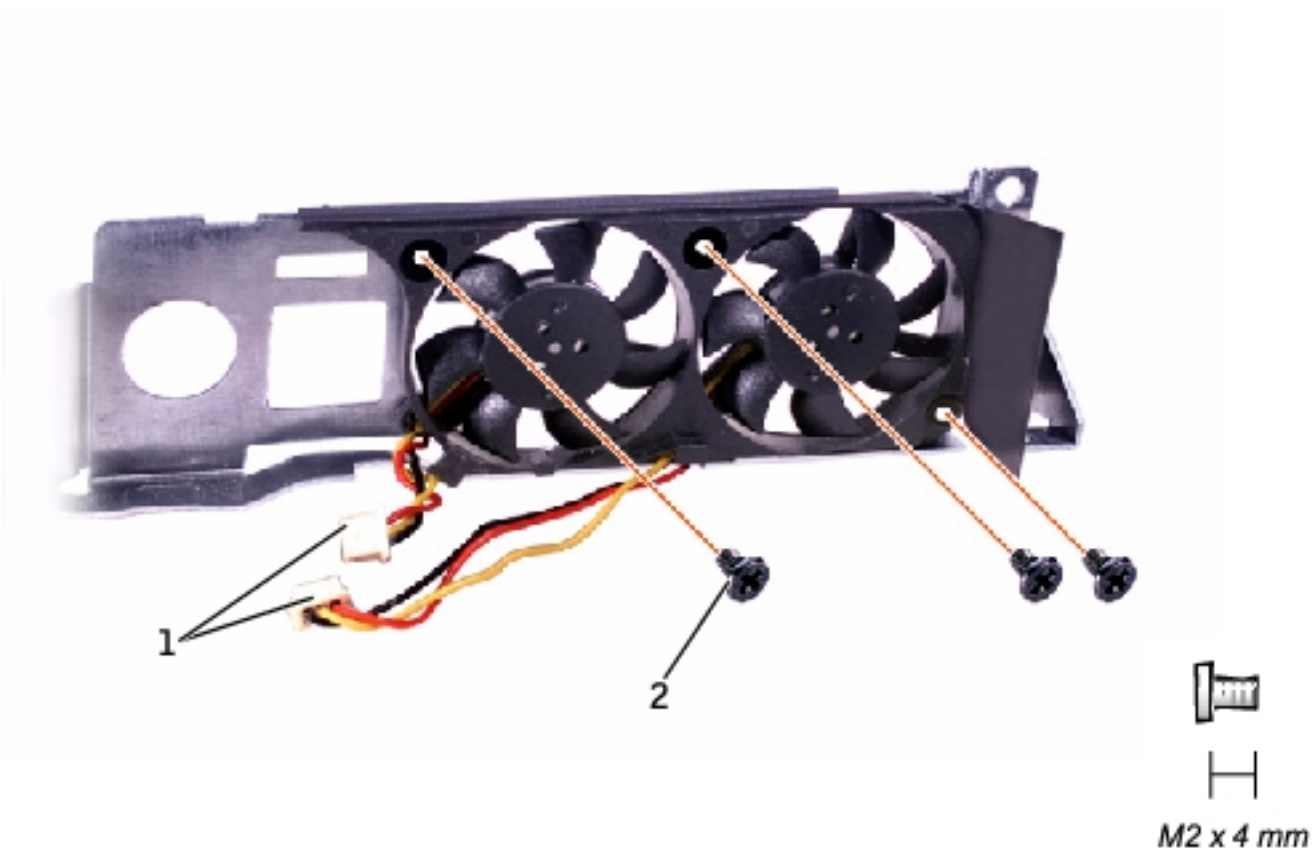

1	fan cables
2	M2 x 4-mm screws (3)

## Removing the Fan

1. Follow the instructions in "[Preparing to Work Inside the Computer.](#)"

2. Remove the [system board](#).
3. Remove the three M2 x 4-mm screws from the fan.
4. Disconnect the two fan cables from the system board.
5. Pull the fan away from the back-panel bracket.



**NOTICE:** When reconnecting the fan cables, connect the shorter cable to the connector closest to the fan. Route both cables so that they will not be pinched by the microprocessor thermal-cooling assembly.



---

[Back to Contents Page](#)

[Back to Contents Page](#)

# RJ- 11 /RJ-45 Module

## Dell™ Latitude™ C840 Service Manual

-  **NOTICE:** Disconnect the computer and attached devices from electrical outlets and remove any installed batteries.
-  **NOTICE:** To avoid ESD, ground yourself by using a wrist grounding strap or by periodically touching unpainted metal on the computer.

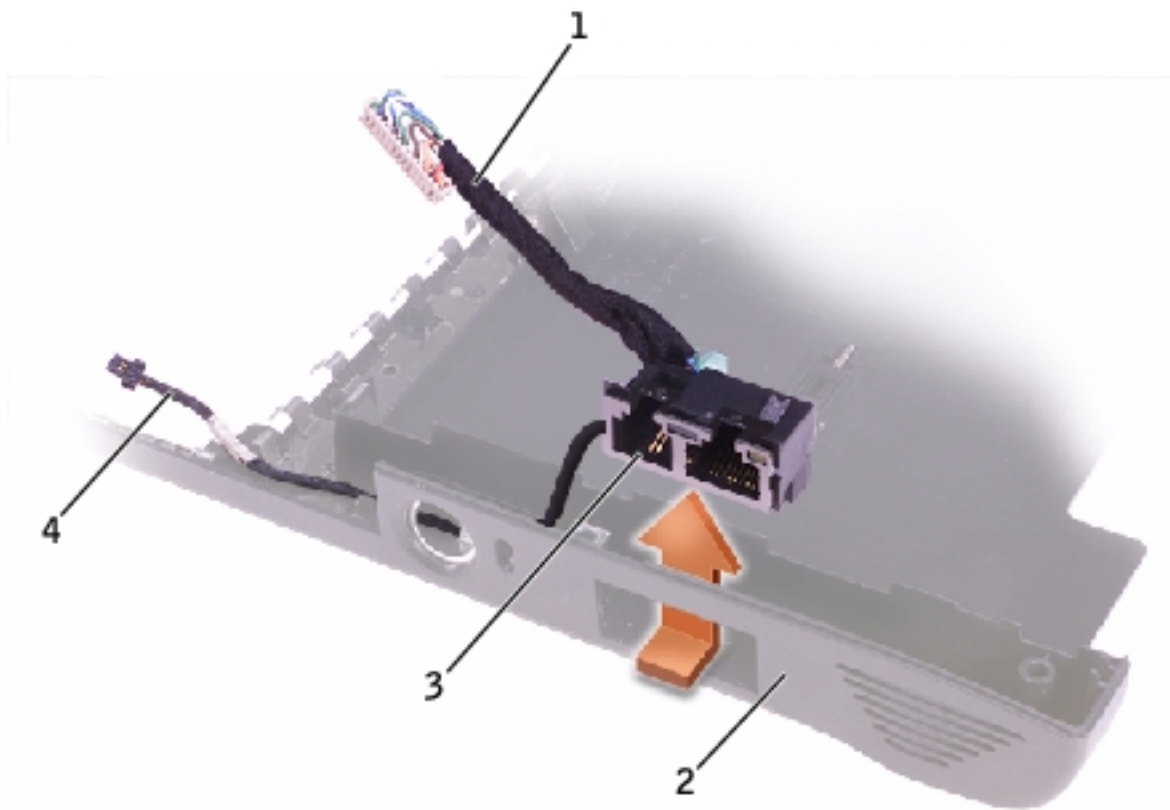

1	network cable
2	bottom case
3	RJ- 11/RJ-45 module
4	modem cable

## Removing the RJ-11/RJ-45 Module

1. Follow the instructions in "[Preparing to Work Inside the Computer](#)."
2. Remove the [system board](#).
3. From outside the bottom case, push in and up on the RJ-11/RJ-45 module while pulling the side of the bottom case slightly outward. When the module disengages, lift it out.

## Replacing the RJ-11/RJ-45 Module

When replacing the RJ-11/RJ-45 module, hold both cables safely out of the way and snap the housing down into place. Then route the modem cable through the vertical slot, through the appropriate posts, and out through the corner of the memory module/modem cutout.

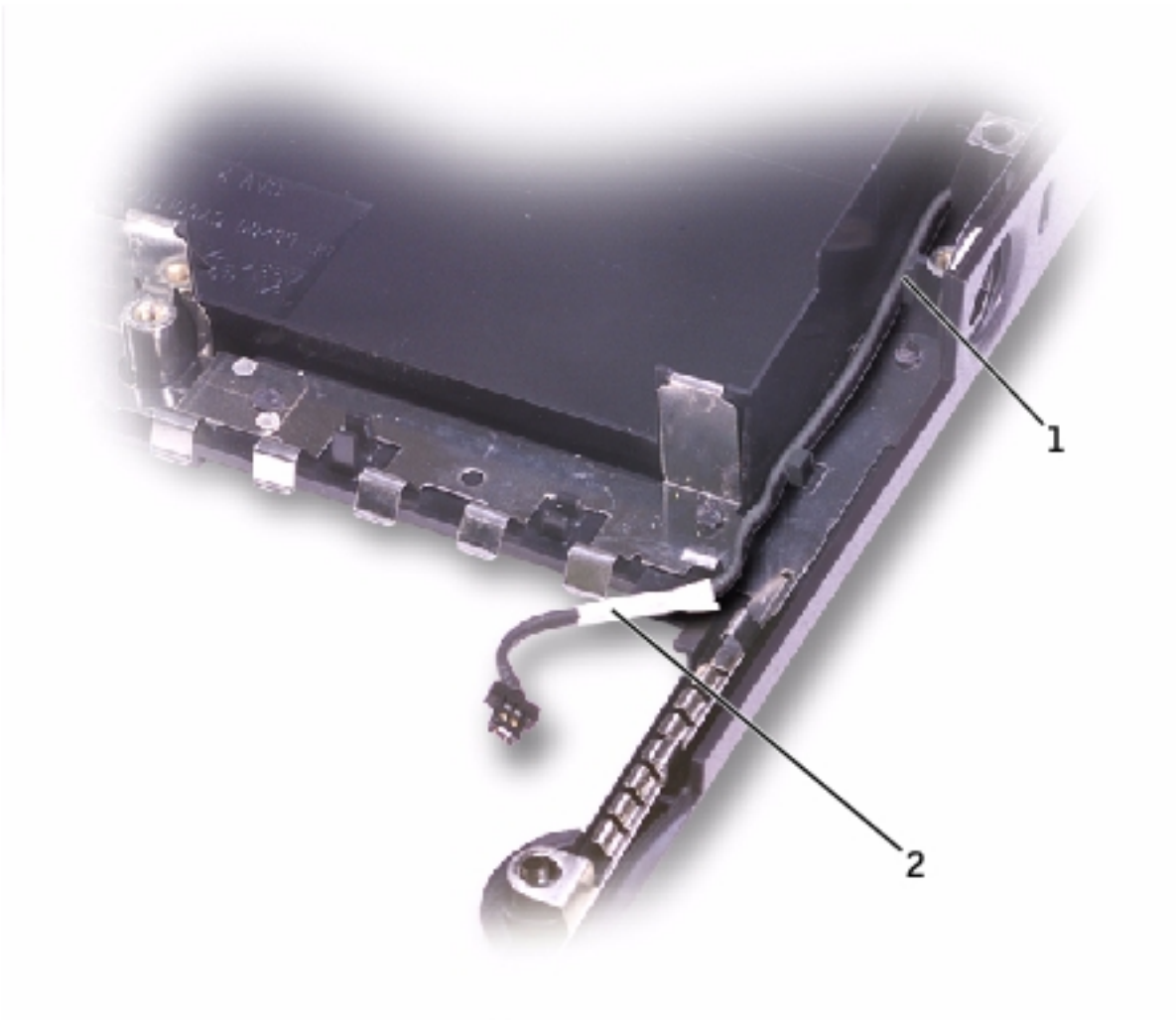

<b>1</b>	<b>vertical slot</b>
<b>2</b>	<b>modem cable</b>

When replacing the system board, ensure that the network cable is safely above the board and out of the way.

---

[Back to Contents Page](#)

[Back to Contents Page](#)

# Pin Assignments for I/O Connectors

## Dell™ Latitude™ C840 Service Manual

### USB Connector

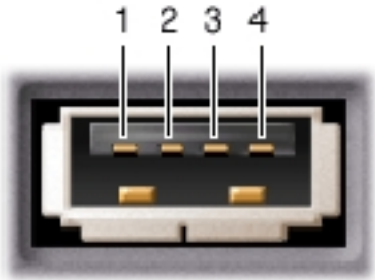

Pin	Signal
1	VCC
2	-Data
3	+Data
4	Ground

### Serial Connector





1 2 3 4 5  
6 7 8 9

Pin	Signal	Pin	Signal
1	DCD	6	DSR
2	RXDA	7	RTS
3	TXDA	8	CTS
4	DTR	9	RI
5	GND		

## Parallel Connector



13 12 11 10 9 8 7 6 5 4 3 2 1  
25 24 23 22 21 20 19 18 17 16 15 14

Pin	Signal	Pin	Signal

1	STRB#	11	BUSY
2	PDO	12	PE
3	PD1	13	SLCT
4	PD2	14	AFDF#
5	PD3	15	ERROR#
6	PD4	16	INIT#
7	PD5F	17	SLCT_IN
8	PD6F	18-23	GND
9	PD7F	24	DFDD/LPT#
10	ACK#	25	GND

## Video Connector



Pin	Signal	Pin	Signal
1	RED	9	CRT_VCC
2	GREEN	10	GND
3	BLUE	11	MSEN#
4	NC	12	DAT_DDC2
5	GND	13	HSYNC

6	GND	14	VSYNC
7	GND	15	CLK_DDC2
8	GND		

## PS/2 Connector

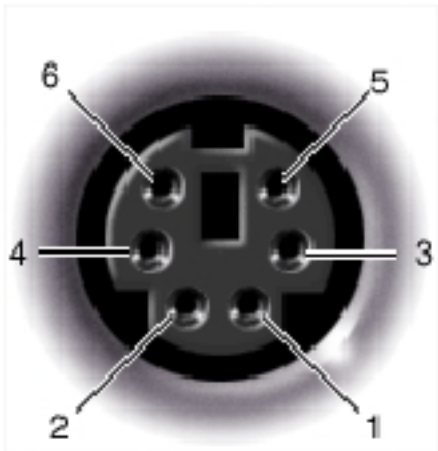

Pin	Signal
1	DAT_KBD
2	DAT_SM1
3	GND
4	PS2VCC
5	CLK_KBD
6	CLK_SM1

## S-Video TV-Out Connector

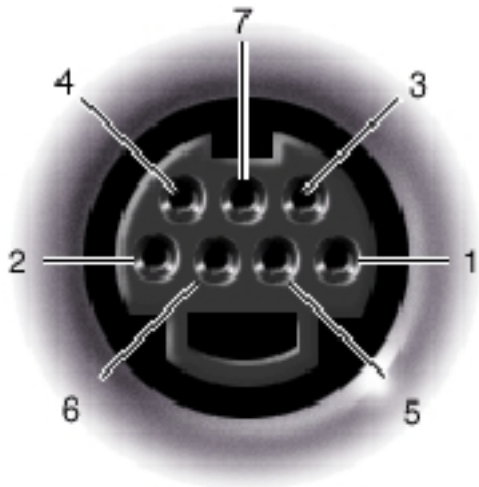

### S-Video

Pin	Signal
1	GND
2	GND
3	DLUMA-L
4	DCRMA-L

### Composite Video

Pin	Signal
5	SPDIF
6	DCMPS-L
7	SPGND

## Docking Connector

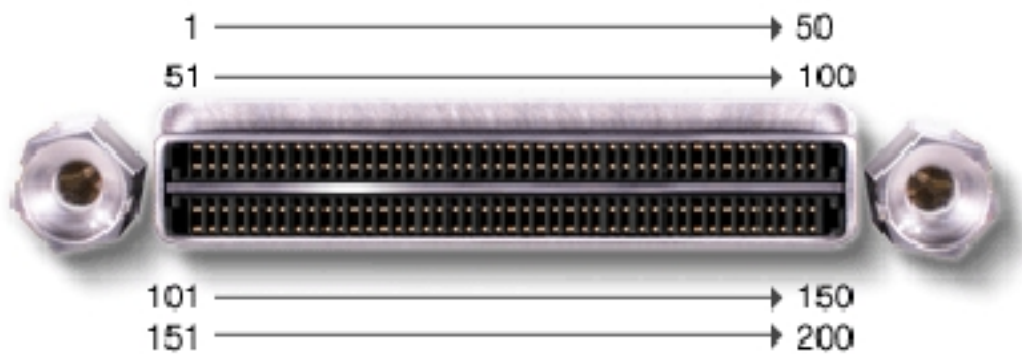

Pin	Signal	Pin	Signal
1	STRB#/5V	101	VGA_GRN
2	PD0	102	GND
3	PD1	103	VGA_RED
4	PD2	104	GND
5	PD3	105	VGA_BLU
6	PD4	106	DOCK_SD/MODE
7	PD5	107	D_IRTX
8	PD6	108	D_IRRX
9	PD7	109	GND
10	GND	110	SPIRQB#
11	DOCK_SPKR	111	SPIRQC#
12	DOCK_MIC	112	DAT_DDC2
13	DOCK_LINE	113	CLK_DDC2
14	DOCK_CDROM	114	SPAR
15	GND	115	SPME#
16	M_SEN#	116	GND
17	POWER_SW#	117	SSERR#

18	QPCIEN#	118	SPERR#
19	S1.6M_EN#	119	SLOCK#
20	DFDD/LPT#	120	SSTOP#
21	GND	121	GND
22	NC	122	SDEVSEL#
23	NC	123	STRDY#
24	D_ATCTLED	124	SIRDY#
25	D_PWRLED	125	SFRAME#
26	DOCK_PWR_SRC	126	SCLKRUN#
27	DOCK_PWR_SRC	127	GND
28	DOCK_PWR_SRC	128	SGNTA#
29	GND	129	SREQA#
30	+5VDOCK	130	SGNT0#
31	+5VDOCK	131	SREQ0#
32	+5VDOCK	132	SPCIRST#
33	+5VDOCK	133	SH1SEL#
34	+5VDOCK	134	GND
35	GND	135	SWRPRT#
36	DOCK_PWR_SRC	136	SDSKCHG#/DRQ
37	DOCK_PWR_SRC	137	SDIR#
38	DOCK_PWR_SRC	138	STRK0#
39	DOCK_PWR_SRC	139	SSTEP#
40	GND	140	SDRV1#
41	DOCK_+DC_IN	141	GND
42	DOCK_+DC_IN	142	SMRT1#
43	DOCK_+DC_IN	143	SWRDATA#
44	DOCK_+DC_IN	144	SWGATE#

45	DOCK_+DC_IN	145	SRDATA#
46	DOCK_+DC_IN	146	SINDEX#
47	DOCK_+DC_IN	147	GND
48	DOCK_+DC_IN	148	NC
49	GND	149	+5VALW
50	LOW_PWR	150	NC
51	HSYNC	151	GND
52	VSYNC	152	CLK_SPCI
53	GND	153	GND
54	DOCKED	154	SAD0
55	USB_VD1+	155	SAD1
56	USB_VD1-	156	SAD2
57	GND	157	SAD3
58	USB_VD2+	158	SAD4
59	USB_VD2-	159	SAD5
60	DOCKOCI#	160	SAD6
61	RUN_ON#	161	GND
62	GND	162	SAD7
63	NC	163	SAD8
64	DOCK_SCLK	164	SC/BE0#
65	DOCK_LRCK	165	SAD9
66	DOCK_MCLK	166	SAD10
67	GND	167	SAD11
68	+12V	168	SAD12
69	AFD#	169	GND
70	ERROR#	170	SAD13
71	ACK#	171	SAD14

72	GND	172	SAD15
73	INIT#	173	SAD16
74	SLCT_IN#	174	SC/BE1#
75	BUSY	175	CD/BE2#
76	PE	176	GND
77	SLCT	177	SAD17
78	GND	178	SAD18
79	DAT_SMB	179	SAD19
80	DCLK_SMB	180	SAD20
81	SMB_INIT#	181	SAD21
82	GND	182	GND
83	DAT_DOCKSM1	183	SAD22
84	CLK_DOCKSM1	184	SAD23
85	DAT_DOCKKBD	185	SAD24
86	CLK_DOCKKBD	186	SC/BE3#
87	GND	187	SAD25
88	RIO	188	GND
89	CTS0	189	SAD26
90	RTS0	190	SAD27
91	DSR0	191	SAD28
92	GND	192	SAD29
93	DTR0	193	SAD30
94	TXD0#	194	SAD31
95	RXD0#	195	GND
96	DCD0	196	NC
97	NC	197	NC
98	+5VSUS	198	NC



99	NC	199	NC
100	NC	200	GND

## IEEE 1394 Connector



Pin	Signal
1	TPB-
2	TPB+
3	TPA-
4	TPA+

---

[Back to Contents Page](#)