



Maintenance and Service Guide

Compaq Armada 110™

Document Part Number: 238850-001

April 2001

This guide is a troubleshooting reference used for maintaining and servicing the notebook. It provides comprehensive information on identifying computer features, components, and spare parts, troubleshooting computer problems, and performing computer disassembly procedures.

© 2001 Compaq Computer Corporation

Compaq, the Compaq logo, Armada, Deskpro Registered in U. S. Patent and Trademark Office.

Microsoft, MS-DOS, Windows, Windows NT are trademarks of Microsoft Corporation in the United States and other countries.

All other product names mentioned herein may be trademarks of their respective companies.

Compaq shall not be liable for technical or editorial errors or omissions contained herein. The information in this document is provided “as is” without warranty of any kind and is subject to change without notice. The warranties for Compaq products are set forth in the express limited warranty statements accompanying such products. Nothing herein should be construed as constituting an additional warranty.

Maintenance and Service Guide

First Edition (April 2001)

Document Part Number: 238850-001

Contents

1 Product Description

1.1 Models and Features	1-1
Models	1-2
Features	1-4
1.2 Security	1-5
1.3 Power Management	1-6
Enabling Power Savings	1-6
Timeout Settings	1-7
Setting Standby	1-7
Hibernation	1-7
Standby	1-8
1.4 Computer External Components	1-9
1.4 Design Overview	1-18

2 Troubleshooting

Using the PhoenixBIOS Setup Utility	2-2
Troubleshooting Flowcharts for Portable Computers ...	2-3
2.1 Initial Troubleshooting	2-4
2.2 No Power, Part 1	2-5
2.3 No Power, Part 2	2-6
2.4 No Power, Part 3	2-7
2.5 No Power, Part 4	2-8
2.6 No Video, Part 1	2-9
2.7 No Video, Part 2	2-10
2.8 Non-Functioning Docking Station (if applicable).....	2-11

2.9 No Operating System (OS) Loading	2-12
2.10 No OS Loading from Hard Drive, Part 1.	2-13
2.11 No OS Loading from Hard Drive, Part 2.	2-14
2.12 No OS Loading from Hard Drive, Part 3.	2-15
2.13 No OS Loading from Diskette Drive.	2-16
2.14 No OS Loading from CD- or DVD-ROM Drive.	2-17
2.15 No Audio, Part 1	2-18
2.16 No Audio, Part 2	2-19
2.17 Non-Functioning Device	2-20
2.18 Non-Functioning Keyboard.	2-21
2.19 Non-Functioning Pointing Device.	2-22
2.20 Network or Modem Connection	2-23

3 Illustrated Parts Catalog

3.1 Serial Number Location	3-1
3.2 Computer System Major Components	3-2
3.3 Plastics Kit Components	3-6
3.4 Hardware Kit Components.	3-7
3.5 Cable Kit Components	3-8
3.6 Mass Storage Devices	3-9
3.7 Miscellaneous.	3-10

4 Removal and Replacement Preliminaries

4.1 Tools Required.	4-1
4.2 Service Considerations.	4-1
Plastic Parts	4-2
Cables and Connectors	4-2
4.3 Preventing Damage to Removable Drives	4-2
4.4 Preventing Electrostatic Damage.	4-4
4.5 Packaging and Transporting Precautions	4-4
4.6 Workstation Precautions	4-5
4.7 Grounding Equipment and Methods	4-6

5 Removal and Replacement Procedures

5.1 Serial Number	5-2
5.2 Disassembly Sequence Chart	5-3
5.3 Preparing the Computer for Disassembly	5-4
5.4 Computer Feet	5-5
5.5 LED Cover	5-6
5.6 Keyboard	5-7
5.7 Optical Drive	5-10
5.8 Display	5-12
5.9 Heat Sink	5-16
5.10 Processor	5-20
5.11 Top Cover.	5-22
5.12 Diskette Drive	5-25
5.13 TouchPad	5-27
5.14 Hard Drive	5-30
5.15 Disk Cell Real Time Clock (RTC) Battery	5-32
5.16 Fan	5-34
5.17 System Board	5-37

6 Specifications

A Connector Pin Assignments

B Power Cord Set Requirements

3-Conductor Power Cord Set	B-1
General Requirements	B-1
Country-Specific Requirements	B-2
Notes	B-3

C Screw Listing

Index

Product Description

1.1 Models and Features

The Compaq Armada 110 Series notebook offers advanced modularity, Intel Pentium III or Intel Celeron processors with 64-bit architecture, industry-leading Accelerated Graphics Port (AGP) implementation, and extensive multimedia support.



Figure 1–1: Compaq Armada 110

Models

Computer models are shown in Table 1-1.

Table 1-1
Compaq Armada 110
Models and Model Naming Conventions

Key										
A11	P	800	4X	10	V	C	128	98	9L	XXXXXX-XXX
1	2	3	4	5	6	7	8	9	10	11
Key	Description				Options					
1	Brand / Series designator				A=Armada			11=110		
2	Processor type				P=Intel Pentium III			C=Intel Celeron		
3	Processor speed				800=800 MHz			700=700MHz		
4	Display type/size/resolution				4=14.x"			X=XGA (1024 x 768)		
					2=12.x"			S=SVGA (800 x 600)		
5	Hard drive size				10=10.0 GB					
6	Optical drive designator				V=8X Max DVD-ROM drive			D=24X Max CD-ROM drive		
7	Integrated communication				M=modem 0 = none			C=modem/NIC combination card		
8	RAM				64=64 MB			12=128 MB		
9	Operating system				8=Windows 98 8m=Windows 98/ME dual install			M=Windows Millennium Edition		
10	Battery cells / type				L=9 cells, Lithium ion			H=9 cells, Nickel Metal Hydride		
11	SKU#									

Table 1-1
Compaq Armada 110
Models and Model Naming Conventions (Continued)

1	2	3	4	5	6	7	8	9	10	11
A11	P	800	4X	10	V	C	64	M	L	226917-B21
A11	P	800	4X	10	D	C	64	M	L	226915-B21
A11	P	800	4X	10	D	C	64	M	L	231665-B21 (NAFTA)
A11	P	800	TS	10	D	C	64	M	L	226918-B21
A11	C	700	TX	10	D	C	64	M	L	231664-B21
A11	C	700	TX	10	D	C	64	M	H	226919-B21
A11	C	700	TS	10	D	M	64	8M	H	226921-B21
A11	C	700	TS	10	D	M	64	8M	H	231663-B21 (NAFTA)

All Compaq Armada 110 computer models use configuration code **JMVZ**.

Features

- Processors, varying by computer model:
 - ❑ 800-MHz Intel Pentium III Processor, with 256-KB integrated cache
 - ❑ 700-MHz Intel Celeron Processor, with 128-KB integrated cache
- ATI RAGE LT Pro, 4-MB SGRAM (synchronous graphics)
- 64-MB high-performance Synchronous DRAM (SDRAM), expandable to 320 MB
- Microsoft Windows 98 or Windows Me preinstalled
- Displays, varying by computer model:
 - ❑ 14.1-inch, SXGA, CTFT (1024 × 768) display, with over 16.8 million colors
 - ❑ 12.1-inch, SVGA, CTFT (800 × 600) display, with over 16.8 million colors
- Full-size TouchPad keyboard
- Mini PCI 56K V.90 modem or mini PCI V.90 modem plus 10/100 NIC combination card, varying by computer model
- One Type II PC Card slot with support for both 32-bit CardBus and 16-bit PC Cards
- External AC adapter with power cord
- 9-cell Lithium ion (Li ion) or Nickel Metal Hydride (NiMH) battery pack
- 10-GB high-capacity hard drive

- Connectors for:
 - stereo speaker/headphone
 - microphone
 - universal serial bus
 - RJ-45 network (internal network models only)
 - RJ-11 modem
 - keyboard/mouse
 - AC power
 - infrared port
- Stereo speakers

1.2 Security

If the notebook you are servicing has a password and you know the password, follow these steps to disable or clear the password:

1. Access PhoenixBIOS Setup Utility (PSU) by turning on the computer and pressing **F10** when the Compaq logo displays on the screen.
2. Enter the current password and press **enter**.
3. Move to **Password On Boot**. Use the + or - key to select **disable** and press **enter**.
4. Move to **Set Supervisor Password**. In the upper space, enter the current password and press **enter**. In the spaces to enter the new password and confirm new password, press **enter**. Press **enter** again to exit the screen.
5. Use the arrow keys to select **Exit** from the menu bar.
6. Make sure **Exit Saving Changes** is selected. Press **enter**, then select **Yes** to save the changes and exit.

If the notebook you are servicing has an unknown password, follow these steps to clear the password. These steps also clear CMOS.

1. Prepare the computer for disassembly. Refer to Section 5.3, “Preparing the Computer for Disassembly,” for more information.
2. Remove the disk cell RTC battery (refer to Section 5.15, “Disk Cell Real Time Clock (RTC) Battery”).
3. Wait approximately five minutes.
4. Reassemble the computer.
5. Connect AC power to the computer. Do **NOT** reinsert the battery pack at this time.
6. Turn on the computer.
7. All passwords and all CMOS settings are clear.

1.3 Power Management

The computer operating system provides power management utilities that help maintain and conserve power when the computer is running on battery power.

To access power management options, select the power application icon in the operating system’s Control Panel.

Enabling Power Savings

The Enable Power Savings feature in Power Management controls all power management features. When set to disabled, the power menu is automatically disabled. The default setting is enabled.

Timeout Settings

Timeout functions can be set up to power down computer components by selecting the Power Schemes tab from the power application in the operating system's Control Panel. When a component such as the monitor, hard drive, system, or video is not in use, the component powers down to conserve power. The time out interval can be set from one minute up to several hours. The component will power up again when you access it or press any key.

Setting Standby

Standby is initiated by pressing the **Fn+F4** hotkeys or automatically by the computer if it reaches the defined percentage of battery pack power remaining. When Standby is initiated, several subsystems will power off to conserve energy. The system will wake up from Standby when a key is pressed. Although the Standby mode maintains the information and opens the file upon wake-up, any unsaved information is lost if the computer is turned off before ending Standby.

Hibernation

Hibernation is an energy-saving feature and safeguard that saves information in RAM to a hibernation file on the hard drive, then shuts down the computer. Hibernation is initiated by the computer when the computer reaches the defined percentage of battery pack power remaining. To wake the computer from Hibernation, press the power button. When you resume work, the information returns to the screen where you left off.

The computer uses the operating system with a power management utility that helps you maintain and conserve power when the computer is running on battery power.

Standby

Standby is an energy-saving feature that conserves power and reduces startup time.

Standby reduces power to system components that are not being used. Standby can be initiated by you or by the system. When Standby is initiated, all work is saved in random access memory (RAM) and the screen is cleared. When work is resumed, the information returns to the screen.

Refer to Section 1.4 in this chapter to identify the Power, Standby, and Hibernation controls.

1.4 Computer External Components

The external components on the display and left side of the computer are shown in Figure 1-2 and described in Table 1-2.



Figure 1–2: Display and Left Side Components

**Table 1-2
Display and Left Side Components**

Item	Component	Function
1	Display release latch	Releases the display to open the computer.
2	Infrared port	Links another IrDA-compliant device for wireless communication.
3	Vent	Allows airflow to cool internal components.
4	PC Card slot	Supports 32-bit (CardBus) and 16-bit PC Cards.
5	PC Card eject button	Ejects a PC Card from the PC Card slot.
6	Diskette drive	Accepts 3.5-inch diskettes.

The computer right side and rear panel components are shown in Figure 1-3 and described in Table 1-3.





Figure 1–3: Right Side and Rear Panel Components

Table 1-3
Right Side and Rear Panel Components

Item	Component	Function
1	Optical drive	Accepts CD- or DVD-ROM disks, depending on the computer model.
2	Security cable slot	Attaches an optional security cable to the computer.
3	Stereo speaker/ headphone jack	Connects stereo speakers, headphones, headset, or television audio.
4	Microphone jack	Connects a single sound channel microphone.

Table 1-3
Right Side and Rear Panel Components (Continued)

Item	Component	Function
5	Keyboard/mouse connector	Connects an optional full-sized keyboard or a mouse. When this connector is used, both the external and computer keyboard and pointing device are active. An optional splitter/adaptor allows both an external keyboard and mouse to be used at the same time.
6	Power jack	Connects any one of the following: <ul style="list-style-type: none"> ■ AC Adapter ■ Optional Automobile Power Adapter/Charger ■ Optional Aircraft Power Adapter
7	RJ-11 jack (internal modem models only)	Connects the modem cable to an internal modem. <p> A modem cable is included with internal modem models.</p>
8	RJ-45 jack (network models only)	Connects the network cable. <p> A network cable is included with network models</p>
9	Universal Serial Bus (USB) connector	Connects USB devices.
10	Vent	Allows airflow to cool internal components.
11	Serial connector	Connects a serial device.
12	External monitor connector	Connects an external monitor or overhead projector.
13	Parallel connector	Connects a parallel device.

The computer keyboard components are shown in Figure 1-4 and described in Table 1-4.



Figure 1–4: Keyboard Components

Table 1-4
Keyboard Components

Item	Component	Function
1	Fn key	Used with hotkeys to perform preset hotkey functions.
2	Caps lock key	Turns on the caps lock function.
3	F1 through F12 function keys	Perform preset functions.
4	Display switch	Turns off the computer display if the computer is closed while on.
5	Embedded numeric keypad	Converts keys to numeric keypad.
6	Cursor control keys	Move the cursor around the screen.
7	Windows application keys	Displays a menu when using a Microsoft application. The menu is the same that is displayed by pressing the right mouse button.
8	Microsoft logo key	Displays Windows Start menu.

The components on the top of the computer are shown in Figure 1-5 and described in Table 1-5.



Figure 1-5: Top Components

**Table 1-5
Top Components**

Item	Component	Function
1	Speakers (2)	Produce stereo sound.
2	Hard drive light	On: The primary hard drive is being accessed.

Table 1-5
Top Components (Continued)

Item	Component	Function
3	Battery light	Green steady: Battery charging is complete. Red steady: Battery pack is charging. Red blinking: Battery pack is being queried, computer cannot communicate with battery pack, or battery pack is bad.
4	Num lock light	On: Num lock is on and the embedded numeric keypad is enabled.
5	Caps lock light	On: Caps lock is on.
6	Scroll lock light	On: Scroll lock is on.
7	Power button	Turns the computer on or off or exits Standby.
8	Easy Access buttons (4)	Four buttons that provide quick access to the Internet.
9	Microphone	Inputs single-channel sound to the computer; can be used whether the computer is open or closed.
10	Right TouchPad button	Functions like the right mouse button on an external mouse.
11	TouchPad	Moves the mouse cursor, selects, and activates.
12	Left TouchPad button	Functions like the left mouse button on an external mouse.

The external components on the bottom of the computer are shown in Figure 1-6 and described in Table 1-6.



Figure 1–6: Bottom Components

Table 1-6
Bottom Components

Item	Component	Function
1	Mini PCI slot cover	Contains the mini PCI modem or network interface card.
2	Fan vent	Provides airflow to cool internal components.
3	Certificate of Authenticity label	Contains the Product Key, which may need to be entered before using some Windows operating systems.
4	Memory expansion compartment	Covers the memory expansion compartment.
5	Front label area	Contains agency information.
6	Battery compartment	Accepts a 9-cell Lithium ion (Li ion) or Nickel Metal Hydride (Ni MH) battery pack.
7	Battery release latch	Releases the battery pack from the battery bay.
8	Serial number	Identifies the computer.

1.4 Design Overview

This section presents a design overview of key parts and features of the computer. Refer to Chapter 3, “Illustrated Parts Catalog” and Chapter 5, “Removal and Replacement Procedures.”

The system board provides the following device connections:

- Memory expansion board
- Hard drive
- Display
- Keyboard/TouchPad
- Audio
- Intel Pentium III or Intel Celeron Processors
- Fan
- PC Card
- Modem or modem/NIC
- Microphone

The computer uses an electrical fan for ventilation. The fan is controlled by a temperature sensor and is designed to turn on automatically when high temperature conditions exist. These conditions are affected by high external temperatures, system power consumption, power management/battery conservation configurations, battery fast charging, and software applications. Exhaust air is displaced through the ventilation grill located on the right side of the computer.



CAUTION: To properly ventilate the computer, allow at least a 3-inch (7.6 cm) clearance on the left and right sides of the computer.

Troubleshooting



WARNING: Only authorized technicians trained by Compaq should repair this equipment. All troubleshooting and repair procedures are detailed to allow only subassembly/module level repair. Because of the complexity of the individual boards and subassemblies, no one should attempt to make repairs at the component level or to make modifications to any printed wiring board. Improper repairs can create a safety hazard. Any indication of component replacement or printed wiring board modification may void any warranty or exchange allowances.

Utilities that are preinstalled on the computer include:

- **PhoenixBIOS Setup Utility**—Allows you to modify or restore factory default settings and configure the system BIOS to diagnose and solve minor problems.
- **Power Management**—Allows you to reduce your computer power consumption. Power Management information is contained in Chapter 1.
- **Security**—Allows you to set or remove your power-on password. Security information is contained in Chapter 1.

Using the PhoenixBIOS Setup Utility

The PhoenixBIOS Setup Utility (PSU) is built into the system. You can configure the system BIOS and modify or restore factory default settings, such as date and time, types of disk drives, power management, and password settings. To run PSU, press **F10** during system startup. When the main screen displays, use the keyboard and arrow keys to move around the menus and make selections.

Troubleshooting Flowcharts for Portable Computers

Table 2-1
Troubleshooting Flowcharts Overview

Section	Description
2.1	Initial troubleshooting
2.2	No power, part 1
2.3	No power, part 2
2.4	No power, part 3
2.5	No power, part 4
2.6	No video, part 1
2.7	No video, part 2
2.8	Non-functioning docking station
2.9	No operating system (OS) loading
2.10	No OS loading from hard drive, part 1
2.11	No OS loading from hard drive, part 2
2.12	No OS loading from hard drive, part 3
2.13	No OS loading from diskette drive
2.14	No OS loading from CD-/DVD-ROM drive
2.15	No audio, part 1
2.16	No audio, part 2
2.17	Non-functioning device
2.18	Non-functioning keyboard
2.19	Non-functioning pointing device
2.20	No network or modem connection

2.1 Initial Troubleshooting

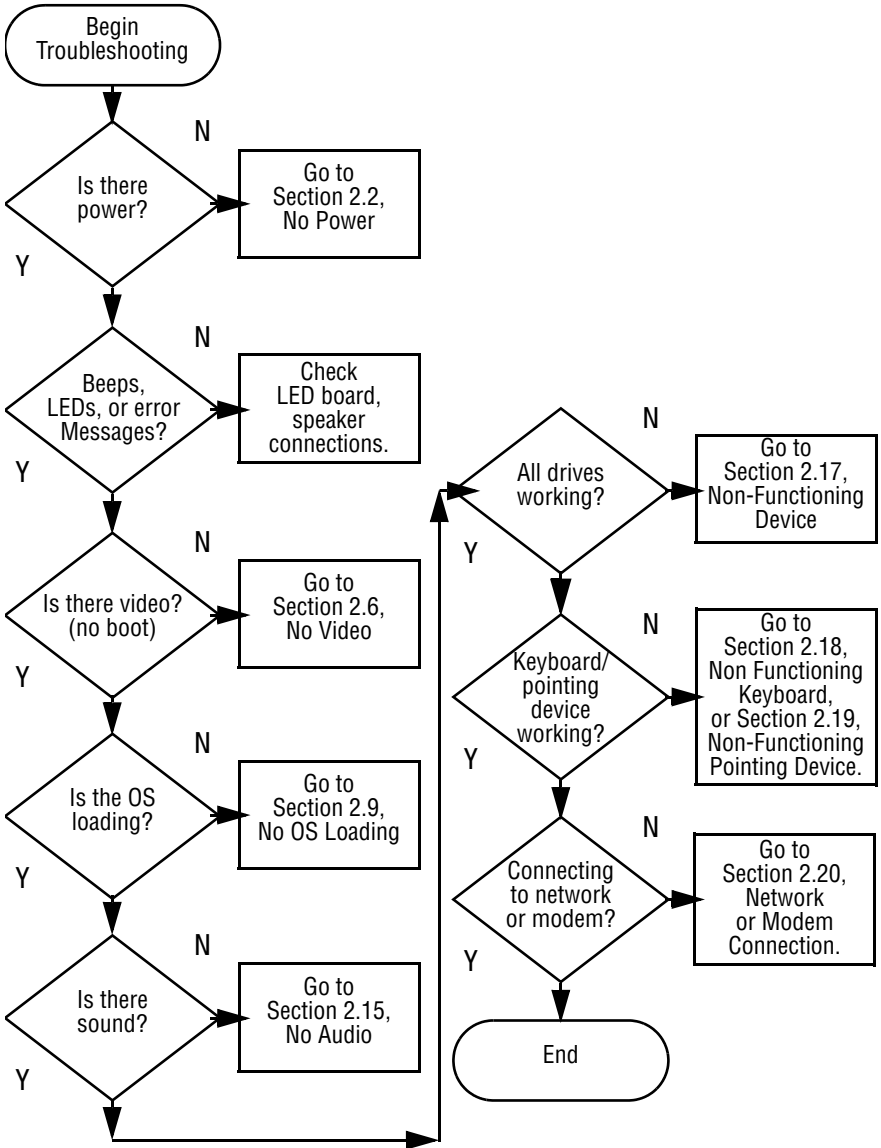

2.2 No Power, Part 1

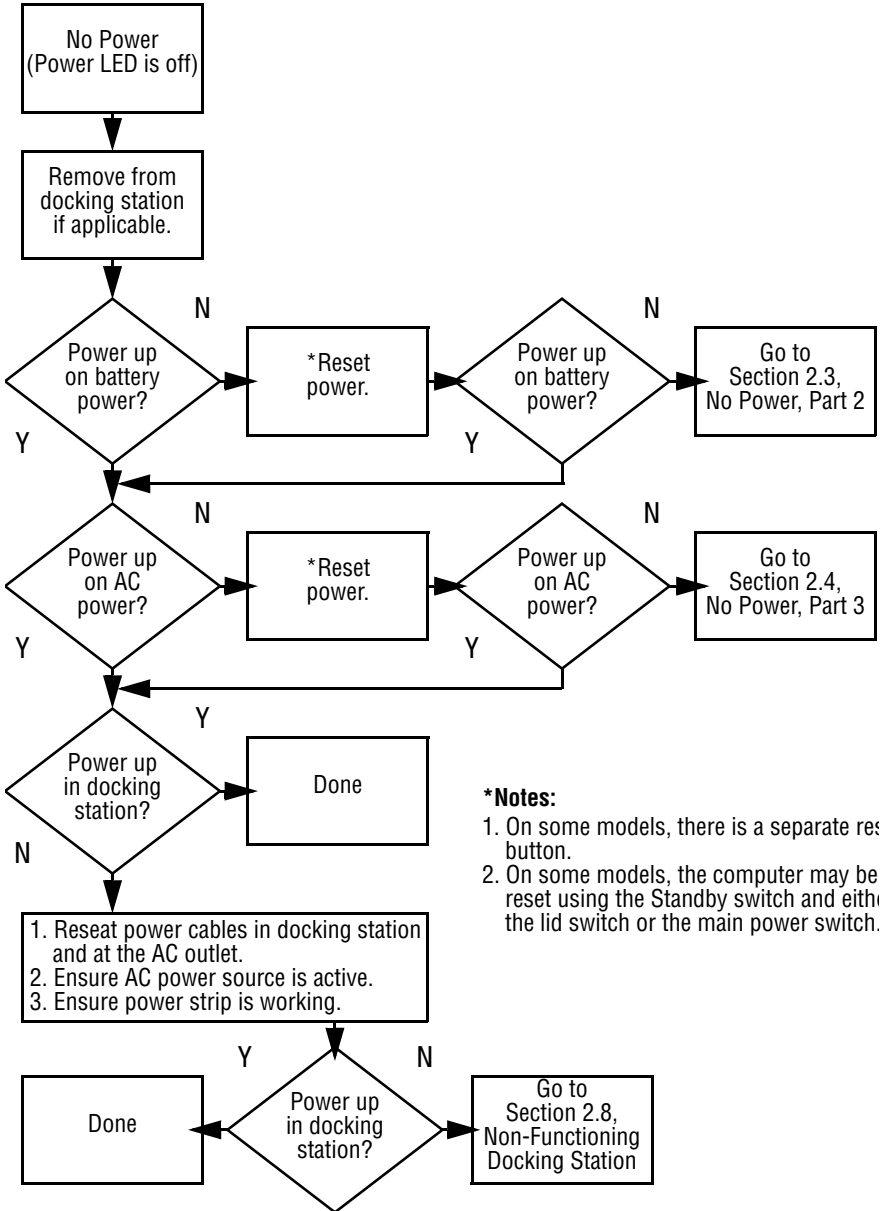

***Notes:**

1. On some models, there is a separate reset button.
2. On some models, the computer may be reset using the Standby switch and either the lid switch or the main power switch.

2.3 No Power, Part 2

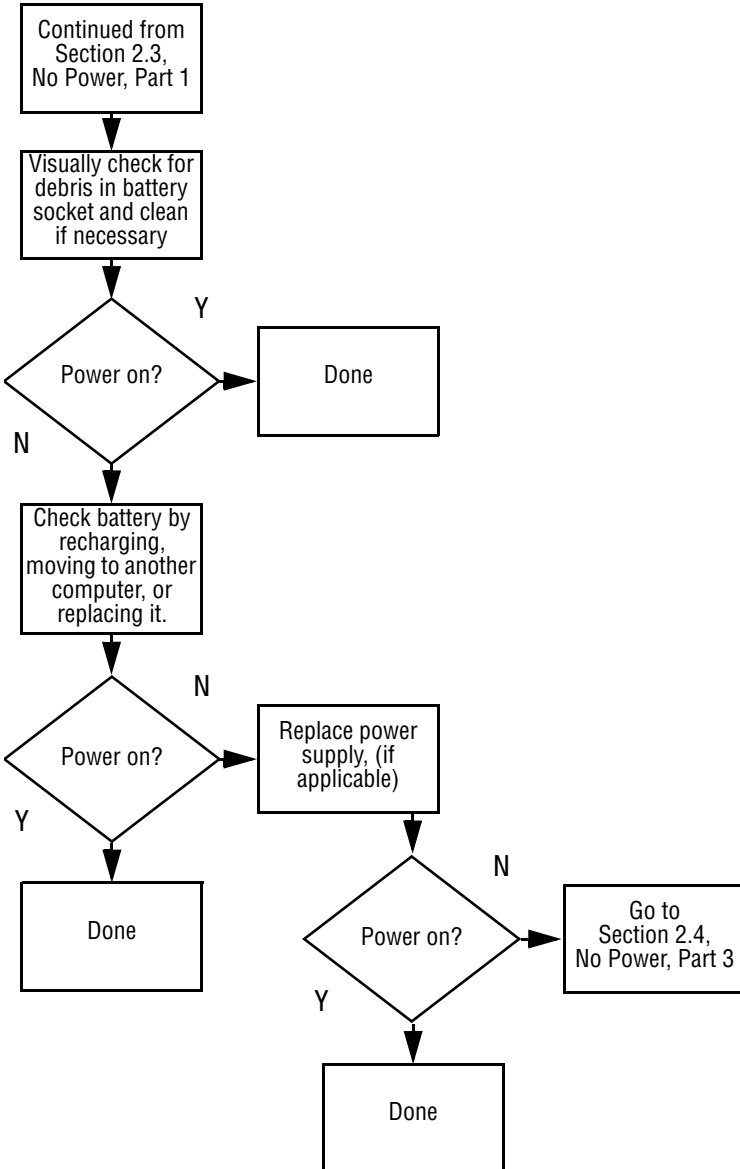

2.4 No Power, Part 3

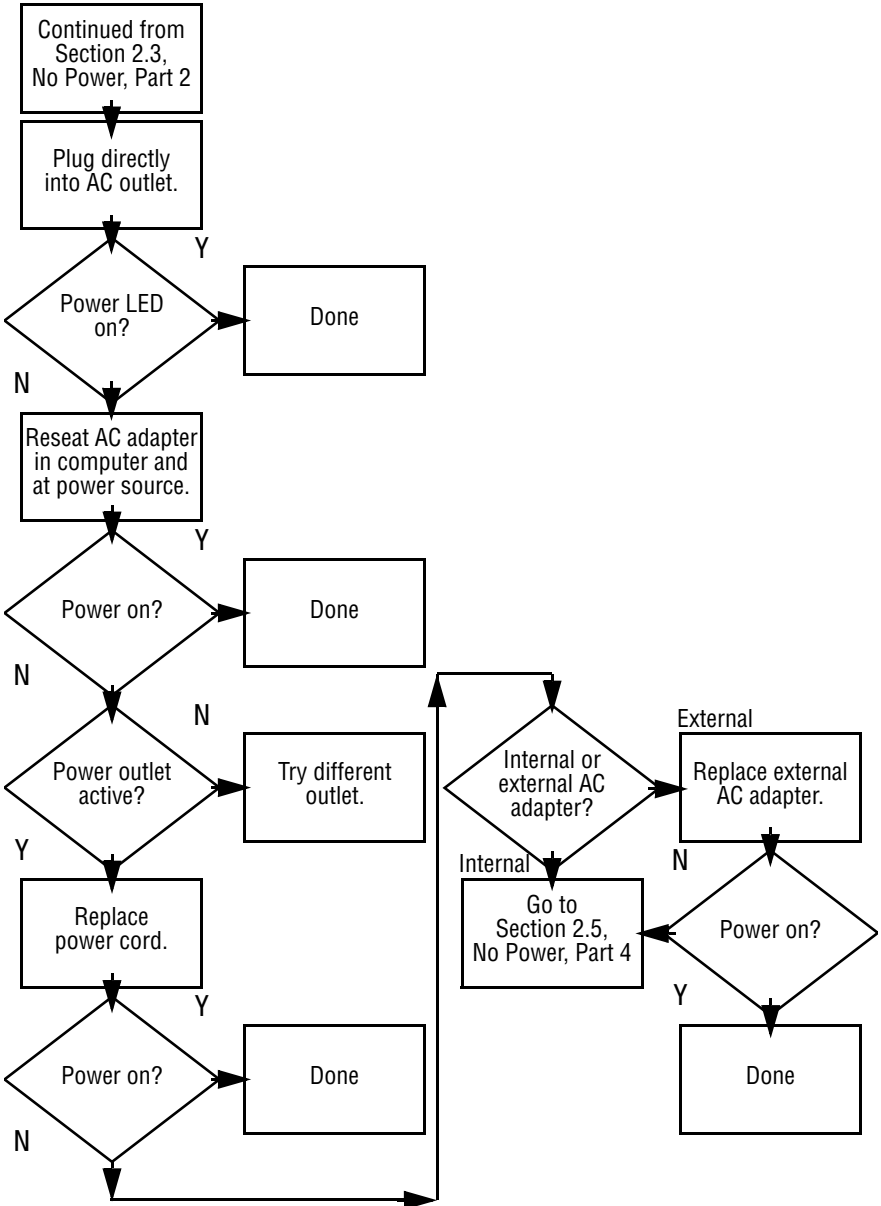

2.5 No Power, Part 4

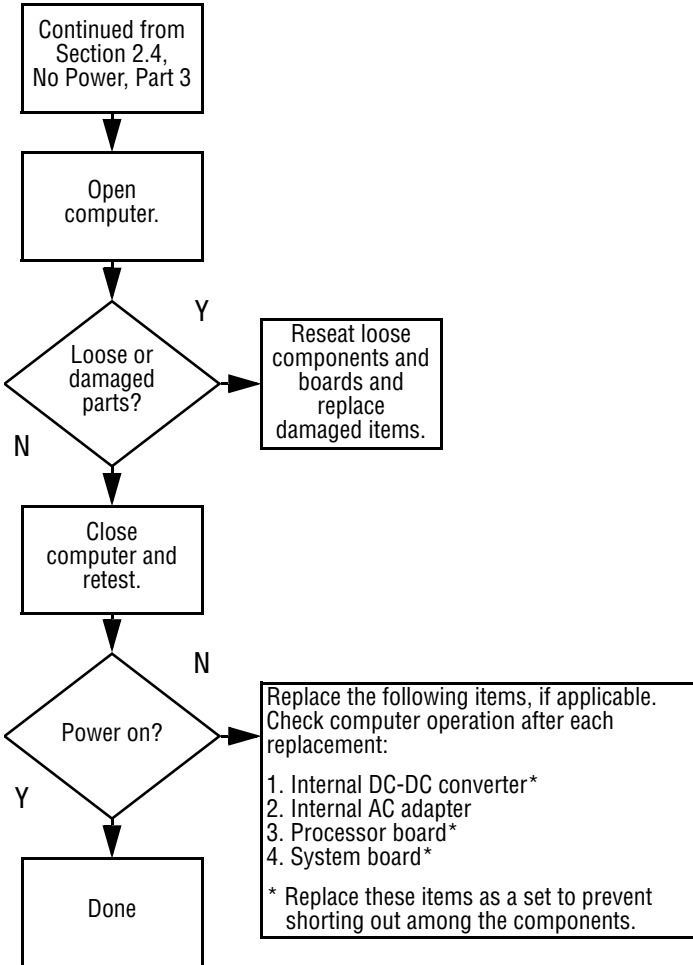

2.6 No Video, Part 1

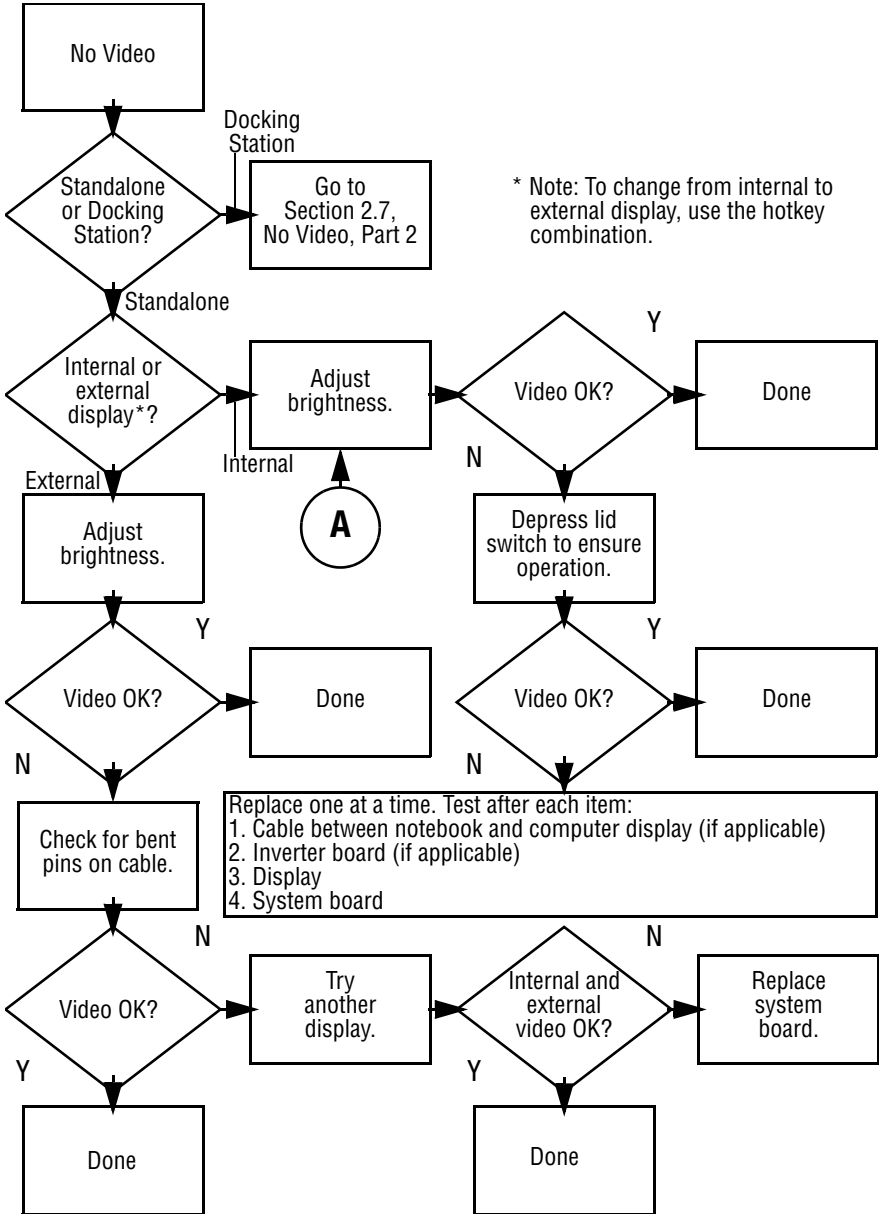

2.7 No Video, Part 2

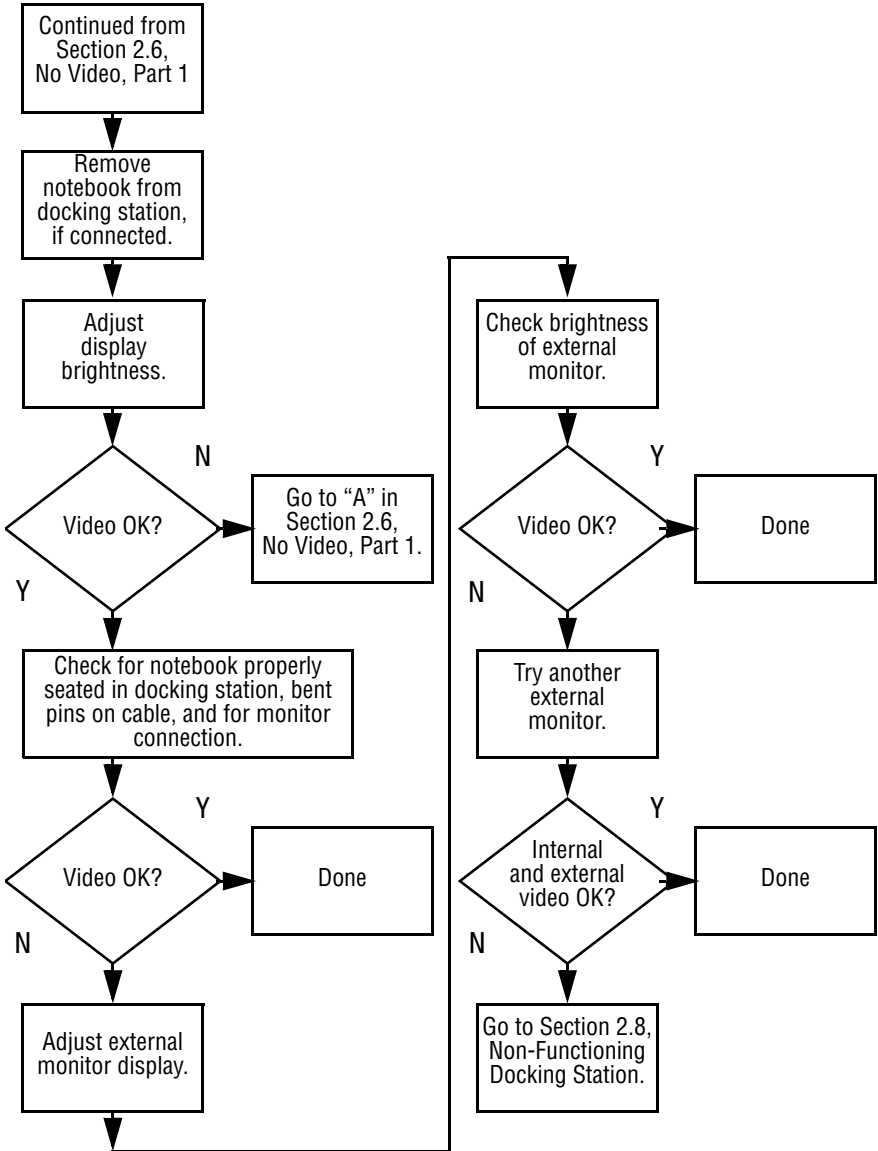

2.8 Non-Functioning Docking Station (if applicable)

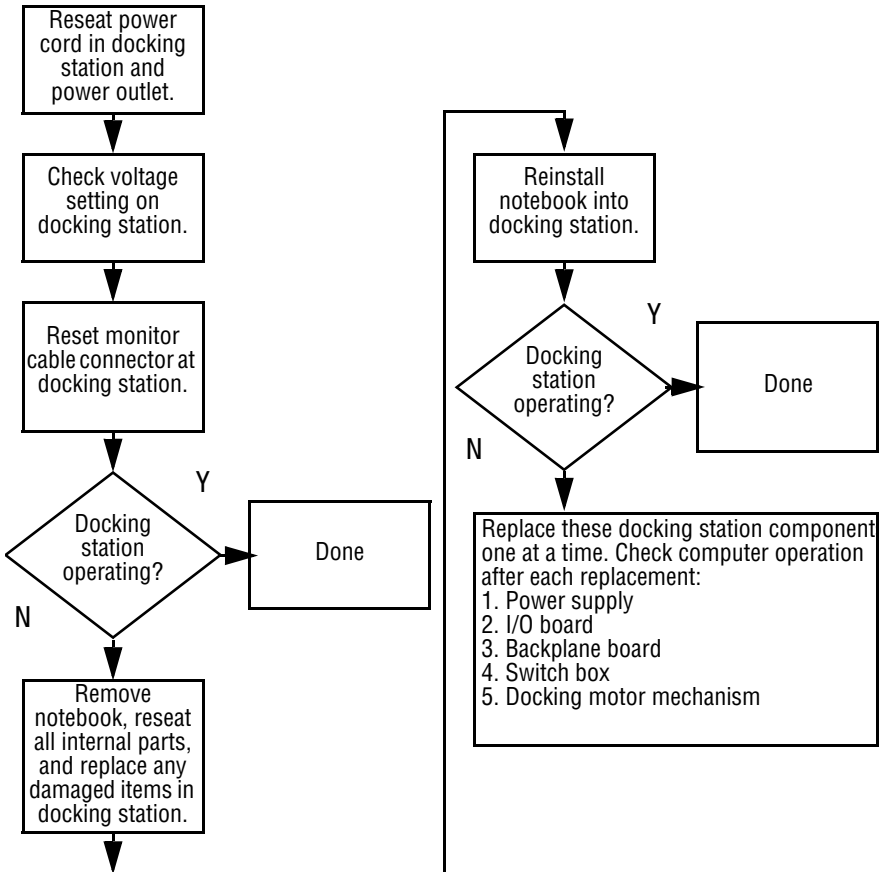

2.9 No Operating System (OS) Loading

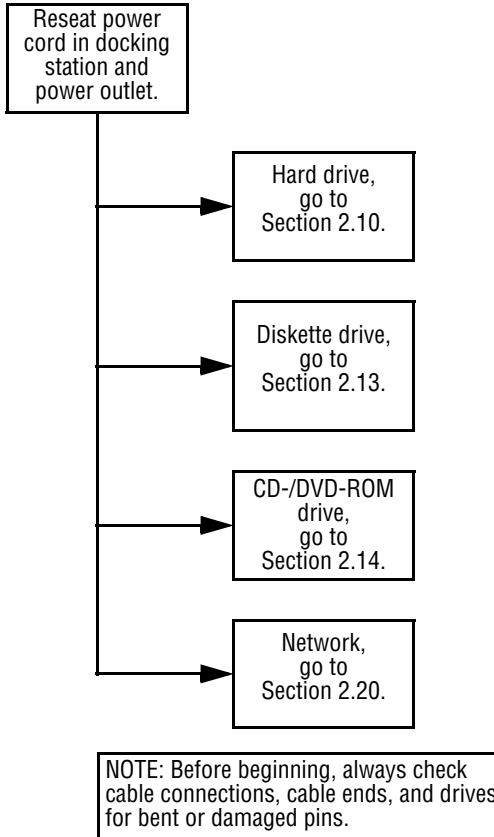

2.10 No OS Loading from Hard Drive, Part 1

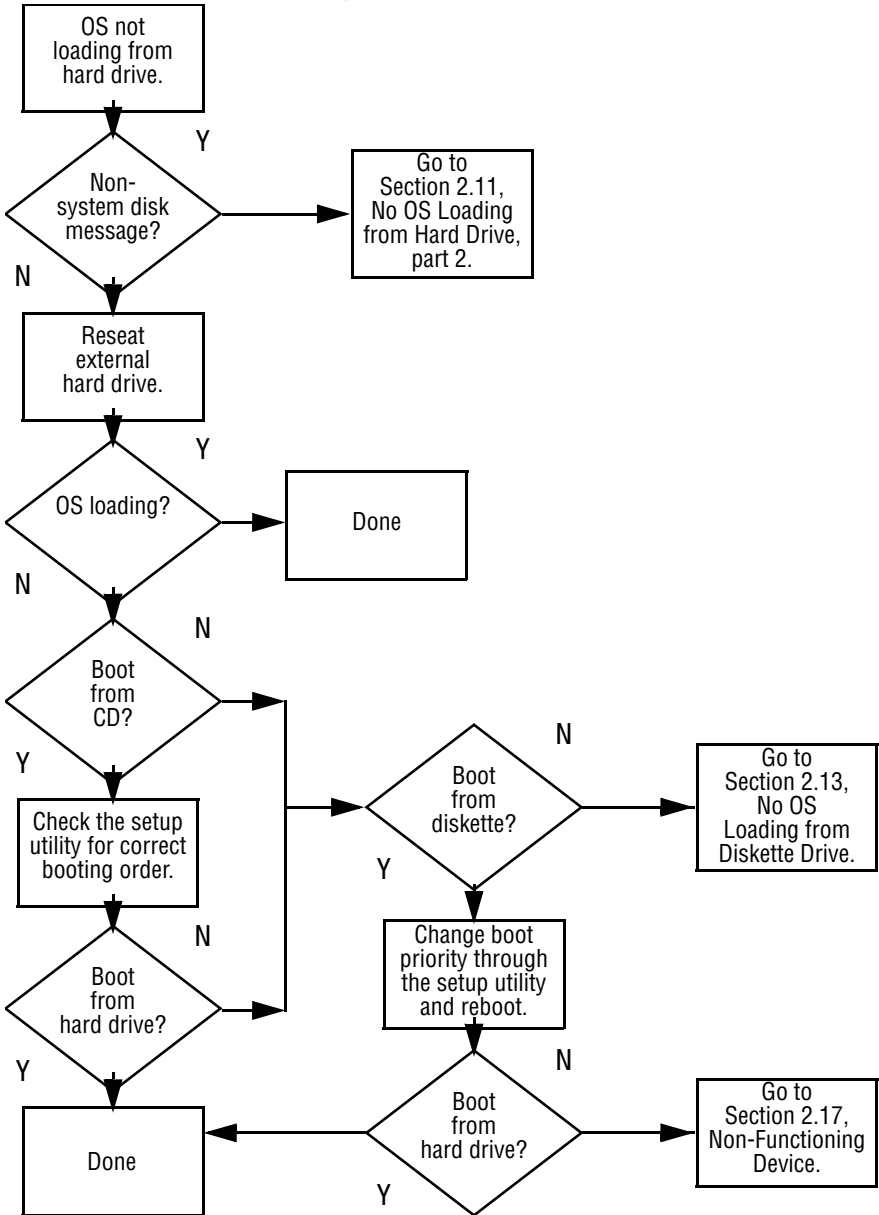

2.11 No OS Loading from Hard Drive, Part 2

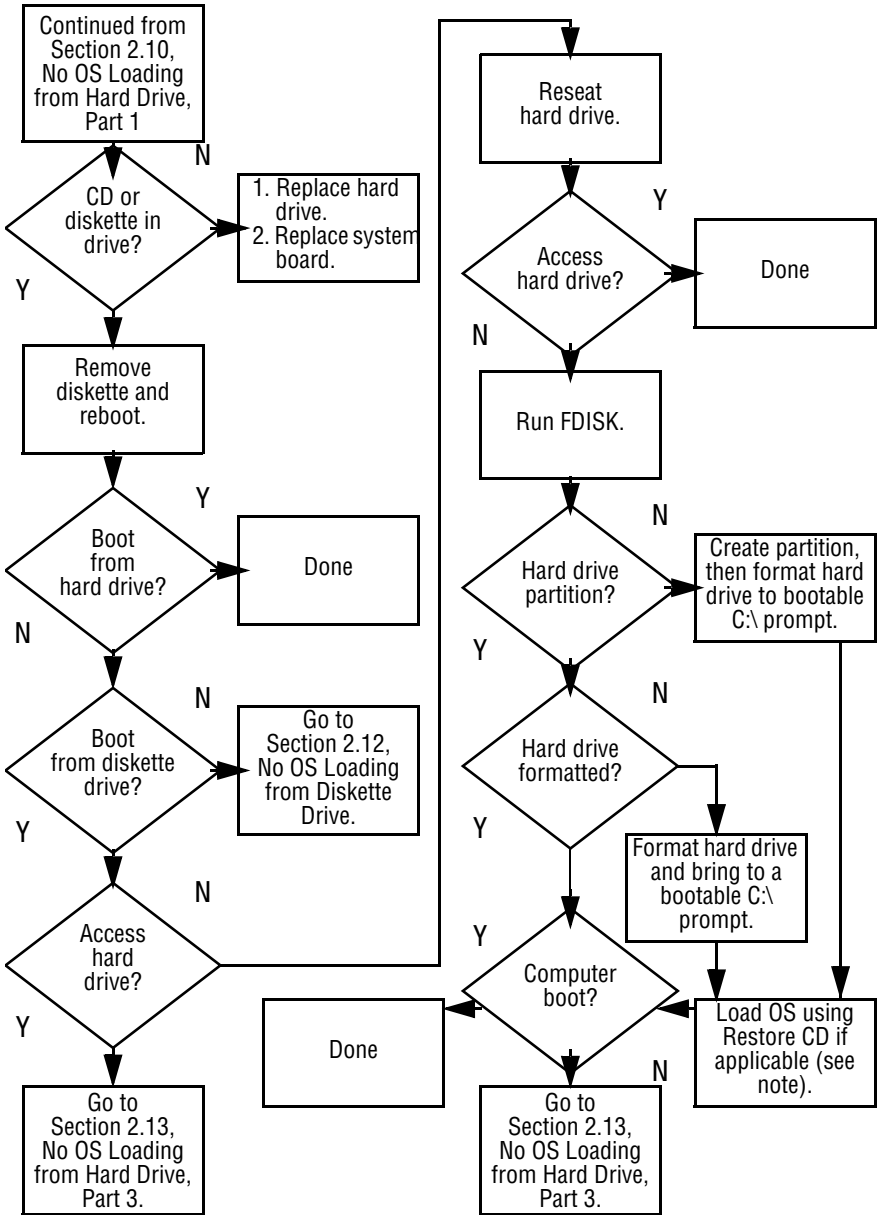

2.12 No OS Loading from Hard Drive, Part 3

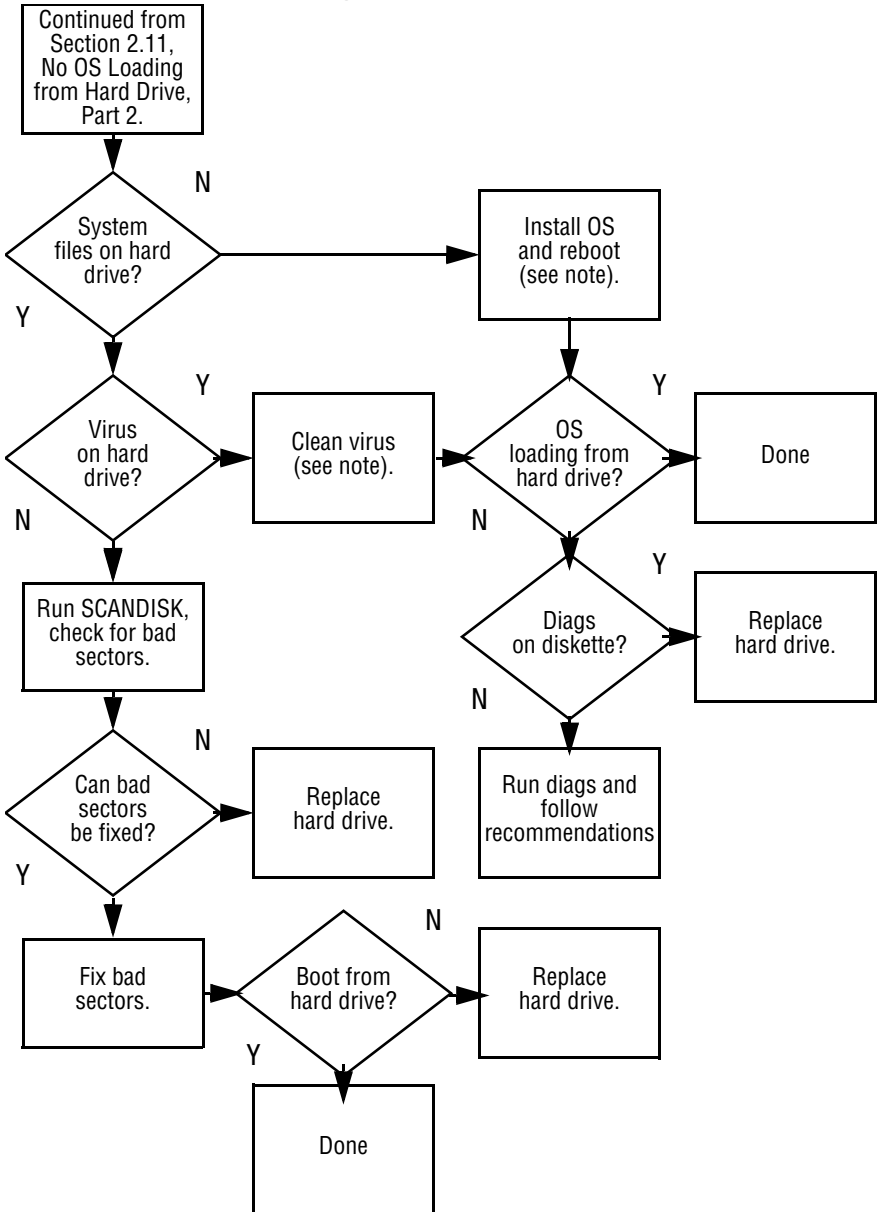

2.13 No OS Loading from Diskette Drive

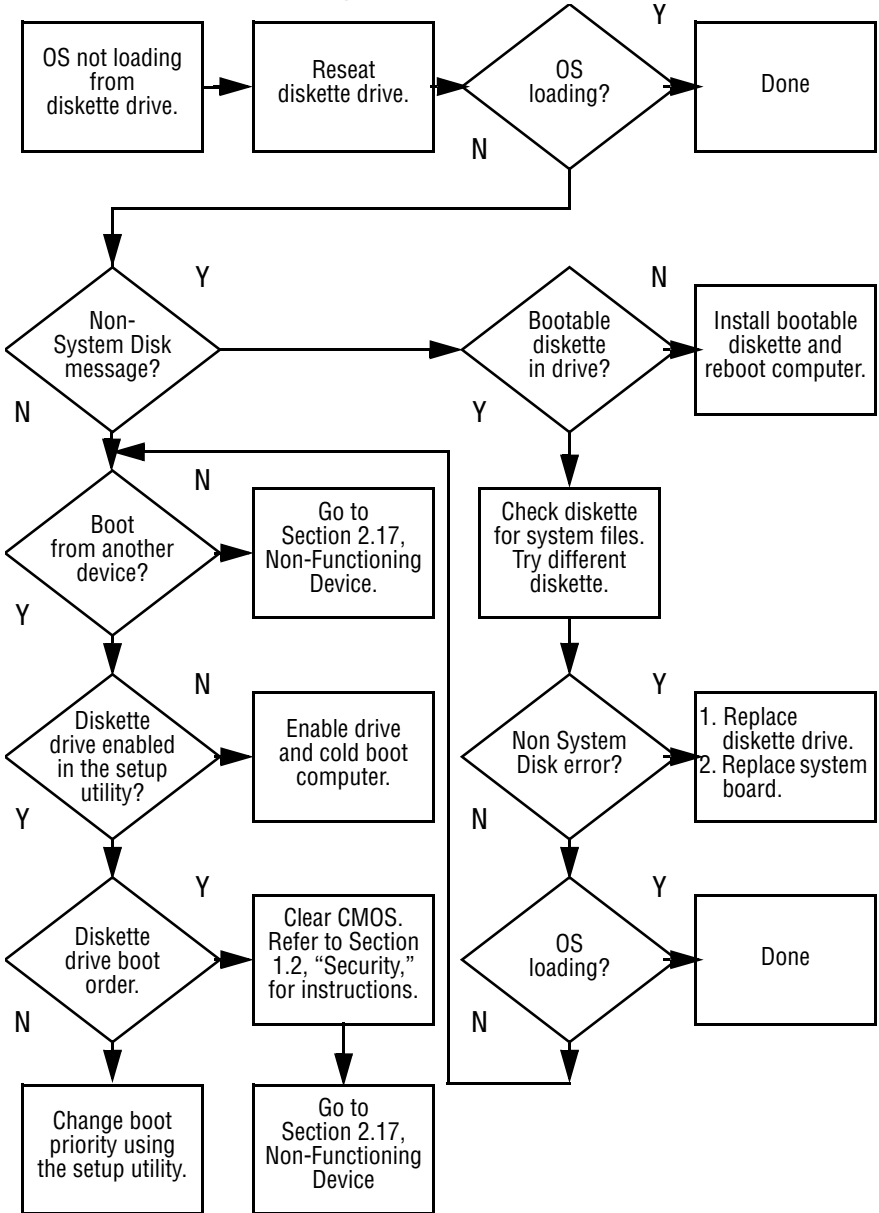

2.14 No OS Loading from CD- or DVD-ROM Drive

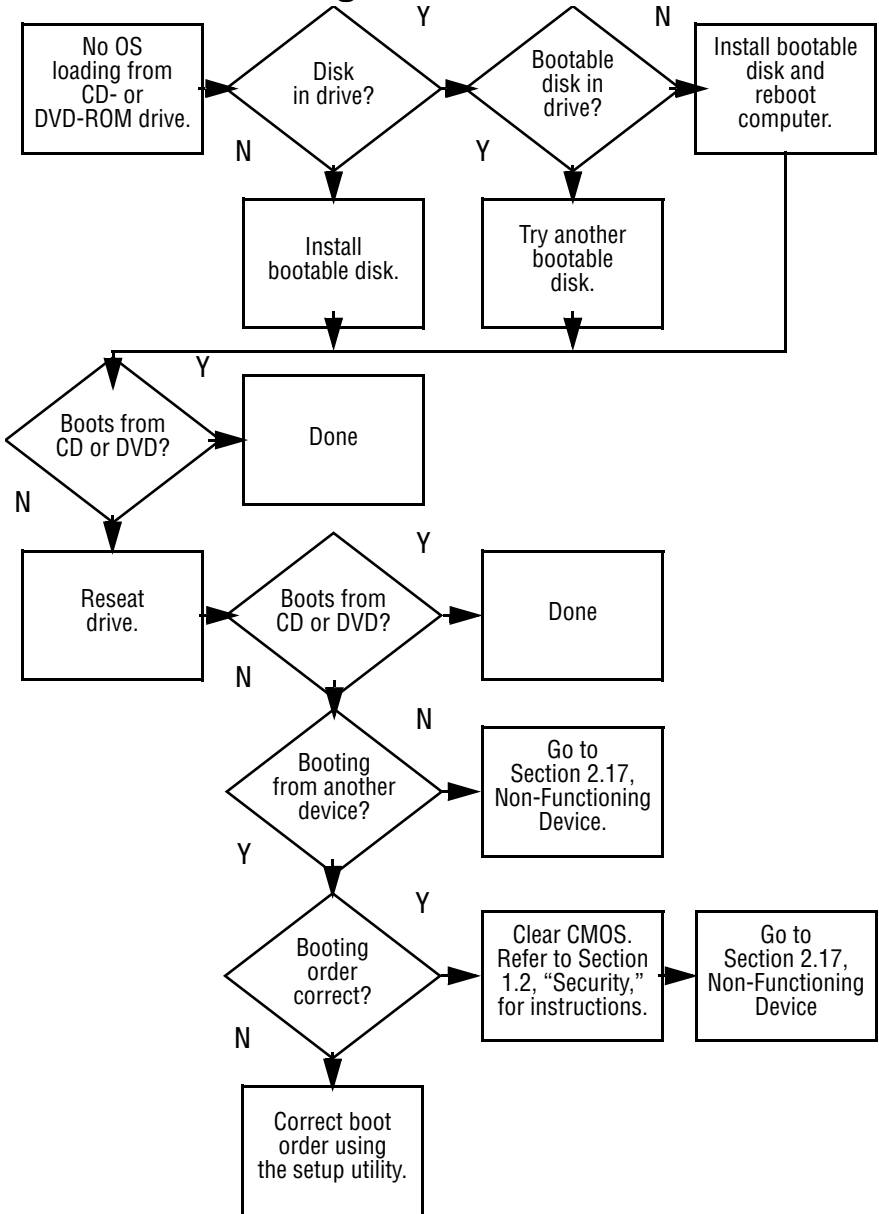

2.15 No Audio, Part 1

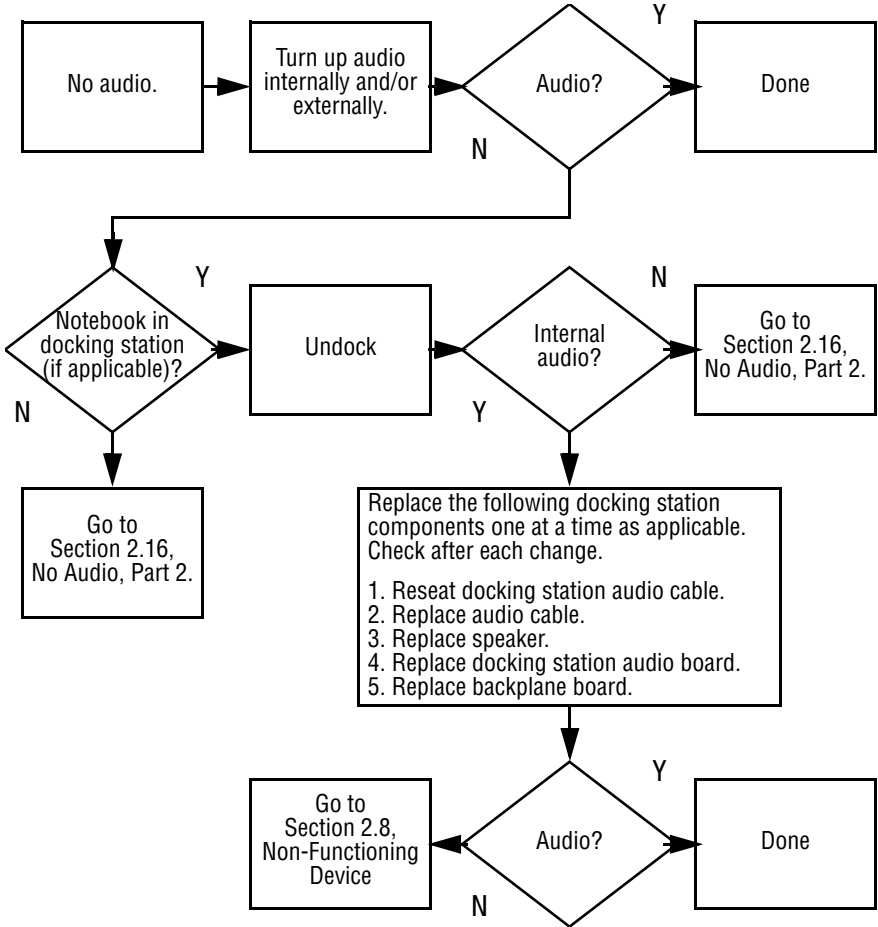

2.16 No Audio, Part 2

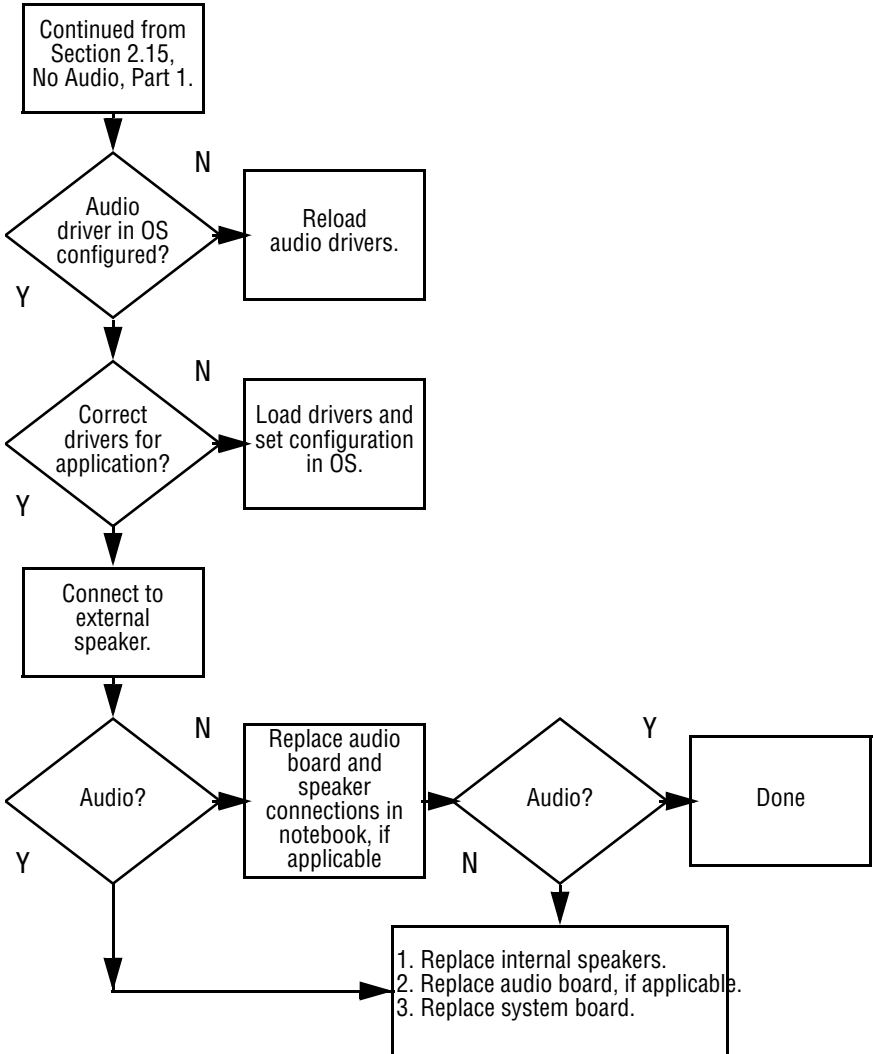

2.17 Non-Functioning Device

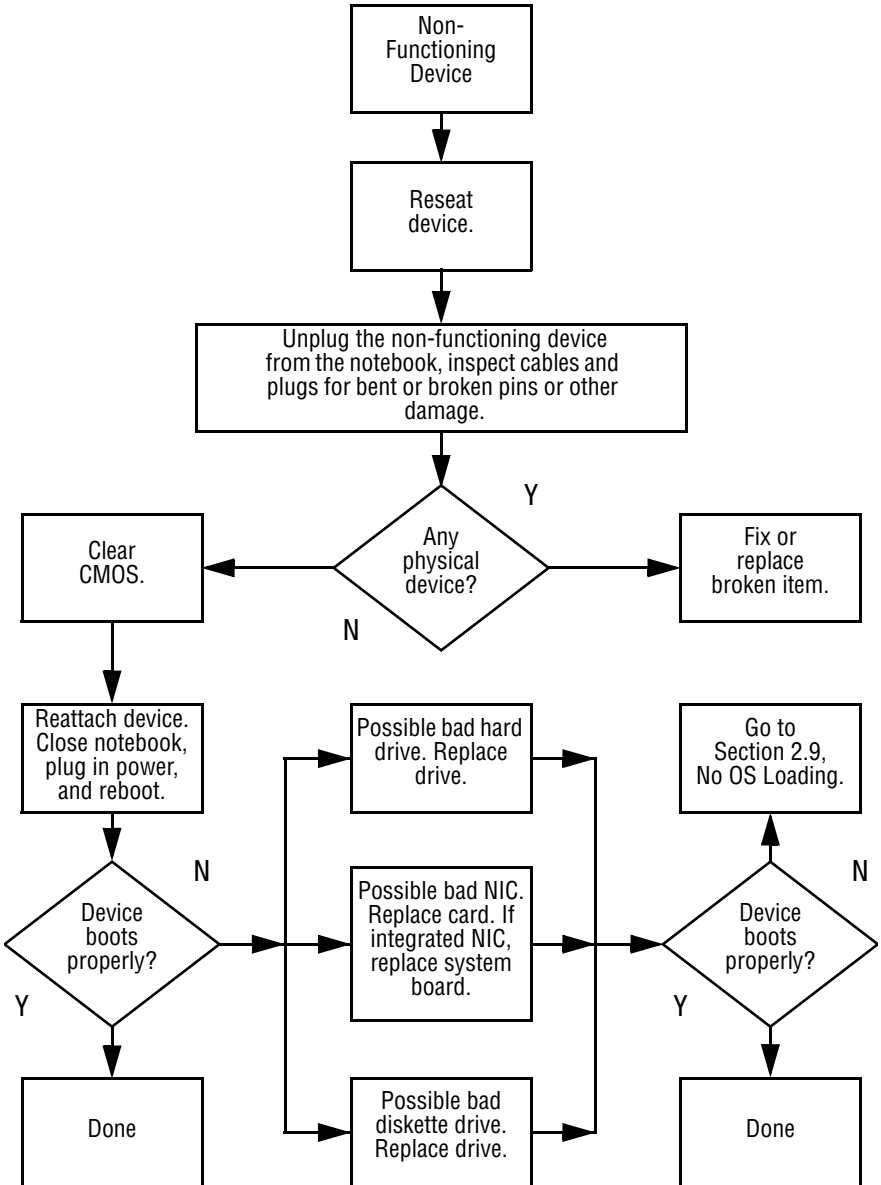

2.18 Non-Functioning Keyboard

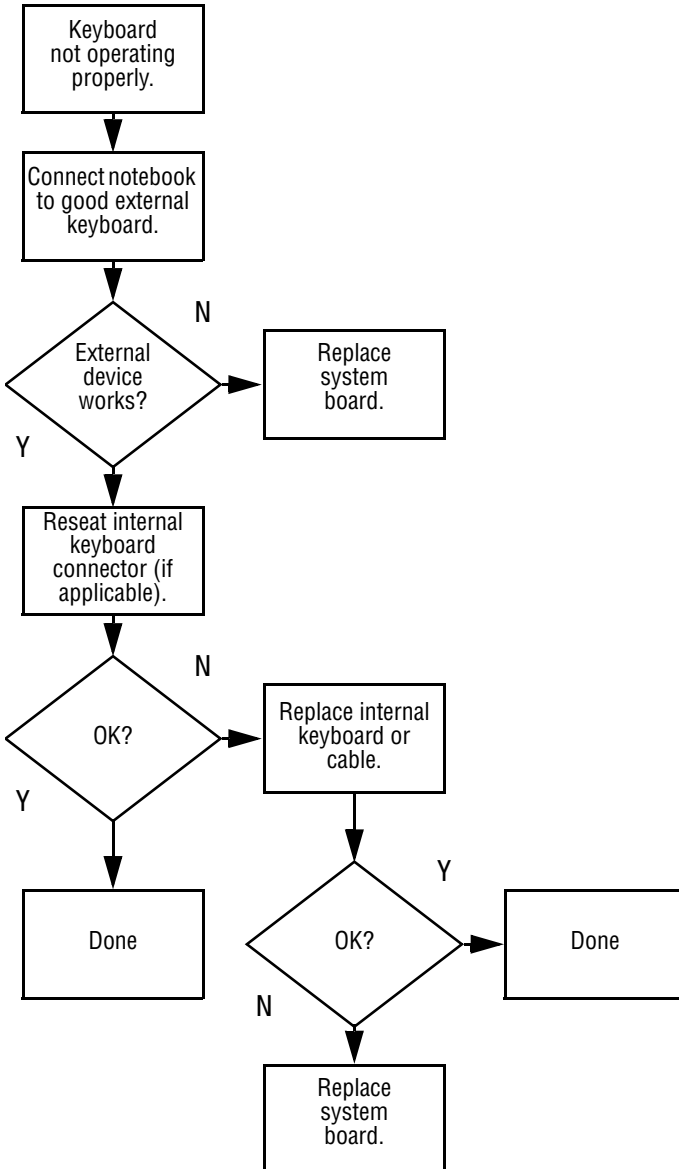

2.19 Non-Functioning Pointing Device

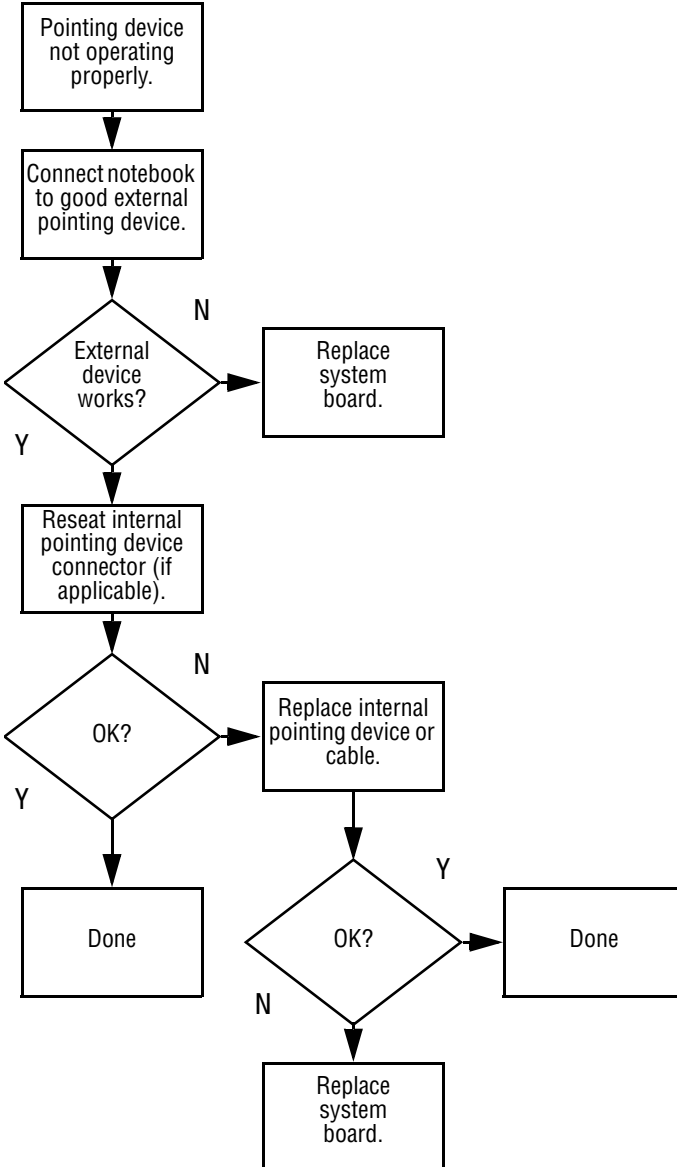

2.20 Network or Modem Connection

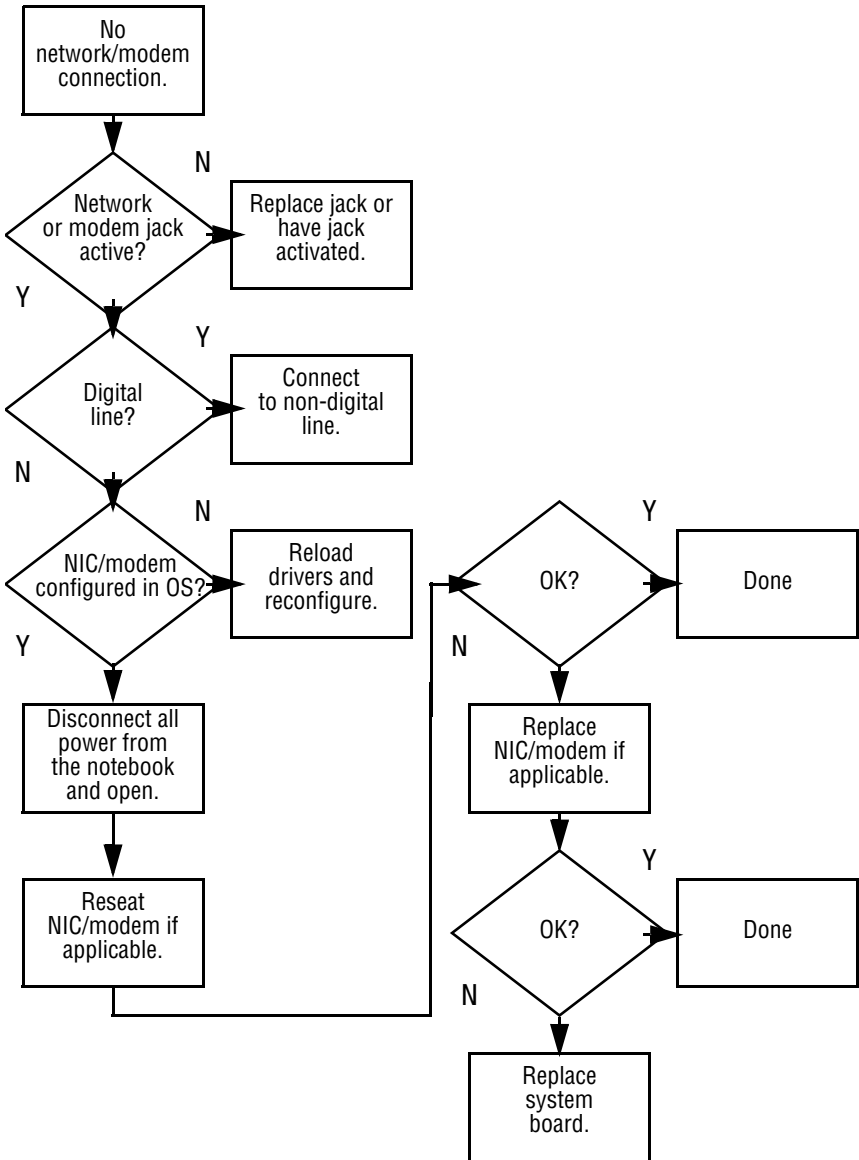

Illustrated Parts Catalog

This chapter provides an illustrated parts breakdown and a reference for spare part numbers and option part numbers.

3.1 Serial Number Location

When ordering parts or requesting information, provide the computer serial number and model number located on the bottom of the computer (Figure 3-1).



Figure 3–1: Serial Number Location

3.2 Computer System Major Components

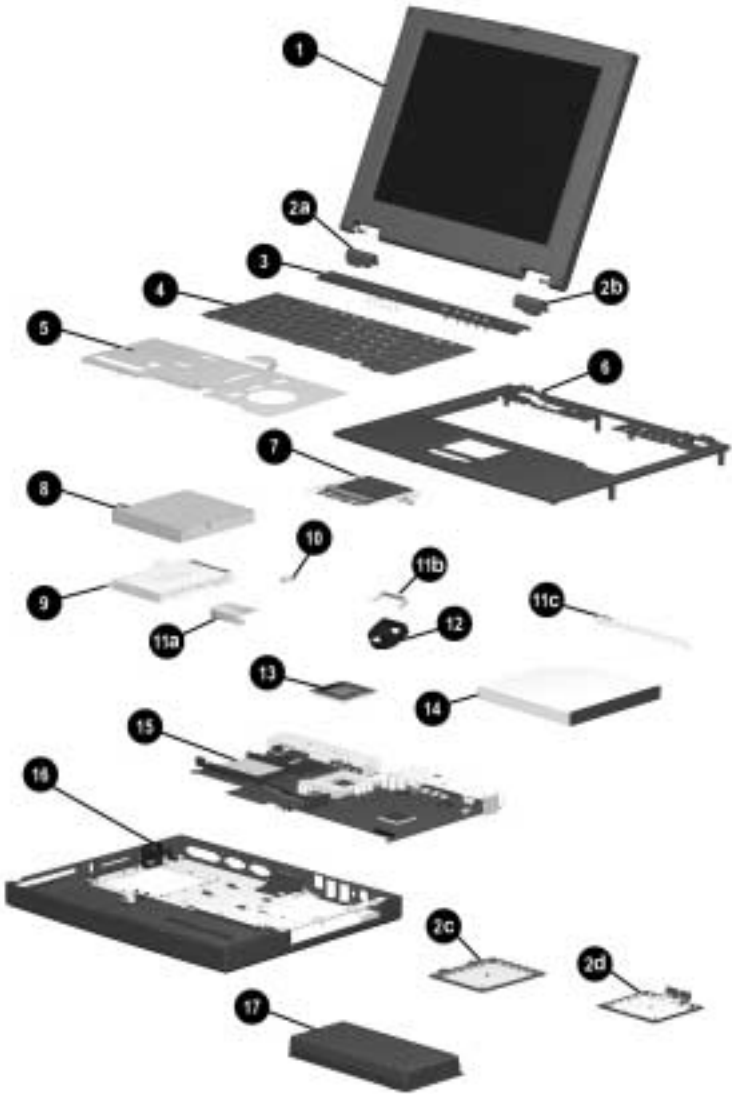
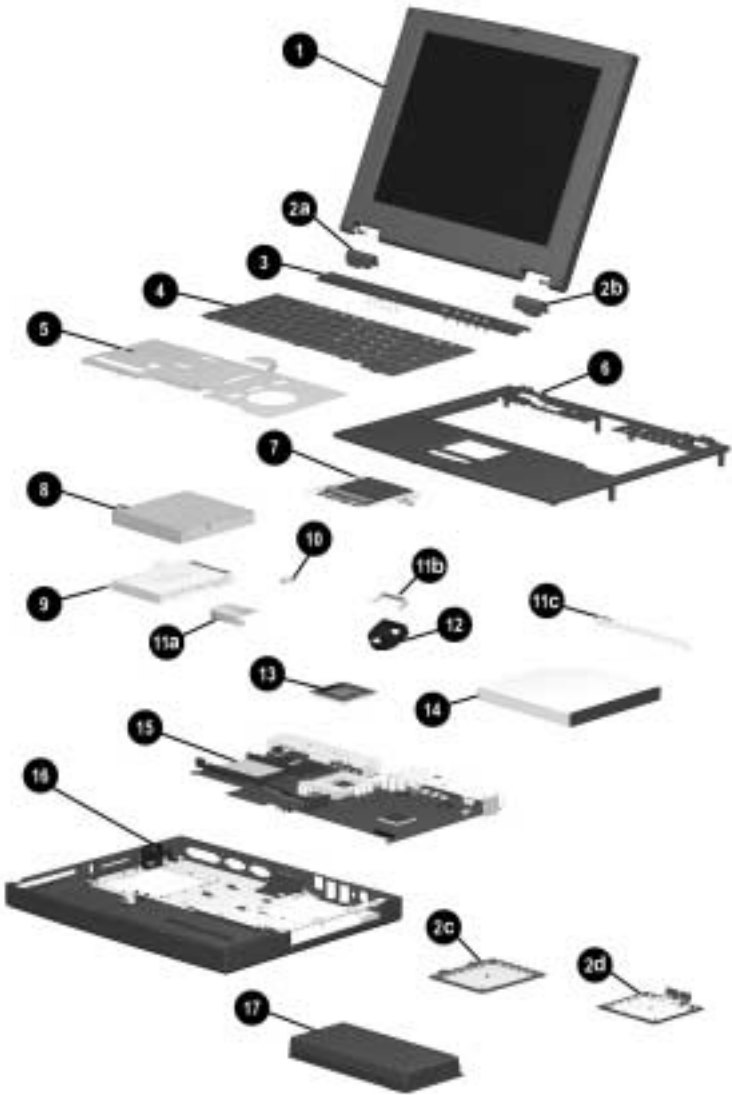

Figure 3-2: Computer System Major Components

Table 3-1
Spare Parts: Computer System Major Components

Item	Description	Spare Part Number
1	Displays	
	14.1-inch, XGA, CTFT	233545-001
	12.1-inch, SVGA, CTFT	233544-001
	Plastics Kit	233562-001
2a	Left hinge cover	not illustrated:
2b	Right hinge cover	Computer feet
2c	Memory expansion compartment cover	RJ-45 cover
2d	Mini PCI slot cover	RJ-11 cover
3	LED cover	233559-001
4	Keyboard	
	Arabic 233740-171	Korean 233740-AD1
	Belgian 233740-381	Latin American
	Czech 233740-221	Spanish 233740-161
	Danish 233740-081	Norwegian 233740-091
	French 233740-051	Portuguese 233740-131
	French	Russian 233740-251
	Canadian 233740-121	Spanish 233740-071
	German 233740-041	Swedish 233740-101
	Hebrew 233740-BB1	Swiss 233740-BF1
	Hungarian 233740-211	Taiwanese 233740-AB1
	International 233740-002	Turkish 233740-141
	Italian 233740-061	U.K. English 233740-031
	Japanese 233740-291	U.S. English 233740-001
5	Heat sink (requires installation of thermal pad; refer to Section 5.9, "Heat Sink," for instructions on thermal pad installation)	233555-001
6	Top cover	233568-001
7	TouchPad	236076-001



Computer System Major Components (continued)

Table 3-1
Spare Parts: Computer System Major Components (Continued)

Item	Description	Spare Part Number
8	Diskette drive	233553-001
9	10-GB hard drive (hard drive bracket spared in Hardware Kit, spare part number 234005-001)	233554-001
10	Disk cell RTC battery	236359-001
	Hardware Kit	234005-001
11a	Hard drive bracket	
11b	Fan bracket	
11c	Optical drive alignment rail	
12	Fan (fan bracket spared in Hardware Kit, item 11, spare part number 234005-001)	233552-001
13	Processors 800 MHz Intel Pentium III 700 MHz Intel Celeron	233551-001 233549-001
14	Optical drives (optical drive alignment rail spared in Hardware kit, item 11, spare part number 234005-001) 24X Max CD-ROM drive 8X Max DVD-ROM drive	 233550-001 233548-001
15	System board (includes 64 MB SDRAM, left and right speakers, and left and right brackets)	233567-001
16	Base enclosure	233547-001
17	Battery packs 9 cell Lithium ion (Li ion) 9 cell Nickel Metal Hydride (Ni MH)	 231964-001 231965-001

3.3 Plastics Kit Components

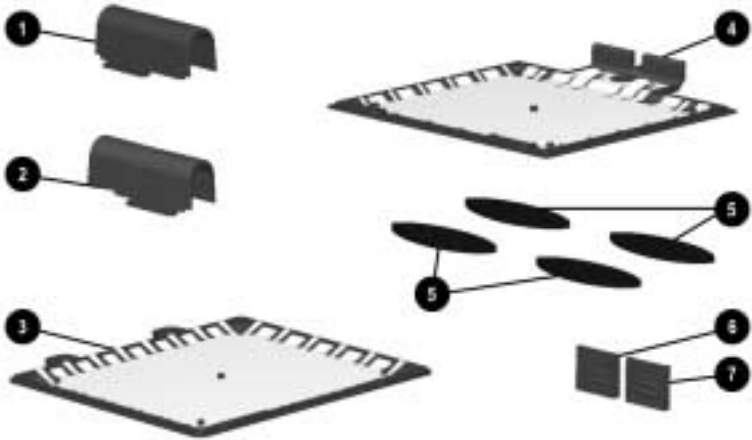

Figure 3–3: Plastics Kit Components

**Table 3-2
Plastics Kit Components
Spare Part Number 233562-001**

Item	Description
1	Left hinge cover
2	Right hinge cover
3	Memory expansion compartment cover
4	Mini PCI slot cover
5	Computer feet
6	RJ-45 cover
7	RJ-11 cover

3.4 Hardware Kit Components

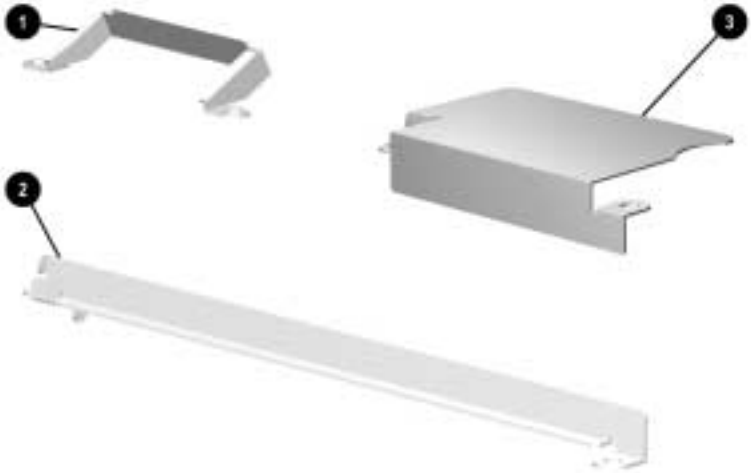

Figure 3-4: Hardware Kit Components

**Table 3-3
Hardware Kit Components
Spare Part Number 234005-001**

Item	Description
1	Fan bracket
2	Optical drive alignment rail
3	Hard drive bracket

3.5 Cable Kit Components



Figure 3-5: Cable Kit Components

Table 3-4
Cable Kit Components
Spare Part Number 234006-001

Item	Description
1	Diskette drive cable (2)
2	TouchPad cable
3	RJ-11 cable
4	RJ-45 cable

3.6 Mass Storage Devices



Figure 3-6: Mass Storage Devices

**Table 3-5
Mass Storage Devices**

Item	Description	Spare Part Number
1	Diskette drive	233553-001
2	10-GB hard drive	233554-001
3	24X Max CD-ROM drive	233550-001
4	8X Max DVD-ROM drive	233548-001

3.7 Miscellaneous

Table 3-6
Spare Parts: Miscellaneous (not illustrated)

Description				Spare Part Number
Modems				
Type III mini PCI combination 56 Kbps modem/NIC board				233558-001
Type III mini PCI 56 Kbps modem board				233557-001
PC Card modem				233564-001
Modem adapters				
Czech	234963-221	Norwegian	234963-091	
German	236432-041	Swiss	198294-111	
Hungarian	234963-211			
Modem cable				234962-001
Modem cable adapters				
Australian	304398-011			
Belgian	304398-181			
French	304398-051			
RJ-11 P55 adapters				
Danish	316904-081	Italian	316904-061	
Finnish	316904-351	Swedish	316904-101	
RJ-11 PTT adapter (used in the United Kingdom)				158593-031
RJ-45 network cable				237672-001

Table 3-6
Spare Parts: Miscellaneous (not illustrated) (Continued)

Description	Spare Part Number
External AC adapter	163444-001
50W slim AC adapter	163444-291
Logo kit	233556-001
Memory expansion boards	
256 MB	167136-001
128 MB	135244-001
64 MB	135243-001
Screw kit (includes M2.5 × 7, M2.5 × 5.5, M2.5 × 5, and M2.5 × 4.5 screws; refer to Appendix C, "Screw Listing," for more information on screw specifications and usage)	233565-001
Power cord, black, 6 feet	
Australian	246959-011
Danish	246959-081
European/Middle Eastern/African	246959-021
Italian	213352-001
Japanese	197233-001
Korean	246959-AD1
Swiss	246959-AG1
Taiwanese	234961-AA1
U.K. English	246959-031
U.S. English	246959-001

Removal and Replacement Preliminaries

This chapter provides essential information for proper and safe removal and replacement service.

4.1 Tools Required

You will need the following tools to complete the removal and replacement procedures:

- Magnetic screwdriver
- Phillips P0 screwdriver
- Tool kit (includes connector removal tool, loopback plugs, and case utility tool)

4.2 Service Considerations

Listed below are some of the considerations that you should keep in mind during disassembly and assembly procedures.



As you remove each subassembly from the computer, place it (and all accompanying screws) away from the work area to prevent damage.

Plastic Parts

Using excessive force during disassembly and reassembly can damage plastic parts. Use care when handling the plastic parts. Apply pressure only at the points designated in the maintenance instructions.

Cables and Connectors

Cables must be handled with extreme care to avoid damage. Apply only the tension required to unseat or seat the cables during removal and insertion. Handle cables by the connector whenever possible. In all cases, avoid bending, twisting, or tearing cables. Ensure that cables are routed in such a way that they cannot be caught or snagged by parts being removed or replaced. Handle flex cables with extreme care; they tear easily.



CAUTION: When servicing the computer, ensure that cables are placed in their proper location during the reassembly process. Improper cable placement can damage the computer.

4.3 Preventing Damage to Removable Drives

Removable drives are fragile components that must be handled with care. To prevent damage to the computer, damage to a removable drive, or loss of information, observe these precautions:

- Before removing or inserting a hard drive, shut down the computer. If you are unsure whether the computer is off or in Hibernation, turn the computer on, then shut it down.
- Before removing a diskette drive or optical drive, ensure that a diskette or disc is not in the drive. Ensure that the optical drive tray is closed.

- Before handling a drive, ensure that you are discharged of static electricity. While handling a drive, avoid touching the connector.
- Handle drives on surfaces that have at least one inch of shock-proof foam.
- Avoid dropping drives from any height onto any surface.
- After removing a hard drive, CD-ROM drive, or a diskette drive, place it into a static-proof bag.
- Avoid exposing a hard drive to products that have magnetic fields such as monitors or speakers.
- Avoid exposing a drive to temperature extremes or to liquids.
- If a drive must be mailed, do the following: place the drive into a bubble pack mailer or other suitable form of protective packaging; label the package “Fragile: Handle With Care.”

4.4 Preventing Electrostatic Damage

Many electronic components are sensitive to electrostatic discharge (ESD). Circuitry design and structure determine the degree of sensitivity. Networks built into many integrated circuits provide some protection, but in many cases the discharge contains enough power to alter device parameters or melt silicon junctions.

A sudden discharge of static electricity from a finger or other conductor can destroy static-sensitive devices or microcircuitry. Often the spark is neither felt nor heard, but damage occurs. An electronic device exposed to electrostatic discharge may not be affected at all and can work perfectly throughout a normal cycle. It may function normally for a while, then degrade in the internal layers, reducing its life expectancy.

4.5 Packaging and Transporting Precautions

Use the following grounding precautions when packaging and transporting equipment:

- To avoid hand contact, transport products in static-safe containers such as tubes, bags, or boxes.
- Protect all electrostatic-sensitive parts and assemblies with conductive or approved containers or packaging.
- Keep electrostatic-sensitive parts in their containers until they arrive at static-free workstations.
- Place items on a grounded surface before removing them from their container.
- Always be properly grounded when touching a sensitive component or assembly.

- Place reusable electrostatic-sensitive parts from assemblies in protective packaging or non-conductive foam.
- Use transporters and conveyers made of antistatic belts and roller bushings. Ensure that mechanized equipment used for moving materials is wired to ground, and that proper materials were selected to avoid static charging. When grounding is not possible, use an ionizer to dissipate electric charges.

4.6 Workstation Precautions

Use the following grounding precautions at workstations:

- Cover the workstation with approved static-dissipative material (refer to Table 4-2).
- Use a wrist strap connected to a properly grounded work surface and use properly grounded tools and equipment.
- Use conductive field service tools, such as cutters, screwdrivers, and vacuums.
- When using fixtures that must directly contact dissipative surfaces, use fixtures made of static-safe materials only.
- Keep the work area free of nonconductive materials such as ordinary plastic assembly aids and Styrofoam.
- Handle electrostatic-sensitive components, parts, and assemblies by the case or PCM laminate. Handle them only at static-free workstations.
- Avoid contact with pins, leads, or circuitry.
- Turn off power and input signals before inserting or removing connectors or test equipment.

4.7 Grounding Equipment and Methods

Grounding equipment must include either a wrist strap or a foot strap at a grounded workstation.

- When seated, wear a wrist strap connected to a grounded system. Wrist straps are flexible straps with a minimum of one megaohm $\pm 10\%$ resistance in the ground cords. To provide proper ground, wear a strap snug against the skin at all times. On grounded mats with banana-plug connectors, connect a wrist strap with alligator clips.
- When standing, use foot straps and a grounded floor mat. Foot straps (heel, toe, or boot straps) can be used at standing workstations and are compatible with most types of shoes or boots. On conductive floors or dissipative floor mats, use them on both feet with a minimum of one-megaohm resistance between the operator and ground. To be effective, the conductive strips must be worn in contact with the skin.
- Other grounding equipment recommended for use in preventing electrostatic damage includes:
 - Antistatic tape
 - Antistatic smocks, aprons, or sleeve protectors
 - Conductive bins and other assembly or soldering aids
 - Non-conductive foam
 - Conductive tabletop workstations with ground cord of one-megaohm resistance
 - Static-dissipative table or floor mats with hard tie to ground
 - Field service kits
 - Static awareness labels
 - Material-handling packages

- Non-conductive plastic bags, tubes, or boxes
- Metal tote boxes
- Electrostatic voltage levels and protective materials

Table 4-1 shows how humidity affects the electrostatic voltage levels generated by different activities.

**Table 4-1
Typical Electrostatic Voltage Levels**

Event	Relative Humidity		
	10%	40%	55%
Walking across carpet	35,000 V	15,000 V	7,500 V
Walking across vinyl floor	12,000 V	5,000 V	3,000 V
Motions of bench worker	6,000 V	800 V	400 V
Removing DIPS from plastic tube	2,000 V	700 V	400 V
Removing DIPS from vinyl tray	11,500 V	4,000 V	2,000 V
Removing DIPS from Styrofoam	14,500 V	5,000 V	3,500 V
Removing bubble pack from PCB	26,500 V	20,000 V	7,000 V
Packing PCBs in foam-lined box	21,000 V	11,000 V	5,000 V

 A product can be degraded by as little as 700 volts.

Table 4-2 lists the shielding protection provided by antistatic bags and floor mats.

**Table 4-2
Static-Shielding Materials**

Material	Use	Voltage Protection Level
Antistatic plastic	Bags	1,500 V
Carbon-loaded plastic	Floor mats	7,500 V
Metallized laminate	Floor mats	5,000 V

Removal and Replacement Procedures

This chapter provides removal and replacement procedures.

All screws removed during disassembly are P0 Phillips screws. There are four different sized screws that must be removed and replaced when servicing the computer. Make special note of the size and location of each screw during removal and replacement.

Refer to Appendix C, “Screw Listing,” for detailed information on screw sizes, locations, and usage.

5.1 Serial Number

Report the computer serial number to Compaq when requesting information or ordering spare parts. The serial number is located on the bottom of the computer (Figure 5-1).



Figure 5-1: Serial Number Location

5.2 Disassembly Sequence Chart

Use the chart below to determine the section number to be referenced when removing computer components.

Table 5-1
Disassembly Sequence Chart

Section	Description	# of Screws Removed
5.3	Preparing the computer for disassembly	0
5.4	Computer feet	0
5.5	LED cover	0
5.6	Keyboard	2
5.7	Optical drive	1
5.8	Display	7
5.9	Heat sink	5
5.10	Processor	0
5.11	Top cover	15
5.12	Diskette drive	2
5.13	TouchPad	1
5.14	Hard drive Hard drive bracket	3
5.15	Disk cell Real Time Clock (RTC) battery	0
5.16	Fan Fan bracket	2
5.17	System board Optical drive alignment rail	7

5.3 Preparing the Computer for Disassembly

Perform the following steps before disassembling the computer. Consult the computer *Hardware Guide* for instructions on the following steps:

1. Turn off the computer.
2. Disconnect the AC Adapter and all external devices.
3. Remove any battery packs inserted into the computer.
4. Remove the memory expansion compartment cover.

5.4 Computer Feet

The computer feet are adhesive-backed rubber pads. The computer feet are included in the Plastics Kit (spare part number 233562-001). Refer to Figure 5-2 for the computer feet locations.

Computer Feet Spare Part Number Information

Plastics kit, includes:

Left hinge cover
Right hinge cover
Mini PCI slot cover
Memory expansion compartment cover

Spare part number 233562-001

Computer feet
RJ-45 cover
RJ-11 cover

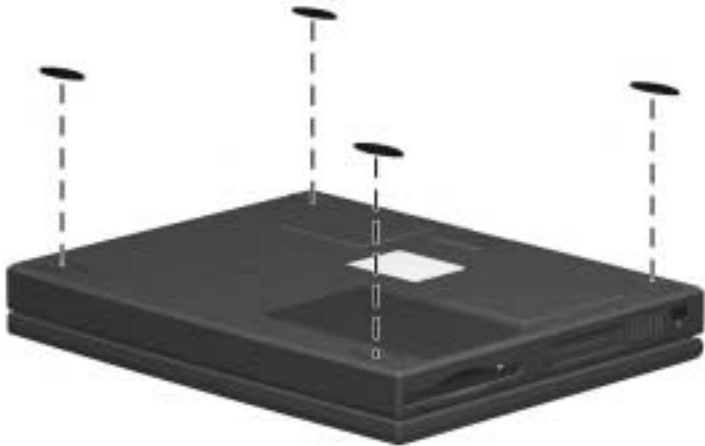

Figure 5-2: Replacing the Computer Feet

5.5 LED Cover

LED Cover Spare Part Number Information

LED cover

233559-001

1. Prepare the computer for disassembly (Section 5.3).
2. Turn the computer top side up with the front facing you.
3. Open the computer.
4. Lift up the left edge of the LED cover ❶ (Figure 5-3).
5. Lift up the front edge of the LED cover from left to right ❷.
6. Lift the LED cover straight up to remove it.



Figure 5-3: Removing the LED Cover

Reverse the above procedure to install the LED cover.

5.6 Keyboard

Keyboard Spare Part Number Information

Keyboards

Arabic	233740-171	Korean	233740-AD1
Belgian	233740-381	Latin American Spanish	233740-161
Czech	233740-221	Norwegian	233740-091
Danish	233740-081	Portuguese	233740-131
French	233740-051	Russian	233740-251
French Canadian	233740-121	Swedish	233740-101
German	233740-041	Swiss	233740-BF1
Hebrew	233740-BB1	Spanish	233740-071
Hungarian	233740-211	Taiwanese	233740-AB1
International	233740-002	Turkish	233740-141
Italian	233740-061	U.K. English	233740-031
Japanese	233740-291	U.S. English	233740-001

1. Prepare the computer for disassembly (Section 5.3).
2. Remove the LED cover (Section 5.5).

3. Remove the two M2.5 × 5 screws securing the keyboard to the base enclosure ❶ (Figure 5-4).
4. Swing the back edge of the keyboard up and forward ❷ until it rests on the top cover.



Figure 5-4: Removing the Keyboard Screws

5. Release the zero insertion force (ZIF) connector to which the keyboard cable is connected ❶ and disconnect the keyboard cable from the system board ❷ (Figure 5-5).

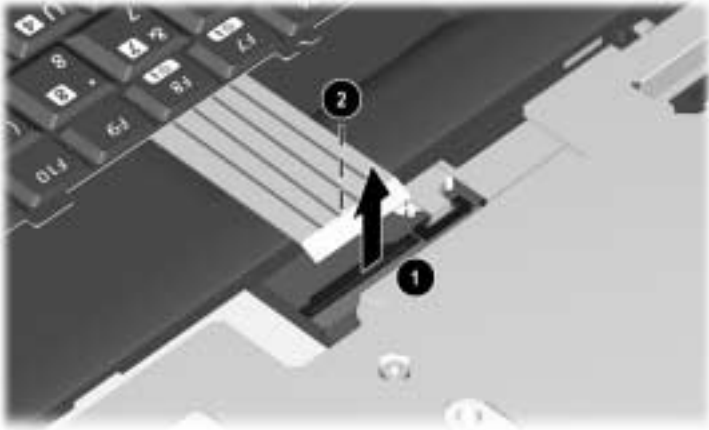

Figure 5–5: Disconnecting the Keyboard Cable

6. Remove the keyboard.

Reverse the above procedure to install the keyboard.

5.7 Optical Drive

Optical Drives Spare Part Number Information

Optical drives

24X Max CD-ROM drive	233550-001
8X Max DVD-ROM drive	233548-001

Optical drive alignment rail (included in Hardware kit)	234005-001
--	------------

1. Prepare the computer for disassembly (Section 5.3) and, in the order below, remove the following components:
 - LED cover (Section 5.5)
 - Keyboard (Section 5.6)

2. Remove the M2.5 × 4.5 screw that secures the optical drive to the heat sink ❶ (Figure 5-6).
3. Push the back edge of the optical drive ❷ to the right to disconnect it from the connector on the system board.
4. Slide the optical drive out of the base enclosure ❸.

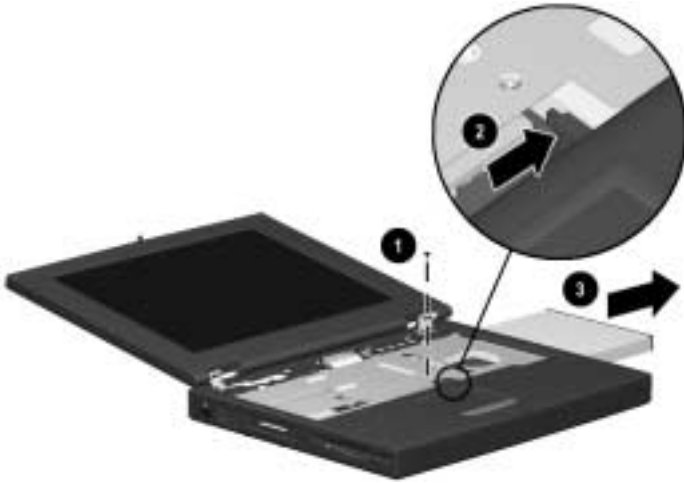

Figure 5–6: Removing the Optical Drive

Reverse the above procedure to install the optical drive.

5.8 Display

Display Spare Part Number Information

Displays

14.1-inch, XGA, CTFT	233545-001
12.1-inch, SVGA, CTFT	233544-001



When the display screws are removed, the display assembly is unsupported. Make sure to provide support for the display assembly when removing the display screws.

1. Prepare the computer for disassembly (Section 5.3) and, in the order below, remove the following components:
 - LED cover (Section 5.5)
 - Keyboard (Section 5.6)
2. Close the computer.
3. Position the computer with the rear panel facing you.

4. Remove the two M2.5 × 4.5 screws securing the hinge covers to the display hinges ❶ (Figure 5-7).
5. Lift the hinge covers straight up to remove them ❷.



Figure 5-7: Removing the Hinge Covers



The right and left hinge covers are included in the Plastics Kit and are not interchangeable.

Hinge Covers Spare Part Number Information

Plastics kit, includes:

Left hinge cover
Right hinge cover
Mini PCI slot cover
Memory expansion compartment cover

Spare part number 233562-001

Computer feet
RJ-45 cover
RJ-11 cover

6. Position the computer with the front facing you.
7. Open the computer.
8. Remove the M2.5 × 4.5 screw securing the display ground cable to the base enclosure ❶ (Figure 5-8).
9. Disconnect the display video cable ❷.
10. Remove the four M2.5 × 7 screws securing the display hinges to the base enclosure ❸.

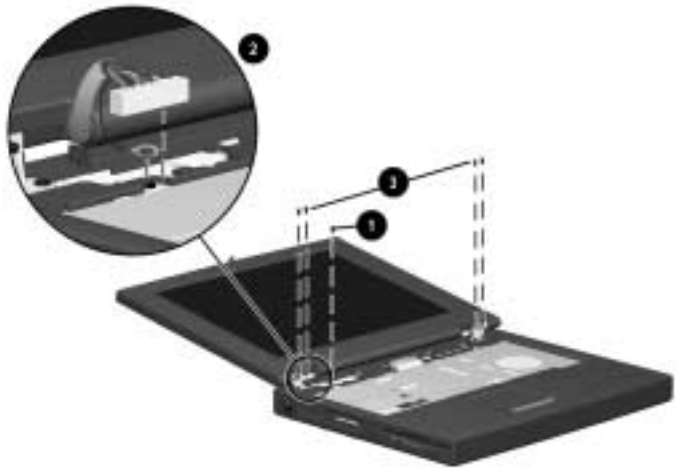

Figure 5–8: Removing the Display

11. Remove the display.

Reverse the above procedure to install the display.



To ensure proper alignment of the display when replacing it, loosely install the screws in the ①, ②, ③, ④, ⑤ sequence indicated in Figure 5-9. After all screws have been loosely installed, tighten them.

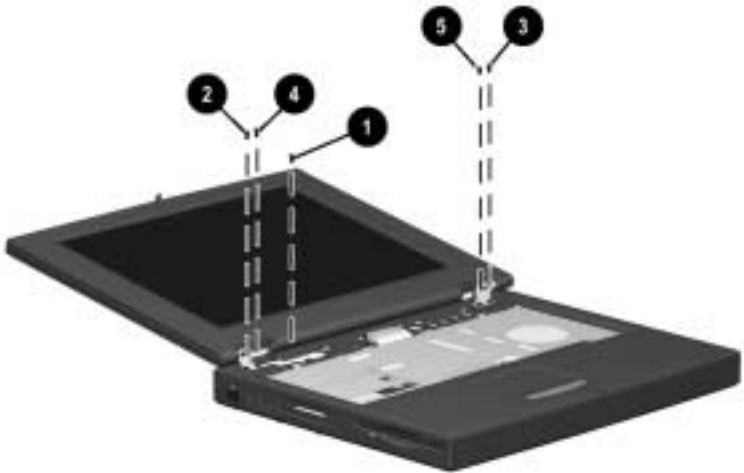

Figure 5–9: Installing the Display Screws

Reverse the above procedure to install the display.

5.9 Heat Sink

Heat Sink Spare Part Number Information

Heat sink	233555-001
-----------	------------

1. Prepare the computer for disassembly (Section 5.3) and, in the order below, remove the following components:
 - LED cover (Section 5.5)
 - Keyboard (Section 5.6)
 - Optical drive (Section 5.7)
 - Display (Section 5.8)



The heat sink is secured to the base enclosure by five screws that are two different sizes. Be sure to carefully note the size and location of each screw.

2. Remove the four M2.5 × 7 screws ❶ and the M2.5 × 4.5 screw ❷ securing the heat sink to the base enclosure (Figure 5-10).

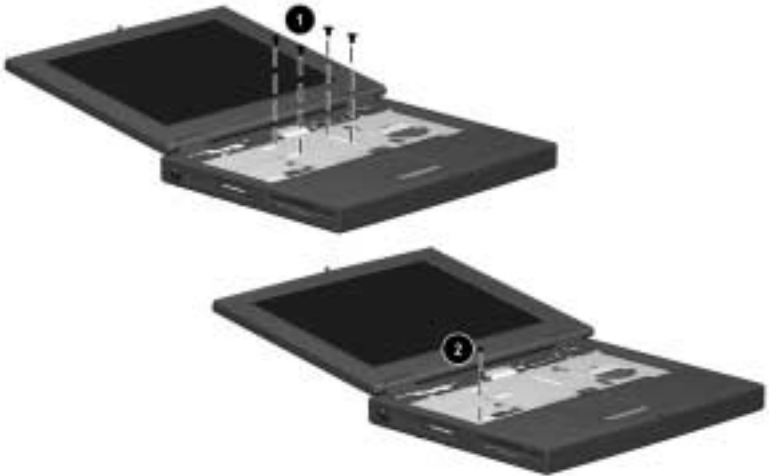

Figure 5–10: Removing the Heat Sink Screws

3. Lift the front edge of the heat sink and swing it up and back until the shield rests at a 45-degree angle ❶ (Figure 5-11).
4. Pull the heat sink away from the base enclosure at a 45-degree angle ❷ and remove it from the base enclosure.

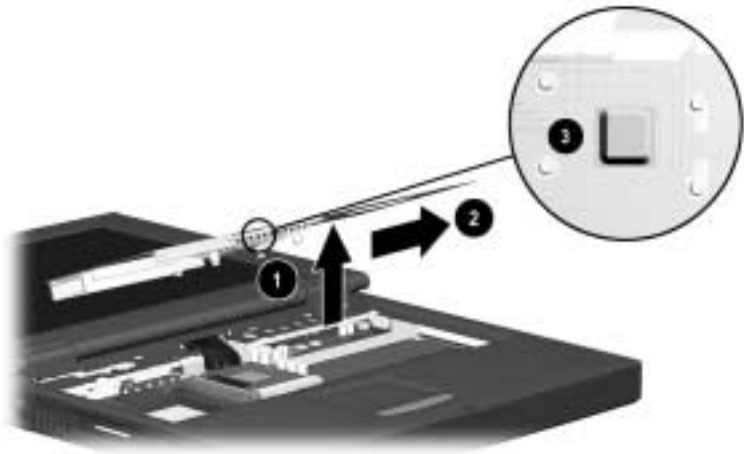

Figure 5–11: Removing the Heat Sink

A thermal pad ❸ is installed on the heat sink and makes contact with the processor. Any time the heat sink is removed, inspect the thermal pad for damage.

Follow these steps to replace a damaged thermal pad:

- a. Carefully peel the old thermal pad from the heat sink area.
- b. Use a plastic straight edge tool (such as a credit card) to remove any thermal pad residue. Glue residue does not need to be totally removed. The glue used on the thermal pad has thermal conducting properties and will flow together with the glue from the new thermal pad.



CAUTION: Do not use any metal tools when removing thermal pad residue from the heat sink or processor. Failure to follow this caution can result in damage to these components and system failure.

- c. Peel the backing from the new thermal pad and position it on the heat sink in the same location as the old pad.

5.10 Processor

Processor Spare Part Number Information

800 MHz Intel Pentium III	233551-001
700 MHz Intel Celeron	233549-001

1. Prepare the computer for disassembly (Section 5.3) and, in the order below, remove the following components:
 - LED cover (Section 5.5)
 - Keyboard (Section 5.6)
 - Optical drive (Section 5.7)
 - Heat sink (Section 5.9)

2. Slide the processor lever to the left ❶ and then swing it up and forward ❷ until it is vertical (Figure 5-12).
3. Lift the outside edges of the processor straight up to remove it from the system board ❸.



When replacing the processor, make sure the processor is seated in the processor socket with the gold triangle in the rear left corner ❹.



If there is any thermal pad residue on the processor ❺, use a plastic straight edge tool (such as a credit card) to remove it. Refer to Section 5.9, “Heat Sink,” for instructions on replacing the thermal pad on the heat sink.

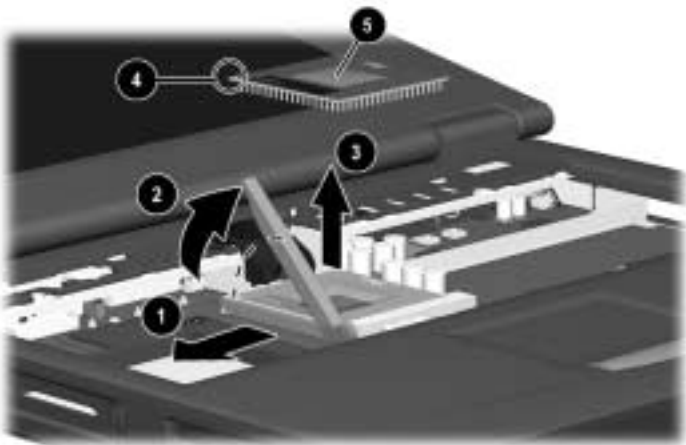

Figure 5–12: Removing the Processor



CAUTION: Do not use any metal tools when removing thermal pad residue from the heat sink or processor. Failure to follow this caution can result in damage to these components and system failure.

5.11 Top Cover

Top Cover Spare Part Number Information

Top cover	233568-001
-----------	------------

1. Prepare the computer for disassembly (Section 5.3) and, in the order below, remove the following components:
 - LED cover (Section 5.5)
 - Keyboard (Section 5.6)
 - Optical drive (Section 5.7)
 - Display (Section 5.8)
 - Heat sink (Section 5.9)
2. Turn the computer bottom side up with the front facing you.



The top cover is secured to the base enclosure by 15 screws that are two different sizes. Be sure to carefully note the size and location from which each screw was removed.

3. Remove the 10 M2.5 × 7 screws ❶ and the three M2.5 × 4.5 screws ❷ securing the top cover to the base enclosure (Figure 5-13).

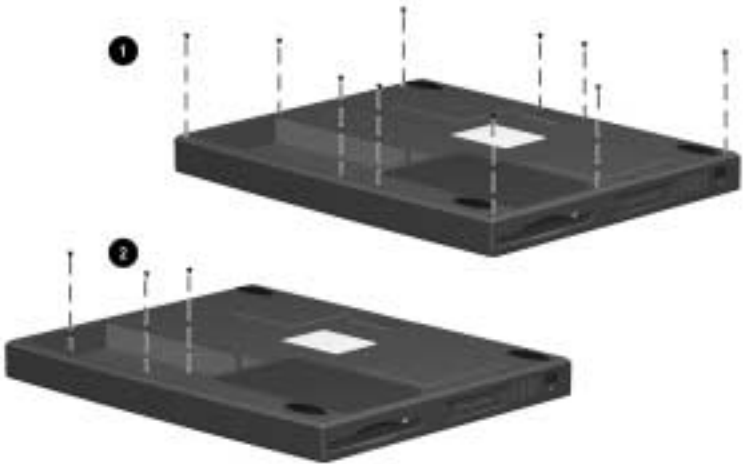

Figure 5–13: Removing the Top Cover Screws

4. Turn the computer top side up with the front facing you.
5. Disconnect the diskette drive cable from the low insertion force (LIF) connector on the system board ❶ (Figure 5-14).
6. Disconnect the TouchPad cable from the LIF connector on the system board ❷.
7. Remove the two M2.5 × 4.5 screws securing the top cover to the base enclosure ❸.
8. Lift the top cover straight up to remove it from the base enclosure ❹.

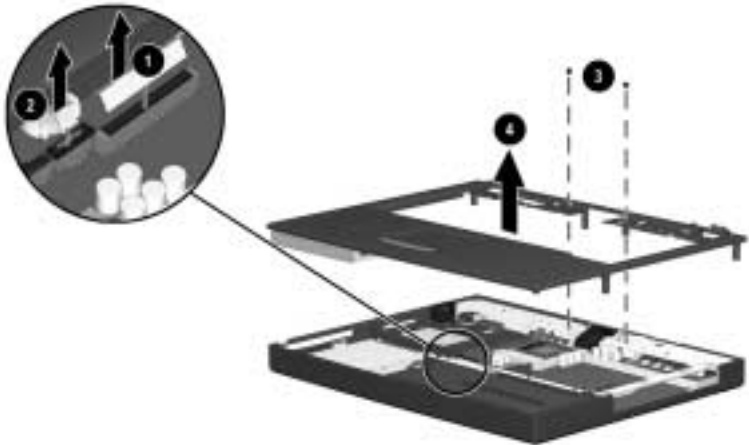

Figure 5–14: Removing the Top Cover

Reverse the above procedure to install the top cover.

5.12 Diskette Drive

Diskette Drive Spare Part Number Information

Diskette drive

233553-001

1. Prepare the computer for disassembly (Section 5.3) and, in the order below, remove the following components:
 - LED cover (Section 5.5)
 - Keyboard (Section 5.6)
 - Optical drive (Section 5.7)
 - Display (Section 5.8)
 - Heat sink (Section 5.9)
 - Top cover (Section 5.11)
2. Turn the top cover bottom side up with the front facing you.

3. Remove the two M2.5 × 4.5 screws securing the diskette drive to the top cover ❶ (Figure 5-15).
4. Remove the tape adhering the diskette drive and TouchPad cables to the top cover ❷.
5. Remove the diskette drive from the top cover ❸.

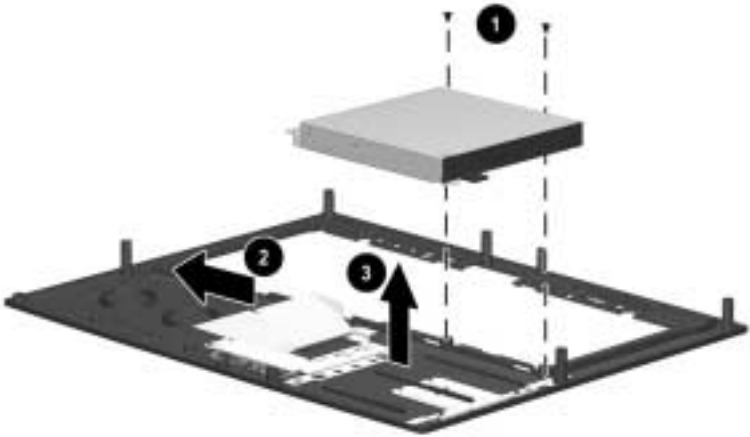

Figure 5-15: Removing the Diskette Drive

Reverse the above procedure to install the diskette drive.



When installing the diskette drive in the top cover, make sure the tab in the front right corner of the diskette drive fits into the slot in the front right corner of the top cover.

5.13 TouchPad

TouchPad Spare Part Number Information

TouchPad

236076-001

1. Prepare the computer for disassembly (Section 5.3) and, in the order below, remove the following components:
 - LED cover (Section 5.5)
 - Keyboard (Section 5.6)
 - Optical drive (Section 5.7)
 - Display (Section 5.8)
 - Heat sink (Section 5.9)
 - Top cover (Section 5.11)

2. Remove the M2.5 × 4.5 screw ❶ securing the TouchPad bracket to the top cover (Figure 5-16).
3. Slide the TouchPad bracket forward ❷.
4. Lift the TouchPad bracket up and remove it from the top cover ❸.

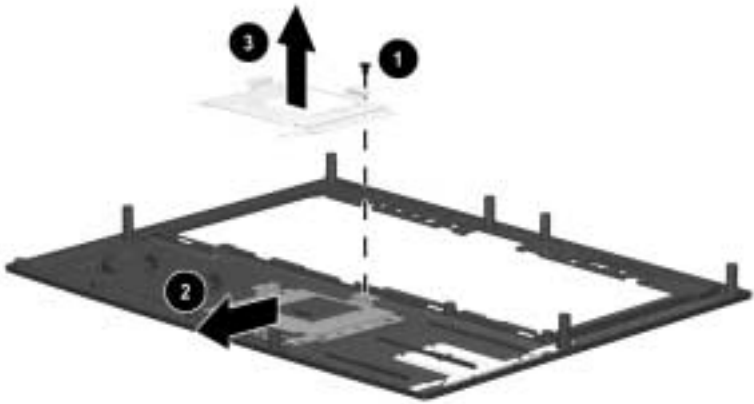

Figure 5–16: Removing the TouchPad Bracket

5. Remove the TouchPad board and cable from the top cover (Figure 5-17).

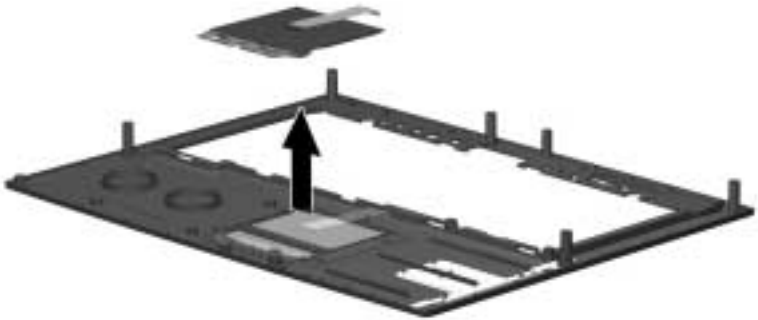

Figure 5–17: Removing the TouchPad

Reverse the above procedure to install the TouchPad.

5.14 Hard Drive

Hard Drive Spare Part Number Information

10-GB hard drive	233554-001
Hard drive bracket (included in Hardware kit)	234005-001



CAUTION: To prevent damage to the computer and hard drive and loss of information, shut down the computer before removing the hard drive from the computer. Do not remove the hard drive while the computer is on, in Suspend (Standby), or in Hibernation. If you are not sure whether the computer is in Hibernation, turn the computer on, then shut it down. If the computer is running a retail version of a Windows operating system, shut down the computer before removing any drive.

1. Prepare the computer for disassembly (Section 5.3) and, in the order below, remove the following components:
 - LED cover (Section 5.5)
 - Keyboard (Section 5.6)
 - Optical drive (Section 5.7)
 - Display (Section 5.8)
 - Heat sink (Section 5.9)
 - Top cover (Section 5.11)

2. Remove the three M2.5 × 5.5 screws ❶ securing the hard drive and hard drive bracket to the base enclosure (Figure 5-18).
3. Remove the hard drive bracket ❷ from the base enclosure.
4. Slide the hard drive toward the front of the base enclosure ❸ to disconnect it from the system board.
5. Remove the hard drive from the base enclosure ❹.

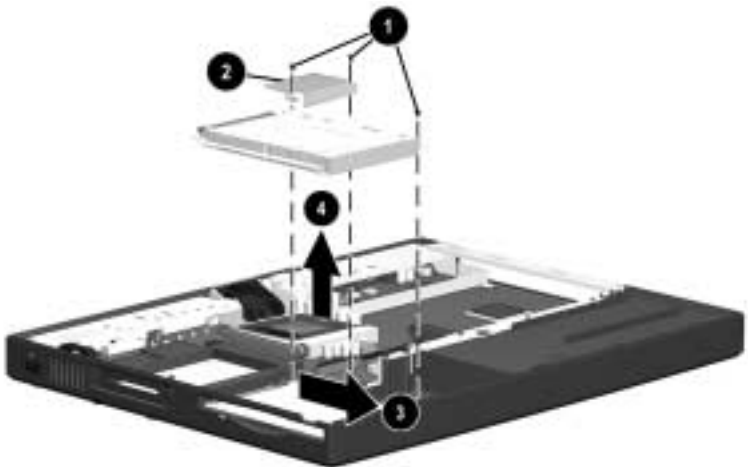

Figure 5–18: Removing the Hard Drive

Reverse the above procedure to install the hard drive.

5.15 Disk Cell Real Time Clock (RTC) Battery

Disk Cell RTC Battery Spare Part Number Information

Disk cell RTC battery

236359-001

1. Prepare the computer for disassembly (Section 5.3) and, in the order below, remove the following components:
 - LED cover (Section 5.5)
 - Keyboard (Section 5.6)
 - Optical drive (Section 5.7)
 - Display (Section 5.8)
 - Heat sink (Section 5.9)
 - Top cover (Section 5.11)

2. Lift the edge of the battery to disconnect it from its socket (Figure 5-19).

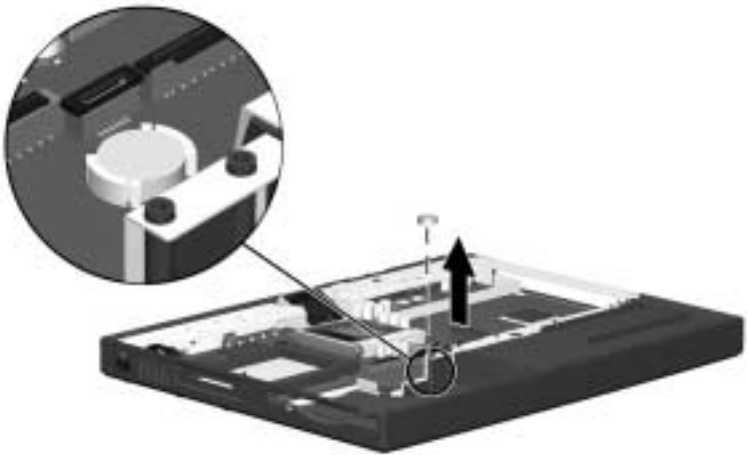

Figure 5–19: Removing the Disk Cell Battery

Reverse the above procedure to install the disk cell RTC battery.

5.16 Fan

Fan Spare Part Number Information

Fan	233552-001
Fan bracket (included in Hardware kit)	234005-001

1. Prepare the computer for disassembly (Section 5.3) and, in the order below, remove the following components:
 - LED cover (Section 5.5)
 - Keyboard (Section 5.6)
 - Optical drive (Section 5.7)
 - Display (Section 5.8)
 - Heat sink (Section 5.9)
 - Top cover (Section 5.11)

2. Remove the two M2.5 × 4.5 screws ❶ securing the fan bracket and fan to the system board (Figure 5-20).
3. Disconnect the fan cable from the system board ❷.
4. Remove the fan bracket ❸ and fan ❹ from the base enclosure.

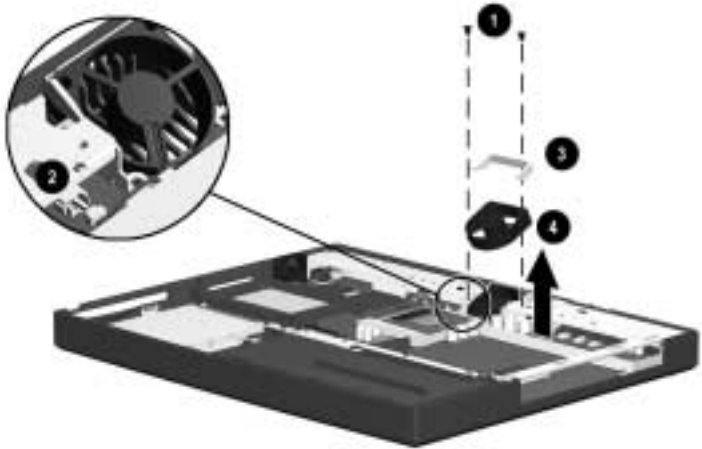

Figure 5–20: Removing the Fan

Reverse the above procedure to install the fan.



When installing the fan, route the fan cable ❶ under the clip ❷ on the processor mount as indicated in Figure 5-21.

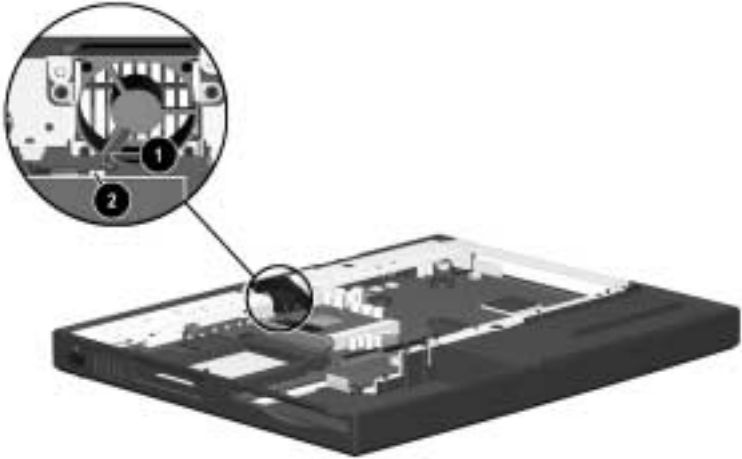

Figure 5–21: Routing the Fan Cable

5.17 System Board

System Board Spare Part Number Information

System board (includes 64 MB SDRAM, left and right speakers, and left and right brackets)	233567-001
---	------------

Optical drive alignment rail (included in Hardware kit)	234005-001
---	------------

1. Prepare the computer for disassembly (Section 5.3) and, in the order below, remove the following components:
 - LED cover (Section 5.5)
 - Keyboard (Section 5.6)
 - Optical drive (Section 5.7)
 - Display (Section 5.8)
 - Heat sink (Section 5.9)
 - Processor (Section 5.10)
 - Top cover (Section 5.11)
 - Hard drive (Section 5.14)
 - Fan (Section 5.16)
2. Turn the base enclosure bottom side up with the rear panel facing you.

3. Remove the four M2.5 × 7 screws from the bottom of the base enclosure securing the system board to the base enclosure (Figure 5-22).

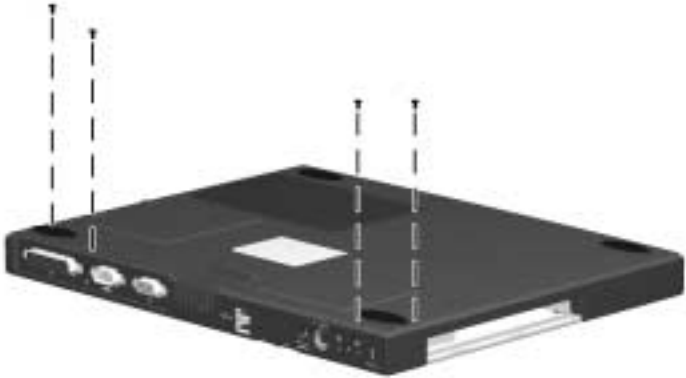

Figure 5-22: Removing the Exterior System Board Screws

4. Turn the base enclosure top side up with the front facing you.

5. Remove the M2.5 × 5.5 screw ❶ securing the optical drive alignment rail to the base enclosure (Figure 5-23).
6. Remove the two M2.5 × 5.5 screws ❷ securing the system board to the base enclosure.
7. Remove the optical drive alignment rail ❸.
8. Disconnect the microphone cable ❹ from the system board.

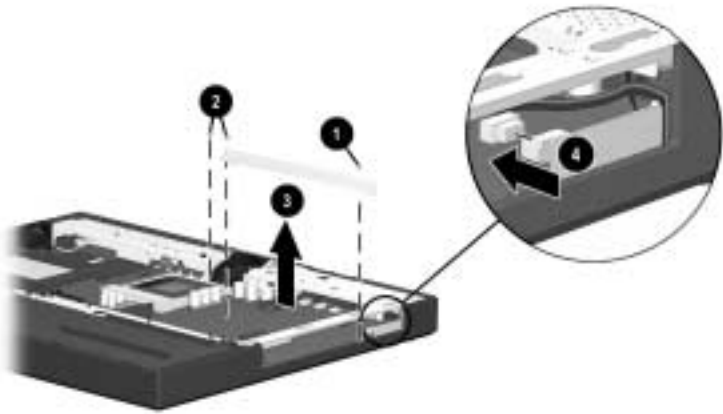

Figure 5–23: Removing the Interior System Board Screws, Optical Drive Alignment Rail, and Disconnecting the Microphone Cable

9. Make sure the PC Card eject button ❶ is fully depressed (Figure 5-24).
10. Lift up the front edge of the system board until the board is at a 45-degree angle ❷.
11. Pull the system board away from the base enclosure at a 45-degree angle ❸.

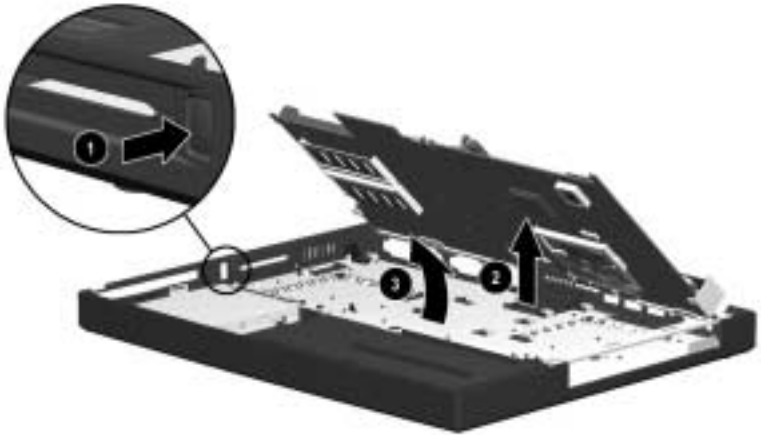

Figure 5–24: Removing the System Board

Reverse the above procedure to install the system board.



When installing the system board, route the microphone cable ❶ through the slot ❷ on the right side of the system board as indicated in Figure 5-25.

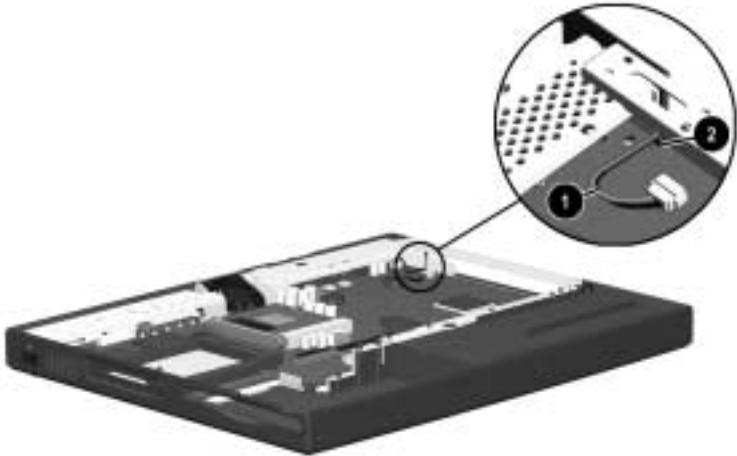

Figure 5–25: Routing the Microphone Cable

6

Specifications

This chapter provides physical and performance specifications.

Table 6-1
Computer

Dimensions

Height	12.5 in	318 mm
Depth	1.7 in	42 mm
Width	9.8 in	248 mm

Weight	7.1 to 7.4 lb depending on display configuration	3.2 to 3.4 kg depending on display configuration
---------------	--	--

Standalone (Battery) Power Requirements

Nominal operating voltage (Li ion)	11.1 VDC
Nominal operating voltage (NiMH)	10.8 VDC

AC Adapter Power Requirements

Rated input power	90 to 264 VAC RMS (auto switching
Rated input current	< 60 W
Rated frequency	47 to 63 Hz

Temperature

Operating	50 to 95°F	10 to 35°C
Nonoperating	-4 to 140°F	-20 to 60°C

Table 6-1
Computer (Continued)

Relative Humidity (non-condensing)

Operating	20 to 80%
Nonoperating	20 to 90%, 101.6°F/38.7°C maximum wet bulb

Altitude (unpressurized)

Operating	0 to 10,000 ft	0 to 3,048 m
Nonoperating	0 to 40,000 ft	0 to 9,144 m

Shock

Operating	0 G, 11 ms, half sine
Nonoperating	60 G, 11 ms, half sine

Vibration

Operating	0.5 G zero to peak, 10 to 500 Hz, 0.5 oct/min sweep rate
Nonoperating	1.0 G zero to peak, 10 to 500 Hz, 0.50 oct/min sweep rate



Applicable product safety standards specify thermal limits for plastic surfaces. The computer operates well within this range of temperatures.

Table 6-2
14.1-inch XGA, TFT Display

Dimensions		
Height	8.42 in	21.40 cm
Depth	11.22 in	28.50 cm
Width	14.10 in	35.81 cm
Number of colors	Up to 16.8 million	
Contrast ratio	180:1	
Brightness	>150 nits typical	
Pixel resolution		
Pitch		0.279 × 0.279 mm
Format	1024 × 768	
Configuration	RGB vertical stripe	
Backlight	Cold cathode fluorescent, 1 tube	
Character display	80 × 25	
Refresh	60 Hz	
Total Power Consumption	8.0 W	

Table 6-3
12.1-inch SVGA, TFT Display

Dimensions

Height	7.83 in	19.90 cm
Depth	10.83 in	27.50 cm
Width	12.10 in	30.74 cm

Number of colors Up to 16.8 million

Contrast ratio 250:1

Brightness >120 nits typical

Pixel resolution

Pitch		0.3075 × 0.3075 mm
Format	800 × 600	
Configuration	RGB vertical stripe	

Backlight Cold cathode fluorescent, 1 tube

Character display 80 × 25

Refresh 60 Hz

Total Power Consumption 4.5 W

Table 6-4
10.0-GB Hard Drive

User capacity per drive¹	10.0 GB	
Drive height (with drive frame)	0.37 in	9.5 mm
Drive width (with drive frame)	2.5 in	63.5 mm
Interface type	ATA-4	
Seek times (typical read, including setting)		
Single track	2.5 ms	
Average	12.0 ms	
Full stroke	23.0 ms	
User addressable sectors³	19,640,880	
Logical configuration		
Cylinders	16,683	
Heads	16	
Sectors per track	63	

Table 6-4
10.0-GB Hard Drive (Continued)

Physical configuration

Cylinders ³	22784
Heads	2
Sectors per track ³	293-560
Bytes per sector	512

User addressable sectors³ 19,640,880

Buffer size³ 512 KBytes

Disk rotational speed 4200 rpm

Transfer rate

Interface max (Mbytes/sec) ²	66.6
Media (Mbits/sec) ³	109-20

¹ 1 GB = 1,000,000,000 bytes.

² System capability may differ.

³ Actual drive specifications may differ slightly.

Certain restrictions and exclusion apply. Consult the Compaq Customer Support Center for details.

**Table 6-5
Diskette Drive**

Diskette size	3.5 inch	
Light	On system	
Height	0.5 in	12.7 mm
Bytes per sector	512	
Sectors per track		
High density	18 (1.44 MB)	15 (1.2 MB)
Low density	9	
Tracks per side		
High density	80	
Low density	80	
Read/write heads	2	
Average seek times		
Track-to-track (high/low)	3 ms	6 ms
Average (high/low)	95 ms	174 ms
Settling time	15 ms	
Latency average	100 ms	

Table 6-6
CD-ROM Drive

Applicable disk	CD-ROM (Mode 1, 2, and 3) CD-XA ready (Mode 2, Form 1 and 2) CD-I ready (Mode 2, Form 1 and 2) CD-R (read only) CD Plus Photo CD (single/multisession) CD-Extra Video CD CD-WO (fixed packets only) CD-Bridge	
Center hole diameter	.59 in	15 mm
Disk diameter	12 cm, 8 cm	
Disk thickness	1.2 mm	
Track pitch	1.6 μ	
Access time		
Random	< 150 ms	
Full Stroke	< 300 ms	
Cache buffer	128 KB	
Data transfer rate		
Sustained, 24X	2400 KB/sec (150 KB/sec at 1X)	
Variable	1500 to 3600 KB/sec (10X to 24X)	
Normal PIO Mode 4 (single burst)	16.66 KB/sec	
Startup time	< 8 seconds	
Stop time	< 4 seconds	

Table 6-7
DVD-ROM Drive

Applicable disk	DVD-5, DVD-9, DVD-10 CD-ROM (Mode 1 and 2) CD Digital Audio CD-XA ready (Mode 2, Form 1 and 2) CD-I ready (Mode 2, Form 1 and 2) CD-R (read only) CD Plus Photo CD (single/multisession) CD-Bridge	
Center hole diameter	.59 in	15 mm
Disk diameter	12 cm, 8 cm	
Disk thickness	1.2 mm	
Track pitch	.74 μ	
Access time		
Random	< 150 ms	
Full Stroke	< 225 ms	
Audio output level		
Lineout	0.7 V rms	
Headphone	none	
Cache buffer	128 KB	
Data transfer rate		
Sustained, 1X DVD rate	150 KB/sec	
Sustained, 16X DVD rate	2400 KB/sec	
Sustained, 1X DVD rate	1380 KB/sec	
Sustained, 4X DVD rate	5520 KB/sec	
Normal IO Mode 4 (single burst)	16.6 MB/sec	
Startup time	< 15 seconds	
Stop time	< 6 seconds	

Table 6-8
AC Adapter

Weight	0.45 lb	0.21 kg
Power supply (input)		
Operating voltage	100 to 240 VAC RMS Nominal	
Operating current	1.5 A RMS	
Operating frequency range	50 to 60 Hz Nominal	
Maximum transient	4/50 kV	

**Table 6-9
Battery Packs**

Dimensions

Lithium ion (Li ion)		
Height	0.83 in	21 mm
Length	3.15 in	166
Width	6.55 in	81
Weight	0.97 lb	0.44 kg
Cells	9 Li ion	
Nickel Metal Hydride (NiMH)		
Height	0.83 in	21 mm
Length	3.15 in	166
Width	6.55 in	81
Weight	0.132 lb	0.60 kg
Cells	9 NiMH	

Energy

Li ion		
Voltage	11.1 V	
Amp-hour capacity	4.8 Ah	
Watt-hour capacity	53.2 Wh	
NiMH		
Voltage	10.8 V	
Amp-hour capacity	4.5 Ah	
Watt-hour capacity	48.6 Wh	

Environmental requirements

Temperature		
Operating	50°F to 104°F	10°C to 40°C
Nonoperating	-12°F to 140°F	-30°C to 60°C

Table 6-10
System DMA

Hardware DMA	System Function
DMA0	Available for audio
DMA1	Entertainment audio (default; alternate = DMA0, DMA3, none)
DMA2	Diskette drive
DMA3	ECP parallel port LPT1 (default; alternate = DMA0, none)
DMA4	DMA controller cascading (not available)
DMA5	Available for PC Card
DMA6	not assigned
DMA7	not assigned

 PC Card controller can use DMA 1, 2, or 5.

**Table 6-11
System Interrupts**

Hardware IRQ	System Function
IRQ0	System timer
IRQ1	Keyboard controller
IRQ2	Cascaded
IRQ3	COM2
IRQ4	COM1
IRQ5	Audio (default)*
IRQ6	Diskette drive
IRQ7	Parallel port
IRQ8	Real time clock (RTC)
IRQ9	Infrared
IRQ10	System use
IRQ11	System use
IRQ12	Internal point stick or external mouse
IRQ13	Coprocessor (not available to any peripheral)
IRQ14	IDE interface (hard drive and optical drive)
IRQ15	System use

 PC Cards may assert IRQ3, IRQ4, IRQ5, IRQ7, IRQ9, IRQ10, IRQ11, or IRQ15. Either the infrared or the serial port may assert IRQ3 or IRQ 4.

*Default configuration; audio possible configurations are IRQ5, IRQ7, IRQ9, IRQ10, or none.

Table 6-12
System I/O Addresses

I/O Address (hex)	System Function (shipping configuration)
000 - 00F	DMA controller no. 1
010 - 01F	unused
020 - 021	Interrupt controller no. 1
022 - 024	Opti chipset configuration registers
025 - 03F	unused
02E - 02F	87334 "Super IO" configuration for CPU
040 - 05F	Counter/timer registers
044 - 05f	unused
060	Keyboard controller
061	Port b
062 - 063	unused
064	Keyboard controller
065 - 06F	unused
070 - 071	NMI enable/real time clock
072 - 07F	unused
080 - 08F	DMA page registers
090 - 091	unused
092	Port A
093 - 09F	unused
0A0 - 0A1	Interrupt controller no. 2

Table 6-12
System I/O Addresses (Continued)

I/O Address (hex)	System Function (shipping configuration)
0A2 - 0BF	unused
0C0 - 0DF	DMA controller no. 2
0E0 - 0EF	unused
0F0 - 0F1	Coprocessor busy clear/reset
0F2 - 0FF	unused
100 - 16F	unused
170 - 177	Secondary fixed disk controller
178 - 1EF	unused
1F0 - 1F7	Primary fixed disk controller
1F8 - 200	unused
201	Joystick (decoded in ESS1688)
202 - 21F	unused
220 - 22F	Entertainment audio
230 - 26D	unused
26E - 26	unused
278 - 27F	unused
280 - 2AB	unused
2A0 - 2A7	unused
2A8 - 2E7	unused
2E8 - 2EF	Reserved serial port

Table 6-12
System I/O Addresses (*Continued*)

I/O Address (hex)	System Function (shipping configuration)
2F0 - 2F7	unused
2F8 - 2FF	Infrared port
300 - 31F	unused
320 - 36F	unused
370 - 377	Secondary diskette drive controller
378 - 37F	Parallel port (LPT1/default)
380 - 387	unused
388 - 38B	FM synthesizer - OPL3
38C - 3AF	unused
3B0 - 3BB	VGA
3BC - 3BF	Reserved (parallel port/no EPP support)
3C0 - 3DF	VGA
3E0 - 3E1	PC Card controller in CPU
3E2 - 3E3	unused
3E8 - 3EF	Internal modem
3F0 - 3F7	"A" diskette controller
3F8 - 3FF	Serial port (COM1/default)
CF8 - CFB	PCI configuration index register (PCIDIVO-1)
CFC - CFF	PCI configuration data register (PCIDIVO-1)

Table 6-13
System Memory Map

Size	Memory Address	System Function
640 K	00000000 - 0009FFFF	Base memory
128 K	000A0000 - 000BFFFF	Video memory
48 K	000C0000 - 000CBFFF	Video BIOS
160 K	000C8000 - 000E7FFF	unused
64 K	000E8000 - 000FFFFFF	System BIOS
15 M	00100000 - 00FFFFFF	Extended memory
58 M	01000000 - 047FFFFFF	Super extended memory
58 M	04800000 - 07FFFFFF	unused
2 M	08000000 - 080FFFFFF	Video memory (direct access)
4 G	08200000 - FFFEFFFF	unused
64 K	FFFF0000 - FFFFFFFF	System BIOS

A

Connector Pin Assignments

Table A-1
Stereo Speaker/Headphone



Pin	Signal	Pin	Signal
1	Audio out	2	Ground

Table A-2
Microphone



Pin	Signal	Pin	Signal
1	Audio in	2	Ground

Table A-3
Keyboard/Mouse

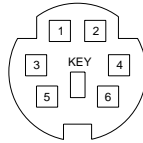

Pin	Signal	Pin	Signal
1	Keyboard/mouse data1	4	+5 VDC
2	Keyboard/mouse data2	5	Keyboard/mouse clock1
3	Ground	6	Keyboard/mouse clock2

Table A-4
RJ-11 Modem



Pin	Signal	Pin	Signal
1	Unused	4	Unused
2	Tip	5	Unused
3	Ring	6	Unused

**Table A-5
RJ-45 Network Interface**

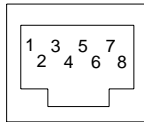

Pin	Signal	Pin	Signal
1	Transmit +	5	Unused
2	Transmit -	6	Receive -
3	Receive +	7	Unused
4	Unused	8	Unused

**Table A-6
Universal Serial Bus**



Pin	Signal	Pin	Signal
1	+5 VDC	3	Data +
2	Data -	4	Ground

Table A-7
Serial

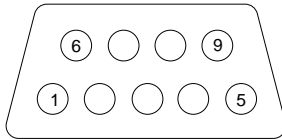

Pin	Signal	Pin	Signal
1	Carrier detect	6	Data set ready
2	Receive data	7	Ready to send
3	Transmit data	8	Clear to send
4	Data terminal ready	9	Ring indicator
5	Signal ground		

Table A-8
External Monitor

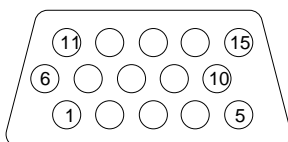

Pin	Signal	Pin	Signal
1	Red analog	9	+5 VDC
2	Green analog	10	Ground
3	Blue analog	11	Monitor detect
4	Not connected	12	DDC 2B data
5	Ground	13	Horizontal sync
6	Ground analog	14	Vertical sync
7	Ground analog	15	DDC2B clock
8	Ground analog		

Table A-9
Parallel

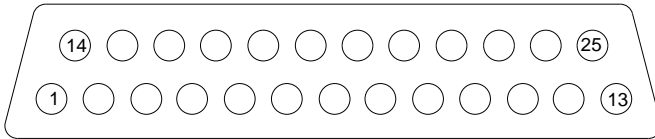

Pin	Signal	Pin	Signal
1	Strobe*	10	Acknowledge*
2	Data bit 0	11	Busy
3	Data bit 1	12	Paper out
4	Data bit 2	13	Select
5	Data bit 3	14	Auto line feed*
6	Data bit 4	15	Error*
7	Data bit 5	16	Initialize printer*
8	Data bit 6	17	Select in*
9	Data bit 7	18-25	Signal ground

*Signal is active low.

Power Cord Set Requirements

3-Conductor Power Cord Set

The wide range input feature of the Compaq Armada M700 Series of Personal Computers permits it to operate from any line voltage from 100 to 120 or 220 to 240 volts AC.

The power cord set received with the computer meets the requirements for use in the country where the equipment is purchased.

Power cord sets for use in other countries must meet the requirements of the country where the computer is used. For more information on power cord set requirements, contact a Compaq authorized reseller or service provider.

General Requirements

The requirements listed below are applicable to all countries:

1. The length of the power cord set must be at least 5.00 feet (1.5 m) and a maximum of 6.50 feet (2.0 m).
2. All power cord sets must be approved by an acceptable accredited agency responsible for evaluation in the country where the power cord set will be used.

3. The power cord set must have a minimum current capacity of 10A and a nominal voltage rating of 125 or 250 volts AC, as required by each country's power system.
4. The appliance coupler must meet the mechanical configuration of an EN 60 320/IEC 320 Standard Sheet C13 connector, for mating with appliance inlet on the back of the computer.

Country-Specific Requirements

3-Conductor Power Cord Set Requirements—By Country

Country	Accredited Agency	Applicable Note Number
Australia	EANSW	1
Austria	OVE	1
Belgium	CEBC	1
Canada	CSA	2
Denmark	DEMKO	1
Finland	FIMKO	1
France	UTE	1
Germany	VDE	1
Italy	IMQ	1
Japan	METI	3
The Netherlands	KEMA	1
Norway	NEMKO	1
Sweden	SEMKO	1
Switzerland	SEV	1
United Kingdom	BSI	1
United States	UL	2

Notes

1. The flexible cord must be <HAR> Type HO5VV-F, 3-conductor, 1.0 mm² conductor size. Power cord set fittings (appliance coupler and wall plug) must bear the certification mark of the agency responsible for evaluation in the country where it will be used.
2. The flexible cord must be Type SPT-3 or equivalent, No. 18 AWG, 3-conductor. The wall plug must be a two-pole grounding type with a NEMA 5-15P (15A, 125V) or NEMA 6-15P (15A, 250V) configuration.
3. The appliance coupler, flexible cord, and wall plug must bear a “T” mark and registration number in accordance with the Japanese Dentori Law. The flexible cord must be Type VCT or VCTF, 3-conductor, 1.00mm² conductor size. The wall plug must be a two-pole grounding type with a Japanese Industrial Standard C8303 (7A, 125V) configuration.

C

Screw Listing

This appendix provides specification and reference information for the screws used in the Compaq Armada 110 Series. All screws listed in this appendix are available in the Miscellaneous Screw Kit, spare part number 233656-001.

Table C-1
M2.5 × 5 Screw

	Color	Qty	Length	Thread	Head Width
	Black	2	5 mm	M2.5	5.5 mm

Where used: 2 screws securing the keyboard to the base enclosure (documented in Section 5.7)



Table C-2
M2.5 × 4.5 Screw





Color	Qty	Length	Thread	Head Width
Black	15	4.5 mm	M2.5	4 mm

Where used: 2 screws securing the hinge covers to the display hinges (documented in Section 5.6).



Table C-2
M2.5 × 4.5 Screw (Continued)

 	Color	Qty	Length	Thread	Head Width
	Black	15	4.5 mm	M2.5	4 mm

Where used:

- ❶ 1 screw securing the optical drive to the heat sink (documented in Section 5.8)
 - ❷ 1 screw securing the display ground cable to the base enclosure (documented in Section 5.9)
 - ❸ 1 screw securing the heat sink to the base enclosure (documented in Section 5.10)
-

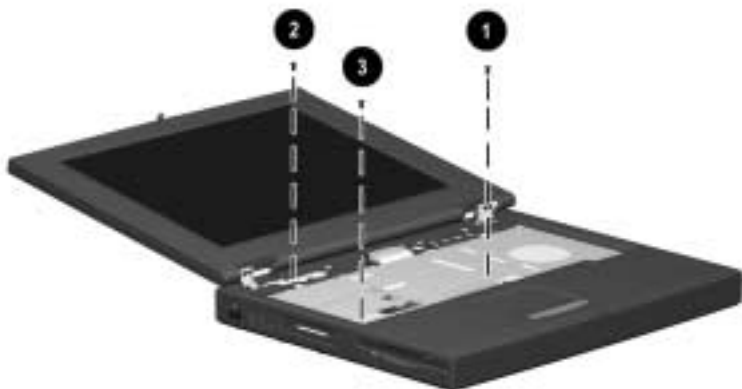
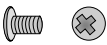

Table C-2
M2.5 × 4.5 Screw (Continued)

	Color	Qty	Length	Thread	Head Width
	Black	15	4.5 mm	M2.5	4 mm

Where used:

- ❶ 3 screws securing the top cover to the base enclosure through the battery bay (documented in Section 5.11)
- ❷ 2 screws securing the top cover to the base enclosure through the top (documented in Section 5.11)

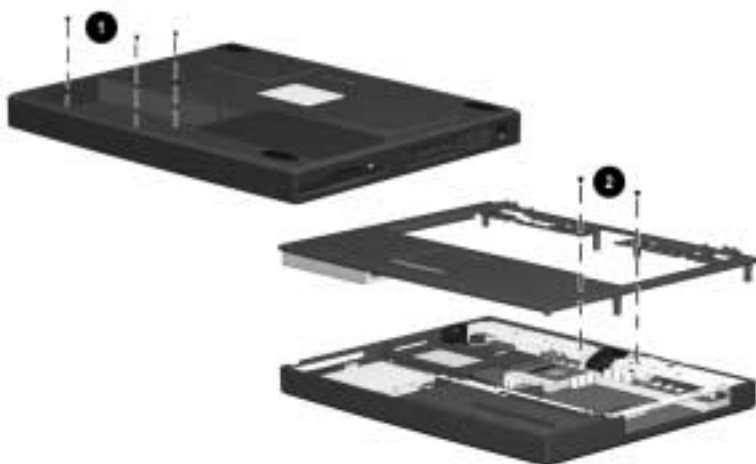



Table C-2
M2.5 × 4.5 Screw (Continued)

 	Color	Qty	Length	Thread	Head Width
	Black	15	4.5 mm	M2.5	4 mm

Where used:

- ❶ 2 screws securing the diskette drive to the top cover (documented in Section 5.12)
 - ❷ 1 screw securing the TouchPad to the top cover (documented in Section 5.13)
-

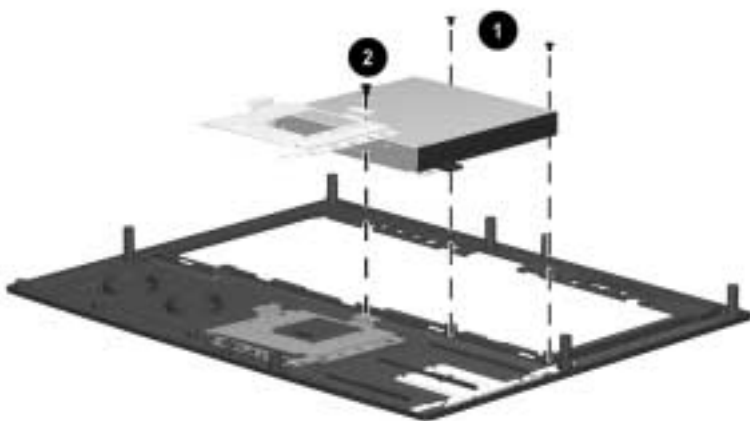
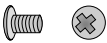



Table C-2
M2.5 × 4.5 Screw (Continued)

	Color	Qty	Length	Thread	Head Width
	Black	15	4.5 mm	M2.5	4 mm

Where used: 2 screws securing the fan and fan bracket to the base enclosure (documented in Section 5.16)



Table C-3
M2.5 × 7 Screw

	Color	Qty	Length	Thread	Head Width
	Black	25	7 mm	M2.5	4.5 mm

Where used:

- 1 screw securing the modem/network interface card compartment cover to the base enclosure (refer to the *Hardware Guide* included with the computer for installation procedure)
 - 2 screws securing the memory expansion compartment cover to the base enclosure (refer to the *Hardware Guide* included with the computer for installation procedure)
 - 4 screws securing the display to the base enclosure (illustrated below; documented in Section 5.9)
-

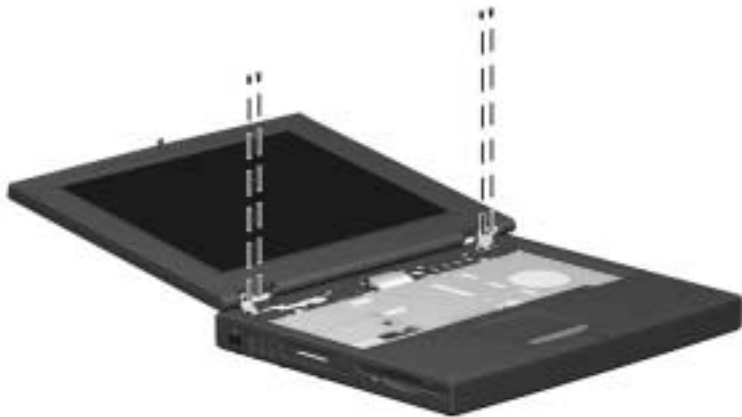



Table C-3
M2.5 x 7 Screw (Continued)

	Color	Qty	Length	Thread	Head Width
	Black	25	7 mm	M2.5	4.5 mm

Where used:

- ❶ 4 screws securing the heat sink to the base assembly (documented in Section 5.10)
 - ❷ 10 screws securing the top cover to the base enclosure through the bottom of the computer (documented in Section 5.11)
-

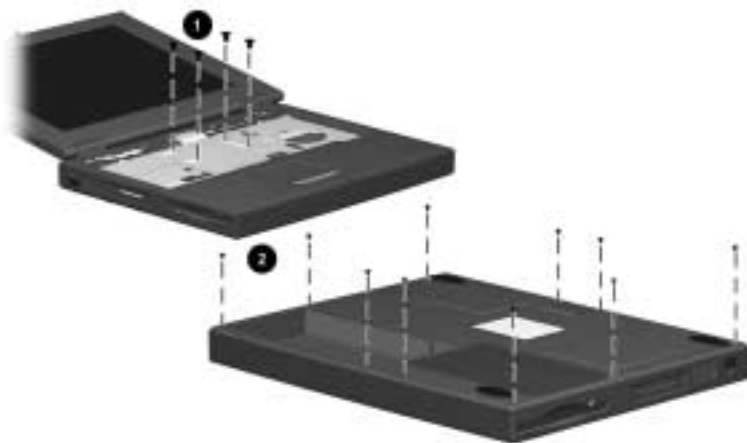



Table C-3
M2.5 x 7 Screw (Continued)

	Color	Qty	Length	Thread	Head Width
	Black	25	7 mm	M2.5	4.5 mm

Where used: 4 screws securing the system board to the base enclosure through the computer bottom (documented in Section 5.17)

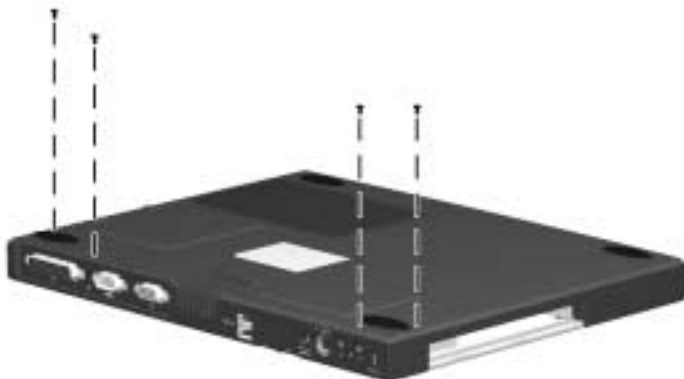
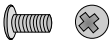

Table C-4
M2.5 × 5.5 Screw



Color	Qty	Length	Thread	Head Width
Black	6	5.5 mm	M2.5	4.5 mm

Where used:

- ❶ 3 screws securing the hard drive and hard drive bracket to the base enclosure (documented in Section 5.14)
 - ❷ 1 screw securing the optical drive alignment rail to the base enclosure (documented in Section 5.17)
 - ❸ 2 screws securing the system board to the base enclosure (documented in Section 5.17)
-

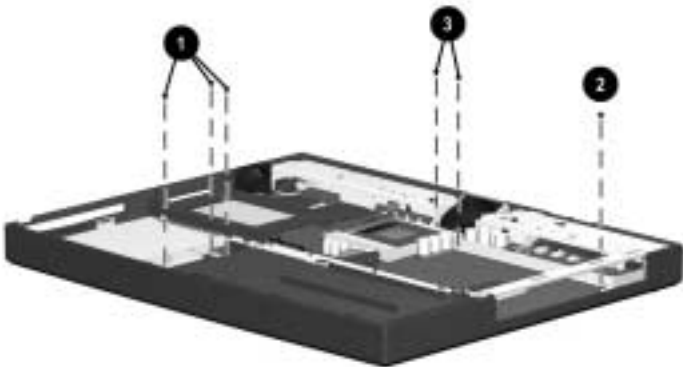

Index

A

- AC adapter
 - spare part numbers 3-11
 - specifications 6-10

B

- base enclosure
 - illustrated 3-4
 - spare part number 3-5
- battery
 - illustrated 3-4
 - release latch 1-17
 - spare part number 3-5
 - specifications 6-11
- batteyr
 - light 1-15

C

- Cable Kit
 - components 3-8
 - spare part number 3-8
- cables 4-2
- caps lock
 - key 1-13
 - light 1-15

CD-ROM drive

- alignment rail 5-39
 - illustrated 3-7
- illustrated 3-4, 3-9
- removal 5-10
- spare part number 3-5, 5-10
- specifications 6-8

Certificate of Authenticity

- label 1-17

computer

- bottom components 1-17
- display components 1-9
- features 1-4
- feet
 - illustrated 3-6
 - locations 5-5
- keyboard components 1-13
- left side components 1-9
- models 1-2
- rear panel components 1-10
- right side components 1-10
- specifications 6-1
- top components 1-14

- connector pin assignments
 - A-1
 - headphone jack A-1
 - keyboard connector A-2
 - microphone jack A-1
 - modem jack A-2
 - monitor connector A-5
 - mouse connector A-2
 - network interface jack A-3
 - parallel connector A-6
 - RJ-11 jack A-2
 - RJ-45 jack A-3
 - serial connector A-4
 - speaker jack A-1
 - universal serial bus (USB) connector A-3
- connectors 4-2
- cursor control keys 1-13
- D**
- design overview 1-18
- disassembly sequence chart
 - 5-3
- disk cell battery
 - removal 5-32
 - spare part number 3-5, 5-32
- diskette drive 1-9
 - cable
 - illustrated 3-8
 - removal 5-24
 - illustrated 3-2, 3-9
 - removal 5-25
 - spare part number 3-5, 5-25
 - specifications 6-7
- display
 - ground cable 5-14
 - illustrated 3-2
 - installation 5-15
 - release latch 1-9
 - removal 5-12
 - spare part number 3-3, 5-12
 - specifications 6-3, 6-4
 - switch 1-13
 - video cable 5-14
- DMA specifications 6-12
- drives, preventing damage 4-2
- DVD-ROM drive
 - alignment rail 5-39
 - illustrated 3-7
 - illustrated 3-4, 3-9
 - removal 5-10
 - spare part number 3-5, 5-10
 - specifications 6-9
- E**
- Easy Access buttons 1-15
- electrostatic
 - damage, preventing 4-4
 - voltage levels 4-7
- embedded numeric keypad
 - 1-13
- F**
- F1 through F12 keys 1-13
- fan
 - bracket 5-35
 - illustrated 3-7
 - installation 5-36
 - removal 5-34

- spare part number 3–5, 5–34
- vent 1–17
- Fn key 1–13
- front label area 1–17
- G**
- grounding
 - equipment 4–6
 - methods 4–6
- H**
- hard drive
 - bracket
 - illustrated 3–7
 - removal 5–31
 - illustrated 3–9
 - light 1–14
 - removal 5–30
 - spare part number 3–5, 5–30
 - specifications 6–5
- Hardware Kit
 - components 3–5, 3–7
 - spare part number 3–5, 3–7
- headphone jack 1–10
 - pin assignments A–1
- heat sink
 - illustrated 3–2
 - removal 5–16
 - spare part number 3–3, 5–16
- hinge covers
 - illustrated 3–6
 - removal 5–13
- I**
- I/O address specifications 6–14
- illustrated parts catalog 3–1
- infrared
 - port 1–9
- interrupt specifications 6–13
- K**
- keyboard
 - components 1–12
 - connector 1–11
 - pin assignments A–2
 - illustrated 3–2
 - removal 5–7
 - spare part number 3–3, 5–7
- L**
- LED cover
 - illustrated 3–2
 - removal 5–6
 - spare part number 3–3, 5–6
- Logo Kit spare part number 3–11
- M**
- mass storage devices
 - illustrated 3–9
 - spare part numbers 3–9
- memory
 - expansion board, spare part numbers 3–11
 - expansion compartment 1–17
 - expansion slot cover, illustrated 3–6

memory map specifications
6–17

microphone 1–15

 cable

 disconnecting 5–39

 routing 5–41

 jack 1–10

 pin assignments A–1

Microsoft logo key 1–13

mini PCI slot cover 1–17

 illustrated 3–6

modem

 adapter, spare part numbers
 3–10

 cable adapter, spare part
 numbers 3–10

 cable, spare part number
 3–10

 jack, pin assignments A–2

 spare part numbers 3–10

monitor connector 1–11

 pin assignments A–5

mouse connector 1–11

 pin assignments A–2

N

network interface jack

 pin assignments A–3

num lock light 1–15

O

optical drive 1–10

 alignment rail 5–39

 illustrated 3–7

 illustrated 3–4

 removal 5–10

 spare part number 3–5,
 5–10

 specifications 6–8, 6–9

P

packing precautions 4–4

parallel connector 1–11

 pin assignments A–6

PC Card

 eject button 1–9

 slot 1–9

plastic parts 4–2

Plastics Kit

 components 3–3, 3–6

 illustrated 3–2

 spare part number 3–3, 3–6

power

 button 1–15

 cord

 3-conductor set B–1

 country-specific

 requirements B–2

 general requirements

 B–1

 notes B–3

 set requirements B–1

 spare part numbers

 3–11

 jack 1–11

Power Management 1–6

preparing the computer for

 disassembly 5–4

processor

 spare part number 3–5

R

removal

- preliminaries 4-1
- procedures 5-1

replacement

- preliminaries 4-1
- procedures 5-1

RJ-11

- cable, illustrated 3-8
- cover, illustrated 3-6
- jack 1-11
 - pin assignments A-2
- P55 adapter spare part numbers 3-10
- PTT adapter spare part number 3-10

RJ-45

- cable, illustrated 3-8
- cover, illustrated 3-6
- jack 1-11
 - pin assignments A-3
- network cable
 - spare part number 3-10

RTC battery

- removal 5-32
- spare part number 3-5, 5-32

S

Screw Kit

- components C-1
- spare part number 3-11
- screw listing C-1
- scroll lock light 1-15
- security cable slot 1-10

serial connector 1-11

- pin assignments A-4

serial number location 1-17, 3-1, 5-2

service considerations 4-1

speaker jack 1-10

- pin assignments A-1

speakers 1-14

specifications

- AC adapter 6-10
- battery 6-11
- CD-ROM drive 6-8
- computer 6-1
- diskette drive 6-7
- display 6-3, 6-4
- DMA 6-12
- DVD-ROM drive 6-9
- hard drive 6-5
- I/O addresses 6-14
- interrupts 6-13
- memory map 6-17
- optical drive 6-8, 6-9
- static shielding materials 4-7
- system board
 - illustrated 3-4
 - removal 5-37
 - spare part number 3-5, 5-37

T

tools required 4-1

top cover

- illustrated 3-2
- removal 5-22
- spare part number 3-3, 5-22

- TouchPad 1–15
 - bracket 5–28
 - buttons 1–15
 - cable
 - illustrated 3–8
 - removal 5–24
 - illustrated 3–2
 - removal 5–27
 - spare part number 3–3, 5–27
- transporting precautions 4–4
- troubleshooting 2–1

U

- universal serial bus (USB)
 - connector 1–11
 - pin assignments A–3

V

- vent 1–9, 1–11

W

- Windows application key 1–13
- workstation precautions 4–5