

# Handling Precautions

---



## CAUTION

*High potential static charge can cause damage to the integrated circuits on the board. Before handling any mainboard outside of its protective packaging, ensure that there is no static electric charge on your body.*

*Danger of explosion if battery is incorrectly replaced. Replace only with the same or equivalent type recommended by the manufacturer.*

There are some basic precautions when handling the motherboard or other computer components:

- ◆ Keep the board in its anti-static bag until you are ready to install it.
- ◆ Protect your board from static electricity by well grounding of your body and the equipment during the installation, such as wearing a grounded wrist strap.
- ◆ Always handle the board by its edges.
- ◆ Do not touch with the components on the boards, add-on cards and modules, or the “gold finger” connectors going to be plugged into the expansion slot. It is best to handle system components by their mounting bracket.
- ◆ Ensure the system power is completely turn-off before doing any installation work.

## Notice to Customers

---

The information contained in this User's Guide with no liability whatsoever, and disclaims any express or implied warranty, relating to sale and/or use of products including liability or warranties relating to fitness for a particular purpose, merchantability, or infringement of any patent, copyright or other intellectual property right. We shall not be liable for any loss or profits, loss of business, loss of use or data, interruption of business, or for indirect, special, incidental, or consequential damages arising from any defect or error in this User's Guide or product.

We retains the right to make changes on this User's Guide and product descriptions at any time, without notice.

---



# Trademarks™

---

**Intel®**, **Pentium®** are registered trademarks of Intel Corporation.

**IBM**, **IBM PC**, **IBM PC/AT**, **PC-DOS**, **OS/2** and **OS/2 WARP** are registered trademarks of International Business Machines Corporation.

**MS-DOS**, **Windows** and **Windows 95** are registered trademarks of Microsoft Corporation.

**AWARD BIOS** is a product of Award Software International Inc.

**Third-party brands and names mentions in this User's Guide are the property of their respective owners.**

User's Guide Revision : 1.6

Release Date : July 1998

Copyright © 1998, All rights reserved.

---



# Table of Contents

---

<i>OVERVIEW</i> .....	1
<i>FEATURES SUMMARY</i> .....	1
<i>INSTALLATION PRECAUTIONS</i> .....	2
<i>A QUICK INTRODUCTION</i> .....	2
<i>CPU INSTALLATION</i> .....	3
<i>INSTALLING SYSTEM MEMORY (RAM)</i> .....	4
<i>EXPANSION CARDS INSTALLATION</i> .....	5
<i>CONNECTING EXTERNAL CONNECTOR</i> .....	6
<i>REPLACING BATTERY</i> .....	10
<i>QUICK INSTALLATION GUIDE</i> .....	11
<i>QUICK REFERENCE OF YOUR MOTHERBOARD</i> .....	16
<i>GETTING START</i> .....	20
<i>ENTERING SETUP</i> .....	20
<i>GETTING HELP</i> .....	21
<i>THE MAIN MENU</i> .....	21
<i>STANDARD CMOS SETUP</i> .....	23
<i>BIOS FEATURES SETUP</i> .....	25
<i>CHIPSET FEATURES SETUP</i> .....	27
<i>POWER MANAGEMENT SETUP</i> .....	28
<i>PNP/PCI CONFIGURATION</i> .....	30
<i>INTEGRATED PERIPHERALS SETUP</i> .....	31
<i>LOAD BIOS DEFAULTS</i> .....	33
<i>LOAD SETUP DEFAULTS</i> .....	33
<i>PASSWORD SETTING</i> .....	33
<i>IDE HDD AUTO DETECTION</i> .....	33
<i>SAVE AND EXIT SETUP</i> .....	33
<i>EXIT WITHOUT SAVING</i> .....	33
<i>MOTHERBOARD TECHNICAL SPECIFICATION</i> .....	34
<i>ENVIRONMENT</i> .....	34
<i>DIMENSIONS AND WEIGHT</i> .....	34
<i>ELECTRICAL SPECIFICATION</i> .....	34
<i>POWER CONSUMPTION</i> .....	34
<i>REQUEST FOR TECHNICAL SUPPORT</i> .....	35

---

# Features of the Board

---

## Overview

Congratulations on purchasing the highest performance Pentium® motherboard. With the advanced technology available today, this motherboard is designed to run Intel's Pentium® processors at speeds up to 233 MHz. The on-board system memory consists of SIMM and DIMM giving you the most flexibility for system design. It supports up to 128 MB of DRAM using standard 72-pin SIMM sockets that accept either Fast Page Mode (FPM), Extended Data Out (EDO) memory. In addition, an unbuffered, 3.3 Volts, 168-pin SDRAM sockets are also included for 16 to 256MB synchronous Dynamic memory support. A 298-pin ,type 7, Zero Insertion Force (ZIF) socket allows an easy upgrade path for the future Pentium Overdrive® processors.

The motherboard uses VIA VT82580VPX PCI chipset. The VIA VT82C586A PCI/ISA Bridge provides an integrated Bus Mastering IDE controller with two high performance UltraDMA-33 EIDE interfaces for up to four IDE devices (such as hard drives or CD-ROM). The PCI/ISA Bridge also include an USB interface. The integrated Prime 3C I/O controller integrates the standard PC I/O functions: floppy interface, two FIFO serial ports, one EPP/ECP capable parallel port, and support for an IrDA and Consumer Infra Red compatible interface.

Three on-board 32-bit PCI local bus slots allow a higher bandwidth data path , which serves as a super highway for intensive data-movement such as video or networking. The BIOS support PCI bridge user configuration, which allows further expansion of the system with PCI peripherals. Up to three 16-bit ISA slots is provided so that the board is backward hardware compatible with the older expansion card. A total of five expansion slots can be populated with add-in cards as one PCI and ISA slot share the same chassis I/O panel. Two full length ISA add-in cards can be installed while the third can be half length. All PCI cards can be full length.

## Features Summary

This motherboard comes with following features:

- Supports Intel Pentium® Processor up to 233MHz, which included the newest MMX CPU.
- VIA VPX PCIsset, including a 82C585VPX PCI/Memory controller , 82C587 data bus Accelerator and 82C586A PCI ISA IDE Accelerator.
- PnP BIOS with support for power management, UltraDMA33/EIDE/SCSI features and desktop management interface (DMI) which allows higher level of hardware compatibility.
- Flash BIOS for easy upgrade
- Up to 4 each 72-pin SIMM sockets, supports up to 128 MB DRAM in two banks, which included FPM, EDO DRAM types
- A high speed unbuffered SDRAM sockets, supports 16-256M memory.
- Three 16-bit ISA expansion slots and three 32-bit PCI expansion slots.
- Integrated two PCI bus master UltraDMA-33 EIDE controller with two on-board connectors supports up to four IDE devices such as Hard Disk, CD-ROM or Tape Backup drives. USB interface also provided.
- Integrated Prime 3C I/O chipset featuring one floppy disk controller, two 16550 UART compatible serial ports, one high speed EPP/ECP capable parallel port, one Infra Red port.

## INSTALLATION PRECAUTIONS

During installation and initial test, use caution to avoid personal injury and damage to wiring due to sharp

Adhere to warnings and limitations regarding accessibility into areas designated only for authorized technical personnel.

To Install and operate your the new motherboard, you must follow the steps below:



1. Set Jumpers on the motherboard
2. Install the CPU with cooling fan
3. Install RAM modules
4. Connect cables, wires and power connector
5. Install expansion cards

## Jumpers Setting

board which allow you to configure your system to match your requirements. This chapter contains the information on the various jumpers settings and connector

## Jumpers

Jumpers are used to make several hardware settings on the motherboard. From the “Map of the

on-board, 2-pin jumper and 3-pin jumper. On the symbol of jumper likes “”, “” inside stands for pin 1. To set a jumper, a black cap containing metal contacts is placed across the jumper pin/s according to your required configuration. The jumper settings will also be described numerically such as [open] for open, [short] for short, [1-2] for connect pins 1&2, [2-3] for connects pins 2&3 respectively.

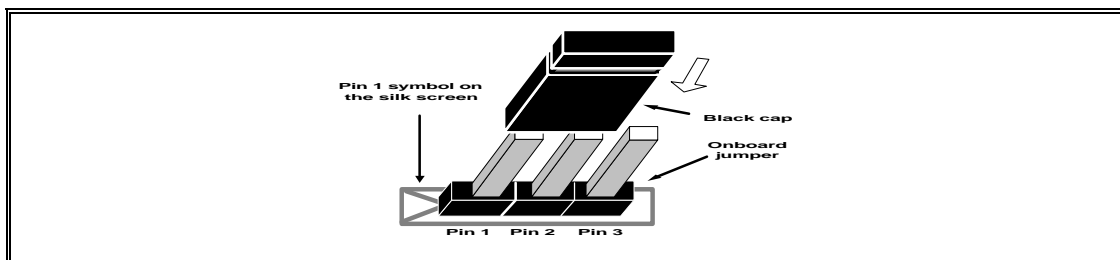

### CAUTION

*Users are not recommended to change any jumpers in it's default setting listed on this User's Guide. Changing the jumper settings improperly may affect the system performance.*

## CPU Installation

The motherboard provides a 298-pin, type-7, ZIP socket. The CPU should have a fan attached to it to prevent overheating. If this is not the case then purchase a fan before you turn-on the system.

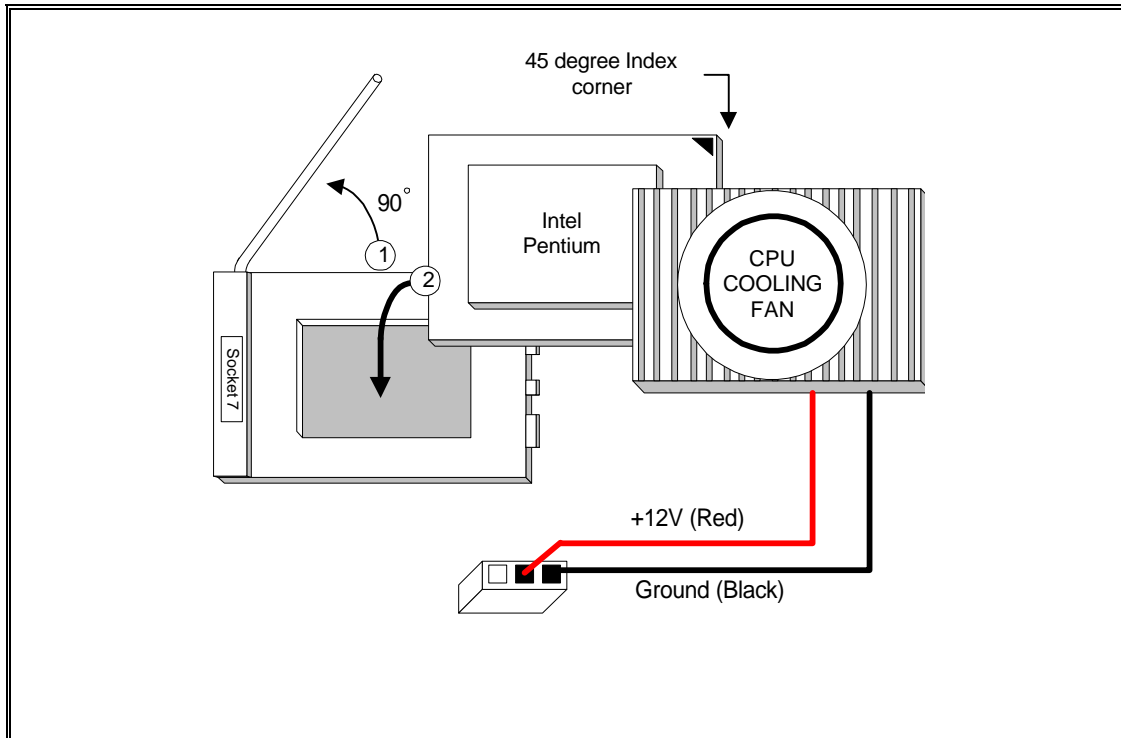

CPU Installation Diagram

**!** CAUTION

*Without a effective cooling fan, the CPU can overheat and cause damage to both the CPU and the motherboard.*

## INSTALLING SYSTEM MEMORY (RAM)

The motherboard supports four 72-pin SIMMs (Single-In-Line Memory Modules) from 8MB up to 256MB memory size and two 168-pin DIMM. The four 72-pin SIMMs sockets are divided into two memory banks, Bank 0 and Bank 1, and each bank has two SIMM sockets which accept either FPM or EDO DRAM module.

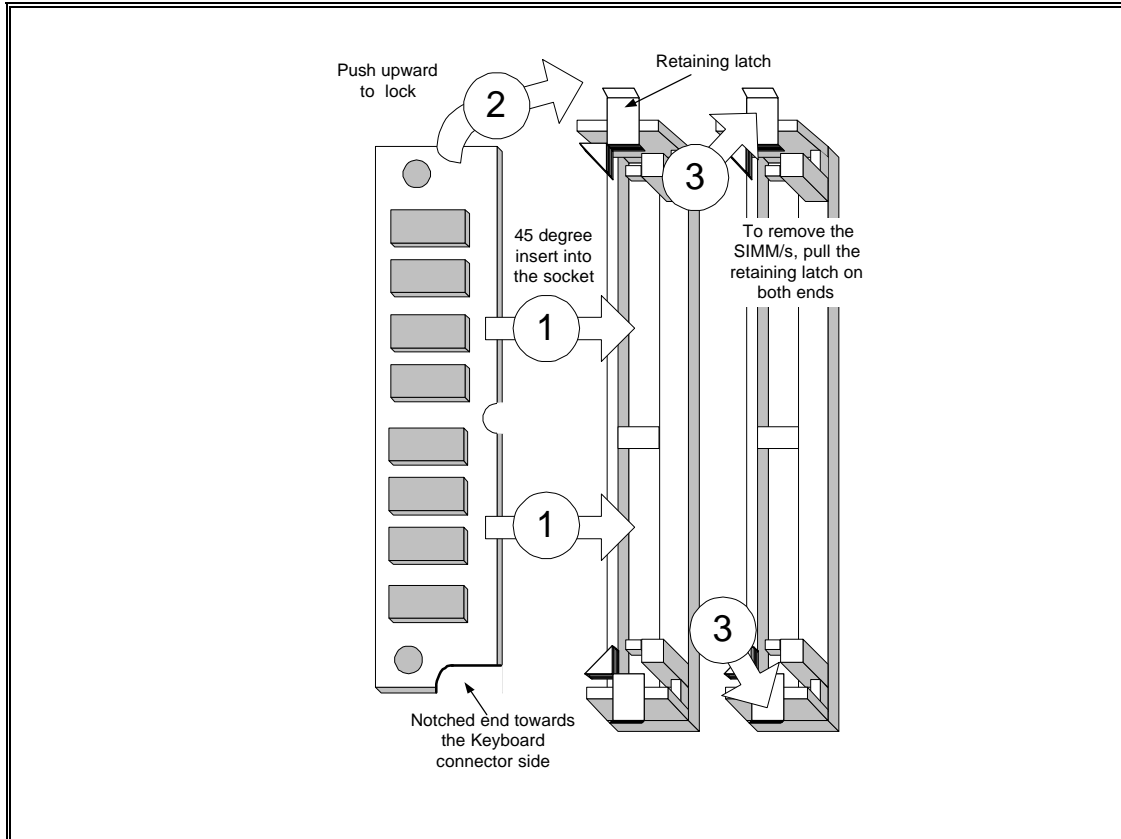

**SIMM Module Installation Diagram**

**! CAUTION**

*Each bank must have the same size and type of memory module installed in pairs.*

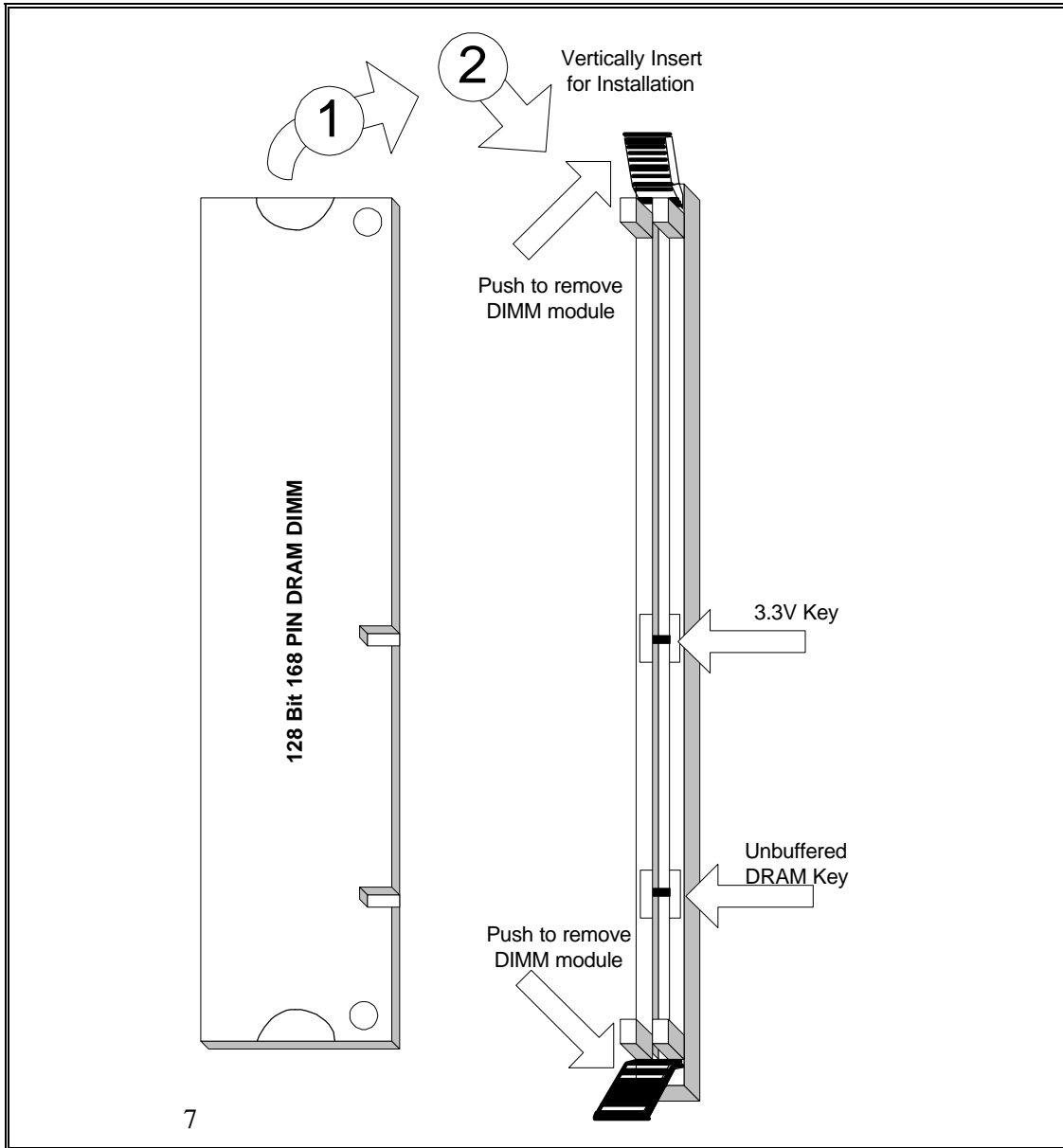

128-Pin SDRAM Module Installation Diagram

**!** CAUTION

*SDRAM Module can be used together with the SIMMs Module.*



## EXPANSION CARDS INSTALLATION

At the most of beginning, you must read your expansion card documentation on any hardware and software settings that may be required. The installation procedures are summarized as below:

1. Read the User's Guide/Manual of your expansion card.
2. If necessary, set any jumpers on your expansion card.
3. Power-off the system and then disconnected the power cord.
4. Remove your computer's cover.
5. Remove the metal bracket from one of the empty slot, ISA or PCI, corresponding to the type of expansion card.
6. Carefully align the card's connectors and press firmly, make sure that the connection is good.
7. Secure the card on the slot.
8. Replace the computer's cover.
9. Setup the BIOS configuration if necessary.
10. Install the required software drivers for your expansion card.

### CAUTION

*Before adding or removing any expansion card or other system components, make sure that you unplug your system power supply. Failure to do so may cause damage of your motherboard and expansion cards.*

## CONNECTING EXTERNAL CONNECTOR

### Power Connector

PW1, single 12-pin connector incorporates standard  $\pm 5V$  and  $\pm 12V$ , optional 3.3V and soft-power signals. With a power supply supports remote power on/off, the motherboard can turn off the system power through software control, such as the shutdown in Windows 95 Start menu. The system BIOS will turn the system power off when it receives the proper APM command from the OS. APM must be enabled in the system BIOS and OS in order for the soft-off feature to work correctly.

Pin	Signal Name	Pin	Signal Name
1	Power Good Signal	7	Ground
2	+5V	8	Ground
3	+12V	9	-5V
4	-12V	10	+5V
5	Ground	11	+5V
6	Ground	12	+5V

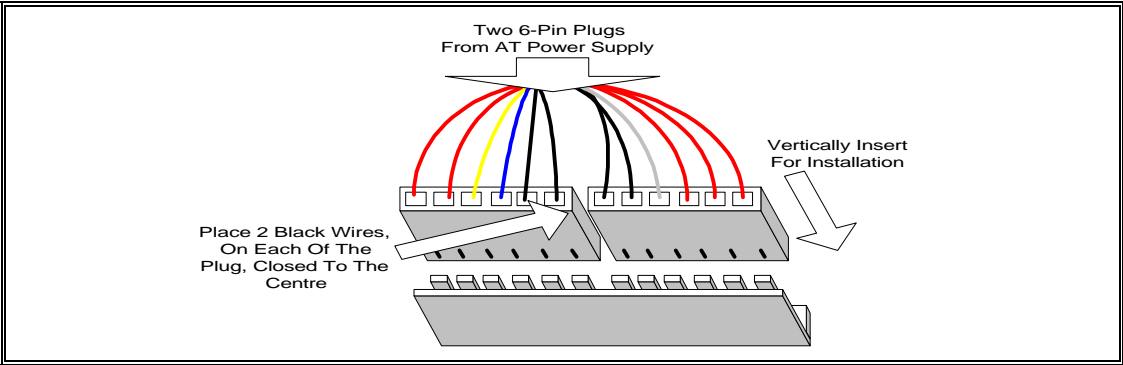

AT Power Connector Installation

### Floppy Drive Connector

This 34-pin connector supports the provided floppy drive ribbon cable. After connecting the single end to the on-board “FLOPPY” connector, connect the remaining plugs on the other end to the floppy drives correspondingly.

### IDE Connectors

The two on-board IDE connectors support the provided 40-pin IDE hard disk ribbon cable. After connecting the single end to the board, connect the two remaining plugs at the other end of your hard disk(s). If you install two hard disks, you must configure the two drives by setting its jumpers according to the documentation of your hard disk. Also, you may connect the two hard disks to be both Masters using one ribbon cable on the primary IDE connector and one on the secondary IDE connector.

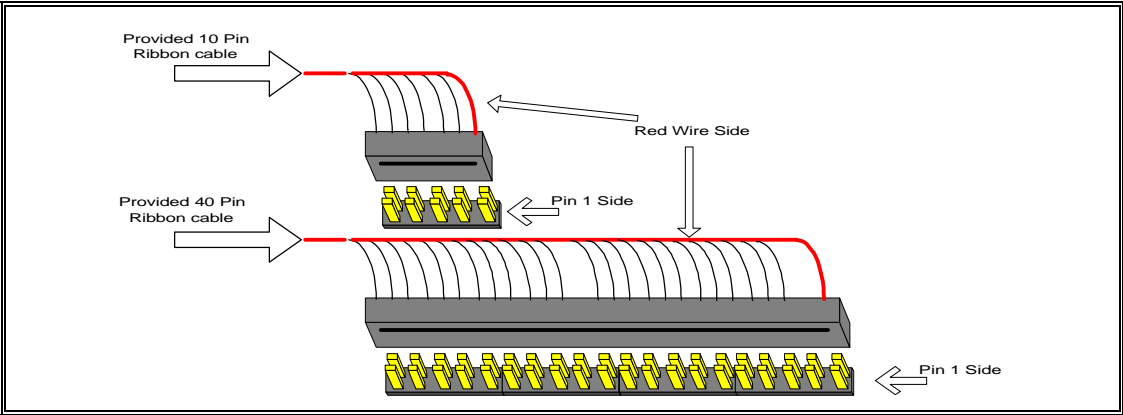

Ribbon cable Installation Example

**NOTICE**

*For the flat ribbon cable connection, please make sure that the pin 1 of the ribbon cable (the red wire side of the cable) is correctly connected to the on-board connector’s pin 1 as shown on the “Map of the Motherboard”.*

## Front Panel Function Connectors

All the front panel indicator, speaker, and switch functions are grouped into a on-board 26-pin connector, JP20. Front panel features supported include:

- System Reset, RESET
- Power LED, form KEYLOCK
- Hard Drive activity LED, IDE LED
- System Speaker, SPEAKER
- Turbo LED, TBLED
- External power saving control, EXTSMI (optional)

The connector pin out are described as the figure below:

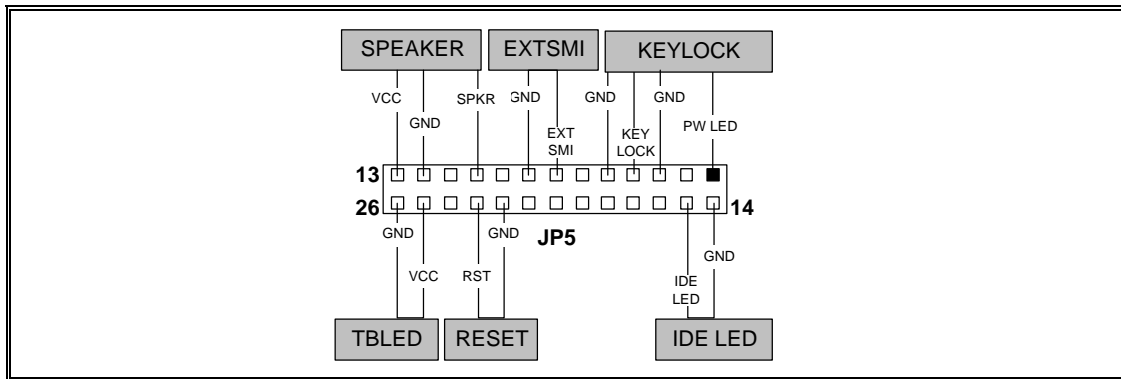

The Onboard Function Connector Pin Out

### Integrated USB, Infra-Red and PS/2 Mouse connector

The total of two USB device connectors, a PS/2 mouse, and an Infrared devices are all allocated at this connector (JP15).

- Pin1 to Pin5 for USB1 connector
- Pin11 to Pin15 for USB2 connector
- Pin6 to Pin10 for PS/2 connector
- Pin16 to Pin20 InfraRed connector

The connector pin out signal definitions are described as the table below:

Pin	Signal Name	Pin	Signal Name
1 (USB1)	USB +5 Volt	11 (USB2)	USB +5 Volt
2	USB Port 1-	12	USB Port 2-
3	USB Port 1+	13	USB Port 2+
4	Ground	14	Ground
5	No Connect	15	No Connect
6 (PS/2 Mouse)	PS/2 Data	16 (IR)	+5V
7	PS/2 Clock	17	No Connect
8	Ground	18	Infrared Receive
9	No Connect	19	Ground
10	+5V	20	Infrared Transmit

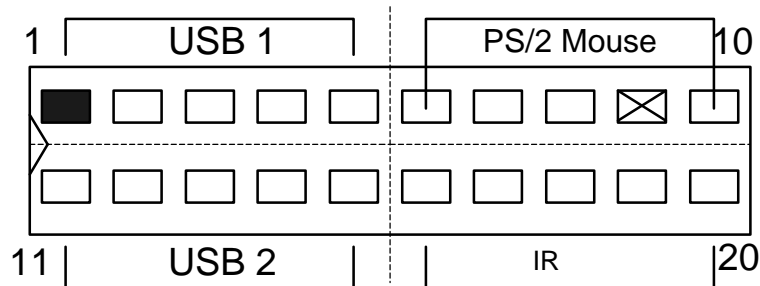

### CMOS Reset

JP14 is used to clear the CMOS RAM data. After the CMOS reset, all the system BIOS configuration will lose at all.

Description		
<b>Jumper</b>	[2-3]	[1-2] ( <i>default</i> )
<b>JP14</b>	CMOS RAM clear	Normal operation

## **REPLACING BATTERY**

A 3V, CR-2030, Lithium battery is installed on the on-board battery socket. This battery is used to supply the CMOS RAM backup power during system powered-off. Danger of explosion if battery is incorrectly replaced. Therefore, if you have any difficulty , please consult to the technical personnel.

# Quick Installation Guide

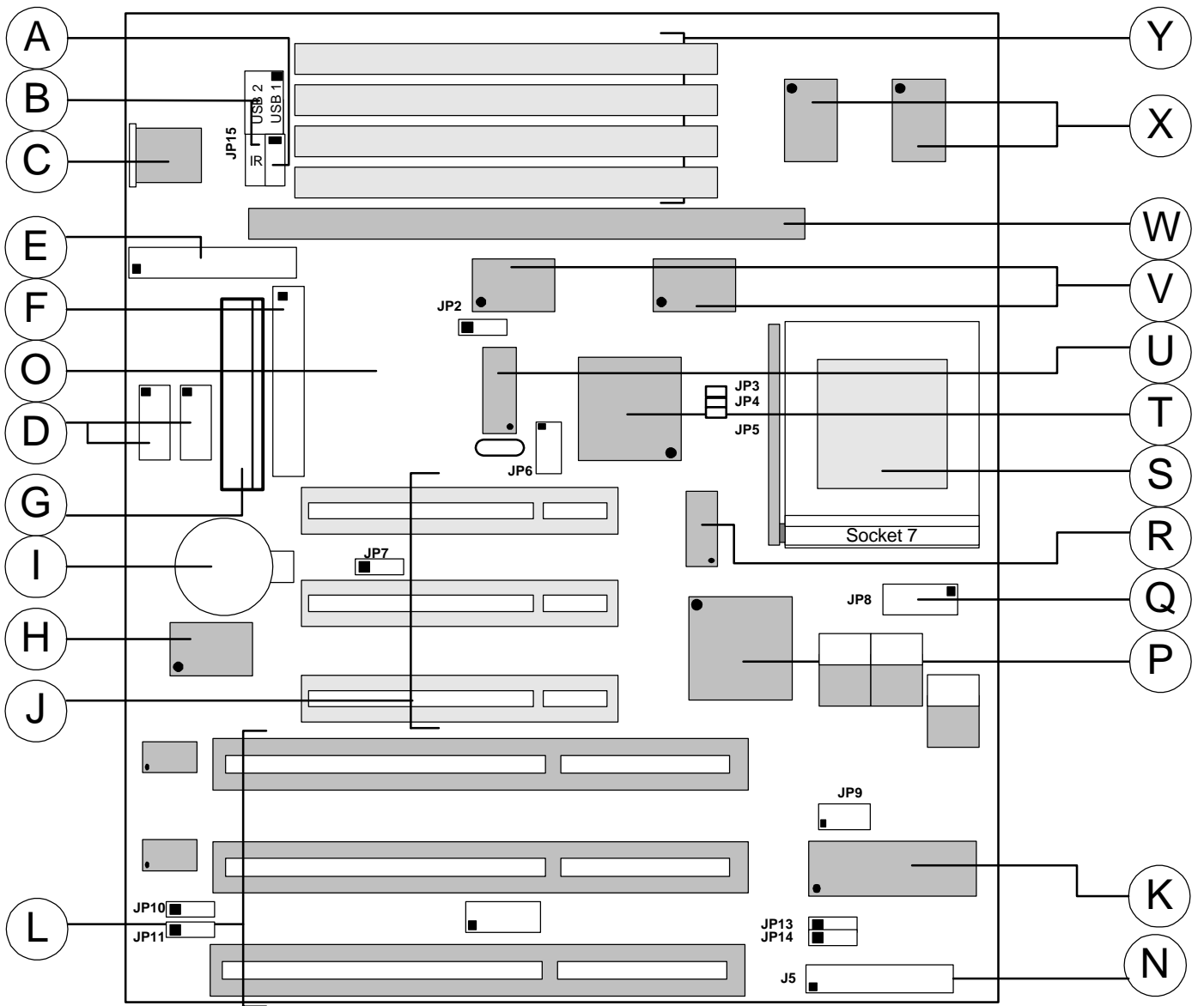

5SVA

A	PS/2 Mouse Header	N	Functions Connector
B	Universal Serial Bus (USB) and IR Headers	O	IDE Connectors
C	AT Keyboard Connector	P	VIA 82C586 PCI-ISA Bridge
D	Serial (COM1 and 2) Port Headers	Q	MMX Split Power Plane Connector
E	Parallel (Printer) Port Connector	R	TAG RAM
F	Floppy Drive Connector	S	Pentium Socket 7
G	AT Power Supply Connector	T	VIA 82C585 System Controller
H	Integrated I/O Controller	U	System Clock Chip
I	3V Lithium Battery	V	VIA 82C587 Data Buffer
J	PCI Bus	W	3.3V Unbuffered SDRAM Socket
K	Flash BIOS EEPROM	X	256/512K Cache RAM
L	ISA Bus	Y	SIMM RAM Socket

### “CPU Voltage Selection”

- JP13 for CPU I/O and chipset voltage selection
- JP9 for CPU core voltage selection
- JP8 for MMX CPU split power plane

**! CAUTION**

*Please be reminded that the core voltage setting of Intel MMX and Cyrix 6x86L CPU should be 2.8V. For these and other split power plane CPU, JP8 & JP9 must be set according to Pg14 before turning on the system power. Failure to do so may cause damage to your CPU.*

CPU Power Setting for Intel MMX CPU (2.8V) or Cyrix 6x86L CPU

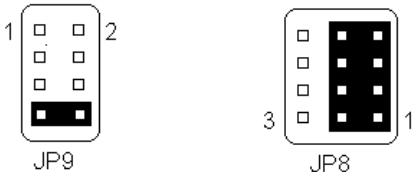

CPU Power Setting for AMD K6-233/266 CPU (2.2V)

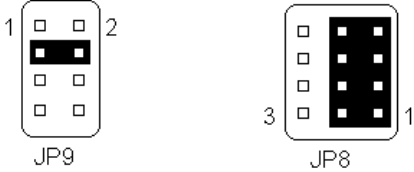

CPU Power Setting for Intel Pentium CPU (3.5V) or Cyrix 6x86 or AMD-K5 CPU



CPU Power Setting for AMD-K6 PR166/200 (2.9V)

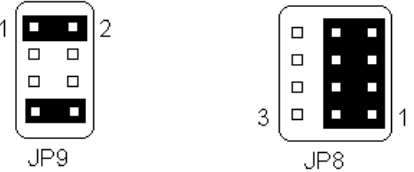

CPU Power Setting for AMD-K6 PR233 (3.2V)

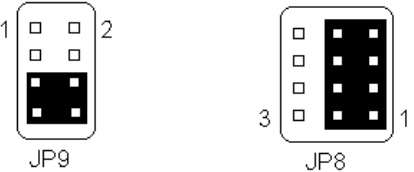



## CPU Speed and Voltage Selection

### INTEL PENTIUM CPU

Internal CPU speed	External Bus	JP6		Frequency Ratio	JP3	JP4	JP5	JP2
90	60MHz	[1-3]	[4-6]	1.5x	OPEN	OPEN	ON	[2-3]
100	66MHz	[3-5]	[2-4]	1.5x	OPEN	OPEN	ON	[2-3]
120	60MHz	[1-3]	[4-6]	2x	OPEN	ON	OPEN	[2-3]
133	66MHz	[3-5]	[2-4]	2x	OPEN	ON	OPEN	[2-3]
150	60MHz	[1-3]	[4-6]	2.5x	ON	ON	OPEN	[2-3]
166 (default)	66MHz	[3-5]	[2-4]	2.5x	ON	ON	OPEN	[2-3]
180	60MHz	[1-3]	[4-6]	3x	ON	OPEN	OPEN	[2-3]
200	66MHz	[3-5]	[2-4]	3x	ON	OPEN	OPEN	[2-3]
233	66MHz	[3-5]	[2-4]	3.5x	OPEN	OPEN	OPEN	[2-3]

### CYRIX/IBM 6X86 CPU (\* = Only supported in 5SVA with 512K cache)

Internal CPU speed	External Bus	JP6		Frequency Ratio	JP3	JP4	JP5	JP2
PR133	55MHz	[3-5]	[4-6]	2x	OPEN	ON	OPEN	[1-2]
PR150	60MHz	[1-3]	[4-6]	2x	OPEN	ON	OPEN	[2-3]
PR166	66MHz	[3-5]	[2-4]	2x	OPEN	ON	OPEN	[2-3]
PR200 *	75MHz	[1-3]	[4-6]	2x	OPEN	ON	OPEN	[1-2]
PR166	60MHz	[1-3]	[4-6]	2.5x	ON	ON	OPEN	[2-3]
PR200 *	75MHz	[1-3]	[4-6]	2x	OPEN	ON	OPEN	[1-2]
PR233 *	75MHz	[1-3]	[4-6]	2.5x	ON	ON	OPEN	[1-2]
PR 300	66MHz	[3-5]	[2-4]	3.5x	OPEN	OPEN	OPEN	[2-3]
PR 300	75Mhz	[1-3]	[4-6]	3x	ON	OPEN	OPEN	[1-2]
PR 333	75Mhz	[1-3]	[4-6]	3.5x	OPEN	OPEN	OPEN	[1-2]

### AMD-K5 CPU

Internal CPU speed	External Bus	JP6		Frequency Ratio	JP3	JP4	JP5	JP2
PR90	60MHz	[1-3]	[4-6]	1.5x	OPEN	OPEN	ON	[2-3]
PR100	66MHz	[3-5]	[2-4]	1.5x	OPEN	OPEN	ON	[2-3]
PR133	66MHz	[3-5]	[2-4]	1.5x	OPEN	OPEN	ON	[2-3]
PR150	60MHz	[1-3]	[4-6]	1.75x	ON	ON	OPEN	[2-3]
PR166	66MHz	[3-5]	[2-4]	1.75x	ON	ON	OPEN	[2-3]

### AMD-K6 CPU

Internal CPU speed	External Bus	JP6		Frequency Ratio	JP3	JP4	JP5	JP2
PR166	66MHz	[3-5]	[2-4]	2.5x	ON	ON	OPEN	[2-3]
PR200	66MHz	[3-5]	[2-4]	3x	ON	OPEN	OPEN	[2-3]
PR233	66MHz	[3-5]	[2-4]	3.5X	OPEN	OPEN	OPEN	[2-3]
PR266	66MHz	[3-5]	[2-4]	4X	OPEN	ON	ON	[2-3]
PR300	66MHz	[3-5]	[2-4]	4.5X	ON	ON	ON	[2-3]
PR333	66MHz	[3-5]	[2-4]	5x	ON	OPEN	ON	[2-3]

**CPU Voltage**

<b>CPU type</b>	<b>JP13</b>	<b>I/O voltage</b>	<b>JP9</b>	<b>Core voltage</b>	<b>JP8</b>
<b>Intel Pentium</b> <b>Cyrix/IBM 6x86</b> <b>AMD-K5</b>	Nil	3.5V	[1-2],[3-4] [5-6],[7-8]	3.5V	Fully open
<b>Intel Pentium with MMX</b> <b>Cyrix 6x86L</b> <b>AMD-K6 PR166/200</b> Cyrix 6x86MX PR166/200, MII300 <b>AMD-K6 PR233</b> <b>AMD-K6 PR300</b>	[1-2]	3.3V	[7-8] [7-8] [7-8][1-2] [7-8][1-2] [7-8][5-6] [3-4]	2.8V 2.8V 2.9V 2.9V 3.2V 2.2V	Fully open

---



## Quick Reference of Your Motherboard

### **[A] PS/2 Mouse Header**

PS/2 device, like some PS/2 keyboard and mouse, all have a standard 6-pin round shape connector. However, it does not have a unique onboard standard. Therefore, please refer to the Chapter “Motherboard Installation”, in order to purchase a suitable PS/2 Mouse Connector.

### **[B] USB & IR Headers**

Universal Serial Bus (USB) is a new interface standard for any I/O device “Outside the Box”. USB makes your peripherals have a real plug and play (PnP) capabilities with up to 12MB/sec data speed. Coming soon, any external device connected to your computer will be standardized into USB standard which all have a special 4-pin rectangle shape connector. Therefore, with the VIA chipset, this motherboard builds two USB headers on-board for your future investment. If you are using a USB device, you must purchase an optional USB connector.

A 5-pin interface on the front panel I/O connector is provided to allow connection to a Hewlett Packard HSDSL-1000 compatible Infra-red (IrDA) transmitter/receiver. Once the module is connected to the front panel I/O header, Serial port 2 can be re-directed to the IrDA module. When configured for IrDA, the user can transfer files to or from portable devices such as laptops, PDA's and printers using application software such as LapLink. The IrDA specification provides for data transfers at 115kbps from a distance of 1 meter. Support for Consumer Infra Red (ASK-IR) is also included, please refer to your IR equipment for more detailed information.

### **[C] AT Keyboard Connector**

This connection is used for a standard IBM-compatible keyboard, such as 101 enhanced keyboard.

### **[D] Serial (COM 1 and 2) Port Headers**

This motherboard provides two high-speed UART compatible serial ports.

### **[E] Parallel (Printer) Port Connector**

One Parallel port with SPP, EPP and ECP capabilities.

### **[F] Floppy Drive Connector**

A 34-pin connector on-board allows connection to two 360K, 720K, 1.2M, 1.44, 2.88M floppy disk drives.

### **[G] AT Power Supply Connector**

Based on the AT specification, one 12-pin power connector covers all the required power sources,  $\pm 5V$  and  $\pm 12V$ .

### **[H] Integrated I/O Controller**

On the motherboard, keyboard controller, real time clock, serial ports, parallel port and floppy drive are all integrated into a single chip. The I/O port allows you to configure through the BIOS setup. This integrated I/O chip provides:

- Plug-and-Play compatible.
- Supports two 360K, 720K, 1.2M, 1.44, 2.88M floppy disk drives
- One multi-mode high performance parallel port which can be configured in BIOS as standard (SPP) mode, enhanced (EPP) mode, high speed (ECP) mode.
- Supports two 16C550 compatible enhanced serial ports.
- Supports IrDA or ASKIR infra-red interface.

### **[I] 3V Lithium Battery**

An on-board battery holder is used to hold a 3 Volts CR-2032 Lithium battery which makes the battery's replacement more convenient. This battery is used to supply power for the RTC CMOS RAM in order to save your system setting and date/time counting during system power-off. In general, the battery's life-time is about 2-3 years. If you see a "BIOS checksum error" message happened while system turn-on, it may be caused by the battery low. You can try to fix it by simply replaced the battery. The scrapped Lithium battery should be handled with care and should not be thrown into fire.

### **[J] PCI Add-in Board Connectors**

This motherboard provides three full-length 32 bit PCI slots with up to 133MB/sec burst data transfer rate.

### **[K] Flash BIOS**

The flash BIOS allows user have more flexibility to upgrade their motherboard. The flash BIOS can be programmed by software easily. For the latest BIOS upgrade information, please feel free to visit our web site: <http://www.zida.com>.

### **[L] ISA Add-in Board Connectors**

This motherboard provides three 16 bit ISA slots which allows backward hardware compatibility.

---



## [N] Front Panel Function Connector

For your convenience, all the front panel functions are integrated into a single connector, which included power LED and keyboard lock, turbo switch, reset switch, SMI switch and speaker.

## [O] IDE Connectors

This motherboard has two independent high performance bus-mastering PCI IDE interfaces capable of supporting up to UltraDMA-33 devices. The system BIOS supports automatic detection of the IDE device data transfer rate and translation between different kinds of device mode such as Logical Block Addressing (LBA) and Extended Cylinder Sector Head (ECSH) translation modes and ATAPI (e.g., CD-ROM) devices on both IDE interfaces.

In a true multi-tasking operating systems like Windows® 95 and Windows® NT, the IDE interface can operate as a PCI bus master capable of supporting Ultra DMA-33 devices with transfer rates of up to 33MB/sec.

## [P] 82C586 PCI/ISA Bridge

The VIA 82C586 is a 208-pin QFP package IC which provides the following features:

- Interface between the PCI local bus and ISA bus.
- Supports for 2 Universal Serial Bus (USB) ports.
- Integrated fast IDE interface supports up to 4 devices. With separated Master/Slave mode support, it provides data transfer rate up to 33 MB/sec in UltraDMA-33 mode. It is also backward compatible to Mode 4 device. In addition, it also integrated sixteen levels of prefetch and write buffers and full scatter and gather capability which further enhanced the system performance.
- Enhanced DMA controller with Fast Type-F DMA
- Counters/Timers provides advanced power management with programmable system management interrupt (SMI).

## [Q] MMX Split Power Plane Connector

With this specific connector, it provides an easier way for MMX CPU supporting.

## [R] TAG RAM

High speed Tag RAM.

## [S] Pentium® Type-7 Socket

The type-7 socket is a 298-pin, zero insertion force (ZIF) socket. It provides users with a performance upgrade path to Pentium® OverDrive technology.



## **PENTIUM® PROCESSOR**

*An approved Pentium heatsink is necessary for proper thermal dissipation in an AT compliant chassis. The processor/heatsink assembly must be securely fastened to the Socket 7 ZIF socket by two clips. These clips fit over the heatsink assembly and attach to the outer wide tabs of the Socket 7 assembly.*

### [T] 82C585VPX System Controller

The 82C585VPX integrated the cache and main memory DRAM control functions and provide bus control for transfers between the CPU, cache, main memory and the PCI Bus. The VPX comes in a 208 pin PQF package.

### [U] System Clock Chip

This system clock chip provides all the clock signals for the system, such as CPU clock and PCI bus clock.

### [V] 82C587 Data Buffer

The 82C587VP provide the data paths between the CPU/cache, main memory, and PCI.

### [W] SDRAM Socket

There is an unbuffered, 3.3 Volts, SDRAM socket on-board provides more flexibility for your system memory upgrade.

### [X] 256K/512K Cache RAM

256K/512K Cache RAM on-board in order to further enhanced of your system performance.

### [Y] SIMM Sockets

This motherboard provides four 72-pin SIMM sockets. The minimum memory size is 8 MB by using two 1M x 32 SIMM modules and maximum memory size is 128 MB by four 8M x 32 SIMM modules. Memory timing can be configured through the BIOS setup, please refer to the chapter of BIOS setup. They support both Fast Page Mode and Extended Date Output (EDO) SIMM RAM. Both parity and non-parity memory are supported.

The four sockets are arranged into two banks, Bank 0 and Bank 1, of two sockets each. Each bank provides a 64/72-bit wide data path. Both SIMMs modules in a bank must be of the same memory size and type. There are no jumper settings required for the memory size or type, as it is automatically detected by the system BIOS.



### NOTICE

*Due to the electrical loading characteristics, 64 MB SIMMs using the 16 MB technology are not supported by this motherboard. 64 MB SIMMs using 64 MB technology will be supported by the motherboard when they become available, depending on the characteristics of the memory module.*



### EDO DRAM

Extended Data Out (or Hyper Page) DRAM is designed to improve the DRAM read performance. EDO DRAM holds the memory data valid until the next memory access cycle, unlike standard fast page mode DRAM that tri-states the memory data when the pre-charge cycle occurs, prior to the next memory access cycle. EDO DRAM timings are X-2-2-2 compared to FPM timings of X-3-3-3.

# Award BIOS and CMOS Setup Utility

## GETTING START

All computer motherboards provide a Setup utility program for specifying the system configuration and settings. If your motherboard came in a computer system, the proper configuration entries may have already been made.

This motherboard has been programmed with Award BIOS setup utility. The setup utility program is stored inside the on-board programmable Flash ROM chip. This Setup program allows user to modify the basic system configuration. The system configuration is stored in the battery backup CMOS RAM (inside the real time clock chip) so that it retains the setup information when the power is turned off. This chapter explains the setup utility for the Award BIOS.

## ENTERING SETUP

When you turn on the computer, the system allows you an opportunity to enter the BIOS Setup utility. During the POST (**P**ower **O**n **S**elf **T**est), you can see the below message appears at the bottom of the screen, press <Del> key or simultaneously press <Ctrl>, <Alt> and <Esc> keys.

```
Press DEL to enter SETUP, ESC to skip memory test
```

If the message disappears before you respond, POST will continue with its test routines, thus preventing you from calling up the Setup utility. However, if you still want to enter Setup, restart the system to try again by turning it OFF and then ON or pressing the "RESET" button on the system case. You may also restart your system by simultaneously pressing <Ctrl>, <Alt> and <Delete> keys. If you do not press the keys at the correct time and the system does not boot up, and error message below may be displayed and you will again be asked to,

```
PRESS F1 TO CONTINUE, CTRL-ALT-DEL TO ENTER SETUP
```

## Summary of Control Keys

Up arrow	Move to previous item
Down arrow	Move to next item
Left arrow	Move to the item in the left hand
Right arrow	Move to the item in the right hand
Esc key	Main Menu -- Quit and not save changes into CMOS Status Page Setup Menu and Option Page Setup Menu -- Exit current page and return to Main Menu
PgUp key	Increase the numeric value or make changes
PgDn key	Decrease the numeric value or make changes
+ key	Increase the numeric value or make changes
- key	Decrease the numeric value or make changes
F1 key	General help, only for Status Page Setup Menu and Option Page Setup Menu
(Shift)F2 key	Change color from total 16 colors. F2 to select color forward, (Shift) F2 to select color backward
F3 key	Calendar, only for Status Page Setup Menu
F5 key	Restore the previous CMOS value from CMOS, only for Option Page Setup Menu
F6 key	Load the default CMOS value from BIOS default table, only for Option Page Setup Menu
F7 key	Load the setup default, only for Option Page Setup Menu
F10 key	Save all the CMOS changes, only for Main Menu

## GETTING HELP

### Main Menu

The on-line description of the highlighted setup function is displayed at the bottom of the screen.

### Status Page Setup Menu/Option Page Setup Menu

Press F1 to pop up a small help window that describes the appropriate keys to use and the possible selections for the highlighted item. To exit the Help Window, press <Esc>.

## THE MAIN MENU

Once you enter Award BIOS CMOS Setup Utility, the Main Menu (Figure 1) will appear on the screen. The Main Menu allows you to select from ten setup functions and two exit choices. Use arrow keys to select among the items and press <Enter> to accept or enter the sub-menu.

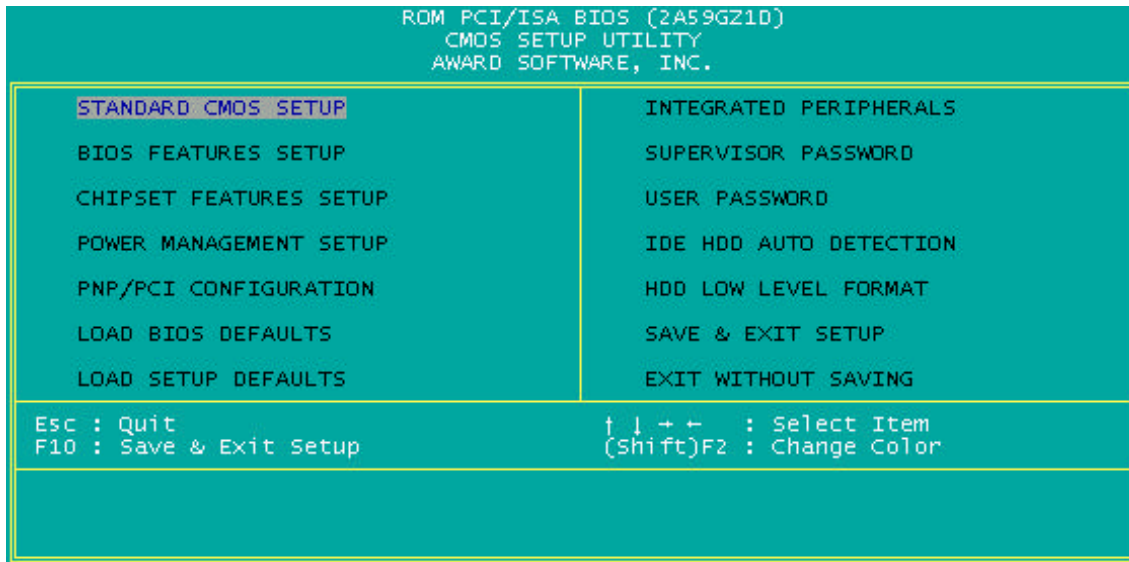

The CMOS Setup Utility Main Menu

### Standard CMOS Setup

This setup page includes all the items in a standard compatible BIOS.

### BIOS Features Setup

This setup page includes all the items of Award special enhanced features.

### Chipset Features Setup

This setup page includes all the items of chipset special features.

### Power Management Setup

This setup page includes all the items of green features.



### **PnP/PCI Configuration**

This setup page includes all the items of PnP , PCI IRQ and ISA IRQ settings. You can allocate these resources for your system use in this menu.

### **Integrated Peripherals**

This setup page is used to configure the On-board multi I/O and IDE interface.

### **Load BIOS Defaults**

This function is for user to load the BIOS default settings. The BIOS defaults indicates the most appropriate value of the system parameter which the system would be in minimum performance.

### **Load SETUP Defaults**

This function is for user to load the SETUP default settings. SETUP defaults indicates the values required by the system for the maximum performance.

### **Supervisor/User Password**

This function is for Change, set, or disable the supervisor or user password. The supervisor password allows you to limit the user access to the system and Setup.

### **IDE HDD Auto Detection**

Automatically configure hard disk parameters.

### **HDD Low Level Format**

This Automatically configure hard disk parameters.

### **Save & Exit Setup**

Save CMOS value changes to CMOS and exit setup.

### **Exit Without Save**

Abandon all CMOS value changes and exit setup.

## STANDARD CMOS SETUP

The items in Standard CMOS Setup Menu are divided into 10 categories. Each category includes no, one or more than one setup items. Use the arrow keys to highlight the item and then use the <PgUp> or <PgDn> keys to select the value you want in each item.

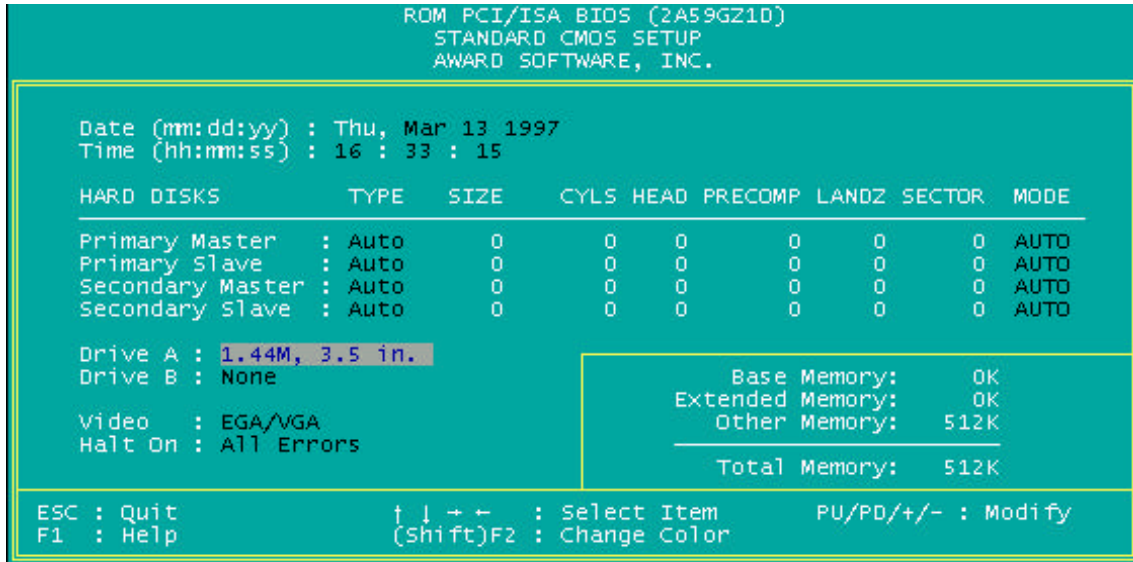

The Default Setting of Standard CMOS Setup

### Date & Time

Enter current Date & Time to set system clock. The date format is <month> <day> <year> and the time format is <hour> <minute> <second>. The time is calculated based on the 24-hour military-time clock.

### Primary and Secondary Master / Slave

The categories identify the types of IDE hard disk on primary or secondary IDE channel that have been installed in the computer. There are 46 pre-defined types and a user definable type. Type "1" to Type "46" are predefined. Type "User" is user-definable.

Press PgUp or PgDn to select a numbered hard disk type or type the number and press <Enter>. Note that the specifications of your drive must match with the drive table. The hard disk will not work properly if you enter improper information for this category. If your hard disk drive type is not matched or listed, you can use Type User to define your own drive type manually.

If you select Type "User", related information is asked to be entered to the following items. Enter the information directly from the keyboard and press <Enter>. This information should be provided in the documentation from your hard disk vendor or the system manufacturer.

There are the option of Type "AUTO" and Mode "AUTO" to auto detect the hard disk type and the hard disk mode (Normal, LBA and Large). If a hard disk has not been installed select NONE and press <Enter>.

 **NOTICE FOR HARD DISK LARGER THAN 528MB**

*The Mode settings are for IDE hard disks only. There are three entries you can select from in the mode field, "Normal", "Large" and "LBA".*

*Set Mode to the Normal settings for IDE hard disk drives smaller than 528MB. Use the LBA setting for drives over 528MB that use Logical Block Addressing mode to allow larger IDE hard disks.*

### **Drive A / Drive B**

This category identifies the types of floppy disk drive A or drive B that have been installed in the computer.

### **Video**

This category selects the type of adapter used for the primary system monitor that must match your video display card and monitor. Although secondary monitors are supported, you do not have to select the type in Setup.

### **Halt On**

This category determines whether the computer will stop if an error is detected during power up. There are different types of error can be configured in this category.

### **Total Memory**

This category is display-only which is determined by POST (Power On Self Test) of the BIOS.

### **Base Memory**

The POST of the BIOS will determine the amount of base (or conventional) memory installed in the system. The value of the base memory is typically 640K for systems with 640K or more memory installed on the motherboard.

### **Extended Memory**

The BIOS determines how much extended memory is present during the POST. This is the amount of memory located above 1MB in the CPU's memory address map.

### **Other Memory**

This refers to the memory located in the 640K to 1024K address space. This is memory that can be used for different applications. DOS uses this area to load device drivers to keep as much base memory free for application programs. Generally, this area is used for Shadow RAM.

## BIOS FEATURES SETUP

The item BIOS Features Setup Menu is divided into 23 categories. Each category includes no, one or more than one setup items. Use the arrow keys to highlight the item and then use the <PgUp> or <PgDn> keys to select the value you want in each item.

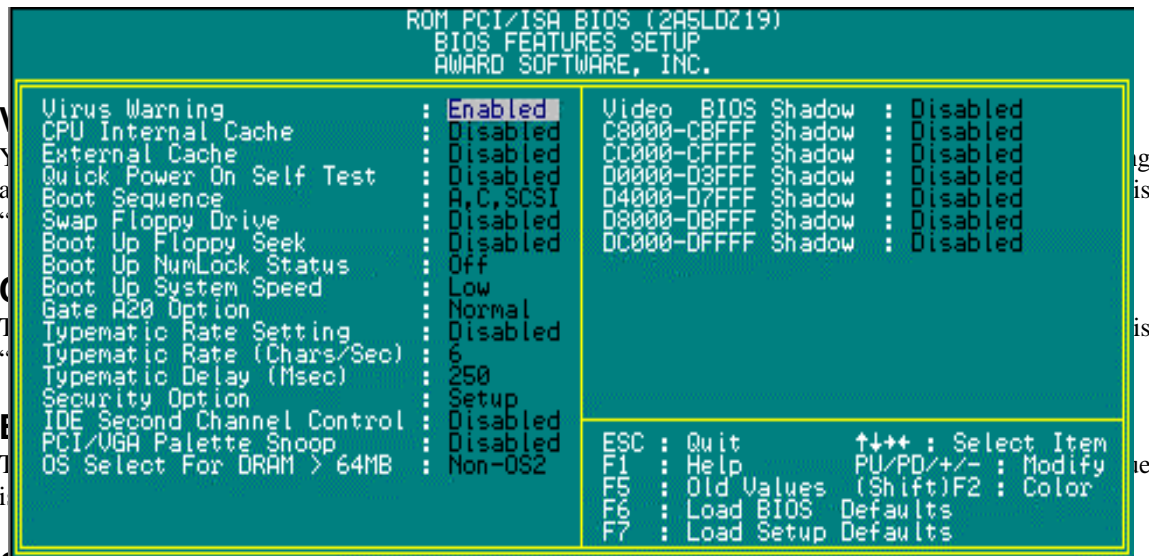

### Quick Power On Self Test

This category speeds up Power On Self Test (POST) after you power on the computer. If it is set to “Enabled”, BIOS will shorten or skip some check items during POST. The default value is “Disabled”.

### Boot Sequence

This category determines which drive computer searches first for the disk operating system (i.e., DOS). The default setting is “A,C,SCSI”, means that the system will determine the drive A before drive C.

### Swap Floppy Drive

This feature allows you to enable the system swap floppy function, the default is “Disabled”. When this function enables, the system will assign the Drive A as Drive B, and vice versa.

### Boot Up Floppy Seek

The default setting is “Enabled”, so that the BIOS will search for floppy disk drive to determine if it is 40 or 80 tracks. If disabled, BIOS will not search for the type of floppy disk drive by track number. Note that there will be no warning message if the drive installed is 360K.

### Boot Up NumLock Status

It determine the Num-Lock is turned on/off Num Lock. when the system is powered on so that the end user can use the arrow keys on both the numeric keypad and the keyboard. The default value is “On”.

### Boot Up System Speed

It selects the default system speed - the speed that the system will run at immediately after power up. The default value is “High”.

## Gate A20 Option

The A20 signal option specify A20 controlled by keyboard controller or chipset hardware. The default is “Fast”, therefore, the A20 signal is controlled by chipset specific method.

## Typematic Rate Setting

Typematic Rate sets the rate at which characters on the screen at which characters on the screen repeat. The default setting is Disabled.

## Typematic Rate (Chars/Sec)

Typematic rate sets the rate at which characters on the screen repeat when a key is pressed and held down. You can select 6-30 characters per second. The default setting is “6”.

## Typematic Delay (M sec)

When holding down a key, the time between the first and second character display. you specified numbers of times of character repeat on the screen. The default setting is “250”.

## Security Option

This category allows you to limit access to the system and Setup or just to Setup. When you select system, the system will not boot and access to Setup will be denied if the correct password is not entered at the prompt. If you select Setup, the system will boot but access to Setup will be denied if the correct password is not entered at the prompt. The default setting is “Setup”.

## PCI/VGA Palette Snoop

This option controls the system to access the PCI VGA card palette register. In general, this option is “Disabled”. However, you may need to enable this option for some VGA cards which have incorrect color displayed on some software application.

## OS Select For DRAM > 64MB

Some the OS/2 application access the memory in different mode. Enable this option to allow the system use another mode to access the main memory for OS/2 applications.

## VIDEO BIOS Shadow

The system BIOS is automatically shadowed. The default setting for the “Video BIOS Shadow” is “Enabled”. It determines whether video BIOS will be copied to RAM. However, it is optional from chipset design. Video Shadow will increase the video speed.

## C8000 - CFFFF Shadow/E8000 - EFFFF Shadow

These categories determine whether optional ROM will be copied to RAM by 16K byte. You can enable the optional shadow or you can disable it. The default setting is disabled.

## CHIPSET FEATURES SETUP

This section allows you to configure the system based on the specific features of the installed chipset. This chipset manages bus speeds and access to system memory resources, such as DRAM and the external

```

ROM PCI/ISA BIOS (2A5LD219)
CMOS SETUP UTILITY
CHIPSET FEATURES SETUP

DRAM Auto Configuration : Disabled
DRAM Timing Control     : Normal
SDRAM Cycle Length      : 3
SDRAM Bank Interleave   : Disabled

Sustained 3T Write      : Enabled
2 Bank PDSRAM           : 3-1-1-1
Read Pipeline           : Disabled
Write Pipeline          : Disabled
Cache Timing            : Fastest

Video BIOS Cacheable    : Disabled
System BIOS Cacheable   : Disabled
Memory Hole At 15Mb Addr.: Disabled

OnChip USB              : Enabled
USB Keyboard Support    : Disabled

```



## POWER MANAGEMENT SETUP

Power Management setup controls the system board Power Management features. This is a feature of microprocessor with the energy-efficient technology. The setup screen is shown in figure below.

```

ROM PCI/ISA BIOS (2A5LD219)
POWER MANAGEMENT SETUP
AWARD SOFTWARE, INC.

Power Management      : Disable
PM Control by APM    : No
Video Off Option      : Always On
Video Off Method      : Blank Screen
Conserve Mode         : Disabled
MODEM Use IRQ        : NA

  ** PM Timers **
HDD Power Down       : Disable
Doze Mode             : Disable
Suspend Mode         : Disable

  ** PM Events **
VGA                  : OFF
LPT & COM            : NONE
HDD & FDD            : OFF
DMA/master           : OFF
Primary INTR         : OFF

ESC : Quit          ↑↓↓↑ : Select Item
F1  : Help          PU/PD/+/- : Modify
F5  : Old Values   (Shift)F2 : Color
F6  : Load BIOS Defaults
F7  : Load Setup Defaults
  
```

### PM Control by APM

This feature is automatically set to “Yes”, the system BIOS will wait for APM prompt before it enters the GREEN mode.

#### NOTICE

*If APM is installed, & if there is a task running, event the timer is time out, the APM will not prompt the BIOS to put the system into any power saving mode!*

## Video Off Method

There are three options you can choose to turn off the VGA display.

- Blank Screen — The system will blank the screen only.
- DPMS — This function is enabled for only the VGA card supporting DPM.
- V/H SYNC + Blank — Choose this mode if your system use the monitor with power management feature. In addition to the blank screen, the system will turn off the horizontal and vertical sync signal. Most monitor will turn off itself if these signal are inactive.

The default setting is “V/H SYNC+Blank”.

## Modem Use IRQ

If you installed the MODEM on your system, you can use this option to specify the MODEM use which IRQ. Normally, if you install the external modem on COM1, it will use IRQ4 and COM2 will use IRQ3. The default setting is “3”.

## Standby Mode/Suspend Mode/Doze Mode

These option specify the continuous idle time before the system enter the power saving mode. Normally, Doze and Standby mode puts the system into low speed clock and suspend mode puts the system clock stopped. The default setting is “Disabled”.

## HDD Power Down

This option defines the continuous HDD idle time before the HDD enter power saving mode (motor off).

## PM Events

Power Down and Resume events are I/O events whose occurrence can prevent the system from entering a power saving mode or can awaken the system from such a mode. In effect, the system remains alert for anything which occurs to a device which is configured as “On”, even when the system is in a power down mode.

Interrupt requests, which can be exempted much as the COM ports and LPT ports above can. When an I/O device wants to gain the attention of the operating system, it signals this by causing an IRQ to occur. When the operating system is ready to respond to the request, it interrupts itself and performs the service. As above, the choices are “On” and “Off”. The default setting is listed on the Figure above.



## PNP/PCI CONFIGURATION

The System BIOS on a PCI platform plays the role of a System Resources Manager. Its main job is to dynamically allocate system resources such as I/O, Memory & IRQs to all PCI devices without any conflicts!

```

ROM PCI/ISA BIOS (2A5LD219)
PNP/PCI CONFIGURATION
AWARD SOFTWARE, INC.

PNP OS Installed      : No
Resources Controlled By : Auto
Reset Configuration Data : Disabled

CPU to PCI Write Buffer : Disabled
PCI Dynamic Bursting   : Disabled
PCI Master 0 WS Write  : Enabled

PCI IRQ Activated By  : Edge
PCI IDE IRQ Map To    : PCI-AUTO
Primary IDE INT#      : A
Secondary IDE INT#    : A

ESC : Quit          ↑↓↓↑ : Select Item
F1  : Help         PU/PD/+/- : Modify
F5  : Old Values   (Shift)F2 : Color
F6  : Load BIOS Defaults
F7  : Load Setup Defaults

```

that the off-board PCI IDE device is present and the system will route the IRQ to that SLOT. If an IDE IRQ MAP is set to ISA, the system does not need to route the IRQ because a paddle card is installed and the IRQ is received from an ISA slot. Otherwise, the IRQ can be routed correctly according to the specification of the INT# value.

### CPU to PCI Write Buffer/ Dynamic Bursting/0WS Write

These are setting which can boost the system performance. Default setting is “Disable”. You are not recommended to change the setting unless you know what are the functions of the item.

## INTEGRATED PERIPHERALS SETUP

The Integrated Peripherals Setup Menu is divided into different categories. Use the arrow keys to highlight the item and then use the <PgUp> or <PgDn> keys to select the value you want in each item.

```

ROM PCI/ISA BIOS (2A5LD0219)
INTEGRATED PERIPHERALS
AWARD SOFTWARE, INC.

OnChip IDE First Channel : Enabled
OnChip IDE Second Channel : Enabled
IDE Prefetch Mode : Enabled
IDE HDD Block Mode : Enabled
IDE Primary Master PIO : Auto
IDE Primary Slave PIO : Auto
IDE Secondary Master PIO : Auto
IDE Secondary Slave PIO : Auto
IDE Primary Master UDMA : Auto
IDE Primary Slave UDMA : Auto
IDE Secondary Master UDMA : Auto
IDE Secondary Slave UDMA : Auto

Onboard FDD Controller : Enabled
Onboard Serial Port 1 : Auto
Onboard Serial Port 2 : Auto
Infra Red (IR) Function : Disabled
Onboard Parallel Port : 378/IRQ7
Onboard Parallel Mode : ECP+EPP
ECP Mode Use DMA : 3

Onboard Game Port : Disabled
IR Transfer Mode : Full-Dup

ESC : Quit          ↑↓↓↑ : Select Item
F1  : Help          PU/PD/+/- : Modify
F5  : Old Values   (Shift)F2 : Color
F6  : Load BIOS Defaults
F7  : Load Setup Defaults

```

AUTO, the PIO mode will be set according to the value the drive reports with the auto detect hard disk function. The user may decrease the PIO mode by modifying this option, default is "AUTO".

### IDE Primary/Secondary and Master/Slave UDMA

Ultra DMA/33 implementation is possible only if your IDE hard drive supports it and the operation environment includes a DMA driver (Windows95 OSR2 or a third-party IDE bus master driver). If your hard drive and your system software both support Ultra DMA/33, select Auto to enable BIOS support.

### Onboard FDD Controller

This option allows you disable the on board FDD interface if you are not using it or you are using another peripheral as the FDD interface.

### Onboard Serial Port 1 / Port 2

You can configure the on-board serial port as COM1-COM4 or select "none" to disable the serial port.

### Infra Red (IR) Function

This option allows you disable the on board IR function if you are not using it. The Default setting is "Disabled". When enabled, two IR standards is possible ASKIR or HPSIR. Please refer to your IR device for detailed information.

### Onboard Parallel Port

The on-board parallel port can be configured as LPT1 (378), LPT2 (278) or select "none" to disable the parallel port.

### **Parallel Mode**

You can select SPP (Standard mode), EPP(Enhanced mode) and ECP(Extended mode) for parallel port mode in this menu. This communication mode is hardware dependent, please refer to your hardware manual for the Mode setting.

### **ECP Mode Use DMA**

This option specifies which DMA channel will be used when the parallel port is set to ECP mode.

### **Onboard Game Port**

No game port is provided in the motherboard and the Default setting is "Disabled". User is not recommended to change this field.

### **IR Transfer Mode**

The communication link between the system to the device can be half or full duplex. This option allows you to specify if the link is half or full duplex. Please refer to your IR device for detail information.

## LOAD BIOS DEFAULTS

This features stay in the default system values before the user has changed any CMOS values. If CMOS setting is lost. the BIOS defaults will automatically be loaded.

## LOAD SETUP DEFAULTS

This features load the default setting for normal use.

## PASSWORD SETTING

When you select the supervisor or user password function, the following message will appear on the screen to assist you in creating a password.

ENTER PASSWORD :

Type the password, up to eight characters, and press <Enter>. The password typed now will clear any previously entered password from CMOS memory. You will be asked to confirm the password. Type the password again and press <Enter>. You may also press <Esc> to abort the selection and not to enter a password.

To disable password, just press <Enter> when you are prompted to enter password. A message will confirm the password being disabled. Once the password is disabled, the system will boot and you can enter Setup freely.

PASSWORD DISABLED .

If you select System at Security Option of BIOS Features Setup Menu, you will be prompted for the password every time the system is rebooted or any time you try to enter Setup. If you select Setup at Security Option of BIOS Features Setup Menu, you will be prompted only when you try to enter Setup.

## IDE HDD AUTO DETECTION

You can use this utility to detect the IDE hard disk parameters. It can automatically detect up to four hard disk.

## SAVE AND EXIT SETUP

Select this option when you finished setup the CMOS and it will save the change you made and reboot the system after you press "YES".

## EXIT WITHOUT SAVING

If you decided not to save any change you had made, you can select this option to exit the CMOS setup and all the change you made will be ignored.

# Motherboard Technical Specification

## ENVIRONMENT

Parameter	Specification
<b>Operating</b>	
Temperature	+0°C to +55°C
Humidity	20% to 80%
Atmosphere	Non-condensing
<b>Non-operating/Transportation</b>	
Temperature	-20°C to +65°C
Humidity	10% to 90%
Atmosphere	Non-condensing
<b>TX Power Supply Requirement</b>	
±5 V	±5 %
±12 V	±5 %
<b>Vibration</b>	
Operating	0.2G Z axis (up and down), 5 to 300 Hz 0.1G X axis (front and rear), 5 to 300 Hz Y axis (left and right), 5 to 300 Hz

## DIMENSIONS AND WEIGHT

<b>Dimension Approx.</b>	220 x 200 mm (8.5 x 8 inches)
<b>Net Weight</b>	0.46 Kg (1.05 lb.)

## ELECTRICAL SPECIFICATION

<b>Onboard Voltage Regulation</b>	Under 3.3V condition
Voltage transient	± 5%
Set point variation	± 1%
<b>Onboard Current Limitation</b>	
Under 3.3V condition	about 14 Ampere (max.)

## POWER CONSUMPTION

The board is designed to operate with 140-200 W AT power supply. For a system configured with the motherboard including a 200 MHz Pentium processor w/ 256 KB Cache, 64 MB EDO DRAM, 3.5-inch floppy drive, 2.1 GB IDE hard drive, 8X IDE CD-ROM, and a PCI graphics card, The overall calculated power dissipation is about 80W. However, this information is provided only as reference for the total system power usage.

# Request For Technical Support

In order to provide you with effective and quick technical support, we need to know your system specification and environments. Please fill the following form as complete as possible so we can give you assistance.

PRODUCT INFORMATION	
MODEL	
CHIPSET MODEL	
RAM TYPE/SIZE/BRAND/SPEED	
BIOS VERSION	
PURCHASE DATE	
PROBLEM DESCRIPTION	
OPERATING SYSTEM	
APPLICATION SOFTWARE	
PROBLEM DESCRIPTION	

SYSTEM CONFIGURATION		
Display Card (Brand/Model)		
Resolution		
IDE Controller Card (Brand/Model)		
LAN Card (Brand/Model)		
Fax/Modem Card (Brand/Model)		
SCSI Controller (Brand/Model)		
Multi I/O Card (Brand/Model)		
Other Add-on Card (Brand/Model)		
IDE Disk Drive	PRIMARY MASTER (Brand/Model)	
	PRIMARY SLAVE (Brand/Model)	
	SECONDARY MASTER (Brand/Model)	
Floppy Drive	SECONDARY SLAVE (Brand/Model)	
	DRIVE A (Brand/Model)	
	DRIVE B (Brand/Model)	
Other Device (Brand/Model)		