

The  
**COMPLETE**  
**GUIDE TO**  
**HIGH-PERFORMANCE**  
**COMPUTING**  
**WITH YOUR**  
**PANTERA**  
**COMPUTER**

# User's Guide

**ZEOS**<sup>®</sup>

© Copyright 1995  
Micron Electronics, Inc.  
All rights reserved

ZEOS shall not be held liable for technical or editorial omissions or errors made herein; nor for incidental or consequential damages resulting from furnishing, performance, or use of this material. This document contains proprietary information protected by copyright. No part of this document may be photocopied or reproduced by mechanical, electronic, or other means in any form without prior written permission of ZEOS.

**Limitation of remedies and liabilities:**

ZEOS' entire liability and customers' exclusive and sole remedy for damages from any cause whatsoever (including without limitation any nonperformance, misrepresentation, or breach of warranty) shall be limited to returning the products pursuant to the thirty (30) day money-back guarantee, or to repair or replace specific products or services that do not comply with the Limited Warranty offered by ZEOS. In no event will ZEOS be liable for any damages caused, in whole or in part, by customer, or for any economic loss, physical injury, lost revenues, lost profits, lost savings or other indirect, incidental, special or consequential damages incurred by any person, even if ZEOS has been advised of the possibility of such damage for claims.

Some states do not allow the exclusion or limitation of incidental or consequential damages for consumer products, and some states do not allow limitations on how long an implied warranty lasts, so the above limitations or exclusions may not apply to you.

**Trademark Acknowledgments**

Adaptec is the trademark of Adaptec, Inc.

IBM, XT, AT, and OS/2 are registered trademarks of International Business Machines Corporation.

UNIX is a trademark of AT&T Laboratories.

Phoenix is the trademark of Phoenix Technologies Ltd.

Quadtel is the trademark of Quadtel Corp., A Phoenix Technologies Ltd. Co.

Intel, 486SX, DX, DX2, DX4, and Pentium are trademarks of Intel Corporation.

XENIX, MS-DOS, GW-Basic, Windows, and Microsoft are trademarks of Microsoft Corporation.

All other brand and product names are trademarks or registered trademarks of their respective companies.

## **ZEOS Computer Systems One Year Limited Warranty**

All new ZEOS computer systems come with a One Year Limited Warranty which provides that the products ZEOS manufactures or assembles, other than items such as software, disks and related documentation, will remain in good working condition, free from defects in material and workmanship under normal use and service, for a period of one year from the date of shipment from ZEOS. This warranty is limited to the original purchaser and is not transferable. During this one year period, ZEOS will repair or replace, at its option, any defective product or parts at no additional charge to the customer, provided that the defective product or part is returned, shipment prepaid, to ZEOS. All replaced products and parts become the property of ZEOS. Replacement parts shall be similar new or serviceable used parts. This Limited Warranty does not extend to any products which have been damaged as a result of accident, misuse, abuse (such as incorrect voltages, power surges, improper or insufficient ventilation, failure to follow ZEOS' provided operating instructions, "acts of God" or other situations beyond the control of ZEOS), or as the result of service or modification by anyone other than ZEOS. Non-ZEOS installed parts or components are not covered, nor is damage to ZEOS provided components covered as a result of their installation. This warranty does not cover work performed by others, all warranty work must be performed by ZEOS. ZEOS provides no warranties whatsoever on software.

**EXCEPT AS SPECIFICALLY PROVIDED IN THIS SECTION, THERE ARE NO OTHER WARRANTIES EXPRESS OR IMPLIED INCLUDING BUT NOT LIMITED TO ANY IMPLIED WARRANTIES OF MERCHANTABILITY OR FITNESS FOR A PARTICULAR PURPOSE.**

# Contents

<b>1. The Big Picture .....</b>	<b>9</b>
Desktop System At A Glance .....	10
Tower System At A Glance .....	12
How to Open a Desktop Case .....	14
How to Open a Tower Case .....	16
Inside a Desktop Computer .....	18
Inside a Tower Computer .....	19
<b>2. The Mainboard .....</b>	<b>20</b>
Mainboard Features .....	20
PCI Local Bus 32-Bit High Speed Expansion Slots .....	21
Secondary Cache Subsystem .....	21
Continuous Full-Speed Processing .....	21
On-Board Peripherals .....	22
Serial Ports .....	23
Parallel Port .....	24
PCI SCSI/ Ethernet Port .....	25
Mainboard Diagram .....	26
Mainboard Connectors .....	27
Mainboard Jumpers .....	28
Jumper Settings .....	29
Mainboard Jumpers Described .....	30
FLSH .....	30
CLR .....	30
CLK1 .....	31
CACHE1 .....	31
<b>3. Using SETUP .....</b>	<b>32</b>
Main Menu .....	33
Main Menu Options .....	34
System Time .....	34
System Date .....	34
Daylight Savings .....	34
Diskette Drive A: .....	34
Diskette Drive B: .....	34
IDE Adapters (Four Provided) .....	34
Video System .....	35

Memory Control .....	36
Memory Shadow .....	37
Advanced Menu .....	38
Large Disk Access Mode .....	38
OS support for more than 64MB .....	38
Plug & Play O/S .....	38
Integrated Peripherals .....	38
PCI Devices .....	41
Security Options .....	42
Supervisor Password is .....	42
User Password is .....	42
Password on boot .....	43
Diskette access .....	43
Fixed disk boot sector .....	43
System backup reminder .....	43
Virus check reminder .....	43
Power Options .....	44
Power Savings (DOS and Windows) .....	44
Exit Menu Options .....	45
<b>4. Expanding Your System .....</b>	<b>46</b>
Adding an Expansion Board .....	46
How Disk Drives Work .....	48
How a Floppy Drive Works .....	49
How an IDE Hard Drive Works .....	50
How a CD-ROM Drive Works .....	51
Adding System RAM .....	52
Installing SIMMs .....	53
Adding System Cache Memory .....	55
Installing a New CPU .....	57
<b>5. Mainboard Specifications .....</b>	<b>59</b>
Mainboard Environmental Specifications .....	59
9-Pin Serial Port (J2) Pin Assignment .....	60
25-Pin Serial Port (J3) Pin Assignment .....	60
Parallel Port (J4) Pin Assignment .....	62

Handy Cheat Sheet .....	64
Glossary .....	66
Index .....	68

# FCC Compliance Statement

## For U.S. and Canadian Users

### Warning!

*Changes or modifications to this unit not expressly approved by the party responsible for compliance could void the user's authority to operate the equipment.*

This equipment has been tested and found to comply with the limits for a Class B digital device, pursuant to Part 15, Subpart B of the FCC Rules. These limits are designed to provide reasonable protection against harmful interference in a residential installation. This equipment generates, uses and can radiate radio frequency energy and, if not installed and used in accordance with the instructions, may cause harmful interference to radio communications.

However, there is no guarantee that interference will not occur in a particular installation. If this equipment does cause harmful interference to radio or television reception, which can be determined by turning the equipment on and off, the user is encouraged to try to correct the interference by one or more of the following measures.

- Reorient or relocate the receiving antenna.
- Increase the separation between the equipment and receiver.
- Connect the equipment into an outlet on a circuit different from that to which the receiver is needed.
- Consult the dealer or an experienced radio/TV technician for help.

The connection of a non-shielded equipment interface cable to this equipment will invalidate the FCC Certification of this device and may cause interference levels which exceed the limits established by the FCC for this equipment.

This equipment is a Class B digital apparatus which complies with the Radio Interference Regulations, C.R.C., c. 1374.

Cet appareil numérique de la classe B est conforme au Règlement sur le brouillage radioélectrique, C.R.C., ch. 1374.

# Customer Assurance Program

## Thirty (30) Day Money-Back Guarantee on Most Products.

Any product (except for software, software disks, related documentation and consumables) purchased from ZEOS may be returned within thirty days from the date it was shipped by ZEOS for a full refund of the purchase price excluding original shipping charges.

Returned products must be in as new condition, in original packing, complete with all warranty cards, manuals, cables and other materials as originally shipped; not modified or damaged.

Any returned product must be shipped prepaid and insured. Any return must carry a ZEOS Return Merchandise Authorization (RMA) number, obtained from ZEOS, on the outside of each carton. Returns without RMA numbers will not be accepted. After thirty days from shipment, all sales are final and credit or refunds will not be given.



# 1. The Big Picture

Welcome to the *ZEOS User's Guide*! The *User's Guide* works with the *Getting Started* manual to help keep your system running trouble free, year after year.

This *User's Guide* is divided into five chapters.

**Chapter 1, The Big Picture** gives an overview of a typical desktop and tower system. It also shows the major components inside the computer case.

**Chapter 2, The Mainboard** gives detailed information about your mainboard.

**Chapter 3, Using SETUP** explains how to use the SETUP utility program to customize the built-in features of your system's BIOS (Basic Input/Output System).

**Chapter 4, Expanding Your System** shows how to add components and enhancements to your system. These include a video adapter card, a controller card, an internal modem, a floppy drive, an IDE hard drive, a CD-ROM drive, memory RAM SIMMs, system LEVEL 2 cache, and a new CPU.

**Chapter 5, Mainboard Specifications** includes your mainboard specifications, environmental specifications, plus pin assignments for your serial and parallel ports.

The **Handy Cheat Sheet** gives a short summary of some of the most needed or most forgotten commands.

The **Glossary** gives short definitions of some common computer terms.

# Desktop System At A Glance

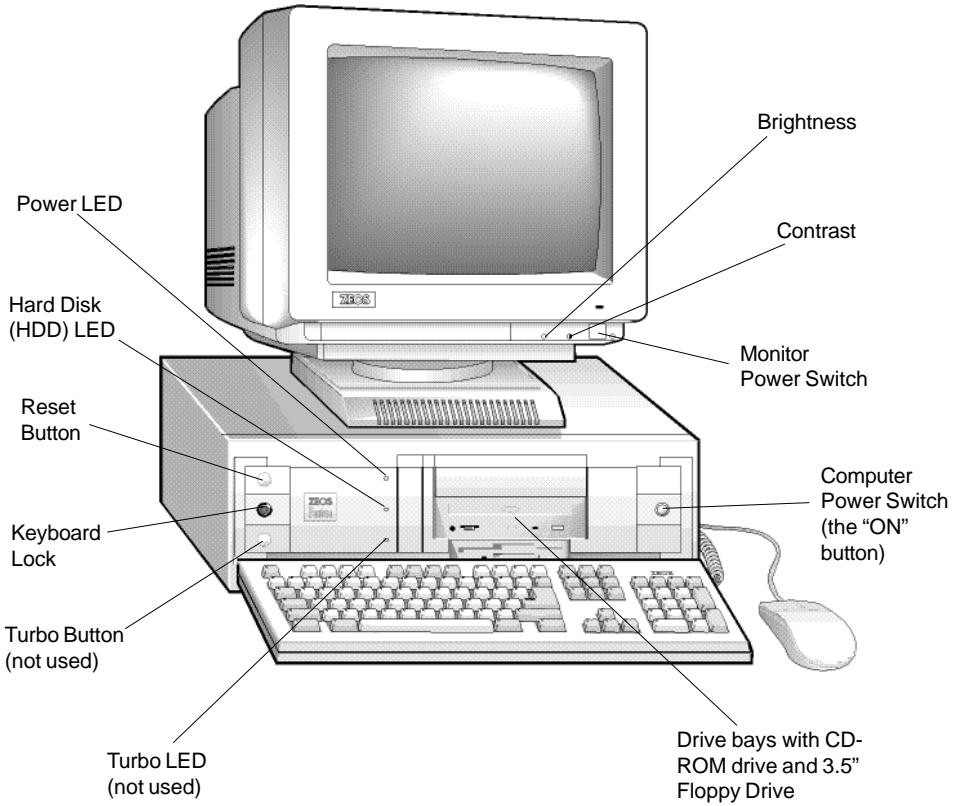

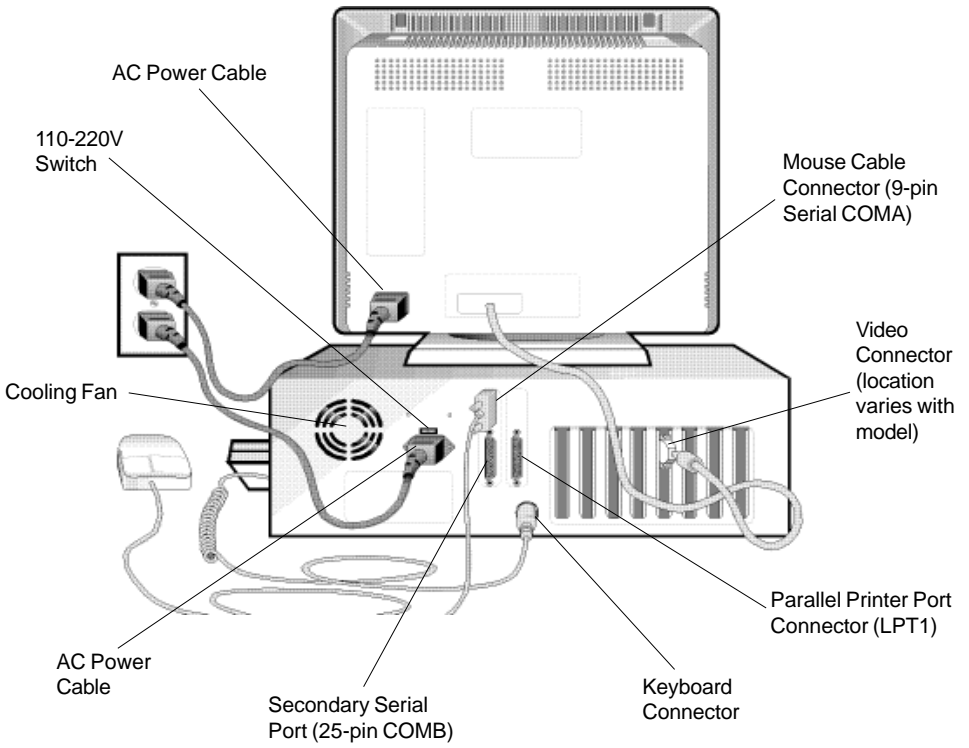

# Tower System At A Glance

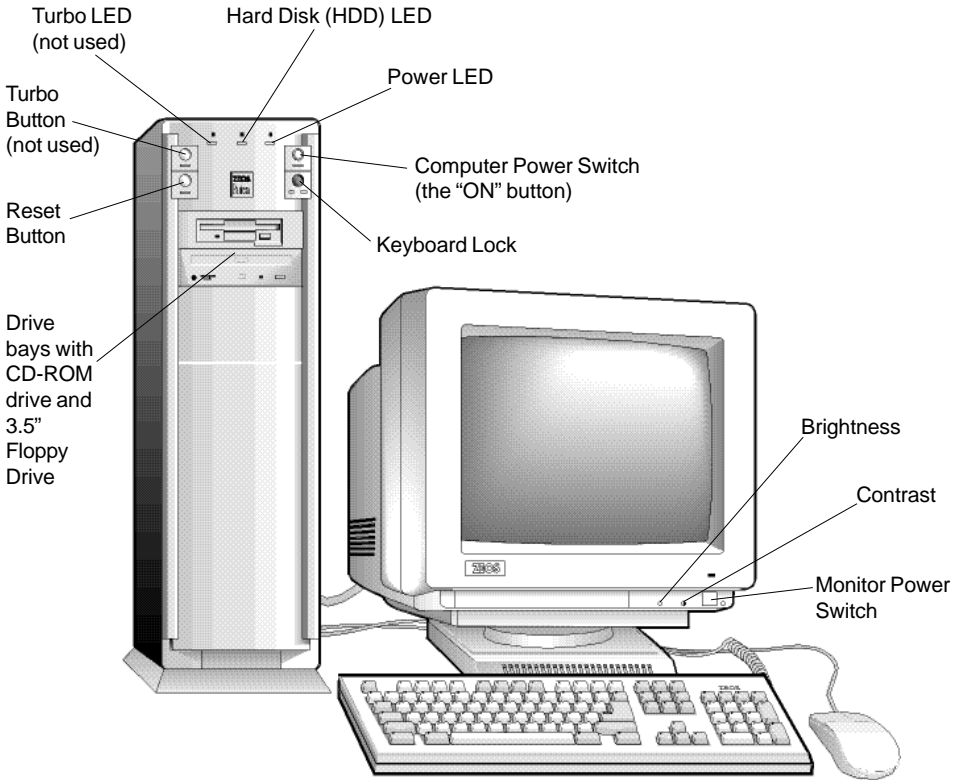

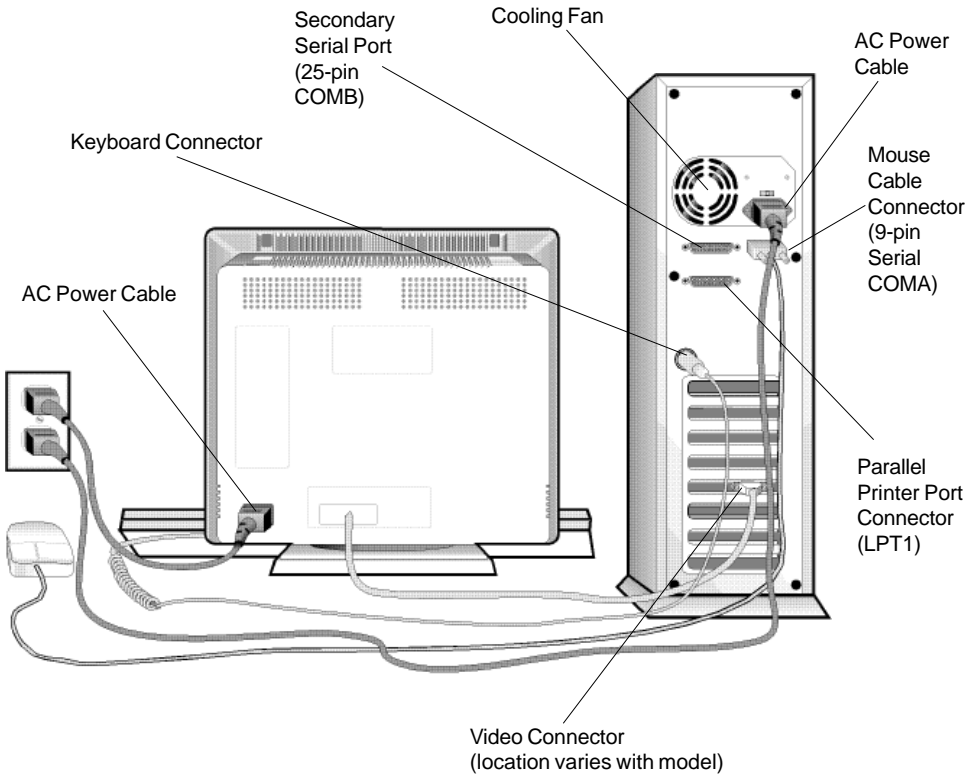

## How to Open a Desktop Case

### Caution:

*Whenever you open the case or work inside the computer there is danger of static electric shock. These shocks can permanently damage your equipment. Always ground yourself by touching the system cabinet before touching any internal component. We strongly recommend using an antistatic wrist strap attached to cabinet ground.*

To open a desktop case:

1. Turn off the monitor and system unit power. Unplug the AC power cables and disconnect any other cables attached to the back of the system unit.
2. Remove the plastic bezel from the back of the case by pulling it away from the case.
3. Unscrew the five mounting screws at the back of the case that hold the case cover to the system unit chassis.
4. Slide the case cover back and up. Be careful not to snag any cables or connectors inside the case.
5. Set the case cover aside while you work on your system.
6. When through, reattach the case cover, screws, bezel, and cables in the reverse order.

The figures opposite show the plastic bezel, screw locations, and how to remove a desktop PC's cover.

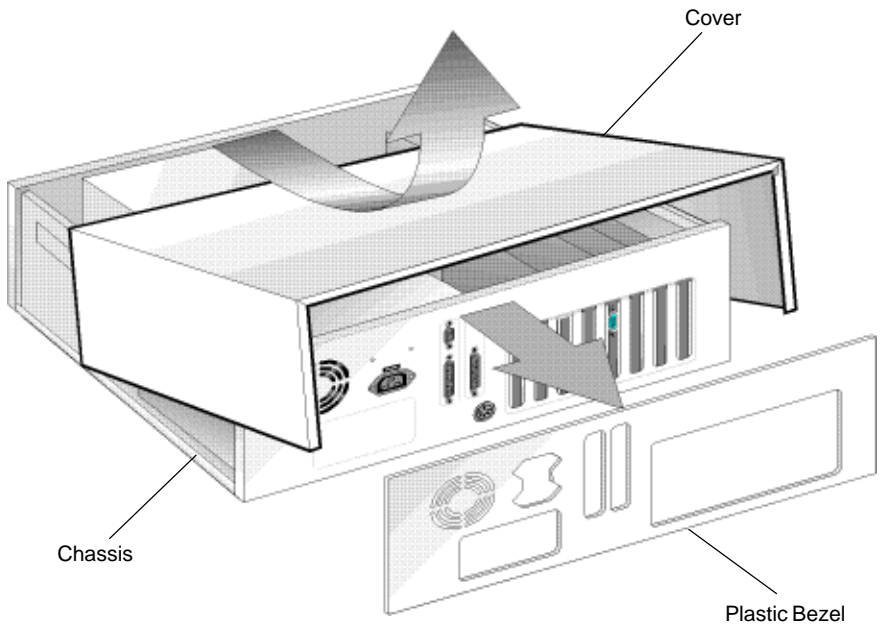
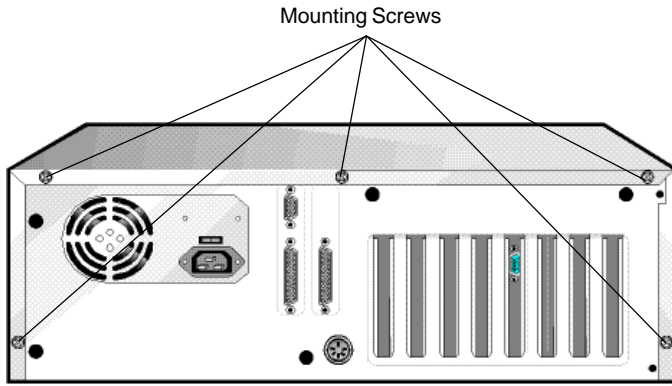

## How to Open a Tower Case

### Caution:

*Whenever you open the case or work inside the computer there is danger of static electric shock. These shocks can permanently damage your equipment. Always ground yourself by touching the system cabinet before touching any internal component. We strongly recommend using an antistatic wrist strap attached to cabinet ground.*

Opening a tower case is almost identical to opening a desktop case.

To open a tower case:

1. Turn off the monitor and system unit power. Unplug the AC power cables and disconnect any other cables attached to the back of the system unit.
2. Remove the plastic bezel from the rear of the case by pulling it away from the case.
3. Unscrew the six mounting screws at the back of the case that hold the case cover to the system unit chassis.
4. Slide the case cover back and up, taking care not to snag any cables or connectors inside.
5. Set the case cover aside while you work on your system.
6. Afterwards, reattach the case cover, screws, bezel, and cables in the reverse order.

The figures opposite show the plastic bezel, screw locations, and cover motion for a tower case.



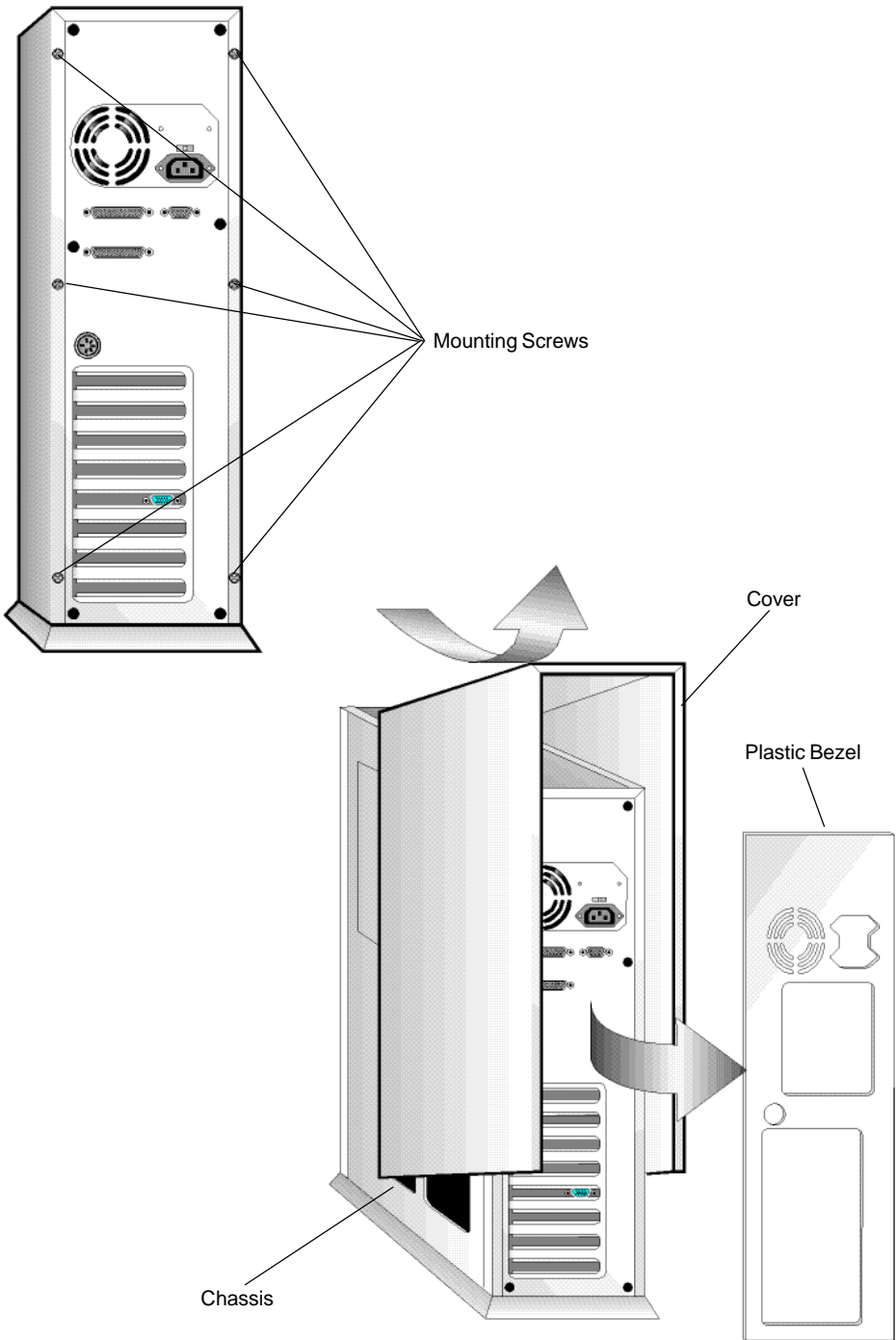

# Inside a Desktop Computer

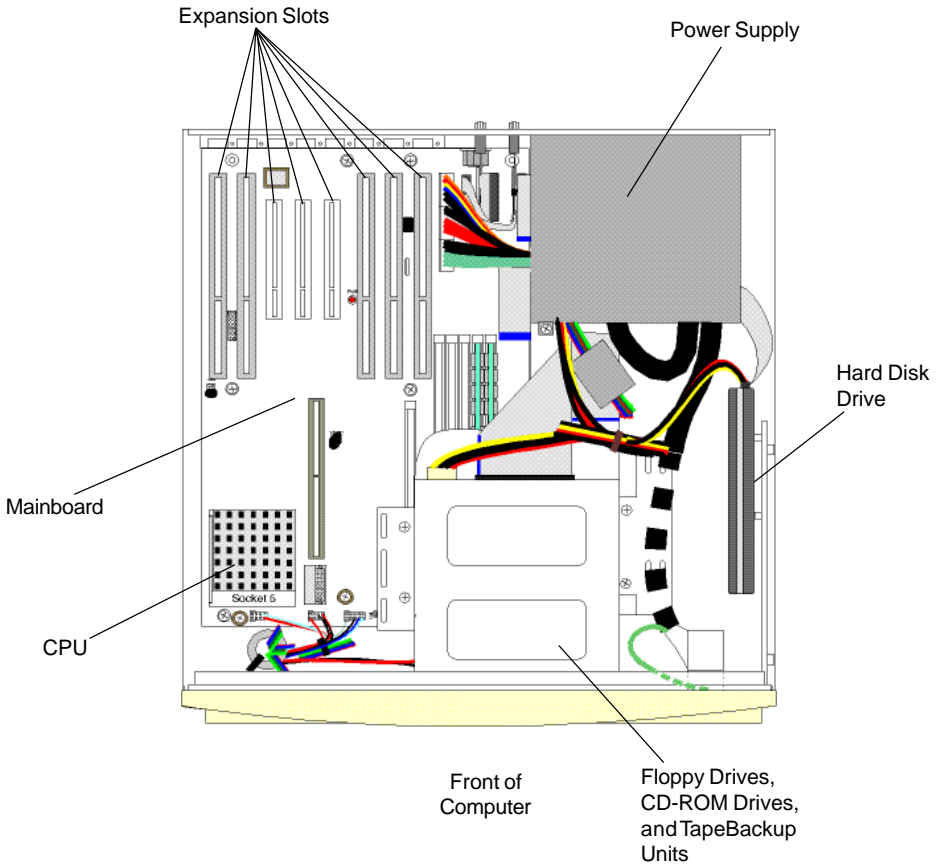

The mainboard is the large circuit board at the bottom of the chassis. It is the heart of your system. All of the other components inside the case work for the mainboard. The power supply delivers electricity to the mainboard. The disk drives, keyboard connectors, and other parts of the system unit bring information to and from the mainboard.

The figure above shows some of the most common components inside the computer.

# Inside a Tower Computer

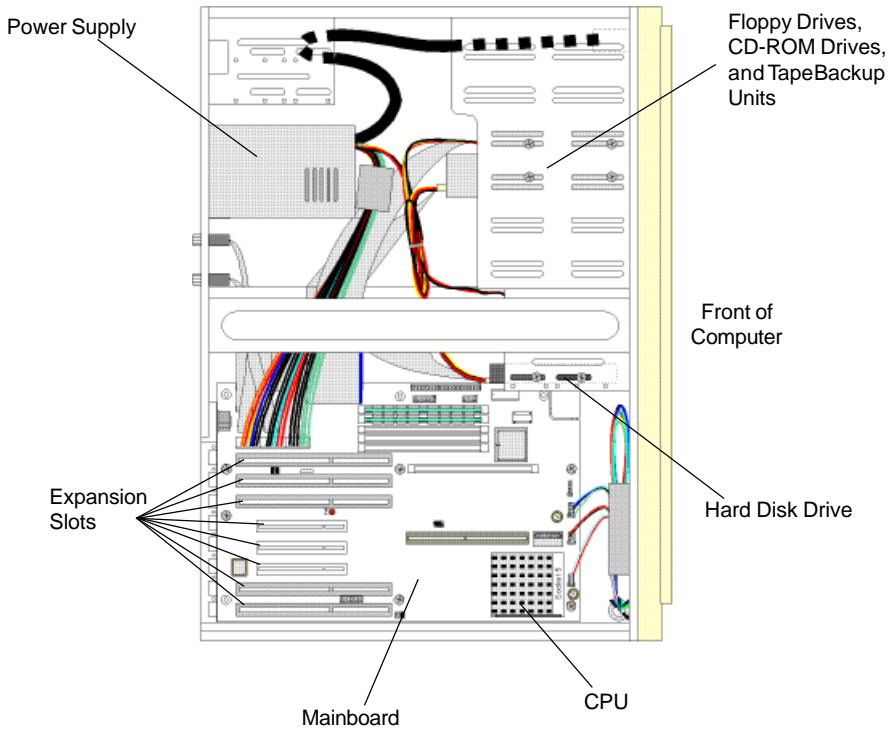

Tower systems have the same components as desktop systems. The figure above shows the mainboard and typical components inside a Tower case.

## 2. The Mainboard

The mainboard is the largest circuit board in the computer. It contains the CPU (Central Processing Unit), the Level 2 cache, expansion slots, ports and connectors for other components, and the system's main memory, or RAM (Random Access Memory).

### Mainboard Features

Standard Features:

- Intel Pentium (P54C) running at 75, 90, 100, 120, or 133MHz
- Optional 256K or 512K Level 2 system cache, write-back, direct-mapped
- Integrated onboard floppy drive controller
- Two onboard IDE hard drive interface ports supporting up to 4 IDE devices (both are PCI local bus)
- Bidirectional Parallel Port (configurable through software)
- Two RS232, 16550 high-speed serial ports
- RAM Configurations: 2, 4, 6, 8, 10,12, 16, 32, 64, 128, 192, 384MB, etc. (Banks must hold identical pairs)
- 384Mb maximum RAM capacity
- Flash BIOS, relocatable to system RAM to boost performance
- Five 16-bit ISA expansion slots
- Three 32-bit PCI local bus expansion slots
- Clock/calendar with onboard battery backup
- Energy saving, low power "sleep" mode

Factory Installed Options:

- AMD SCSI host adapter socket on PCI bus
- AMD network controller on PCI bus

## **PCI Local Bus 32-Bit High Speed Expansion Slots**

The three PCI local bus, high speed expansion slots move information at up to 132 MB/s. This offers a high performance, 32-bit interface to support local bus peripherals such as video cards, LAN adapters and hard disk drives.

## **Secondary Cache Subsystem**

The secondary (Level 2) cache subsystem enhances the performance of the CPU. The onboard cache controller allows cache memory to provide an ultra high-speed, 12-15-nanosecond buffer between the CPU and conventional (50, 60, or 70ns) RAM. Your system can accommodate three cache configurations: 0K, 256K, or 512K of Level 2 cache. The single cache slot (labelled CACHE) is located next to the CPU.

## **Continuous Full-Speed Processing**

Pantera systems now run continuously at maximum speed, eliminating Turbo Mode. Because of this, the Turbo button and Turbo LED are not used on Pantera systems.

## **On-Board Peripherals**

Your mainboard has all of the standard peripheral interfaces and many extras built in. This eliminates the need for many peripheral expansion cards and greatly enhances system reliability.

Integrated onboard peripherals include:

- Two serial ports (16550 UART)
- Parallel port (bidirectional, assigned through SETUP)
- Floppy drive controller (handles floppy drives up to 2.88Mb)
- Two PCI local bus IDE hard drive controller ports, each capable of controlling two hard drives

Factory installed options:

- SCSI port (supports both SCSI-1 and -2 type devices)
- Ethernet port

## **Serial Ports**

Your mainboard has two RS-232C asynchronous serial ports, which are usually referred to as COM1 or COMA (9-pin) and COM2 or COMB (25-pin) ports. The serial ports are used to attach mice, serial printers, modems, or other serial peripheral devices. Both serial ports are 16550 UART compatible for higher data transfer rates.

You can install up to two additional serial ports (COM3 and COM4) simultaneously in your system. However, because MS-DOS does not manage more than two COM ports simultaneously very well, you shouldn't attempt to use more than two COM ports at the same time. Specifically, don't try to use COM1 and COM3 at the same time, or COM2 and COM4 at the same time.

## **Parallel Port**

The 25-pin Centronics parallel port is often called the *printer* port because it is usually used for printers. However, devices that use this speedy parallel interface are becoming more common. Your Pantera's parallel port is also Bidirectional, allowing data to flow to and from an external device at the same time.



## **PCI SCSI/ Ethernet Port**

The optional onboard SCSI (host adapter allows you to connect and control up to seven peripheral devices such as SCSI-compatible disk drives, tape backup units, communications devices, and CD-ROM drives.

The SCSI port is a parallel, multitasking interface which supports both SCSI-1 and SCSI-2 devices.

The SCSI port is configured from the system SETUP program. For SCSI system setup parameters, refer to the SCSI Control Menu in *Using SETUP*.

The SCSI host adapter socket can also accept an Ethernet LAN controller chip allowing you to make direct Ethernet LAN connections for high speed local area network communications.

*Note: The onboard SCSI and LAN options are factory installed options only. The onboard SCSI and LAN option can only be upgraded at the time of purchase.*



## Mainboard Connectors

Connectors and headers are used to attach peripheral devices to the mainboard. These devices can be internal (e.g., hard disk indicator lights), or external (e.g., serial and parallel ports). The most commonly used connectors are shown in the *Mainboard Diagram*. The table below provides a brief summary.

**Table 1. - Mainboard Connectors**

Connector ID	Description
J1	Keyboard connector
PS1	Main power supply header
PS2	PCI 3.3 volt power supply header
J2	COMA: communications port A (DB9)
J3	COMB: communications port B (DB25)
J4	LPT1: Parallel “printer” port header
J5	Floppy disk drive header
J6	Legacy ISA header
J7	Primary IDE hard drive header (PCI local bus)
J8	Secondary IDE hard drive header (PCI local bus)
J9	10Base2 (BNC) adapter header
J10	10BaseT (RJ45) adapter header
J11	SCSI device header
J13	KBDLOCK: Keyboard Lock input
J14	SPEAKER output, HDD LED output
J15	RESET switch input, Mute LED (not used), Business Audio Mute (not used)
VREG	Voltage Regulator connector (for future CPUs)

# Mainboard Jumpers

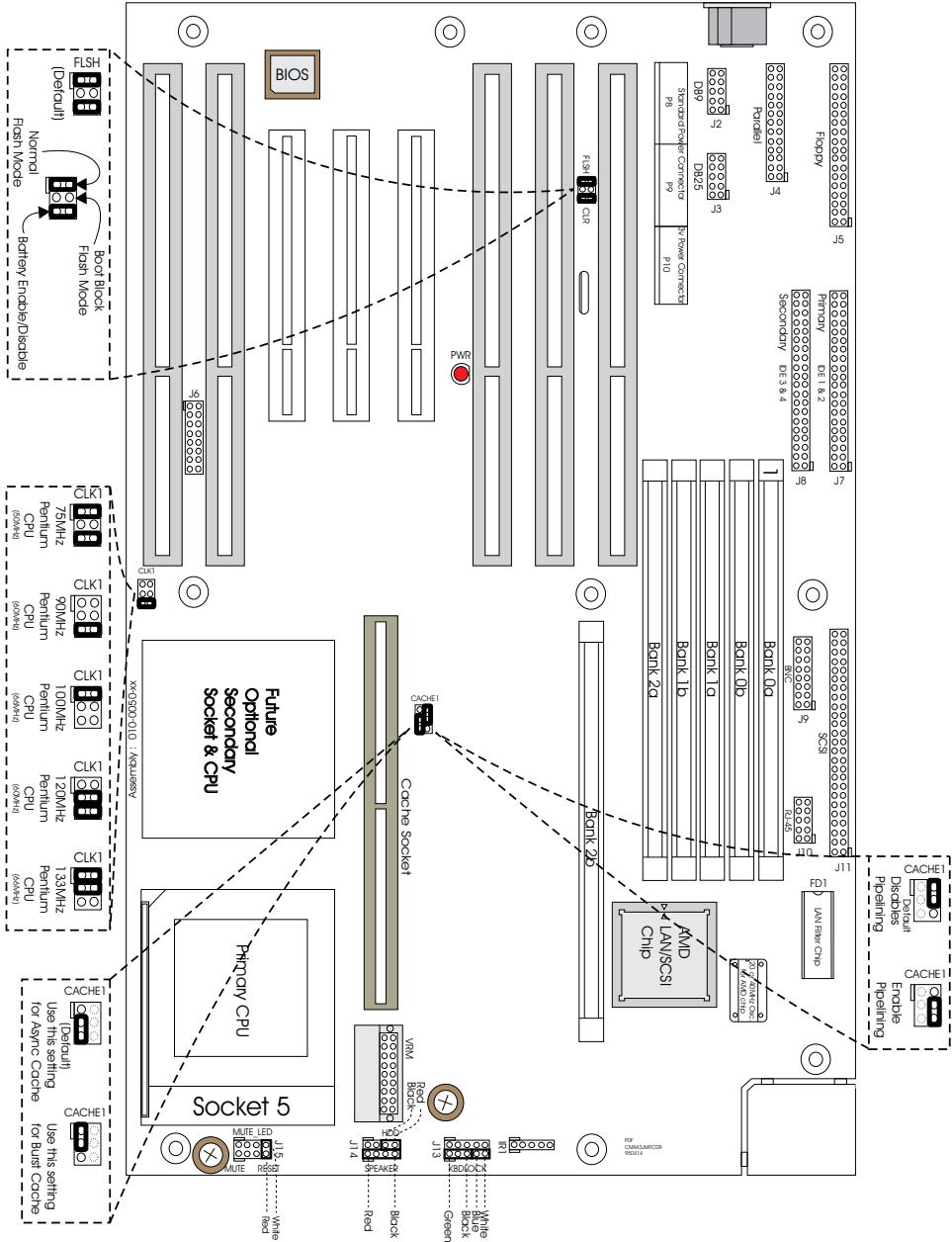

# Jumper Settings

## CLK1 (Adjusts CPU and Bus Frequencies)

CPU Frequency/Bus Frequency (preset at factory)



75MHz CPU/50MHz Bus



90MHz CPU/60MHz Bus



100MHz CPU/66MHz Bus



120MHz CPU/60MHz Bus



133MHz CPU/66MHz Bus

## FLSH /CLR (Controls Storage of Flash BIOS Data)

Flash BIOS; CMOS Battery



FLSH: Normal Operation  
(default)



FLSH: Reprogram Boot  
Block (software controlled)



CLR: CMOS Battery  
Enabled



CLR: CMOS Battery  
Disabled

## CACHE1 (Sets Level 2 Cache Modes)

Asynchronous or Burst; Pipelining Enabled or Disabled



Asynchronous Cache  
(default)



Burst Cache



Enable Pipelining



Disable Pipelining  
(default)

## Mainboard Jumpers Described

Jumpers are small groups of pins that can be connected or disconnected with jumper caps. To connect a jumper, carefully place the jumper cap over the pins you wish to connect, then gently press down.

The mainboard uses four jumpers, allowing great system flexibility. However, most system settings are stored in battery-backed CMOS (Complimentary Metal-Oxide Semiconductor) memory. You can use the BIOS SETUP program to change settings stored in the CMOS.

Other mainboards use jumpers to configure upgrade options and parameters on the mainboard. Pantera mainboards use the SETUP program and the FLASH programming utility instead, making BIOS changes and upgrades without removing the BIOS chip.

### FLSH

The FLSH jumper allows or disallows reprogramming of the FLASH BIOS with the FLASH utility program. The factory default (NORMAL) setting allows you to reprogram the BIOS with the FLASH utility.

### CLR

The CLR jumper maintains your BIOS settings or allows you to restore them to factory defaults. Settings are stored in a CMOS (Complimentary Metal-Oxide Semiconductor) chip. Do not clear these settings unless they become corrupted and cannot be reprogrammed with the SETUP program, which also can reset the factory default BIOS settings.

To clear the CMOS memory:

1. Turn off system power and remove the case (pp.14-16).
2. Remove the CLR jumper (p.28). This disconnects the CMOS battery.
3. Turn on system. System will report a dead battery. Turn off system, replace the CLR jumper. Settings are now cleared.
4. Turn on system, enter SETUP (press the F2 key during bootup).
5. Reconfigure BIOS settings, including passwords and LBA Mode Control (if your hard drive holds more than 528MB).
6. Save and Exit SETUP.

(continued next page)

## **CLK1**

The CLK1 jumper sets the speed of the system clock. It will be set correctly to work with your system, so don't change this jumper unless you change CPUs.

<b>Pins Jumpered</b>	<b>CPU Clock Speed (MHz)</b>	<b>Bus Clock Speed (MHz)</b>
1-2 , 5-6	75	50
5-6	90	60
1-2	100	66
3-4, 5-6	120	60
1-2, 3-4	133	66

See the diagram, *Mainboard Jumpers*, for the location of all jumpers.

## **CACHE1**

A fast CPU operates more efficiently when it has a buffer of ultrafast RAM between itself and system RAM. The CACHE1 jumper configures how Level 2 cache is used by your system. 256K to 512K of cache can be added by inserting a standard cache SIMM. The cache controller is integrated into the system chipset.

### **CPU Pipelining**

Increases data throughput by allowing the CPU to start the next machine cycle before it finishes processing the current one.

### **Burst Cache Module**

During a single machine cycle, a bursting CPU generates a beginning address and a quantity of bytes for the cache to expect. Then the CPU transfers that quantity of bytes as a single package, without needing to generate any intermediate addresses.

### **Asynchronous Cache Module**

An asynchronous cache can generate wait states that tell the CPU to delay transferring information until valid data is ready to be transferred to or from the cache.

## 3. Using SETUP

The SETUP utility program allows you to customize the power-on initialization parameters of your computer's BIOS (Basic Input/Output System). You may need to use the SETUP program if you add components to your system. To run the BIOS SETUP program, press **F2** during system boot. Once inside SETUP, you can reach different sections by pressing the right/left arrow keys on your keyboard. Inside each section, you can go into a subsection (indicated by a right-pointing triangle on the left side of the screen) by moving to it with the up/down arrow keys, then pressing the Enter key.

Setup's five sections are Main, Advanced, Security, Power, and Exit. Each section contains topics you can view or adjust to suit your system's needs. SETUP allows you to customize various system parameters, although our technicians optimize them for your system as shipped. If you inadvertently change BIOS values that cause your system to malfunction, you can simply reload the original factory default settings from ROM by entering SETUP, then pressing the **F9** key. Otherwise, you can load the most recently saved settings from battery backed CMOS by pressing **F10**. Within SETUP, pressing **F1** toggles the General Help window, while the right-hand panel describes the function of the currently highlighted topic.

To change your BIOS settings, first use the arrow keys to highlight the desired topic, then press the space bar or the <+> or <->key on the numeric keypad to rotate through the available options. Note: only an item whose label is surrounded by [square brackets] may be changed; values not in brackets can only be viewed.

Once you've finished customizing your BIOS settings, press the **Esc** key a couple times to reach the Exit menu. There you can decide if you really want to keep your changes, if you'd prefer to return to the factory defaults, or if you want to go back to using your previously saved values. In any case, remember you can always change the BIOS settings again next time you boot up.



## Main Menu

Your system's BIOS settings were configured at the factory to maximize performance with the options you ordered. Generally, you need to run SETUP only if you install a new or different hard drive, if the onboard battery fails, or if you otherwise add to or change your basic hardware.

SETUP's Main Menu allows you to view and configure several basic parameters, including system time, date, and daylight savings, Diskette A and B, system memory (RAM) timing, memory shadowing, boot sequence options, and video system type.

The Main Menu lets you configure four PCI local bus IDE devices:

- IDE Adapter 0 Master (Drive letter, capacity in megabytes)
- IDE Adapter 0 Slave (Drive letter, capacity in megabytes)
- IDE Adapter 1 Master (Drive letter, capacity in megabytes)
- IDE Adapter 1 Slave (Drive letter, capacity in megabytes)

Each of the four IDE Adapter subsections lets you view and customize the settings for a separate PCI local bus IDE device attached directly to you mainboard. The subsections are described on the following pages.

SETUP's Main Menu also contains subsections for Memory Control, Memory Shadow, and Boot Sequence. Finally, System Memory and Extended Memory are displayed. At the very bottom is a chart showing how to navigate and change values in SETUP.

## Main Menu Options

### System Time

Sets the real-time clock, using a 24-hour format. During the power-up sequence, the real time is read and saved in memory for use by the operating system. After boot up, the operating system updates the system time.

### System Date

Sets the real-time date for month, day, and year. During the power-up sequence, this information is read and saved in memory for use by the operating system to determine the current date. After completing the power-up sequence, the operating system updates the current date.

### Daylight Savings

Adjusts system clock for daylight savings time. Default: Enabled.

### Diskette Drive A:

Specifies the size and capacity of the floppy-disk drive installed as drive A. Options are: 360K, 720K, 1.2M, 1.44M, and 2.88M.

### Diskette Drive B:

Specifies the size and capacity of the floppy-disk drive installed as drive B.

### IDE Adapters (Four Provided)

Each of the four IDE Adapter subsections allows you to view and change configurations of the IDE devices attached to your onboard IDE Hard Drive connectors, J7 and J8. The IDE Adapter subsections list the IDE devices that are currently installed. Your Primary hard drive (J7) is listed as *IDE Adapter 0 Master*. You can attach a second hard drive to the same cable as *IDE Adapter 0 Slave*, then two more devices on the Secondary connector (J8) as *IDE Adapter 1 Master*, or *IDE Adapter 1 Slave*. The following page describes the contents of each IDE Adapter subsection.

*Note: If you attach two drives to a single drive cable, it doesn't matter whether or not the Master drive is connected to the end connector. Just be sure that one drive is configured as Master and the other drive is configured as Slave.*

## Autotype Fixed Disk

This utility detects and configures your IDE Adapter, if the device conforms to ANSI technical specifications. ZEOS drives are configured at the factory, so to add a hard drive you just run Autotype. If Autotype is successful, it will identify your hard drive type and display the drive parameters. Otherwise, you can select one of the established drive type numbers from the *Type* list, or select Type USER to set Cylinders, Heads, Sectors/Track and Write Precomp yourself (according to the information supplied by the device's manufacturer).

*Note: Don't alter drive parameters unless you change or add a hard drive.*

## Multi-Sector Transfer

Determines the number of sectors per block for multiple sector transfers. Options are Disabled, 2, 4, 8, and 16. Older hard drives (and even some newer drives) will not work properly if the number of sectors is set too high. Default: 16.

*Note: Before adding a new hard drive or formatting one from Zeos, first disable Multi-Sector Transfers, then format the drive, then run FDISK. Later, you can enable Multi-Sector Transfers again.*

## Write Precomp

Write Precompensation. In older hard drives, this setting tells the drive to apply a stronger magnetic field to inner tracks of the disk to *compensate* for magnetic drift. Your hard disk manufacturer's documentation should tell you if your drive requires this setting.

Default: *None* (Disabled).

## LBA Mode Control

Enables or disables Logical Block Addressing, allowing you to use large IDE hard drives. This must be enabled for IDE hard drives greater than 528 MB. Default: Set at the factory.

## Video System

This option sets the video type. It can be set to *Monochrome*, *CGA 80 x 25* (80 column Color Graphics), or *EGA/VGA* (Enhanced/Video Graphics Adapter). Default: EGA/VGA.

## Memory Control

The Memory Control subsection lets you view and change DRAM (system RAM) Timing, enable/disable the L2 (Level 2) External Cache, and determine which shadowed upper memory regions (in addition to system and video) are allowed to be cached in a superfast (12-15ns) 256K or 512K SIMM.

### DRAM Timing

Sets the upper limit for DRAM (system RAM) speed to 50, 60, or 70ns (nanoseconds). DRAM Timing must be set to match the speed of the slowest SIMM in your memory slots.

Default: 70ns.

### External Cache

Allows you to enable/disable the L2 (Level 2) External Cache feature. If the special Level 2 cache SIMM is present, it offers an ultrafast, 12- to 15-nanosecond buffer between your CPU and regular (50-70ns) system RAM. Normally L2 cache speeds up your system, but because some software has problems with L2 caching, you may (rarely) need to disable the External Cache.

Default: *Enabled*.

### Cache Memory Regions

Allows you to choose which specific shadowed BIOS memory regions (in addition to System code and Video code) will be cached. Regions are identified by hexadecimal (base 16) addresses.

Default: All specific regions *Disabled*.

## **Memory Shadow**

BIOS shadowing copies data from portions of the computer's slower ROM (Read-Only Memory) chips into much faster DRAM (system RAM) chips in system memory. This data can then be read more quickly by the CPU, so system performance improves. The Memory Shadow subsection lets you make certain regions of your upper memory (other than that reserved for basic system and video) available for BIOS shadowing.

### **System Shadow**

This setting is not adjustable. System shadow is always *Enabled*.

### **Video Shadow**

Enables/disables copying of the video BIOS into RAM. Shadowing the video BIOS code improves video performance.

Default: *Enabled*.

### **Shadow Memory Regions**

Allows additional specific memory regions (other than System and Video) to be shadowed in upper RAM memory. When enabled, any ROM data located in the specified region will be copied to shadow RAM when you boot up. Regions are identified by hexadecimal (base 16) addresses.

Default: All specific regions *Disabled*.

### **Boot Sequence**

Determines what drive the system checks first for an operating system.

Choices are *A: then C:*, *C: then A:*, and *C: only*.

Default: *A: then C:*.

## Advanced Menu

### Warning!

*Setting these items incorrectly could cause your system to malfunction. Never needlessly change from the defaults.*

The Advanced Menu offers the following options:

### Large Disk Access Mode

Lets you set your system to expect a large DOS hard disk, or some Other type of hard disk, such as expected by UNIX or Novell Netware.

Default: DOS.

### OS support for more than 64MB

This option allows support for more than 64MB of memory with operating systems other than DOS, such as OS/2 and Windows NT. On systems with more than 64MB of memory, set to disable for DOS and Windows, Enable for OS/2 and Windows NT.

Default: Disabled.

### Plug & Play O/S

Enables/disables peripheral add-on features for computers with Plug & Play operating systems.

Default: No.

### Integrated Peripherals

Lets you configure your serial and parallel ports, as well as your onboard floppy disk controller, your onboard IDE controller, your audio device (if present), and your PC's speaker volume. The following list describes each of these parameters.

(more settings, next page)

Advanced Menu (continued)

### **1st COM Port**

When 1st COM Port (COM A) is set to *Auto*, the system will automatically set the interrupt and IRQ for that port. Otherwise this option allows you to choose (from a list) the interrupt and I/O address of the 9-pin serial port.

Default: Auto.

### **2nd COM Port**

When 2nd COM Port (COM B) is set to *Auto*, the system will automatically set the interrupt and IRQ for that port. Otherwise this option allows you to choose (from a list) the interrupt and I/O address of the 25-pin serial port.

Default: Auto.

### **LPT Port**

Sets the parallel port designation. This allows you to specify the parallel port address and IRQ, which otherwise are factory set.

Default: Auto.

### **LPT Mode**

Allows you to set the parallel port communication mode to match the capabilities of your parallel port device. Settings: Unidirectional, Bidirectional or Enhanced.

Default: Unidirectional.

### **Floppy Disk Controller**

Configures the onboard floppy disk controller to Primary, Secondary, or Disabled.

Default: Primary.

### **IDE Controller**

Enables/disables the onboard IDE controller, which controls up to four PCI local bus devices.

Default: Enabled.

### **PC Speaker volume**

Sets PC speaker to low, medium or high volume, or disables it.

Default: Medium.



## **PCI Devices**

The PCI (Peripheral Component Interconnect) Devices subsection allows you to enable or disable the integrated SCSI and LAN options.

### **Enable Onboard SCSI**

Enables/disables the built-in SCSI port, if present.

Default: set at factory.

### **Onboard Ethernet**

Enables/disables the onboard AMD Ethernet controller, if present.

Default: set at factory.

## Security Options

The Security Menu allows you to password-protect system access, a way of safeguarding information. When passwords are enabled, users must type the proper password to access the protected part of the system.

*Note: 1. It's easy to forget a password, so we strongly recommend writing down your passwords and storing them in a secure place.*

*2. If you type the User password on entering SETUP, you cannot change the Supervisor Password or Diskette Access settings.*

### **Warning!**

*If you forget the password, your system will not operate. You will have to completely clear the CMOS memory and reenter your entire system configuration. Write down your password and store it in a safe place.*

The following security items are available:

- Set Supervisor Password
- Set User Password
- Password on Boot
- Diskette Access
- Fixed disk boot sector
- System Backup Reminder
- Virus Check Reminder

### **Supervisor Password is**

Allows you to enter a system supervisor password. This password controls access to all features of your system.

### **User Password is**

Accessible only after Supervisor Password is enabled, this allows you to enter a system user password. You can't use the User Password to alter the Supervisor Password in SETUP.

## **Password on boot**

When enabled, the system asks you for a password on boot. The system will boot only after the correct supervisor or user password is entered.

Default: *Disabled*.

## **Diskette access**

Active only when a Supervisor password is enabled, this specifies which level of password (Supervisor or User) is required on bootup to use the floppy disk drives. This can prevent unauthorized transfer of data.

Default: *Supervisor*.

*Note: All diskette drive access can be denied (including system diskettes) by 1) setting a Supervisor password, 2) setting Password on Boot to Disabled, then 3) setting Diskette Access to Supervisor.*

## **Fixed disk boot sector**

When enabled, write protects the boot sector on your hard drive to protect against viruses.

Default: *Disabled*.

## **System backup reminder**

When enabled, this periodically displays a boot reminder message to back up your system. Options: Daily, Weekly, Monthly, Disabled.

Default: *Disabled*.

## **Virus check reminder**

When enabled, this periodically displays a boot reminder message to scan for viruses. Options: Daily, Weekly, Monthly, Disabled.

Default: *Disabled*.

## Power Options

SETUP's Power menu lets you tell your system to enter a low-power *Standby* mode when it is idle for a specified time. Standby minimizes your system's energy consumption while allowing you to resume work within moments.

### Power Savings (DOS and Windows)

Lets you choose when to activate power conservation for your system. The way you enable Power Savings differs between DOS and Windows, but both methods reduce power consumption when they kick in (30 Watts or less in *Standby* mode). With the power management feature activated, the system will automatically "go to sleep" after the specified period of user inactivity, while operating under DOS.

To activate power savings in DOS, go to SETUP during bootup by pressing the F2 key, then under the Power menu choose *Maximum*, *Medium*, *Minimum*, or *Disabled*. This allows you to choose one of three preset configurations, or to disable power savings altogether.

- *Maximum* enters Standby mode after 5 minutes
- *Medium* enters Standby mode after 10 minutes
- *Minimum* enters Standby mode after 20 minutes
- *Disabled* prevents power conservation in DOS

*Note: In DOS, the system will not go to sleep unless the EMM386 program in Config.sys is either removed or "REM'd" out.*

In Windows, activating power conservation is simpler. Launch the Control Panel utility from the Main program group. Then enter the "Desktop" dialog and select the ZEOS screen saver. Now you can select the timeout period, down to a minimum of one minute. That's all there is to it.

When the system enters *Standby* mode, the screen will go dark, the CPU processing speed will be diminished, and a command will be given to the hard disk drive to stop spinning. Normally the hard drive shuts down about 5 minutes after the rest of the system, due to a built-in delay.

In *Standby* mode, power consumption will be 30 Watts or less.

*Note: Power Savings in Windows will not be active unless you select the ZEOS screen saver.*

## Exit Menu Options

Offers Exit and Save options for the SETUP program.

# 4. Expanding Your System

## Adding an Expansion Board

The five ISA and three PCI expansion slots on your mainboard are designed to accept a wide variety of add-on cards (many available from ZEOS). Scanners, tape backup units, video capture devices, and many other devices come on expansion cards, which communicate with the CPU via standard expansion slots. Often, adding these components is as easy as opening the case, slipping the new card into an empty slot, then connecting the external component (if there is one) to the card.

To add an expansion board:

1. Turn off the monitor and system unit power, then unplug the AC power cords from the wall outlet.
2. Open the system unit case (see *How to Open a Desktop Case*, earlier).
3. Find an empty expansion slot or, if you are replacing an expansion card already in your system (such as when upgrading your video card), locate the old card.
4. Unscrew the mounting screw and remove the blank bracket by sliding it up. If you are removing an old expansion card, carefully lift it straight up (sometimes you have to wiggle it a little).
5. Set any jumpers or switches on the new card. See the card's documentation for the correct jumper settings.
6. Slide the new card into the slot. Press down firmly, so the edge connector slides completely into the slot.
7. Tighten the mounting screw.

(more steps, next page)

## How to Add an Expansion Board (continued)

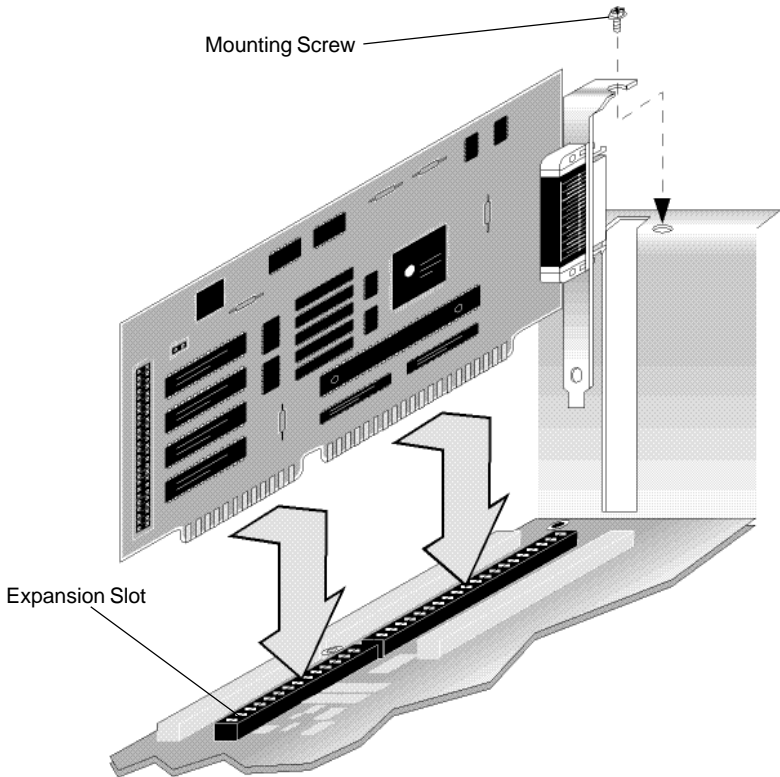

8. Connect any internal cables to the expansion card.
9. Close the computer case, and turn on the power.

Many expansion cards require you to run diagnostic or installation software before the new board will work properly. Your expansion card's installation manual should have detailed instructions.

## **How Disk Drives Work**

There are three main types of disks for storing files - floppy, hard, and compact disks.

Floppy disks are small, relatively slow, portable disks. Most people use floppy disks to transfer files or install new programs onto their hard drives. Floppy disks fit into the floppy disk drives mounted in your system unit. Although there are some combination drives, most floppy disk drives are designed to hold only one size of disk.

Hard, or fixed disks, are permanently mounted inside your system unit case. They are very fast, hold a lot of files, and are not removable without disassembling your system.

Compact disks fit into CD-ROM drives. Compact disks can store very large amounts of information.

Floppy, hard, and CD-ROM disk drives all fit into the drive bays in your system unit. This chapter shows how some of the most common drives connect to the mainboard. Most drives have two connections - a power connection and a data connection. For detailed installation and configuration information, always check the disk drive's documentation.



## How a Floppy Drive Works

Floppy drives have two primary connectors, a ribbon cable called the data cable, and a power connection to the power supply. The ribbon cable connects the back of the floppy drive with the floppy controller port J5 on the mainboard. Data ribbon cables often have two connectors. If you have more than one floppy drive on your system, they often share the same ribbon cable.

The data cable also has a red stripe. Whenever connecting or disconnecting the ribbon cable, be sure to attach the cable connectors so the red stripe is pointing toward pin 1 of the connector. Pin 1 is often labelled with a small triangle or filled in corner.

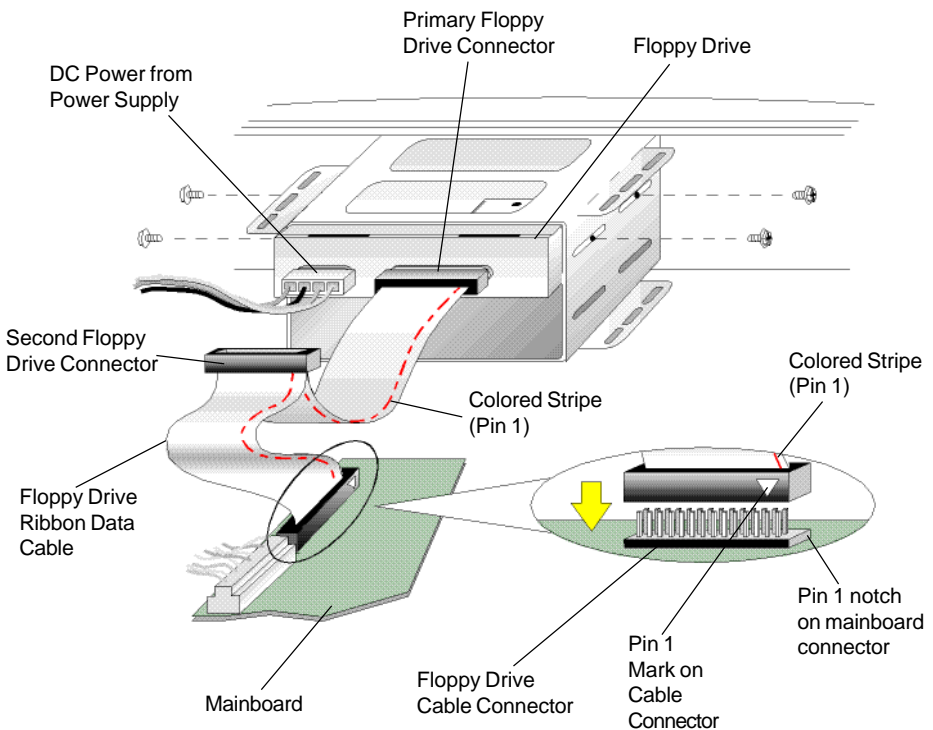

## How an IDE Hard Drive Works

IDE (Integrated Drive Electronics) hard drives are the most common hard drives and are the most likely to be installed on your system. IDE devices have most of the electronics or “smarts” built into the drive, rather than installed on a separate controller card or on the motherboard. IDE hard drives have two main connections – a ribbon cable called the data cable and a power connection to the power supply. The ribbon cable attaches to the back of the drive and connects to the IDE controller port J7 or J8 on the mainboard. Whenever connecting or disconnecting the ribbon cable, be sure to attach the data cable so the red stripe points toward pin 1 on the connector.

Most drives also have configuration jumpers at the back of the drive for setting drive identification and resistors. See your hard drive user’s guide for complete information.

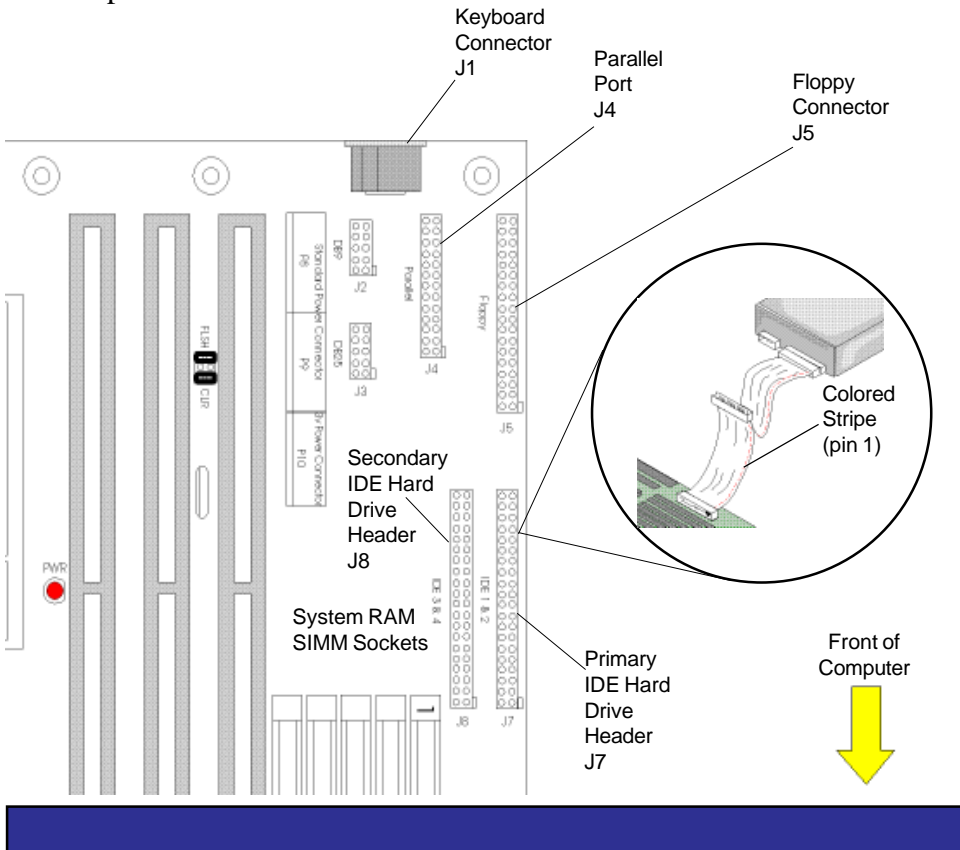

## How a CD-ROM Drive Works

CD-ROM drives read information from compact discs, or CDs. The “ROM” in CD-ROM stands for Read Only Memory. Compact discs are *read-only*--you can read information from them, but cannot add new files or information onto them as you can do with a floppy disk or hard disk. Despite their limitations, CDs have some distinct advantages. CDs can store large amounts of information--one compact disk can store as much information as 500 floppy disks. With the right software, you can even listen to music on your CD-ROM drive.

There are many types of CD-ROM drives. Most have three primary connectors, a power connector, a data cable connector, and an audio connector.

The power connector is just like the DC power connector on floppy drives and hard disk drives. It accepts DC power from the computer’s internal power supply.

The data cable is a flat ribbon cable that connects the drive with some type of controller. Some drives use a dedicated controller card inserted into one of the expansion slots on the mainboard. Your IDE CD-ROM drive connects to the 16-bit IDE controller port on the mainboard (J8) or to an IDE controller card inserted into one of the expansion slots. Still other drives use a CD-ROM controller port mounted on a sound card in one of the expansion slots.

Most CD-ROM drives also have an audio connector where you can connect headphones or computer speakers. If your system has a sound card and speakers installed, the CD-ROM drive’s audio connector probably can be connected to the sound card.

For detailed information about your CD-ROM drive, check the manufacturer’s documentation.

## Adding System RAM

System memory is often called RAM or Random Access Memory. RAM is the “thinking space” available to your applications. Usually, the more system RAM you have, the faster your system will run. Many software applications simply run much faster and more efficiently when more RAM is available.

You add RAM by inserting Single In-line Memory Modules (SIMMs) into SIMM sockets on the mainboard. Your computer’s mainboard will hold up to six SIMMs of 32-bit RAM. Slots must be filled in sequence from 0A to 2B. You must have identical pairs of SIMMs in each bank, but different banks can support various capacities and speeds. The mainboard will support up to 384Mb of RAM.

*Note: SIMMs MUST ALWAYS BE INSTALLED IN SEQUENCE FROM BANK 0A TO BANK 2B, AND WITHIN THE SAME BANK, THEY MUST BE THE SAME SPEEDS AND CAPACITIES.*

RAM Configurations		
Memory Size	SIMMs Used	Memory Scheme
2MB	two 1MB	Page
4MB	two 2MB	Page/Interleaved
8MB	two 4MB	Page/Interleaved
10MB	two 4MB, two 1MB	Page/Interleaved
12MB	six 2MB	Page/Interleaved
16MB	four 4MB	Page/Interleaved
24MB	six 4MB	Page/Interleaved
32MB	four 8MB	Page/Interleaved
64MB	four 16MB	Page/Interleaved
128MB	four 32MB	Page/Interleaved
256MB	four 64MB	Page/Interleaved
384MB	six 64MB	Page/Interleaved

*Note: This is just a small sample of possible RAM configurations.*

## Installing SIMMs

When installing SIMMs, use 70ns or faster memory chips for maximum system performance. Different speed SIMMs may be mixed, but only if you put them different banks. In addition, always set the CPU/DRAM Speed option in SETUP to match the slowest SIMM. Note that with SIMMs, larger numbers mean that more time is used to access information (a 70ns SIMM is slower than a 60ns SIMM). For best results, use SIMMs from the same manufacturer.

### Caution:

*Static electric shocks can permanently damage your equipment. Always ground yourself by touching the metal part of the computer case before beginning the following procedure. We strongly recommend using an antistatic wrist strap attached to the case ground.*

To Install SIMMs:

1. Remove system cover (see *How to Open a Desktop Case*, earlier).
2. Remove any SIMMs you are replacing with new SIMMs by gently pulling the metal socket clips away from the SIMM to release the SIMM from the socket. Hold them out while you are tilting the SIMM away from the metal clips. Carefully lift the SIMM up and out.

### Caution:

*Never use force to remove the module out of the socket. Failure to properly release the retainer clips may break the socket, causing expensive damage which is not covered by your warranty.*

3. Grasping a new SIMM by the edge, remove it from the antistatic bag.
4. Insert the bottom edge into the socket slot. Press down firmly on the SIMM while maintaining the proper angle of insertion.

(more steps, next page)

## Installing SIMMs (continued)

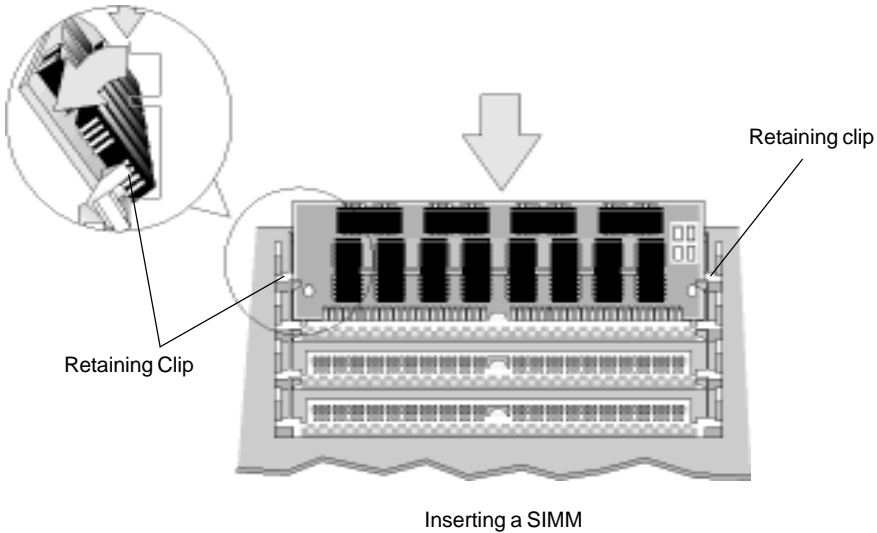

5. Ensure the SIMM seats correctly. If not, remove and repeat Step 4.
6. Gently push the top edge toward the retainer clips until the clips snap into place.
7. Reinstall system cover.

After completing the installation, your ROM BIOS will determine the amount of memory installed; however you may need to change the CPU/DRAM Speed option in your system SETUP program. Refer to *Using SETUP* earlier for detailed instructions.

## Adding System Cache Memory

Secondary cache memory can speed up memory intensive applications and greatly enhance your CPU's performance.

You add cache memory by adding a single in-line memory module (SIMM) into the secondary system cache SIMM socket on the mainboard. Your system mainboard will hold one cache SIMM of 64-bit, 12- to 15-nanosecond memory.

### Caution:

*You must use a 3-volt SIMM when you add cache memory. If you aren't sure, contact ZEOS Technical Support before purchasing or installing a cache SIMM.*

*Note: System cache SIMMs are not the same as RAM memory SIMMs. Do not try to install cache SIMMs in your RAM memory sockets, or RAM SIMMs in your cache SIMM socket.*

Although installing secondary cache memory is easy and straightforward, a few simple precautions will ease the installation. Before you begin, make note of your system's current SETUP parameters. You can access the SETUP screen by pressing **F2** at boot. Copy the SETUP parameters to a piece of paper.

Also, all SIMMs are extremely sensitive to static electricity. Be sure to use an antistatic wrist band and ground yourself by touching the computer case before you touch the mainboard or handle any chips.

To install secondary cache memory:

1. Turn off the system power and unplug the AC power cord. Remove system cover (see *Opening the Case*, earlier).
2. Locate the secondary system cache memory SIMM socket. The figure above shows where to find the socket on the mainboard.
3. If you are upgrading your system cache memory, remove the SIMM you are replacing by gently pulling the SIMM out of the socket.
4. Grasping a new SIMM by the edge, remove it from the antistatic bag and press it into the socket.

**Caution:**

*Static RAM is extremely sensitive to static electricity. These shocks can permanently damage your equipment. Use an antistatic wrist strap attached to cabinet ground. Be sure to ground yourself by touching the system cabinet before beginning this procedure.*

5. Reinstall system cover, plug in AC power, and turn on the computer as you normally would.
6. Make sure the External Cache option on the Memory Control Menu of the Advanced System Setup Menu is Enabled. Also check your system SETUP to be sure it hasn't changed. If any settings have changed, reenter the correct values and reboot the system.

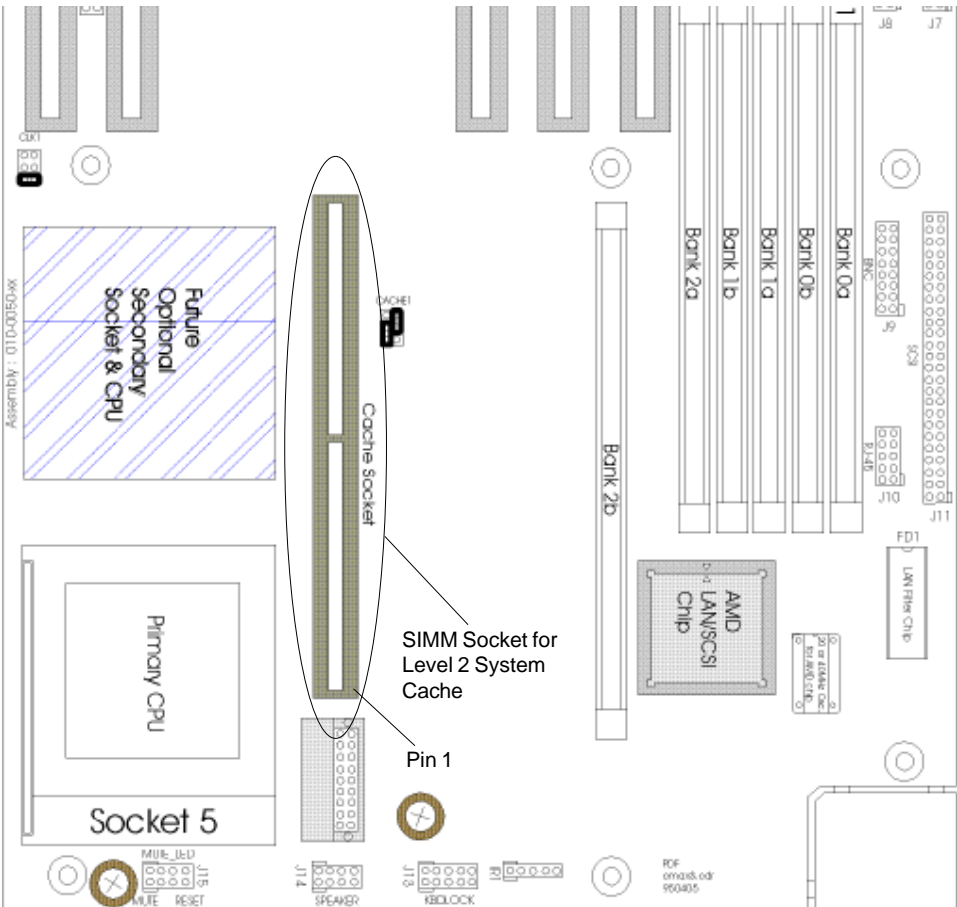



## Installing a New CPU

### Caution:

*Static electricity can permanently destroy your CPU. Always ground yourself by touching the system cabinet before beginning the following procedure. We strongly recommend using an antistatic wrist strap attached to cabinet ground.*

To install a new CPU:

1. Open the case and locate the CPU socket on the mainboard. If you need help see *How to Open a Desktop Case and Mainboard Diagram*, earlier.
2. Lift up the ZIF (Zero Insertion Force) socket arm to the open position. This will loosen the pressure on the pins of the old CPU chip. Carefully lift the old CPU and heat sink out of the socket.
3. Important: You must align the new CPU over the socket on the board ***exactly like the old CPU***. **Make absolutely sure the Pin-1 notch on the CPU chip aligns with Pin-1 on the ZIF socket.**
4. Place the new CPU into the socket and press gently. Be careful not to bend any pins on the CPU. Once the CPU is firmly seated in the socket, carefully lower the ZIF arm back down to the closed position.
5. Attach the heat sink to the new CPU. If your new CPU is exactly the same size as your old CPU, you can reuse your old heat sink. If your new CPU is not the same size as your old one, you must use the heat sink supplied with your new CPU. If your heat sink is a peel and stick type, peel off the adhesive layer and stick the heat sink onto the new CPU. If your heat sink uses a retaining clip, place the heat sink on the chip, then slide the retaining clip over the heat sink until it snaps onto the sides of the CPU.

(more steps, next page)

6. Set the CLK jumper to match the speed of your new CPU. If you need help with this jumper, see *Mainboard Jumpers Diagram*, earlier.
7. Close case and boot as you normally would.

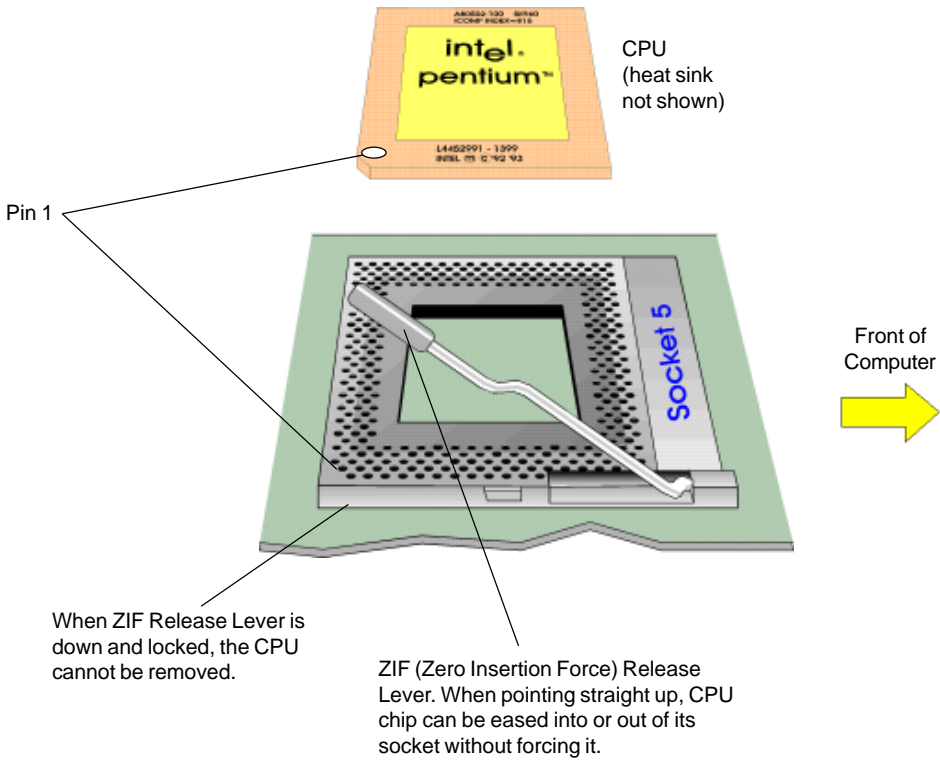

# 5. Mainboard Specifications

CPU	Intel Pentium (P54C)
Power Consumption	Approx. 25Watts (varies with CPU, memory)
Clock Speeds	75, 90, 100, 120, or 133MHz
Chipset	Intel "Neptune" chipset
ISA bus speed	8.25 MHz for 33MHz systems 8.33 MHz for 25MHz systems
PCI local bus speed	up to 133 MB/s (33MHz) up to 100 MB/s (25MHz)
Memory Types	1, 2, 4, 16, 32MB x36 or x32 SIMMs
Memory Speeds	50, 60, 70ns
Memory Configurations	See table, page 52
Data path	8, 16, 32, 64-bits
Expansion slots (8)	Five 16-bit ISA Three 32-bit PCI local bus
Secondary Cache Mapping	Direct-mapped
Secondary Cache Write policy	Write-back
Secondary Cache Capacity	0KB (standard), 256KB, or 512KB
Secondary Cache Type	One 256KB or 512KB SIMM
Secondary Cache Speed	12 or 15-nanosecond

## Mainboard Environmental Specifications

Operating Temperature	0°C to 40°C
Storage Temperature	-20°C to 60°C
Operating Humidity	Up to 100% non-condensing

## 9-Pin Serial Port (J2) Pin Assignment

Header Pin Number	DB9 Connector Pin Number	Signal
1	1	DCD, Data Carrier Detect
2	6	DSR, Data Set Ready
3	2	RXD, Receive Data
4	7	RTS, Request to Send
5	3	TXD, Transmit Data
6	8	CTS, Clear To Send
7	4	DTR, Data Terminal Ready
8	9	RI, Ring Indicator
9	5	GND, Ground

## 25-Pin Serial Port (J3) Pin Assignment

Header Pin Number	DB25 Connector Pin Number	Signal
1	8	DCD, Data Carrier Detect
2	3	RXD, Receive Data
3	2	TXD, Transmit Data
4	20	DTR, Data Terminal Ready
5	7	GND, Ground
6	6	DSR, Data Set Ready
7	4	RTS, Request to Send
8	5	CTS, Clear to Send
9	22	RI, Ring Indicator

## 9-Pin Serial Port (J2) Pin Assignment

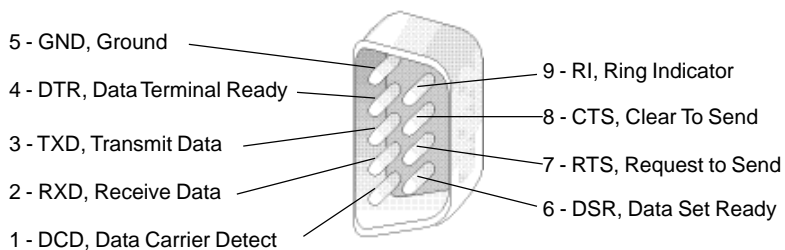

## 25-Pin Serial Port (J3) Pin Assignment

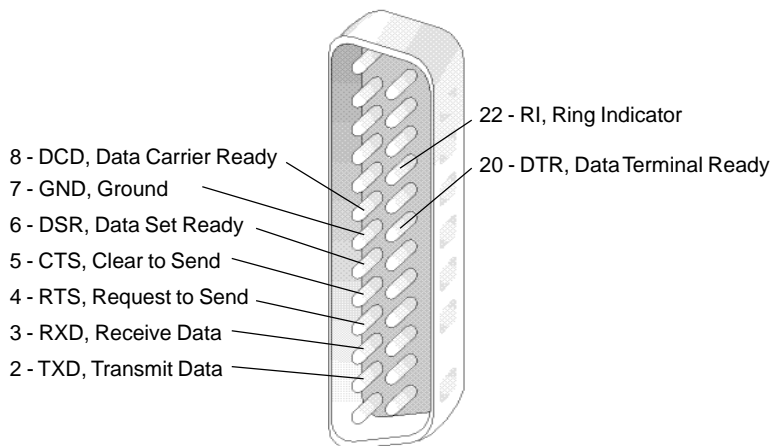

## Parallel Port (J4) Pin Assignment

Header Pin Number	Parallel Port Connector Pin Number	Signal
1	1	STB, Strobe
3	2	PD0, Data Bit 0
5	3	PD1, Data Bit 1
7	4	PD2, Data Bit 2
9	5	PD3, Data Bit 3
11	6	PD4, Data Bit 4
13	7	PD5, Data Bit 5
15	8	PD6, Data Bit 6
17	9	PD7, Data Bit 7
19	10	ACK, Acknowledge
21	11	Busy, Busy
23	12	PE, Paper Empty
25	13	SLCT, Select
2	14	AFD, Auto Feed
4	15	ERR, Error
6	16	INIT, Initialize
8	17	SLIN, Select Input
10	18	GND, Ground
12	19	GND, Ground
14	20	GND, Ground
16	21	GND, Ground
18	22	GND, Ground
20	23	GND, Ground
22	24	GND, Ground
24	25	GND, Ground

## Parallel Port (J4) Pin Assignment

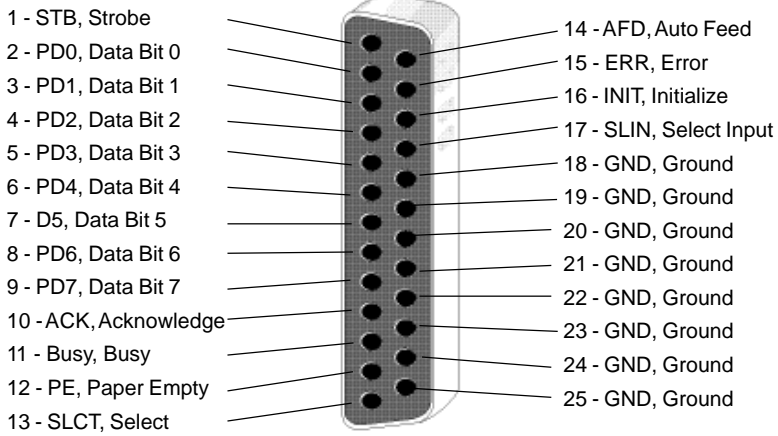

# Handy Cheat Sheet

Here are some of the most often needed or forgotten notes.

**CTRL-ALT-DEL** ..... Warm Reboot  
**Reset** button, or  
**Power** button ..... Cold Reboot  
**F2** during power up ..... Access SETUP  
**CTRL-BREAK**, or  
**CTRL-C** ..... Pause or Break an application or batch file

## DOS Commands

**COPY** [filename] [drive:][path][newfilename] ..... copies a file  
**FORMAT** [drive:] ..... erases and formats a disk  
**DIR** [drive:][path] ..... lists the files in a certain drive and directory  
**DEL** [filename] ..... deletes a file  
**MD**[newdirectory] ..... makes a new directory  
**RD**[directoryname] ..... removes and erases an empty, old directory  
**RENAME** [oldfilename][newfilename] ..... renames a file  
**CHKDSK** [drive:] ..... displays a status report for a disk  
**CD**[path] ..... changes to a different directory  
**CLS** ..... clears the screen

## Common DOS file extensions

**.BAK** backup file  
**.BAT** ..... batch file  
**.COM** ..... command program file  
**.EXE** ..... executable program file  
**.SYS** ..... system file  
**.INI** ..... Windows initialization file  
**.PIF** ..... Windows program information file

**README** files ..... text files with special instructions



# Handy Cheat Sheet

## Windows Shortcuts

Ctrl-C ..... copy to clipboard  
Ctrl-V ..... paste or copy from the clipboard  
Ctrl-X ..... delete and copy to clipboard  
Alt-Tab ..... toggle between open applications  
Alt-Esc ..... jump to next open application

**Wildcards** - wildcards are special characters that can represent any other valid numbers, letters, or symbols in a file name.



The asterisk represents any number of other characters.  
For example:

\*.BAK would represent any file with the extension BAK.

GONOW.\* would represent all files named GONOW with any extension.



The question mark represents one single character.  
For example:

GONOW.?XE would represent any file named GONOW with an extension ending in XE.

?ONOW.EX? would represent any five character filename ending in ONOW with EX as the first two characters of its extension.

# Glossary

*This glossary provides general definitions of key terms. For an expanded list look in standard reference books on computers.*

**Address** - A number or expression representing the physical location of a device or a piece of data.

**Application Program** - A word processor, spreadsheet, desktop publisher or other program that allows interaction with the user.

**AUTOEXEC.BAT File** - An MS-DOS batch file containing commands which execute automatically when you turn on your computer.

**Batch File** - A file containing several commands that execute in sequence as a group, or batch. MS-DOS batch files must have a filename extension of .BAT.

**Boot** - Short for Bootstrap. Transfer of a disk operating system program from storage on floppy disk or hard disk drive to computer's working memory.

**Boot Disk** - A disk with an operating system installed which loads the system on power up.

**Character** - Anything that can print in a single space on the page or the screen. Includes numbers, letters, punctuation marks, and graphic symbols.

**Command Processor** - The part of an operating system that processes commands entered by you. The command processor in MS-DOS is contained in the COMMAND.COM file.

**CPU** - Central Processing Unit. The piece of hardware which interprets instructions, performs the tasks you indicate, keeps track of stored data, and controls all input and output operations.

**Crash** - A malfunction in the computer hardware or software, usually causing loss of data.

**Cursor** - The arrow, vertical I-beam or other screen object that shows where you can click to select something onscreen. See Insertion point.

**Diagnostics** - The tests and procedures the computer performs to check its internal circuitry and set up its configuration. See POST.

**DIP Switches** - Small switches on a piece of hardware such as a CPU, a printer, or an option card. DIP switch settings control various functions and provide a system with information about itself. DIP stands for Dual In-Line Package.

**Directory** - A list of the files stored on a disk or a part of a disk. Often depicted onscreen by a small folder.

**Disk Drive** - The physical device which allows the computer to read from and write to a disk. A floppy disk drive has a disk slot into which you insert floppy disks. A hard disk drive is permanently fixed inside the system unit.

**DMA** - Direct Memory Access. Process where a hard drive, LAN adapter or other device transfers data directly to/from system RAM, bypassing the CPU.

**DOS** - Disk Operating System. A computer program which continuously runs and mediates between the computer user and the Application Program, and allows access to disk data by disk filenames. The Disk Operating System controls the computer's input and output functions. See Operating System.

**File** - A group of related pieces of information called records, or entries, stored together on disk. Text files consist of words and sentences. Program files consist of codes and are used by computers to interpret and carry out instructions.

**Floppy disk** - a flat piece of flexible plastic coated with magnetic material and used to store data permanently.

**Format** - To prepare a new disk (or erase an old one) so it can receive information. Formatting a disk divides it into tracks and sectors which create addressable locations on it.

**Hard Disk Drive** - Commonly called rigid disk drives, or fixed disk drives. Unlike floppy disks, hard disks are fixed in place inside the system unit. They can process data faster and store many more files than floppy disks.

**Hardware** - Any physical component of a computer system, such as a monitor, printer, keyboard, or CPU.

**IDE** - Integrated Drive Electronics. An IDE drive has the controller electronics built into the drive itself and is connected directly to the mainboard or to an adapter card.

**Insertion Point** - A blinking vertical marker which shows where you can type words or numbers. Sometimes called Text Cursor. See Cursor.

**Jumper** - A small electrical connector that alters some of the computer's functions. Short (makes a connection) or Non-Short (no connection).

# Glossary

**Kilobyte (KB)** - A unit used to measure storage space (in a computer's memory or on a disk). One kilobyte equals 1024 bytes.

**LED** - Light Emitting Diode. A diode that illuminates when electricity passes through it, like the indicator lights on the front panel of the computer.

**Local Bus** - A set of addresses, data, and control signals that interface directly with the host CPU.

**Mainboard** - also *Motherboard*. A printed circuit board into which other circuit boards can be plugged. Usually, it contains the CPU, connectors for memory (SIMMs), secondary cache, adapter sockets and expansion slots for add-on devices.

**Memory** - Computer chips that make data quickly available to the CPU. They can store data permanently (ROM) or temporarily (RAM).

**MHz** - 1 Megahertz = one million (*Mega*) cycles per second (*Hertz*).

**Operating System** - A body of programs, such as MS-DOS, that coordinate the activities of a computer. It determines how programs run and supervises all input and output.

**PCI** - Peripheral Component Interconnect. PCI is an industry standard for local bus peripheral expansion. **Parallel Port** - also *Printer Port*. A 25-pin Input/Output connector usually used for printers.

**Peripheral** - A device (such as, a printer or a modem) connected to a computer that depends on the computer for its operation.

**Port** - A physical input/output socket on a computer where you can connect a peripheral.

**POST** - Power-On Self Test. An initial diagnostic test a computer performs to check its hardware.

**RAM** - also *DRAM*. Random Access Memory. Small chips or modules that provide the CPU rapid access to data. Software programs and files reside in RAM while being used. RAM is called *volatile* memory because it "evaporates" when you turn off the power.

**Read** - To copy data from one area to another. For example, when you open a text file stored on disk, the computer reads the data from the disk and displays it on the screen.

**Reset** - To reload a computer's operating system so you can retry a task or begin using a different operating system. Resetting clears RAM.

**ROM** - Read Only Memory. A portion of memory that can only be read and cannot be used for temporary storage. ROM retains its contents even when you turn off the power.

**SETUP** - This refers (usually) to the program that is used to load the CMOS data base with input from the user. SETUP sets the date, time, and configuration of disk drives installed on the system.

**Software** - The programs that enable your computer to perform the tasks and functions you indicate. Application programs are software.

**SRAM** - Static RAM. Memory chips that do not require refresh circuitry, as do conventional RAM chips. SRAMs operate in the 10-30 nanosecond range, which is faster than RAM chips. SRAM is often used as a buffer between fast CPUs and RAM.

**Subdirectory** - A directory within another directory.

**System Disk** - A disk that contains the operating system. A Boot Disk.

**Write** - To store data on a disk.

**Write-Protect** - To prevent a floppy disk from being overwritten by placing a write-protect tab over the notch on the side of the floppy disk (5.25") or setting the write-protect switch (3.5"). When a floppy disk is write-protected, you cannot erase, change, or record over its contents.

# Index

## A

- Adding an Expansion Board 46
- Adding System Cache Memory 55
- Adding System RAM 52
- Advanced Menu 38
- Asynchronous Cache Module 31
- Autotype Fixed Disk 35

## B

- Boot Sequence 37
- Burst Cache Module 31

## C

- Cache Memory
  - Adding 55
  - Location 56
  - Regions 36
- CD-ROM Drive 51
- Com Port A: in SETUP 39
- Com Port B: in SETUP 39
- CPU
  - Inserting into ZIF Socket 57
  - Installing 57
  - Location 26
- CPU Pipelining 31
- Customer Assurance Program 8

## D

- Daylight Savings 34
- Desktop System
  - Diagram 10
  - How to Open 14
  - Internal Diagram 18
- Disk Drives 48
- Diskette Access 43
- Diskette Drive A: in SETUP 34
- Diskette Drive B: in SETUP 34
- DRAM Timing 36

## E

- Enable On-board SCSI 41
- Expansion Board
  - Adding 46
- Expansion Slots
  - Location 26
- External (Level 2) Cache 36

## F

- Fixed Disk Boot Sector 43
- Floppy Disk Controller 40
- Floppy Drive 49

## H

- Hard Drive 50

## I

- IDE Adapters 34
- IDE Controller 40
- Installing a New CPU 57
- Installing SIMMs 53
- Integrated Peripherals 38

## J

- Jumpers
  - CLK1 31
  - CLR 30
  - FLSH 30
  - Settings 29

## L

- Large Disk Access Mode 38
- Large Disk DOS Compatibility 38
- LBA Mode Control 35
- LPT Mode 40
- LPT Port 39

# Index

## M

- Mainboard
  - Diagram 26
  - Environmental Specifications 59
  - Jumper Functions 30
  - Jumpers Diagram 28
  - Specifications 59

## Memory

- Control 36
- Shadow 37

Mode, in SETUP 40

Multi-Sector Transfer 35

## O

On-board Ethernet 41

OS Support for More than 64MB 38

## P

### Parallel Port

- Features 24
- in SETUP 39

Password 42

Password on Boot 43

PC Speaker Volume 40

### PCI

- Devices 41
- Local Bus 21
- SCSI/ Ethernet Port 25

Pinouts, Serial and Parallel 60

Plug & Play O/S 38

Power Savings 44

## R

### RAM

- Adding 52

## S

SCSI Port Features 25

Secondary Cache Subsystem 21

Security 42

Serial Port Features 23

SETUP 32

Shadow Memory Regions 37

### SIMMs

- Adding 53

### System

- Backup Reminder 43
- Date 34
- Shadow 37
- Time 34

### System Memory

- Adding 52

## T

### Tower System

- Diagram 12
- How to Open 16
- Internal Diagram 19

## U

User Password 42

## V

Video Shadow 37

Virus Check Reminder 43

## W

Write Precomp 35

# Late Changes

The following changes arrived too late for printing :

p.1: new ZEOS logo.

p.4-6: updated TOC.

p.11: video connector location moved.

p.13: video connector location moved.

p.15: video connector location moved.

p.17: video connector location moved.

p.18: updated mainboard diagram.

p.19: updated mainboard diagram.

p.22: removed Business Audio reference.

p.25: removed Business Audio reference.

p.29: updated FLSH/CLR jumper settings.

p.30: new procedure to clear BIOS settings stored in CMOS.

p.40: removed reference to "Audio Device" (Business Audio).

p.49: moved Pin1 marker on floppy drive connector.

p.56: updated mainboard diagram.

p.58: updated CPU graphic.

p.68-9: updated index.