



Tiger LE

S2515

Motherboard User's Manual

Revision 1.01

Copyright © Tyan Computer Corporation, 2001. All rights reserved. No part of this manual may be reproduced or translated without prior written consent from Tyan Computer Corp.

All registered and unregistered trademarks and company names contained in this manual are property of their respective owners including, but not limited to the following.

Tiger LE S2515 is a trademark of Tyan Computer Corporation.

AMIBIOS is a trademark of American Megatrends, Inc.

Windows is a trademark of Microsoft Corporation.

Red Hat is a trademark of Red Hat, Inc.

IBM, PC, AT, PS/2 are trademarks of IBM Corporation.

Intel, Pentium III are trademarks of Intel Corporation.

ServerWorks and ServerSet are trademarks of ServerWorks, Inc.

Promise, FastTrack 100, FastBuild are trademarks of Promise Technology, Inc.

Information contained in this document is furnished by Tyan Computer Corporation and has been reviewed for accuracy and reliability prior to printing. Tyan assumes no liability whatsoever, and disclaims any express or implied warranty, relating to sale and/or use of Tyan products including liability or warranties relating to fitness for a particular purpose or merchantability. Tyan retains the right to make changes to product descriptions and/or specifications at any time, without notice. In no event will Tyan be held liable for any direct or indirect, incidental or consequential damage, loss of use, loss of data or other malady resulting from errors or inaccuracies of information contained in this document.

Table of Contents

Chapter 1: Introduction	Page 4
1.1 Overview	4
1.2 Hardware Specifications	5
1.3 Software Specifications	6
1.4 Technical Support	7
1.5 Returning Merchandise for Service	7
Chapter 2: Board Installation	8
2.1 Unpacking	8
2.2 Installation	8
2.3 How to install our products right... the first time	8
2.4 Quick Reference for Jumpers	10
2.5 Map of Motherboard Jumpers	11
2.6 Map of Motherboard Features	12
2.7 Setting Jumpers	13
2.7-A Front Panel Connector	13
2.7-B CMOS Reset	13
2.7-C CPU Front Side Bus Select	13
2.7-D PCI Speed Configuration	13
2.7-E Server Management Connector	14
2.7-F Chassis Intrusion Alarm Connector	14
2.7-G Speaker Connector	14
2.7-H Serial Port 2 Connector	14
2.7-I FAN Connectors	14
2.7-J CPU Multiplier Settings	14
2.7-K LAN Link External LED	15
2.7-L Soft Power Connector	15
2.7-M Hardware Reset Switch Connector Installation	15
2.7-N Flash Utility	15
2.8 Mounting the Motherboard in the Chassis	15
2.9 Installing Memory	16
2.10 Installing the CPU and Cooling Fan	17
2.11 Connecting IDE and Floppy Drives	18
2.12 Installing Add-on Cards	20
2.13 Connecting PS/2, USB, and Serial Port 1	21
2.14 Connecting the Power Supply	21
2.15 Frequently Asked Questions (FAQ)	22
Chapter 3: BIOS Setup	23
3.1 Main Setup	25
3.2 Advanced Setup	26
3.2-A Configure SuperIO Configuration	26
3.2-B IDE Configuration	26
3.2-C Floppy Configuration	27
3.2-D Boot Settings Configuration	28
3.2-E Onboard Device Configuration	29
3.2-F System Health Monitor	29
3.2-G Event Log Configuration	29
3.3 Chipset Setup	30
3.4 PCI/PnP Menu	31
3.5 Power Menu	32
3.6 Boot Menu	33
3.7 Security Menu	33
3.8 Exit Menu	33

Chapter 4: System Resources	34
4.1 Beep Codes	34
4.2 Displayed Error Messages	35
4.3 Flash Utility	37

Appendix I: FastTrak100 Installation and LAN Information **38**

Introduction to the Promise FastTrak100 IDE RAID Controller	38
Features of the Promise FastTrak100 IDE RAID Controller	38
Visual concepts of RAID 0 (striping) and RAID 1 (mirroring)	38
Installing the hard drives	39
Checking CMOS Settings	40
Creating your disk array	40
Creating an array for Performance (RAID 0)	41
Creating a Security Array with New Drives (RAID 1)	41
Creating a Security Array with an Existing Data Drive	42
Using the FastBuild Configuration Utility.....	43
Viewing FastTrak100 BIOS Screen.....	43
LAN Information	44

Appendix II: Glossary **45**

Chapter 1: Introduction

1.1 Overview

The Tiger LE™ is a high performance, rackmount motherboard designed for web and front-end serving applications that require the power of dual Socket 370 Intel® Pentium® III processors. This motherboard utilizes the ServerWorks® ServerSet™ III LE chipset and can support CPU speeds of 500 MHz through 1 GHz and host bus speeds of 100 MHz to 133 MHz. Please see Tyan's website for updates and information concerning CPU information and support:

<http://www.tyan.com>

This integrated high-performance system board is supported in an ATX and 1U rackmount form factor. Some of the features included are onboard UltraDMA support, onboard Promise Technology® FastTrak100-Lite UltraATA-33/66/100 RAID capabilities, and onboard dual Intel Ethernet 82559 controllers.

With I/O and drive controller support onboard, two 64-bit PCI slots* are free for numerous types of add-on expansion cards. The DIMM sockets are angled at 25 degrees to allow for easy installation into a 1U rackmount chassis. Remember to visit Tyan's website at <http://www.tyan.com>. There you can find information on all of Tyan's products with FAQs, distributors list, and BIOS settings explanations.

* check p.13 (section 2.7-D) for important information regarding the PCI slot capability

1.3 Hardware Specifications

Processor Information	Dual ZIF PGA370 Socket Intel Pentium III FC-PGA Two onboard VRMs (VRM 8.4 spec) 100/133 MHz Front Side Bus support only**
Expansion Slots	Two 64-bit 5.0V PCI slots @ 66 or 33 MHz
Chipset Information	ServerWorks ServerSet III LE Chipset Integrated I/O APIC SMC FDC37B787 Super I/O Chip
System Management (manufacturing option)	Myson 2-ch. hardware monitoring chip 3-pin fan monitoring headers 2-pin chassis intrusion header (optional) CPU temperature and voltage monitoring
Intelligent Platform Management (manufacturing option)	Vitesse VSC210 controller Tailored for Intelligent Platform Management Interface (IPMI) Baseboard Management Controller (BMC) applications Two PC serial multi-master controllers and UARTs
Memory	Four 25-degree angled 3.3V DIMM sockets Up to 4 GB* PC100/PC133 registered SDRAM Supports ECC (72-bit) type memory modules
Integrated I/O	One floppy connector for up to two drives Two 9-pin UART serial ports (one serial port via cable -optional) Two USB ports* PS/2 mouse and keyboard ports
Integrated PCI / IDE	Dual channel master mode Up to four Enhanced IDE devices Support for UDMA33*** IDE and ATAPI compliant devices
Integrated LAN Controllers	Two Intel 82559 LAN controllers 10/100 Mbps data transfer rate per controller Alert On Lan (AOL 2) chipset (optional) 3-pin Wake On LAN (optional)
Integrated IDE RAID Controller	Promise Technology FastTrak100 controller RAID 0, 1, and 0+1 capabilities Concurrent Dual Channel UltraATA/100 capabilities Supports IDE bus mastering operations
Integrated 2D / 3D graphics	ATI Rage XL PCI Accelerator 4 MB 1Mx16 SDRAM frame buffer Standard 15-pin analog VGA port

* under qualification at time of print, check Tyan website for updates: <http://www.tyan.com>

** 66 MHz FSB is **NOT SUPPORTED** due to its technological limitations. For CPU compatibility updates and information check the Tyan website: <http://www.tyan.com>

*** UDMA66/100 IDE devices are compatible, but UDMA66/100 transfer speeds are not possible, with the exception of the onboard UltraDMA-100 IDE RAID feature

BIOS

AMIBIOS on 4 Mb flash[^]

You **must** check the Tyan website for BIOS Flash[^] information and instructions: <http://www.tyan.com>

User settings of HW monitoring*

Auto configuration of IDE hard disk types

Multiple boot options

PXE (**optional**)

Console redirect (**optional**)

Form Factor

1U and ATX 12" x 9.6" (304.8 x 243.84mm)

One 20-pin ATX power connector

(250 watt or higher power supply required)

Stacked mouse and keyboard ports

Two stacked USB ports*

One serial port and one DB15 video port

Two RJ-45 ports with LEDs

Regulatory

FCC Class B (Declaration of Conformity)

European Community CE

(Declaration of Conformity)

1.4 Software Specifications***

OS

Operates with Windows NT v4.0, Windows 2000, and Red Hat v6.2**

* under qualification at time of print, check Tyan website for updates: <http://www.tyan.com>

** Promise RAID chip Linux drivers (optional feature) are only for Red Hat 6.2 OS, please check with Tyan for driver availability.

*** Software produced by third party developers are the responsibility of the end user

[^] **IMPORTANT!** Check the BIOS Flash section on **p.37** for update regarding flashing

1.5 Technical Support

If a problem arises with your system, you should turn to your dealer for help first. Your system has most likely been configured by them, and they should have the best idea of what hardware and software your system contains. Hence, they should be of the most assistance. Furthermore, if you purchased your system from a dealer near you, you can actually bring your system to them to have it serviced, instead of attempting to do so yourself (which can have expensive consequences).

Help Resources:

1. See the FAQ and beep codes section of this manual.
2. See the Tyan website for FAQ, bulletins, driver updates, and other information: <http://www.tyan.com>
3. Contact your dealer for help **BEFORE** calling Tyan.
4. Check the Tyan user group: alt.comp.periphs.mainboard.tyan

1.6 Returning Merchandise for Service









During the warranty period, contact your distributor or system vendor **FIRST** for any product problems. This warranty only covers normal customer use and does not cover damages incurred during shipping or failure due to the alteration, misuse, abuse, or improper maintenance of products.

NOTE: A receipt or copy of your invoice marked with the date of purchase is required before any warranty service can be rendered. You can obtain service by calling the manufacturer for a Return Merchandise Authorization (RMA) number. The RMA number should be prominently displayed on the outside of the shipping carton and the package should be mailed prepaid. Tyan will pay to have the board shipped back to you.

Chapter 2: Board Installation

2.1 Unpacking

The retail motherboard package should contain the following:

-  Tiger LE motherboard
-  34-pin floppy cable
-  (2) ATA-66 IDE cables*** (each with a blue connector)
-  Tiger LE I/O shield*
-  Tiger LE Riser card**
-  Tiger LE user's manual
-  Tyan driver CD
-  Promise FastTrak100 Driver Disk

2.2 Installation

You are now ready to install your motherboard. The mounting hole pattern of the Tiger LE matches the ATX motherboard specifications, so your chassis must be capable of supporting an ATX motherboard.

2.3 How to install our products right.. the first time.

Question: what's the first thing I should do?

The first thing you should do is read the user's manual. It contains important information which will make configuration and setup much easier. By reading through the manual completely before installing your motherboard, you will have a complete overview on the installation.

* if you require a different I/O shield solution, please check with your chassis vendor

** Tyan's Riser card solution may not work with all 1U chassis'. If you require a different Riser card solution, please check with your chassis vendor

*** UDMA66 cable is upwards compatible with UDMA100 devices, and backwards compatible with UDMA33 devices, but UDMA66/100 speeds are not possible, with the exception of the IDE RAID

Here are some safety tips:

- (1) **Ground yourself properly before removing your motherboard from the antistatic bag.** Unplug the power from your computer power supply and touch any metal part on the computer case. (You might also want to wear a grounded wrist strap.)
- (2) **Hold the motherboard by its edges and do not touch the bottom of the board.**
- (3) **Avoid touching motherboard components, IC chips, connectors, and leads.**
- (4) **Avoid touching pins of memory modules and chips.**
- (5) **Place motherboard on a grounded antistatic surface or on the antistatic bag.**

Having reviewed the precautions above, the next step is to take the motherboard out of the cardboard box and static bag, hold it by its edges, and place it on a grounded antistatic surface, component side up. Inspect the board for damage.

NOTE:**DO NOT APPLY POWER TO THE BOARD IF IT HAS BEEN DAMAGED!**

Press down on any of the socketed ICs if it appears that they are not properly seated (the board should still be on an antistatic mat). Do not touch the bottom of the board. Remember, don't take any electronic device out of its protective bag until you are ready to actually install it into the computer case. If you do not ground yourself, you risk zapping the motherboard or adapter card. Subsequent problems may not arise immediately because electrostatic discharge, unlike physical damage, causes the device to fail over time.

Installation Steps (Overview)

1. Set jumpers (if necessary)
2. Mount motherboard in chassis
3. Install memory
4. Install CPU and cooling fan(s)
5. Connect IDE and floppy drives
6. Install add-on cards
7. Connect PS/2, serial, USB devices

2.4 Quick References for Jumpers

In this manual, the term “closed” and “on” are used when referring to jumpers (or jumper pins) that are active; “open” and “off” are used when referring to jumpers (or jumper pins) that are inactive. See **Figure 2.0a** for examples of “on” and “off” pins and jumpers. The small number “1” indicates pin 1.

Jumpers and pins are connected by slipping the plastic jumper connector over the top of two adjacent jumper pins (indicated by 1-2 or 2-3). The metal rod inside the plastic shell bridges the gap between the two pins, completing the circuit. See **Figure 2.0b** for more examples of pin connections.

The tables and maps on the following pages will help you set the jumpers for CPU speed, infrared, and external connector pin assignments, among others. The miniature motherboard maps will help you locate the jumpers on your board. Full page maps of the motherboard can be found on the next two pages.

2-pin jumpers

off on

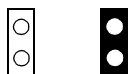

Figure 2.0a
(overhead view)

3-pin jumpers

1-2 2-3 open

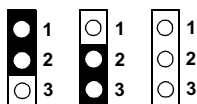
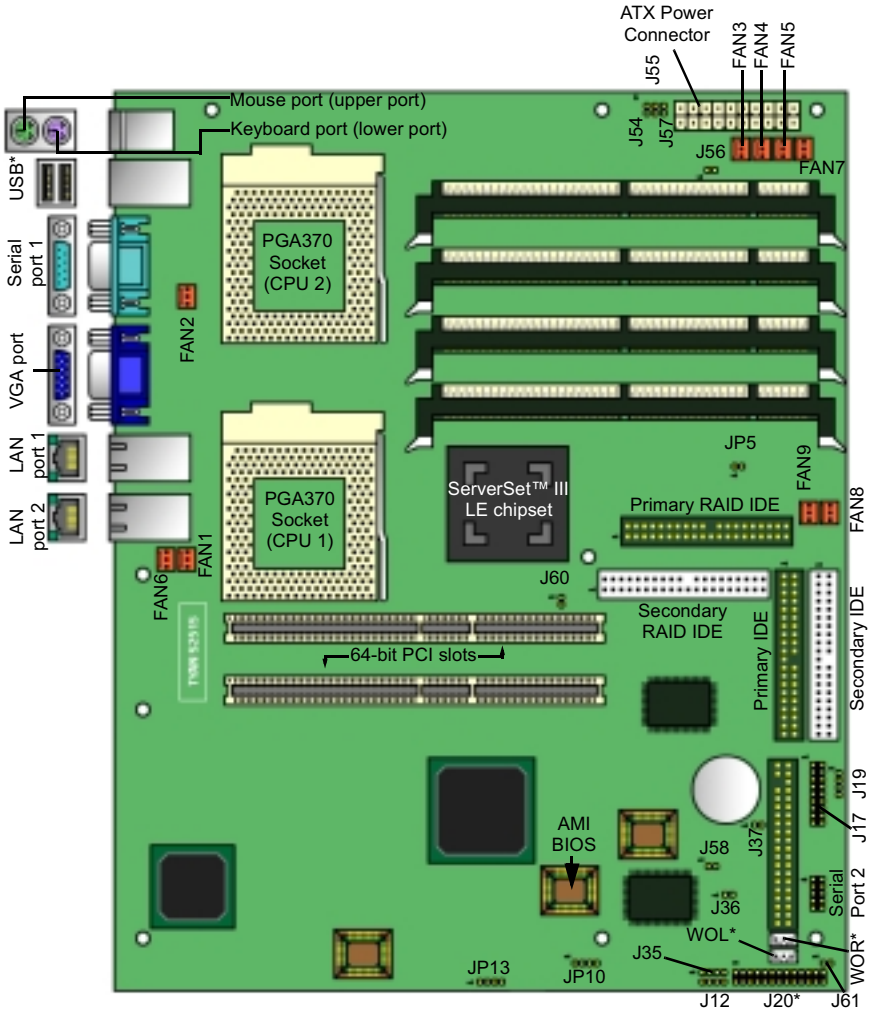

Figure 2.0b
(overhead view)

2.5 Map of Motherboard Jumpers



INSTALL

* under qualification at time of print, check Tyan website for updates: <http://www.tyan.com>

2.6 Map of Motherboard Features

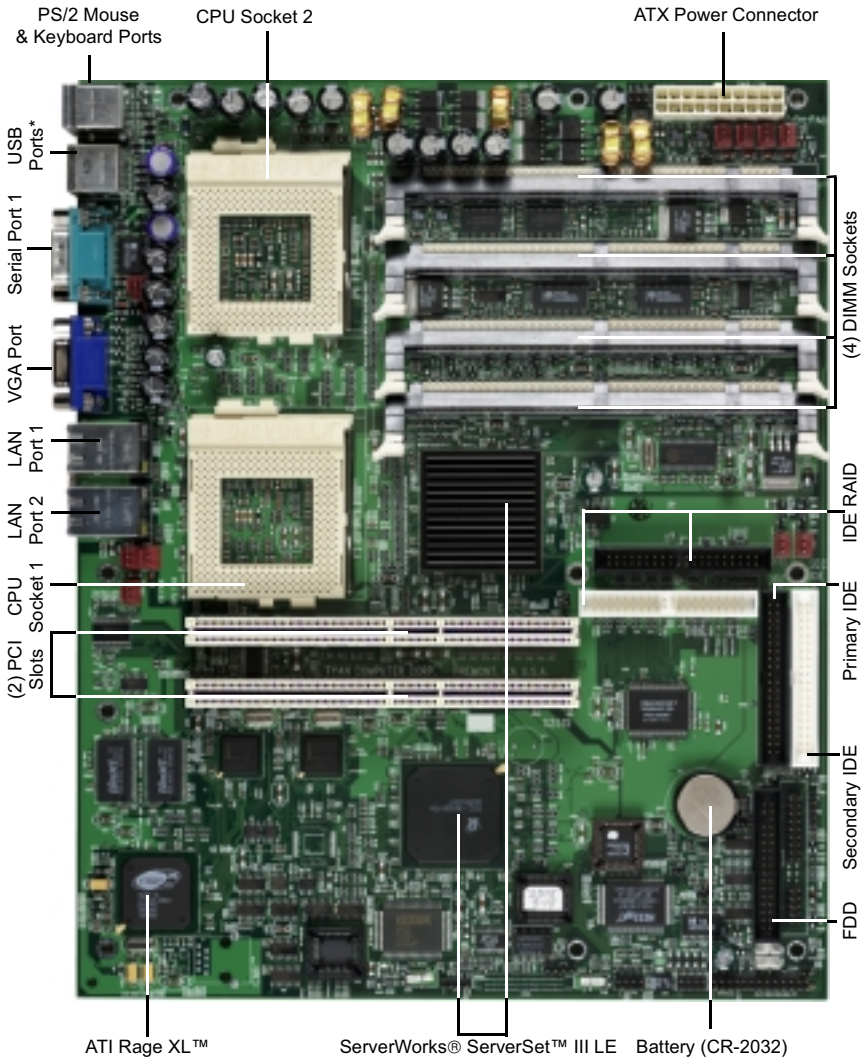

* under qualification at time of print, check Tyan website for updates: <http://www.tyan.com>

2.7 Setting Jumpers

2.7-A. Front Panel Connector (J17)

HDD LED	VCC	1	2	Pwr LED+	Pwr/Slp LEDs
	LED	3	4	Slp LED+	
Reset Switch	Ground	5	6	Switch	Power Switch
	Switch	7	8	Ground	
Infrared	IR +5V	9	10	SN_NMI	
	IR RX	11	12	Ground	
	Ground	13	14	no connect	
	IR TX	15	16	no connect	
	CHIN2	17	18	no connect	

*Power LED:
for 2-pin
(bi-color/
single-color)
LED, refer to
the table
(see left)

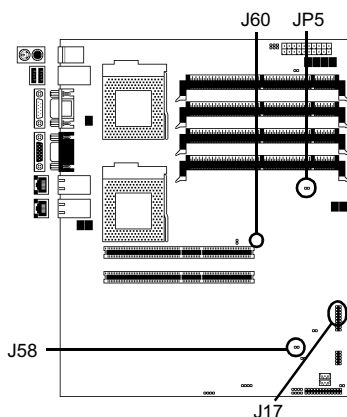

INSTALL

2.7-B. CMOS Reset (J58)

J58	open	close
	disable	enable

If you have been locked out of your system because you forgot your password or set the CMOS incorrectly, follow the instructions below.

1. Power off the system, and disconnect the power supply
2. Close J58 (see p. 11 for location of J58)
3. Wait about three seconds
4. Open J58, then power on the system again

By following this procedure, you will erase your password and reset the CMOS.

2.7-C. CPU Front Side Bus Select (JP5)

JP5	open	close
	133/100 MHz	100 MHz only

* default for JP5 is OPEN

Selection of the front side bus (FSB) speed can be set using this jumper. Please note that if your CPU does not have 133 MHz FSB, opening JP5 will not cause the CPU to run at 133 MHz FSB speed.

NOTE:

Tyan takes no responsibility and will not be held liable for damage related to the alteration of this jumper from the correct setting corresponding to your CPU manufacturer's designated front side bus speed.

2.7-D. PCI Speed Configuration (J60)

J60	open	close
	66 MHz	33 MHz

* PCI bus will not run at 66MHz if you are using a 33MHz PCI device

You have the option of changing the speed of the onboard PCI slots to either 66 MHz or 33 MHz, depending on your PCI expansion card's specifications. Check your PCI expansion card's documentation for details. **It is not recommended that you run at 66 MHz if you do not have 66 MHz devices.**

NOTE:

DEFAULT FOR J60 IS CLOSED. Tyan takes no responsibility and will not be held liable for damage related to the alteration of this jumper from the correct setting corresponding to your PCI card manufacturer's designated operating speed.

2.7-E. Server Management Connector (J20) (optional)

The (optional) EXTSMI (External System Management Interface) connector J20 is used by some plug-in cards. Certain applications associated with these plug-in cards use the interface for hardware control and queries.

2.7-F. Chassis Intrusion Alarm Connector (J36) (optional)

This is the header for the (optional) Chassis Intrusion Alarm. Note: there are only two pins that you need to connect (1 and 2, labeled on p. 11).

2.7-G. Speaker Connector (J19)

The speaker should be connected to jumper J19. The external speaker should have a 4-pin connector to connect J19 from pins 1 to 4.

J19	1	2	3	4
	Power in	no connect	no connect	Speaker

2.7-H. Serial Port 2 Connector (J17)

Check the Tyan website for pinout information: <http://www.tyan.com>

2.7-I. FAN1 to FAN9

FAN	1	2	3
	Ground	+12V	Speed

- FAN1 corresponds to the closest CPU slot
- FAN2 corresponds to the closest CPU slot
- All other fans are left to the user's discretion

2.7-J. CPU Multiplier Settings (J54, J55, J56, J57)

These settings will have **NO EFFECT** unless you have a **non-retail** (engineering sample) CPU. If you do have one, you must use these settings so the board will properly detect the CPU.

Multiplier	Bus Speed	CPU Speed	J54	J55	J56	J57	NOTE:
4	100 133	400 533	Open	Open	Open	Open	Tyan takes no responsibility and will not be held liable for damage related to the alteration of jumpers from their correct settings in accordance with your CPU specifications.
4.5	100 133	450 600	Open	Close	Open	Close	
5	100 133	500 667	Close	Open	Open	Close	
5.5	100 133	550 733	Open	Open	Open	Close	
6	100 133	600 800	Close	Close	Close	Open	
6.5	100 133	650 867	Open	Close	Close	Open	
7	100 133	700 933	Close	Open	Close	Open	
7.5	100 133	750 1000	Open	Open	Close	Open	
8	100 133	800 1067	Close	Close	Open	Open	

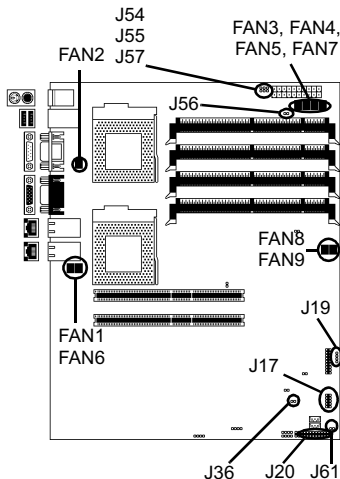

2.7-K. LAN Link External LED (J61) (optional)

This is the LAN Link LED header for the (optional) external LAN Link LED on the chassis. Use of this header is dependent on the chassis manufacturer. The LED connected to J61 will show traffic and status for both LAN ports.

2.7-L. Soft Power Connector

The soft power connector is part of jumper block J17 (pins 6 to 8). This board uses the chipset for power management, including turning on and off the system. If the power button function option in the BIOS Power Management menu is set to On/Off (which is the default), pressing the power button once after the BIOS has booted up will turn the system on and off. If the power button function is set to Suspend, pressing the power button once will wake up the system or send it to Suspend mode. In this case, you cannot turn the system off unless you shut down through the Windows operating system or you hold the power button down for four seconds.*

2.7-M. Hardware Reset Switch Connector Installation

The reset switch on your chassis case provides you with the Hardware Reset function, which is the same as power on/off, except that the system will immediately execute a cold start after the reset button is pushed.

2.7-N. Flash Utility

You can upgrade the BIOS of this motherboard by using the Flash Utility. Check **p. 37** for details.

2.8 Mounting the Motherboard in the Chassis

Your chassis may or may not have come with mounting hardware. If it did come with mounting hardware, we have provided the following examples to help you install your motherboard into the chassis.

The chassis sometimes comes with the studs integrated into the chassis wall, so in those cases you would only need to use screws (possibly included with the chassis to install the motherboard). See the diagram (**Figure 2.0**, see right) for details.

If the chassis included mounting hardware without the studs pre-installed, then you will need to install the motherboard using the mounting hardware as shown in the diagram (right). Remember not to over-tighten any of the screws, or you might break internal traces in the surrounding area, or damage the motherboard in some other way.

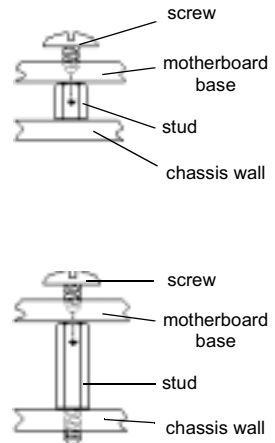

Figure 2.0

NOTE:

The diagrams above are only representative of two solutions for installing the motherboard into the chassis. The installation procedure for installing your motherboard may differ.

* under qualification at time of print, check Tyan website for updates: <http://www.tyan.com>

2.9 Installing Memory

Since Tyan boards are manufactured with performance in mind, you should use add-in components that match. Some DIMM modules may seem to be high quality because of the name or feel but that does not guarantee real-world stability. Some cheaper or OEM parts may have brand-name components, but they may contain inferior or substandard parts which do not meet the critical tolerances our products require. Because of this, your memory may not work correctly in a Tyan board. In the interest of making installation easy and trouble-free, Tyan strongly recommends that you purchase high-quality memory. For memory compatibility information and updates, check the Tyan website: <http://www.tyan.com>

Memory Installation Procedure

Line your module up so that the pins fit into the slot. There is only one way your DIMM can fit properly. Make sure that the short row of pins is lined up with the short gap in the DIMM slot. See **Figure 2.2** for graphic details on how the DIMM should be installed.

Step **1** Insert the DIMM by pushing the module into the socket with even force. Do not insert one end and then the other: install the whole module at once or you might bend the DIMM pins (see **Figure 2.2, bottom of this page**).

Step **2** Lock the DIMM into place by pushing the clips back on either end of the socket onto the notches in the ends of the DIMM (see pictures at **right**).

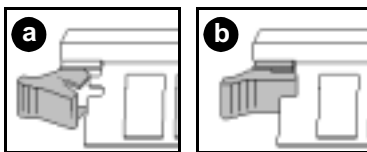

Step **3** Removing the DIMM is just the reverse: simply pull back the clips from the DIMM and carefully pull the module straight out. Place the DIMMs in the anti-static bag as soon as you remove them to avoid static damage.

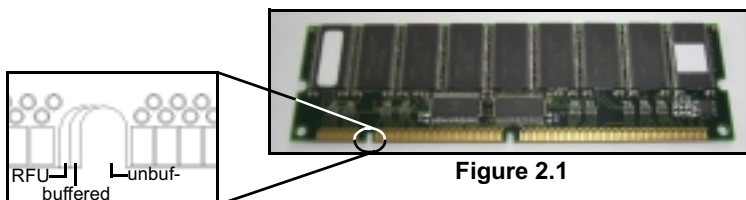



Figure 2.1

The 168-pin DIMMs (Dual In-line Memory Modules) must be of the **3.3V PC100/PC133 registered** variety. The position of the notch in the SDRAM key position will tell you whether or not a DIMM is registered (see **Figure 2.1**). All installed memory will be automatically detected, so there is no need to set any jumpers.



Figure 2.2

Here are some details of memory installation for this board:

-  At least one registered DIMM must be installed for the system to POST.
-  The motherboard supports 64MB, 128MB, 256MB, 512MB, and 1024MB registered SDRAM*.

The table below shows some of the possible memory configurations. Not all possible configurations are listed*.

DIMM 1	DIMM 2	DIMM 3	DIMM 4	TOTAL
64MBx1	0	0	0	64MBx1
64MBx1	0	128MBx1	0	192MBx1
64MBx1	64MBx1	64MBx1	64MBx1	256MBx1
128MBx1	0	128MBx1	0	256MBx1
128MBx1	128MBx1	128MBx1	128MBx1	512MBx1
128MBx1	0	256MBx1	0	384MBx1
256MBx1	256MBx1	256MBx1	256MBx1	1024MBx1
256MBx1	0	512MBx1	0	768MBx1
512MBx1	0	512MBx1	0	1024MBx1
512MBx1	512MBx1	512MBx1	512MBx1	2048MBx1
You can keep making combinations up to 4GB*				3072MBx1
				4096MBx1*

INSTALL

* 4GB memory support not verified at time of print, check Tyan website for memory information and updates: <http://www.tyan.com>

2.10 Installing the CPU and Cooling Fan

Socket 370 type **Pentium III processors ONLY** (500 MHz through 1 GHz) can be used on the Tiger LE. For more information on CPU compatibility, check Tyan's website: <http://www.tyan.com>. Remember the following: The CPU is a sensitive electronic component and it can easily be damaged by static electricity. Do not touch the CPU pins with your fingers. You should be able to insert the CPU into the socket with virtually no force. Do not press down hard on the CPU as you might bend or break pins.

Installing the Socket 370 type CPU

Before installing the CPU, check it for damage. Make sure that none of the pins are bent. Pin 1 on the CPU is denoted by a small dot on one of the corners, and Pin 1 on the ZIF socket is denoted by one of the angled corners (left bottom-most angle from the Intel logo).

Step **1** Carefully lift the arm of the ZIF socket until it is at a 90 degree angle pointing away from the motherboard. Be very careful not to damage any components that might be next to the socket. Please note that each picture for this section (see right) corresponds to the step.

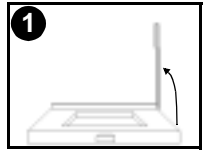

Step **2** There are two beveled corners on the CPU, which will match the two angled corners on the socket face. Carefully install the CPU by lining both Pin 1 on the CPU and Pin 1 on the socket, making sure the pins actually fit into the socket face. **Do not** force the CPU into the socket if it does not fit: check the pin alignment of CPU pins to socket holes.

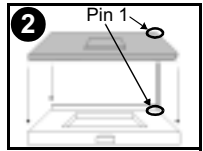

Step **3** Push down lightly on the CPU while lowering the arm on the socket to secure the CPU (see right). A squeaking noise may be heard while lowering the arm, or the socket may make a 'click' noise when the arm is locked into position: these noises are normal.

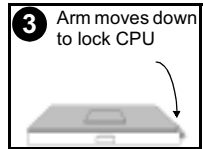

Installing the Cooling Fan

After the CPU has been installed, you will need to **install the proper cooling device** for the CPU. This device, a heatsink/cooling fan combination, can be purchased at many computer retail stores. Connection of the cooling device may vary depending on the fan manufacturer's design. You should take space into consideration when installing a cooling device into CPU1 and/or 2. Tyan **highly recommends** that you use some type of thermal compound between the CPU and heat sink, to maximize cooling. Please take extra caution when installing any kind of clamp-style fan, or else damage may occur to the CPU socket. See **Figure 2.3** for an example of how the fan power connector is installed.

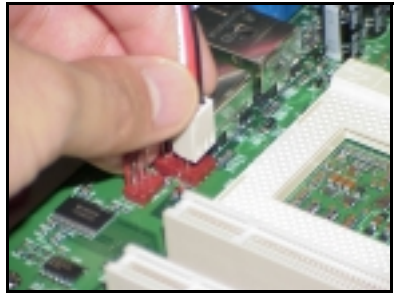

Figure 2.3

2.11 Connecting IDE and Floppy Drives

A variety of IDE and ATAPI-compliant devices can be installed on this motherboard, such as hard disk drives (HDDs) and CD-ROMs.

Please keep in mind that on this motherboard, the primary IDE connector is **BLACK**, and the secondary IDE connector is **WHITE**. **Figure 2.4** (see right) shows the IDE cable properly connected to the motherboard. Consult the documentation that came with your device, or contact the device's manufacturer for details on its

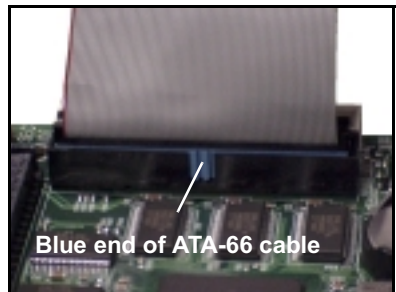

Figure 2.4

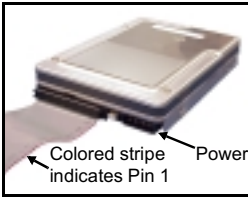

Figure 2.5

installation. Also see **Figure 2.5** (see picture to the left) for an example of an HDD with the IDE cable installed. ATA-66* IDE HDDs require a special 80-wire IDE cable* which has additional grounding wires, and may or may not have a notch near the blue connector. The cable is included in the Tiger LE motherboard package. The ATA-66 cable* is also upwards compatible with UDMA-100* devices, and backwards compatible with UDMA-33 and Legacy IDE HDDs.

* UDMA66/100 devices are compatible with non-RAID IDE interface, but UDMA66/100 transfer speeds are not possible, with the exception of the UltraDMA-100 IDE RAID feature

NOTE:

The **BLUE** end of the ATA-66 cable* must connect to the motherboard. The black connector on the ATA-66 cable* is for the master HDD, and the grey connector is for the slave HDD. See Figure 2.4 for an example of cable installation on the motherboard.

Only Tyan-approved cables are recommended for this motherboard. If you are using an existing configuration with older cables, your system might not work properly. Use only Tyan-approved cables (i.e. the ones that were included with your motherboard).

Some symptoms of incorrectly installed HDDs are...

HDDs are not auto-detected	May be a Master/Slave configuration problem, bad IDE cable, or BIOS mis-configuration. Consult the HDD documentation or contact your HDD vendor.
Hard Disk Drive Fail message at bootup	May be a bad cable or lack of power going to the drive. Check the cables for damage and bad connections.
No video or beeps during bootup	Usually means the cable has been installed backwards.
HDD lights are constantly on	Bad IDE cable or defective drives/motherboard. Try another HDD, or contact your HDD vendor.
HDD does not power on	Check power cables and cabling. May be a bad power supply or IDE drive problem.

Connecting Floppy Drives

Pin 1 on the floppy cable is usually denoted by a red or colored stripe down one side of the cable (see **Figure 2.6**). Most of the current floppy drives on the market require that the cable be installed with the colored stripe positioned next to the power connector. In most cases, there will be a key pin on the cable which will force you to connect the cable properly.

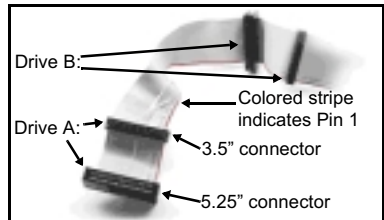









Figure 2.6

The first floppy drive (denoted as A:) is usually attached to the end of the cable with the twist in it (see **Figure 2.6** on previous page). Drive B: is usually connected to the middle of the cable. Refer to your installation instructions or call your dealer if you are unsure about attaching floppy drives. Remember, you can only have 2 floppy drives connected at any given time.

Some symptoms of incorrectly installed FDDs are...	
FDDs are not auto-detected	Usually caused by faulty cables, cables put in backwards, or a bad floppy or motherboard. Try another floppy drive to verify the problem or try another cable. Also check to see if the onboard floppy is enabled in the BIOS.
Floppy Drive Fail message at bootup	The cable, floppy, or motherboard may be faulty. Try another cable or floppy drive to verify.
FDD does not power on	Check power cables and cabling. May be a bad power supply or IDE drive problem.
FDD light is constantly on	Usually signifies that the cable is on backwards. Reverse the cable at the floppy drive end and try again.

2.11 Installing Add-on Cards*

There are a few rules you need to follow when plugging in a card. In order to assure proper operation and a quick installation, adhere to the following guidelines:

-  If you are going to install a PCI-bus interface card on your system, be aware that any one of the (2) PCI slots can support a Master or Slave device.
-  NEVER force a card into a slot. If it doesn't fit, look at the socket on the motherboard to make sure there are no wires or other obstructions to the slot.
-  NEVER plug an ISA card into a PCI slot. You will void your warranty and damage your system board if you do this.
-  When plugging the card in, especially when installing long cards, try to push the entire card in at one time. Don't force one end of the card into the socket first and then the other, or a rocking motion between the card and the slot might occur, and could damage the pins within the socket.
-  Check **speed of your PCI add-on card** and check **p. 13** for details on setting the PCI speed
-  Make sure the cards are seated securely into their slots.
-  Before turning on the system, make sure no cards are touching.

If you follow these basic guidelines, there shouldn't be any problems with installation. However, if you do encounter any problems with your add-on cards, consult their documentation, or have a qualified professional install/troubleshoot your cards for you, otherwise contact the card's manufacturer. Remember, always read the manuals and installation notes that come with the adapter cards. They contain important information which will help you install the components right, the first time.

* If you need a Riser card solution, check the Tyan website for updates: <http://www.tyan.com>

2.12 Connecting PS/2, USB, and Serial Port 1

This board includes ports for PS/2 mouse and keyboard, Universal Serial Bus (USB)*, and serial. Please note that the upper PS/2 port is the mouse port, and the lower PS/2 port is for the keyboard (see **Figure 2.7** below).

The PS/2 connectors are probably quite familiar to you, while the USB connectors may not be. A USB port* can function as a serial, parallel, mouse, keyboard, or joystick port. It is capable of supporting up to 127 daisy-chained peripheral devices. **Figure 2.7** (below) shows the ATX double row connectors on this board. Serial Port 1, as well as the other ports, are labeled in the image below.

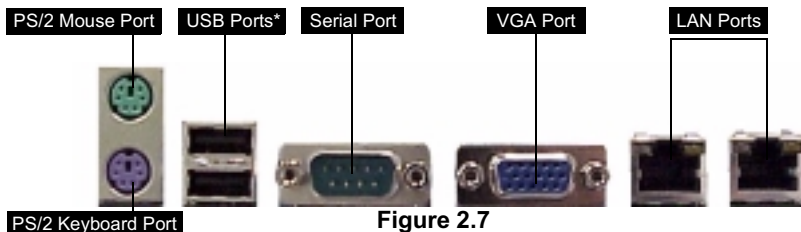

Figure 2.7

Connecting devices to Serial Port 1

When plugging in your keyboard and mouse, or when plugging anything into any external port, make sure that the power is off. Connecting these devices and ports while the power is on is called “hot plugging”, and may damage your system.

2.13 Connecting the power supply

This motherboard requires an ATX power supply. Tyan recommends using one that conforms to industry standard Revision 2.01, and is **250 watts or higher** (see website for updates: <http://www.tyan.com>). The photos below show the ATX power connector before (**Figure 2.8a**) and after (**Figure 2.8b**) it has been plugged in. The clip on the power connector should lock over the tab on the onboard connector. You shouldn't be able to plug the power connector in any other way but just to be safe, make sure it looks like **Figure 2.8b**. Make certain that you do not miss connecting any of the pins because if you do, you will void

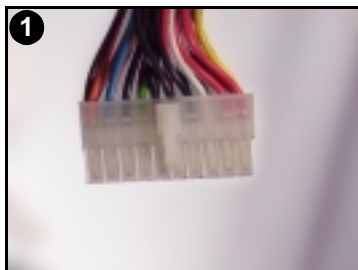

Figure 2.8a



Figure 2.8b

your warranty and possibly cause damage to yourself and/or your motherboard when the power is turned on. After connecting the power, make sure the connector is seated firmly into its socket so it will not become loose or fall off when the computer is jostled or moved.

* under qualification at time of print, check Tyan website for updates: <http://www.tyan.com>

You are done!

Other than checking the jumper settings and cable connections, and putting the case back on, you are done. Installing a new motherboard may seem difficult, but by following these directions, you should have a fairly uneventful time installing our products. If you do encounter problems, your dealer will be able to help you, or you can consult one of our many technical support resources (see p. 7).

2.15 Frequently Asked Questions (FAQ)

Q: My system sometimes becomes unstable. How should I check the system?

A: The first thing to do is check and see if you have any device conflicts related to the IRQ, or DMA. If you are using Microsoft Windows NT 4.x or 2000, the Control Panel is a good place to start investigating the conflict. Please consult your operating system documentation for details. Secondly, slowing down the memory timing in the BIOS' chipset setup section will help the situation as well. Many memory modules are not suitable for high performance systems and are probably the main source of your problem. Also check to make sure you are using a **250W or higher** power supply (with ATX 2.01 specification or better). Lastly, make sure the motherboard is receiving adequate cooling.

Q: I have a question about memory compatibility; why can't I bypass the memory test?

A: Memory compatibility information can be found on Tyan's website at: <http://www.tyan.com>. For questions concerning bypassing the memory test, check the Tyan website: <http://www.tyan.com>

Q: Where can I get additional accessories for my Tyan motherboard?

A: You can purchase additional accessories such as USB cables, as well as other Tyan-approved accessories at the Tyan Computer Online Store: <http://www.etyan.com>

Q: Where do I get pinout information for my motherboard?

A: Pinouts of certain headers are available on the Tyan website: <http://www.tyan.com>

Q: My motherboard is dead, how do I return it?

A: Contact the place of purchase or your distributor for assistance to return the motherboard for service. RMA issues will not be handled via e-mail by Tyan Tech Support. Please refer to the URL link here for more details: http://www.tyan.com/support/html/rma_faq.html

Q: How do I upgrade my BIOS?

A: Check the section about the Flash Utility (see p. 37) for information on upgrading your BIOS. BIOS update files, flash utilities, and instructions on how to install them are also available from the Tyan website at: <http://www.tyan.com>

Q: Why do I get a "CMOS checksum invalid" error message during POST?

A: If you get the above error message or "Invalid configuration, run Setup" message, it is an indication that the CMOS battery needs to be changed. Contact your dealer for assistance. Once you've replaced your battery, don't forget to check the Clear CMOS section (see p. 13) so that you can reset your CMOS.

Chapter 3: BIOS Setup

Introduction to the BIOS setup

The BIOS is the basic input/output system, required by the computer to perform functions such as CPU and hard drive support. This chapter describes different settings for AMIBIOS that can be used to configure your system.

The BIOS section of the manual is subject to change without notice and is provided here for reference purposes only. The settings and configurations of the BIOS are current at the time of print, and therefore they may not be exactly the same as that displayed on your screen.

This manual describes the AMIBIOS setup program. The setup program lets you modify basic configuration settings. The settings are then stored in a dedicated battery-backed memory, called NVRAM, that retains the information when the power is turned off.

The AMIBIOS in your computer is a customized version of an industry-standard BIOS for IBM PC AT-compatible personal computers. It supports Intel x86 and compatible processors. The BIOS provides critical low-level support for the system central processing, memory, and I/O subsystems.

The BIOS has been customized by adding important, but non-standard, features such as virus and password protection, power management, and detailed fine-tuning of the chipset controlling the system. The rest of this manual is intended to guide you through the process of configuring your system using the AMIBIOS setup program.

Starting Setup

The BIOS is immediately activated when you first turn on the computer. The BIOS reads system configuration information in CMOS RAM and begins the process of checking out the system and configuring it through the Power-On Self Test (POST).

When these preliminaries are finished, the BIOS seeks an operating system on one of the data storage devices (HDD, floppy drive, etc.) If one is found, the BIOS will launch that operating system and hand control of system operations to it. During POST, you can start the setup program by pressing the **[DEL]** key when the "Press DEL key to enter BIOS setup" message appears on the screen.

Setup Keys

The table below shows how to navigate in the setup program using the keyboard.



Key	Function
Tab	Moves from one selection to the next
Left/Right Arrow Keys	Change from one menu to the next
Up/Down Arrow Keys	Move between selections
Enter	Opens highlighted section
PgUp/PgDn Keys	Change setting

Getting Help

Press **[F1]** to display a small help window that describes the appropriate keys to use and the possible selections for the highlighted item. To exit the Help Window press **[ESC]** or the **[F1]** key again.

In Case of Problems

If you discover that you have trouble booting the computer after making and saving changes with the BIOS setup program, you can restart the computer by either:

-  Pressing **[CTRL]+[ALT]+[DEL]** (all three keys at the same time)
-  Holding the power button down until the computer shuts off*

The best advice is to alter only settings that you thoroughly understand. In particular, do not change settings in the Chipset screen unless you absolutely sure that you need to. The Chipset defaults were carefully chosen by AMI or your system manufacturer for the best performance and reliability. Even a seemingly small change to the Chipset setup may cause the system to become unstable.

Setup Variations

Not all systems have the same setup program. While the basic look and function of the setup program remains more or less the same for all system, the appearance of your Setup screen may differ from the screens shown here. Each system design and chipset combination require custom configurations. In addition, the final appearance of the setup program depends on your system designer. You system designer can decide that certain items should not be available for user configuration, and remove them from the BIOS setup program.

* under qualification at time of print, check Tyan website for updates: <http://www.tyan.com>

3.1 Main Setup

The AMIBIOS allows you to select from several setup functions and two exit choices.

System Date/Time

You can type in the date and time directly, or select the portion of the date or time that you want to modify and adjust it using the **↑ ↓** cursor keys. The clock runs on a 24-hour cycle (i.e 1:00 PM is 13:00).

General Help

At any time, you can press **[F1]** to bring up a General Help screen in case you want to learn the shortcut commands. There are two settings you should be aware of (listed below).

Key	Function
Load Failsafe Defaults	If your system is experiencing configuration problems, you can choose this option to reset all settings.
Load Optimal Defaults	This will load preset options that are designed for maximum system performance, but may not work for all computer applications. You should not use this option if you are experiencing configuration problems.

3.2 Advanced Setup

In the Advanced setup, you can setup your system devices, boot options, and more. Each option has a configuration sub-screen (denoted by the **▶** symbol).

The screenshot shows the BIOS Setup Utility interface. At the top, the title is "BIOS SETUP UTILITY" and the menu options are "Main", "Advanced", "Chipset", "PCIPnP", "Power", "Boot", "Security", and "Exit". The "Advanced" option is selected. The main area displays a "Setup Warning" message: "Setting items on this screen to incorrect values may cause the system to malfunction!". Below this, a list of configuration options is shown, each preceded by a right-pointing arrow (▶): SuperIO Configuration, IDE Configuration, Floppy Configuration, Boot Settings Configuration, Onboard Device Configuration, System Health Monitor, and Event Log Configuration. In the bottom right corner, a legend explains the navigation keys: left and right arrows for "Select Screen", up and down arrows for "Select Item", Enter for "Go to Sub Screen", F1 for "General Help", F10 for "Save and Exit", and ESC for "Exit". At the very bottom, the copyright notice reads "v02.02 (C) Copyright 1985-2000, American Megatrends, Inc."

3.2-A. Configure SuperIO Configuration

In this sub screen you can configure the different hardware ports available, and change the status of the floppy controller.

Onboard Floppy Controller	This device handles communication between the floppy drive and the motherboard. [Default setting is Enabled]
Serial Port Address	The address of Serial Port 1 can be changed if a hardware conflict occurs. [Default setting is Normal]
Serial Port 2 Mode	Depending on your needs, the mode of Serial Port 2 can be altered. [Default is Normal]

3.2-B. IDE Configuration

On bootup, the BIOS will auto-detect the existence of IDE devices such as hard drives and CD-ROMs. You can also check the status of those IDE devices and change other IDE-related options. There are also configuration sub screens for each IDE device (denoted by the ► symbol). Depending on what devices you set up, some options may or may not be available. In most cases, the default settings that appear when the device is detected by the BIOS will be sufficient. To absolutely sure that your settings are correct, always check the documentation for each device you set up.

Onboard PCI IDE Controller	The PCI IDE controller is essential for communication between the IDE devices and the motherboard. [Default setting is Both]
Hard Disk Protect	This option disables or enables write protection to the IDE devices. This option is only effective if the devices are being accessed through the BIOS. [Default setting is Auto]
ATA(PI) Detect Time Out	The BIOS will spend a preset amount of time to detect any IDE devices before it continues to the next stage of bootup. The amount of time can be changed using this option. [Default is 0]
ATA(PI) 80Pin Cable Detection	Selects the process that the BIOS will use to detect 80Pin ATA(PI) cables. [Default is Normal]

An explanation of possible options in the IDE configuration sub-screens is shown on the next page.

Type	The type of IDE device installed can be configured using this option. [Default setting is Auto for auto-detect]
LBA/Large Mode	These modules make it possible for the BIOS to take advantage of the additional space on drives which are larger than 504MB. This can be auto-detected (when you select Auto for Type), or you can manually set this mode to Disabled. [Default setting is Auto]
Block (Multi-sector Transfer)	When set to Auto, the block mode auto-detects the optimal number of block read/writes per section that the drive supports. [Default is 0]
PIO Mode	Programming input/output is a method of transmitting data between devices that use the system's CPU as part of the data path. There are 6 modes: 5 with their own transmission speed and 1 auto mode. To use modes 3 and 4, you must use an Enhanced IDE drive. [Default is Auto]
DMA Mode	This option specifies the Direct Memory Access mode for the IDE device. If set to Auto, the BIOS will determine the DMA mode. [Default is Auto]
S.M.A.R.T. (Self-Monitoring Analysis and Reporting Technology)	This option allows the S.M.A.R.T. protocol to report server system information over a network. [Default is Auto]
32Bit Data Transfer	If set to On, this option allows for the transmission of 32-bits in parallel (e.g. at the same time). If set to Off, only 16-bits will be transmitted in parallel. [Default is Enabled]
ARMD Emulation Type	Specifies the type of emulation used for a non-disk device attached as the primary master IDE device. If set to Auto, the BIOS will determine the emulation type. [Default is Auto]

3.2-C. Floppy Configuration

In this configuration sub-screen you can change options for your floppy drive(s). If you are unsure what kind of floppy drive you have, you should consult the documentation that came with your drive, or consult your vendor.

Floppy A	The settings are 360KB 5.25", 1.2MB 5.25", 720KB 3.5", 1.44MB 3.5", or 2.88MB 3.5".
Floppy B	The options are the same as listed for Floppy A. [Default setting is Disabled]
Diskette Write Protect	Sets whether or not the drive can be written to. [Default is Disabled]
Floppy Drive Seek	Sets whether or not the BIOS should check for the drive at bootup. [Default is Disabled]

3.2-D. Boot Settings Configuration

In the Boot Settings Configuration sub-screen, several options are available to change how the system boots up.

Quick Boot	When Enabled, the BIOS will save time during bootup by skipping certain items. [Default is Enabled]
Quiet Boot	When Disabled, the normal POST messages are displayed. [Default setting is Disabled]
AddOn ROM Display Mode	Specifies the system display mode that is set at the time that AMIBIOS post initializes an optional ROM. If set to Force BIOS, the current mode used by AMIBIOS is used. If set to Keep Current, the current display mode is used. [Default is FORCEBIOS]
Bootup Num-Lock	Sets whether or not the NumLock key should be turned on at bootup. [Default is On]
Bootup CPU Speed	Sets the initial CPU speed to high or low at bootup. [Default is High]
PS/2 Mouse Support	Sets whether or not the PS/2 ports should support a mouse device. If set to Enabled, IRQ12 will be reserved for the mouse device. [Default is Enabled]
Typematic Rate	Sets how fast the keyboard will accept input. [Default is Fast]
System Keyboard	Sets whether or not the keyboard exists. [Default is Present]
Primary Display	Sets the type of monitor that is being used. [Default is VGA/EGA]
Parity Check	Sets whether or not the memory will be checked for parity. [Default is Disabled]
Boot to OS/2	Set this option to 'Yes' if you are using OS/2 and are using more than 64MB of system memory. [Default is No]
Wait for 'F1' if error	If an error occurs during bootup, the BIOS will ask the user to press 'F1' to enter the BIOS Setup Utility to repair the problem. [Default is Enabled]
Hit 'DEL' Message Display	If Enabled, the BIOS will display an option to enter the BIOS Setup Utility at bootup. [Default is Enabled]
Internal Cache	Sets the type of caching algorithm that will be used for the L1 internal cache memory. [Default is Write-Back]
System BIOS Cacheable	Sets the type of caching algorithm that will be used for the L2 external cache memory. [Default is Enabled]

3.2-E. Onboard Device Configuration

In this sub-screen, you can enable or disable certain devices as your needs require.

Onboard LSI SCSI	This option is only available on the S2510. [Default setting is Enabled]
Onboard Intel NIC 82559(1)	The operating status of one of the onboard LAN controllers can be changed using this option. [Default is Enabled]
Onboard Intel NIC 82559(2)	The operating status of one of the onboard LAN controllers can be changed using this option. [Default is Enabled]
Onboard Promise IDE Controller	The onboard Promise IDE controller can be enabled and disabled using this option. [Default is Enabled]

3.2-F. System Health Monitor

The status of CPU1 and 2, chassis fans 1 to 4, and the voltage are shown in this screen, depending on what components you have installed.

CPU1	Shows three fields: current temperature in celsius, core voltage (Vcore), and fan speed in revolutions per minute (RPM).
CPU2	Shows three fields: current temperature in celsius, core voltage (Vcore), and fan speed in RPM.
Chassis FanX Speed	Shows speed of FanX, where 'X' is the number of the fan. Speed is measured in RPM.
VCC	Shows system voltage values for your convenience.

3.2-G. Event Log Configuration

In this sub-screen you can access the log that is created when bootup errors occur. This log will help you troubleshoot any configuration problems you might experience. The status of the Event Log is shown on the top half of the screen.

Event Logging	If set to Enabled, bootup error events will be logged. [Default is Enabled]
ECC Event Logging	If set to Enabled, ECC events will be logged. [Default setting is Disabled]
Clear All Event Logs	If set to Yes, the event log will be cleared on saving of BIOS settings followed by reboot. [Default is No]
View Event Log	Shows you the Event Log.
Mark All Events As Read	By using this option, the events in the Event Log can be organized to help troubleshoot configuration problems.

3.3 Chipset Setup

The Chipset Setup is for advanced configuration of the motherboard attributes.

C000 - C400, 16k Shadow	<p>Specifies how the 16k of video ROM is treated at the listed address.</p> <p>Disabled: contents of video ROM are not copied to RAM</p> <p>Enabled: contents of video ROM at listed address segment is copied (shadowed) from ROM to RAM for faster execution.</p> <p>Cached/WP: contents of video ROM from listed address segment are copied from ROM to RAM and can be written to or read from cache memory.</p> <p>[Default is Cached]</p>
C800 - DC00, 16k Shadow	[Default is Disabled]
Act to Deact	[Default is 6Clks]
Act to Read/Write	[Default is 3Clks]
RAS Precharge Time	Sets length of RAS precharge part of DRAM system memory access cycle when SDRAM system memory is installed. [Default is 3Clks]
RA Cycle Time	[Default is 10Clks]
Write to Deact	[Default is 3Clks]
SDRAM CAS Latency	[Default is CAS Latency 3]
ISA IO Cycle Delay	[Default is 1.5 Bclk]
MPS 1.4 Support	[Default is Enabled]

3.4 PCI/PnP Menu

The PCI/PnP Setup lets you configure the onboard PCI Plug-n-Play (PnP) devices available.

Plug & Play O/S	Indicates if you are using a PnP O/S. [Default is No]
Reset Config Data	If set to Yes, PCI/PnP data will be stored in Flash on next boot. [Default setting is No]
PCI Latency Timer	Specifies latency timings for PCI devices. [Default is 64]
Allocate IRQ to PCI VGA	Informs PCI devices that an ISA graphics device is installed in the system so the card will function correctly. [Default is Yes]
Palette Snooping	If set to Enabled, multiple VGA devices operating on different buses can handle data from the CPU on each set of palette registers on every video device. [Default is Disabled]
PCI IDE Bus Master	Specifies that the IDE controller on the PCI bus has bus mastering capability. [Default is Disabled]
Offboard PCI/ISA IDE Card	Specifies if an offboard PCI or ISA IDE controller card is installed. [Default is Auto]
USB Function	Enables USB. [Default is Disabled]*
Legacy USB Support	Enables legacy USB device support. [Default is Disabled]*
IRQ (3,4,5,7,9,10,11,14,15)	Allows listed IRQ to be used by PCI/PnP devices. [Default is Available]
DMA Channel (0,1,3,5,7)	Allows listed DMA to be used by PCI/PnP devices. [Default is Available]
Reserved Memory Size	Specifies size of memory area reserved for legacy ISA adapter cards. [Default is Disabled]

* under qualification at time of print, check Tyan website for updates: <http://www.tyan.com>

3.5 Power Menu*

The Power Setup lets you configure how the BIOS handles power management.

Power Management	Enables Power functions on this screen. [Default is Disabled]
Power Button Mode	Changes how the power button will function. [Default setting is On/Off]
Sleep Button Enable	Changes the function of the sleep button. [Default is Suspend]
Green PC Monitor Power State	Changes option for the Green PC compatible monitors. [Default is StandBy]
Video Power Down	Changes the event that occurs when the video powers down. [Default is Suspend]
Hard Disk Power Down Mode	Changes the event that occurs when the HDD powers down. [Default is Disabled]
Inactivity Timer	Changes the amount of time the BIOS will wait before activating system power functions as set by the user. [Default is Off]
Suspend Time Out (Minutes)	Changes the amount of time the BIOS will wait before activating the suspend mode. [Default is Off]
IRQ (3,4,5,7,9,10,11,14,15)	Changes how the BIOS will treat each IRQ in terms of power management.
USB Controller Resume*	Changes how the BIOS will handle the USB controller power function. [Default is Disabled]
PME Resume	Changes the PME power function. [Default is Disabled]
RI Resume	Changes the RI power function. [Default is Disabled]

* under qualification at time of print, check Tyan website for updates: <http://www.tyan.com>

3.6 Boot Menu

The Boot Setup lets you configure options set for each device during boot. The options available will depend on what devices you have installed in your computer.

Boot Device Priority	Sets the order of devices that BIOS will attempt to boot from.
Hard Disk Drives	Shows the available HDDs and allows changes to the order in which each is booted (e.g. which boot firsts, second, and so on).
Removeable Drives	Shows the available removable drives and allows changes to the order in which each is booted (e.g. which boot firsts, second, and so on).
ATAPI CDROM Drives	Shows the available CD-ROM drives and allows changes to the order in which each is booted (e.g. which boot firsts, second, and so on).

3.7 Security Menu

The Security Setup lets you configure security options such as passwords and boot sector virus protection. The status of the Supervisor and User Passwords are shown at the top, and options can be set through the rest of the configuration sub-screen.

Change Supervisor Password	Install or change the password.
Change User Password	Install or change the password.
Clear User Password	Immediately clears the User password.
Boot Sector Virus Protection	Protect against boot sector viruses. [Default is Disabled]

A password screen (such as the example screen below) will appear when you select one of the Change Password functions. To set a password, enter a unique set of 6 letters and/or numbers.

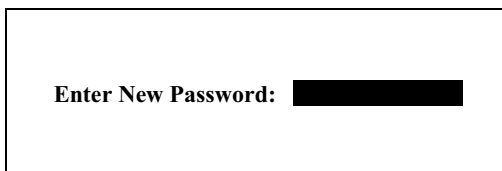

3.8 Exit Menu

Before you exit the BIOS, a set of options will be presented to you.

Exit Saving Changes	Save changes and exit setup.
Exit Discarding Changes	Do not save changes and exit setup.
Load Optimal Defaults	Load optimal settings. Note: May not work with all applications.
Load Failsafe Defaults	Load failsafe settings. Note: May not work with all applications.
Discard Changes	Disregard all changes you made.

Chapter 4: System Resources

First things to check when theres an error: memory, video, and CPU. Since this board has built-in video, you will only need to check memory and CPU if there is a problem.

4.1 Beep Codes

Fatal errors, which halt the boot process, are communicated through a series of audible beeps. If AMI-BIOS POST can initialize the system video display, it displays the error message. Displayed error messages, in most cases, allow the system to continue to boot. Displayed error messages are described on p. 34-37. See below for the beep code explanations.

Troubleshooting System Problems

If the computer beeps...

then...

5 times...	re-seat the memory. If the system still beeps, replace the memory.
6 times...*	try a different keyboard, or replace the keyboard fuse (if one exists). If the error occurs again, return the board to your dealer for a replacement.
8 times...*	there is a memory error on the video adapter. Replace the video adapter, or the RAM on the video adapter (applies only to external video adapters). If the error occurs again, return the board to your dealer for a replacement.
9 times...*	the BIOS ROM is bad. The system probably needs a new BIOS ROM chip.
11 times...*	re-seat the cache memory on the motherboard. If it still beeps, replace the cache memory.
4, 7, or 10 times...*	for 5 or 7 beeps, first test with a new CPU. If that does not solve the problem, then return the board to your dealer for a replacement.

4.2 Displayed Error Messages

If an error occurs after the system display has been initialized, the error message will be displayed in the following format:

```
ERROR Message Line 1
ERROR Message Line 2
Press <F1> to continue
```

and the system will halt. The system will not half of the "Wait for <F1> If Any Error" option in Advanced Setup is set to Disabled.

```
RUN SETUP UTILITY
```

may also appear. Press **[F1]** to run WINBIOS Setup if this message appears.

* under qualification at time of print, check Tyan website for updates: <http://www.tyan.com>

The table below can be used to troubleshoot error messages.

Error Message	Possible Reason For Error	Possible Solution
8042 Gate-A20 Error	Gate A20 on the keyboard controller (8042) is not working.	Replace the 8042
Address Line Short!	Error in the address decoding circuitry.	Return the board to dealer for a replacement.
C: Drive Error	No response from drive C:	Check the C: hard disk type in CMOS Setup.
C: Drive Failure	No response from hard disk drive C:	Replace the drive
Cache Memory Bad, Do Not Enable Cache!	Cache memory is defective.	Return the board to dealer for a replacement.
CH-2 Timer Error	An AT system has two timers. There is an error in timer 2.	Return the board to dealer for a replacement.
CMOS Battery State Low	CMOS RAM is powered by a battery. This error message indicates low battery power.	Replace the battery
CMOS Checksum Failure	CMOS RAM checksum is different than the previous value.	Run CMOS Setup
CMOS System Options Not Set	The values stored in the CMOS RAM have been destroyed.	Run CMOS Setup
CMOS Display Type Mismatch	The video type set in CMOS RAM does not match the type detected.	Run CMOS Setup
CMOS Memory Size Mismatch	The amount of memory found by AMI-BIOS is different than the amount in CMOS RAM.	Run CMOS Setup
CMOS Time and Date Not Set	The date and time need to be set.	Run CMOS Setup
D: Drive Error	No response from drive D:	Check the hard disk type in CMOS Setup
D: Drive Failure	No response from drive D:	Check the hard disk type in CMOS Setup
Diskette Boot Failure	The boot diskette in drive A: cannot be used to boot the system.	Use another boot disk
Display Switch Not Proper	Some systems require a video switch to be set to either color or monochrome.	Turn system off, set switch properly, then power back on

Error Message	Possible Reason For Error	Possible Solution
DMA Error	Error in the DMA controller.	Return the board to dealer for a replacement.
DMA 1 Error	Error in first DMA channel.	Return the board to dealer for a replacement.
DMA 2 Error	Error in second DMA channel.	Return the board to dealer for a replacement.
FDD Controller Failure	AMIBIOS cannot communicate with the floppy disk drive controller.	Check all appropriate connections after the system is powered down.
HDD Controller Failure	AMIBIOS cannot communicate with the hard disk drive controller.	Check all appropriate connections after the system is powered down.
INTR1 Error	Interrupt channel 1 failed POST.	Return the board to dealer for a replacement.
INTR2 Error	Interrupt channel 2 failed POST.	Return the board to dealer for a replacement.
Invalid Boot Diskette	AMIBIOS can read the diskette in floppy drive A:, but it cannot boot the system with it.	Use another boot disk
Keyboard is locked... Unlock it	The keyboard lock on the system is engaged.	The system must be unlocked to continue the boot sequence
Keyboard Error	The keyboard has a timing problem.	Make sure a keyboard controller is installed. Set Keyboard in Advanced Setup to Not Installed to skip the keyboard POST routines.
KB/Interface Error	There is an error in the keyboard connector.	Check the keyboard connector when the system has powered down
No ROM BASIC	Cannot find a proper bootable sector on either drive A: or C:.	Check the disks for boot files
Off Board Parity Error	Parity error in memory installed on an adapter card in an expansion slot. The format is: OFF BOARD PARITY ERROR ADDR = (XXXX) XXXX is the hex address where the error occurred.	Check memory in adapter card

Error Message	Possible Reason For Error	Possible Solution
On Board Parity Error	Parity error in motherboard memory. The format is: OFF BOARD PARITY ERROR ADDR = (XXXX) XXXX is the hex address where the error occurred.	Check memory onboard
Parity Error ?????	Parity error in system memory at an unknown address.	Reseat memory; if error occurs again change memory

4.3 Flash Utility

Every BIOS file is unique for the motherboard it was designed for. For Flash Utilities, BIOS downloads, and information on how to properly use the Flash Utility with your motherboard, you must check the Tyan website: <http://www.tyan.com>

IMPORTANT! If you have a BIOS chip with part number **SST 28SF040A** (see **Figure 3.1 below**), **DO NOT** flash with a BIOS that is **below v1.04**. Otherwise, you will render your system inoperable. In order to find out if you have the SST 28SF040A, you will need to peel back the sticker (see **Figure 3.0 below**). **If you have a different chip other than the SST 28SF040A, this note does not affect you.**

NOTE:

Please be aware that by flashing your BIOS, you agree that in the event of a BIOS flash failure, you must contact your dealer for a replacement BIOS. There are no exceptions. Tyan does not have a policy of replacing BIOS chips directly with end users. In no event will Tyan be held responsible for damage done to the BIOS by the end user.



Figure 3.0 - Peeling back the sticker

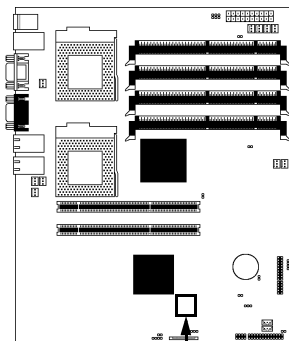

AMI BIOS



Figure 3.1
SST 28SF040A

Appendix I: RAID Installation and LAN Information

Introduction to the Promise FastTrak100 IDE RAID Controller

The FastTrak100 can stripe multiple UltraDMA/100 hard drives together under RAID 0; mirror the data on two drives under RAID 1 (master only); or do both for maximum speed and protection under RAID 0+1. Under mirroring, should one drive fail, the remaining drive will handle all data. When a new replacement drive is later installed, the FastTrak100 rebuilds data to the new drive from the mirrored drive to restore fault tolerance. Up to 4 drives* can be linked to the Promise FastTrak100 RAID controller, effectively doubling their sustained data transfer rate**. The FastBuild™ auto-menu allows for quick and easy array builds. **NOTE: You cannot install any devices other than HDDs on the RAID controller!**

Features of the Promise FastTrak100 IDE RAID Controller

Drive Support	EIDE, UltraDMA-33/66/100 drives
Drives Required	2 (maximum 4)*
Data performance (RAID 0)	Doubles sustained transfers of attached drives**
Data Storage (RAID 0, JBOD)	Links multiple drives as one large drive (C, D, or other)
Data Protection (RAID 1, RAID 0+1)	Send identical data to two drives (or drive pairs) per save; rebuilds data in background; supports "hot" spare drive (RAID 1 mode only) in case of failure
Onboard BIOS support	Automatically identifies type of drive; allows booting from any drive array
RAID Levels	RAID 0 (striping 2-to-4 drives) RAID 1 (mirroring 2 drives) RAID 1 + spare (3 drives) RAID 0+1 (4 drives only) JBOD (spanning 2-to-4 drives)

Visual concepts of RAID 0 (striping) and RAID 1 (mirroring)

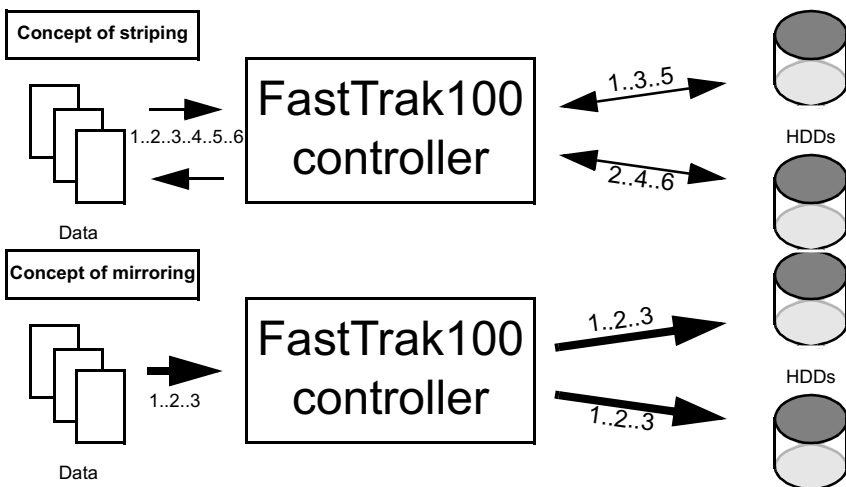

* Promise recommends using identical drives

** performance varies depending on drives and systems

Installing the hard drives

If you wish to use your current bootable HDD (using Windows NT 4.x or 2000) as part of the bootable mirrored (RAID 1) array, do **NOT** connect the hard drive yet. First, you **MUST** install Windows NT 4.x or 2000 on your **existing** hard drive controller.

Hard drives must be of the Fast ATA-2, EIDE, or UltraDMA-33/66/100 type if you want to use them with the RAID controller. For best performance, we recommend that you use drives of identical model and capacity. By matching drives, you ensure compatibility as well. If you are planning to use an UDMA-66 or 100 drive, you must use an UltraDMA-66/100 cable (Tyan has included that cable with the motherboard).

Also, if you are planning to use striping (RAID 0), we recommend you use two new drives. For mirroring (RAID 1), you should either use two new drives, or your old drive **and** a new drive (of the same size or larger than your current drive).

Step **1** The first step is to set the hard drive to either Master, Slave, or Cable Select setting, and install them according to the table below. **Note: Sometimes the Master drive with no Slave attached is called "single".** The Master/Slave setting differentiates two drives connected on the same cable. **NOTE: Check your HDD documentation for master, slave, and cable select settings.**

Jumper Settings (see your HDD documentation for jumpers)		
# of Drives	IDE Channel 1	IDE Channel 2
1	M	---
2	M	M
3	M & S	M
4	M & S	M & S

M = Master, S = Slave

Step **2** Next, you should install the drives into your system, and connect the power. Attach one UltraDMA cable (black connector) to each drive (if you have a Slave drive, connect that drive to the second connector (grey connector) on the UltraDMA cable). Make sure that Pin 1 on the cable (indicated by the colored stripe) is connected to Pin 1 of the hard drive. See **Figure I-1** (to the right) for an example.

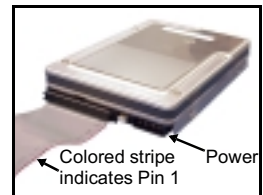

Figure I-1

Step **3** The **blue** end of the cable (see **Figure I-2** to the right for an example) goes to the RAID connector on the motherboard (see p. 11 & 12 for location). Make sure Pin 1 of the ATA-66 cable connects to Pin 1 of the Promise RAID IDE connector (see p. 11 & 12 for location). Check all connections after completing this step, before you continue to the next part of the installation.

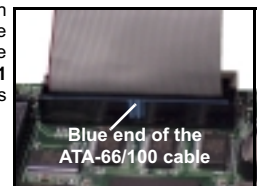

Figure I-2

NOTE:

If you are planning to use your old hard drive, backup all necessary data first. Always backup the data on an existing hard drive if you are planning to use it in a new system configuration.

Checking CMOS Settings

The FastTrak100 controller is a Plug-n-Play device that supports PCI IRQ sharing. In order to make the RAID array bootable, make sure that in the CMOS, drive types are set to "Unknown" or "Not Installed" (see p. 26, section 3.2-B). You should also change the order of boot devices (see p. 33, section 3.6) so that the FastTrak100 RAID array is the second choice as a bootable device.

Creating your disk array

You can now use the FastBuild BIOS Utility to create your drive array. Three possibilities exist: you can create an array for performance; you can create a Security array with new hard drives (recommended); or you can create a Security array using your old hard drive and a new one.

NOTE:

If you are planning to use your old hard drive, backup all necessary data first. Always backup the data on an existing hard drive if you are planning to use it in a new system configuration.

Step **1** Boot your system. If this is the first time you have booted with the FastTrak100 with drives installed, the Promise onboard BIOS will display the following screen.

```
FastTrak100 (tm) BIOS Version 1.xx (Build xxxx)
(c) 1995-2000 Promise Technology, Inc. All Rights Reserved.

No array defined . . .

Press <Ctrl-F> to enter FastBuild (tm) Utility
Or press <ESC> key to continue booting the system.
```

Step **2** Press <Ctrl-F> keys to display the FastBuild (tm) Utility Main Menu

Step **3** Press "1" to display the Auto Setup Menu (shown below). This is the fastest and easiest method to creating your first array.

```
FastBuild (tm) Utility 1.xx (c) 1995-2000 Promise Technology, Inc.
[Auto Setup Options Menu]
```

```
Optimize Array for:           Performance
Typical Application usage:    A/V Editing
```

```
[Auto Setup Configuration]
```

```
Mode.....Stripe
Drives used in Array.....2
Array Disk Capacity.....16126
```

```
[↑] Up [↓] Down [←] [→] , Space] Change Option [ESC] Exit [Ctrl-Y] Save
```

Creating an array for Performance (RAID 0)

FastTrak100 allows users to create striped arrays with 1, 2, 3, or 4 drives. To create your array, follow the steps outlined below.

- Step **1** Choose **Performance** under the **Optimize Array** section.
- Step **2** Select how you will use your PC the mode under the **Typical Application usage** section. The choices are **A/V Editing**, **Server**, and **Desktop** (the default).
- Step **3** Press **<Ctrl-Y>** keys to Save and create the array.
- Step **4** Reboot the system.
- Step **5** Proceed to install the drivers from the driver disk.

Creating a Security Array with New Drives (RAID 1)

To create an array for data protection using new hard drives, use the following steps.

NOTE:

FastTrak100 permits only two drives to be used for a single Mirrored array in Auto Setup. If a third drive is attached, it becomes a "hot" spare drive. If four drives are attached, the Mirroring option will not be available at all.

- Step **1** Choose **Security** under the **Optimize Array for** section.
- Step **2** Press **<Ctrl-Y>** keys to Save your selection.
- Step **3** The window below will appear.

Do you want the disk image to be duplicated to another? (Yes/No)
Y - Create and Duplicate
N - Create Only
- Step **4** Press "N" for the **Create Only** option.
- Step **5** A window will appear almost immediately confirming that your Security array has been created. Press any key to reboot the system.

Array has been created.
<Press Any Key to Reboot>

- Step **6** Once the arrayed drives have been formatted, proceed to install your O/S and drivers from the driver disk.

Creating a Security Array with an Existing Data Drive

You would use this method if you wish to use a drive that already contains data and/or is the bootable system drive in your system. You will need another drive of identical or larger storage capacity.

NOTE:

FastTrak100 permits only two drives to be used for a single Mirrored array in Auto Setup. If a third drive is attached, it becomes a "hot" spare drive. If four drives are attached, the Mirroring option will not be available at all.

NOTE:

If you are planning to use your old hard drive, backup all necessary data first. Always backup the data on an existing hard drive if you are planning to use it in a new system configuration.

NOTE:

If you wish to include your current bootable drive using the Windows NT 4.x or Windows 2000 operating system as part of the bootable Mirrored (RAID 1) array on your FastTrak100 do **NOT** connect the hard drive to the FastTrak100 connector yet. You **MUST** install the Windows NT 4.x or 2000 driver software first (from the driver disk) while it is still attached to your existing hard drive controller. For all other operating systems, continue using the following steps listed below.

Step **1** Choose **Security** under the **Optimize Array for** section.

Step **2** Press **<Ctrl-Y>** keys to Save your selection. The window below will appear.

Do you want the disk image to be duplicated to another? (Yes/No)
Y - Create and Duplicate
N - Create Only

Step **3** Press "Y" for the **Create and Duplicate** option. The window below will appear asking you to select the Source drive to use. FastBuild will copy all data from the Source drive to the Target drive.

Channel:ID	Source Disk Drive Model	Capacity (MB)
Channel:ID	Target Disk Drive Model	Capacity (MB)
[Please Select a Source Disk]		
Channel:ID	Drive Model	Capacity (MB)
1 : Master	QUANTUMCR8.4A	8063
2 : Master	QUANTUMCR8.4A	8063

[↑] Up [↓] Down [ESC] Exit [Ctrl-Y] Save

Step **4** Use the arrow keys to choose which drive contains the existing data to be copied.

Step **5** Press **<Ctrl-Y>** keys to Save selection and start duplication. The following progress screen will appear.

Start to duplicate the image . . .
Do you want to continue? (Yes/No)
Y - Continue N - Abort

Step **6** Select "Y" to continue. If you choose "N", you will be returned to Step 1.

Step **7** Once complete, the following screen will appear confirming that your Security array has been created. Press any key to reboot the system.

Array has been created.
<Press Any Key to Reboot>

Step **8** Proceed to install the drivers from the driver disk and/or the O/S.

Using FastBuild™ Configuration Utility

The FastBuild Configuration Utility offers several menu choices to create and manage the drive array on the Promise FastTRak100 Adapter. For purposes of this section, it is assumed that you have already created an array using one of the methods previously discussed, and that you wish to make a change to the array.

Viewing FastTrak100 BIOS Screen

When you boot your system with the FastTrak100 card and drives installed, the Promise onboard BIOS will detect the drives attached. If an array already exists, the following screen will be displayed:

```

                FastTrak100 (tm) BIOS Version 1.xx (Build xxxx)
                (c) 1995-2000 Promise Technology, Inc. All Rights Reserved.

ID   MODE      SIZE   TRACK-MAPPING   STATUS
1 *  2+0 Striped 16126M 611/128/32      Functional

Press <Ctrl-F> to enter FastBuild (tm) Utility....
```

Three possible conditions will be displayed under 'STATUS':

Functional - The array is operational

Critical - A mirrored array contains a drive that has failed or disconnected. The remaining drive member in the array is functional. However, the array has temporarily lost its ability to provide fault tolerance. The user should identify the failed drive through the FastBuild Setup Utility, and then replace the problem drive.

Offline - A mirrored array has 2 drives that have failed/disconnected or a striped array has 12 drive that has failed or been disconnected. When the array condition is "offline", the user must replace the failed drive(s), then restore the data from a backup source.

LAN Information

Your motherboard has (2) onboard Intel 82559 LAN controllers. LAN capabilities including 10/100 MBits/s transfer speed, optional Alert on LAN 2 chip (AOL 2), and optional Wake On LAN (WOL). For more information regarding the onboard LAN controllers, check the Intel website: <http://www.intel.com>

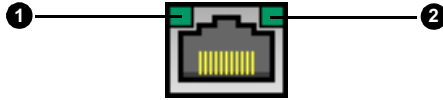

Below are some explanations of what the LEDs mean, and how they display the LAN's status.

LAN Status	LED (1) - Green/Orange Light	LED (2) - Yellow Light
Good connection @ 10 Mbps	LED (1) is GREEN	OFF
Good connection @ 100 Mbps	LED (1) is ORANGE	OFF
No connection	OFF	OFF
Data being transferred	Green (10Mbps) or Orange (100Mbps)	LED is blinking

Appendix II: Glossary

ACPI (Advanced Configuration and Power Interface): a power management specification that allows the operating system to control the amount of power distributed to the computer's devices. Devices not in use can be turned off, reducing unnecessary power expenditure.

AGP (Accelerated Graphics Port): a PCI-based interface which was designed specifically for demands of 3D graphics applications. The 32-bit AGP channel directly links the graphics controller to the main memory. While the channel runs at only 66 MHz, it supports data transmission during both the rising and falling ends of the clock cycle, yielding an effective speed of 133 MHz.

AMR (Audio Modem Riser): a modem that can be used on Intel Reference Motherboard platforms using Intel's core logic chipsets supporting AC-link 2.1. It supports fax and all data feedback modes. It provides high speed communications between your personal computer and a remote location, such as an Internet Service Provider (ISP).

AT: the original form factor of IBM's PC.

ATAPI (AT Attachment Packet Interface): also known as IDE or ATA; a drive implementation that includes the disk controller on the device itself. It allows CD-ROMs and tape drives to be configured as master or slave devices, just like HDDs.

ATX: the form factor designed to replace the AT form factor. It improves on the AT design by rotating the board 90 degrees, so that the IDE connectors are closer to the drive bays, and the CPU is closer to the power supply and cooling fan. The keyboard, mouse, USB, serial, and parallel ports are built-in.

Bandwidth: refers to carrying capacity. The greater the bandwidth, the more data the bus, phone line, or other electrical path, can carry. Greater bandwidth, then, also results in greater speed.

BBS (Bulletin Board System): a computer system with a number of modems hooked up to it which acts a center for users to post messages and access information.

BIOS (Basic Input/Output System): the program that resides in the ROM chip, and provides the basic instructions for controlling your computer's hardware. Both the operating system and application software use BIOS routines to ensure compatibility.

Buffer: a portion of RAM which is used to temporarily store data, usually from an application, though it is also used when printing, and in most keyboard drivers. The CPU can manipulate data in a buffer before copying it, all at once, to a disk drive. While this improves system performance --- reading to or writing from a disk drive a single time is much faster than doing so repeatedly --- there is also the possibility of losing your data should the system crash. Information stored in a buffer is temporarily stored, not permanently saved.

Bus: a data pathway. The term is used especially to refer to the connection between the processor and system memory, and between the processor and PCI or ISA local buses.

Bus mastering: allows peripheral devices and IDEs to access the system memory without going through the CPU (similar to DMA channels).

Cache: a temporary storage area for data that will be needed often by an application. Using a cache lowers data access times, since the needed information is stored in the SRAM instead of in the slow DRAM. Note that the cache is also much smaller than your regular memory: a typical cache size is 512KB, while you may have as much as 1GB of regular memory.

Cache size: refers to the physical size of the cache onboard. This should not be confused with the cacheable area, which is the total amount of memory which can be scanned by the system in search of data to put into the cache. A typical setup would be a cache size of 512KB, and a cacheable area of 512MB. In this case, up to 512KB of the main memory onboard is capable of being cached. However, only 512KB of this memory will be in the cache at any given moment. Any main memory above 512MB could never be cached.

Closed and open jumpers: jumpers and jumper pins are active when they are “on” or “closed”, and inactive when they are “off” or “open”.

CMOS (Complementary Metal-Oxide Semiconductors): chips that hold the basic startup information for the BIOS.

COM port: another name for the serial port, which is called as such because it transmits the eight bits of a byte of data along one wire, and receives data on another single wire (that is, the data is transmitted in serial form, one bit after another). Parallel ports transmit the bits of a byte on eight different wires at the same time (that is, in parallel form, eight bits at the same time).

DDR (Double Data Rate): improves RAM speed to at least 200 MHz. It activates output on both the rising and falling edge of the system clock rather than on just the rising edge, potentially doubling output.

DIMM (Dual In-line Memory Module): faster and more capacious form of RAM than SIMMs, and do not need to be installed in pairs.

DIMM bank: sometimes called DIMM sockets, because the physical slot and the logical unit are the same. That is, one DIMM module fits into one DIMM socket, which is capable of acting as a memory bank.

DMA (Direct Memory Access): channels that are similar to IRQs. DMA channels allow hardware devices (like soundcards or keyboards) to access the main memory without involving the CPU. This frees up CPU resources for other tasks. As with IRQs, it is vital that you do not double up devices on a single line. Plug-n-Play devices will take care of this for you.

Doze mode: in this mode, only the CPU's speed is slowed.

DRAM (Dynamic RAM): widely available, very affordable form of RAM which has the unfortunate tendency to lose data if it is not recharged regularly (every few milliseconds). This refresh requirement makes DRAM three to ten times slower than non-recharged RAM such as SRAM.

EDO RAM (Extended Data-Out RAM): speeds access to memory locations by assuming that memory addresses are static; the next time it looks for a bit of data, it will be at the same spot, or one nearby.

EEPROM (Electrically Erasable Programmable ROM): also called Flash BIOS, is a ROM chip which can, unlike normal ROM, be updated. This allows you to keep up with changes in the BIOS programs without having to buy a new chip. Tyan's BIOS updates can be found at <http://www.tyan.com>

ESCD (Extended System Configuration Data): a format for storing information about Plug-n-Play devices in the system BIOS. This information helps properly configure the system each time it boots.

Fault-tolerance: a term describing a system where one component can quickly be replaced without causing a loss of service, such as in a **RAID** system.

Firmware: low-level software that controls the system hardware.

Form factor: an industry term for the size, shape, power supply type, and external connector type of the Personal Computer Board (PCB) or motherboard. The standard form factors are the AT and ATX, although Tyan also makes some Baby-AT and ATX Footprint boards.

Global timer: onboard hardware timer, such as the Real-Time Clock (RTC).

Handshaking: a form of encryption. One system, typically the server, sends an encryption scheme to another agent, typically a client. Thus, the client's data is protected during transmittal to the server.

HDD: stands for Hard Disk Drive, a type of fixed drive.

H-SYNC: controls the horizontal synchronization/properties of the monitor.

IC (Integrated Circuit): the formal name for the computer chip.

IDE (Integrated Device/Drive Electronics): a simple, self-contained HDD interface. It can handle drives up to 8.4 GB in size. Almost all IDEs sold now are in fact Enhanced IDEs (EIDEs), with maximum capacity determined by the hardware controller.

IDE INT (IDE Interrupt): a hardware interrupt signal that goes to the IDE.

I/O (Input/Output): the connection between your computer and another piece of hardware (mouse, keyboard, etc.)

IRQ (Interrupt Request): an electronic request that runs from a hardware device to the CPU. The interrupt controller assigns priorities to incoming requests and delivers them to the CPU. It is important that there is only one device hooked up to each IRQ line; doubling up devices on IRQ lines can lock up your system. Plug-n-Play operating systems can take care of these details for you.

ISA (Industry Standard Architecture): a slower 8- or 16-bit bus (data pathway).

Latency: the amount of time that one part of a system spends waiting for another part to catch up. This is most common when the system sends data out to a peripheral device, and it waiting for the peripheral to send some data back (peripherals tend to be slower than onboard system components).

Mirroring: see **RAID**.

NVRAM: ROM and EEPROM are both examples of Non-Volatile RAM, memory that holds its data without power. DRAM, in contrast, is volatile.

OEMs (Original Equipment Manufacturers): Compaq or IBM package other companies' motherboards and hardware inside their case and sell them.

Parallel port: transmits the bits of a byte on eight different wires at the same time (that is, in parallel form, eight bits at the same time).

PCI (Peripheral Component Interconnect): a 32-bit local bus (data pathway) which is faster than the ISA bus. Local buses are those which operate within a single system (as opposed to a network bus, which connects multiple systems).

PCI PIO (PCI Programmable Input/Output) modes: the data transfer modes used by IDE drives. These modes use the CPU for data transfer (in contrast, DMA channels do not). PCI refers to the type of bus used by these modes to communicate with the CPU.

PCI-to-PCI bridge: allows you to connect multiple PCI devices onto one PCI slot.

Pipeline burst SRAM: a fast secondary cache. It is used as a secondary cache because SRAM is slower than SDRAM, but usually larger. Data is cached first to the faster primary cache, and then, when the primary cache is full, to the slower secondary cache.

Pipelining: improves system performance by allowing the CPU to begin executing a second instruction before the first is completed. A pipeline can be likened to an assembly line, with a given part of the pipeline repeatedly executing a set part of an operation on a series of instructions.

PM timers (Power Management timers): software timers that count down the number of seconds or minutes until the system times out and enters sleep, suspend, or doze mode.

PnP (Plug-n-Play): a design standard that has become ascendant in the industry. Plug-n-Play devices require little set-up to use. Novice end users can simply plug them into a computer that is running on a Plug-n-Play aware operating system (such as Windows 98), and go to work. Devices and operating systems that are not Plug-n-Play require you to reconfigure your system each time you add or change any part of your hardware.

Striping: see RAID.

RAID (Redundant Array of Independent Disks): a way for the same data to be stored in different places on many hard drives. By using this method, the data is stored redundantly, also the multiple hard drives will appear as a single drive to the operating system. RAID level 0 is known as striping, where data is striped (or overlapped) across multiple hard drives, but offers no fault-tolerance. RAID level 1 is known as mirroring, which stores the data within at least two hard drives, but does not stripe. RAID level 1 also allows for faster access time and fault-tolerance, since either hard drive can be read at the same time. RAID level 0+1 is both striping and mirroring, providing fault-tolerance, striping, and faster access all at the same time.

RAM (Random Access Memory): technically refers to a type of memory where any byte can be accessed without touching the adjacent data, is often used to refer to the system's main memory. This memory is available to any program running on the computer.

ROM (Read-Only Memory): a storage chip which contains the BIOS; the basic instructions required to boot the computer and start up the operating system.

SDRAM (Synchronous Dynamic RAM): called as such because it can keep two sets of memory addresses open simultaneously. By transferring data alternately from one set of addresses and then the other, SDRAM cuts down on the delays associated with non-synchronous RAM, which must close one address bank before opening the next.

Serial port: called as such because it transmits the eight bits of a byte of data along one wire, and receives data on another single wire (that is, the data is transmitted in serial form, one bit after another).

SIMM (Single In-line Memory Module): formerly the most common form of RAM for motherboards. They must be installed in pairs, and do not have the carrying capacity or the speed of DIMMs.

SIMM bank/socket: SIMM sockets are the physical slots into which you install SIMM modules. A pair of SIMM sockets form a SIMM bank, and act as one unit. If only one socket is filled, the bank will not operate.

Sleep/Suspend mode: in this mode, all devices except the CPU shut down.

SRAM (Static RAM): unlike DRAM, this type of RAM does not need to be refreshed in order to prevent data loss. Thus, it is faster, and more expensive.

Standby mode: in this mode, the video and fixed disk drive (usually the HDD) shuts down; all other devices continue to operate normally.

UltraDMA/33/66/100: a fast version of the old DMA channel. UltraDMA is also called UltraATA. Without the proper UltraDMA controller, your system cannot take advantage of the higher data transmission rates of the new UltraDMA/UltraATA HDDs.

USB (Universal Serial Bus): a versatile port. This one port type can function as a serial, parallel, mouse, keyboard, or joystick port. It is fast enough to support video transfer, and is capable of supporting up to 127 daisy-chained peripheral devices.

VGA (Video Graphics Array): the PC video display standard.

V-SYNC: controls the vertical properties of the monitor.

ZIF socket (Zero Insertion Force socket): these sockets make it possible to insert CPUs without damaging the sensitive CPU pins. The CPU is lightly placed in an open ZIF socket, and the metal level is pulled down. This shifts the processor over and down, guiding it into place on the board.

**Notice for the USA**

Compliance Information Statement (Declaration of Conformity Procedure) DoC
FCC Part 15: This device complies with Part 15 of the FCC Rules.

Operation is subject to the following conditions:

- 1) this device may not cause harmful interference, and
- 2) this device must accept any interference received including interference that may cause undesired operation. If this equipment does cause harmful interference to radio or television reception, which can be determined by turning the equipment off and on, the user is encouraged to try one or more of the following measures:
 - Reorient or relocate the receiving antenna.
 - Increase the separation between the equipment and receiver.
 - Plug the equipment into an outlet on a circuit different from that of the receiver.
 - Consult the dealer or an experienced radio/television technician for help.

Notice for Canada

This apparatus complies with the Class B limits for radio interference as specified in the Canadian Department of Communications Radio Interference Regulations. (Cet appareil est conforme aux normes de Classe B d'interférence radio tel que spécifié par le Ministère Canadien des Communications dans les règlements d'interférence radio.)

**Notice for Europe (CE Mark)**

This product is in conformity with the Council Directive 89/336/EEC, 92/31/EEC (EMC).

CAUTION: Lithium battery included with this board. Do not puncture, mutilate, or dispose of battery in fire. Danger of explosion if battery is incorrectly replaced. Replace only with the same or equivalent type recommended by manufacturer. Dispose of used battery according to manufacturer instructions and in accordance with your local regulations.