

## Table Of Contents

<b>1. Introduction.....</b>	<b>3</b>
1.1 Overview.....	3
1.2 Hardware Specifications.....	4
1.3 Software Specifications.....	5
1.4 Environment.....	5
<b>2. Board Installation.....</b>	<b>6</b>
2.1 Unpacking.....	6
2.2 Installation.....	7
<b>3. S1468 On Board Resource Setting.....</b>	<b>8</b>
3.1 S1468 Board Layout & Jumper Location .....	8
3.2 Quick Reference for Jumpers.....	9
3.3 CMOS RTC.....	12
3.4 Speaker Connect.....	12
3.5 Turbo Switch.....	12
3.6 Turbo LED Connect.....	12
3.7 Reset Connector.....	13
3.8 Flash EPROM Jumpers.....	13
3.9 CMOS & Password Reset.....	13
3.10 DRAM Installation.....	14
3.11 CPU Installation.....	15
3.12 Upgrading Cache Memory.....	16
3.13 Understanding Different Clock Speeds.....	17
3.14 Peripheral Device Installation.....	18
3.15 Turbo/Non-Turbo hotkeys.....	18
3.16 Connecting The Power Supply.....	19
<b>4. BIOS Configuration.....</b>	<b>21</b>
4.1 Entering Setup.....	21
4.2 Control Keys.....	22
4.3 Getting Help.....	23
4.4 The Main Menu.....	23
4.5 Standard CMOS Setup Menu.....	25
4.6 BIOS Features Setup.....	28
4.7 Chipset Features Setup.....	31
4.7.1 Power Management Setup.....	36
4.8 PCI Slot Configuration.....	38
4.9 Load Setup Defaults.....	40
4.10 Password Setting.....	40
4.11 IDE HDD Auto Detection.....	42
4.12 Save & Exit Setup.....	42
4.13 Keyboard Setting Functions.....	43

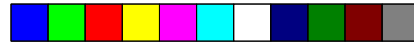

<b>5. AMI WinBIOS.....</b>	<b>44</b>
5.1 Standard Setup Options.....	44
5.2 Advanced Setup.....	45
5.3 Advanced Chipset.....	48
5.4 Power Management.....	50
5.5 Peripheral.....	51
5.6 Utility.....	52
5.7 Security.....	52
5.8 Defaults.....	52
<b>6. Flash Writer Utility.....</b>	<b>53</b>
6.1 The Flash Memory Writer Utility Screen.....	55
<b>7. AT Technical Information.....</b>	<b>56</b>
7.1 I/O Bus Connector Pin Out.....	56
7.1.1 ISA Slot Pin Out.....	56
7.1.2 PCI-Bus Slot Pin Out.....	57
7.2 Timer & DMA Channel Map.....	58
7.3 Interrupt Map.....	58
7.4 RTC & CMOS Ram Map.....	59
<b>Appendix A. Post Codes.....</b>	<b>60</b>



Information presented in this publication has been carefully checked for reliability; however, no responsibility is assumed for inaccuracies. The information contained in this document is subject to change without notice.

**Trademarks**

Award BIOS/Flash are trademarks of Award Software International Inc.  
 AMI BIOS is a trademarks of American Megatrends Inc.  
 IBM,PC,AT,PS/2 are trademarks of IBM Corporation  
 INTEL,Pentium are trademarks of Intel Corporation.



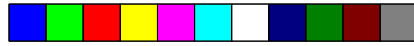

# 1. Introduction

## 1.1 Overview

The S1468 is a quality, high performance mainboard based on the powerful Intel Pentium microprocessors. This mainboard is designed around the latest and fastest Intel Triton chipset and can support CPU speeds of 75MHz through 166MHz.

The S1468's PCI Local Bus provides high performance capabilities that are ideal for a wide range of demanding applications such as: CAD, CAM, CAE, networking, multi-user environments, database management, desktop publishing, image processing and 3D animation.

This integrated system board achieves the highest reliability and yet is small enough for all of its features to be supported in a "Baby-AT" form-factor. Some of the features included are: on-board dual channel PCI IDE, on-board floppy controller, on-board high speed I/O, and support for either pipeline-burst or standard asynchronous SRAM.

Flexibility and expandability have been designed into the S1468. With I/O and drive controller support built on-board, the four PCI and five ISA (One ISA and one PCI as a shared slot) slots are free for any add-on expansion cards. Unlike most Triton based mainboards that have only four SIMM sockets, the S1468 supports six SIMM sockets for a more flexible memory configuration. The S1468's VRM (Voltage Regulator Module) will support future Pentium CPU's that may require less Voltage than the current Pentiums.

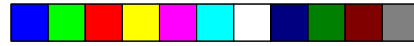

## 1.2 Hardware Specifications/Features

- ◆CPU Intel Pentium 75 MHz thru 166 MHz (Socket 7)
- ◆Coprocesor On-chip floating point unit
- ◆Speed 50/60/66 MHz system bus  
25/30/33 MHz PCI bus  
7.5/8.33 MHz ISA bus speed
- ◆DRAM 3 double banks of 72 pin SIMM sockets  
Supports 5V or 3.3V memory  
Supports EDO(Exended Data Out) DRAMs  
Supports Fast Page Mode DRAMs  
Supports 8MB to 128MB of DRAMs
- ◆L2 Cache 16KB cache memory included in Pentium  
256/512KB on board 2nd level cache memory  
Supports either synchronous pipeline-burst or  
standard asynchronous SRAM.
- ◆EIDE Controller Primary and secondary PCI EIDE channels on  
board for support of up to four EIDE Mode 0  
through Mode 4 drives.
- ◆Enhanced I/O Multi-mode bi-directional parallel port that  
supports standard, EPP and ECP modes.  
Supports 16550 compatible Uarts for on-board  
high speed serial ports.  
Support for an IrDA comliant Infra Red inter-  
face.  
On-board floppy controller
- ◆I/O Bus Slots 4 Master/Slave PCI-Bus  
5 ISA Bus (One ISA and one PCI shared slot)
- ◆Shadow RAM Main and Video shadow function is program-  
mable.  
Main and Video caching function is program-  
mable.

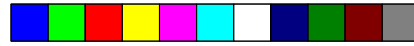

- ◆Mouse On-board PS/2 mouse connector.

### 1.3 Software Specifications

- ◆BIOS Licensed Award or AMI BIOS  
AT CMOS setup, BIOS/CHIPSET setup,  
and hard disk utility included.  
Support for easy BIOS upgrades with flash  
EPROM chip.
- ◆O.S. Operates with MS-DOS, Windows 3.x, Windows  
for Work Group 3.x, Windows 95, Windows NT  
OS/2, Novell Netware, Novell UnixWare, and  
SCO Unix.

### 1.3 Environment

Ambient Temperature	0 to +50 C (operating)
Relative Humidity	0 to +85% (operating)
Altitude	0 to 10,000 feet (operating)
Vibration	0 to 1,000 Hz
Voltage	4.9 to 5.2 V

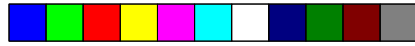

## 2. Board Installation

### 2.1 Unpacking

The mainboard package should contain the following:

- ◆S1468 Mainboard
- ◆One IDE 40 pin cables
- ◆Two serial cables
- ◆One parallel cable
- ◆One 34 pin floppy cable
- ◆User's Manual

The mainboard contains sensitive electric components which can be easily damaged by static electricity, so the mainboard should be left in its original packaging until it is ready to be installed.

Unpacking and installation should be done on a grounded anti-static mat. The operator should be wearing an anti-static wristband, grounded at the same point as the anti-static mat.

Inspect the main board carton for obvious damage. Shipping and handling may cause damage to your board. Be sure there are no shipping and handling damage on the board before proceeding.

After opening the mainboard carton, extract the system board and place it only on a grounded anti-static surface, component side up. Again inspect the board for damages. Press down on all of the socket IC's to make sure that they are properly seated. Do this only with the board placed on an anti-static mat.

**DO NOT APPLY POWER TO THE BOARD IF IT HAS BEEN DAMAGED!**

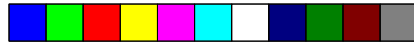

## 2.2 Installation

You are now ready to install your mainboard. The mounting hole pattern of the S1468 matches the IBM-AT system board spec. It is assumed that the chassis is designed for a standard IBM XT/AT mainboard.



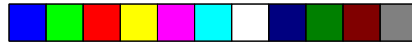

### 3. On Board Resource Setting

#### Figure 3.1 S1468 Board Layout

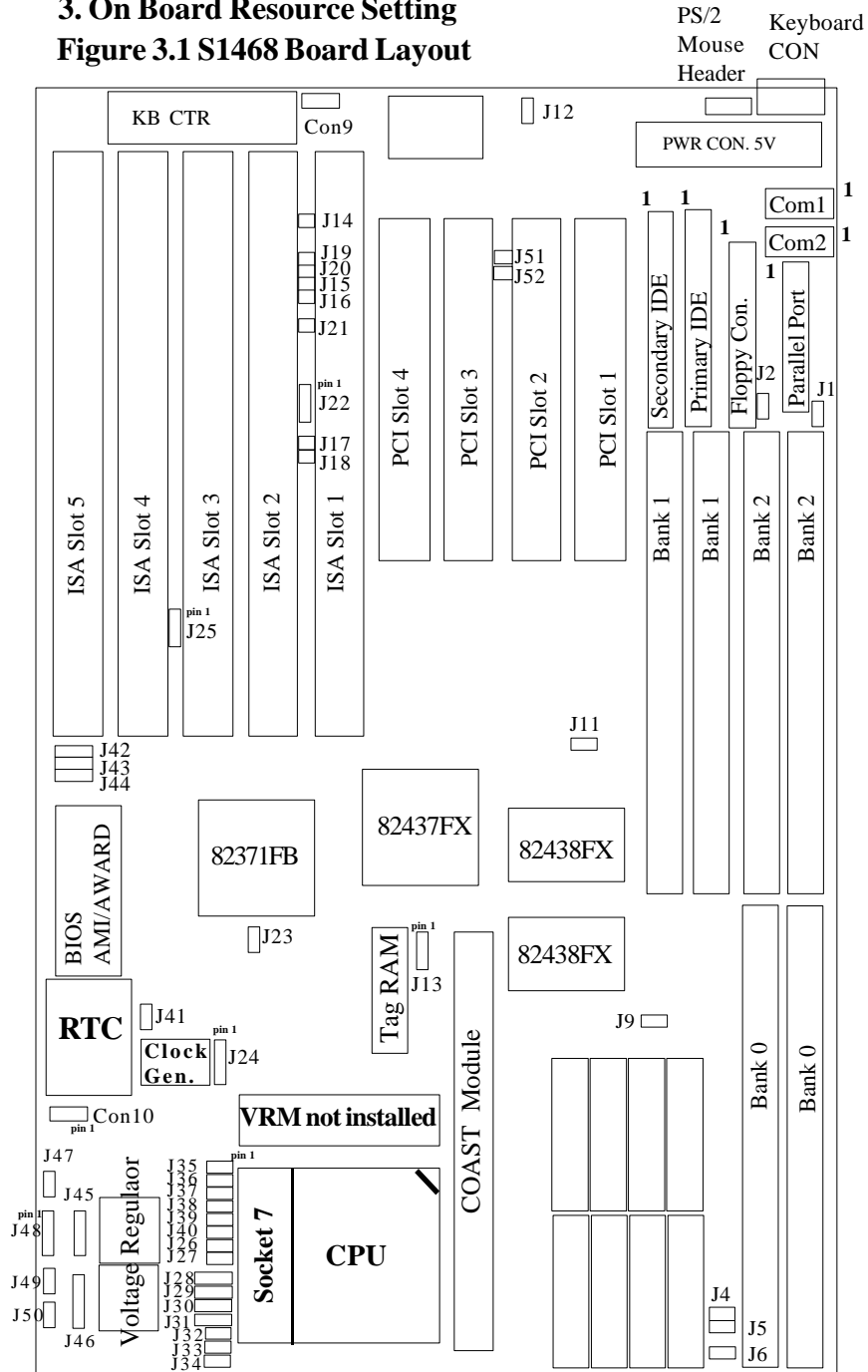



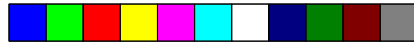

### 3.2 Jumper Settings

#### CPU Speed:

	<b>J24</b>	<b>J32</b>	<b>J33</b>	<b>CPU Speed</b>
	1-2, 3-4	Off	Off	75 MHz
	3-4	Off	Off	90 MHz
	1-2	Off	Off	100 MHz
	3-4	On	Off	120 MHz
	1-2	On	Off	133 MHz
	3-4	On	On	150 MHz
	1-2	On	On	166 MHz

**Memory Voltage:** 5 volts is the default. Some EDO memory uses 3.3volts.

Damage to system can result if these are set incorrectly!

	<b>Volts</b>	<b>J1</b>	<b>J2</b>	<b>J9</b>	<b>J11</b>	<b>J4</b>	<b>J5</b>	<b>J6</b>
Default	<b>5V</b>	On	On	On	On	Off	Off	Off
	<b>3.3V</b>	Off	Off	Off	Off	On	On	On

#### Cache Size:

<b>Size</b>	<b>J13</b>
512KB	1-2
256KB	2-3

**On Board Cache:** Used to specify type of cache being used.

<b>J28</b>	<b>J29</b>	<b>J30</b>	<b>J31</b>	<b>Size</b>
2-3	1-2	2-3	1-2	512KB
1-2	2-3	2-3	1-2	256KB
1-2	1-2	1-2	1-2	COAST Module

#### CMOS Reset: J41

Off: Normal operation(Default)

On: Clears password and resets CMOS

◆With power off, put jumper on J41 for about 10 seconds.

◆Remove jumper and power system on and the CMOS will be reset.



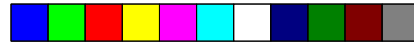

### AT Clock Timing: J22

Pins 2-3: Normal AT clock timing (Default)  
Pins 1-2: Do not use.

### Speaker Connector: J45

Pinout Assignments	
1	Speaker out
2	Ground
3	Ground
4	+ 5V

### Keylock Connector: J46

Pinout Assignments	
1	Led Output
2	No Connect
3	Ground
4	Keylock
5	Ground

### Turbo Switch: J47

Open for Turbo
Close for Non-Turbo

### HDD LED: J48 (Only pins 1 and 2 are used)

Pinout Assignments	
1	Cathode
2	Anode

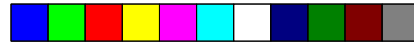

### Reset Connector: J49

Pinout Assignment	
1	Power Good
2	Ground

### Turbo LED Connector: J50

Pinout Assignment	
1	Cathode
2	Anode

### Flash EPROM: J42, J43 and J44

These jumpers should be left at the factory default.

J42	1-2
J43	1-2
J44	1-2

### Voltage Regulator: J35, J36, J37, J38, J39, J40, J26 and J27.

Ignore these setting if your board has these jumpers hardwired.

**Do not change these jumpers!**

**CPU can be damaged if these are set incorrectly.**

	J35	J36	J37	J38	J39	J40	J26	J27	
STD	Off	Off	On	Off	Off	On	On	On	Default
STD/VRE/VR	Off	On	Off	Off	On	Off	On	On	
VRE	On	Off	Off	On	Off	Off	On	On	

STD/VRE will work with most Pentium CPUs

### Infra Red Interface: Con9 and Con10

Pinout	Assignment
1	Signal In
2	Gnd
3	Signal Out
4	VCC

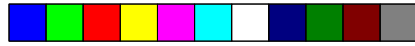

### 3.3 CMOS RTC

CMOS RTC includes an internal battery and Real Time Clock circuit. It provides the date and the time for the system. Normally the life span of a RTC internal battery is 10 years. When replacing, you should use the same model.

### 3.4 Speaker Connector Installation

S1468 provides a 4-Pin header (J45) to connect the speaker. The polarity can go either way.

### 3.5 Turbo Switch

The front panel on your case may have a turbo switch to control system speed when slower program execution is required for software developed in the old XT days.

You can connect the chassis turbo switch to J47 on the mainboard. The Triton chipset doesn't support a hardware turbo function so this switch will only turn on or off the turbo LED. You need to use the hot key of <Ctrl> + <Alt> + <-> for slow speed and <Ctrl> + <Alt> + <+> for high speed.

### 3.6 Turbo LED Connector Installation

The TURBO LED on the front case panel can indicate the current speed status of the system. The TURBO LED connector should be installed to J50 in the correct direction.

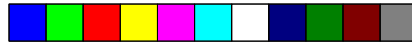

### 3.7 Hardware Reset Switch Connector Installation

The RESET switch on your cases' display panel provides users with the HARDWARE RESET function which is the same as power on/off. The system will do a cold start after the RESET switch is pushed by the user. The RESET switch is a 2 pin connector and should be installed on jumper J49.

### 3.8 Flash EPROM-Jumper J42, J43 and J44

The S1468 uses flash memory to store BIOS programs. It can be updated as new versions of the BIOS becomes available. The flash utility will guide you through the process step by step.

J42, J43, and J44 determines which type of EPROM is used. These jumpers have been set to match the on board BIOS chip. The factory default for the S1468 is on pins 1-2. Depending on the type of EPROM used, some boards will have J42 on pins 2-3.

**Refer to chapter 6 for Flash EPROM upgrade procedures.**

### 3.9 Hardware CMOS & Password Reset

(The following steps are valid provided the board has a DS12887A RTC)

If you have been locked out of your system because you forgot your password or set the CMOS incorrectly, follow the instructions below.

- a. Power off the system
- b. Short jumper J41.
- d. Wait for 5 seconds then remove the jumper from J41.
- e. Then power on the system again.

By doing the above procedures, your password will be erased and the CMOS will be reset to the BIOS default.

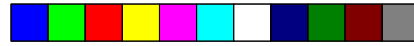

### 3.10 DRAM Installation

The S1468 uses a 64-bit data path from memory to CPU and can accommodate up to 128 MB of RAM. The mainboard supports both standard and EDO (Extended Data Out) 72 pin SIMMs. All installed memory will be automatically detected so there is no need to set jumpers.

- ◆ SIMM modules must be installed in pairs.
- ◆ Each pair of SIMMs must be of the same size and type.
- ◆ The mainboard supports 1, 2, 4 and 8MBx32 SIMMs.
- ◆ Bank 0 only supports single sided SIMMs.
- ◆ Bank 1 and 2 can use either double or single sided SIMMs.
- ◆ Two SIMMs must be installed in any bank for the system to POST.
- ◆ The table below shows some of the available memory configurations.

Bank 1	Bank2	Bank0	Total Memory
1MBx32	none	none	8MB
1MBx32	1MBx32	none	16MB
1MBx32	1MBx32	1MBx32	24MB
2MBx32	none	none	16MB
2MBx32	1MBx32	none	24MB
2MBx32	1MBx32	1MBx32	32MB
2MBx32	2MBx32	none	32MB
2MBx32	2MBx32	1MBx32	40MB
4MBx32	none	none	32MB
4MBx32	2MBx32	none	48MB
8MBx32	4MBx32	1MBx32	104MB
8MBx32	8MBx32	none	128MB

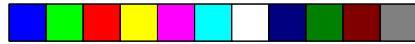

### 3.11 CPU Installation

Several types of CPUs (75 thru 166 MHz) can be used on S1468. Please refer to the previous pages for the correct CPU jumper settings for your board.

- ◆ The CPU is a sensitive electronic component and it can be easily damaged by static electricity. Do not touch the CPU pins with your fingers.
- ◆ When installing the CPU into the socket, match the CPU pins to the socket pins.
- ◆ Before the CPU is installed, the mainboard must be placed on a flat plane in order to avoid being broken by the pressure of CPU insertion.
- ◆ **A cooling fan and heat sink assembly is required to protect the CPU from being damaged.**

1. Make sure the ZIF socket lever is up. To raise the lever, pull it out to the side a little and raise it as far as it will go. The top plate will slide back.
2. Align the CPU and socket Pin 1 corners. The pins on the bottom should align with the rows of holes in the socket.
3. Insert the CPU in the socket. It should insert easily. If it does not, adjust the position of the lever a little.
4. Press the lever down. The top plate will slide forward. You will feel some resistance as the pressure starts to secure the CPU in the socket. This is normal and will not damage the CPU. When the CPU is installed, the lever should snap into place at the side of the socket.

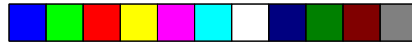

### 3.12 Upgrading Cache Memory

The S1468 can support either standard SRAM or synchronous pipeline burst SRAM. The standard SRAM configuration would use either eight pieces of 32Kx8(256KB cache) or eight pieces of 64Kx8(512KB cache).

For the synchronous pipeline burst cache configuration, a "COAST Module" is plugged into the "COAST Module" connector that is located between the CPU and the standard SRAM socket. To enable the "COAST Module", you must set the jumpers to pins 1-2 for J28, J29, J30 and J31.

- ◆ Refer to page 9 for the cache jumper settings.
- ◆ When using the "COAST Module", the standard SRAM sockets must be empty and the Tag RAM socket must be empty.
- ◆ The "COAST Module" pipeline burst cache unit comes in either 256KB or 512KB sizes and has a built in Tag RAM chip.
- ◆ The "COAST Module" will only fit in the "Coast Socket" one way and should install easily.
- ◆ When upgrading standard SRAM to 512KB, you will need to set the jumpers and use eight 64Kx8 chips.
- ◆ The tag RAM chip doesn't need to be changed when upgrading to 512KB of standard SRAM.



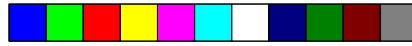

### 3.13 Understanding The Different Clock Speeds

The following chart shows the different CPU, mainboard and PCI frequencies. As you may have noticed, all the Intel Pentium CPUs use an internal clock multiplier(x3, x2.5, x2 or x1.5 Motherboard speed).

Pentium Internal Clock	Mainboard Clock	PCI Bus Clock
75 MHz	50 MHz	25 MHz
90 MHz	60 MHz	30 MHz
100 MHz	66.67 MHz	33 MHz
120 MHz	60 MHz	30 MHz
133 MHz	66.67MHz	33 MHz
150 MHz	60 MHz	30 MHz
166 MHz	66.67 MHz	33 MHz

In the table above, the 50, 60 and 66.67 MHz figures are oscillator speeds that establish the external clock speed. The PCI Bus clock speed is fixed at one half of the mainboard clock speed. The 150MHz Pentium when set for 2.5x mode will achieve a 30MHz PCI bus speed but if it is set for 3x mode you will get a slower 25MHz PCI bus speed.

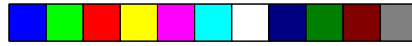

### 3.14 Peripheral Device Installation

After all the jumpers on the mainboard have been set, the it can be mounted into the case. Then proceede in installing the display card and any other peripheral devices.

If a PCI-Bus interface card is to be installed in the system, any one of the four PCI-Bus slots can support either a Master or a Slave device.

After installing the peripheral controller, the user should check everything again, and prepare to power-on the system.

### 3.15 Turbo / Non-Turbo hotkeys

press <Ctrl> + <Alt> + <-> : turn off turbo function.

press <Ctrl> + <Alt> + <+> : turn on turbo function.



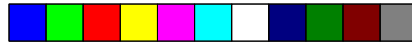

### 3.16 Connecting the Power Supply

The system power supply connectors on the mainboard is for a 5 volt power supply. Incorrect installation of the power supply could result in serious damage to the system board and connected peripherals.

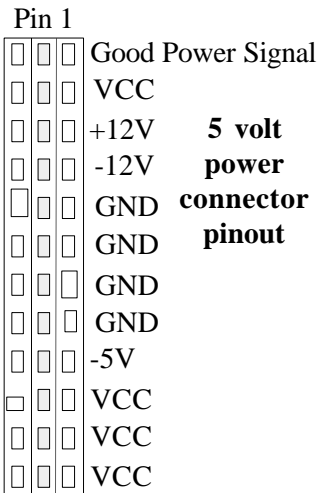

To connect the leads from either voltage power supply, you should first make sure the power supply is unplugged. Most power supplies have two leads. Each lead has six wires, two of which are black.

**Orient the connectors so the black wires are in the middle of the 5V power supply.**

**Caution: Some power supplies also include "3V" connectors. The connection wires normally have two colors with 3 black wires on one side. Please be very careful. Don't to use the wrong connector.**

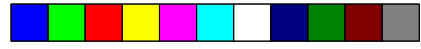

Align the plastic guide pins on the lead cables to their receptacles on the mainboard. You may need to hold the lead at an angle to line it up. Once you have the guide pins aligned, press the lead connector so that the plastic clips on the lead snap into place and secure the lead to the connector.

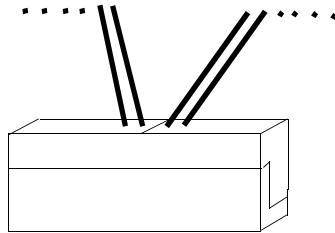

Connecting 5V power supply

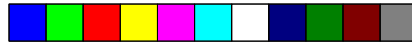

## 4. BIOS Configuration

Award's BIOS has a built in setup program that allows the user to modify the basic system configuration. This type of information is stored in the battery-backed CMOS SRAM. **Entering incorrect information or forgetting your password can lock you out of your system.(refer to 3.15 for resetting of CMOS)**

### 4.1. Entering Setup

Power ON the computer and press <Del> immediately and you will enter Setup. The other way to enter setup is to power on the computer, when the below message appears briefly at the bottom of the screen during the post (Power On Self Test), press <Del> key or simultaneously press <Ctrl>, <Alt>, and <Esc> keys.

\* TO ENTER SETUP BEFORE BOOT PRESS CTRL-ALT-ESC OR DEL KEY

If the message disappears before you respond and you wish to enter Setup, restart the system by turning it OFF then ON or by pressing "Reset" on the system case. You may also restart by simultaneously pressing <Ctrl>, <Alt>, and <Del> keys. If you do not press the keys at the correct time, the system will not boot and an error message will appear on the screen. You will be asked to,

\* PRESS F1 TO CONTINUE, CTRL-ALT-ESC OR DEL TO ENTER SETUP.

Figure 4.1 will appear on the screen. The Main Menu allows you to select from the 8 setup functions and 2 exit choices. Use the arrow keys to select among the items and press <Enter> to accept or enter the sub-menu.

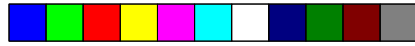

## 4.2. Control Keys

PgUp key	Increases the numeric value or make changes
PgDn key	Decreases the numeric value or make changes
F1 key	General help, only for Status Page Setup menu and Option Page Setup Menu
F2 key	Change color from a total of 16 colors
F3 key	Calendar, only for Status Page Setup Menu
F4 key	Reserved
F5 key	Restore the previous CMOS value, only for Option Page Setup Menu
F6 key	Load defaults
F8 key	Reserved
F9 key	Reserved
F10 key	Save all CMOS changes, only for Main Menu



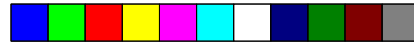

### 4.3. Getting Help

#### 4.3.1. Main Menu

The on-line description of the highlighted setup function is displayed at the bottom of the screen.

#### 4.3.2. Setup Page menu/Option Page Setup Menu

Press F1 to pop up a small help window that describes the appropriate keys to use and the possible selections for the highlighted items. To exit the Help Window, press <Esc>.

### 4.4. The Main Menu

Once you enter the Award BIOS CMOS Setup Utility, the Main Menu (Figure 4.1) will appear on the screen. The Main Menu allows you to select from the eight setup functions and 2 exit choices. Use the arrow keys to select among the items and press <Enter> to accept or enter the sub-menu.

**Figure 4.1: Main Menu**

ROM ISA BIOS (2A59CT51)  
CMOS SETUP UTILITY  
AWARD SOFTWARE, INC.

STANDARD CMOS SETUP	LOAD SETUP DEFAULTS
BIOS FEATURED SETUP	PASSWORD SETTING
CHIPSET FEATURES SETUP	IDE HDD AUTO DETECTION
POWER MANAGEMENT	SAVE & EXIT SETUP
PCISLOT CONFIGURATION	EXIT WITHOUT SAVING
LOAD BIOS DEFAULTS	
ESC : Save & Exit Setup F10 : Quit	
↑ ↓ → ← :Select Item (Shift)F2 :Change Color	
Time, Date, Hard Disk Type,.....	

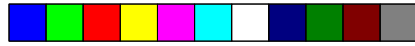

- ◆ **Standard CMOS setup**

This setup page includes all the items in a standard compatible BIOS.

- ◆ **BIOS features setup**

This setup page includes all of the enhanced features of Award's BIOS.

- ◆ **Chipset features setup**

This setup page includes all the items of the Intel Triton chipset features.

- ◆ **Power Management Setup**

Change, set, or disable system power management options

- ◆ **PCI slot configuration**

This setup page allows you to modify the configuration of PCI slot parameters.

- ◆ **Load setup defaults**

BIOS defaults indicate the most appropriate values of each system parameter for your system.

- ◆ **Password setting**

Change, set, or disable password. It allows you to limit access to the system and Setup.

- ◆ **IDE HDD auto detection**

Automatically configure hard disk parameters.

- ◆ **Save and exit setup**

Save changes to CMOS and exit setup

- ◆ **Exit without saving**

Abandon all CMOS changes and exit setup.



## 4.5. Standard CMOS Setup Menu

The items in Standard CMOS Setup Menu (Figure 4.2) are divided into 9 categories. Each category includes one or more setup items. Use the arrows to highlight the item and use the <PgUp> or <PgDn> keys to select the value you want for each item.

**Figure 4.2: Standard CMOS Setup Menu**

ROM ISA BIOS (2A59CT51)																	
STANDARD CMOS SETUP																	
AWARD SOFTWARE, INC.																	
Date (mm:dd:yy) : Tue, Dec 7 1995																	
Time (hh:mm:ss) : 18 : 01 : 38																	
	Type	Size	CYLS.	HEADS.	PRECOMP.	LANDZONE	SECTORS										
Primary Master :	none	0mb	0	0	0	0	0										
Primary Slave:	none	0mb	0	0	0	0	0										
Secondary Master:	none	0mb	0	0	0	0	0										
Secondary Slave:	none	0mb	0	0	0	0	0										
Drive A : 1.44 M, 3.5 in.				<table border="1"> <tr> <td>Base Memory:</td> <td>640 K</td> </tr> <tr> <td>Extended Memory:</td> <td>7168 K</td> </tr> <tr> <td>Expanded Memory:</td> <td>0 K</td> </tr> <tr> <td>Other Memory:</td> <td>384 K</td> </tr> <tr> <td>Total Memory:</td> <td>8192 K</td> </tr> </table>				Base Memory:	640 K	Extended Memory:	7168 K	Expanded Memory:	0 K	Other Memory:	384 K	Total Memory:	8192 K
Base Memory:	640 K																
Extended Memory:	7168 K																
Expanded Memory:	0 K																
Other Memory:	384 K																
Total Memory:	8192 K																
Drive B : 1.2 M, 5.25 in.																	
Video : EGA/VGA																	
Halt On : All errors																	
ESC: Quit		↑ → ↓ ← : Select Item		PU/PD/+/-: Modify													
F1: Help		(Shift)F2: Change Color		F3: Toggle Calendar													

### ◆ Date

The date format is <month>, <day>, <year>. Press <F3> to show the calendar.

### ◆ Time

The time format is <hours>, <minutes>, <seconds>. The time is calculated based on the 24-hour military-time clock. For example 1 p.m. is 13:00:00.

Day	The day, from Sun to Sat, Determined by the BIOS date, month and year entries.
Date	The date, from 1 to 31 (or maximum allowed in a month)
Month	The month, Jan to Dec.
Year	The year, from 1900 to 2099

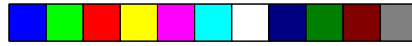

◆ **Primary/Secondary Drive type**

This category identifies the types of hard disk drives that have been installed in the computer. There are 46 predefined types and a user definable type.

Press PgUp or PgDn to select a numbered hard disk type or type a number and press <Enter>. Note that the specifications of your drive must match with the drive table. The hard disk will not work properly if you enter improper information for this category. If your hard disk type is not listed, you can Type User to define your own drive manually.

If you select Type User, you will be asked to enter the following info. Enter the paramters directly from the keyboard and press <Enter>. The hard disk information should be provided in the documentation from the hard disk vendor or the system manufacturer.

CYLS	number of cylinders
HEADS	number of heads
PRECOMP	written precom
LANDZONE	landing zone
SECTORS	number of sectors

If a hard disk has not been installed or you have a CD-ROM/Tape drive connected to an IDE channel, select NONE and press <Enter>.

◆ **Drive A type/Drive B type**

This category identifies the types of floppy disk drive A or B, that have been installed in your computer.

None	No floppy drive installed
360K, 5.25 in.	5-1/4 inch PC-type standard drive; 360 kilobyte capacity
1.2M,5.25 in.	5-1/4 inch AT-type high-density drive; 1.2 megabyte capacity
720K, 3.5 in.	3-1/2 inch double-sided drive; 720 kilobyte capacity
1.44M, 3.5 in.	3-1/2 inch double-sided drive; 1.44 megabyte capacity
2.88M, 3.5 in.	3-1/2 inch double-sided drive; 2.88 megabyte capacity



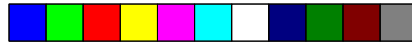

◆ **Video**

This category detects the type of graphics adapter used for the primary display system. It must match your video display card and monitor. Although secondary monitors are supported, you do not have to select that type in setup.

EGA/VGA	Enhanced Graphics Adapter/Video Graphics Array. For VGA,SVGA, or PGA monitor adapters.
CGA 40	Color Graphics Adapter, power up in 40 column mode.
CGA 80	Color Graphics Adapter, power up in 80 column mode.
Mono	Monochrome adapter, includes hi-res monochrome.

◆ **Halt On**

The category determines whether the computer will stop if an error is detected during power up.

No errors	Whenever the BIOS has detected a non-fatal error, the system will be stopped and you will be prompted.
All errors	The system boot will not be stopped for any errors that are detected.
All, but Keyboard	The system boot will not stop for a keyboard error;it will stop for all other errors.
All, but Diskette	The system boot will not stop for disk errors; it will stop for all other errors.
All, but Disk/Key	The system boot will not stop for a keyboard or disk error; it will stop for all other errors.

◆ **Memory**

The category is for display-only and it is determined by POST Power On Self Test of the BIOS.

Base Memory

The POST of the BIOS will determine the amount of base (or conventional) memory installed in the system. The value of the base memory is typically 640K.

Extended Memory

The BIOS determines how much extended memory is present during the POST. This is the amount of memory located above 1MB in the CPU's memory address map.

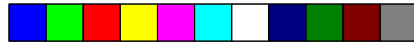

### Expanded Memory

Expanded Memory (EMS) defines a 64 K page frame in the area between 640K and 1Mb containing four 16K pages that are windows into the EMS memory. Programs issue requests to the EMS manager to switch the page to any part of EMS memory. Extended memory can be converted to emulate EMS by using a memory manager such as EMM386 that ships with Windows and DOS.

### Other Memory

This refers to memory located in the 640K to 1024K address space. This memory can be used for different applications. DOS uses this area to load device drivers to keep as much conventional memory free for application programs as possible.

## 4.6. BIOS FEATURES SETUP



### ROM ISA BIOS BIOS FEATURES SETUP AWARD SOFTWARE, INC.



Virus Warning	:Enabled	Video BIOS Shadow	:Enabled
CPU Internal Cache	:Enabled	C8000-CBFFF Shadow	:Disabled
External Cache	:Enabled	CC000-CFFFF Shadow	:Disabled
Boot Sequence	:A,C	D0000-D3FFF Shadow	:Disabled
Swap Floppy Drive	:Disabled	D4000-D7FFF Shadow	:Disabled
Boot Up Floppy Seek	:Enabled	D8000-DBFFF Shadow	:Disabled
Boot Up NumLock Status	:On	DC000-DFFFF Shadow	:Disabled
Memory Parity Check	:Enabled		
Gate A20 Option	:Fast		
Typematic Rate Setting	:Disabled		
Typematic Rate (Chars/sec)	:6		
Typematic Delay (msec)	:250		
Security Option	:Setup		
		ESC :Quit ↑ ↓ → ← :Select Item	
		F1 :Help PU/PD/+/- :Modify	
		F5 :Old Values (Shift)F2 :Color	
		F6 :Load BIOS Defaults	
		F7 :Load Setup Defaults	



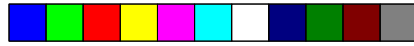

◆ **Virus warning**

This category flashes on screen. During and after the system boot up, any attempt to write to the boot sector or the partition table of the hard disk drive will halt the system and the following error message will appear. In the meantime, you can run an anti-virus program to locate the problem. Default value is Enabled.

Enabled	Activate automatically when the system boots up causing a warning message to appear when anything attempts to access the boot sector or hard disk partition table.
Disable	No warning message to appear when anything attempts to access the boot sector or hard disk partition table.

◆ **CPU Internal Cache/External Cache**

These two categories speed up the memory access. However, it depends on the CPU/Chipset design. Default value is Enabled.

Enabled	Enables the cache
Disabled	Disables the cache

◆ **Boot Sequence**

This category determines which drive the computer searches first for the disk operating system (i.e. DOS). Default value is A,C.

A,C	System will first search for floppy disk drive then hard disk drive.
C,A	System will first search for hard disk drive then floppy disk drive

◆ **Swap Floppy Drive**

Default value is Disabled

Enabled	Floppy A & B will be swapped under DOS
Disable	Floppy A & B will be normal definition.

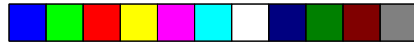

◆ **Boot Up Floppy Seek**

During POST, the BIOS will determine if the floppy disk drive installed is 40 or 80 tracks. 360K type is 40 tracks while 720K, 1.2M and 1.44M are all 80 tracks. Default value is Enabled

Enabled	BIOS searches for floppy disk drive to determine if it is 40 or 80 tracks. Note that the BIOS cannot tell from 720k, 1.2M or 1.44M drive type as they are all 80 tracks
Disabled	BIOS will not search for the type of floppy disk drive by track number. Note that there will not be any warning messages if the drive installed is 360K

◆ **Boot Up NumLock Status**

Default value is On

On	Keypad is number keys
Off	Keypad is arrow keys

◆ **Memory Parity Check**

The default value is disabled

◆ **Gate A20 Option**

Gate A20 controls the ability to access memory addresses above 1 MB by enabling (Fast) or disabling (Normal) access to the processor. Default value is Fast

◆ **Typematic Rate Setting, Typematic Rate (char/sec), and Typematic Delay.**

Typematic Rate Setting enables or disables the following two options. The Typematic Rate (6, 8, 10, 12, 15, 20, 24, or 30 characters per second) and Typematic Rate Delay (250, 500, 750, or 1000 milliseconds) control the speed at which the keystroke is repeated. The selected character is displayed when a key is held down after a delay set by the Typematic Rate Delay. It then repeats at a rate set by the Typematic Rate.

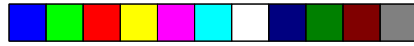

#### ◆ Security Option

This category allows you to limit access to the system setup, or just setup. Default value is Setup

System	The system will not boot and access to Setup will be denied if the correct password is not entered at the prompt
Setup	The system will boot, but access to setup will be denied if the password is not entered at the prompt

#### ◆ Video BIOS Shadow

It determines whether Video BIOS will be copied to RAM, however, it is an optional chipset design. Default is Enabled.

### 4.7 Chipset Features Setup

This screen controls the settings for the board's chip set. The controls for this screen are the same as the previous screen.

#### The Chipset Features Screen

ROM ISA BIOS  
 CHIPSET SETUP UTILITY  
 AWARD SOFTWARE, INC.

DRAM RAS# Precharge Time :4	PCI Concurrency :Enabled
DRAM R/W Leadoff Timing :8/6	PCI Streaming :Enabled
DRAM RAS to CAS Delay :3	PCI Bursting :Enabled
DRAM Read Burst Timing :x2222	Onboard FDC Controller :Enabled
DRAM Write Burst Timing :x3333	Onboard Serial Port 1 :Com1
System BIOS Cacheable :Enabled	Onboard Serial Port 2 :Com2
Video BIOS Cacheable :Enabled	Onboard Parallel Port :278H
8 bit I/O Recovery Time :1	Parallel Port Mode :EPP
16 bit I/O Recovery Time :1	
Memory Hole at 15M/16M :Disabled	ESC :Quit    ↑ ↓ → ← :Select Item
IDE Block Mode :Disabled	F1 :Help      PU/PD/+/- :Modify
IDE Primary Master PIO :Auto	F5 :Old Values (Shift)F2 :Color
IDE Primary Slave PIO :Auto	F6 :Load BIOS Defaults
IDE Secondary Master PIO :Auto	F7 :Load Setup Defaults
IDE Secondary Slave PIO :Auto	
On-Chip Primary PCI IDE :Enabled	
On-Chip Secondary PCI IDE :Enabled	
PCI Slot IDE 2nd Channel :Enabled	

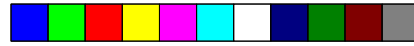

#### ◆ **Chipset Features**

The DRAM timings can be altered from the default to optimize system performance. Be aware though that these settings are sensitive to the type and speed of DRAMs being used and can cause lockups or data lost if set incorrectly. The default settings should work with most DRAMs.

#### ◆ **DRAM RAS# Precharge Time**

DRAM must continually be refreshed or it will lose its data. Normally, DRAM is refreshed entirely as the result of a single request. This option allows you to determine the number of CPU clocks allocated for the Row Address Strobe to accumulate its charge before the DRAM is refreshed. If insufficient time is allowed, refresh may be incomplete and data will be lost. A lower setting may increase performance.

*The default value is 4 clocks.*

#### ◆ **DRAM R/W Leadoff Timing**

This sets the number of CPU clocks allowed before reads and writes to DRAM are performed. The default of 8/6 would set the leadoff timing for reads to eight clocks and writes to six clocks.

A lower setting may increase performance.

*The default value is 8/6.*

#### ◆ **DRAM RAS to CAS Delay**

When DRAM is refreshed, both rows and columns are addressed separately. This option allows you to determine the timing of the transition from Row Address Strobe (RAS) to Column Address Strobe(CAS). A lower setting may increase performance.

*The default is 3 cpu clock delay.*



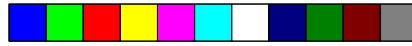

#### ◆ **DRAM Read/Write Burst Timing**

This sets the timing for Burst mode reads from DRAM. Burst read and write request are generated by the CPU in four separate parts. The "x" is the leadoff cycle and is determined by the chipset and the memory timing. The remaining four numbers is the actual data cycles. The lower the timing numbers, the faster the system will address memory.

*The default for read burst timing is x2222.*

*The default for write burst timing is x3333.*

#### ◆ **System BIOS Cacheable**

When enabled, accesses to the system BIOS ROM addressed at F0000H-FFFFFH are cached. Enable this for best performance under DOS/Windows or Windows95. When using operating systems that do not access the BIOS (Unix, OS/2, NT, etc...) this setting can be disabled.

*The default is enabled.*

#### ◆ **Video BIOS Cacheable**

As with caching the system BIOS above, enabling the Video BIOS cache will cause access to the video BIOS addressed at C0000h to C7FFFFh to be cached.

*The default is enabled.*

#### ◆ **8 bit I/O Recovery Time**

The recovery time is the length of time measured in CPU clocks, which the system will delay after the completion of an I/O request. This delay takes place because the CPU is operating so much faster than the I/O bus that the CPU must be delayed to allow for the completion of the I/O request. This option allows you to determine the recovery time allowed for 8 bit I/O.

*The default is 1 clock cycle.*

#### ◆ **16 bit I/O Recovery Time**

This option allows you to determine the recovery time allowed for 16 bit I/O.

*The default is 1 clock cycle.*

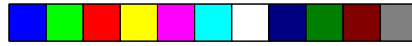

◆ **Memory Hole at 15M-16M**

Some ISA cards may not function correctly when more than 16MB of RAM is installed. If this is the case, then enable this option. Most ISA should work fine with this option disabled.

*The default is disabled.*

◆ **IDE HDD Block Mode**

This option allows the hard disk controller to use fast block mode transfer to and from the hard disk drive. The hard drive must support block mode transfer for this option to be enabled.(Most new drives do.)

*The default is enabled.*

◆ **IDE Primary/Secondary Master/Slave PIO**

Rather than have the BIOS issue a series of commands to effect a transfer to or from the disk drive, PIO(Programmed Input/Output) allows the BIOS to tell the controller what it wants and lets the controller and the CPU perform the complete task themselves. This method is simpler, more efficeint and faster. This BIOS supports five modes (0 thru 4) and can be set by the user or set to Auto detect.

*The default is Auto.*

◆ **On-Chip Primary/Secondary PCI IDE**

This option enables or disables the on board PCI IDE controllers.

*The default is enabled.*

◆ **PCI Concurrency**

When enabled, the CPU can run concurrently with a PCI bus mastering peripheral. This achieves significant data transfer rate improvements without splitting resource utilization between the CPU and bus mastering device.

*The default is enabled.*

◆ **PCI Streaming**

Streaming is an advanced bus cycle type and can increase data transfer rate on the PCI bus.

*The default is enabled.*

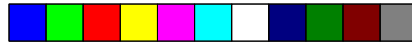

◆ **PCI Bursting**

When enabled, all read and write data transfers over the PCI bus are burst transfers.

*Default is enabled.*

◆ **Onboard FDC Controller**

This option lets you enable or disable the onboard floppy controller.

*The default is enabled.*

◆ **Onboard Serial Port 1/2**

This option lets you select how this port will be addressed. The options are Com1 thru Com4 or disabled.

*The default is Com1 for port 1 and Com2 for port 2.*

◆ **Onboard Parallel Port**

This option lets you select the LPT port address. Options are 3BCh, 378h, 278h or Disabled.

*The default is 278h.*

◆ **Parallel Port Mode**

This option lets you select which mode the parallel port will run in. The options are Normal, EPP, ECP, or ECP + EPP.

*The default is EPP.*

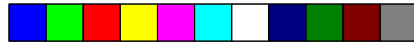

## 4.7.1 Power Management Setup

ROM ISA BIOS  
POWER MANAGEMENT SETUP  
AWARD SOFTWARE, INC

Power Management	:Disabled	IRQ3 (Com2)	:Off
PM Control By APM	:No	IRQ4 (Com1)	:Off
Video Off Method	:Blank Screen	IRQ5 (LPT2)	:Off
Doze Mode	:Disabled	IRQ6 (Floppy Disk)	:Off
Standby Mode	:Disabled	IRQ7 (LPT1)	:Off
Suspend Mode	:Disabled	IRQ8 (RTC Timer)	:Off
HDD Power Down	:Disabled	IRQ9 (IRQ2 Redir)	:Off
IRQ3 (Wake-Up Event)	:Off	IRQ10 (Reserved)	:Off
IRQ4 (Wake-Up Event)	:Off	IRQ11 (Reserved)	:Off
IRQ8 (Wake-Up Event)	:Off	IRQ12 (PS/2 Mouse)	:Off
IRQ12 (Wake-Up Event)	:Off	IRQ13 (Coprocesor)	:Off
		IRQ14 (Hard Disk)	:Off
		IRQ15 (Reserved)	:Off
<u>Power Down Activities</u>			
Com Ports Accessed	:Off		
LPT Ports Accessed	:Off		
Drive Ports Accessed	:Off		

### ◆ Power Management

Options are disabled, user defined, Min saving, and Max saving.

### ◆ PM Control by APM

Options are "Yes" and "No". When set for "No", system BIOS will ignore APM when power managing the system. If set on "Yes" the system BIOS will wait for APM's prompt before it enters any PM mode, e.g. Doze, Standby or Suspend.

### ◆ Video Off Method

The "Blank Screen" option will let the system BIOS blanks the screen when disabling video. V/H SYNC+Blank will let the BIOS turn off the V-SYNC and H-SYNC signals from the VGA card to the monitor.

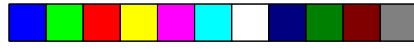

◆ **Doze Mode**

Defines the continuous idle time before the system enters Doze mode.

◆ **Standby Mode**

Defines the continuous idle time before the system enters Standby mode.

◆ **Power Down Activities**

Defines the activities that can cause the PM timers to reload. (Breaking out of PM Mode)



## 4.8 PCI Slot Configuration

ROM ISA BIOS  
PCI SLOT CONFIGURATION  
AWARD SOFTWARE, INC.

<p>PnP BIOS Auto-Config:Enabled</p> <p>Slot1 Using INT# :    AUTO Slot2 Using INT#:    AUTO Slot3 Using INT#:    AUTO Slot4 Using INT#:    AUTO</p> <p>PCI IRQ Activated By:   Level PCI IDE IRQ Map To:   Auto Primary IDE INT#:     A Secondary IDE INT#:    B</p>	<p>ESC: Quit   ↑   ↓   →   ←   :Select Item F1 : Help    PU/PD/+/-   :Modify F5 : Old Values (Shift)F2   :Color F6 : Load BIOS Defaults F7 : Load Setup Defaults</p>
--	--

◆ PCI Slot 1/Slot 2/Slot 3/slot 4 INT#

◆ For Default Setting.

	Connect to PCI System INT#
PCI Slot1 INTA	INTA
PCI Slot1 INTB	INTB
PCI Slot1 INTC	INTC
PCI Slot1 INTD	INTD
PCI Slot2 INTA	INTB
PCI Slot2 INTB	INTC
PCI Slot2 INTC	INTD
PCI Slot2 INTD	INTA
PCI Slot3 INTA	INTC
PCI Slot3 INTB	INTD
PCI Slot3 INTC	INTA
PCI Slot3 INTD	INTB
PCI Slot4 INTA	INTD
PCI Slot4 INTB	INTA
PCI Slot4 INTC	INTB
PCI Slot4 INTD	INTC

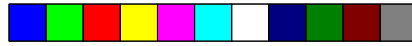

◆ **PnP BIOS Auto-Config**

This option lets you enable or disable auto configuration for the Plug and Play BIOS.

*The default is Enabled.*

◆ **1st Available IRQ#**

◆ **2nd Available IRQ#**

◆ **3rd Available IRQ#**

◆ **4th Available IRQ#**

Select four available IRQs assignments to PCI slots INT

◆ **PCI IRQ Actived By:**

Select the PCI IRQ Active scheme either LEVEL or EDGE.

*Default value is LEVEL.*

◆ **PCI IDE IRQ Map To:**

Select the IDE IRQ Map to ISA IRQ#.

◆ **Primary IDE INT#**

Select the PCI INT# that the Primary IDE controller will use.

*Default value is A.*

◆ **Secondary IDE INT#**

Select the PCI INT# that the Secondary IDE controller will use.

*Default value is B*

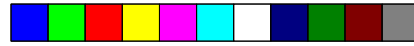

## 4.9. LOAD SETUP DEFAULTS

ROM ISA BIOS  
CMOS SETUP UTILITY  
AWARD SOFTWARE INC.

STANDARD CMOS SETUP	PASSWORD SETTING
BIOS FEATURES SETUP	IDE HDD AUTO DETECTION
CHIPSET F	SETUP
PCI SLOT	T SAVING
LOAD SETUP DEFAULTS	
<p>ESC : Save &amp; Exit Setup F10 : Quit</p> <p>↑ ↓ → ← : Select Item (Shift)F2 : Change Color</p>	
Load SETUP Defaults except standard CMOS SETUP	

### ◆ Load SETUP defaults

To load SETUP default values to CMOS SRAM, enter "Y". If not, enter "N"

◆ If any problem has occurred, loading the SETUP DEFAULTS is recommended.

## 4.10. PASSWORD SETTING

When you select this function, the following message will appear at the center of the screen to assist you in creating a password.

ENTER PASSWORD



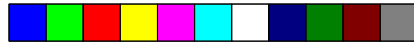

ROM ISA BIOS  
 CMOS SETUP UTILITY  
 AWARD SOFTWARE, INC.

STANDARD CMOS SETUP	PASSWORD SETTING
BIOS FEATURES SETUP	IDE HDD AUTO DETECTION
CHIPSET FE	SETUP
PCI SLOT C	UT SAVING
LOAD SETUP DEFAULTS	
<div style="border: 1px solid black; padding: 5px; display: inline-block;">Enter Password</div>	
ESC : Save & Exit Setup F10 : Quit	↑ ↓ → ← :Select Item (Shift)F2 :Change Color
Change/Set/Disable Password	

Type the password, up to eight characters, and press <Enter>. The password typed now will clear the previously entered password from CMOS memory. You will be asked to confirm the password. Type the password again and press <Enter>. You may also just press <Esc> to abort the selection and not enter a password.

To disable the password, just press <Enter> when you are prompted to enter a password. A message will confirm that the password has been disabled, the system will boot and you can enter Setup freely.

PASSWORD DISABLED

If you select System at Security Option of BIOS Features Setup Menu, you will be prompted for the password every time the system is rebooted or any time you try to enter setup. If you select Setup at Security Option of BIOS Features Setup Menu, you will be prompted only when you try to enter setup.



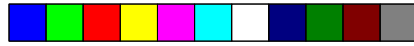

#### 4.11. IDE HDD AUTO DETECTION

ROM ISA BIOS  
CMOS SETUP UTILITY  
AWARD SOFTWARE, INC.

		CYLS.	HEAD	PRECOMP	LANZONE	SECTORS
Drive C:	(202 Mb)	989	12	65535	989	35

Do you want to accept this as drive C (Y/N)?

Esc:Skip

Type "Y" to accept the H.D.D parameter reported by BIOS. Type "N" to keep the old H.D.D parameter info.

#### 4.12. SAVE & EXIT SETUP

ROM ISA BIOS  
CMOS SETUP UTILITY  
AWARD SOFTWARE, INC.

STANDARD CMOS SETUP	PASSWORD SETTING
BIOS FEATURES SETUP	IDE HDD AUTO DETECTION
CHIPSET FIRMWARE SETUP	LOAD SETUP DEFAULTS
PCI SLOT CONFIGURATION	UT SAVING
Save to CMOS and EXIT (Y/N)? N	
ESC : Save & Exit Setup F10 : Quit	
↑ ↓ → ← :Select Item (Shift)F2 :Change Color	
Time, Date, Hard Disk Type,.....	

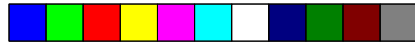

Type "Y" and you will quit the Setup Utility and save the user setup values to RTC CMOS SRAM. Type "N" to return to Setup Utility.

### 4.13 KEYBOARD SETTING FUNCTION

After booting the O.S., there are some special functions used by the keyboard as follows:

- |                |  |
|----------------|--|
| "CTRL_ALT_DEL" | -Pressing these keys simultaneously will cause the system to WARM START (Soft Reset)                             |
| "CTRL_ALT_[+]" | -Pressing these keys simultaneously will change the system speed to high speed (Turbo, all cache memory enabled) |



## 5.0 AMI WINBIOS

The AMI WINBIOS is based on a Graphical User Interface that enables the user to access all of the BIOS setup options with either a mouse or keyboard. You can enter the BIOS setup by pressing on the "DEL" key during the memory test/count.

The WINBIOS Setup screen consists of the following option groups:

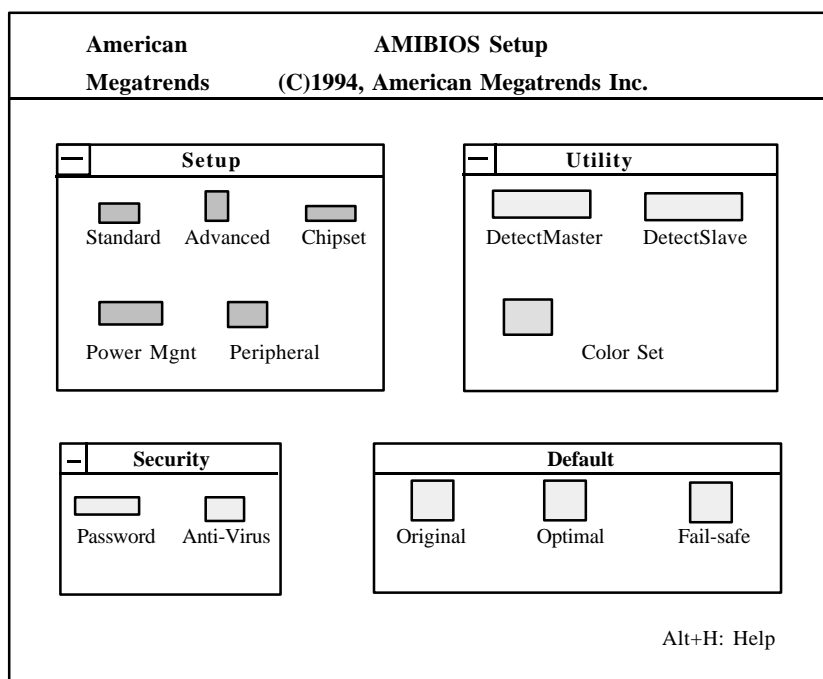

### 5.1 Standard Setup Options

#### **Date, Day and Time Configuration**

Select the Standard Option, then select the Date and Time Icon. The current values for each category are displayed. Use the arrow keys or mouse to highlight the date or time fields. Use the + or - keys to change the field values. The system will automatically select the appropriate day of the week.

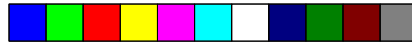

- ◆ **Primary Master**

- ◆ **Primary Slave**

Select one of these hard disk drive Icons to configure the drive named in the option. WINBIOS supports up to four IDE hard disk drives: the primary master, primary slave, secondary master and secondary slave. If the hard disk drive is an IDE drive, select DETECT PRIMARY or DETECT SLAVE from the Utility Setup Option Section of the WINBIOS Setup Main Menu to have WINBIOS automatically detect the IDE drive parameters and report them to this screen. The SCSI option must be selected if a SCSI Disk Drive installed.

You can also manually enter the hard disk drive parameters. Hard disk type 47 is the user-definable drive type. The drive parameters are: Type, Cylinders, Heads, Write precompensation, Landing Zone, Sectors and Capacity.

- ◆ **Floppy Drive A:**

- ◆ **Floppy Drive B:**

Move the cursor to these fields via the up and down arrow keys and select the floppy type. The settings are 360 KB 5 1/4 inch, 1.2MB 5 1/4 inch, 720MB 3 1/2 inch, 1.44MB 3 1/2 inch and 2.88MB 3 1/2 inch..

## 5.2 Advanced Setup

The WINBIOS Setup options described in this section are selected by choosing the Advanced Setup Icon from the WINBIOS Setup Main Menu.

- ◆ **Typematic Rate (Chars/Sec)**

Set the rate at which characters on the screen repeat when a key is pressed and held down. The Optimal setting is 30 characters per second. The Fail-Safe default setting is *disabled*.

- ◆ **System Keyboard**

Specify if error messages are displayed when a keyboard is not attached. This option permits you to configure workstations with no keyboards. The Optimal and Fail-Safe default settings are *Present*.

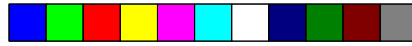

◆ **Primary Display**

Configures the type of monitor attached to the computer. *The Optimal and Fail-Safe default settings are VGA/EGA.*

◆ **Above 1MB Memory Test**

When this option is *enabled*, the system will test the entire memory pool during the Power On Self Test(POST). If it is *disabled*, the system will only count the amount of available memory without testing it.

◆ **Hit "DEL" Message Display**

*Enable or disable* the "HitDElete key" message upon boot up. *The default is enabled.*

◆ **Extended BIOS RAM Area**

Specify in this option if the top 1 KB of the system programming area begins at 639K (*DOS 1K*) or at address 0:300. In most instances 0:300 should be used. *The default is 0:300.*

◆ **Wait for "F1" if Any Error**

Enable this option to display the message "Hit F1 to continue" when the system encounters an error during POST. *The default is Enabled.*

◆ **System Boot Up Num Lock**

This option lets you turn on or off the num lock for the keyboard during boot up. *The default is ON.*

◆ **Floppy Drive Seek at Boot**

This option *enables or disables* the floppy drive seek during POST. *The default is disabled.*

◆ **Floppy Drive Swapping at Boot**

When *enabled*, the system allows the floppy drives to swap drive letters with each other. *The default is disabled.*

◆ **System Boot Up Sequence**

This option determines which disk drive the system will attempt to boot from first. The options are "A: to C:" or "C: to A:". *The default is "A: to C:"*

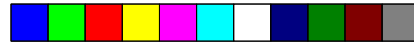

#### ◆ Password Checking

This option enables the password check option everytime the system boots or the user runs WinBIOS Setup. If *Always* is chosen, a user password prompt appears everytime the computer is powered on. If *Setup* is chosen, the password prompt appears if WinBIOS Setup is executed. *The default is Setup.*

#### ◆ Cache Memory

The options are "*Both*"(L1 and L2 enabled), "*Internal*"(L1 enabled and L2 cache is disabled) and "*Disabled*" (Both L1 and L2 cache disabled). *The default is "Both"*

#### ◆ System BIOS Shadow Cacheable

If this option is *enabled*, the F000 segment of the BIOS shadow will be cached. *The default is enabled.*

#### ◆ Video ROM and Adaptor ROM

The video and adaptor ROMs present on the system may either execute out of ROM(*disabled*), RAM(*Shadow*), or execute out of RAM and be cached(*Cache*). The video ROM should be set for *cache* for best performance. The adaptor ROM area should be left *disabled* unless the device in that region can support shadowing (Its ROM being copied to RAM for better performance). *The default is disabled.*

#### ◆ IDE Block Mode

If you know the maximum s/b (Sectors per Burst) of your drive then it can be chosen here. If you are not sure about your drive specs then choose *auto*. The options are *disabled*, *auto*, *2 s/b*, *4 s/b*, *8 s/b*, *16 s/b*, *32 s/b* or *64 s/b*. For drives that don't support Block Mode transfers, this option should be *disabled*.

#### ◆ Onboard PCI IDE

You can *enable* or *disable* the onboard PCI controller. If it is set for *auto*, the system will auto-detect for a device attached to the controller. *The default is Auto.*

#### ◆ Onboard PCI IDE Prim. PIO Mode

This option lets you select the PIO Mode for the IDE HDD that is attached to your primary controller. Choices are from *mode 0* thru *mode 4*. If you are not sure which mode your drive supports, use the *Auto option*.

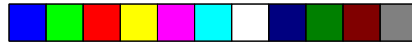

◆ **Onboard PCI IDE Sec. PIO Mode**

This option lets you select the PIO Mode for the IDE HDD that is attached to your secondary controller. Choices are from *mode 0* thru *mode 4*. If you are not sure which mode your drive supports, use the *Auto* option. *The default is Auto.*

◆ **Onboard PCI IDE 32bit Mode**

This option *Enables* or *Disables* PCI IDE 32-bit transfer mode. Be aware that not all drives support this mode. The default is *enabled*.

◆ **Primary Master LBA Mode**

**Primary Slave LBA Mode**

**Secondary Master LBA Mode**

**Secondary Slave LBA Mode**

This option *enables* or *disables* LBA (Logical Block Addressing) support for each of the drives. LBA Mode is an advanced method for accessing data on IDE drives. Data is accessed by block addresses rather than the traditional Cylinder-Header-Sector scheme. LBA Mode also breaks the 528MB size limit imposed by older IDE drives. *Enable* only if your drive can support LBA. *The default is disabled.*

◆ **Secondary Ctrl Drives Present**

This option specifies the number of IDE drives controlled by the onboard secondary IDE controller. The settings are *None*, *1(drive)*, or *2(drives)*.

*The default is None.*

### 5.3 Advanced Chipset

◆ **Memory Hole**

This option lets you create a memory hole for either the *512-640KB* region or the *15-16MB* region. *The default is disabled.*

◆ **DRAM Speed**

This option should be set according to the speed of the DRAM in the system. The value of this option determines how the DRAM timing should be programmed in the chipset. The options are *60ns* and *70ns*. *The default is 60ns.*



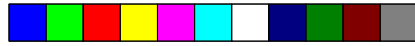

◆ **8 bit I/O Recovery Time**  
**16 bit I/O Recovery Time**

These options set the 8 bit and 16 bit I/O recovery time in the chipset. I/O devices may not function correctly if two back to back I/O writes occur too close together. These options increase the delay between back to back I/O instructions.

The options for 8 bit are *1,2,3,4,5,6,7,8 Sysclk* or *Disabled*.

The options for 16 bit are *1,2,3,4 Sysclk* or *Disabled*.

*The default for both options is 1 Sysclk.*

◆ **PCI Burst Mode**

This option lets you *enable* or *disable* support for PCI Burst Mode. PCI Burst Mode should be enabled for best performance.

*The default is enabled.*

◆ **PCI VGA Palette Snooping**

The purpose of this option is to allow multiple VGA devices on different busses in a system to have data written from the CPU to each set of palette registers of every video device (ISA VGA and a PCI VGA).

The options are *enabled* or *disabled*. *The default is enabled.*

◆ **IRQx Available to (x= IRQ 3,4,5,7,9,10,11)**

These options allow interrupts to be specified as being used by legacy ISA devices or that they are available for PCI/PnP devices.

The options are *ISA/EISA* or *PCI/PnP*.

◆ **PCI IDE Card Selection**

**PCI Primary IDE INT# Line**

**PCI Secondary IDE INT# Line**

These options indicate the presence and information of an offboard PCI IDE device. The first option indicates the device number of the PCI IDE and the other options indicate how IRQ14 and IRQ15 are routed to the device. *The default is absent.*

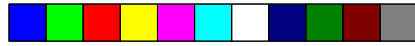

## 5.4 Power Management

### ◆Advanced Power Management

This option *enables* or *disables* power management.  
*The default is disabled.*

### ◆Standby to Suspend Timeout Value

This option indicates the time before standby and suspend power saving modes will occur. The options are from *disabled* thru *255 minutes*.  
*The default is disabled.*

### ◆IDE Drive Power Down In

This option specifies which mode the IDE drives will power down in.  
The options are *disabled*, *standby* or *suspend*.  
*The default is disabled.*

### ◆VESA Video Power Down In

This option specifies which mode the video will power down in.  
The options are *disabled*, *standby* or *suspend*.  
*The default is disabled.*

### ◆VESA Power Down In

This option specifies the power saving mode for the video.  
The options are *standby*, *suspend* or *off*.  
*The default is standby.*

### ◆Slow Clock Ratio

This ratio indicates the amount the CPU will be slowed when the CPU enters standby mode.  
*The default is 1:1.*

### ◆IRQ x Break Event (x= 0 to 15)

These break events indicate which IRQ events will wake up the system and/or reload the standby and suspend timers. The options are *disabled* and *enabled*.  
*The default is disabled.*

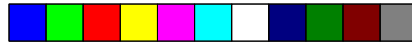

## 5.5 Peripheral

### ◆ Programming Mode

When set to manual, you can customize all the settings below.

When set to auto, they system will automatically configure all the ports.

*The default is Manual.*

### ◆ OnBoard FDC

This option lets you enable or disable the onboard floppy disk controller.

*The default is enabled.*

### ◆ Serial Port 1

This option lets you configure the address of serial port 1. The options are 3F8h, 3E8h, 2E8h or disabled.

*The default is 3F8h.*

### ◆ Serial Port 2

This option lets you configure the address of serial port 2. The options are 2F8h, 3E8h, 2E8h and disabled.

*The default is 2F8h.*

### ◆ Parallel Port

This option lets you configure the address of the onboard parallel port. The options are 3BCh, 378h, 278h or disabled.

*The default is 378h.*

### ◆ Parallel Port Mode

This option lets you configure the mode that the onboard parallel port will function in. The options are Extended or Normal.

*The default is Extended.*

### ◆ IRQ Active

This options lets you set the IRQ trigger. The options are High or Low. The default should be used in most cases.

*The default is High.*

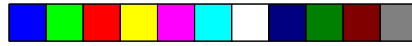

## 5.6 Utility

### **Detect Master/Detect Slave**

These options, when invoked will enable the CMOS to query the IDE drive firmware for its cylinder, head and sector parameters.

### **Color Set**

This option lets you select the color scheme of the WinBIOS setup screen. The options are *LCD*, *Army*, *Pastel* and *Sky*. The default is *LCD* (Very boring).

## 5.7 Security

### **Password**

The password feature prohibits unauthorized changes to the system setup accessed via the CMOS setup program. The default password is "AMI".

### **Anti-Virus**

If enabled, this option will protect the boot sector of the hard disk drive. Nothing can be written to the boot sector while this option is enabled. This option should be disabled if you are installing a new operating system that writes to the boot sector. The default is *disabled*.

## 5.8 Defaults

### **Original**

This option restores the CMOS setup to factory default settings.

### **Optimal**

This option will configure the CMOS setup to its fastest settings.

### **Fail-Safe**

This option will configure the CMOS setup to its most conservative settings.

### **CMOS Save & Exit**

To save the changes made to the CMOS setup, press the ESCape key until the "exit CMOS" menu appears, then select your choice.

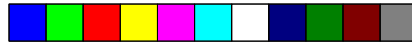

## 6.0 Flash Writer Utility

You can upgrade the BIOS of your mainboard by using a "Flash Memory Writer"(FMW) utility. This utility can be downloaded from the factory's BBS(Consult your system vendor for the phone #). The system BIOS is stored on a 'flash' EPROM ROM chip on the mainboard which can be erased and reprogrammed by the FMW. The following three files make up the FMW.

AWDFLASH.EXE	-The Flash Memory Writer utility for Award to Award upgrade.
AMIFLASH.COM	-The Flash Memory Writer utility for AMI to AMI upgrade.
README	-A text file of instructions
*S68AWXX.BIN	-XX-A 2-digit version number.

Flash memory writer records (or 'programs') a new BIOS onto the flash memory chip. You cannot upgrade an Award BIOS to a AMI BIOS or a AMI BIOS to an Award BIOS.

\*This file name is subject to change and can have either a "bin" or a "rom" extension.

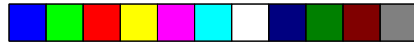

To reprogram the System BIOS, you must first do the following:

1. Check jumpers J42, J43, and J44.

The S1468 uses a 5V Flash EPROM so these three jumpers should be left in the default position on pins 1 and 2. These jumper should never be moved.

2. Make sure the CPU is running in 'real mode'.

FMW will not run if the CPU is operating in a protected or virtual mode. This means that you can not run it with Windows running or with any memory manager software. You must disable any memory manager first. The easiest way to do this is to:

- a. Boot your system from a bootable floppy disk with no CONFIG.SYS or AUTOEXEC.BAT files, and then run Flash Memory Writer from a backup copy of your support disk. You can make your back-up floppy bootable when you format it, and use one disk for both purposes.

- b. If you are using MS-DOS 6.x, you can use the feature that allows you to bypass the CONFIG.SYS and AUTOEXEC.BAT file. You do this while pressing <F5> while the "Starting MS-DOS..." line is on the screen.

There are other ways to accomplish the same result. The main point is to make sure no memory managers are running. If you are not sure, try running FMW. If it runs, then you have succeeded. If it displays a warning message about the CPU mode, you will have to try again.

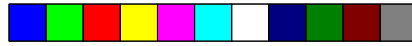

Once you have satisfied the two requirements mentioned above, you can run FMW. You can copy the contents of the “Flash” directory to your hard drive, or you can run the utility from a backup of the support floppy disk. Make sure the new BIOS file is in the same directory as the FMW utility.

To run FMW, change to the “Flash” directory if you are not already in it. Type “Awdflash” at the DOS command line and press the <Enter> key. The following screen will appear.

### 6.1 The Flash Memory Writer Utility Screen (Award)

FLASH MEMORY WRITER V3.0 Copyright (C) 1993, AWARD Software Inc.,	
For Triton-2A59CT51	Date:4/13/95
File Name to Program:	
Error Message:	

Type in the whole file name, e.g. A61AW10.BIN and confirm that you want to program the BIOS. The utility will then ‘Blank’, ‘Erase’, and then ‘Program’ the flash memory on the mainboard with the new BIOS file. You should choose “yes” to save the original system BIOS to a floppy diskette before you program the new BIOS. This leaves you with a backup of your original BIOS in case you need to re-install it. This option is highly recommended. If you can not successfully program the BIOS file for whatever reason, re-install you original BIOS from the backup file.

**Warning:** If you do not successfully install a complete BIOS file in the flash memory on the Mainboard, your system may not be able to boot. If this happens, it will require service by your system vendor. Follow the requirements and instructions in this section precisely to avoid inconvenience.

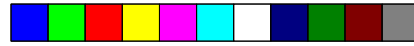

## 7.0 AT TECHNICAL INFORMATION

### 7.1 I/O BUS CONNECTOR PIN OUT

#### 7.1.1 ISA SLOT PIN OUT

GND	B01	A01	-I/O CH CHK	-MEMC16	D01	C01	SBHE
RESET	B02	A02	SD07	-I/OCS16	D02	C02	LA23
+5V	B03	A03	SD06	IRQ10	D03	C03	LA22
IRQ9	B04	A04	SD05	IRQ11	D04	C04	LA21
-5V	B05	A05	SD04	IRQ12	D05	C05	LA20
DRQ2	B06	A06	SD03	IRQ15	D06	C06	LA19
-12V	B07	A07	SD02	IRQ14	D07	C07	LA18
0WS	B08	A08	SD01	-DACK0	D08	C08	LA17
+12V	B09	A09	SD00	DRQ0	D09	C09	-MEMR
GND	B10	A10	-I/O CH RDY	-DACK5	D10	C10	-MEMW
-SMEMW	B11	A11	AEN	DRQ5	D11	C11	SD08
-SMEMR	B12	A12	SA19	-DACK6	D12	C12	DS09
-IOW	B13	A13	SA18	DRQ6	D13	C13	DS10
-IOR	B14	A14	SA17	-DACK7	D14	C14	DS11
-DACK3	B15	A15	SA16	DRQ7	D15	C15	DS12
-DRQ3	B16	A16	SA15	+5V	D16	C16	DS13
DACK1	B17	A17	SA14	-MASTER	D17	C17	DS14
DRQ1	B18	A18	SA13	GND	D18	C18	DS15
-REFRESH	B19	A19	SA12				
BCLK	B20	A20	SA11				
IRQ7	B21	A21	SA10				
IRQ6	B22	A22	SA09				
IRQ5	B23	A23	SA08				
IRQ4	B24	A24	SA07				
IRQ3	B25	A25	SA06				
-DACK2	B26	A26	SA05				
T/C	B27	A27	SA04				
BALE	B28	A28	SA003				
+5V	B29	A29	SA02				
OSC	B30	A30	SA01				
GND	B31	A31	SA00				



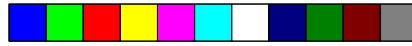

## 7.1.2 PCI-BUS SLOT PIN OUT

-12V	A01 B01	NC
NC	A02 B02	+12V
GND	A03 B03	NC
NC	A04 B04	NC
VCC	A05 B05	VCC
VCC	A06 B06	INT#A
INTB#	A07 B07	INT#C
INTD#	A08 B08	VCC
PST#1	A09 B09	NC
NC	A10 B10	VCC
PST#2	A11 B11	NC
GND	A12 B12	GND
GND	A13 B13	GND
NC	A14 B14	NC
GND	A15 B15	RST#
CLK	A16 B16	VCC
GND	A17 B17	GNT#
REQ#	A18 B18	GND
VCC	A19 B19	NC
AD_31	A20 B20	AD_30
AD_29	A21 B21	NC
GND	A22 B22	AD_28
AD_27	A23 B23	AD_26
AD_25	A24 B24	GND
NC	A25 B25	AD_24
CBE#3	A26 B26	IDSEL
AD_23	A27 B27	NC
GND	A28 B28	AD_22
AD_21	A29 B29	AD_20
AD_19	A30 B30	GND
NC	A31 B31	AD_18
AD_17	A32 B32	AD_16
CEB#2	A33 B33	NC
GND	A34 B34	FRAME#
IRDY#	A35 B35	GND
NC	A36 B36	STOP#
DEVSEL#	A37 B37	NC
GND	A38 B38	SDONE
LOCK#	A39 B39	SBO#
PERR#	A40 B40	GND
NC	A41 B41	PAR
SERR#	A42 B42	AD_15
NC	A43 B43	NC
CBE#1	A44 B44	AD_13
AD_14	A45 B45	AD_11
GND	A46 B46	GND
AD_12	A47 B47	AD_09
AD_10	A48 B48	CBE#0
GND	A49 B49	NC
AD_08	A50 B50	AD_06
AS_07	A51 B51	AD_04
NC	A52 B52	GND
AD_05	A53 B53	AD_02
AD_03	A54 B54	AD_00
GND	A55 B55	VCC
AD_01	A56 B56	NC
VCC	A57 B57	VCC
NC	A58 B58	VCC
VCC	A59 B59	
VCC	A60 B60	
	A61 B61	
	A62 B62	

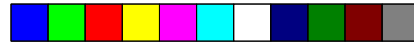

## 7.2. TIMER & DMA CHANNEL MAP

TIMER MAP:           TIMER Channel-0 system timer interrupt  
                          TIMER Channel-1 DRAM REFRESH request  
                          TIMER Channel-2 SPEAKER tone generator

DMA CHANNELS:       DMA Channel-0 Available  
                          DMA Channel-1 IBM SDLC  
                          DMA Channel-2 FLOPPY DISK adapter  
                          DMA Channel-3 Available  
                          DMA Channel-4 Cascade for DMA controller 1  
                          DMA Channel-5 Available  
                          DMA Channel-6 Available  
                          DMA Channel-7 Available

## 7.3 INTERRUPT MAP

NMI:                   Parity check error

IRQ (H/W)           0 System TIMER interrupt from TIMER-0  
                          1 KEYBOARD output buffer full  
                          2 Cascade for IRQ 9-15  
                          3 SERIAL port 2  
                          4 SERIAL port 1  
                          5 PARALLEL port 2  
                          6 FLOPPY DISK adapter  
                          7 PARALLEL port 1  
                          8 RTC clock  
                          9 Available  
                          10 Available  
                          11 Available  
                          12 Available  
                          13 MATH co-processor  
                          14 HARD DISK adapter  
                          15 Available

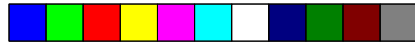

## 7.4 RTC & CMOS RAM MAP

RTC & CMOS:	00	Seconds
	01	Seconds alarm
	02	Minutes
	03	Minutes alarm
	04	Hours
	05	Hours alarm
	06	Days of the week
	07	Days of the month
	08	Month
	09	Year
	0A	Status register A
	0B	Status register B
	0C	Status register C
	0D	Status register D
	0E	Diagnostic status byte
	0F	Shutdown byte
	10	Floppy DISK drive type byte
	11	Reserved
	12	HARD DISK type byte
	13	Reserved
	14	Equipment byte
	15	Base memory low byte
	16	Base memory high byte
	17	Extension memory low byte
	18	Extension memory high byte
	19-2d	Reserved
	2E-2F	2-byte CMOS RAM checksum
	30	Reserved for extension memory low byte
	31	Reserved for extension memory high byte
	32	DATE CENTURY byte
	33	INFORMATION FLAG
	34-3f	Reserved
	40-7f	Reserved for CHIPSET SETTING DATA

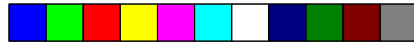

## Appendix A: Post Codes

ISA POST codes are typically output to port address 80h ( Award BIOS)

POST	Name	OEM specific-Cache control
C0	Turn off Chipset cache	Processor Status (1 FLAGS) verification.
1	Processor Test 1	Test the following processor status flags; carry, zero, sign, overflow. The BIOS will set each of these flags, verify they are set, then turn each flag off and verify it is off
2	Processor Test 2	Read/Write/Verify all CPU registers except SS,SP, and BP with data pattern FF and 00
3	Initialize chips	Disable NMI, PIE, AIE, UEL, SQWV, video, parity checking, DMA. Reset math co-processor. Clear all page registers. Initialize timer 0,1 and 2. Initialize DMA controllers 0 and 1. Initialize interrupt controllers 0 and 1.
4	Test Memory refresh toggle	Assures that memory refresh function is working.
5	Blank Video Initialize Keyboard	Keyboard initialization
6	Reserved	
7	Test CMOS and battery status	Verifies CMOS is working properly, detects a bad battery.
BE	Chipset Default	Programs chipset registers with power on BIOS default
C1	Memory presence test	OEM specific-Test to size on-board memory.
C5	Early shadow	OEM specific-early shadow enable for fast boot
C6	Cache presence test	External cache size detection
8	Setup low memory	Clear low 64K memory. Test first 64K memory.
9	Early cache initialize	Cache initialization
A	Setup Interrupt Vector Table	Initialization first 120 interrupt vectors with SPURIOUS_INT-HDLR and initialize INT 00h-1 Fh according to INT_TBL.
B	Test CMOS	Test CMOS RAM Checksum.
C	Initialize keyboard	Detect type of keyboard controller. Set NUM_LOCK status.
D	Initialize video interface	Detect CPU clock. Read CMOS location 14h to find type of video. Detect and initialize video adapter.
E	Test video memory	Test video memory, writer sign-on message to screen. Setup shadow RAM. Enable shadow according to setup.
F	Test DMA controller 0	BIOS checksum test. Keyboard detect and initialization

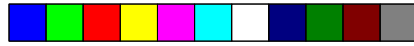

10	Test DMA memory controller 1	Test DMA controller
11	Test DMA Page registers	Test DMA page Registers
12-13	reserved	
14	Test timer counter 2	Test 8254 timer 0 countner 2
15	Test 8259-1 Mask	Verify 8259 channel 1 masked interrupts
16	Test 8259-2 Mask	Verify 8259 channel 2 masked interrupts
17	Test Stuck 8259 interrupt bits	Turn off interrupt then verify nointerrupt mask register is on
18	Test 8259 interrupt functionality	Force interrupt and verify interrupt occured
19	Test Stuck NMI bits	Verify NMI can be cleared
1A	Check clock	Display CPU clock
1B-1F	Reserved	
20	Enable slot 0	Initialize slot 0 (system board)
21-2F	Enable slot 1-15	Initialize slot 1-15
30	Size base and Extended memory	Size base memory form 256K to 640K and Extended memory above 1MB
31	Test base and Extended memory	Test base and Extended memory
32-3B	Reserved	
3C	Setup Enabled	
3D	Initialize and install mouse	Detects if mouse is present, initialize mouse and install interrupt vectors.
3E	Setup cache controller	Initialize cache controller
41	Initialize floppy drive and controller	Initialize floppy disk drive and controller
42	Initialize hard drive and controller	Initialize hard drives
43	detect and initialize serial and parallel ports	Initialize any serial, parallel ports and gameports
44	Reserved	
45	Detect and initialize math co-processor	Initialize math co-processor
46-4D	Reserved	

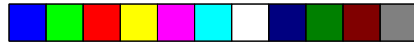

4E	Manufacturing POST loop or display messages	Reboot if manufacturing POST loop pin is set. Otherwise display any messages(i.e. non fatal errors that were detected during POST) and enter setup
4F	Security check	Ask password security (optional)
50	Write CMOS	Write all CMOS values back to RAM and clear screen
51	PRE-boot enable	Enable parity checker, enable NMI and enable cache before boot
52	Initialize Option ROMS's	Initialize any option ROM's present for C8000h to EFFFFh. When FSCAN option is enabled, will initialize from C8000h to F7FFFh.
53	Initialize time value	Initialize time value in 40h: BIOS area
60	Setup Virus Protect	Setup virus protect according to setup
61	Set Boot Speed	Set system speed for boot
62	Setup NumLock	Set up NumLock status according to setup
63	Boot Attempt	Set low stack. Boot via INT 19h
B0	Spurious	If interrupt occurs in protected mode
B1	Unclaimed NMI	If unmasked NMI occurs, display Press F1 to disable NMI or F2 to reboot
E1-EF	Setup Pages	E1-Page 1, E2-Page 2, etc.

