

Tyan S1598
Trinity ATX

Motherboard User's Manual
Revision 1.00

Copyright © Tyan Computer Corporation, 1999. All rights reserved. No part of this manual may be reproduced or translated without prior written consent from Tyan Computer Corp.

All registered and unregistered trademarks and company names contained in this manual are property of their respective companies including, but not limited to the following.

AwardBIOS is a trademark of Award Software Inc.

Windows is a trademark of Microsoft Corporation.

IBM, PC, AT, PS/2 are trademarks of IBM Corporation.

INTEL, Pentium, Pentium MMX are trademarks of Intel Corporation.

S1598 Trinity ATX is a trademark of TYAN Computer Corporation.

Information contained in this publication has been carefully checked for accuracy and reliability. In no event will Tyan Computer be held liable for any direct or indirect, incidental or consequential damage, loss of use, loss of data, or other malady resulting from errors or inaccuracies of information contained in this manual. The information contained in this document is subject to change without notice.

PRINTED IN USA

Table of Contents

1. Introduction.....	4
Overview.....	4
Icons.....	5
Hardware Specifications/Features.....	5
Software Specifications.....	7
Technical Support.....	7
Returning Merchandise for Service.....	8
2. Board Installation.....	9
Unpacking.....	9
Precautions.....	9
Installation Steps.....	10
What is a Jumper?.....	11
Map of Motherboard Jumpers.....	12
Picture of Motherboard Features.....	13
Setting Jumpers.....	14
Mounting the Motherboard in the Chassis.....	16
Installing Memory.....	17
Installing CPU and Cooling Fan.....	20
Connecting IDE and Floppy Drives.....	22
Connecting the Power Supply.....	23
Installing Add-on Cards.....	24
Connecting PS/2, USB, Serial & Parallel Devices.....	25
Frequently Asked Questions.....	26
3. BIOS Configuration.....	30
Introduction to Setup.....	30
Main Setup Menu.....	33
Standard CMOS Setup.....	35
BIOS Features Setup.....	38
Chipset Features Setup.....	43
Power Management Setup.....	46
PnP/PCI Setup.....	51
Integrated Peripherals.....	54
User Password.....	57
Flash Writer Utility.....	57
4. System Resources.....	60
POST Messages.....	60
Appendix 1 - Glossary.....	64

This page has been intentionally left blank.

chapter 1

Introduction

Overview

The S1598 Trinity ATX is a quality, high performance mainboard designed for Socket 7 microprocessors. This mainboard utilizes the VIA MVP3 100MHz AGPset and host bus speeds of 66MHz to 100MHz. For CPU speed support, please refer to the CPU Compatibility Chart in Tyan's website (http://www.tyan.com/support/html/socket_7_compatibility.html). The Trinity ATX also has 100MHz Front Side Bus support, which allows you to take full advantage of 100MHz SDRAM memory modules.

The S1598 mainboard, with built-in AGP slot, provides high performance capabilities that are ideal for a wide range of demanding applications such as CAD, CAM, CAE, desktop publishing, 3D animation, and video production.

This system board achieves high reliability with numerous features and yet is small enough to be supported in an ATX form factor. Some of the features included are onboard dual channel PCI PIO, Bus Master IDE and UltraDMA/66, onboard floppy controller, and onboard high speed I/O. Flexibility and expandability have been designed into the Trinity ATX. With I/O and drive controller support built onboard, the one AGP slot, five PCI and two ISA slots (one shared, seven usable) are free for numerous add-on expansion cards. Remember to take a look at TYAN Computer's web site located at

<http://www.tyan.com>. There you can find information on all of TYAN's products along with FAQs, distributors list, drivers, and BIOS setting explanations.

Icons

In order to help you navigate this manual and set up your system, we have added several icons to our format.



This icon alerts you to particularly important details regarding the setup or maintenance of your system. This icon often appears next to information that may keep you from damaging your board or system. While we will often point out the most vital paragraphs in a chapter, you should always read every word in the text. Failing to do so can lead to exasperation and expense.



Wherever possible, we have included step-by-step instructions for setting up your system, which are indicated by this icon. However, it is in your best interest to read an entire section (and perhaps the entire manual) before you begin to fiddle with your motherboard.



While we have alerted you to potential dangers in several places in the manual with this icon, these warnings should not be regarded as the whole of your safety regimen. Never forget that computers are electrical devices, and are capable of delivering a shock. Prevent damage to yourself and to your board: always ensure that your system is turned off and unplugged whenever you are working with it, and that you are equipped with a static safety device.

Hardware Specifications/Features

Processor Information*

- Intel Pentium/Pentium MMX
- AMD /K6/K6-2/K6-3
- Cyrix/6x86MX / MII
- IDT C6/C6+
- Front Side Bus support for 66 /75 /83 /95 /100MHz
- Integrated VRM
- Supports Core Voltage settings 1.3 - 3.5V
- Supports Clock Multiplier 2.5 - 5.5

On Board Cache

- On board Pipeline Burst SRAM 1MB
- 512K or 2MB (manufacturing option)

Chipset Information

- VIA MVP3 100MHz memory & AGP controller(VT82C598AT)
- VIA VT82C686 Super I/O controller

BIOS Information

- Award BIOS on 2MB flash RAM
- Plug and Play
- APM 1.2 / ACPI 1.0 / PC98 compliant
- IDE drive auto configure
- Soft power-down
- Multiple boot options
- DMI 2.0 compliant
- Hardware monitoring of CPU voltage, temperature, and Fan status

System Memory

- Supports 8MB to 768MB
- Three 3.3V unbuffered 168-pin DIMM sockets.
- Maximum rated memory bus speed 100MHz
- Supports EDO, SDRAM, Parity, and ECC (ECC only with Parity memory)

Expansion Slots

- One AGP Slot (supports 66/133MHz speeds)
- Five 32-bit PCI 2.1 Bus Master slots.
- Two 16-bit ISA slots.
- One shared, seven usable slots total.
- All slots support full length add-on cards

On Board PCI/IDE

- Two 40-pin IDE connectors for up to 4 drives
- PIO Mode 3 / 4, UltraDMA33/66 supported
- ATAPI IDE CD-ROM and LS-120 supported

On Board I/O

- One Floppy port (1.44MB, 2.88MB, 3-mode)
- Two 9-pin 16550 UART Serial ports
- One 25-pin ECP / EPP Parallel port
- One Fast IR TX / RX header
- Two USB (0,1) rev 1.2 ports
- Two USB (2,3) rev 1.2 ports via cable (optional)
- PS/2 Mouse and Keyboard ports

On Board Audio (Manufacturing Option)

- VIA VT82C686 digital link audio
- AC-97 Codec on board
- One MIDI / Game port
- Line-in MIC-in and Line-out ports
- 4-pin CD-ROM audio (ATAPI) header
- 4-pin Video-in (ATAPI) header

Other Features

- 3-pin Wake on LAN header*
- 3-pin Wake on Ring
- Two 3-pin Fan speed monitoring support

Form Factor

- ATX design (8.3" x 12.0")
- 4 Layer board
- 20-pin ATX power connector
- Stacked (double row) I/O connectors

* Requires ATX 2.01 power supply

Software Specifications

OS

- Operates with Windows 95, Windows 98, Windows NT 4.0, OS/2 v4.0, Novell Netware v5.0, and SCO Unix v5.05

Technical Support

If a problem arises with your system, you should turn to your dealer for help first. Your system has most likely been configured by them, and they should have the best idea of what hardware and software your system contains. Hence, they should be of the most assistance. Further, if you purchased your system from a dealer near to you, you can actually bring your system in to them to have it serviced, instead of attempting to do so yourself (which can have expensive consequences).

Help resources:

1. See FAQ and beep codes sections of this manual.
2. See Tyan web site for FAQ, bulletins, driver updates, etc.
<http://www.tyan.com>
3. Contact your dealer or distributor for help BEFORE calling Tyan.
4. Email Tyan tech support: techsupport@tyan.com
5. Call Tyan tech support: 510-440-8808

Returning Merchandise for Service

During the warranty period, contact your distributor or system vendor **FIRST** for any product problems. This warranty only covers normal customer use and does not cover damages incurred during shipping or failure due to the alteration, misuse, abuse, or improper maintenance of products.

For Resellers Only:

A receipt or copy of your invoice marked with the date of purchase is required before any warranty service can be rendered. You can obtain service by calling the manufacturer for a Return Merchandise Authorization (RMA) number. The RMA number should be prominently displayed on the outside of the shipping carton and the package should be mailed prepaid, or hand-carried to the manufacturer. TYAN will pay to have the board shipped back to you.

chapter 2

Board Installation

Unpacking

The mainboard package should contain the following:

- (1) S1598 mainboard
- (1) 40-pin IDE and 34-pin floppy cable pack
- (1) S1598 User's Manual
- (1) Driver CD

Precautions

What's the first thing I should do?

The first thing you should do is read this user's manual. It contains important information which will make configuration and setup much easier.

Here are some precautions you should follow when installing your motherboard:

- (1) **Ground yourself properly before removing your motherboard from the antistatic bag.** Unplug the power from your computer



and then touch any metal part on the computer case. (Or wear a grounded wrist strap.)

- (2) **Hold the motherboard by its edges and do not touch the bottom of the board.**
- (3) **Avoid touching motherboard components, IC chips, connectors, and leads.**
- (4) **Avoid touching pins of memory modules and chips.**
- (5) **Place motherboard on a grounded antistatic surface or on the antistatic bag.**

Having reviewed the precautions above, the next step is to take the motherboard out of the cardboard box and static bag, hold it by its edges, and place it on a grounded antistatic surface, component side up. Inspect the board for damage.



DO NOT APPLY POWER TO THE BOARD IF IT HAS BEEN DAMAGED!

Press down on any of the socket ICs if it appears that they are not properly seated (the board should still be on an antistatic mat). Do not touch the bottom of the board. Remember, don't take any electronic device out of its protective bag until you are ready to actually install it into the computer case. If you do not ground yourself, you risk zapping the motherboard or adapter card. Subsequent problems may not arise immediately because electrostatic discharge damage, unlike physical damage, causes the device to fail over time.

***Power Supply Requirement: If you use an ATX Power Supply, it should be 2.01 compliant. Standby current must be 750mA or higher (SB5V = 0.75A)**

Installation Steps

You are now ready to install your mainboard. The mounting hole pattern of the S1598 matches the ATX system board specifications. Your chassis should have standard ATX mainboard form factor mounting holes and an ATX power supply.



1. Set Jumpers
2. Mount Motherboard in Chassis
3. Install Memory
4. Install CPU & Cooling Fan
5. Connect IDE and Floppy Drives

- 6. Connect Power Supply
- 7. Install Add-on Cards
- 8. Connect PS/2, USB, Serial and Parallel Devices

What is a Jumper?

In this manual, the terms “closed” and “on” are used when referring to jumpers (or jumper pins) that are active; “open” and “off” are used when referring to jumpers (or jumper pins) that are inactive. See the **Figure 2-1** for examples of “on” and “off” pins and jumpers. The square pin in the diagram is Pin 1.

Jumpers and pins are connected by slipping the blue plastic jumper connector overtop of two adjacent jumper pins (indicated by **1-2** or **2-3**). The metal rod inside the plastic shell bridges the gap between the two pins, completing the circuit. See **Figure 2-2** for more examples of pin connections.

The tables and maps on the following pages will help you set the jumpers for CPU speed, Infrared, and external connector pin assignments, among others. The miniature motherboard maps will help you locate the jumpers on your board. A full-page map of the motherboard can be found on the next two pages.

INSTALL

2 pin jumpers

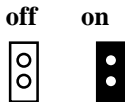

Figure 2-1

3 (or more) pin jumpers

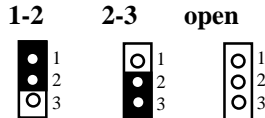
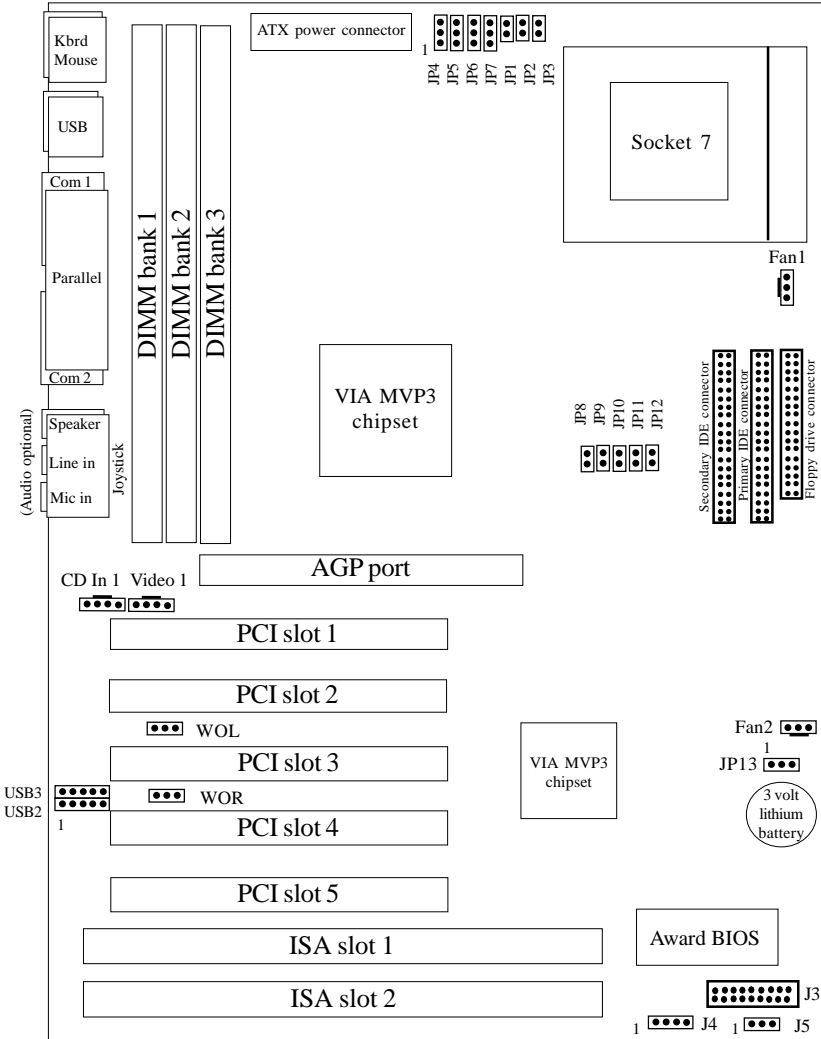

Figure 2-2

Map of Motherboard Jumpers



The tiny number “1”s next to jumpers of 3 pins or more indicate the position of pin 1 for that jumper.

Picture of Motherboard Features

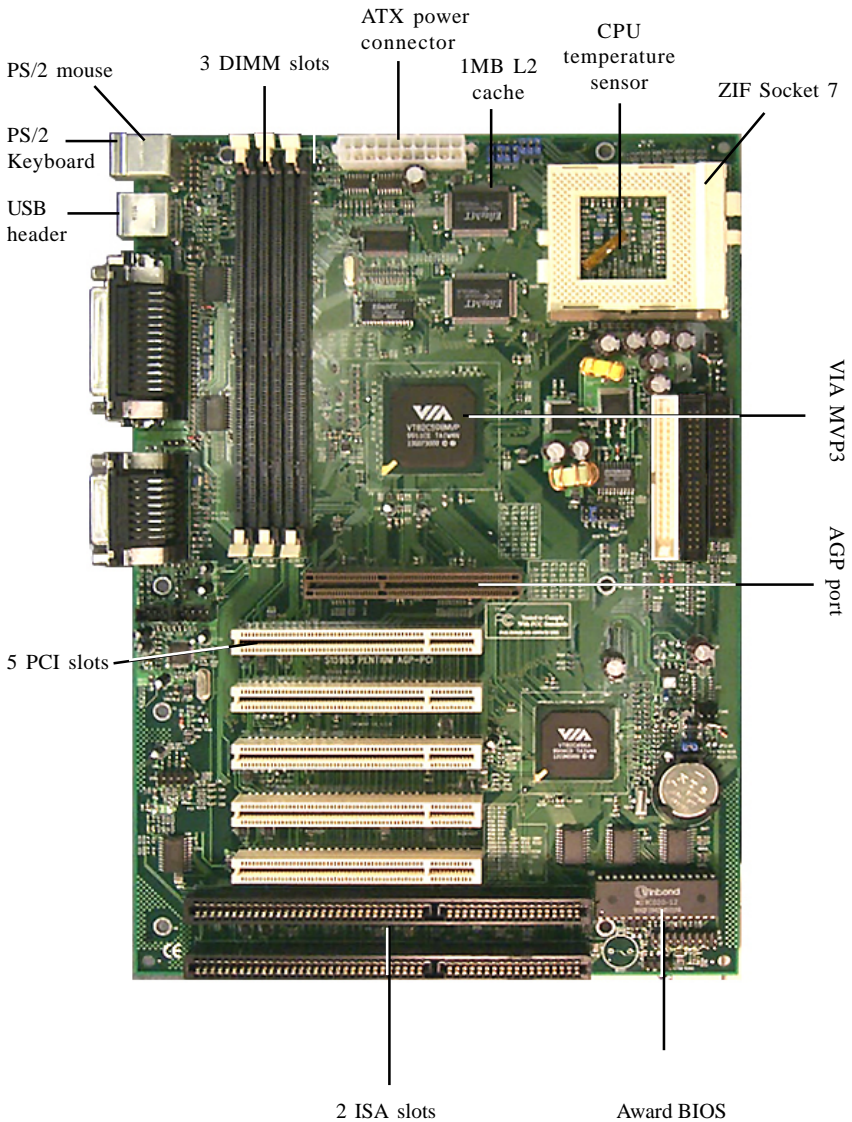

INSTALL

1. Setting Jumpers

1-A. CPU Bus Speed Settings

Bus Speed	JP4	JP5	JP6
60MHz	2-3	2-3	2-3
66MHz	1-2	2-3	2-3
75MHz	1-2	1-2	2-3
83MHz	1-2	2-3	1-2
95MHz	2-3	1-2	1-2
100MHz	1-2	1-2	1-2

1-B. CPU Clock Multiplier

Multiplier	JP1	JP2	JP3
2.5x	ON	ON	OFF
3x	OFF	ON	OFF
3.5x	OFF	OFF	OFF
4x	ON	OFF	ON
4.5x	ON	ON	ON
5x	OFF	ON	ON
5.5x	OFF	OFF	ON

1-C. CPU Core Voltage Settings

CPU Voltage	JP8	JP9	JP10	JP11	JP12
1.3V	OFF	OFF	OFF	OFF	ON
1.4V	OFF	ON	OFF	OFF	ON
1.5V	OFF	OFF	ON	OFF	ON
1.6V	OFF	ON	ON	OFF	ON
1.7V	OFF	OFF	OFF	ON	ON
1.8V	OFF	ON	OFF	ON	ON
1.9V	OFF	OFF	ON	ON	ON
2.0V	OFF	ON	ON	ON	ON
2.1V	ON	OFF	OFF	OFF	OFF
2.2V**	OFF	ON	OFF	OFF	OFF
2.3V	ON	ON	OFF	OFF	OFF
2.4V	OFF	OFF	ON	OFF	OFF

CPU Voltage	JP8	JP9	JP10	JP11	JP12
2.5V	ON	OFF	ON	OFF	OFF
2.6V	OFF	ON	ON	OFF	OFF
2.7V	ON	ON	ON	OFF	OFF
2.8V	OFF	OFF	OFF	ON	OFF
2.9V	ON	OFF	OFF	ON	OFF
3.0V	OFF	ON	OFF	ON	OFF
3.1V	ON	ON	OFF	ON	OFF
3.2V	OFF	OFF	ON	ON	OFF
3.3V	ON	OFF	ON	ON	OFF
3.4V	OFF	ON	ON	ON	OFF
3.5V	ON	ON	ON	ON	OFF

** Default Setting (2.2V)

The CPU speed is controlled by setting the bus speed and the multiplier with the jumpers described above that are appropriate for your CPU and memory. You must have a 100MHz processor AND PC/100 memory to run at a bus speed of 100MHz. Tyan does not recommend operating CPUs, memory or PCI bus at higher than rated speed. Tyan takes no responsibility for any problems related to overclocking any bus or component on the system board.



1-D. J3 External Pin Assignments

HDD LED	VCC	1	2	Power LED	Power/Slip LED
	LED	3	4	Ground	
Reset Switch	Ground	5	6	Power On/Off	Power Switch
	Switch	7	8	Ground	
Infrared	VCC	9	10	Ground	SMI Switch
	Receive	11	12	K/B Lock	
	IRRX	13	14	Ground	
	Ground	15	16	SMI Switch	
IRTX	17	18	Ground		

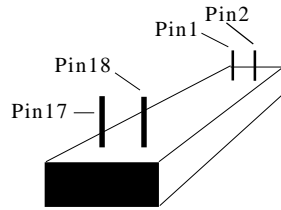

J3 Side View

1-E. FAN Pin Assignments

	1	2	3
FAN1, FAN2	GND	+12V	Fan Monitor

1-F. Memory Clock

The memory clock can be set to run at the CPU clock speed or to the AGP bus speed (normally 66MHz). The benefit of this setting is that you can run the CPU bus at 100MHz with only 66MHz memory by setting the memory clock jumper to AGP.

Memory Clock	JP7
CPU Clock	1-2
AGP Clock	2-3

CMOS	JP13
Default	1-2
Reset CMOS	2-3

Hardware CMOS & Password Reset

If you have been locked out of your system because you forgot your password or set the CMOS incorrectly, follow the instructions below.

1. Power off the system
2. Set jumper JP13 to pins 2 and 3
3. Wait for 2 seconds, then return jumper JP13 to pins 1 and 2.
4. Power on the system again.

By following this procedure, you will erase your password and reset the CMOS to the BIOS defaults.

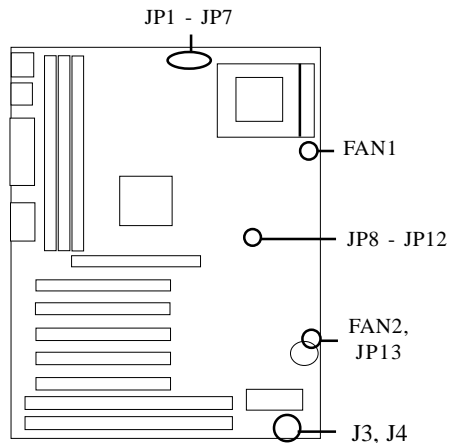

ACPI Bi-Color LED Connector (J5)

This connector provides a bi-color (green / yellow) LED for your computer chassis. When the computer system is On, the Green LED will light up. If the system is on stand-by mode, the Yellow LED will light up. Whenever there is an incoming message, the LED will flash on and off.

Soft Power Connector

The Soft Power Connector is located on pins 6 and 8 of jumper block J3. Pressing the Soft Power Button will turn the system on and off. Holding this button for more than four seconds (when the system is on) will power down the system. Pressing it again will reboot the system.

Speaker Connector Installation

The Trinity ATX provides a 4-pin header to connect the speaker. The speaker is connected to jumper block J4.

CMOS RTC

The VIA MVP3 AGPset includes a Real Time Clock (RTC) circuit, which provides the date and time for the system. If the external battery for the RTC is low, you will lose your BIOS settings. Normally the life span of an external battery is 2 years. If yours is running low, you will need to replace it with a new 3V lithium battery (Sony CR2032).

USB

There are two ATX Universal Serial Bus ports on the back of the board. The board also has an additional USB header (USB2, USB3) on the edge of the board near the third PCI slot. This header can be used to connect a USB port on the front of the chassis.

Flash EEPROM

The Trinity ATX uses flash memory to store BIOS programs. It can be easily updated if necessary using the flash utility (see page 57). Tyan does not recommend flashing the BIOS unnecessarily. Check the Tyan web site for the latest BIOS revision.

2. Mounting the Motherboard in the Chassis

Follow the instructions provided by the case manufacturer for proper installation guidelines. TYAN recommends that you use only one screw to hold down the motherboard. The rest of the mounting holes should be used for the plastic standoffs. If your case does not have a hole for a standoff, simply cut off the

bottom of the plastic standoff so that the flat portion rests on the metal. The adapter cards and the screws holding them down will keep your board flat. The fastening screw should not short any of the traces on the motherboard. Make certain that you do not overtighten the screw, as it will damage the motherboard and possibly break internal traces in the surrounding area. The hole you should use is located at the top-center of the board where the adapter cards are fastened to the case.

3. Installing Memory

Since TYAN boards are manufactured with performance in mind, you should use add-in components that match. Some DIMM modules may seem to be high quality because of name or feel but that does not guarantee real-world usability. Some cheaper or OEM memory may have brand-name components, but they may contain inferior or substandard parts which do not meet the critical tolerances our products require. Because of this, your memory may not work correctly in a TYAN board though it may work well in a competitor's board. This is because many of our competitors do not adhere to the strict tolerances required for high performance. If you buy a TYAN board, you are getting the best system available. To make installation easy and trouble free, get high quality parts. Some brands we recommend are Corsair Microsystems, Kingston Memory, and QesTec Incorporated. These DIMMs have proven to be very stable on our boards and perform extremely well. For a list of recommended memory vendors, please visit Tyan's website at www.tyan.com (go to the Memory Support area in the Support section).

This table lists some of the possible memory configurations. Not all possible configurations are listed.



Note: This board does NOT support Registered DIMMs. Check with your memory dealer for more information.

DIMM Bank 1	DIMM Bank 2	DIMM Bank 3	Total
8MBx1	0	0	8MB
8MBx1	8MBx1	0	16MB
8MBx1	8MBx1	8MBx1	24MB
16MBx1	8MBx1	8MBx1	32MB
16MBx1	16MBx1	16MBx1	48MB
32MBx1	16MBx1	16MBx1	64MB
32MBx1	32MBx1	8MBx1	72MB
64MBx1	32MBx1	32MBx1	128MB
64MBx1	64MBx1	32MBx1	160MB
64MBx1	64MBx1	64MBx1	192MB
128MBx1	64MBx1	64MBx1	256MB
128MBx1	128MBx1	64MBx1	320MB
128MBx1	128MBx1	128MBx1	384MB
256MBx1	256MBx1	256MBx1	768MB

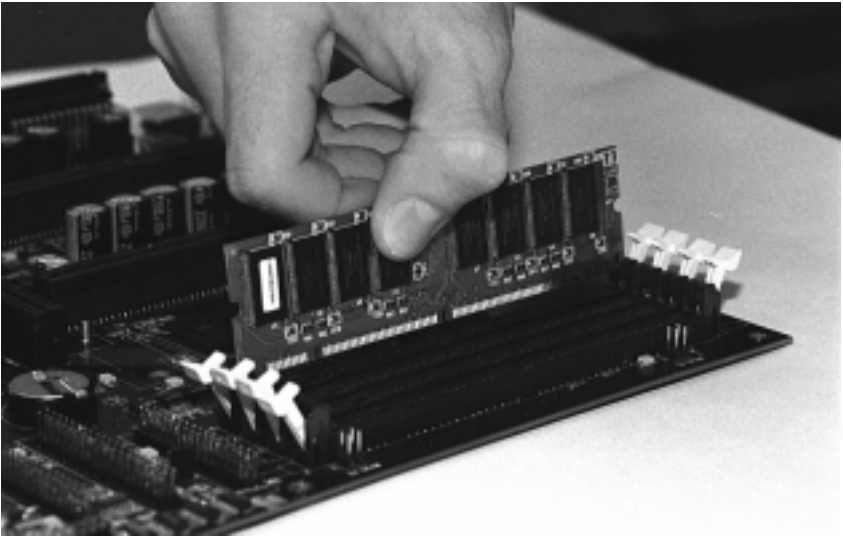

Figure 2-3

*The image above is used to illustrate a concept and may not represent the actual image of your motherboard.

To install your DIMMs, line your module up so that the pins fit into the slot. There is only one way that your DIMM can fit properly. Make sure that the short row of pins is lined up with the short gap in the DIMM slot. Figure 2-3 above shows how to sit the DIMM into its slot. To insert the DIMM, push down vertically on the module with even force, as shown in the photo. Do not shove one end in first; doing so will bend the DIMM pins.

To lock the DIMM into place, push the plastic clips on either end of the slot onto the notches in the ends of the DIMM (see Figure 2-4 on the next page). To remove your DIMM, simply pull the clips back, and pull up on the module. Place the DIMMs in an anti-static bag as soon as you remove them to avoid static damage.

The Trinity 100AT uses a 64-bit data path from memory to CPU and can accommodate up to 384MB of SDRAM. The 168-pin DIMMs (Dual In-line Memory Modules) must be of the 3.3V, **unbuffered** variety. The position of the notch in the SDRAM key position will tell you whether or not a DIMM is unbuffered (see Figure 2-5 below). All installed memory will be automatically detected, so there is no need to set any jumpers.

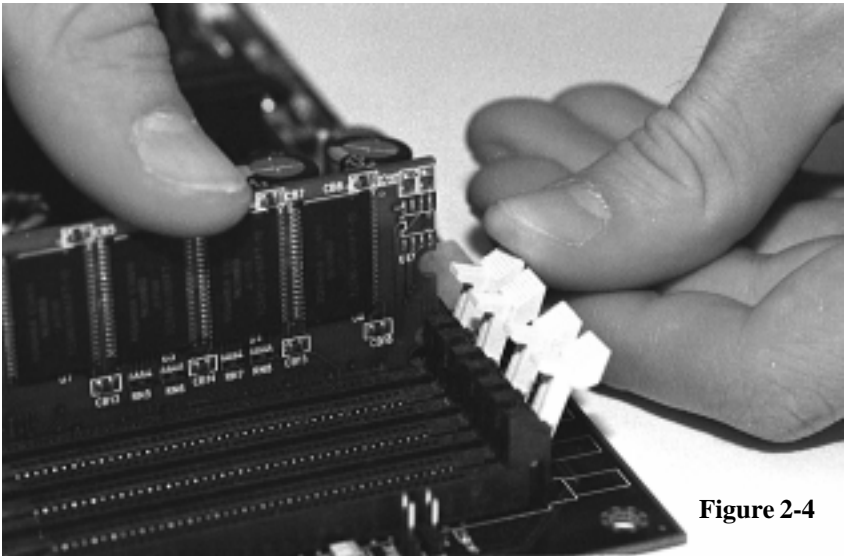

Figure 2-4

*The image above is used to illustrate a concept and may not represent the actual image of your motherboard.

Some details of memory installation:

- The mainboard supports 32MB, 64MB, 128MB SDRAM modules.
- PC-100 DIMMs are required if CPU bus speed is at 100MHz
- SDRAM, Parity, and ECC (using Parity memory) memory is supported.

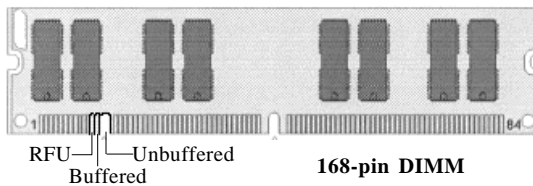

Figure 2-5

Cache Memory

The Trinity ATX has 1MB (or 2MB) of onboard pipeline burst SRAM. This SRAM cannot be upgraded.

4. Installing the CPU and Cooling Fan

Socket 7 processors (see Specifications on page 5) can be used on the Trinity ATX. Please refer to page 14 for the correct CPU jumper settings for your CPU. Remember:

- The CPU is a sensitive electronic component and it can easily be damaged by static electricity. Do not touch the CPU pins with your fingers.
- Before the CPU is installed, the mainboard must be placed on a flat surface. You should be able to insert the CPU with minimal, but firm, pressure. Do not press down hard on the CPU.



Figure 2-6

In Figure 2-6, you can see the CPU and the ZIF socket. Notice that the arm of the ZIF socket is up. When this arm is up, the CPU is unlocked from the socket and allows you to remove or install a CPU. As the ZIF socket is keyed to the processor that you are using, you will only be able to install the CPU one way, thus eliminating the chance for error. Pin 1 on the CPU is



Figure 2-7

denoted by a small dot on one of the corners and Pin 1 on the ZIF socket is denoted by an angled corner. Never force a CPU into a socket. Forcing a CPU to seat will bend the pins on the CPU and possibly damage the motherboard. Check with your vendor or manufacturer for proper voltage selection.



important!

Push down lightly on the CPU, and lower the arm on the ZIF socket to secure the CPU. A squeaking noise is normal as the arm lowers. After the CPU is securely seated, install the appropriate cooling device (Figure 2-7). Tyan strongly recommends a heatsink/fan combination. Consult with your case manufacturer for other cooling options.

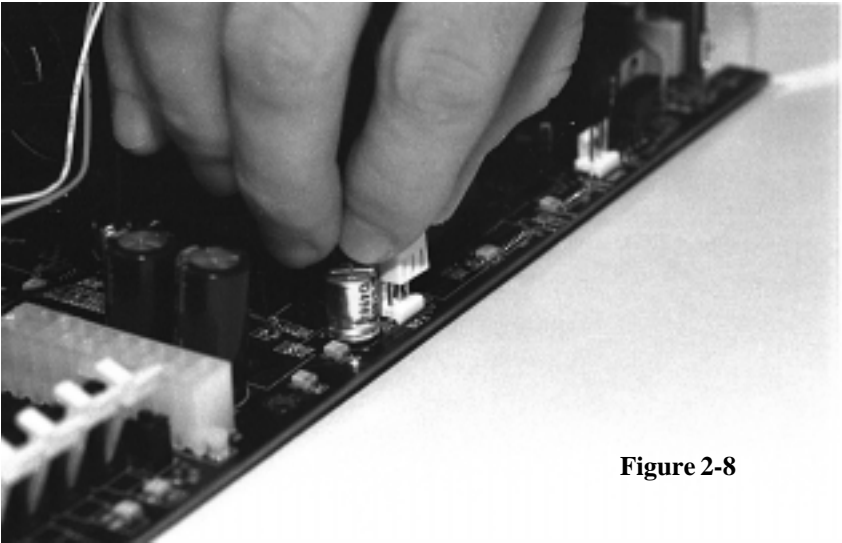

Figure 2-8

Locate the cooling fan connector (e.g. CPU Fan, Fan1) on the motherboard. Plug the CPU's cooling fan cable into the cooling fan connector on the board. There will be a plastic clip assembly similar to that of the ATX power connector that will force you to connect the fan cable correctly (see Figure 2-8 above).



Figure 2-9

5. Connecting IDE and Floppy Drives

The colored stripe on a ribbon cable should face toward the keyboard connector. In Figure 2-9 on the previous page, you can see how the IDE cables should look when they are connected to your hard drive. Notice how Pin 1 (denoted by a red stripe) is connected so that it is next to the power connector of the drive. The primary IDE connector is black; the secondary IDE connector is white.

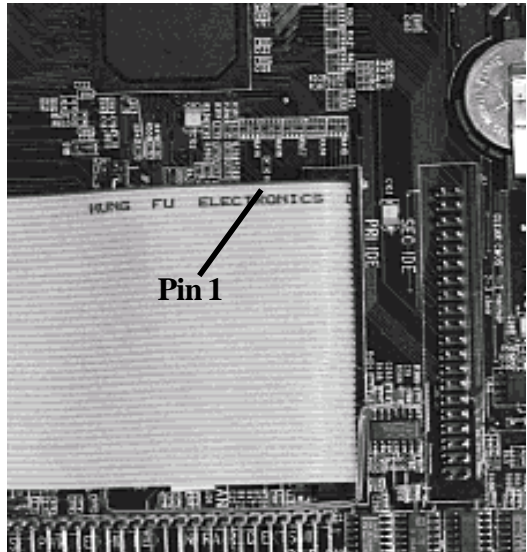

Figure 2-10

In most cases, this is the proper way of connecting your IDE cable to the harddrive. Figure 2-10 shows the IDE cable properly connected to the motherboard. Contact your hard disk drive manufacturer or documentation for more information.

ATA-66 IDE hard drives require a special IDE cable which has additional grounding wires. The cable is sold separately, and is required when using ATA-66 drives. This cable will also support all legacy IDE drives.

Some symptoms of incorrectly installed HDDs are:

- Hard disk drives are not auto-detected: may be a Master / Slave problem or a bad IDE cable. Contact your vendor.
- Hard Disk Drive Fail message at bootup: may be a bad cable or lack of power going to the drive.
- No video or beeps on bootup: usually means the cable is on backwards.
- Hard drive lights are constantly on: bad IDE cable or defective drives/motherboard. Try another HDD.
- Hard drives do not power up: check power cables and cabling. May also be caused by a bad power supply or IDE drive.

Figure 2-11

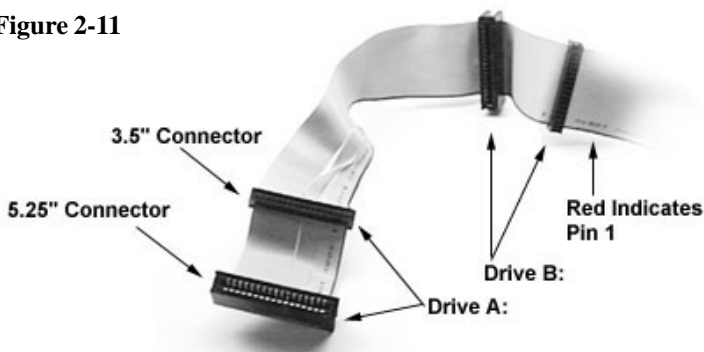

Connecting Floppy Drives

Pin 1 on the floppy cable is usually denoted by a red or colored stripe down one side of the cable (see Figure 2-11 on the following page). Most of the current floppy drives on the market require that the colored stripe be positioned so that it is right next to the power connector. In most cases, there will be a key pin on the cable which will force you to connect the cable properly. Drive A: is usually attached to the end of the cable with the twist in it. Drive B: is usually connected to the middle of the cable. Refer to your installation instructions or call your dealer if you are unsure about attaching floppy drives. Refer to Figure 2-11 for a detailed anatomy of the floppy cable. Remember, you can only have 2 floppy drives connected at any given time.

Some symptoms of incorrectly installed floppies are:

- Floppy drives are not detected: usually caused by faulty cables, backward cables, or a bad floppy or motherboard. Try another single floppy drive to verify the problem or try another cable. Also, check to see if the onboard floppy is enabled in the BIOS.
- Floppy Drive Fail message at bootup: the cable, floppy, or motherboard may be faulty. Try another cable or floppy drive to verify.
- Light on the floppy is on constantly: a dead giveaway that the cable is on backwards. Reverse the cable at the motherboard end and try again.

6. Connecting the Power Supply

The Trinity ATX requires an ATX power supply. The photos on the next page show the ATX power connector before (Figure 2-12) and after (Figure 2-13) it has been plugged in. The plastic clip on the power connector should lock over the plastic tab on the onboard connector. You shouldn't be able to plug the power connector in any other way but just to be safe, make sure it looks like



Figure 2-12

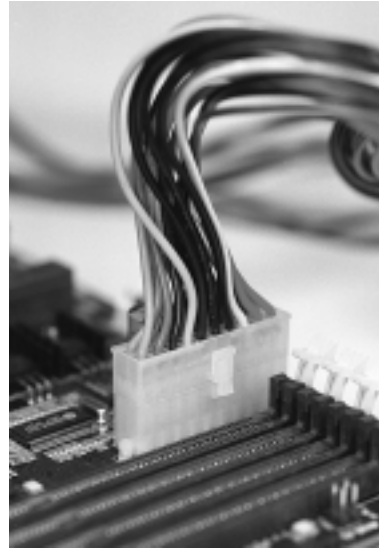

Figure 2-13

Figure 2-13.

Make absolutely certain that you do not miss any pins, because if you do you will void your warranty and cause damage to yourself or your motherboard when you turn the system on. After connecting the power, make sure the connector is seated firmly into its socket so it will not become loose or fall off when the computer is jostled or moved. Note: Tyan recommends using one that conforms to industry standard revision 2.01.

7. Installing Add-on Cards

There are a few rules you need to follow when plugging in a card. In order to assure proper operation and a quick installation, adhere to these guidelines:



- If you are going to install a PCI-Bus interface card on your system, be aware that any one of the two PCI slots can support a Master or Slave device.
- NEVER force a card into a slot. If it doesn't fit, look at the socket on the computer to make sure there are no wires or other obstructions to the slot.
- NEVER plug an ISA card into a PCI slot or a PCI card in an ISA slot. You will void your warranty and damage your system board if

- you do this.
- When plugging the card in, especially when installing long cards, try to push the entire card in at one time. Don't force one end of the card into the socket first and then the other. This will create a rocking motion between the card and the slot and it will damage the pins within the socket.
 - Make sure that the cards are seated securely into the slots.
 - Before turning on the system, make sure no cards are touching.

If you follow these basic guidelines, there shouldn't be any problems with installation. However, if you do encounter any problems, have a qualified professional install your cards for you or contact your card manufacturer.

Remember, always read the manuals and installation notes that come with the adapter cards. They contain important information which will help you install the components right, the first time.

8. Connecting PS/2, USB, Serial & Parallel Devices

This board includes ports for USB, PS/2 mouse, and PS/2 keyboard devices. Note that, for this board, the PS/2 mouse port is the upper PS/2 port, and the PS/2 keyboard port is the lower PS/2 port.

The PS/2 connectors are probably quite familiar to you. The USB connectors, however, may be foreign. The USB (Universal Serial Bus) is a versatile port. This one port type can function as a serial, parallel, mouse, keyboard, or

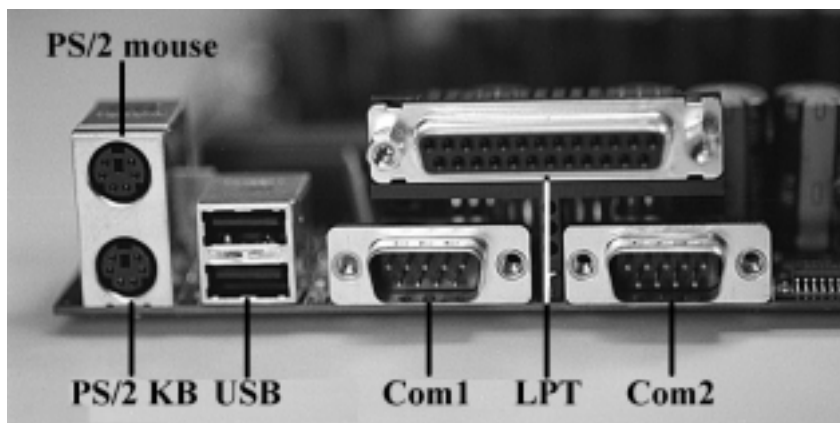

Figure 2-14

Chapter 2

Board Installation

joystick port. It is fast enough to support video transfer, and is capable of supporting up to 127 daisy-chained peripheral devices.

Connecting Com and Printer Ports



Warning: When plugging in your keyboard and mouse, or when plugging anything into a serial or Com port, make sure that the power is off. Connecting these devices and ports while the power is on is called “hot plugging,” and may damage your system.

Figure 2-14 on the previous page shows the ATX double row connectors on this board. The Com and Printer ports, as well as the other ports, are labeled. Note: Only TYAN cables will work on this motherboard. If you are using an existing case with old cables, your system will not function properly. Use only TYAN-approved cables.

You are done!

Other than checking the jumper settings and cable connections and putting the case back on, you are done. Installing a new motherboard may sound difficult, but by following these directions, you should have had a fairly uneventful time installing our products. If you did encounter problems, your dealer will be able to help you, or you can consult one of our many technical support resources (see page 7).

Frequently Asked Questions

Q: My system sometimes becomes unstable. How should I check the system?

A: The first thing to do is to check and see if you have any device conflict in address, IRQ, or DMA. If you are using Windows 95, the Device Manager is a good place to start. Please consult your operating system manual for details. Second of all, slowing down the memory timing in the BIOS’s chipset setup section will help the situation, as well. Many memory modules are not suitable for high performance systems and are probably the main source of your problem.

Q: What is AGP?

A: AGP (Accelerated Graphics Port) is a new bus architecture for 3D graphics. The AGP slot eliminates the PCI bandwidth bottleneck by bypassing the PCI interface and accessing the system memory directly. Currently, the AGP supports 1X and 2X modes, which yield bandwidths of 264MB/s (at 33MHz bus speed) and 533MB/s (at 66MHz bus speed), respectively. Compare this

with the mere 132MB/s (at 33MHz bus speed) that you get with the PCI bus.

Q: Does my operating system support AGP?

A: Currently, only Windows 98 and Windows NT 5.0 will have built-in support for AGP. Some AGP cards require Windows 95 OSR2.1 or a special driver from Intel. Please check with your graphics vendor for more details.

Q: My AGP Video has an Intel i740 chipset and gives me problems when I plug it onto this motherboard, why?

A: There is a known incompatibility with the Intel i740 chipset and the VIA Apollo chipset on the motherboard. In addition, Windows NT 4.0 does not support Intel's i740 and older chipsets. Nor does it support VIA apollo chipset. Such a combination will definitely cause a conflict. One solution to this problem is to install VIA's AGP driver (AGP driver ver. 2.6 or later). It is included on the Tyan Driver CD, or you can download it from Via's web site at <http://www.via.com.tw/drivers/index.htm>.

Q: How do I identify Pin #1 of a 3-pin jumper?

A: There should be a small numeral 1 silkscreened on the board in white next to pin 1. You can also look on the back side of the board, pin 1 is identified with a square solder footprint.

Q: Does the motherboard support 2X AGP?

A: Yes, the S1598 supports x2 AGP.

Q: What drivers do I install from the CD-ROM provided with the S1598 motherboard?

A: Inside the CD-ROM provided with the Trinity motherboard are Win95, Win98, and WinNT 4.0 drivers for VIA MVP3 chipset and are located in the VIA folder.

The "agpvxd" folder will install driver support for AGP video. NOTE: this driver is for Win95 users only, however, some Win98 users may need to install this driver who are having conflicts in Device Manager. There are no drivers for WinNT 4.0

The "Bmide" folder will install driver support for VIA IDE Busmaster.

NOTE: this driver is for Win95 and WinNT 4.0 users. Win98 users normally DO NOT have to install this driver; Win98 has built in VIA IDE Bustmaster driver when installed originally. Install only if you are having conflicts or exclamation marks with Hard disk controllers in Device Manager

The "viareg" folder is for "VIA Power Management Controller" and "VIA PCI to USB Universal Host Controller". NOTE: this driver is for Win95 users. There are no drivers for WinNT 4.0. No need to install for Win98 users.

The "virq13 or virq11" folder will install "VIA PCI IRQ Routing Miniport Driver". NOTE: Enable "OnChip USB" in BIOS Chipset Features setup menu and Enable "Assign IRQ for USB" in PNP/PCP Configuration Setup menu. NOTE II: this driver is for Win95 users only, however, some Win98 users may need to install this driver who are having conflicts in Device Manager. There are no drivers for WinNT 4.0

- Q:** When Windows 95 restarts for the first time I get the following message: "Device IOS failed to initialize. Windows Protection Error. You must reboot your computer." How do I fix this to get into Windows 95 normally?
- A:** Follow the following link to download the patch file for this problem:
http://www.amd.com/products/cpg/k623d/win95_update_k6.html

This page intentionally left blank.

chapter 3

BIOS Configuration

Introduction to Setup

This manual describes the Award EliteBIOS Setup program. The Setup program lets you modify basic system configuration settings. The settings are then stored in a dedicated battery-backed memory, called CMOS RAM, that retains the information when the power is turned off.

The EliteBIOS in your computer is a customized version of an industry-standard BIOS for IBM PC AT-compatible personal computers. It supports Intel x86 and compatible processors. The BIOS provides critical low-level support for the system central processing, memory, and I/O subsystems.

The EliteBIOS has been customized by adding important, but nonstandard, features such as virus and password protection, power management, and detailed fine-tuning of the chipset controlling the system. The rest of this manual is intended to guide you through the process of configuring your system using Setup.

Starting Setup

The EliteBIOS is immediately activated when you first turn on the computer. The BIOS reads system configuration information in CMOS RAM and begins

the process of checking out the system and configuring it through the power-on self test (POST).

When these preliminaries are finished, the BIOS seeks an operating system on one of the data storage devices (hard drive, floppy drive, etc.). The BIOS launches the operating system and hands control of system operations to it.

During POST, you can start the Setup program in one of two ways:

1. By pressing immediately after switching the system on, or
2. By pressing the key or by simultaneously pressing <Ctrl>, <Alt>, and <Esc> keys when the following message appears briefly at the bottom of the screen during POST:

TO ENTER SETUP BEFORE BOOT PRESS DEL KEY

If the message disappears before you respond and you still wish to enter Setup, restart the system to try again by turning it OFF then ON or pressing the RESET button on the system case. You may also restart by simultaneously pressing <Ctrl>, <Alt>, and <Delete> keys. If you do not press the keys at the correct time and the system does not boot, an error message appears and you are again asked to

PRESS F1 TO CONTINUE, DEL TO ENTER SETUP

Setup Keys

The table on the following page shows how to navigate in Setup using the keyboard.

Getting Help

Press F1 to pop up a small help window that describes the appropriate keys to use and the possible selections for the highlighted item. To exit the Help Window press <Esc> or the F1 key again.

In Case of Problems

If, after making and saving system changes with Setup, you discover that your computer no longer is able to boot, the EliteBIOS supports an override to the CMOS settings that resets your system to its default configuration.

Key	Function
Up arrow	Move to previous item.
Down arrow	Move to next item.
Left arrow	Move to item on the left hand.
Right arrow	Move to item on the right hand.
Esc key	Main Menu: Quit and do not save changes into CMOS RAM. Status Page Setup Menu: Exit current page and return to Main Menu.
PgUp key	Increase the numeric value or make changes.
PgDn key	Decrease the numeric value or make changes.
+ key	Increase the numeric value or make changes.
- key	Decrease the numeric value or make changes.
F1 key	General help, only for Status Page Setup Menu and Option Page Setup Menu.
F2 key Shift-F2	Change color from total 16 colors. F2 to select color forward, Shift-F2 to select color backwards.
F3 key	Calendar, only for Status Page Setup Menu.
F4 key	Reserved.
F5 key	Restore the previous CMOS value from CMOS, only for Option Page Setup Menu.
F6 key	Load the default CMOS RAM value from BIOS default table, only for Option Page Setup Menu.
F7 key	Load the default.
F8 key	Reserved.
F9 key	Reserved.
F10 key	Save all the CMOS changes, only for Main Menu.

You can invoke this override by immediately pressing <Insert> when you restart your computer. You can restart by either using the ON/OFF switch, the RESET button or by pressing <Ctrl>, <Alt> and <Delete> at the same time.

The best advice is to alter only settings that you thoroughly understand. In particular, do not change settings in the Chipset screen without a good reason. The Chipset defaults have been carefully chosen by Award Software or your system manufacturer for the best performance and reliability. Even a seemingly small change to the Chipset setup may causing the system to become unstable.

Setup Variations

Not all systems have the same Setup. While the basic look and function of the Setup program remains the same for all systems, the appearance of your Setup screens may differ from the screens shown here. Each system design and chipset combination require custom configurations. In addition, the final appearance of the Setup program depends on your system designer. Your system designer can decide that certain items should not be available for user configuration and remove them from the Setup program.

Main Setup Menu

When you enter the EliteBIOS CMOS Setup Utility, a Main Menu, similar to the one shown below, appears on the screen. The Main Menu allows you to select from several Setup functions and two exit choices. Use the arrow keys to select among the items and press enter to accept and enter the sub-menu.

A brief description of each highlighted selection appears at the bottom of the screen. Following is a brief summary of each Setup category.

ROM PCI/ISA BIOS (2A5LET5A)
 CMOS SETUP UTILITY
 AWARD SOFTWARE, INC.

STANDARD CMOS SETUP	INTEGRATED PERIPHERALS
BIOS FEATURES SETUP	SUPERVISOR PASSWORD
CHIPSET FEATURES SETUP	USER PASSWORD
POWER MANAGEMENT SETUP	IDE HDD AUTO DETECTION
PNP/PCI CONFIGURATION	SAVE & EXIT SETUP
LOAD BIOS DEFAULTS	EXIT WITHOUT SAVING
LOAD SETUP DEFAULTS	
Esc : Quit F10 : Save & Exit Setup	
↑ ↓ → ← : Select Item (Shift)F2 : Change Color	
Time, Date, Hard Disk Type ...	

Standard CMOS Setup

Options in the original PC AT-compatible BIOS.

BIOS Features Setup

Award Software enhanced BIOS options.

Chipset Features Setup

Options specific to your system chipset.

Power Management Setup

Advanced Power Management (APM) options.

PnP/PCI Configuration

Plug and Play standard and PCI Local Bus configuration options.

Integrated Peripherals

I/O subsystems that depend on the integrated peripherals controller in your system.

Supervisor/User Password

Change, set, or disable a password. In BIOS versions that allow separate user and supervisor passwords, only the supervisor password permits access to Setup. The user password generally allows only power-on access.

IDE HDD Auto Detection

Automatically detect and configure IDE hard disk parameters.

Load BIOS Defaults

BIOS defaults are factory settings for the most stable, minimal-performance system operations.

Load Setup Defaults

Setup defaults are factory settings for optimal-performance system operations.

Save & Exit Setup

Save settings in nonvolatile CMOS RAM and exit Setup.

Exit Without Saving

Abandon all changes and exit Setup.

Standard CMOS Setup

In the Standard CMOS menu you can set the system clock and calendar, record disk drive parameters and the video subsystem type, and select the type of errors that stop the BIOS POST.

Date

The BIOS determines the day of the week from the other date information. This

```
ROM PCI/ISA BIOS (2A5LET59)
STANDARD CMOS SETUP
AWARD SOFTWARE, INC.
```

Date (mm:dd:yy) : Fri, Jul 10 1998									
Time (hh:mm:ss) : 10 : 7 : 7									
HARD DISKS	TYPE	SIZE	CYLS	HEAD	PRECOMP	LANDZ	SECTOR	MODE	
Primary Master	: Auto	0	0	0	0	0	0	AUTO	
Primary Slave	: Auto	0	0	0	0	0	0	AUTO	
Secondary Master	: Auto	0	0	0	0	0	0	AUTO	
Secondary Slave	: Auto	0	0	0	0	0	0	AUTO	
Drive A	: 1.44M, 3.5 in.								
Drive B	: None								
Floppy 3 Mode Support	: Disabled								
Video	: EGA/VGA								
Halt On	: All Errors								
					Base Memory: 640K				
					Extended Memory: 130048K				
					Other Memory: 384K				
					Total Memory: 131072K				
ESC	: Quit	↑ ↓ → ←			: Select Item			PU/PD/+/- : Modify	
F1	: Help	(Shift)F2			: Change Color				

BIOS

field is for information only. Press the arrow keys to move to the desired field (date, month, year). Press the PgUp or PgDn key to increment the setting, or type the desired value into the field.

Time

The time format is based on the 24-hour military-time clock. For example, 1 p.m. is 13:00:00. Press the arrow keys to move to the desired field. Press the PgUp or PgDn key to increment the setting, or type the desired value into the field.

HARD DISKS

The BIOS supports up to four IDE drives. This section does not show information about other IDE devices, such as a CD-ROM drive, or about other

hard drive types, such as SCSI drives. Note: We recommend that you select type auto for all drives.

The BIOS can automatically detect the specifications and optimal operating mode of almost all IDE hard drives. When you select type auto for a hard drive, the BIOS detects its specifications during POST, every time the system boots. If you do not want to select drive type auto, other methods of selecting the drive type are available:

1. Match the specifications of your installed IDE hard drive(s) with the preprogrammed values for drive types 1 through 45.
2. Select User and enter values into each drive parameter field.
3. Use the IDE HDD Auto Detection function in Setup.

Here is a brief explanation of drive specifications:

Type: The BIOS contains a table of pre-defined drive types. Each defined drive type has a specified number of cylinders, number of heads, write precompensation factor, landing zone, and number of sectors. Drives whose specifications do not accommodate any pre-defined type are classified as type user.

Size: Disk drive capacity (approximate). Note that this size is usually slightly greater than the size of a formatted disk given by a disk-checking program.

Cyls: Number of cylinders

Head: Number of heads

Precomp: Write precompensation cylinder

Landz: Landing zone

Sector: Number of sectors

Mode: Auto, Normal, large, or LBA

Auto: The BIOS automatically determines the optimal mode.

Normal: Maximum number of cylinders, heads, and sectors supported are 1024, 16, and 63.

Large: For drives that do not support LBA and have more than 1024 cylinders.

LBA (Logical Block Addressing): During drive accesses, the IDE controller transforms the data address described by sector, head, and cylinder number into a physical block address, significantly improving data transfer rates. For drives with greater than 1024 cylinders.

Drive A, Drive B

Select the correct specifications for the diskette drive(s) installed in the computer.

None	No diskette drive installed
360K, 5.25 in	5-1/4 inch PC-type standard drive; 360 kilobyte capacity
1.2M, 5.25 in	5-1/4 inch AT-type high-density drive; 1.2 megabyte capacity
720K, 3.5 in	3-1/2 inch double-sided drive; 720 kilobyte capacity
1.44M, 3.5 in	3-1/2 inch double-sided drive; 1.44 megabyte capacity
2.88M, 3.5 in	3-1/2 inch double-sided drive; 2.88 megabyte capacity

Floppy 3 Mode Support

When Enabled, the BIOS supports a type of 3.5-in diskette drive that can read 720-KB, 1.2-MB, and 1.44-MB diskettes.

Video

Select the type of primary video subsystem in your computer. The BIOS usually detects the correct video type automatically. The BIOS supports a secondary video subsystem, but you do not select it in Setup.

EGA/VGA	Enhanced Graphics Adapter/Video Graphics Array. For EGA, VGA, SEGA, SVGA, or PGA monitor adapters.
CGA 40	Color Graphics Adapter, power up in 40 column mode.
CGA 80	Color Graphics Adapter, power up in 80 column mode.
MONO	Monochrome adapter, includes high resolution monochrome adapters.

Halt On

During the power-on self-test (POST), the computer stops if the BIOS detects a hardware error. You can tell the BIOS to ignore certain errors during POST and continue the boot-up process. These are the selections:

No errors	POST does not stop for any errors.
All errors	If the BIOS detects any non-fatal error, POST stops and prompts you to take corrective action.
All, But Keyboard	POST does not stop for a keyboard error, but stops for all other errors.
All, But Diskette	POST does not stop for diskette drive errors, but stops for all other errors.
All, But Disk/Key	POST does not stop for a keyboard or disk error, but stops for all other errors.

Memory

You cannot change any values in the Memory fields; they are only for your information. The fields show the total installed random access memory (RAM) and amounts allocated to base memory, extended memory, and other (high) memory. RAM is counted in kilobytes (KB: approximately one thousand bytes) and megabytes (MB: approximately one million bytes).

RAM is the computer's working memory, where the computer stores programs and data currently being used, so they are accessible to the CPU. Modern personal computers may contain up to 64 MB, 128 MB, or more.

Base Memory: Typically 640 KB. Also called conventional memory. The DOS operating system and conventional applications use this area.

Extended Memory: Above the 1-MB boundary. Early IBM personal computers could not use memory above 1 MB, but current PCs and their software can use extended memory.

Other Memory: Between 640 KB and 1 MB; often called high memory. DOS may load terminate-and-stay-resident (TSR) programs, such as device drivers, in this area, to free as much conventional memory as possible for applications. Lines in your config.sys file that start with loadhigh load programs into high memory.

BIOS Features Setup

The screen (shown on the following page) contains industry-standard options additional to the core PC AT BIOS. This section describes all fields offered by Award Software in this screen. The example screen below may vary from the one in your Setup program. Your system board designer may omit or modify some fields.

ROM PCI/ISA BIOS (2A5LET59)
 BIOS FEATURES SETUP
 AWARD SOFTWARE, INC.

Virus Warning : Disabled CPU Internal Cache : Enabled External Cache : Enabled Quick Power On Self Test : Enabled Boot Sequence : A, C, SCSI Swap Floppy Drive : Disabled Boot Up Floppy Seek : Enabled Boot Up NumLock Status : On Gate A20 Option : Normal Memory Parity/ECC Check : Enabled Typematic Rate Setting : Disabled Typematic Rate (Chars/Sec) : 6 Typematic Delay (Msec) : 250 Security Option : Setup PCI/VGA Palette Snoop : Disabled OS Select For DRAM > 64MB : Non-OS2	Video BIOS Shadow : Enabled C8000-CBFFF Shadow : Disabled CC000-CFFFF Shadow : Disabled D0000-D3FFF Shadow : Disabled D4000-D7FFF Shadow : Disabled D8000-DBFFF Shadow : Disabled DC000-DFFFF Shadow : Disabled Cyrix 6x86/MII CPU ID : Enabled
ESC : Quit ↑↓←→ : Select Item F1 : Help PU/PD/+/- : Modify F5 : Old Values (Shift)F2 : Color F6 : Load BIOS Defaults F7 : Load Setup Defaults	

BIOS

BIOS Feature Setup - Default Settings Chart

Setting Option	BIOS Default	Setup Default
Virus Warning	Disabled	Disabled
CPU Internal Cache	Enabled	Enabled
External Cache	Enabled	Enabled
Quick Power On Self Test	Disabled	Enabled
Boot Sequence	A,C, SCSI	A,C, SCSI
Swap Floppy Drive	Disabled	Disabled
Boot Up Floppy Seek	Enabled	Enabled
Boot Up NumLock Status	On	On
Gate A20 Option	Normal	Fast
Memory Parity / ECC Check	Enabled	Disabled
Typematic Rate Setting	Disabled	Disabled
Typematic Rate (Chars/Sec)	6	6
Typematic Delay (Msec)	250	250
Security Option	Setup	Setup
PCI / VGA Palette Snoop	Disabled	Disabled
OS Select For DRAM > 64MB	Non-OS2	Non-OS2
Video BIOS Shadow	Enabled	Enabled
C8000-CBFFF Shadow	Disabled	Disabled
CC000-CFFFF Shadow	Disabled	Disabled
D0000-D3FFF Shadow	Disabled	Disabled

Settings Chart (Continued)

Setting Option	BIOS Default	Setup Default
D4000-D7FFF Shadow	Disabled	Disabled
D8000-DBFFF Shadow	Disabled	Disabled
DC000-DFFFF Shadow	Disabled	Disabled
Cyrix 6x86 / MII CPU ID	Enabled	Enabled

Virus Warning

When enabled, you receive a warning message if a program (specifically, a virus) attempts to write to the boot sector or the partition table of the hard disk drive. You should then run an anti-virus program. Keep in mind that this feature protects only the boot sector, not the entire hard drive. Note: Many disk diagnostic programs that access the boot sector table can trigger the virus warning message. If you plan to run such a program, we recommend that you first disable the virus warning.

CPU Internal Cache/External Cache

Cache memory is additional memory that is much faster than conventional DRAM (system memory). CPUs from 486-type on up contain internal cache memory, and most, but not all, modern PCs have additional (external) cache memory. When the CPU requests data, the system transfers the requested data from the main DRAM into cache memory, for even faster access by the CPU. The External Cache field may not appear if your system does not have external cache memory.

Quick Power On Self Test

Select Enabled to reduce the amount of time required to run the power-on self-test (POST). A quick POST skips certain steps. We recommend that you normally disable quick POST. Better to find a problem during POST than lose data during your work.

Boot Sequence

The original IBM PCs loaded the operating system from drive A (floppy disk), so IBM PC-compatible systems are designed to search for an operating system first on drive A, and then on drive C (hard disk). However, modern computers usually load the operating system from the hard drive, and may even load it from a CD-ROM drive. The BIOS now offers a large number of boot devices and boot sequence options.

Swap Floppy Drive

This field is effective only in systems with two floppy drives. Selecting

Enabled assigns physical drive B to logical drive A, and physical drive A to logical drive B.

Boot Up Floppy Seek

When Enabled, the BIOS tests (seeks) floppy drives to determine whether they have 40 or 80 tracks. Only 360-KB floppy drives have 40 tracks; drives with 720 KB, 1.2 MB, and 1.44 MB capacity all have 80 tracks. Because very few modern PCs have 40-track floppy drives, we recommend that you set this field to Disabled to save time.

Boot Up NumLock Status

Toggle between On or Off to control the state of the NumLock key when the system boots. When toggled On, the numeric keypad generates numbers instead of controlling cursor operations.

Gate A20 Option

Gate A20 refers to the way the system addresses memory above 1 MB (extended memory). When set to Fast, the system chipset controls Gate A20. When set to Normal, a pin in the keyboard controller controls Gate A20. Setting Gate A20 to Fast improves system speed, particularly with OS/2 and Windows.

Memory Parity/ECC Check

Select Enabled or Disabled. If Enabled, allows memory checking when the BIOS detects the presence of ECC or Parity DRAM.

Typematic Rate Setting

When Disabled, the following two items (Typematic Rate and Typematic Delay) are irrelevant. Keystrokes repeat at a rate determined by the keyboard controller in your system. When Enabled, you can select a typematic rate and typematic delay.

Typematic Rate (Chars/Sec)

When the typematic rate setting is enabled, you can select a typematic rate (the rate at which character repeats when you hold down a key) of 6, 8, 10, 12, 15, 20, 24 or 30 characters per second.

Typematic Delay (Msec)

When the typematic rate setting is enabled, you can select a typematic delay (the delay before key strokes begin to repeat) of 250, 500, 750 or 1000 milliseconds.

Security Option

If you have set a password, select whether the password is required every time the System boots, or only when you enter Setup.

PCI/VGA Palette Snoop

Your BIOS Setup may not contain this field. If the field is present, leave at Disabled.

OS Select for DRAM > 64MB

Select OS2 only if you are running OS/2 operating system with greater than 64 MB of RAM on your system.

Video BIOS Shadow

Software that resides in a read-only memory (ROM) chip on a device is called firmware. The EliteBIOS permits shadowing of firmware such as the system BIOS, video BIOS, and similar operating instructions that come with some expansion peripherals, such as, for example, a SCSI adaptor.

Shadowing copies firmware from ROM into system RAM, where the CPU can read it through the 16-bit or 32-bit DRAM bus. Firmware not shadowed must be read by the system through the 8-bit X-bus. Shadowing improves the performance of the system BIOS and similar ROM firmware for expansion peripherals, but it also reduces the amount of high memory (640 KB to 1 MB) available for loading device drivers, etc.

Enable shadowing into each section of memory separately. Many system designers hardwire shadowing of the system BIOS and eliminate a System BIOS Shadow option.

Video BIOS shadows into memory area C0000-C7FFF. The remaining areas shown on the BIOS Features Setup screen may be occupied by other expansion card firmware. If an expansion peripheral in your system contains ROM-based firmware, you need to know the address range the ROM occupies to shadow it into the correct area of RAM.

Cyrix 6x86 / MII CPU ID

Select Enabled to enable the Cyrix 6x86 / MII CPU support. The settings are Enabled or Disabled.

Chipset Features Setup

This section describes features of the Intel 440EX chipset.

Advanced Options

The parameters in this screen are for system designers, service personnel, and technically competent users only. Do not reset these values unless you understand the consequences of your changes. Note: This chapter describes all fields offered by Award Software in this screen. Your system board designer may omit or modify some fields.

ROM PCI/ISA BIOS (2A5LET59)
 CHIPSET FEATURES SETUP
 AWARD SOFTWARE, INC.

BIOS

Bank 0/1 DRAM Timing	: SDRAM 10ns	Current CPU Temperature	: 35C/95F
Bank 2/3 DRAM Timing	: FP/EDO 70ns	Current System Temp.	: 27C/80F
Bank 4/5 DRAM Timing	: FP/EDO 70ns	Current CPUFAN Speed	: 0RPM
SDRAM Cycle Length	: 2	Current SYSFAN Speed	: 0RPM
DRAM Read Pipeline	: Disabled		
		Vcore : 2.40V	5V : 4.95V
Cache Rd+CPU Wt Pipeline	: Disabled	3.3V : 3.31V	
Cache Timing	: Fast	12V : 12.12V	
Video BIOS Cacheable	: Disabled		
System BIOS Cacheable	: Disabled		
Memory Hole At 15Mb Addr	: Disabled		
AGP Aperture Size	: 64M		
OnChip USB	: Enabled		
USB Keyboard Support	: Disabled		
		ESC : Quit ↑↓→← : Select Item F1 : Help PU/PD/+/- : Modify F5 : Old Values (Shift)F2 : Color F6 : Load BIOS Defaults F7 : Load Setup Defaults	

Chipset Features Setup - Default Settings Chart

Setting Option	BIOS Default	Setup Default
Bank 0/1 DRAM Timing	SDRAM 10ns	SDRAM 10ns
Bank 2/3 DRAM Timing	FP/EDO 70ns	FP/EDO 70ns
Bank 4/5 DRAM Timing	FP/EDO 70ns	FP/EDO 70ns
SDRAM Cycle Length	3	3
DRAM Read Pipeline	Disabled	Enabled
Cache Rd+CPU Wt Pipeline	Disabled	Enabled
Cache Timing	Fast	Fast
Video BIOS Cacheable	Disabled	Enabled
System BIOS Cacheable	Disabled	Enabled
Memory Hole At 15Mb Addr	Disabled	Disabled
AGP Aperture Size	64M	64M
OnChip USB	Enabled	Enabled
USB Keyboard Support	Disabled	Disabled
Current CPU Temperature	35C / 95F	35C / 95F
Current System Temp.	27C / 80F	27C / 80F
Current CPUFAN Speed	0 RPM	0 RPM
Current SYSFAN Speed	0 RPM	0 RPM
Vcore	2.40V	2.40V
3.3V	3.31V	3.31V
5V	4.95V	4.95V
12V	12.12V	12.12V

Bank 0/1, 2/3, 4/5 DRAM Timing

The system board designer must select the proper value for these fields, according to the specifications of the installed DRAM chips. Turbo mode reduces CAS access time by 1 clock tick.

SDRAM Cycle Length

This field sets the CAS latency timing.

DRAM Read Pipeline

Select Enabled to pipeline reads from system memory. Pipelining improves system performance.

Cache Rd+CPU Wt Pipeline

Select Enabled to pipeline reads from cache memory and writes from the CPU. Pipelining improves system performance.

Cache Timing

For a secondary cache of one bank, select Faster. For a secondary cache of two banks, select Fastest.

Video BIOS Cacheable

Selecting Enabled allows caching of the video BIOS ROM at C0000h to C7FFFh, resulting in better video performance. However, if any program writes to this memory area, a memory access error may result in a system error.

System BIOS Cacheable

If Enabled, results in better system performance by permitting caching of the system BIOS ROM at F0000h-FFFFFh. Any program which tries to write to this memory area, however, may cause a system error.

Memory Hole at 15Mb Addr.

You can reserve this area of system memory for ISA adapter ROM. When this area is reserved, it cannot be cached. The user information of peripherals that need to use this area of system memory usually discusses their memory requirements.

AGP Aperture Size

Select the size of the Accelerated Graphics Port (AGP) aperture. The aperture is a portion of the PCI memory address range dedicated for graphics memory address space. Host cycles that hit the aperture range are forwarded to the AGP without any translation. See www.agpforum.org for AGP information.

OnChip USB

The chipset contains an integrated USB controller. Select Enabled if you have USB peripherals.

USB Keyboard Support

Select Enabled if your system contains a Universal Serial Bus (USB) controller and you have a USB keyboard.

Current CPU Temp, Current System Temp, Curren CPU / SYS Fan Speed, Vcore, 3.3V, 5V, 12V - These values are automatically detected and displayed by the BIOS.

Power Management Setup

Note: This chapter describes all fields offered by Award Software in this screen. Your system board designer may omit or modify some fields.

ROM PCI/ISA BIOS (2A5LET5A)
POWER MANAGEMENT SETUP
AWARD SOFTWARE, INC.

ACPI Function	: Disabled	Primary INTR	: ON
Power Management	: User Define	IRQ3(COM2)	: Primary
PM Control by APM	: Yes	IRQ4(COM1)	: Primary
Video Off Option	: Suspend->Off	IRQ5(LPT2)	: Primary
Video Off Method	: V/H SYNC+Blank	IRQ6(Floppy Disk)	: Primary
MODEM Use IRQ	: 3	IRQ7(LPT1)	: Primary
Soft-Off by PWRBTN	: Delay 4 sec.	IRQ8(RTC Alarm)	: Disabled
** PM Timers **		IRQ9(IRQ2 Redir)	: Secondary
HDD Power Down	: Disabled	IRQ10(Reserved)	: Secondary
Doze Mode	: Disabled	IRQ11(Reserved)	: Secondary
Suspend Mode	: Disabled	IRQ12(PS/2 Mouse)	: Primary
** PM Events **		IRQ13(Coprocessor)	: Disabled
VGA	: OFF	IRQ14(Hard Disk)	: Primary
LPT & COM	: LPT/COM	IRQ15(Reserved)	: Disabled
HDD & FDD	: ON		
PCI/master	: OFF		
Modem Ring Resume	: Disabled		
RTC Alarm Resume	: Disabled		
		ESC : Quit	↑↓→← : Select Item
		F1 : Help	PU/PD/+/- : Modify
		F5 : Old Values (Shift)	F2 : Color
		F6 : Load BIOS Defaults	
		F7 : Load Setup Defaults	

Power Management Setup - Default Settings Chart

Setting Option	BIOS Default	Setup Default
ACPI Function	Disabled	Disabled
Power Management	User Define	User Define
PM Control by APM	Yes	Yes
Video Off Option	Suspend -> Off	Suspend -> Off
Video Off Method	V/ H SYNC+Blank	V/ H SYNC+Blank
MODEM Use IRQ	3	3
Soft-Off by PWRBTN	Delay 4 sec.	Instant Off
HDD Power Down	Disabled	Disabled
Doze Mode	Disabled	Disabled
Suspend Mode	Disabled	Disabled
VGA	OFF	OFF
LPT & COM	LPT / COM	LPT / COM
HDD & FDD	ON	ON
PCI / master	OFF	OFF

Settings Chart (Continued)

Setting Option	BIOS Default	Setup Default
Modem Ring Resume	Disabled	Disabled
RTC Alarm Resume	Disabled	Disabled
Primary INTR	ON	ON
IRQ3 (COM2)	Primary	Primary
IRQ4 (COM1)	Primary	Primary
IRQ5 (LPT2)	Primary	Primary
IRQ6 (Floppy Disk)	Primary	Primary
IRQ7 (LPT1)	Primary	Primary
IRQ8 (RTC Alarm)	Disabled	Disabled
IRQ9 (IRQ2 Redir)	Secondary	Secondary
IRQ10 (Reserved)	Secondary	Secondary
IRQ11 (Reserved)	Secondary	Secondary
IRQ12 (PS/2 Mouse)	Primary	Primary
IRQ13 (Coprocessor)	Disabled	Primary
IRQ14 (Hard Disk)	Primary	Primary
IRQ15 (Reserved)	Disabled	Disabled

ACPI Function

Enable or disable Advanced Configuration Power Interface.

Power Management

This option allows you to select the type (or degree) of power saving for Doze, Standby, and Suspend modes. See the section PM Timers for a brief description of each mode. This table describes each power management mode:

Max saving	Maximum power savings. Only available for SL CPUs. Inactivity period is 1 minute in each mode.
User Define	Set each mode individually. Select time-out periods in the PM Timers section, following.
Min Saving	Minimum power savings. Inactivity period is 1 hour in each mode (except the hard drive).

PM Control by APM

If Advanced Power Management (APM) is installed on your system, selecting Yes gives better power savings.

Video Off Option

Selects the power-saving modes during which the monitor goes blank.

Always On	Monitor remains on during power-saving modes.
Suspend --> Off	Monitor blanked when system enters Suspend mode.
All Modes--> Off	Monitor blanked when system enters any power-saving mode.

Video Off Method

Determines the manner in which the monitor is blanked. The Blank Screen option will let the system BIOS blank the screen when disabling video. V/H sync+Blank will allow the system BIOS to turn off the V-SYNC and H-SYNC signals running from the VGA card to the monitor.

V/H SYNC+Blank	System turns off vertical and horizontal synchronization ports and writes blanks to the video buffer.
DPMS Support	Select this option if your monitor supports the Display Power Management Signaling (DPMS) standard of the Video Electronics Standards Association (VESA). Use the software supplied for your video subsystem to select video power management values.
Blank Screen	System only writes blanks to the video buffer.

MODEM Use IRQ

If Modem Ring Resume is Enabled, it is possible to wake the system by dialing in to it. This field determines which IRQ will be monitored for the incoming call.

Soft-Off by PWRBTN

When you select Instant Off or Delay 4 Sec., turning the system off with the on/off button places the system in a very low power usage state, either immediately or after 4 seconds, with only enough circuitry receiving power to detect wake-up event activity.

**** PM Timers ****

The following modes are Green PC power saving functions that are user-configurable only in User Defined Power Management mode.

HDD Power Down

After the selected period of drive inactivity (1 to 15 minutes), the hard disk drive powers down while all other devices remain active.

Doze Mode

After the selected period of system inactivity (1 minute to 1 hour), the CPU clock runs at slower speed while all other devices still operate at full speed.

Suspend Mode

After the selected period of system inactivity (1 minute to 1 hour), all devices except the CPU shut off.

**** PM Events ****

A power management (PM) event awakens the system from, or resets activity timers for, Suspend mode. You can disable monitoring of common interrupt requests so they do not generate PM events.

VGA

When On, any video activity is a PM event.

LPT & COM

Select none, or one or more, ports whose activity is a PM event.

HDD & FDD

When On, any hard drive or floppy drive activity is a PM event.

DMA/master

When On, any DMA or bus master activity is a PM event.

Modem Ring Resume

When Enabled, an input signal on the serial Ring Indicator (RI) line (in other words, an incoming call on the modem) awakens the system from Suspend mode.

RTC Alarm Resume

When Enabled, you can set the date and time at which the RTC (real-time clock) alarm awakens the system from Suspend mode.

Primary INTR

A system peripheral signals that it wants to gain the attention of the operating system by sending an interrupt request. When the system is in Suspend mode, IRQ activity can cause a Primary or Secondary wake-up. When Primary INTR is On, the IRQs in the above fields can be configured as Primary, Secondary, or Disabled.

Primary	The system wakes up fully when it detects IRQ activity.
Secondary	The system does not wake up, but the interrupt request is processed. Secondary interrupts are typically housekeeping devices needed to maintain the system while not requiring the use of the rest of the system resources. For example, IRQ8, the RTC Alarm, is configured as Secondary by default. Another example might be a network adapter continually polled by the network.

IRQ_n

The following is a list of IRQs (Interrupt Request Lines) assigned to common system peripherals.

IRQ3 (COM2)

IRQ4 (COM1)

IRQ5 (LPT2)

IRQ6 (Floppy Disk)

IRQ7 (LPT1)

IRQ8 (RTC Alarm)

IRQ9 (IRQ2 Redir)

IRQ10 (Reserved)

IRQ11 (Reserved)

IRQ12 (PS/2 Mouse)

IRQ13 (Coprocessor)

IRQ14 (Hard Disk)

IRQ15 (Reserved)

PnP/PCI Configuration

Note: This chapter describes all fields offered by Award Software in this screen. Your system board designer may omit or modify some fields.

ROM PCI/ISA BIOS (2A5LET5A)
 PNP/PCI CONFIGURATION
 AWARD SOFTWARE, INC.

BIOS

PNP OS Installed	: No	CPU to PCI Write Buffer	: Enabled
Resources Controlled By	: Manual	PCI Dynamic Bursting	: Disabled
Reset Configuration Data	: Disabled	PCI Master 0 WS Write	: Enabled
IRQ3 assigned to	: Legacy ISA	PCI Delay Transaction	: Disabled
IRQ4 assigned to	: Legacy ISA	PCI#2 Access #1 Retry	: Disabled
IRQ5 assigned to	: PCI/ISA PnP	AGP Master 1 WS Write	: Disabled
IRQ7 assigned to	: Legacy ISA	AGP Master 1 WS Read	: Disabled
IRQ9 assigned to	: PCI/ISA PnP	Assign IRQ for USB	: Enabled
IRQ10 assigned to	: PCI/ISA PnP	Assign IRQ for VGA	: Disabled
IRQ11 assigned to	: PCI/ISA PnP	Slot 1 Use IRQ No.	: Auto
IRQ12 assigned to	: PCI/ISA PnP	Slot 2 Use IRQ No.	: Auto
IRQ14 assigned to	: PCI/ISA PnP	Slot 3 Use IRQ No.	: Auto
IRQ15 assigned to	: PCI/ISA PnP	Slot 4 Use IRQ No.	: Auto
DMA-0 assigned to	: PCI/ISA PnP	Slot 5 Use IRQ No.	: Auto
DMA-1 assigned to	: PCI/ISA PnP		
DMA-3 assigned to	: PCI/ISA PnP	ESC : Quit	↑↓←→ : Select Item
DMA-5 assigned to	: PCI/ISA PnP	F1 : Help	PU/PD/+/- : Modify
DMA-6 assigned to	: PCI/ISA PnP	F5 : Old Values (Shift)F2 : Color	
DMA-7 assigned to	: PCI/ISA PnP	F6 : Load BIOS Defaults	
		F7 : Load Setup Defaults	

PnP/PCI Configuration - Default Settings Chart

Setting Option	BIOS Default	Setup Default
PnP OS Installed	No	No
Resources Controlled By	Manual	Manual
Reset Configuration Data	Disabled	Disabled
IRQ3 assigned to	Legacy ISA	Legacy ISA
IRQ4 assigned to	Legacy ISA	Legacy ISA
IRQ5 assigned to	PCI / ISA PnP	PCI / ISA PnP
IRQ7 assigned to	Legacy ISA	Legacy ISA
IRQ9 assigned to	PCI / ISA PnP	PCI / ISA PnP
IRQ10 assigned to	PCI / ISA PnP	PCI / ISA PnP
IRQ11 assigned to	PCI / ISA PnP	PCI / ISA PnP
IRQ12 assigned to	PCI / ISA PnP	PCI / ISA PnP
IRQ14 assigned to	PCI / ISA PnP	PCI / ISA PnP
IRQ15 assigned to	PCI / ISA PnP	PCI / ISA PnP
DMA-0 assigned to	PCI / ISA PnP	PCI / ISA PnP

Settings Chart (continued)

Setting Option	BIOS Default	Setup Default
DMA-1 assigned to	PCI / ISA PnP	PCI / ISA PnP
DMA-3 assigned to	PCI / ISA PnP	PCI / ISA PnP
DMA-5 assigned to	PCI / ISA PnP	PCI / ISA PnP
DMA-6 assigned to	PCI / ISA PnP	PCI / ISA PnP
DMA-7 assigned to	PCI / ISA PnP	PCI / ISA PnP
CPU to PCI Write Buffer	Enabled	Enabled
PCI Dynamic Bursting	Disabled	Enabled
PCI Master 0 WS Write	Enabled	Enabled
PCI Delay Transaction	Disabled	Enabled
PCI #2 Access #1 Retry	Disabled	Disabled
AGP Master 1 WS Write	Disabled	Enabled
AGP Master 1 WS Read	Disabled	Disabled
Assign IRQ for USB	Enabled	Enabled
Assign IRQ for VGA	Disabled	Enabled
Slot 1 Use IRQ No.	Auto	Auto
Slot 2 Use IRQ No.	Auto	Auto
Slot 3 Use IRQ No.	Auto	Auto
Slot 4 Use IRQ No.	Auto	Auto
Slot 5 Use IRQ No.	Auto	Auto

PNP OS Installed

Select Yes if the system operating environment is Plug-and-Play aware (e.g., Windows 95).

Resources Controlled By

The Plug and Play EliteBIOS can automatically configure all the boot and Plug and Play-compatible devices. If you select Auto, all the interrupt request (IRQ) and DMA assignment fields disappear, because the BIOS automatically assigns them.

Reset Configuration Data

Normally, you leave this field Disabled. Select Enabled to reset Extended System Configuration Data (ESCD) when you exit Setup if you have installed a new add-on and the system reconfiguration has caused such a serious conflict that the operating system cannot boot.

IRQ-*n* Assigned to

When resources are controlled manually, assign each system interrupt as one of the following types, depending on the type of device using the interrupt:

Legacy ISA: Devices compliant with the original PC AT bus specification, requiring a specific interrupt (such as IRQ4 for serial port 1).

PCI/ISA PnP: Devices compliant with the Plug and Play standard, whether designed for PCI or ISA bus architecture.

DMA-*n* Assigned to

When resources are controlled manually, assign each system DMA channel as one of the following types, depending on the type of device using the interrupt:

Legacy ISA: Devices compliant with the original PC AT bus specification, requiring a specific DMA channel

PCI/ISA PnP: Devices compliant with the Plug and Play standard, whether designed for PCI or ISA bus architecture.

CPU to PCI Write Buffer

When this field is Enabled, writes from the CPU to the PCI bus are buffered, to compensate for the speed differences between the CPU and the PCI bus.

When Disabled, the writes are not buffered and the CPU must wait until the write is complete before starting another write cycle.

PCI Dynamic Bursting

When Enabled, every write transaction goes to the write buffer. Burstable transactions then burst on the PCI bus; nonburstable transactions do not.

PCI Master 0 WS Write

When this field is Enabled, writes to the PCI bus are executed with zero wait states.

PCI Delay Transaction

The chipset has an embedded 32-bit posted write buffer to support delay transaction cycles. Select Enabled to support compliance with PCI specification version 2.1.

PCI#2 Access #1 Retry

Select Enabled to rotate priority of PCI masters.

AGP Master 1 WS Write

Select Enabled to add one clock tick to AGP write operations.

AGP Master 1 WS Read

Select Enabled to add one clock tick to AGP read operations.

Assign IRQ for USB

Assign an IRQ number to the onboard USB port.

Assign IRQ for VGA

Assign an IRQ number to your VGA adapter.

Slot 1-5 IRQ for VGA

This option allows a user to assign specific IRQ's to the PCI Slot.

Integrated Peripherals

Note: This chapter describes all fields offered by Award Software in this screen. Your system board designer may omit or modify some fields.

ROM PCI/ISA BIOS (2A5LET59)
INTEGRATED PERIPHERALS
AWARD SOFTWARE, INC.

OnChip IDE First Channel : Enabled	Onboard Parallel Port : 378/IRQ7
OnChip IDE Second Channel : Enabled	
IDE Prefetch Mode : Disabled	
IDE HDD Block Mode : Disabled	
IDE Primary Master PIO : Auto	
IDE Primary Slave PIO : Auto	
IDE Secondary Master PIO : Auto	
IDE Secondary Slave PIO : Auto	
IDE Primary Master UDMA : Disabled	
IDE Primary Slave UDMA : Disabled	
MPU-401 I/O Address : 330-333H	
IDE Secondary Master UDMA : Disabled	
IDE Secondary Slave UDMA : Disabled	
Init Display First : PCI Slot	
Onboard FDD Controller : Enabled	ESC : Quit ↑↓←→ : Select Item
Onboard Serial Port 1 : Disabled	F1 : Help PU/PD/+/- : Modify
Onboard Serial Port 2 : Disabled	F5 : Old Values (Shift)F2 : Color
	F6 : Load BIOS Defaults
	F7 : Load Setup Defaults

Integrated Peripherals - Default Settings Chart

Setting Option	BIOS Default	Setup Default
OnChip IDE First Channel	Enabled	Enabled
OnChip IDE Second Channel	Enabled	Enabled
IDE Prefetch Mode	Disabled	Enabled
IDE HDD Block Mode	Disabled	Enabled
IDE Primary Master PIO	Auto	Auto
IDE Primary Slave PIO	Auto	Auto
IDE Secondary Master PIO	Auto	Auto
IDE Secondary Slave PIO	Auto	Auto
IDE Primary Master UDMA	Disabled	Auto
IDE Primary Slave UDMA	Disabled	Auto
IDE Secondary Master UDMA	Disabled	Auto
IDE Secondary Slave UDMA	Disabled	Auto
Init Display First	PCI Slot	PCI Slot
Onboard FDD Controller	Enabled	Enabled
Onboard Serial Port 1	Disabled	3F8 / IRQ4
Onboard Serial Port 2	Disabled	2F8 / IRQ3
Onboard Parallel Port	378 / IRQ7	378 / IRQ7

On-Chip PCI IDE First/Second Channel

This chipset contains a PCI IDE interface with support for two IDE channels. Select Enabled to activate the primary and/or secondary onboard IDE interface. Select Disabled to deactivate this interface, if you install a primary and/or secondary add-in IDE interface.

IDE Prefetch Mode

The onboard IDE drive interface supports IDE prefetching for faster drive accesses. If you install a primary and/or secondary add-in IDE interface, set this field to Disabled if the interface does not support prefetching.

IDE HDD Block Mode

Select Enabled only if your hard drives support block mode. Most new drives support block mode. If Enabled, block mode yields automatic detection of the optimal number of block read/writes per sector that the drive can support.

IDE Primary/Secondary Master/Slave PIO

The four IDE PIO (Programmed Input/Output) fields let you set a PIO mode (0-4) for each of up to four IDE devices that the internal PCI IDE interface

supports. Modes 0 through 4 provide successively increased performance. In Auto mode, the system automatically determines the best mode for each device.

IDE Primary/Secondary Master/Slave UDMA

UDMA (Ultra DMA) is a DMA data transfer protocol that utilizes ATA commands and the ATA bus to allow DMA commands to transfer data at a maximum burst rate of 33 MB/s. When you select Auto in the four IDE UDMA fields (for each of up to four IDE devices that the internal PCI IDE interface supports), the system automatically determines the optimal data transfer rate for each IDE device.

Init Display First

Select the type of display adapter used in your system.

Onboard FDD Controller

Select Enabled if your system has a floppy disk controller (FDC) installed on the system board and you wish to use it. If you install an add-in FDC or the system has no floppy drive, select Disabled in this field.

Onboard Serial Port 1/2

Select a logical COM port address and corresponding interrupt for the first and second serial ports. The second serial port offers infrared options in the next field.

Onboard Parallel Port

Select a logical LPT port address and corresponding interrupt for the physical parallel port.

User Password

When you select this function, a message appears at the center of the screen:
ENTER PASSWORD:

Type the password, up to eight characters, and press Enter. Typing a password clears any previously entered password from CMOS memory. Now the message changes:

CONFIRM PASSWORD:

Again, type the password and press Enter. To abort the process at any time, press Esc.

In the Security Option item in the BIOS Features Setup screen, select System or Setup:

System	Enter a password each time the system boots and whenever you enter Setup.
Setup	Enter a password whenever you enter Setup.

Note: To clear the password, simply press Enter when asked to enter a password. Then the password function is disabled.

Flash Writer Utility

You can upgrade the BIOS on your motherboard by using the Flash Memory Writer (FMW) utility. This utility can be downloaded from TYAN's BBS and from the TYAN website. The system BIOS is stored on a flash EEPROM chip on the mainboard, which can be erased and reprogrammed by the FMW. The following three files make up the FMW:

- AWDFLASH.EXE The Flash Memory Writer utility for Award to Award upgrade.
- README.TXT A text file of instructions.
- S71AWXX.BIN* The new BIOS file.

(*This file name is subject to change and can have either a .bin or .rom extension.)

The FMW records (or programs) a new BIOS onto the flash memory chip. You cannot upgrade an Award BIOS to an AMI BIOS or vice-versa.

Note: You should always clear your CMOS after flashing a BIOS. This will clear out any stray settings from your old BIOS which may have been carried over from the flashing process. Most problems encountered after flashing a BIOS will be solved by this simple procedure (see Hardware CMOS & Password Reset, page 33).

To reprogram the system BIOS, the CPU must be running in real mode. FMW will not run if the CPU is operating in a protected or virtual mode. This means that you cannot run it with Windows running or with any memory manager software. You must disable any memory manager software before you can run FMW. The easiest way to do this is as follows:

- 1) Boot your system from a bootable floppy disk with no CONFIG.SYS or AUTOEXEC.BAT files, and then run FMW from a backup copy of your support disk. You can make your back-up floppy bootable when you format it, and use one disk for both purposes.
- 2) If you are using MS-DOS 6.x, you can use the feature that allows you to bypass the CONFIG.SYS and AUTOEXEC.BAT files. You can access this feature by pressing <F5> while the "Starting MS-DOS..." line is on the screen during boot-up.

If you are uncertain whether or not you have a memory manager running, try FMW. If it works, then there is no active memory manager on your system. If you see a warning message about the CPU mode, follow the above directions to get around the memory manager.

Once you have your CPU in real mode, you can run FMW. You can copy the contents of the "Flash" directory to your hard drive, or you can run the utility from a backup of the support floppy disk. Either way, make sure that the new BIOS file is in the same directory as the FMW utility.

To start FMW, change to the "Flash" directory if you are not already in it. Type "awdfash" at the DOS command line and press the <Enter> key. The FMW utility screen will appear:

FLASH MEMORY WRITER V3.0 Copyright(C) 1993, AWARD SOFTWARE, INC.	
For VX/HX-2A59CT51	Date: 4/13/98
File Name to Program:	
Error Message:	

BIOS

Type in the whole file name, e.g. A61AW10.BIN, and confirm that you want to program the BIOS. The utility will then “Blank,” “Erase,” and “Program” the flash memory on the mainboard with the new BIOS file. You should choose “Yes” to save the original system BIOS to a floppy diskette **before** you program the new BIOS. This leaves you with a backup of your original BIOS in case you need to re-install it. If you cannot successfully program the new BIOS file for some reason, re-install your original BIOS from the backup file. Remember, always reset the CMOS after flashing to a new BIOS (see page 33).

Warning: If you do not successfully install a complete BIOS file in the flash memory on the mainboard, your system may not be able to boot. If this happens, it will require service by your system vendor. Follow the instructions in this section precisely to avoid such an inconvenience.

chapter 4

System Resources

POST Messages

During the power-on self test (POST), the BIOS either sounds a beep code or displays a message when it detects a correctable error. Following is a list of POST messages for the ISA BIOS kernel. Specific chipset ports and BIOS extensions may include additional messages. An error message may be followed by a prompt to press F1 to continue or press DEL to enter Setup.

Beep

Currently the only beep code indicates that a video error has occurred and the BIOS cannot initialize the video screen to display any additional information. This beep code consists of a single long beep followed by two short beeps.

BIOS ROM checksum error - System halted

The checksum of the BIOS code in the BIOS chip is incorrect, indicating the BIOS code may have become corrupt. Contact your system dealer to replace the BIOS.

CMOS battery failed

CMOS battery is no longer functional. Contact your system dealer for a replacement battery.

CMOS checksum error - Defaults loaded

Checksum of CMOS is incorrect, so the system loads the default equipment configuration. A checksum error may indicate that CMOS has become corrupt. This error may have been caused by a weak battery. Check the battery and replace if necessary.

CPU at nnnn

Displays the running speed of the CPU.

Display switch is set incorrectly.

The display switch on the motherboard can be set to either monochrome or color. This message indicates the switch is set to a different setting than indicated in Setup. Determine which setting is correct, and then either turn off the system and change the jumper, or enter Setup and change the VIDEO selection.

Press ESC to skip memory test

The user may press Esc to skip the full memory test.

Floppy disk(s) fail

Cannot find or initialize the floppy drive controller or the drive. Make sure the controller is installed correctly. If no floppy drives are installed, be sure the Diskette Drive selection in Setup is set to NONE or AUTO.

HARD DISK initializing Please wait a moment...

Some hard drives require extra time to initialize.

HARD DISK INSTALL FAILURE

Cannot find or initialize the hard drive controller or the drive. Make sure the controller is installed correctly. If no hard drives are installed, be sure the Hard Drive selection in Setup is set to NONE.

Hard disk(s) diagnosis fail

The system may run specific disk diagnostic routines. This message appears if one or more hard disks return an error when the diagnostics run.

Keyboard error or no keyboard present

The keyboard cannot initialize. Make sure the keyboard is attached correctly and no keys were pressed during POST. To purposely configure the system without a keyboard, set the error halt condition in Setup to HALT ON ALL, BUT KEYBOARD. The BIOS then ignores the missing keyboard during POST.

Keyboard is locked out - Unlock the key

This message usually indicates that one or more keys have been pressed during the keyboard tests. Be sure no objects are resting on the keyboard.

Memory Test :

This message displays during a full memory test, counting down the memory areas being tested.

Memory test fail

If POST detects an error during memory testing, additional information appears giving specifics about the type and location of the memory error.

Override enabled - Defaults loaded

If the system cannot boot using the current CMOS configuration, the BIOS can override the current configuration is a set of BIOS defaults designed for the most stable, minimal-performance system operations.

Press TAB to show POST screen

System OEMs may replace the EliteBIOS POST display with their own proprietary display. Including this message in the OEM display permits the operator to switch between the OEM display and the default POST display.

Primary master hard disk fail

POST detects an error in the primary master IDE hard drive.

Primary slave hard disk fail

POST detects an error in the secondary master IDE hard drive.

Resuming from disk, Press TAB to show POST screen

The BIOS offers a save-to-disk feature for notebook computers. This message may appear when the operator re-starts the system after a save-to-disk shutdown. See the Press TAB ... message above for a description of this feature.

Secondary master hard disk fail

POST detects an error in the primary slave IDE hard drive.

This page has been intentionally left blank.

Appendix 1

Glossary

ACPI (**A**dvanced **C**onfiguration and **P**ower **I**nterface) is a power management specification that allows the operating system to control the amount of power distributed to the computer's devices. Devices not in use can be turned off, reducing unnecessary power expenditure.

AGP (**A**ccelerated **G**raphics **P**ort) is a PCI-based interface which was designed specifically for demands of 3D graphics applications. The 32-bit AGP channel directly links the graphics controller to the main memory. While the channel runs at only 66MHz, it supports data transmission during both the rising and falling ends of the clock cycle, yielding an effective speed of 133MHz.

The **AT** was the original form factor of IBM's PC.

ATAPI (**A**T **A**ttachment **P**acket **I**nterface), also known as IDE or ATA, is a drive implementation that includes the disk controller on the device itself. It allows CD-ROMs and tape drives to be configured as master or slave devices, just like hard drives.

The **ATX** form factor was designed to replace the AT form factor. It improves on the AT design by rotating the board ninety degrees, so that the IDE connectors are closer to the drive bays, and the CPU is closer to the power supply and cooling fan. The keyboard, mouse, serial, USB, and parallel ports are built in.

Bandwidth refers to carrying capacity. The greater the bandwidth, the more data the bus, phone line, or other electrical path, can carry. Greater bandwidth, then, also results in greater speed.

A **BBS (Bulletin Board System)** is a computer system with a number of modems hooked up to it which acts as a center for users to post messages and access information.

The **BIOS (Basic Input/Output System)** program resides in the ROM chip, and provides the basic instructions for controlling your computer's hardware. Both the operating system and application software use BIOS routines to ensure compatibility.

A **buffer** is a portion of RAM which is used to temporarily store data, usually from an application, though it is also used when printing, and in most keyboard drivers. The CPU can manipulate data in a buffer before copying it, all at once, to a disk drive. While this improves system performance--reading to or writing from a disk drive a single time is much faster than doing so repeatedly--there is the possibility of losing your data should the system crash. Information stored in a buffer is temporarily stored, not permanently saved.

A **bus** is a data pathway. The term is used especially to refer to the connection between the processor and system memory, and between the processor and PCI or ISA local buses.

Bus mastering allows peripheral devices and IDEs to access the system memory without going through the CPU (similar to DMA channels).

A **cache** is a temporary storage area for data that will be needed often by an application. Using a cache lowers data access times, since the needed information is stored in the SRAM instead of in the slower DRAM. Note that the cache is also much smaller than your regular memory: a typical cache size is 512KB, while you may have as much as 1GB of regular memory.

Cache size refers to the physical size of the cache onboard. This should not be confused with the cacheable area, which is the total amount of memory which can be scanned by the system in search of data to put into the cache. A typical setup would be a cache size of 512KB, and a cacheable area of 512MB. In this case, up to 512MB of the main memory onboard is capable of being cached. However, only 512KB of this memory will be in the cache at any given moment. Any main memory above 512MB could never be cached.

Closed and open jumpers Jumpers and jumper pins are active when they are On or Closed, and inactive when they are Off or Open.

CMOS Complementary Metal-Oxide Semiconductors are chips that hold the basic start-up information for the BIOS.

The **COM port** is another name for the serial port, which is so-called because it transmits the eight bits of a byte of data along one wire, and receives data on another single wire (that is, the data is transmitted in serial form, one bit after another). Parallel ports transmit the bits of a byte on eight different wires at the same time (that is, in parallel form, eight bits at the same time).

DIMM Dual In-line Memory Modules are a faster and more capacious form of RAM than SIMMs, and do not need to be installed in pairs.

DIMM bank DIMM banks are sometimes called DIMM sockets, because the physical slot and the logical unit are the same. That is, one DIMM module fits into one DIMM socket, which is capable of acting as a memory bank.

DMA Direct Memory Access channels are similar to IRQs. DMA channels allow hardware devices (like sound cards or keyboards) to access the main memory without involving the CPU. This frees up CPU resources for other tasks. As with IRQs, it is vital that you do not double up devices on a single line. Plug and Play devices will take care of this for you.

In **Doze mode**, only the CPU's speed is slowed.

DRAM Dynamic RAM is a widely available, very affordable form of RAM which has the unfortunate tendency to lose data if it is not recharged regularly (every few milliseconds). This refresh requirement makes DRAM slower three to ten times slower than non-recharged RAM such as SRAM.

EDO RAM (Extended Data-Out RAM) speeds access to memory locations by assuming that memory addresses are static: the next time it looks for a bit of data, it will be at the same spot, or one nearby.

EEPROM Electrically Erasable Programmable ROM, also called Flash BIOS, is a ROM chip which can, unlike normal ROM, be updated. This allows you to keep up with changes in the BIOS programs without having to buy a new chip. TYAN's BIOS updates can be found at <http://www.tyan.com/html/drivers.html>

ESCD (Extended System Configuration Data) is a format for storing informa-

tion about Plug and Play devices in the system BIOS. This information helps properly configure the system each time it boots.

Firmware is low level software that controls the system hardware.

Form factor is an industry term for the size, shape, power supply type, and external connector type of the PCB (personal computer board) or motherboard. The standard form factors are the AT and ATX, although TYAN also makes some Baby-AT boards.

A **Global timer** is an onboard hardware timer, such as the Real Time Clock.

Handshaking is a form of encryption. One system, typically the server, sends an encryption scheme to another agent, typically a client. Thus, the client's data is protected during transmittal to the server.

HDD stands for **Hard Disk Drive**.

H-SYNC controls the horizontal properties of the monitor.

IC (Integrated Circuit) is the formal name for the computer chip.

IDE Integrated Device (or Drive) Electronics is a simple, self-contained hard drive interface. It can handle drives up to 8.4GB in size. Almost all IDEs sold now are in fact Enhanced IDEs (EIDEs).

IDE INT (IDE Interrupt) is a hardware interrupt signal that goes to the IDE.

I/O Input/Output is the connection between your computer and another piece of hardware (mouse, keyboard, etc.).

IRQ An Interrupt Request is an electronic request that runs from a hardware device to the CPU. The interrupt controller assigns priorities to incoming requests and delivers them to the CPU. It is important that there is only one device hooked up to each IRQ line; doubling up devices on IRQ lines can lock up your system. Happily, Plug and Play operating systems take care of these details for you.

ISA stands for **Industry Standard Architecture**. ISA is a slower 8- or 16-bit BUS (data pathway).

Latency is the amount of time that one part of a system spends waiting for another part to catch up. This is most common when the system sends data out to a peripheral device, and is waiting for the peripheral to send some data back (peripherals tend to be slower than onboard system components).

NVRAM ROM and EEPROM are both examples of **Non-Volatile RAM**, memory that holds its data without power. DRAM, in contrast, is volatile.

OEMs (**Original Equipment Manufacturers**) like Compaq or IBM package other companies' motherboards and hardware inside their case and sell them.

The **parallel port** transmits the bits of a byte on eight different wires at the same time (that is, in parallel form, eight bits at the same time).

PCI stands for **P**eripheral **C**omponent **I**nterconnect. PCI is a 32-bit local bus (data pathway) which is faster than the ISA bus. Local buses are those which operate within a single system (as opposed to a network bus, which connects multiple systems).

The **PCI PIO** (**PCI Programmable Input/Output**) modes are the data transfer modes used by IDE drives. These modes use the CPU for data transfer (DMA channels do not). PCI refers to the type of bus used by these modes to communicate with the CPU.

PCI-to-PCI bridge allows you to connect multiple PCI devices onto one PCI slot.

Pipeline burst SRAM is a fast secondary cache. It is used as a secondary cache because SRAM is slower than SDRAM, but usually larger. Data is cached first to the faster primary cache, and then, when the primary cache is full, to the slower secondary cache.

Pipelining improves system performance by allowing the CPU to begin executing a second instruction before the first is completed. A pipeline can be likened to an assembly line, with a given part of the pipeline repeatedly executing a set part of an operation on a series of instructions.

PM timers (**Power Management timers**) are software timers that count down the number of seconds or minutes until the system times out and enters sleep, suspend, or doze mode.

PnP is an acronym for Plug and Play, a design standard that has become ascendant in the industry. Plug and Play devices require little set-up to use. Novice end users can simply plug them into a computer that is running on a Plug and Play-aware operating system (such as Windows 95), and go to work. Devices and operating systems that are not Plug and Play require you to reconfigure your system each time you add or change any part of your hardware.

The term **RAM (Random Access Memory)**, while technically referring to a type of memory where any byte can be accessed without touching the adjacent data, is often used to refer to the system's main memory. This memory is available to any program running on the computer.

ROM (Read-Only Memory) is a storage chip which contains the BIOS (Basic Input/Output System), the basic instructions required to boot the computer and start up the operating system.

SDRAM (Synchronous Dynamic RAM) is so-called because it can keep two sets of memory addresses open simultaneously. By transferring data alternately from one set of addresses, and then the other, SDRAM cuts down on the delays associated with non-synchronous RAM, which must close one address bank before opening the next.

The **serial port** is so called because it transmits the eight bits of a byte of data along one wire, and receives data on another single wire (that is, the data is transmitted in serial form, one bit after another).

SIMM Single In-line Memory Modules are the most common form of RAM. They must be installed in pairs, and do not have the carrying capacity or the speed of DIMMs.

SIMM bank/socket SIMM sockets are the physical slots into which you stick SIMM modules. A pair of SIMM sockets form a SIMM bank, and act as a unit. If only one socket is filled, the bank will not operate.

In **Sleep/Suspend mode**, all devices except the CPU shut down.

SRAM Static RAM, unlike DRAM, does not need to be refreshed in order to prevent data loss. Thus, it is faster, and more expensive.

In **Standby mode**, the video and fixed disk drive shut down; all other devices

operate normally.

UltraDMA/33 is a fast version of the old DMA channel. UltraDMA is also called UltraATA. Without UltraDMA your system cannot take advantage of the higher data transmission rates of the new UltraATA hard drives.

Universal Serial Bus or USB, is a versatile port. This one port type can function as a serial, parallel, mouse, keyboard, or joystick port. It is fast enough to support video transfer, and is capable of supporting up to 127 daisy-chained peripheral devices.

VGA (Video Graphics Array) is the PC video display standard.

V-SYNC controls the vertical properties of the monitor.

ZIF socket Zero Insertion Force sockets make it possible to insert CPUs without damaging the sensitive pins. The CPU is lightly placed in an open ZIF socket, and the metal lever pulled down. This shifts the processor over and down, guiding it into place on the board.

Notice for the USA

Compliance Information Statement (Declaration of Conformity Procedure) DoC FCC Part 15: This Device complies with Part 15 of the FCC Rules.

Operation is subject to the following conditions:

1) this device may not cause harmful interference, and
2) this device must accept any interference received including interference that may cause undesired operation. If this equipment does cause harmful interference to radio or television reception, which can be determined by turning the equipment off and on, the user is encouraged to try one or more of the following measures:

- Reorient or relocate the receiving antenna.
- Increase the separation between the equipment and receiver.
- Plug the equipment into an outlet on a circuit different from that of the receiver.
- Consult the dealer or an experienced radio/television technician for help.

CAUTION: LITHIUM BATTERIES included with This PC board. Danger of explosion if battery is incorrectly replaced. Replace **ONLY** with the same or equivalent type recommended by manufacturer. Dispose of used batteries according to manufacturer instructions.

Notice for Canada

This apparatus complies with the Class B limits for radio interference as specified in the Canadian Department of Communications Radio Interference Regulations.

Cet appareil est conforme aux normes de Classe B d'interférence radio tel que spécifié par le Ministère Canadien des Communications dans les règlements d'interférence radio.

Notice for Europe (CE Mark)

This product is in conformity with the Council Directive 89/336/EEC, 92/31/EEC (EMC).

Jumper Settings Quick Reference

CPU Bus Speed Settings

Bus Speed	JP4	JP5	JP6
60MHz	2-3	2-3	2-3
66MHz	1-2	2-3	2-3
75MHz	1-2	1-2	2-3
83MHz	1-2	2-3	1-2
95MHz	2-3	1-2	1-2
100MHz	1-2	1-2	1-2

CPU Clock Multiplier

Multiplier	JP1	JP2	JP3
2.5x	ON	ON	OFF
3x	OFF	ON	OFF
3.5x	OFF	OFF	OFF
4x	ON	OFF	ON
4.5x	ON	ON	ON
5x	OFF	ON	ON
5.5x	OFF	OFF	ON

CPU Core Voltage Settings

CPU Voltage	JP8	JP9	JP10	JP11	JP12
1.3V	OFF	OFF	OFF	OFF	ON
1.4V	OFF	ON	OFF	OFF	ON
1.5V	OFF	OFF	ON	OFF	ON
1.6V	OFF	ON	ON	OFF	ON
1.7V	OFF	OFF	OFF	ON	ON
1.8V	OFF	ON	OFF	ON	ON
1.9V	OFF	OFF	ON	ON	ON
2.0V	OFF	ON	ON	ON	ON
2.1V	ON	OFF	OFF	OFF	OFF
2.2V**	OFF	ON	OFF	OFF	OFF
2.3V	ON	ON	OFF	OFF	OFF
2.4V	OFF	OFF	ON	OFF	OFF

CPU Voltage	JP8	JP9	JP10	JP11	JP12
2.5V	ON	OFF	ON	OFF	OFF
2.6V	OFF	ON	ON	OFF	OFF
2.7V	ON	ON	ON	OFF	OFF
2.8V	OFF	OFF	OFF	ON	OFF
2.9V	ON	OFF	OFF	ON	OFF
3.0V	OFF	ON	OFF	ON	OFF
3.1V	ON	ON	OFF	ON	OFF
3.2V	OFF	OFF	ON	ON	OFF
3.3V	ON	OFF	ON	ON	OFF
3.4V	OFF	ON	ON	ON	OFF
3.5V	ON	ON	ON	ON	OFF

CMOS Reset

	JP13
Default	1-2
Reset CMOS	2-3

Memory Clock

Same as:	JP7
CPU Clock	1-2
AGP Clock	2-3

J3 External Pin Assignments

		1	2		
HDD LED	VCC	1	2	Power LED	Pwr/Slp LEDs
	LED	3	4	Ground	
Reset Switch	Ground	5	6	Power On/Off	Power Switch
	Switch	7	8	Ground	
Infrared	VCC	9	10	Ground	SMI Switch
	Receive	11	12	K/B Lock	
	IRRX	13	14	Ground	
	Ground	15	16	SMI Switch	
	IRTX	17	18	Ground	

FAN Pin Assignments

	1	2	3
FAN1, FAN2	GND	+12V	Fan Monitor

See pages 14-16 for details on Jumpers.