

Tyan S1837

Thunderbolt

Motherboard User's Manual

Revision 1.10

Copyright © Tyan Computer Corporation, 1999. All rights reserved. No part of this manual may be reproduced or translated without prior written consent from Tyan Computer Corp.

All registered and unregistered trademarks and company names contained in this manual are property of their respective companies including, but not limited to the following.

AMIBIOS is a trademark of American Megatrend Incorporated.

Windows is a trademark of Microsoft Corporation.

IBM, PC, AT, PS/2 are trademarks of IBM Corporation.

INTEL, Pentium II, Celeron are trademarks of Intel Corporation.

S1837 Thunderbolt is a trademark of TYAN Computer Corporation.

Information contained in this publication has been carefully checked for accuracy and reliability. In no event will Tyan Computer be held liable for any direct or indirect, incidental or consequential damage, loss of use, loss of data, or other malady resulting from errors or inaccuracies of information contained in this manual. The information contained in this document is subject to change without notice.

PRINTED IN USA

Table of Contents

1. Introduction.....	4
Overview.....	4
Icons.....	5
Hardware Specifications/Features.....	6
Software Specifications.....	8
Technical Support.....	8
Returning Merchandise for Service.....	9
2. Board Installation.....	11
Unpacking.....	11
Installation.....	11
Quick Reference for Jumpers.....	13
Map of Motherboard Jumpers.....	14
Setting Jumpers.....	16
Server Management Connector (External SMI).....	18
Chassis Intrusion Alarm Connector.....	18
Audio Connectors.....	19
Clear CMOS & Reset Password.....	19
Soft Power Connector.....	20
Hardware Reset Switch Connector Installation.....	20
CMOS RTC.....	20
Flash EEPROM.....	20
Mounting the Motherboard in the Chassis.....	21
Installing Memory.....	21
Cache Memory.....	24
Installing the CPU and Cooling Fan.....	25
Connecting IDE and Floppy Drives.....	33
Connecting the Power Supply.....	35
Installing Add-on Cards.....	36
Connecting PS/2, USB, Serial & Parallel Drivers.....	37
Intel Ethernet Setup and Use.....	38
Creative Labs Sound Drivers Installation Note.....	51
Frequently Asked Questions.....	51
3. BIOS Configuration.....	55
Main Setup.....	56
Advanced CMOS Setup.....	61
Chipset Setup.....	66
Power Management Setup.....	72

Plug and Play Setup.....	76
Peripheral Setup.....	81
Supervisor and User Security.....	85
Language Utility.....	86
Flash Writer Utility.....	86
4. System Resources.....	87
Beep Codes.....	87
Troubleshooting System Problems.....	88
Displayed Error Messages.....	89
Appendix 1 - CPU Retention Module Options.....	91
Appendix 2 - Adaptec Ultra2 LVD SCSI.....	93
Appendix 3 - Glossary	102

chapter 1

Introduction

Overview

The Thunderbolt family is a quality, high performance motherboard designed for Intel Pentium II and Pentium III microprocessors. This motherboard utilizes the Intel 440BX or 440GX AGPsets and can support CPU speeds of 233MHz through 550MHz and host bus speeds of 66MHz to 100MHz (please see Tyan's website for up-to-date CPU support information).

The motherboard, with built-in AGP slot, provides high performance capabilities that are ideal for a wide range of demanding applications such as CAD, CAM, CAE, desktop publishing, 3D animation, and video production.

This integrated high-performance system board is supported in an Extended ATX form factor. Some of the features included are onboard UltraDMA/33, onboard dual channel Ultra2 SCSI (Adaptec 7896 chip), onboard Creative ES1373 Audio, onboard Intel Ethernet 82559, and onboard high speed I/O.

With I/O and drive controller support built onboard, the one AGP slot, six PCI and one ISA slots (one shared, seven usable) are free for numerous add-on expansion cards.

Remember to take a look at TYAN Computer's web site located at <http://www.tyan.com>. There you can find information on all of TYAN's products along with FAQs, distributors list, drivers, and BIOS setting explanations.

Icons

In order to help you navigate this manual and set up your system, we have added several icons to our format.



This icon alerts you to particularly important details regarding the setup or maintenance of your system. This icon often appears next to information that may keep you from damaging your board or system. While we will often point out the most vital paragraphs in a chapter, you should always read every word in the text. Failing to do so can lead to exasperation and expense.



Wherever possible, we have included step-by-step instructions for setting up your system, which are indicated by this icon. However, it is in your best interest to read an entire section (and perhaps the entire manual) before you begin to fiddle with your motherboard.



While we have alerted you to potential dangers in several places in the manual with this icon, these warnings should not be regarded as the whole of your safety regimen. Never forget that computers are electrical devices, and are capable of delivering a shock. Prevent damage to yourself and to your board: always ensure that your system is turned off and unplugged whenever you are working with it, and that you are equipped with a static safety device.

Hardware Specifications/Features

Processor Information

- Two SEC slots (Slot One type)
- 66MHz to 100MHz bus support
- Pentium II or Pentium III 233-600MHz*
- Supports Celeron CPUs in single mode

Chipset Information

- Intel 440GX (or BX) AGPset
- Intel PIIX4e controller
- National 82351 Super I/O chipset

BIOS Information

- AMI Plug and Play flash BIOS
- Deep Green, Energy Star, ACPI, Year 2000, and PC98 compliant (Adaptec AIC-7896 SCSI chip is NOT PC98 compliant at this time)
- Yellow LED for sleep mode

Main Memory

- Up to 2048MB onboard (for GX model)
- Up to 1024MB onboard (for BX models)
- Four 168-pin DIMM sockets
- Supports PC100 SDRAM with SPD, and SDRAM+ECC
- Supports 66MHz SDRAM with SPD with 66MHz CPU clock only

Expansion Slots

- One 32-bit AGP slot
- Six 32-bit PCI Bus Master slots
- One 16-bit ISA slot
- One shared, seven usable

Disk Drive & System I/O

- Two PCI bus mastering EIDE channels
- Supports EIDE CD-ROMs
- PIO Mode 3 & 4 (up to 16.6MB/sec DTR)
- UltraDMA/33 bus mastering mode (up to 33MB/sec DTR)

* See TYAN website for CPU Compatibility List

- Support for one floppy drive (Mode 1.44MB supported)
- Two serial ports (16550 UARTs)
- One ECP/EPP parallel port
- One IR (InfraRed) I/O interface port (shared with Com2)
- Two USB rev 1.1 ports
- One PS/2 mouse port
- One PS/2 keyboard port

Onboard Ultra2 SCSI

- Adaptec AIC-7896 dual channel Ultra2 LVD SCSI
- Two 68-pin high density Ultra2 SCSI ports
- One 50-pin legacy connector
- Adaptec Ultra SCSI BIOS

Onboard Ethernet

- Intel 82559 10/100 Ethernet onboard
- Full Wake-on functionality (Requires ATX 2.01 power supply)
- One RJ-45 ATX connector

Creative Labs Sound (Optional)

- 32-bit PCIES1373 audio chip
- ATX Joystick, Audio in, Speaker, Micro phone connectors

System Hardware Management

- Onboard hardware for monitoring temperature, supply voltages, and fan speed
- Intel LANDesk Client Manager software
- Chassis intrusion detection capable

Voltage and Power Information

- ATX power supply connector
- +12V power source for DC fan onboard
- 3.3V DRAM support
- Utilizes GTL+ bus to reduce power consumption and EMI

Physical Dimensions

- Extended ATX design
- 13 inches x 12 inches
- IO shield compatible with Intel Marlinspike (included)

Software Specifications

OS

- Operates with Windows 98, Windows NT 4.0, OS/2, Novell Netware, and SCO Unix

Technical Support

If a problem arises with your system, you should turn to your dealer for help first. Your system has most likely been configured by them, and they should have the best idea of what hardware and software your system contains. Hence, they should be of the most assistance. Further, if you purchased your system from a dealer near you, you can actually bring your system to them to have it serviced, instead of attempting to do so yourself (which can have expensive consequences).

If your dealer is unable to assist you,
try our web page,
technical support phone line,
or e-mail address

<http://www.tyan.com>
(510) 440-8808
techsupport@tyan.com

Returning Merchandise for Service

During the warranty period, contact your distributor or system vendor **FIRST** for any product problems. This warranty only covers normal customer use and does not cover damages incurred during shipping or failure due to the alteration, misuse, abuse, or improper maintenance of products.

For Resellers Only:

A receipt or copy of your invoice marked with the date of purchase is required before any warranty service can be rendered. You can obtain service by calling the manufacturer for a Return Merchandise Authorization (RMA) number. The RMA number should be prominently displayed on the outside of the shipping carton and the package should be mailed prepaid, or hand-carried to the manufacturer. TYAN will pay to have the board ground-shipped back to you.

This page is intentionally left blank.

chapter 2

Board Installation

Unpacking

The retail motherboard package should contain the following:

- S1837 motherboard
- One 40-pin IDE and 34-pin floppy cable pack
- User's manual
- One 3-head Ultra2 SCSI cable (cables with 4 heads or longer must be ordered separately)
- One 3-head regular SCSI cable
- Two CPU retention modules
- One ATX I/O Shield
- One System Management & Driver CD; includes complete drivers for SCSI, LAN and audio controllers
- One gameport cable
- Three Driver Diskettes for Adaptec 7896

Installation

You are now ready to install your motherboard. The mounting hole pattern of the Thunderbolt matches the ATX system board specifications. Your chassis

should be that of an extended ATX motherboard form factor.

How to install our products right...the first time.



What's the first thing I should do?

The first thing you should do is read this user's manual. It contains important information which will make configuration and setup much easier.

Here are some precautions you should follow when installing your motherboard:

- (1) **Ground yourself properly before removing your motherboard from the antistatic bag.** Unplug the power from your computer and then touch any metal part on the computer case. (Or wear a grounded wrist strap.)
- (2) **Hold the motherboard by its edges and do not touch the bottom of the board.**
- (3) **Avoid touching motherboard components, IC chips, connectors, and leads.**
- (4) **Avoid touching pins of memory modules and chips.**
- (5) **Place motherboard on a grounded antistatic surface or on the antistatic bag.**



Having reviewed the precautions above, the next step is to take the motherboard out of the cardboard box and static bag, hold it by its edges, and place it on a grounded antistatic surface, component side up. Inspect the board for damage.

DO NOT APPLY POWER TO THE BOARD IF IT HAS BEEN DAMAGED!

Press down on any of the socket ICs if it appears that they are not properly seated (the board should still be on an antistatic mat). Do not touch the bottom of the board. Remember, don't take any electronic device out of its protective bag until you are ready to actually install it into the computer case. If you do not ground yourself, you risk zapping the motherboard or adapter card. Subsequent problems may not arise immediately because electrostatic discharge damage, unlike physical damage, causes the device to fail over time.

***Power Supply Requirement: ATX Power Supply should be 2.01 compliant. Standby current must be 750mA or higher (SB5V = 0.75A)**

Installation Steps

1. Set Jumpers / Dip Switch
2. Mount Motherboard in Chassis
3. Install Memory
4. Install CPU & Cooling Fan
5. Connect IDE and Floppy Drives
6. Connect Power Supply
7. Install Add-on Cards
8. Connect PS/2, USB, Serial and Parallel Devices

Quick References for Jumpers

In this manual, the terms “closed” and “on” are used when referring to jumpers (or jumper pins) that are active; “open” and “off” are used when referring to jumpers (or jumper pins) that are inactive. See the **Figure 2-1** for examples of “on” and “off” pins and jumpers. The square pin in the diagram is Pin 1.

Jumpers and pins are connected by slipping the blue plastic jumper connector overtop of two adjacent jumper pins (indicated by **1-2** or **2-3**). The metal rod

2 pin jumpers

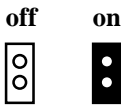

Figure 2-1

3 (or more) pin jumpers

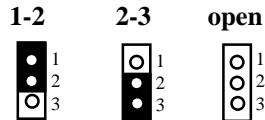
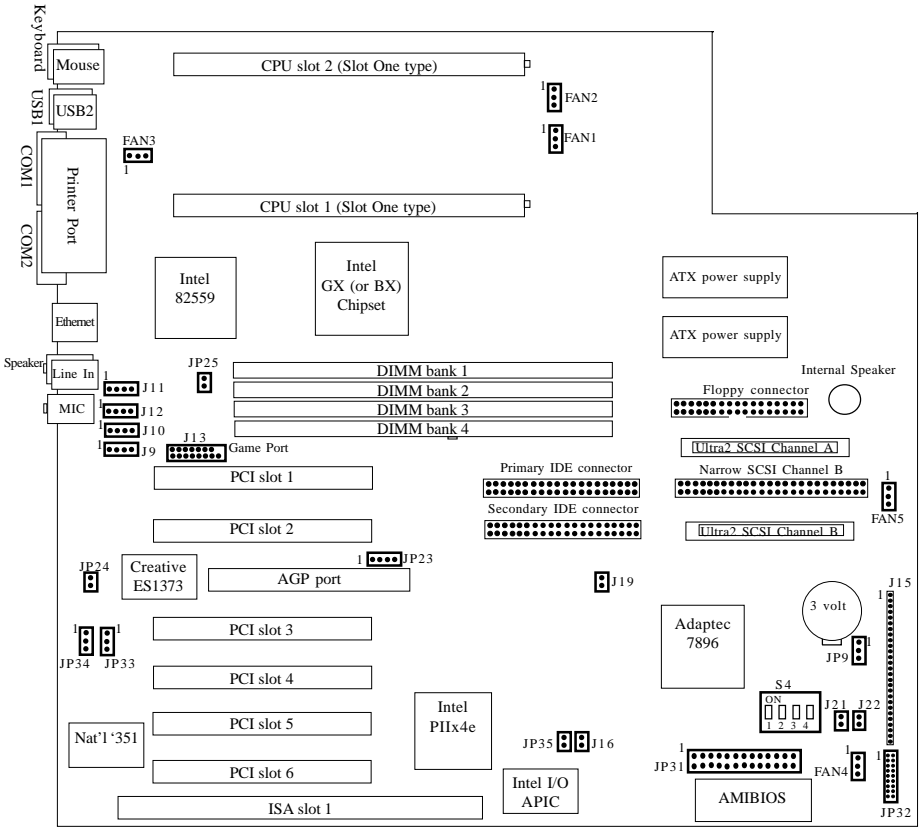

Figure 2-2

inside the plastic shell bridges the gap between the two pins, completing the circuit. See **Figure 2-2** for more examples of pin connections.

The tables and maps on the following pages will help you set the jumpers for CPU speed, Infrared, and external connector pin assignments, among others. The miniature motherboard maps will help you locate the jumpers on your board. A full-page map of the motherboard can be found on the next two pages.

Map of Motherboard Jumpers



The tiny “1”s next to jumpers of 3 pins or more indicate the position of pin 1 for that jumper.

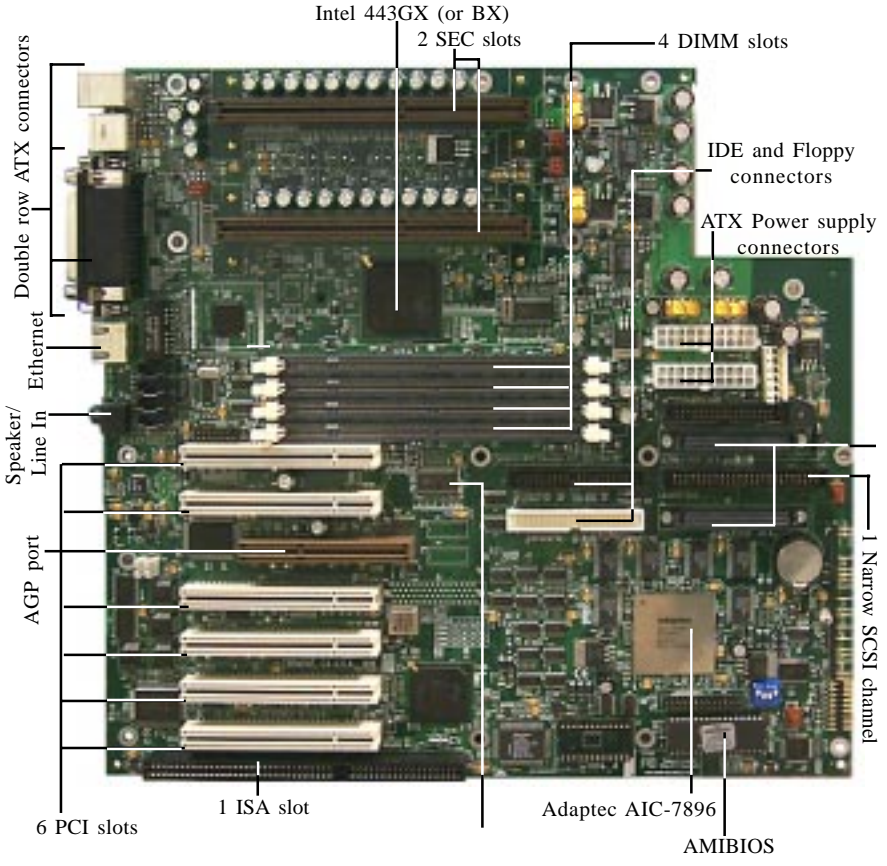

INSTALL

1. Setting Jumpers

1-A. CPU Speed Settings (Switch S4)

There are two steps to set the CPU speed. First, set the **clock multiplier** with jumpers S4 according to the specification of your Pentium II CPU using the chart below. There is no need to set the bus speed. The motherboard auto-detects the bus speed of the CPU. **Pentium III and newer CPUs have their clock multiplier preset - as a result, those CPUs will ignore the S4 setting.** Presently all Celeron CPUs use a 66MHz bus speed. Tyan does not recommend operating CPUs, memory, or PCI Bus at higher than rated speed. Tyan takes no responsibility for any problems related to overclocking any bus or component on the system board.



Multiplier (set Jmprs on board)	Bus Speed	CPU speed	1	2	3	4
3.5	100	350	ON	OFF	OFF	ON
4.0	100	400	OFF	ON	ON	ON
4.5	66	300	OFF	ON	OFF	ON
	100	450	OFF	ON	OFF	ON
5.0	66	333	OFF	OFF	ON	ON
	100	500	OFF	OFF	ON	ON
5.5	66	366	OFF	OFF	OFF	ON
	100	550	OFF	OFF	OFF	ON
6.0	66	400	ON	ON	ON	OFF
	100	600	ON	ON	ON	OFF
6.5	66	433	ON	ON	OFF	OFF
7.0	66	466	ON	OFF	ON	OFF

1-B. Front Panel Assignment (Jumper J15)

Pins	1-2	6-10	13-16	18-20	22-23	24-27
Function	Power On/Off	IR Connector	HDD LED	Power LED	Reset Switch	Speaker
Assignment	1=Power On/Off 2=GND	6=VCC 8=IR RX 9=GND 10=IR TX 11=Mode	15= - cathode 16=+ anode	18=GND 20=+	22=GND 23=Reset	24=VCC 26=Internal Speaker 27=-

1-C. Speaker Connector (Jumper J15)

The speaker should be connected to pins 24-27 of jumper J15. As default, pins 26-27 of jumper J15 are connected to enable the internal buzzer.

1-D. Connector Pinout (JP32)

VCC	1	2	Power LED
HDD LED	3	4	Sleep LED
Ground	5	6	Power On/Off
Reset	7	8	Ground
VCC	9	10	No Connect
IR Receive	11	12	VCC
Ground	13	14	No Connect
IR Transmit	15	16	VCC
No Connect	17	18	No Connect

*Power LED: For 2-pin: bicolor/single color LED - Use pins 2-4
 For 3-pin: bicolor LED - Use pins 2-4 and GND pin 13

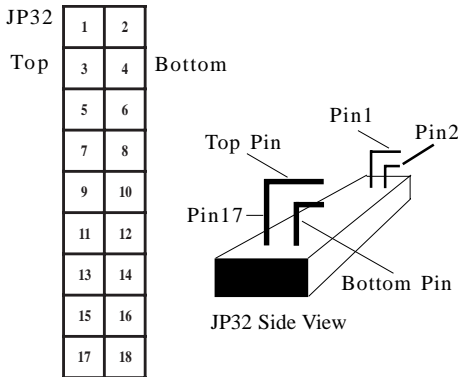

1-E. Wake-On Ring Connector (JP33)

Pin	1	2	3
	+5 VSB	Ground	WOR

1-G. Wake-On LAN Connector (JP34)

Pin	1	2	3
	5VSB	Ground	WOL

1-H. Server Management Connector (JP31)

The EXTSMI (External System Management Interface) connector, jumper JP31, is used by some plug-in cards. Certain applications associated with these plug-in cards use the interface for hardware control and queries.

1-I. Chassis Intrusion Alarm Connector (J16)

The J16 connector is an intrusion alarm, that can be connected to the system chassis. When active (J16 is connected to the chassis), this alarm will alert the system administrator anytime someone opens the system's case.

1-J. Fan1, Fan2, Fan3, Fan4, Fan5 - Pinout

Pin	1	2	3
	Ground	+12V	Speed

- Fan1 connector corresponds to CPU 1 slot.
- Fan2 connector corresponds to CPU 2 slot.
- Fan3 / Fan4 are Chassis Fan
- Fan5 = connector header

Note: With Intel's LANDesk system monitoring software, only 3 fans can be monitored at one time.

1-K. Fan3 Speed Detect (J21) and Fan4 Detect (J22)

J21 and J22 are 2-pin jumpers that control the monitoring of Fan3 or Fan4 respectively. If J21 is set to the ON (closed) position, Fan3 can be monitored by LANDesk. If set to the OFF (open) position, the Fan will NOT be monitored by LANDesk.

When using Intel's LANDesk system management software, you may monitor the status of the CPU Fans by connecting them to the **Fan1** and/or **Fan2** connectors. You will NOT be able to monitor your CPU fan with the other Fan connectors.

1-L. Audio / Video Connector Pinouts - J9, J10, J11, J12

	1	2	3	4
J9 - MPEG Input	MPEG LRCLK	MPEG BCLK	MPEG Data In	Ground
J10 - Modem Audio	Phone	Ground	Ground	Mono Out
J11 - TV Card Audio	In-Left	Ground	Ground	In-Right
J12 - CD Audio Connector	CD_IN-Left	Ground	Ground	CD_IN-Right

Audio Connectors

There are four black 4-pin connectors onboard which are used for various peripherals' audio signals. The digital signal that comes in through these connectors is directed through the Ensoniq 1373 PCI sound chip, and the digital signal is turned into an audio signal which goes out through the speaker. The TDA connector (J10) is for modem audio; the MPEG connector (J9) is for DVD and TV cards; the VIDEO connector is (J11); the CD connector (J12) is for CD-ROMs.

1-M. Onboard Sound Enable/Disable (JP24) ***

	Enable	Disable
JP24	OFF	ON

1-N. Onboard SCSI Enable/Disable (J19) ***

	Enable	Disable
J19	OFF	ON

1-O. SCSI LED Pinout (JP23)*

Pin	1	2	3	4
	VCC	SCSI LED	SCSI LED	VCC

* Default setting is 1-2

1-P. Onboard LAN Enable/Disable (JP25) ***

	Enable	Disable
JP25	OFF	ON

1-Q. Clear CMOS and Reset Password (Jumper JP9)

	Default	Reset
JP9	1-2	2-3

*** Plastic Jumper connectors are not provided. Setting is OFF or "Enabled" by default.

If you have been locked out of your system because you forgot your password or set the CMOS incorrectly, follow the instructions below.

1. Power off the system
2. Set jumper JP9 to pins 2 and 3 (see page 14 for location of JP9).
3. Wait for at least 2 seconds, then return jumper JP9 to pins 1 and 2.
4. Power on the system again.

By following this procedure, you will erase your password and reset the CMOS to the BIOS defaults.

Soft Power Connector

The Soft Power Connector is part of jumper block J15. The Thunderbolt uses the chipset for power management, including turning on and off the system. If the Power Button Function option in the BIOS Power Management Menu is set to On/Off (which is the default), pressing the power button once after the BIOS has booted up will turn the system on and off. If the Power Button Function option is set to Suspend, pressing the power button once will wake the system or send it to Suspend mode. In this case, you cannot turn the system off unless you shut down through the Windows operating system or you hold the power button down for at least four seconds.

Hardware Reset Switch Connector Installation

The Reset switch on your case's display panel provides you with the Hardware Reset function, which is the same as power on/off. The system will do a cold start after the Reset button is pushed.

CMOS RTC

The Real Time Clock (RTC) circuit, which provides the date and time for the system is integrated into the 440BX/GX AGPset. If the external battery for the RTC is low, you will most likely lose your BIOS settings. Normally the life span of an external battery is 2 years. If yours is running low, you will need to replace it with a new 3V lithium battery (CR2032).

Flash EEPROM

The Thunderbolt uses flash memory to store BIOS firmware. It can be updated as new versions of the BIOS become available. You can upgrade your BIOS easily using the flash utility (see page 86).

2. Mounting the Motherboard in the Chassis

Follow the instructions provided by the case manufacturer for proper installation guidelines. TYAN recommends that you make use of all mounting holes to screw down the motherboard. The adapter cards and the screws holding them down will keep your board flat. The fastening screw should not short any of the traces on the motherboard. Make certain that you do not overtighten the screw, as it will damage the motherboard and possibly break internal traces in the surrounding area. The hole you should use is located at the top-center of the board where the adapter cards are fastened to the case.

3. Installing Memory

Since TYAN boards are manufactured with performance in mind, you should use add-in components that match. Some DIMM modules may seem to be high quality because of name or feel but that does not guarantee real-world usability. Some cheaper or OEM memory may have brand-name components, but they may contain inferior or substandard parts which do not meet the critical tolerances our products require. Because of this, your memory may not work correctly in a TYAN board though it may work well in a competitor's board. This is because many of our competitors do not adhere to the strict tolerances required for high performance. If you buy a TYAN board, you are getting the best system available. To make installation easy and trouble free, get high quality parts. For a list of recommended memory vendors, please visit Tyan's website at www.tyan.com - go to the "Memory Support" area in the Support Section. The website memory compatibility lists include DIMMs that have proven to be very stable on our boards and perform extremely well.

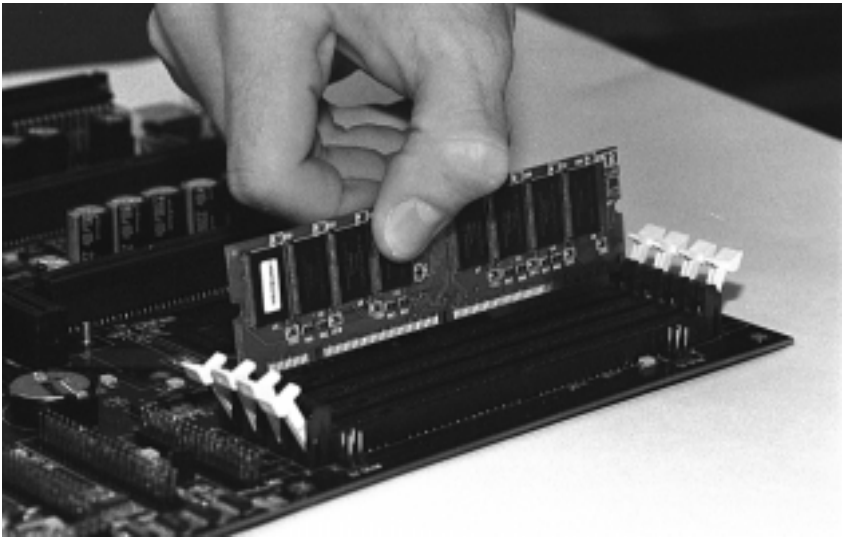

Figure 2-3

To install your DIMMs, line your module up so that the pins fit into the slot. There is only one way that your DIMM can fit properly. Make sure that the short row of pins is lined up with the short gap in the DIMM slot. Figure 2-3 above shows how to sit the DIMM into its slot. To insert the DIMM, push down vertically on the module with even force, as shown in the photo. Do not shove one end in first; doing so will bend the DIMM pins.



To lock the DIMM into place, push the plastic clips on either end of the slot onto the notches in the ends of the DIMM (see Figure 2-4 on the next page). In some cases, pushing the memory module into the DIMM slot will move the plastic clips inward, automatically locking the module into place. To remove your DIMM, simply pull the clips back, and pull up on the module.

Place the DIMMs in an antistatic bag as soon as you remove them to avoid static damage.

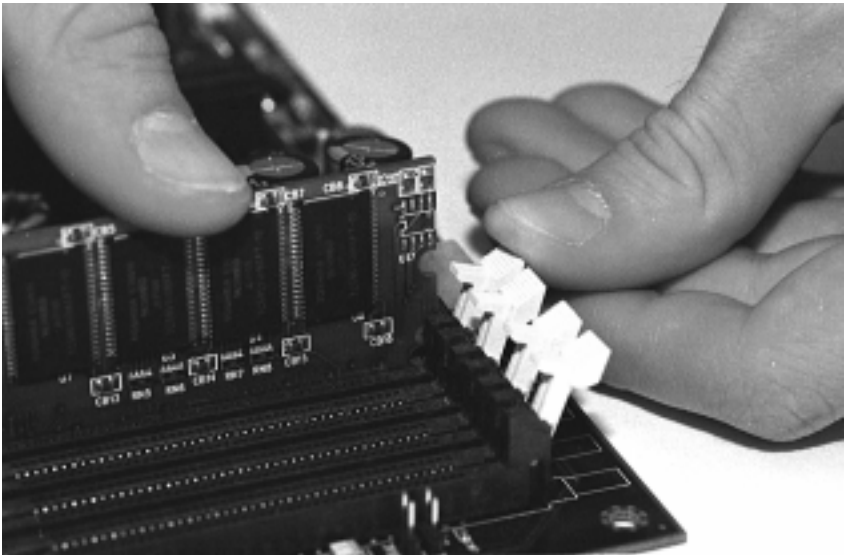

Figure 2-4

The Thunderbolt uses a 64-bit data path from memory to CPU and can accommodate up to 2 GB of SDRAM. The 168-pin DIMMs (Dual In-line Memory Modules) must be of the 3.3V, **unbuffered** variety. The position of the notch in the SDRAM key position will tell you whether or not a DIMM is unbuffered (see the Figure 2-5 below). All installed memory will be automatically detected, so there is no need to set any jumpers.

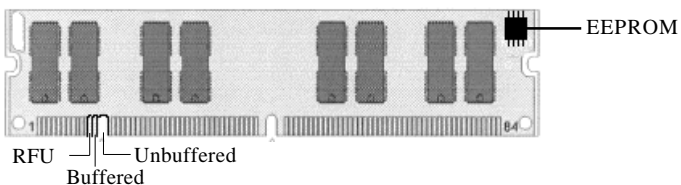

Figure 2-5

Some details of memory installation:

- The mainboard supports 32MB, 64MB, 128MB SDRAM; and supports 256MB registered SDRAM DIMM modules. *
- PC-100 DIMM is required if CPU bus speed is at 100MHz



important!

- The board supports registered or nonregistered memory chips. **DO NOT** mix registered and nonregistered memory chips on the motherboard.

The table below shows some of the possible memory configurations. Not all possible configurations are listed.

DIMM Bank 1	DIMM Bank 2	DIMM Bank 3	DIMM Bank 4	Total
8MBx1	8MBx1	8MBx1	8MBx1	32MB
16MBx1	16MBx1	8MBx1	0	40MB
16MBx1	16MBx1	16MBx1	16MBx1	64MB
32MBx1	16MBx1	16MBx1	16MBx1	80MB
32MBx1	32MBx1	16MBx1	16MBx1	96MB
64MBx1	32MBx1	16MBx1	16MBx1	128MB
64MBx1	64MBx1	32MBx1	32MBx1	192MB
64MBx1	64MBx1	64MBx1	64MBx1	256MB
128MBx1	64MBx1	64MBx1	64MBx1	320MB
128MBx1	128MBx1	64MBx1	64MBx1	384MB
128MBx1	128MBx1	128MBx1	0	384MB
128MBx1	128MBx1	128MBx1	128MBx1	512MB
256MBx1	0	0	0	256MB
256MBx1	256MBx1	0	0	512MB
256MBx1	256MBx1	256MBx1	0	768MB
256MBx1	256MBx1	256MBx1	256MBx1	1024MB
*512MBx1	*512MBx1	*512MBx1	*512MBx1	*2048MB



Warning! The 256MB DIMMs represented in the table are REGISTERED memory chips. DO NOT use registered and nonregistered memory chips simultaneously! (Check with your memory dealer for more information).

See www.tyan.com for latest memory compatibility information.

Cache Memory

Celeron processors have the L2 (Level 2) cache built into their architecture, so there is no need for an L2 cache on the motherboard. The Celeron processor has a physical L2 cache size of 128KB and a cacheable memory area of 512MB.

4. Installing the CPU and Cooling Fan

Pentium II or Pentium III processors can be used on the Thunderbolt. Please refer to pages 16-20 for the correct CPU jumper settings for your board. Remember:

- The CPU is a sensitive electronic component and it can easily be damaged by static electricity. Do not touch the CPU pins with your fingers.
- Before the CPU is installed, the motherboard must be placed on a flat surface. You should be able to insert the CPU with minimal, but firm, pressure. Do not press down hard on the CPU.



Currently, two types of cooling mechanisms are produced for Pentium II processors: active (figure 2-6a) and passive (figure 2-6b). These two types of cooling methods essentially perform the same function. The active cooler is equipped with a cooling fan and heat sink, while the passive cooler is simply a larger heat sink with no fan. The type of cooler used has no effect on performance, and both types can be installed in the CPU slot on the Thunderbolt board.



Figure 2-7

Installing CPU Retention Modules

Installation of a Pentium II / III processor requires a CPU retention module, which is first secured onto the motherboard. Tyan offers a variety of retention mechanisms for the different CPU types. See Appendix 1 for options.

Installation of SECC2 CPUs (Figure 2-7 above) with the retention modules require a little more attention and care. Instructions for SECC2 CPU installation can be found on pages 27-32.

To attach the retention module, place the motherboard on a flat surface. Locate the key pin on one end of the CPU slot on the board. Then carefully line up the key notch on the retention module with the key pin on the CPU slot (the key pin on the CPU slot indicates the correct orientation of the CPU) See Figure 2-8.

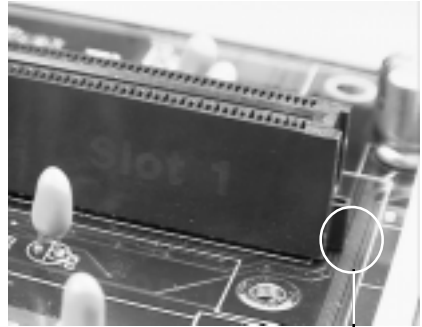

Figure 2-8 - Pentium II Slot Connector and Key Pin



Figure 2-9

Drop the retention module (Figure 2-9) down over the CPU slot so that the retention module sits flat against the motherboard. Tighten the screws in a clockwise manner to secure the module to the board. Warning: Do not overtighten the screws as you may damage the module and/or the motherboard.

Installing the CPU with Active Cooling

When the retention module is securely installed, you are ready to plug in the CPU. Press down firmly on the CPU until you hear a “click” (see Figure 2-10). This clicking sound indicates that the CPU is fully locked into the retention module. If you have an active cooler, you will also need to connect the CPU’s cooling fan cable to the cooling fan power connector on the board.



Figure 2-10

Locate the cooling fan connector (e.g. FAN1) on the motherboard. Plug the CPU’s cooling fan cable into the cooling fan connector on the board. There will be a plastic clip assembly similar to that of the ATX power connector that will force you to connect the fan cable correctly (see Figure 2-11 on the following page).

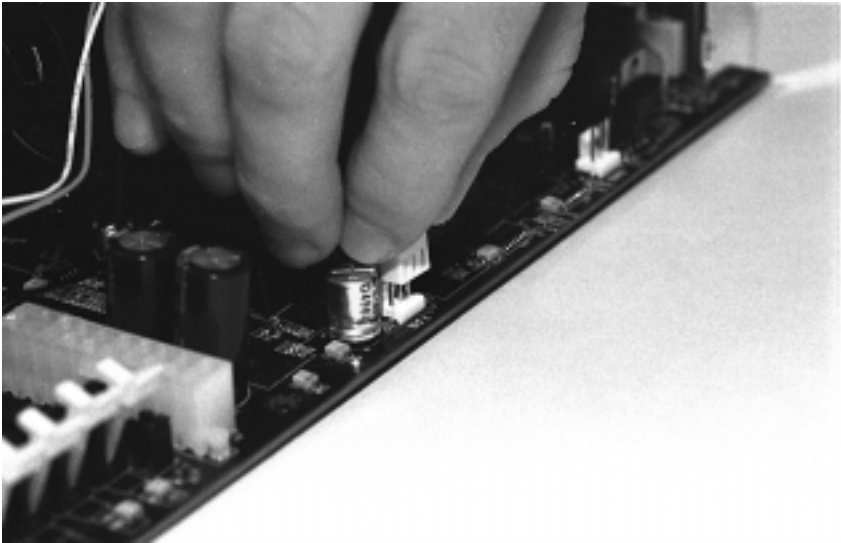

Figure 2-11

Removing the CPU.

To remove the CPU, move the locks to the center of the CPU. A click will be heard when the CPU has been unlocked. Gently pull up on the CPU, taking care not to bend the motherboard or the CPU retention module.

To remove the lock from the retention module, gently press the ends of the locks inward and pull.

Installing SECC2 CPUs - Option 1

The major physical difference between regular Pentium II's and Pentium SECC2 is the plastic CPU enclosure. As Figure 2-12 indicates, the plastic CPU enclosure covers the entire CPU card of regular Pentium II's. On the other hand, the plastic CPU enclosure covers only the side faces of the SECC2 Pentium II / III card.

Due to the physical differences in the SECC2 CPU, installing the retention modules requires a different technique than the ones previously discussed.

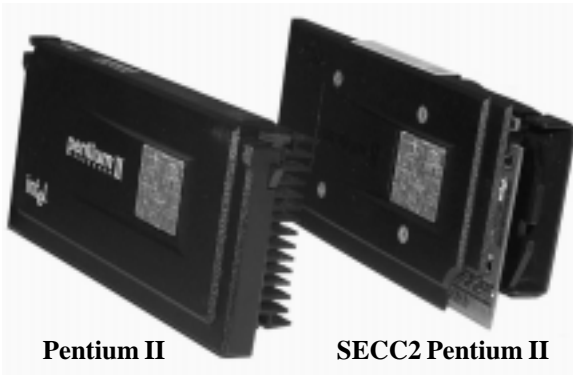

Figure 2-12

On both sides of the SECC2 CPU reside the lower tabs of the aluminum heat sink and the bottom corners of the plastic CPU enclosure (see Figure 2-13). These tabs and corners should fit into the retention braces.

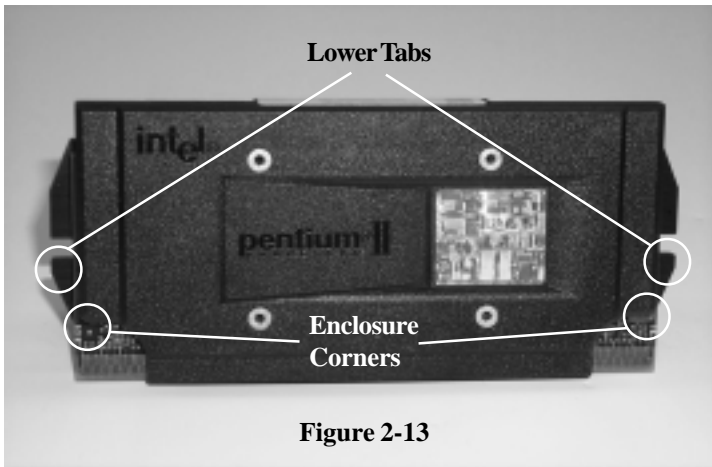

Figure 2-13



Warning: DO NOT first screw the retention braces onto the motherboard by themselves. If you do, you will have difficulties inserting the CPU into the retention braces and CPU slot.

Currently, the retention module recommended for securing the SECC2 CPU is included in the motherboard package. The retention braces consist of two small components that resemble ‘bookends’. (See Figure 2-14)

The first installation step is to set the retention braces properly against the sides of the CPU. The lower tabs of the aluminum heat sink and the bottom corners of the plastic enclosure should loosely fit within the two slits of the braces.

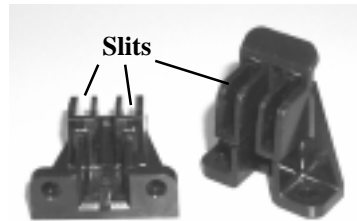

Figure 2-14

Figures 2-15 below show a top view and side view of a retention brace positioned against one side of the SECC2 CPU.

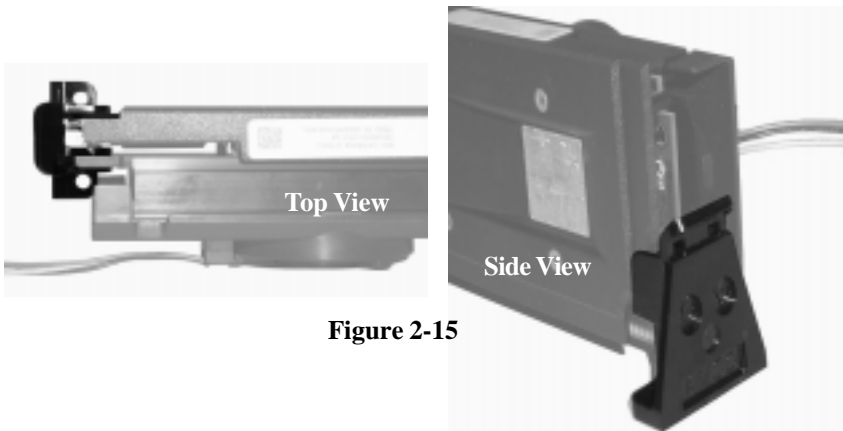

Figure 2-15

When both braces are properly positioned, press both braces against the sides of the CPU and carefully lift them over the CPU slot on the motherboard.

Warning - Because the braces are loosely held against the CPU, they can easily fall off. You must hold both braces against the CPU while lifting all three components above the motherboard. (See Figure 2-16 on the following page.)

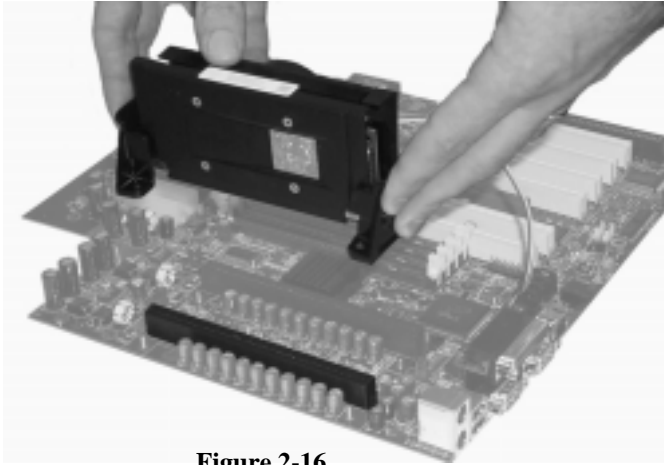

Figure 2-16

Be sure to line up the holes of the retention brace with the screws protruding from the motherboard. At the same time, make sure the CPU is lined up with the CPU slot. Lower the three components onto the motherboard. The screws on the motherboard should fit through the holes of the retention braces and the CPU should fit into the slot. Secure the retention braces with the nuts provided in the package. The end result should look like Figure 2-17.

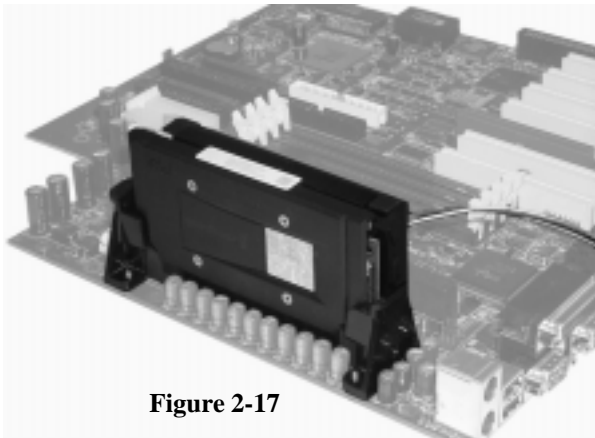

Figure 2-17



important!

When removing the CPU, unscrew the nuts on the retention braces and remove all three components at once. This may require careful firm tugs to pull the CPU out of its slot.

Installing SECC2 CPUs - Option 2

Another method to secure an SECC2 CPU is by using the Universal Retention Module (also provided by Tyan). The universal retention module is designed to accommodate most versions of the Pentium II/III CPUs. Included in this solution is an overhead clip to lock the CPU into its slot along with the side universal braces. See Figure 2-18 (right) for the universal retention module components.

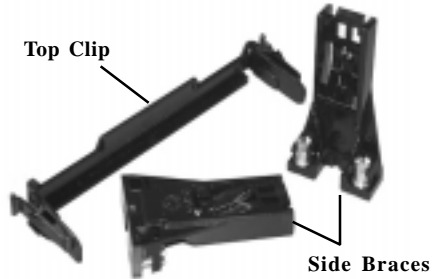

Figure 2-18

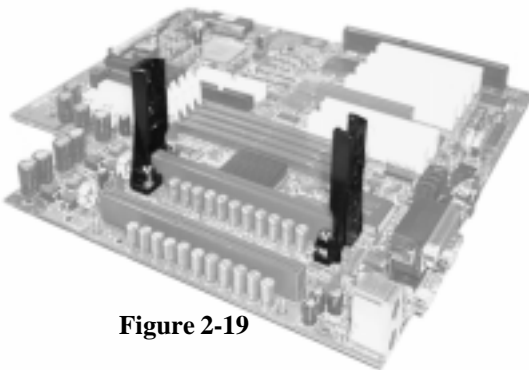

Figure 2-19

To install the CPU, place the two side braces at the ends of the CPU slot (see Figure 2-19 left). The screws on the motherboard should fit through the holes of the retention braces. Tighten and secure both braces using a screw driver.

Next, carefully insert the CPU between the braces and onto the CPU slot (see Figure 2-20). Make sure the CPU fan faces towards the center of the motherboard.

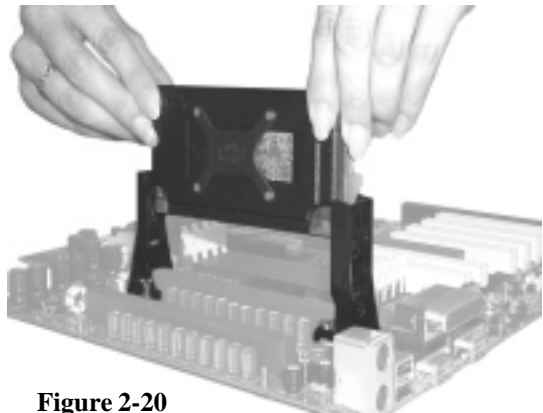

Figure 2-20

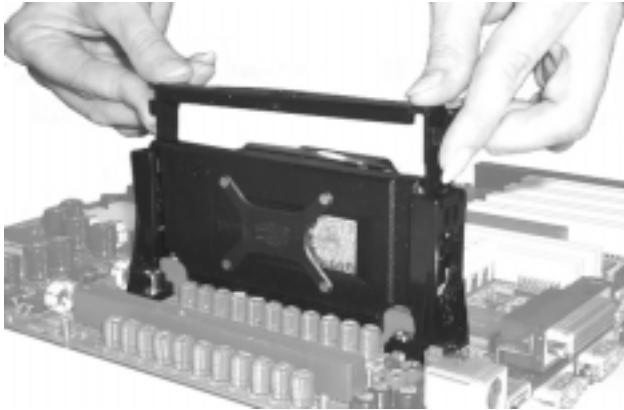

Figure 2-21

When the CPU is secured onto the slot, take the overhead clip and insert the ends of the clip over the top of the side braces (See Figure 2-21 above). You will hear a ‘click’ when the overhead clip is fitted securely into the side braces. **Make sure the tab of the overhead clip is oriented towards the same side of the CPU fan** (see Figure 2-22 below).

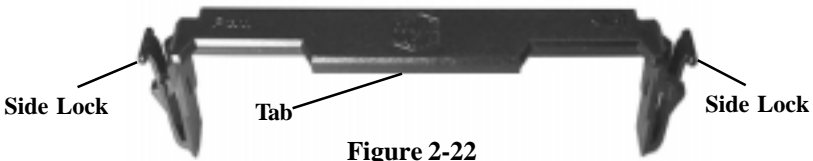

Figure 2-22

Removing CPU - Removal of the CPU is basically the reverse order of the installation steps. First remove the overhead clip. You need to push BOTH side lock tabs (see Figure 2-22 above) towards the center of the CPU in order to unlock it from the side braces.

After removing the overhead clip, you need to release the CPU from the braces one side at a time. Press the center “release tab” of one of the side braces (see Figure 2-23 right) while gently pulling that side of the CPU out of its slot. Repeat the procedure for the other side brace. When both ends of the CPU is loose from the side braces and the slot, you will be able to remove it from the motherboard.



Figure 2-23

5. Connecting IDE and Floppy Drives

The colored stripe on a ribbon cable should face toward the battery on the motherboard. In Figure 2-24 below, you can see how the IDE cables should look when they are connected to your hard drive. Notice how Pin 1 (denoted by a red stripe) is connected so that it is next to the power connector of the drive. The primary IDE connector is black; the secondary IDE connector is white

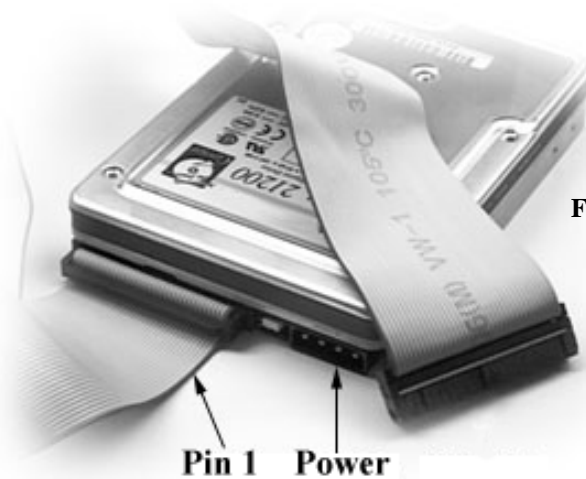

Figure 2-24

In most cases, this is the proper way of connecting your IDE cable to the harddrive. Figure 2-25 on the following page shows the IDE cable properly connected to the motherboard. Contact your hard disk drive manufacturer or documentation for more information.

Some symptoms of incorrectly installed HDDs are:

- Hard disk drives are not auto-detected: may be a Master / Slave problem or a bad IDE cable. Contact your vendor.
- Hard Disk Drive Fail message at bootup: may be a bad cable or lack of power going to the drive.
- No video or beeps on bootup: usually means the cable is on backwards.
- Hard drive lights are constantly on: bad IDE cable or defective drives/motherboard. Try another HDD.
- Hard drives do not power up: check power cables and cabling. May also be a bad power supply or IDE drive.

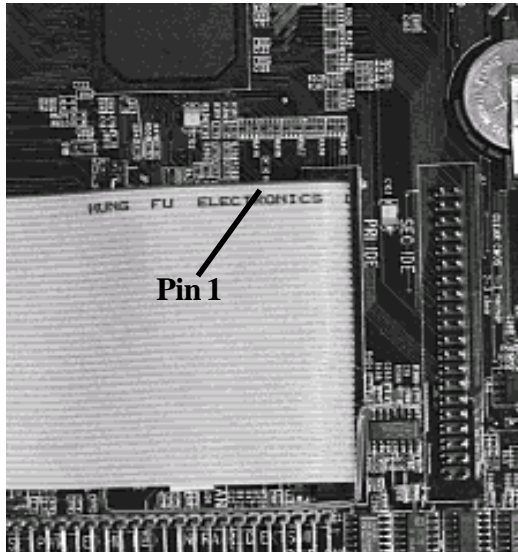

Figure 2-25

Connecting Floppy Drives

Pin 1 on the floppy cable is usually denoted by a red or colored stripe down one side of the cable (see Figure 2-26 below). Most of the current floppy drives on the market require that the colored stripe be positioned so that it is right next to the power connector. In most cases, there will be a key pin on the cable which will force you to connect the cable properly.

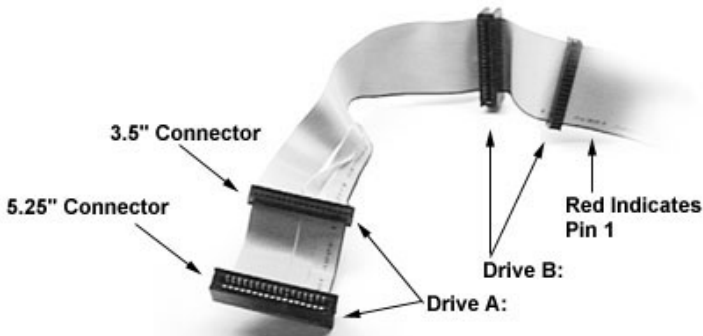

Figure 2-26

Drive A: is usually attached to the end of the cable with the twist in it. Drive B: is usually connected to the middle of the cable. Refer to your installation instructions or call your dealer if you are unsure about attaching floppy drives. Refer to Figure 2-26 for a detailed anatomy of the floppy cable. Remember, you can only have 2 floppy drives connected at any given time.

The color stripe on the cable should face toward the top of your chassis, or toward the big white B printed on the motherboard. Please refer to your documentation for proper installation.

Some symptoms of incorrectly installed floppies are:

- Floppy drives are not detected: usually caused by faulty cables, backward cables, or a bad floppy or motherboard. Try another single floppy drive to verify the problem or try another cable. Also, check to see if the onboard floppy is enabled in the BIOS.
- Floppy Drive Fail message at bootup: the cable, floppy, or motherboard may be faulty. Try another cable or floppy drive to verify.
- Light on the floppy is on constantly: a dead giveaway that the cable is on backwards. Reverse the cable at the motherboard end and try again.



6. Connecting the Power Supply

Tyan recommends using an ATX power supply that conforms to industry standard revision 2.01. The Thunderbolt motherboard comes equipped with two onboard power connectors.

Figure 2-27 on the following page shows an ATX power connector. When plugging in the power connector, make sure that the plastic clip on the power connector is aligned with the plastic tab on the onboard connector (see Figure 2-28 on the following page).



Make certain that you do not miss any pins because if you do, you will void your warranty and cause damage to yourself or your motherboard when you turn the system on. After connecting the power, make sure the connector is seated firmly into its socket so it will not become loose or fall off when the computer is jostled or moved. **NOTE: When installing your power supply, make sure the power supply switch is turned 'Off'. You may turn the switch back 'On' once you've finished building your system.**

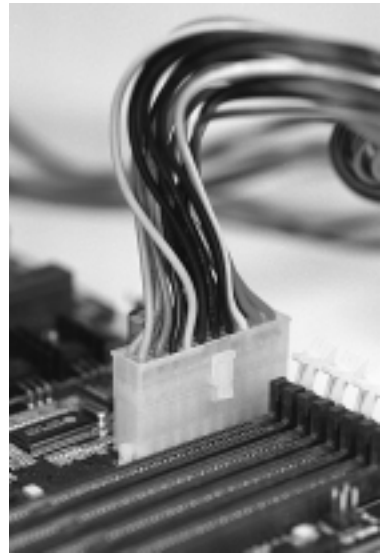

7. Installing Add-on Cards

There are a few rules you need to follow when plugging in a card. In order to assure proper operation and a quick installation, adhere to these guidelines:

- If you are going to install a PCI-Bus interface card on your system, be aware that any one of the PCI slots can support a Master or Slave device.
- NEVER force a card into a slot. If it doesn't fit, look at the socket on the computer to make sure there are no wires or other obstructions to the slot.
- NEVER plug an ISA card into a PCI slot or a PCI card in an ISA slot. You will void your warranty and damage your system board if you do this.
- When plugging the card in, especially when installing long cards, try to push the entire card in at one time. Don't force one end of the card into the socket first and then the other. This will create a rocking motion between the card and the slot and it will damage the pins within the socket.
- Make sure that the cards are seated securely into the slots.
- Before turning on the system, make sure no cards are touching

If you follow these basic guidelines, there shouldn't be any problems with



installation. However, if you do encounter any problems, have a qualified professional install your cards for you or contact your card manufacturer.

Remember, always read the manuals and installation notes that come with the adapter cards. They contain important information which will help you install the components right, the first time.

8. Connecting PS/2, USB, Serial & Parallel Devices

This board includes ports for USB, PS/2 mouse, and PS/2 keyboard devices. Note that, for this board, the PS/2 mouse port is the upper PS/2 port, and the PS/2 keyboard port is the lower PS/2 port.

The PS/2 connectors are probably quite familiar to you. The USB connectors, however, may be foreign. The USB (Universal Serial Bus) is a versatile port. This one port type can function as a serial, parallel, mouse, keyboard, or joystick port. It is fast enough to support video transfer, and is capable of supporting up to 127 daisy-chained peripheral devices.



Connecting Com and Printer Ports

Warning: When plugging in your keyboard and mouse, or when plugging anything into a serial or Com port, make sure that the power is off. Connecting these devices and ports while the power is on is called “hot plugging,” and may damage your system.

Figure 2-29 below shows the ATX double row connectors on this board. The Com and Printer ports, as well as the other ports, are labeled.

Note: Only TYAN cables will work on this motherboard. If you are using an

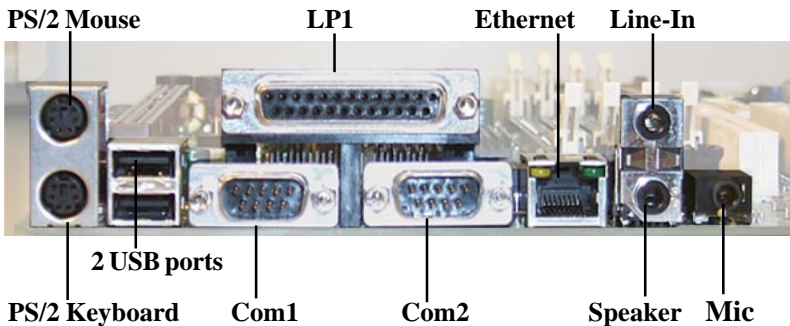

Figure 2-29

existing case with old cables, your system will not function properly. Use only TYAN-approved cables.

You are done!

Other than checking the jumper settings and cable connections and putting the case back on, you are done. Installing a new motherboard may sound difficult, but by following these directions, you should have a fairly uneventful time installing our products. If you do encounter problems, your dealer will be able to help you, or you can consult one of our many technical support resources (see page 8).

Intel Ethernet Setup and Use

The S1837UANG models have the Intel 82559 10/100 Ethernet chip onboard, which makes setting up your Ethernet connection quite simple. The following installation and configuration instructions are courtesy of Intel, and the copyright on the information belongs to Intel Corporation. For more information, data sheets, white papers, or demos, visit their networking web site at <http://www.intel.com/network>.

You can use your modem or Internet connection to download drivers, troubleshooting tips, and more. When downloading new drivers, make sure the archive is for the PRO/100+ adapter (not PRO/100). This information can be found on Intel's website, as well as their FTP site and BBS service. You may find the driver in Tyan's CD.

Connect the Network Cable.

Connect a single network cable to the PRO/100+ adapter. The cable will only fit one way. For 100BASE-TX, your network cable must be category 5, twisted-pair wiring. If you plan on running the adapter at 100 Mbps, it must be connected to a 100BASE-TX hub (not a 100BASE-T4 hub). For 10BASE-T, use category 3, 4, or 5 twisted-pair wiring.

100BASE-T Wiring: Twisted Pair Ethernet (TPE). Use category 5 cable and RJ-45 connector for this adapter. Do not use category 3 wiring at 100 Mbps. At 100 Mbps, connect to a TX hub, not a T4 hub. Note: For more information on 100BASE-T wiring requirements and limitations, see "Fast Ethernet Wiring" in this guide and refer to the README files on the installation disk.

To configure the adapter, continue with the procedures specific to your

operating system on the pages which follow.

Enable Wake-on LAN Power Jumper (JP34) - For Add-on Ethernet Cards only

In order for the Wake On LAN (WOL) feature to work correctly, the adapter must be connected to a continuous power source. This allows the PRO/100+ adapter to “listen to” the network even when the computer is turned off. The WOL power connector (JP34) is enabled when the jumper is connected or closed (ON). **Warning:** As always, turn off and unplug power to the computer before setting the WOL jumper. The WOL connector on your motherboard is live when the computer is plugged in to a power outlet. Failure to do so could damage the adapter or computer. Also, be sure that your ATX power supply is 2.01 compliant or better. This level of quality is required because WOL requires 800 mAmps of 5V standby current. Due to power supply requirements, the ethernet add-on card must have the Intel 82559 Chip for wake-up.



Using Wake-on LAN

In order to use the onboard LAN wake-up feature, you must enable the “LAN Wake-up for Onboard LAN” option in the Power Management Setup of the BIOS. The Wake-on LAN feature operates according to a published specification. In simple terms, the specification allows designers to build network adapters that are capable of “listening to” network activity even when the computer is turned off. WOL adapters have a special low power standby mode that is active when the rest of the computer is without power. The adapter will respond to a special “wake-up” packet sent by another computer or network device. Typically this wake-up packet causes the adapter to signal the computer to power up and run a predefined program.

The wake up packet structure and behavior is defined in the WOL specification, available from the website at <http://www.us.pc.ibm.com/infobrf/iblan.html>. See the “Troubleshooting” section on page 46 for Wake-on LAN troubleshooting tips.

Configuration and Drivers

The Ethernet driver can not be installed directly from the Tyán Driver CD. Before installing the Intel 82559 Ethernet drivers, the complete LAN 82559 directory and all its contents must first be copied from the Tyán Driver CD onto your hard drive. The 82559 driver can then be installed from your hard drive.



Make sure that you are following the proper instructions for your operating system (e.g. if you are using Windows 95 or 98, do not follow the Windows NT instructions).

DOS Setup for Novell NetWare Clients

Automatic configuration

PCI computers automatically detect and configure PCI-compliant adapters while booting. The Intel 82559-based Integrated Fast Ethernet For WfM adapter IRQ level and I/O memory address are automatically set by the BIOS each time you start your computer.

Start your computer to automatically configure the adapter. Configuration is complete when the DOS prompt appears. You can now continue with the procedure below.

Run Setup to install network drivers

Setup can automatically install NetWare DOS ODI client drivers for you or display a README file with installation instructions for other NOS drivers.



1. If your computer already has network drivers installed, restart the computer without loading them. If the drivers are loaded from the AUTOEXEC.BAT or CONFIG.SYS file, type REM in front of each line that loads a network driver. Or, with DOS 6.x or later press 5 as DOS starts, to bypass the drivers.
2. Insert the Intel Configuration and Drivers floppy/CD in a drive, switch to the appropriate drive/directory, and at the DOS prompt, type SETUP.
3. If you have more than one Intel PRO series PCI adapter in your computer, an adapter selection menu appears on the screen. Select the adapter you want by noting the Ethernet address. See “Installing Multiple Adapters” for more information.
4. Select Automatic Setup from the Main menu. Then follow the instructions on the screen. (If you want to test the adapter with a responder on the network, see the next procedure.) Setup displays the adapter’s configuration, then runs a series of diagnostic tests that makes sure the adapter and network are functioning properly. If Setup finds a problem, it displays the results and some possible solutions.
5. When Setup finishes the tests, you’ll see the Install Network Drivers screen.
6. Select the driver you want to install. Setup can install a NetWare client

driver for you. If you're installing other drivers, Setup displays a README file with installation instructions. If you can't connect to a server, first try the suggestions here, then turn to the "Troubleshooting" section on page 44.

- Make sure you're using the drivers for this adapter. The driver filename contains the letter B (for example, E100BODI.COM).
- If you're replacing an existing adapter, make sure the LINK statement in your NET.CFG is correct for the new adapter. For example, the LINK statement for a NetWare client should be: LINK DRIVER E100BODI
- Verify that the frame type in your NET.CFG file matches your network.
- If setting up a server, check your LOAD and BIND statements.
- Test the adapter by running diagnostics in Setup. Additional testing is available by using a responder (see next page).
- Check the README files.

Responder testing on the network (optional)

Setup can test the adapter more thoroughly if you have a responder on the network while running the tests.

1. Go to a computer on the network with any EtherExpress adapter installed (except EtherExpress 32 or EtherExpress 16 MCA).
2. Run the appropriate configuration program for the installed adapter and set it up as a responder.
3. Return to the computer with the new adapter. Run Setup and make the new adapter a sender. Test the adapter.

Windows NT Server or Workstation

Automatic configuration

PCI computers automatically detect and configure PCI-compliant adapters while booting. The Intel 82559-based Integrated Fast Ethernet For WfM adapter IRQ level and I/O address are automatically set by the BIOS each time you start your computer. Start your computer to automatically configure the adapter. Configuration is complete when Windows NT starts or the DOS prompt appears.

Install network drivers - Windows NT Version 4.0 only

We recommend that you install the network drivers for the onboard Intel 82559 network adapter after NT has been installed. In other words, do not let NT auto-detect the onboard network card during the installation. The following steps will guide you through the installation procedure. You will need to have the Tyan driver CD and the NT 4.0 CD for this procedure.



1. Boot NT 4.0
2. Get the Tyan Driver CD and copy the Intel LAN drivers to a directory on your hard disk drive.
3. Double-click the Network icon in the Control Panel
4. Click the Adapters tab in the window that appears.
5. Click Add. A list of adapters appears.
6. Select the "Have Disk" icon and point it to the directory that you created on your hard drive in step 2.
7. You will see "Intel PRO PCI Adapter". Click OK.
8. Follow the NT prompts to complete the installation. (This will require the NT 4.0 CD)
9. Click OK in the main PROSet window to return to Windows NT.
10. Click close to finish.
11. Restart Windows NT when prompted.
12. To verify proper installation of the adapter, go to the Control Panel, double-click the Network icon, select the Adapters tab. You should see the name "Intel (R) PRO/100+ Management Adapter" in the network adapter window.

To install multiple adapters, repeat this procedure for each new adapter. See "Installing Multiple Adapters" for specific information. To run the PROSet software at any time, double-click the Intel PROSet icon in the Control Panel or click the Adapter Properties button.

Install network drivers - Windows NT Version 3.5x only.

After putting the adapter in the computer and starting Windows NT, you need to install the Intel drivers and test the adapter.



1. Double-click the Network icon in the Control Panel.
2. Click Add Adapter.
3. When the list of adapters appears, scroll to the end of the list and select <Other> Requires disk from manufacturer.
4. Insert the Intel Configuration and Drivers disk/CD in the drive and click OK. Drivers and the Intel PROSet utility are installed and PROSet starts. PROSet

is an enhanced utility that you can use to easily configure and test your adapter in Windows NT. PROSet also displays the computer resources that were assigned to each PRO adapter installed. The PROSet main window is shown on the preceding page.

5. Click OK in the PROSet main window to return to Windows NT.
6. Click OK in the Network Settings dialog box and remove the installation disk. When prompted, restart Windows NT.

To install multiple adapters, repeat this procedure for each new adapter. See “Installing Multiple Adapters” for specific information. To run the PROSet software at any time, double-click the Intel PROSet icon in the Control Panel.

If Windows NT reports an error or you can’t connect to the network, try the suggestions here first, then turn to the “Troubleshooting” section on page 44 if necessary.

- Make sure you’re using the drivers for this adapter. Drivers are located on the Windows NT CD-ROM or on the Intel Drivers and Configuration disk version 2.3 or later.
- Make sure the driver is loaded and the protocols are bound. Check the Network Bindings dialog box in Windows NT.
- Check the Windows NT Event Viewer for error messages.
- If you are attaching to a NetWare network, check your frame type and verify that NetWare client software has been installed.
- Test the adapter with PROSet. After installing the adapter you can run PROSet from your hard disk. To do this, double-click the Intel PROSet icon in the Control Panel. Click Test to run diagnostics. For additional information, click Help in the PROSet window.
- Check with your LAN administrator — you may need to install supplemental networking software.

Windows 95

Install Network Drivers from CD



1. After completion of Windows 95 installation, you will have to remove the “PCI Ethernet Controller” under the ‘Device Manager’ menu. (Go to Control Panel and then to Device Manager. Under the “Other Devices” section, choose “PCI Ethernet Controller” and click “Remove”.)
2. Reboot the system. An “Update Device Driver Wizard” dialog box should appear indicating that a “PCI Ethernet Controller” has been found.

3. Click the “Next” button. Then click “Other Locations” from the window that appears. At the command prompt, type D:\LAN82559 (assuming D is your CD-ROM drive). Make sure your Tyan driver CD has been inserted.
4. Click “Finish”. An “Update Device Driver Wizard” dialog box will appear indicating that an “Intel (R) PRO/100+ Management Adapter” has been found.
5. When the “Copying Files” dialog box appears, type D:\LAN82559 at the command prompt (assuming D: is your CD-ROM drive).
6. Windows will copy files from both Tyan and Windows 95 CD. Continue installation process by following the Windows instructions.

Windows 98

Install Network Drivers from CD



1. After completion of Windows 95 installation, you will have to remove the “PCI Ethernet Controller” under the ‘Device Manager’ menu. (Go to Control Panel and then to Device Manager. Under the “Other Devices” section, choose “PCI Ethernet Controller” and click “Remove”.)
2. Reboot the system. An “Add New Hardware Wizard” dialog box should appear indicating that a “PCI Ethernet Controller” has been found.
3. Click the “Next” button. Then select the “Search for the best driver for your device” option. (Make sure your Tyan Driver CD has been inserted)
4. Select the “Specify a location” option. At the command prompt, type D:\LAN82559 (assuming D: is your CD-ROM drive)
5. Click “Next”. The “Intel (R) Pro/100+ Management Adapter” should appear. Click “Next” again.
6. Continue installation process by following the Windows instructions.
7. To check for proper installation, the “Intel Pro/100+ Management Adapter” should be found under “System Properties” in the Device Manager menu

NetWare Server, Client 32, UNIX, OS/2, Banyan, and Other Operating Systems

For these, refer to our online documents. On a DOS computer, view the appropriate README file for information on installing your network driver. To view the README files, insert the Intel Configuration and Drivers disk into a drive, switch to that drive, and type: SETUP /README. Look through the selection called “Installing Intel PRO/100+ Management Adapter Drivers” for the operating system you need.

Installing Multiple Adapters

All users: The adapter's 12-digit, hexadecimal Ethernet address is on a sticker on the motherboard near the LAN controller chip. The Ethernet address is sometimes called the node address or the MAC address. Note that the PCI slot number may not correspond with the physical connector in your computer. Install only one active WOL adapter per computer. You can install additional, non-WOL adapters.

NetWare users: The server drivers use the PCI slot number to identify each installed adapter. You can correlate the PCI slot number to the adapter by using the Ethernet address that is printed on a label on the adapter. Run Setup from the Intel disk to view the Ethernet address and slot number for each installed adapter. For more information, see the README files. NetWare 4.11 server installations use unique slot numbers that are assigned during sever setup.

Windows NT and Windows 95 users: Repeat the configuration procedure for each adapter you want to install (add only one adapter at a time). In Windows NT, be sure to click the Show all PRO Adapters box in the Configuration window. See the README file for more information.

Select Duplex Mode (optional)

Duplexing is a performance option that lets you choose how the adapter sends and receives data packets over the network. The PRO/100+ adapter can operate at full duplex only when connected to a full duplex 10BASE-T, 100BASE-TX switching hub, or another full duplex adapter. To summarize:

- Auto (requires a full duplex adapter or switching hub with auto-negotiation capability). The adapter negotiates with the hub to send and receive packets at the highest rate. This is the default setting. If the hub does not provide auto-negotiation, the adapter runs at half duplex.
- Full duplex (requires a full duplex switching hub or adapter). The adapter can send and receive packets at the same time. This mode can increase adapter performance capability. If the full duplex hub provides auto-negotiation, the adapter runs at full duplex. If the full duplex hub does not provide auto-negotiation, you need to set the adapter duplex mode manually (see following paragraphs)
- Half duplex. The adapter performs one operation at a time; it either sends or receives.

Note: If your hub is running at 100 Mbps and half duplex, your potential bandwidth is higher than if you run at 10 Mbps and full duplex.

“Push” Installation for Windows 95

If you are a LAN Administrator setting up server-based push installation of Windows 95 as defined in Microsoft Windows 95 Resource Kit, additional steps are required for this adapter. Refer to the Push Installation for Windows 95 README file under the Microsoft section of Installing EtherExpress PRO/100B adapter drivers.

These instructions apply to push installs of Retail Windows 95, Windows 95 w/ Service Pack 1, and Windows 95 OEM Service Pack 2 (OSR2).

Note: The network share Z:\PUSH is used here as an example path to the distribution folder. The distribution folder is where the setup files for Win95 reside. During the first step of the push install, the client will connect to the distribution folder with IPX or TCP/IP.



1. Copy the Win95 setup folder from the CD to Z:\PUSH. Use Explorer, Winfile or XCOPYY in order to maintain the same directory structure as on the CD.
2. From the "Intel EtherExpress(TM) PRO/100+ Lan Adapter Configuration and Drivers Diskette", copy the following files and directories into Z:\PUSH:

A:\NET82557.INF	->	Z:\PUSH\NET82557.INF
A:\82557NDL.DLL	->	Z:\PUSH\82557NDL.DLL
A:\WIN95\PUSH\CUSTOM.INF	->	Z:\PUSH\CUSTOM.INF
A:\WIN95\PUSH\MSBATCH.INF	->	Z:\PUSH\MSBATCH.INF
A:\NT*.*	->	Z:\PUSH\NT\
A:\NDIS*.*	->	Z:\PUSH\NDIS\
A:\DOS*.*	->	Z:\PUSH\DOS\

4. Connect the target client system to Z:\PUSH using IPX or TCP/IP.
5. Run Windows 95 setup with the following command line switches:
 Z:\PUSH> SETUP /IS /IW

For debugging purposes, include the additional switches to show each device class scanned for during PnP detection:

Z:\PUSH> SETUP /IS /IW /P B;G=3

Troubleshooting

If the adapter can't connect to the network:

- Make sure the cable is installed properly. The network cable must be securely attached at both RJ-45 connections (adapter and hub). If the cable is attached but the problem persists, try a different cable. The maximum allowable distance from adapter to hub is 100 meters. If you're directly connecting two computers (no hub), use a crossover cable. Most hubs require a straight-through cable, while most switches require a crossover cable (see your hub or switch documentation to verify). See the Cabling Information README file for more information on crossover cables.
- Check the LED lights on the adapter. The onboard cable connector has two diagnostic LEDs. These lights help indicate if there's a problem with the connector, cable, or hub. The table below describes the LEDs, and the drawing on the next page shows their location.

LED	Indication	Meaning
LNK (green)	On	The adapter and hub have acknowledged a connection; the link between the hub and adapter is good.
	Off	The cable connection between the hub and adapter is faulty, or you have a driver configuration problem.
100 (yellow)	On	Network connection operating at 100Mbps.
	Off	Network connection operating at 10Mbps.

100 Mbps LED Link LED

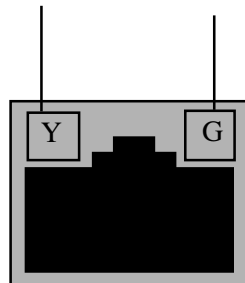

- Make sure you're using the correct drivers. Make sure you're using the drivers that come with this adapter. Drivers that support previous versions of the Intel PRO/100+ Management Adapter do not support this version of the adapter.
- Make sure the hub port and the

adapter have the same duplex setting. If you configured the adapter for full duplex, make sure the hub port is also configured for full duplex. Setting the wrong duplex mode can degrade performance, cause data loss, or result in lost connections.

Testing the adapter

Test the adapter by running Intel diagnostics. For DOS or Windows 3.1 computers, run Setup on the Intel Drivers and Configuration disk. For Windows NT and Windows 95 run Intel PROSet by double-clicking the Intel PROSet Icon in the Control Panel. Click Help from the main PROSet window to get complete diagnostics information and instructions.

Common problems and solutions

SETUP.EXE reports the adapter is "Not enabled by BIOS".

- The PCI BIOS isn't configuring the adapter correctly.

The computer hangs when the drivers are loaded.

- Change the PCI BIOS interrupt settings.
- If you are using EMM386, it must be version 4.49 or newer (this version ships with MS-DOS 6.22 or newer).

Diagnostics pass, but the connection fails or errors occur.

- At 100 Mbps use category 5 wiring and make sure the network cable is securely attached.
- For NetWare clients, make sure you specify the correct frame type in our NET.CFG file.
- Make sure the duplex mode setting on the adapter matches the setting on the hub.
- At 100 Mbps, connect to a 100BASE-TX hub only (not T4).

The LNK LED doesn't light.

- Make sure you've loaded the network drivers.
- Check all connections at the adapter and the hub.
- Try another port on the hub.
- Make sure the duplex mode setting on the adapter matches the setting on the hub.
- Make sure you have the correct type of cable between the adapter and the hub. 100 BASE-TX requires two pairs. Some hubs require a crossover cable while others require a straight-through cable. See the Cabling README file for more information on cabling.

The adapter stopped working when another adapter was added to the computer.

- Make sure the cable is connected to the EtherExpress PRO/100 TX PCI adapter.
- Make sure your PCI BIOS is current.
- Make sure the other adapter supports shared interrupts. Also, make sure your operating system supports shared interrupts — OS/2 doesn't.
- Try reseating the newest adapter.

The adapter stopped working without apparent cause.

- Try reseating the adapter first, then try a different slot if necessary.
- The network driver files may be corrupt or deleted. Delete and then reinstall the drivers.
- Try a different PRO/100 TX PCI adapter.
- Run the diagnostics.

The Wake-on LAN feature is not working.

- Make sure the WOL cable is attached and power is applied to the computer.
- Check the BIOS for its WOL setting. Some computers may need to be configured to WOL.
- Make sure the network cable is fully attached to the adapter.

Link LED does not light when power is connected.

- Make sure WOL cable is attached and power is applied to computer.
- Make sure network cable is attached at both ends.

Technical Information

Fast Ethernet Wiring

100BASE-TX Specification: The 100BASE-TX specification supports 100 Mbps transmission over two pairs of category 5 twisted-pair Ethernet (TPE) wiring. One pair is for transmit operations and the other for receive operations. Segment lengths are limited to 100 meters with 100BASE-TX for signal timing reasons. This complies with the EIA 568 wiring standard.

Fast Ethernet Hub and Switches

The two basic types of hubs are shared hubs and switching hubs. Intel PRO/100+ adapters can be used with either type of hub for 10 Mbps. At 100 Mbps, a TX hub or switch is required.

Shared hubs

In a shared network environment, computers are connected to hubs called repeaters. All ports of the repeater hub share a fixed amount of bandwidth, or data capacity. On a 100 Mbps shared hub, all nodes on the hub must share the 100 Mbps of bandwidth. As stations are added to the hub, the effective bandwidth available to any individual station gets smaller. Shared hubs do not support full duplex.

Think of a shared repeater hub as a single-lane highway that everyone shares. As the number of vehicles on the highway increases, the traffic becomes congested and transit time increases for individual cars.

On a shared hub all nodes must operate at the same speed, either 10 Mbps or 100 Mbps. Fast Ethernet repeaters provide 100 Mbps of available bandwidth, ten times more than what's available with a 10BASE-T repeater.

Repeaters use a well-established, uncomplicated design, making them highly cost effective for connecting PCs within a workgroup. These are the most common type of Ethernet hubs in the installed base.

Switching hubs

In a switched network environment, each port gets a fixed, dedicated amount of bandwidth. In the highway scenario, each car has its own lane on a multi-lane highway and there is no sharing.

In a switched environment, data is sent only to the port that leads to the proper destination station. Network bandwidth is not shared among all stations, and each new station added to the hub gets access to the full bandwidth of the network.

If a new user is added to a 100 Mbps switching hub, the new station receives its own dedicated 100 Mbps link and doesn't impact the 100 Mbps bandwidth of another station. Switching hubs can effectively increase the overall bandwidth available on the network, significantly improving performance. Switching hubs can also support full duplex.

For more information on Fast Ethernet, visit the Network Products website (<http://www.intel.com/network>).

Creative Labs Sound Drivers Installation Note For S1837UANG Win NT 4.0 / Win95 / Win98

Creative Labs ES1373 PCI Sound Setup

Note: This note assumes drive D: for your CDROM drive.

- 1) Go to the following directory path:
D:\Audio\S1837\drivers\setup\english
- 2) Select (double-click) sbsetup.exe - Setup window will appear with "Sound Blaster Setup Options". The two options are "Remove Only" and "Remove and Install Software". The default setting is "Remove and Install Software". Use the default setting and click "Next".
- 3) Click "Next" again. The installation will begin and autodetection of hardware and drivers will follow.
- 4) Click the "Finish" button and reboot the computer.

Frequently Asked Questions

Q: Why don't I get a display after I put in my old DIMM module?

A: The 440BX/GX chipset requires the memory manufacturer to program an EEPROM chip with **SPD** (Serial Presence Detection) on the module in order for the BIOS to program the chipset's timing registers properly. Your DIMM may not have the EEPROM chip on the module, or the EEPROM may not contain the correct program. The figure below shows a DIMM module with an SPD EEPROM chip. One solution is to change the **Method of Memory Detection** in the **Advanced Chipset Setup** of the BIOS to the "Auto Only" setting.

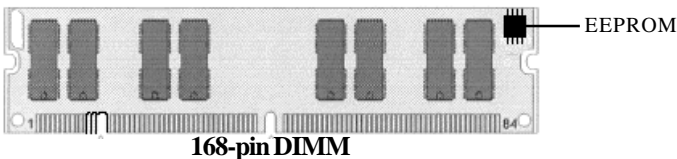

Q: My system sometimes becomes unstable. How should I check the system?

A: The first thing to do is to check and see if you have any device conflict in I/O address, IRQ, or DMA. If you are using Windows 95, the Device Manager is a good place to start. Please consult your operating system manual for details. Second of all, slowing down the memory timing in the BIOS's chipset setup section will help the situation, as well. Many memory modules are not suitable for high performance systems and are probably the main source of your

problem.

Q: Can I use EDO DIMMs on this motherboard?

A: No. The Intel 440BX/GX AGPset does not support EDO memory.

Q: What is AGP?

A: AGP (Accelerated Graphics Port) is a new bus architecture for 3D graphics. The AGP slot eliminates the PCI bandwidth bottleneck by bypassing the PCI interface and accessing the system memory directly. Currently, the AGP supports 1X and 2X modes, which yield bandwidths of 266MB/s (at 33MHz bus speed) and 533MB/s (at 66MHz bus speed), respectively. Compare this with the mere 132MB/s (at 33MHz bus speed) that you get from the PCI bus.

Q: Does my operating system support AGP?

A: Currently, only Windows 98 and Windows 2000 will have built-in support for AGP. Some AGP cards require Windows 95 OSR2.1 or a special driver from Intel. Please check with your graphics vendor for more details.

Q: How do I install the onboard NIC drivers for WinNT 4.0?

A: The Ethernet driver can not be installed directly from the Tyan Driver CD. Before installing the Intel 82559 Ethernet drivers, the complete 82559 directory and ALL its components must first be copied from the Tyan CD onto your hard drive. The 82559 installation program can then be copied normally from your hard drive.

Q: How can I disable the keyboard detection in the BIOS?

A: You need to enable the Quick Boot option in CMOS - then the BIOS will not check for a keyboard.

Q: I cannot install Windows NT when I use an LS/120-type floppy disk drive. What should I do?

A: SYMPTOM - When you are trying to install Windows NT, you may experience any of the following symptoms:

1) When you boot from the installation disks, the following error message may be displayed when disk 2 is inserted:

Stop 0x0000007B Inaccessible Boot Device
(0xFF109C50, 0x00000000, 0x00000000, 0x00000000)

2) When you are attempting to create a set of installation disks using the

WINNT /ox or WINNT32 /ox command, the following error message may be displayed:

This floppy disk is not formatted as high-density, not formatted with a standard Windows NT or MS-DOS format, or is corrupted. Setup is unable to use this disk.

CAUSE OF THE PROBLEM: You are using a LS/120-type floppy disk drive.

RESOLUTION - To work around this issue, install Windows NT Workstation with the /b switch. This causes Windows NT Workstation Setup to run without requiring the installation disks.

If you are using the S1837D or are installing with Adaptec 3940 with AIC-7896 chip then you must install NT 4.0 with a standard 1.44MB floppy disk.

Q: Where can I get Intel PRO/100+ Management Adapter drivers?

A: You will find the drivers located in the Tyán Drivers CD under the subdirectory 'LAN82559'. Please note: You must use the drivers provided in the Tyán CD only. These drivers have been tested and approved by Tyán engineering.

Q: Why does my Intel Ethernet work only intermittently?

A: The Inter Ethernet only operates under standby current; therefore, your power supply must be ATX 2.01 Compliant with a minimum SB5V current of 750mA.

Q: Why does my keyboard LED remain on after the system is turned off?

A: This situation is most likely caused by the enabling of Keyboard Wake-Up Function (under the Peripheral Setup) in the BIOS. When enabled, the motherboard would provide a standby voltage to the keyboard. This would subsequently cause the LED to remain on.

Q: How do I enable the Keyboard Wake-Up function?

A: You will need go into the BIOS and enable the LAN Wake-Up for Onboard LAN (under the Power Management Setup) and the Keyboard Wake-Up Function (under the Peripheral Setup). When both functions are enabled, you can start up your system by hitting the Ctrl key and the F1 key at the same time. By default both the LAN Wake-Up and Keyboard Wake-Up functions are disabled.

This page is intentionally left blank.

chapter 3

BIOS Configuration

The AMIBIOS Setup screen is shown below.

AMI BIOS EASY SETUP UTILITY Ver.1.16 (c)1998 American Megatrends, Inc. All Rights Reserved	
Main	Advanced Security Exit
System Date Fri Jan 1 1999 System Time 12:55:37 Floppy Drive A 1.44 MB 3½ Floppy Drive B Not Installed Primary IDE Master Auto Primary IDE Slave Auto Secondary IDE Master Auto Secondary IDE Slave Auto Auto-Detect Hard Disks [Enter] Boot Sector Virus Protection Disabled	Setup Help Month: Jan - Dec Day: 01 - 31 Year: 1901 - 2099 ↑ Previous Item ↓ Next Item ↔ Select Menu
ESC:Exit Enter:Select F5:Setup Defaults F6:Original Values F10:Save & Exit	

You can select a Setup option by using the following keyboard keys:

Key	Function
Tab	Moves from one box to the next
Arrow keys	Changes selections within a box
Enter	Opens highlighted selection

The pages which follow contain explanations of the settings for the AMIBIOS Setup menus. Drawings have been included for ease of reference. Overall, the AMIBIOS Setup program is easy to use, and fairly intuitive. Note that the graphics in the manual are simpler than those that appear on your screen.

Main Setup

Select the AMIBIOS Setup options below by choosing Main Setup from the AMIBIOS Setup main menu. The Standard Setup menu screen is shown below.

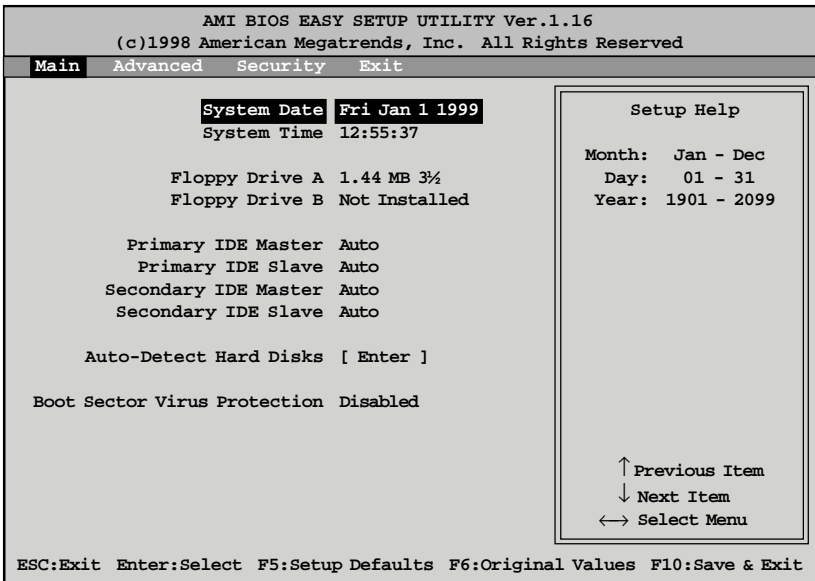

System Date/Time

You can type the date and time in directly, or select the portion of the date or time that you want to modify and adjust it using the ↑ ↓ cursor keys. The clock runs on a 24-hour cycle (i.e. 1:00 PM is 13:00).

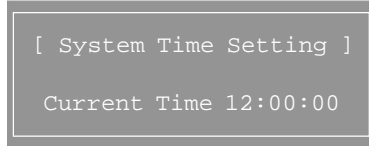
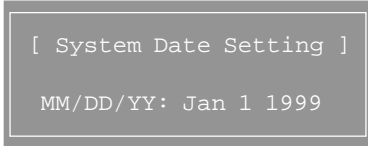

Floppy Drive A: and B:

Move the cursor to these fields via the arrow keys and select the floppy type. The settings are 360KB 5¼ inch, 1.2 MB 5¼ inch, 720KB 3½ inch, 1.44MB 3½ inch, or 2.88MB 3½ inch. If you are not sure what type of floppy drive you have, consult the documentation that came with your drive.

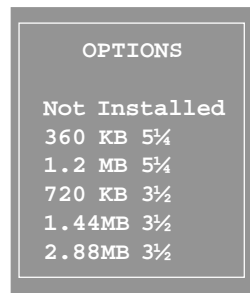

BIOS

Primary Master, Primary Slave, Secondary Master, Secondary Slave

Select these options to configure the various drives. A screen with a list of drive parameters appears.

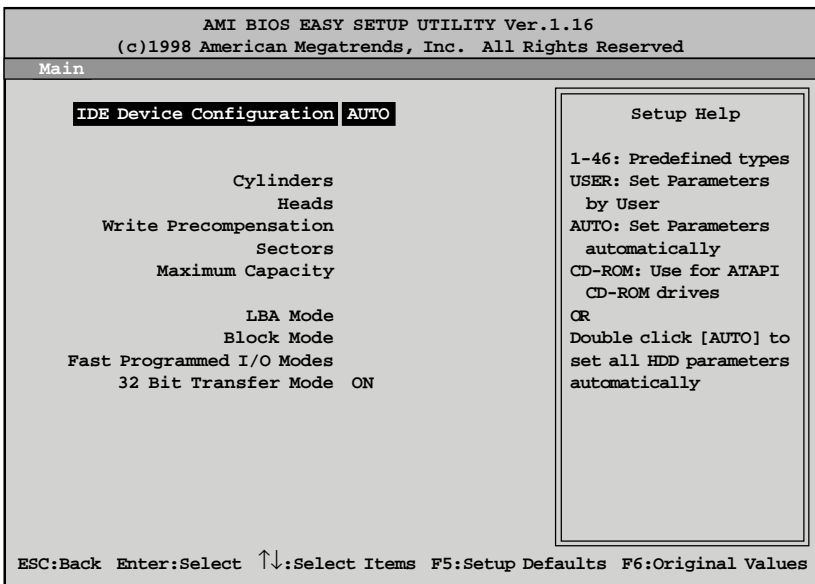

IDE Device Configuration: To have the BIOS autodetect the IDE drive, select Auto. Otherwise, you may choose one of the 46 drive types offered, or enter the parameters yourself (see Entering Drive Parameters on the next page). Consult the table below to see how to configure various drive types yourself.

Type	How to Configure
SCSI	Select <i>Type</i> . Select <i>Not Installed</i> on the drive parameter screen. The SCSI drivers provided by the SCSI manufacturer should allow you to configure the SCSI drive.
IDE	Select <i>Type</i> . Select <i>Auto</i> to let AMIBIOS determine the parameters. Click on <i>OK</i> when AMIBIOS displays the drive parameters. Select <i>LBA Mode</i> . Select <i>On</i> if the drive has a capacity greater than 540MB. Select <i>Block Mode</i> . Select <i>On</i> to allow block mode data transfers. Select <i>32-Bit Mode</i> . Select <i>On</i> to allow 32-bit data transfers. Select the <i>PIO Mode</i> . It is best to select <i>Auto</i> to allow AMIBIOS to determine the PIO mode. If you select a PIO mode that is not supported by the IDE drive, the drive will not work properly. If you are absolutely certain that you know the drive's PIO mode, select PIO mode 0-4, as appropriate.
CD-ROM	Select <i>Type</i> . Select <i>CDROM</i> . Click on <i>OK</i> when AMIBIOS displays the drive parameters.
Standard MFM	(MFM drives are older drives which use an encoding scheme that produces slower data access and less storage room.) Select <i>Type</i> . You must know the drive parameters. Select the drive type that exactly matches your drive's parameters.
Non-Standard MFM	Select <i>Type</i> . If the drive parameters do not match the drive parameters listed for drive types 1-46, select <i>User</i> and enter the correct hard disk drive parameters.

LBA/Large Mode: These modes make it possible for the BIOS to take advantage of the additional space on drives which are larger than 504MB. This can be autodetected (when you select Auto for Type), or you can turn the modes On or Off yourself.

Block Mode: If On, Block Mode automatically detects the optimal number of block read/writes per sector that the drive can support.

Fast Programmed I/O Modes: Programmed Input/Output is a method of transmitting data between devices that uses the system's CPU as part of the data path. There are 6 modes - 5 with their own transmission speed and 1 auto mode. To use modes 3 and 4, you must be using an Enhanced IDE drive.

PIO Mode	Data Transfer Rate (MBps)
Auto	
0	3.3
1	5.2
2	8.3
3	11.1
4	16.6

32bit Transfer Mode: If On, allows for the transmission of 32 bits in parallel (i.e. at the same time). If Off, only 16 bits will be transmitted in parallel.

Entering Drive Parameters

If you select User for the drive Type, you can enter the hard disk drive parameters yourself. The drive parameters are as follows:

Parameter	Description
Type	The number for a drive with certain identification parameters (see the next page for a table of drive types).
Cylinders (Cyl)	The number of cylinders in the disk drive.
Heads (Hd)	The number of heads.
Write Precompensation (WP)	The actual physical size of a sector gets progressively smaller as the track diameter diminishes. Yet, each sector must still hold 512 bytes. Write precompensation circuitry on the hard disk compensates for the physical difference in sector size by boosting the write current for sectors on inner tracks. This parameter is the track number on the disk surface where write precompensation begins.
Sectors (Sec)	The number of sectors per track. MFM drives have 17 sectors per track. RLL drives have 26 sectors per track. ESDI drives have 34 sectors per track. SCSI and IDE drives have even more sectors per track.
Size	The formatted capacity of the drive is the number of heads times the number of cylinders times the number of sectors per track times 512 (bytes per sector).

Auto-Detect Hard Disks

This option lets the system detect your hard disk(s) automatically for your convenience.

Boot Sector Virus Protection

The available settings for this option are 'Enable' and 'Disable'.

Default Settings

Every option in AMIBIOS Setup contains two default values: a Fail-Safe default and the Optimal default value. You can also choose to restore the original BIOS settings (i.e. those that your board came with) at any time. These options can be found in the 'Exit' menu.

Optimal Defaults

The Optimal default values provide optimum performance settings for all devices and system features.

Fail-Safe Defaults

The Fail-Safe default settings consist of the safest set of parameters. Use them if the system is behaving erratically. They should always work but do not provide optimal system performance characteristics.

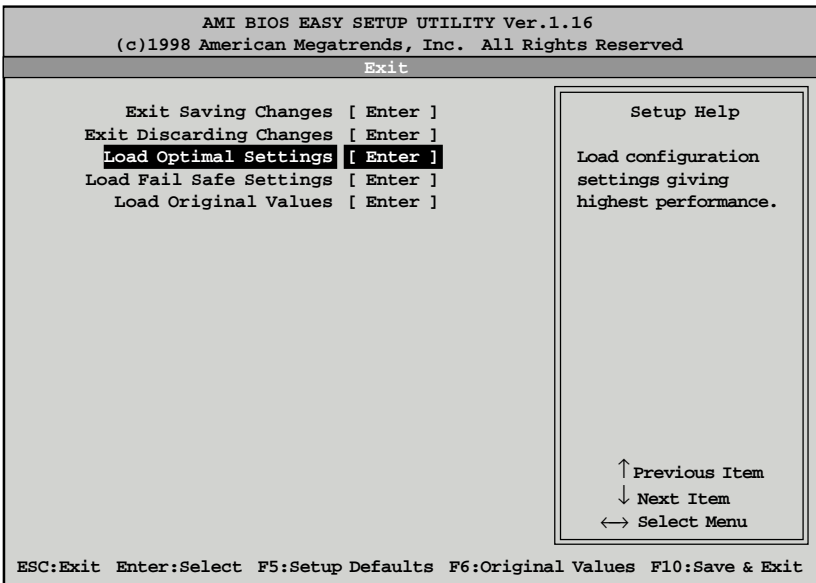

Advanced CMOS Setup

The Advanced Setup options included in the AMIBIOS Setup for the Thunder X are described in this chapter. Select Advanced Setup from the AMIBIOS Setup main menu to display the Advanced Setup options.

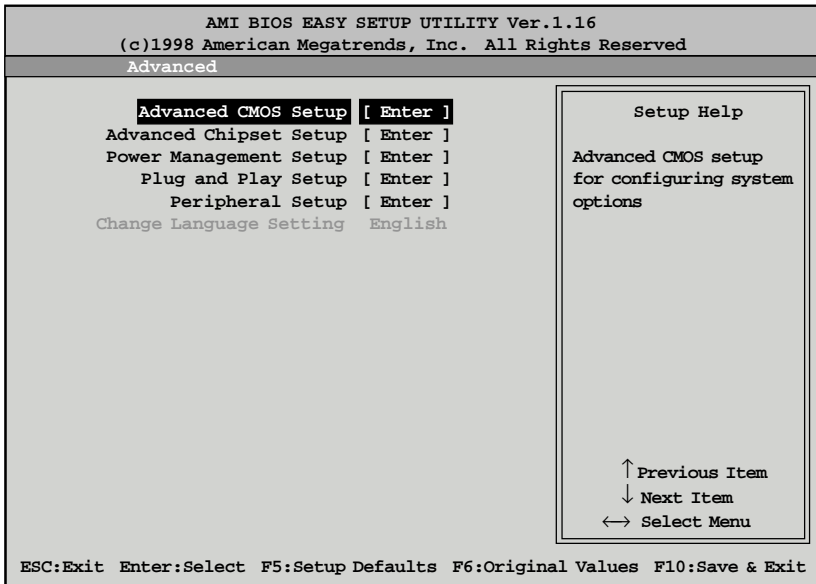

BIOS

Advanced CMOS Setup Default Settings Chart

Setting Option	Optimal Default	Fail-Safe Default
Quick Boot	Disabled	Disabled
Primary Master ARMD Emulated as	Auto	Auto
Primary Slave ARMD Emulated as	Auto	Auto
Secondary Master ARMD Emulated as	Auto	Auto
Secondary Slave ARMD Emulated as	Auto	Auto
1st Boot Device	Floppy	Floppy
2nd Boot Device	1st IDE-HDD	1st IDE-HDD
3rd Boot Device	ATAPI CDROM	ATAPI CDROM
Try Other Boot Devices	Yes	Yes
Floppy Access Control	Read-Write	Read-Write
Hard Disk Access Control	Read-Write	Read-Write

Settings Chart (Continued)

Setting Option	Optimal Default	Fail-Safe Default
S.M.A.R.T. for Hard Disks	Disabled	Disabled
Boot Up Num-Lock	On	On
PS/2 Mouse Support	Enabled	Enabled
Primary Display	VGA/EGA	VGA/EGA
Password Check	Setup	Setup
Boot To OS/2	No	No
Internal Cache	WriteBack	WriteBack
System BIOS Cacheable	Enabled	Disabled
Cache Bus ECC	Enabled	Enabled
Processor Serial Number	N/A	N/A
Default Primary Video	AGP	AGP
MPS Revision	1.1	1.1
C000,16K Shadow	Cached	Cached
C400,16K Shadow	Cached	Cached
C800,16K Shadow	Disabled	Disabled
CC00,16K Shadow	Disabled	Disabled
D000,16K Shadow	Disabled	Disabled
D400,16K Shadow	Disabled	Disabled
D800,16K Shadow	Disabled	Disabled
DC00,16K Shadow	Disabled	Disabled

Advanced Setup

Quick Boot

Set this option to Enabled to instruct AMIBIOS to boot quickly when the computer is powered on. This option replaces the old Above 1 MB Memory Test Advanced Setup option. The settings are:

Setting	Description
Disabled	AMIBIOS tests all system memory. AMIBIOS waits up to 40 seconds for a READY signal from the IDE hard disk drive. AMIBIOS waits for .5 seconds after sending a RESET signal to the IDE drive to allow the IDE drive time to get ready again. AMIBIOS checks for a key press and runs AMIBIOS Setup if the key has been pressed.
Enabled	AMIBIOS does not test system memory above 1MB. AMIBIOS does not wait up to 40 seconds for a READY signal from the IDE hard disk drive. If a READY signal is not received immediately from the IDE drive, AMIBIOS does not configure that drive. AMIBIOS does not wait for .5 seconds after sending a RESET signal to the IDE drive to allow the IDE drive time to get ready again. You cannot run AMIBIOS Setup at system boot, because there is no delay for the Hit to run Setup message.

Pri/Sec Master/Slave ARMD Emulated as

ATAPI Removable Media Disks (e.g. ZIP drives) are hybrid drives. They are removable, and can be used as floppy drives, but also have great capacity and so are sometimes used as hard drives. These four options ensure that, if you have an ARMD attached as a master or slave device, it can be properly detected by the system. The settings are Auto, Floppy, and Hard Disk.

1st Boot Device

This option sets the type of device for the first boot drive that the AMIBIOS attempts to boot from after AMIBIOS POST completes. The settings are Disabled, 1st IDE-HDD, 2nd IDE-HDD, 3rd IDE-HDD, 4th IDE-HDD, Floppy, ARMD-FDD, ARMD-HDD, ATAPI CDROM, SCSI, NETWORK, and I₂O.

2nd Boot Device

This option sets the type of device for the second boot drive that the AMIBIOS attempts to boot from after AMIBIOS POST completes. The settings are Disabled, 1st IDE-HDD, 2nd IDE-HDD, 3rd IDE-HDD, 4th IDE-HDD, Floppy, ARMD-FDD, ARMD-HDD, ATAPI CDROM, and SCSI.

3rd Boot Device

This option sets the type of device for the third boot drive that the AMIBIOS attempts to boot from after AMIBIOS POST completes. The settings are Disabled, 1st IDE-HDD, 2nd IDE-HDD, 3rd IDE-HDD, 4th IDE-HDD, Floppy, ARMD-FDD, ARMD-HDD, ATAPI CDROM.

Try Other Boot Devices

Set this option to Yes to instruct AMIBIOS to attempt to boot from any other drive in the system if it cannot find a boot drive among the drives specified in the 1st Boot Device, 2nd Boot Device, and 3rd Boot Device options. The settings are Yes or No.

Floppy Access Control

This option specifies the read-write access that is set when booting from a floppy drive. The settings are Read-Write or Read-Only.

Hard Disk Access Control

This option specifies the read-write access that is set when booting from a hard disk drive. The settings are Read-Write or Read-Only.

S.M.A.R.T. for Hard Disks

Set this option to Enabled to permit AMIBIOS to use the SMART (System

Management and Reporting Technologies) protocol for reporting server system information over a network. Enabling this feature allows you to back up your data when your hard disk is about to fail. The settings are Enabled or Disabled.

Boot Up Num-Lock

Set this option to Off to turn the Num Lock key off when the computer is booted so you can use the arrow keys on both the numeric keypad and the keyboard. The settings are On or Off.

PS/2 Mouse Support

Set this option to Enabled to enable AMIBIOS support for a PS/2-type mouse. The BIOS will allocate IRQ12 for the PS/2 mouse. The settings are Enabled or Disabled.

Primary Display

This option configures the type of monitor attached to the computer. The settings are Absent, VGA/EGA, CGA40x25, CGA80x25, or Mono.

Password Check

This option enables password checking every time the system boots or when you run AMIBIOS Setup. If Always is chosen, a user password prompt appears every time the computer is turned on. If Setup is chosen, the password prompt appears if AMIBIOS is executed.

Boot To OS/2

Set this option to Yes if you are running an OS/2 operating system and using more than 64 MB of system memory on the motherboard. The settings are Yes or No.

Internal Cache

This option sets the type of caching algorithm used by the L1 internal cache memory on the CPU. The settings are Disabled, WriteThru, or WriteBack.

System BIOS Cacheable

When set to Enabled, the contents of the F0000h system memory segment can be read from or written to cache memory. The contents of this memory segment are copied from the BIOS ROM to system RAM for faster execution. The settings are Enabled or Disabled. The Optimal default setting is Enabled.

Cache Bus ECC

When Enabled, this option permits ECC error checking on the L2 cache bus. This ensures that cached data is not improperly altered. The settings are Enabled or Disabled.

Default Primary Video

This option sets the primary video card as either AGP (Accelerated Graphics Port) card or a regular PCI video card. The settings are AGP or PCI.

MPS Revision

This option sets the Multi-Processor Symmetry. Then settings are 1.1 or 1.4.

C000,16K Shadow and C400,16K Shadow

These options specify how the 32 KB of video ROM at C0000h is treated. The settings are:

Setting	Description
Disabled	The contents of the video ROM are not copied to RAM.
Enabled	The contents of the video ROM area from C000h-C7FFFh are copied (shadowed) from ROM to RAM for faster execution.
Cached	The contents of the video ROM area from C000h-C7FFFh are copied from ROM to RAM and can be written to or read from cache memory.

C800,16K Shadow; CC00,16K Shadow; D000,16K Shadow; D400,16K Shadow; D800, 16K Shadow; and DC00,16K Shadow

These options enable shadowing of the contents of the ROM area named in the option. The ROM area not used by ISA adapter cards is allocated to PCI adapter cards. The settings are:

Setting	Description
Disabled	The contents of the video ROM are not copied to RAM.
Enabled	The contents of the designated ROM area are copied (shadowed) from ROM to RAM for faster execution.
Cached	The contents of the designated ROM area are copied from ROM to RAM and can be written to or read from cache memory.

Chipset Setup

Choose Chipset Setup on the AMIBIOS Setup main menu. All Chipset Setup options are then displayed. AMIBIOS Setup can be customized. AMIBIOS Setup can be customized via AMIBCP. See the AMIBIOS Utilities Guide for additional information.

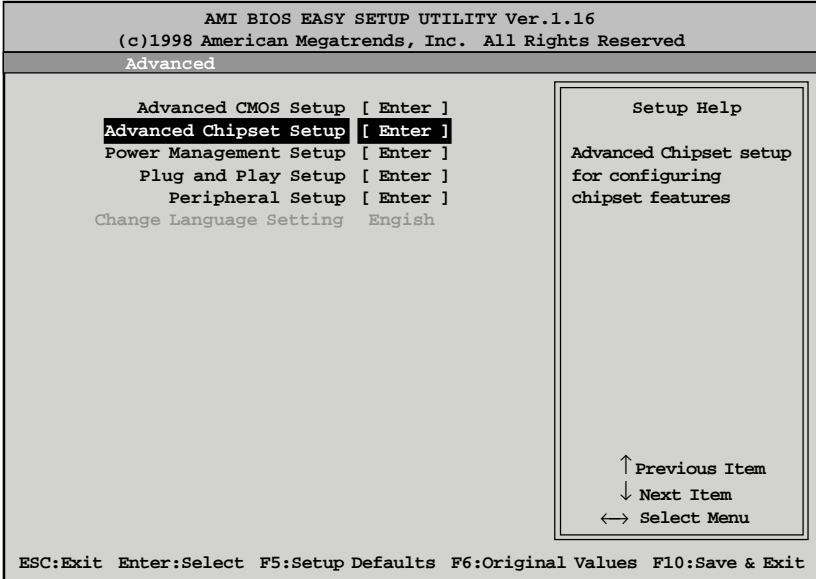

Advanced Chipset Setup Default Settings Chart

Setting Option	Optimal Default	Fail-Safe Default
USB Function	Disabled	Disabled
* USB KB/Mouse Legacy Support	Disabled	Disabled
* Port 64/60 Emulation	Disabled	Disabled
SERR#	Disabled	Disabled
PERR#	Disabled	Disabled
WSC# Handshake	Enabled	Enabled
USWC Write Post	Enabled	Enabled
Master Latency Timer (Ckls)	64	64
Multi-Trans Timer (Ckls)	32	32
PCI1to PCI0 Access	Disabled	Disabled
Method of Memory Detection	Auto & SPD	Auto & SPD
* DRAM Integrity Mode	ECC Hardware	ECC Hardware

Settings Chart (continued)

Setting Option	Optimal Default	Fail-Safe Default
DRAM Refresh Rate	15.6 us	15.6 us
Memory Hole	Disabled	Disabled
SDRAM RAS# to CAS# Delay	3SCLKs	3SCLKs
SDRAM RAS# Precharge	3SCLKs	3SCLKs
Power Down SDRAM	Disabled	Disabled
ACPI Control Register	Disabled	Disabled
Gated Clock	Disabled	Disabled
Graphics Aperture Size	64 M B	64 M B
Search for MDA Resources	Yes	Yes
AGP Multi-Trans Timer (AGP Clks)	32	Disabled
AGP Low-Priority Timer (Clks)	16	Disabled
AGP SERR	Disabled	Disabled
AGP Parity Error Response	Disabled	Disabled
8bit I/O Recovery Time	Disabled	Disabled
16bit I/O Recovery Time	Disabled	Disabled
P1X4 SERR#	Disabled	Disabled
USB Passive Release	Enabled	Enabled
P1X4 Passive Release	Enabled	Enabled
P1X4 Delayed Transaction	Disabled	Disabled
Type FDM A Buffer Control1	Disabled	Disabled
Type FDM A Buffer Control2	Disabled	Disabled
DM A -0 Type	Normal ISA	Normal ISA
DM A -1 Type	Normal ISA	Normal ISA
DM A -2 Type	Normal ISA	Normal ISA
DM A -3 Type	Normal ISA	Normal ISA
DM A -5 Type	Normal ISA	Normal ISA
DM A -6 Type	Normal ISA	Normal ISA
DM A -7 Type	Normal ISA	Normal ISA
CPU Bus Frequency	Auto	Auto

* Setting option not selectable.

USB Function

Set this option to Enabled to enable USB (Universal Serial Bus) support. The settings are Enabled or Disabled.

USB KB/Mouse Legacy Support

Set this option to Enabled to enable support for older keyboards and mouse devices if the USB Function option is set to Enabled. The settings are Enabled or Disabled.

Port 64/60 Emulation

Setting this option to Enabled allows a USB keyboard to act like a legacy keyboard. If this option is not Enabled, USB keyboard lights will not work under Windows NT. With other operating systems, a USB keyboard will work normally with this option Disabled. The settings are Enabled or Disabled.

SERR#

Set this option to Enabled to enable the SERR# signal on the bus. The settings are Enabled or Disabled.

PERR#

Set this option to Enabled to enable the PERR# signal on the bus. The settings are Enabled or Disabled. The Optimal and Fail-safe default settings are Disabled.

WSC# Handshake

Set this option to Enabled to enable handshaking for the WSC# signal. Handshaking is a form of encryption; see the Glossary for more information. The settings are Enabled or Disabled.

USWC Write Post

This option sets the status of USWC posted writes to I/O. USWC is a type of memory that is used by VGA devices. The settings are:

Setting	Description
Enabled	USWC posted writes to I/O are enabled.
Disabled	USWC posted writes to I/O are disabled.

BX Master Latency Timer (Clks)

This option specifies the master latency timer (in PCI clocks) for devices in the computer. The settings are Disabled, 32, 64, 96, 128, 160, 192, or 224.

Multi-Trans Timer (Clks)

This option specifies the multi-trans latency timings (in PCI clocks) for devices in the computer. The settings are Disabled, 32, 64, 96, 128, 160, 192, or 224.

PCI1 to PCI0 Access

Set this option to Enabled to enable access between two different PCI buses (PCI1 and PCI0). The settings are Enabled or Disabled.

Method of Memory Detection

This option determines how your system will detect the type of system memory you have installed. Options are Auto+SPD or Auto only.

DRAM Integrity Mode

This option sets the type of system memory checking. The settings are:

Setting	Description
Non ECC	No error checking or error reporting is done.
EC	Errors are detected, but no corrections will be made.
ECC Hardware	Errors are detected, and single bit errors are corrected.

DRAM Refresh Rate

This option specifies the interval between refresh signals to DRAM system memory. The settings are 15.6 us (microseconds), 31.2 us, 62.4 us, 124.8 us, or 249.6 us.

Memory Hole

This option specifies the location of an area of memory that cannot be addressed on the ISA bus. The settings are Disabled, 512KB-640KB, or 15MB-16MB.

SDRAM RAS# to CAS# Delay

This option specifies the length of the a inserted between the RAS and CAS signals of the DRAM system memory access cycle if SDRAM is installed. The settings are Auto, 2 SCLKs or 3 SCLKs. The Optimal default setting is Auto.

SDRAM RAS# Precharge

(CHANGE) This option specifies the length of the RAS precharge part of the DRAM system memory access cycle when SDRAM system memory is installed in this computer. The settings are Auto, 2 SCLKs, or 3 SCLKs.

Power Down SDRAM

If this option is set to Enabled, the SDRAM Power Down feature is enabled. The settings are Enabled or Disabled.

ACPI Control Register

Set this option to Enabled to enable the ACPI (Advanced Configuration and Power Interface) control register. The settings are Enabled or Disabled. The Optimal and Fail-safe default settings are Enabled.

Gated Clock

Set this option to Enabled to enable the gated clock. The settings are Enabled or Disabled.

Graphics Aperture Size

This option specifies the amount of system memory that can be used by the Accelerated Graphics Port (AGP). The settings are 4 MB, 8 MB, 16 MB, 32 MB, 64 MB, 128 MB, or 256 MB.

Search for MDA Resources

Set this option to Yes to let AMIBIOS search for MDA resources. The settings are Yes or No.

AGP Multi-Trans Timer (AGP Clks)

This option sets the AGP multi-trans timer. The settings are in units of AGP Clocks. The settings are Disabled, 32, 64, 96, 128, 160, 192, or 224.

AGP Low-Priority Timer (Clks)

This option sets the AGP low priority timer. The settings are in units of AGP Clocks. The settings are Disabled, 16, 32, 48, 64, 80, 96, 112, 128, 144, 176, 192, 208, 224, or 240.

AGPSERR

Set this option to Enabled to enable the AGP SERR signal. The settings are Enabled or Disabled.

AGP Parity Error Response

Set this option to Enabled to enable AGP parity error response. The settings are Enabled or Disabled.

8bit I/O Recovery Time

This option specifies the length of a delay inserted between consecutive 8-bit I/O operations. The settings are Disabled and from 1 to 8 Sysclk (system clocks) in increments of one.

16bit I/O Recovery Time

This option specifies the length of a delay inserted between consecutive 16-bit I/O operations. The settings are Disabled and from 1 to 4 Sysclk (system clocks) in increments of one.

PIIX4SERR#

Set this option to Enabled to enable the SERR# signal for the Intel PIIX4 chip. The settings are Enabled or Disabled.

USB Passive Release

Set this option to Enabled to enable passive release for USB. The settings are Enabled or Disabled.

PIIX4 Passive Release

Set this option to Enabled to enable passive release for the Intel PIIX4e chip. This option must be Enabled to provide PCI 2.1 compliance. The settings are Enabled or Disabled.

PIIX4 DELAYED TRANSACTION

Set this option to Enabled to enable delayed transactions for the Intel PIIX4 chip. This option must be Enabled to provide PCI 2.1 compliance. The settings are Enabled or Disabled.

TypeF DMA Buffer Control1 and 2

These options specify the DMA channel where TypeF buffer control is implemented. The settings are Disabled, Channel-0, Channel-1, Channel-2, Channel-3, Channel-5, Channel-6, or Channel-7.

DMA-*n* Type

These options specify the bus that the specified DMA channel can be used on. The settings are Normal ISA, PC/PCI, or Distributed.

CPU Bus Frequency

This option provides selective CPU Bus Frequency; however, it is strongly recommended that the default setting (Auto) be selected. Unpredictable situations may arise if the Intel default CPU bus speed is not used. The settings are Auto, 66.8MHz, 68.5MHz, 75MHz, 83.3MHz, 100MHz, 103MHz, or 112MHz.

Power Management Setup

The AMIBIOS Setup options described in this section are selected by choosing Power Management Setup from the AMIBIOS Setup main menu.

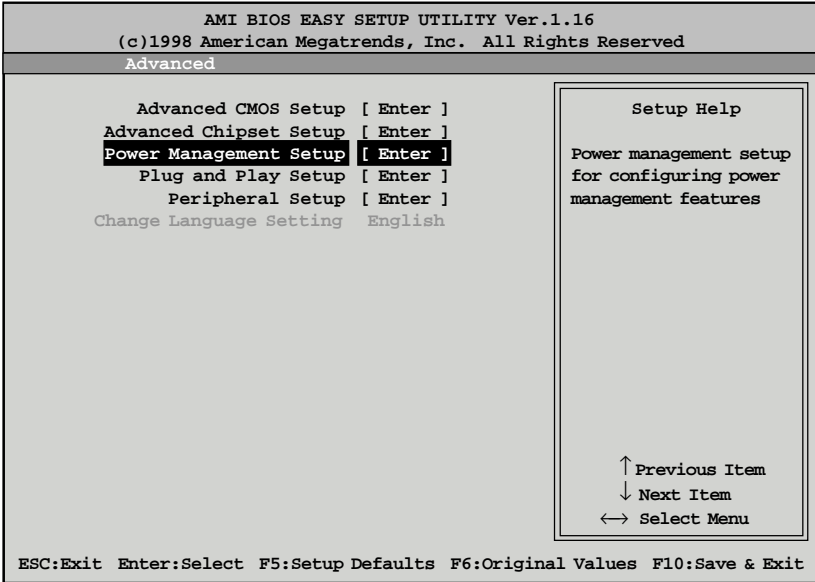

Power Management Setup Default Settings Chart

Setting Option	Optimal Default	Fail-Safe Default
ACPI Aware O/S	No	No
Power Management / APM	Enabled	Enabled
Power Button Function	On/Off	On/Off
Green PC Monitor Power State	Suspend	Stand By
Video Power Down Mode	Suspend	Disabled
Hard Disk Power Down Mode	Suspend	Disabled
Hard Disk Time Out (Minute)	Disabled	Disabled
Power Saving Type	Sleep	Sleep
Standby / Suspend Timer Unit	4 min	4 min
Standby Time Out	Disabled	Disabled
Suspend Time Out	Disabled	Disabled
Slow Clock Ratio	50% - 62.5%	50% - 62.5%
Display Activity	Ignore	Ignore

Setting Option	Optimal Default	Fail-Safe Default
Device 6 (Serial port 1)	Monitor	Monitor
Device 7 (Serial port 2)	Monitor	Monitor
Device 8 (Parallel port)	Monitor	Monitor
Device 5 (Floppy disk)	Monitor	Monitor
Device 0 (Primary master IDE)	Monitor	Monitor
Device 1 (Primary slave IDE)	Monitor	Monitor
Device 2 (Secondary master IDE)	Monitor	Monitor
Device 3 (Secondary slave IDE)	Monitor	Monitor
LAN Wake-up For Addon LAN	Disabled	Disabled
LAN Wake-up For Onboard LAN	Disabled	Disabled
PC 98 Power LED	Disabled	Disabled
Fan OFF at Suspend	Enabled	Enabled
RTC Wake-up	Disabled	Disabled
*Hour	N/A	N/A
*Minute	N/A	N/A

* Setting option not selectable.

ACPI Aware O/S

Set this option to Yes to enable Advanced Configuration and Power Interface (ACPI) BIOS for an ACPI-aware operating system.

Power Management/APM

Set this option to Enabled to enable the chipset power management and APM (Advanced Power Management) features. The settings are Enabled or Disabled.

Power Button Function

This option specifies how the power button mounted externally on the computer chassis is used. See Soft Power Connector on page 20 for more information. The settings are shown in the table below.

Setting	Description
On/Off	Pushing the power button turns the computer on or off.
Suspend	Pushing the power button places the computer in Suspend mode or Full On power mode.

Green PC Monitor Power State

This option specifies the power state that the green PC-compliant video

monitor enters when AMIBIOS places it in a power saving state after the specified period of display inactivity has expired. The settings are Off, Stand By, or Suspend.

Video Power Down Mode

This option specifies the power state that the video subsystem enters when AMIBIOS places it in a power saving state after the specified period of display inactivity has expired. The settings are Stand By, Suspend, or Disabled.

Hard Disk Power Down Mode

This option specifies the power conserving state that the hard disk drive enters after the specified period of hard drive inactivity has expired. The settings are Disabled, Stand By, or Suspend.

Hard Disk Time Out (Minute)

This option specifies the length of a period of hard disk drive inactivity. When this length of time expires, the computer enters power-conserving state specified in the Hard Disk Power Down Mode option (see the previous page). The settings are Disabled, and from 1 to 15 minutes, in one minute intervals.

Power Saving Type

There are several types of sleeping states within the general sleep state. This option allows you to choose how “asleep” you want your system to be. In deeper sleep modes, more energy is saved. However, upon waking up, the system must “reorient” itself, and reestablish control over the system’s sleeping components. The settings are POS, Sleep, Stop Clock, and Deep Sleep. POS is the lightest sleep mode; Deep Sleep is the heaviest.

Standby/Suspend Timer Unit

This option specifies the unit of time used for the Standby and Suspend time out periods. The settings are 4 msec, 4 sec, 32 sec, or 4 min.

Standby Time Out

This option defines the length of time that the system, while in Full On state, must be inactive before it enters Standby mode. The settings are Disabled and from 4 minutes to 508 minutes, in increments of 4 minutes.

Suspend Time Out

This option defines the length of time that the system, while in Standby mode, must be inactive before it enters Suspend mode. The settings are Disabled and from 4 minutes to 508 minutes, in increments of 4 minutes.

Slow Clock Ratio

This option specifies the speed at which the system clock runs in the Standby Mode power saving state. The settings are expressed as a percentage of the normal CPU clock speed. The settings are 0-12.5%, 12.5%-25%, 25%-37.5%, 37.5%-50%, 50%-62.5%, 62.5%-75%, or 75-87.5%.

Display Activity

When set to Monitor, this option enables event monitoring on the video display. If set to Monitor and the computer is in a power saving state, display activity will cause the system to enter the Full On state. AMIBIOS reloads the Standby and Suspend time-out timers if display activity occurs. The settings are Monitor or Ignore.

Device *n* (Device identity)

When set to Monitor, these options enable event monitoring on the specified hardware interrupt request line. If set to Monitor and the computer is in a power saving state, any activity on the IRQ line will cause the system to enter the Full On state. AMIBIOS reloads the Standby and Suspend time-out timers if activity occurs on the specified IRQ line. The settings for each of these options are Monitor or Ignore.

LAN Wake-up

When this option is Enabled, the system will wake up when a signal is received on the Wake-on LAN header. In order for this wake up function to work, the system must have been brought up at least past the POST before it was last shut down (i.e. if you turn the system off before the POST, the registry will not be set, and the system will not be able to wake up using this function). This function requires an ATX 2.01 compliant power supply with 5V standby (STB5V) current of at least 800mA. The settings are Enabled or Disabled.

PC98 Power LED

When this option is Enabled, your power LED will turn to yellow when your system is in Suspend mode. Note that if you do not have a two-color LED, your LED will turn off when the system is in Suspend mode if this option is set to Enabled. The settings are Enabled or Disabled.

FAN OFF at Suspend

If this option is Enabled, the CPU fan will turn off when the system is in Suspend mode. If Disabled, the CPU fan will remain on while the system is in Suspend mode. The settings are Enabled or Disabled.

RTC Wake-up

If Enabled, this option allows you to set an hour and minute for the system to wake up. The next two fields allow you to choose the wake up time. Note that the time fields will not be available if this option is set to Disabled. In order for this wake up function to work, the system must have been brought up at least past the POST before it was last shut down (i.e. if you turn the system off before the POST, the registry will not be set, and the system will not be able to wake up using this function). The settings are Enabled or Disabled.

Plug and Play Setup

Choose PCI/Plug and Play Setup from the AMIBIOS Setup screen to display the PCI and Plug and Play Setup options, described below.

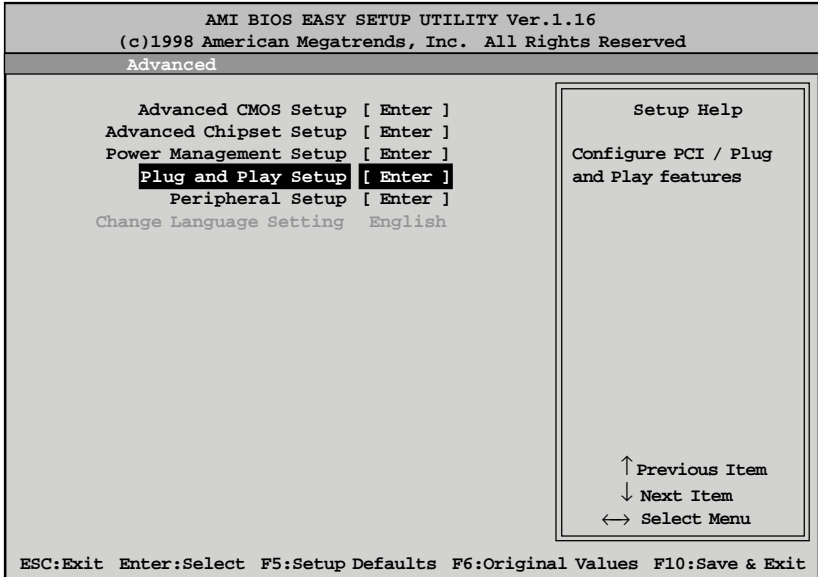

Plug and Play Setup Default Settings Chart

Setting Option	Optimal Default	Fail-Safe Default
Plug and Play Aware O/S	Yes	Yes
PCI Latency Timer (PCI Clocks)	64	64
PCI VGA Palette Snoop	Disabled	Disabled
Allocate IRQ to PCI VGA	Yes	Yes
PCI IDE Bus Master	Disabled	Disabled
Off Board PCI IDE Card	Auto	Auto
*Off Board PCI IDE Primary IRQ	Disabled	Disabled
*Off Board PCI IDE Secondary IRQ	Disabled	Disabled
PCI Slot 1 IRQ Priority	Auto	Auto
PCI Slot 2 IRQ Priority	Auto	Auto
PCI Slot 3 IRQ Priority	Auto	Auto
PCI Slot 4 IRQ Priority	Auto	Auto
DMA Channel 0	PnP	PnP
DMA Channel 1	PnP	PnP
DMA Channel 3	PnP	PnP
DMA Channel 5	PnP	PnP
DMA Channel 6	PnP	PnP
DMA Channel 7	PnP	PnP
IRQ 3	PCI/PnP	PCI/PnP
IRQ 4	PCI/PnP	PCI/PnP
IRQ 5	PCI/PnP	PCI/PnP
IRQ 7	PCI/PnP	PCI/PnP
IRQ 9	PCI/PnP	PCI/PnP
IRQ 10	PCI/PnP	PCI/PnP
IRQ 11	PCI/PnP	PCI/PnP
IRQ 12	PCI/PnP	PCI/PnP
IRQ 14	PCI/PnP	PCI/PnP
IRQ 15	PCI/PnP	PCI/PnP
Reserved Memory Size	Disabled	Disabled
*Reserved Memory Address	C8000	C8000
PCI Device Search Order	First-Last	First-Last
BIOS Devnode for Shadow RAM	Disabled	Disabled

* Setting option is not selectable

Plug and Play Aware O/S

Set this option to Yes to inform AMIBIOS that the operating system can handle plug and Play (PnP) devices. The settings are No or Yes.

PCI Latency Timer (PCI Clocks)

This option specifies the latency timings (in PCI clocks) for PCI devices installed in the PCI expansion slots. The settings are 32, 64, 96, 128, 160, 192, 224, or 248.

PCI VGA Palette Snoop

When this option is set to Enabled, multiple VGA devices operating on different buses can handle data from the CPU on each set of palette registers on every video device. Bit 5 of the command register in the PCI device configuration space is the VGA Palette Snoop bit (0 is disabled). For example, if there are two VGA devices in the computer (one PCI and one ISA) and this field is set for:

Setting	Description
Disabled	Data read and written by the CPU is only directed to the PCI VGA device's palette registers.
Enabled	Data read and written by the CPU is directed to the both the PCI VGA device's palette registers and the ISA VGA device palette registers, permitting the palette registers of both devices to be identical.

This option must be set to Enabled if any ISA adapter card installed in the system requires VGA palette snooping.

Allocate IRQ to PCI VGA

Set this option to Yes to allocate an IRQ to the VGA device on the PCI bus. The settings are Yes or No.

PCI IDE BusMaster

Set this option to Enabled to specify that the IDE controller on the PCI bus has bus mastering capability. The settings are Disabled or Enabled.

OffBoard PCI IDE Card

This option specifies whether or not an offboard PCI IDE controller adapter card is used in the computer, and where it is installed. If an offboard PCI IDE controller is used, the motherboard onboard IDE controller is automatically disabled. The settings are Auto and Slot1 through Slot6. If Auto is selected, AMIBIOS automatically determines the correct setting (including using the onboard controller if no offboard controller card is detected). This option forces IRQ 14 and 15 to a PCI slot on the PCI local bus. This is necessary to

support non-compliant PCI IDE adapter cards.

OffBoard PCI IDE Primary IRQ

This option specifies the PCI interrupt used by the primary IDE channel on the offboard PCI IDE controller. The settings are Disabled, Hardwired, INTA, INTB, INTC, or INTD.

Offboard PCI IDE Secondary IRQ

This option specifies the PCI interrupt used by the secondary IDE channel on the offboard PCI IDE controller. The settings are Disabled, Hardwired, INTA, INTB, INTC, or INTD.

PCI Slot *n* IRQ Priority

These options specify the IRQ priority for PCI devices installed in the PCI devices installed in the PCI expansion slots. The settings are Auto, IRQ 3, 4, 5, 7, 9, 10, and 11, in priority order.

DMA Channel *n*

These options allow you to specify the bus type used by each DMA channel. The settings are PnP or ISA/EISA .

IRQ*n*

These options specify the bus that the specified IRQ line is used on. These options allow you to reserve IRQs for legacy ISA adapter cards. These options determine if AMIBIOS should remove an IRQ from the pool of available IRQs passed to devices that are configurable by the system BIOS. The available IRQ pool is determined by reading the ESCD NVRAM. If more IRQs must be removed from the pool, you can use these options to reserve the IRQ by assigning an ISA/EISA setting to it. Onboard I/O is configured by AMIBIOS. All IRQs used by onboard I/O are configured as PCI/PnP. IRQ12 only appears if the Mouse Support option in Advanced Setup is set to Disabled. IRQ14 and 15 will not be available if the onboard PCI IDE is enabled. If all IRQs are set to ISA/EISA and IRQ14 and 15 are allocated to the onboard PCI IDE, IRQ9 will still be available for PCI and PnP devices, because at least one IRQ must be available for PCI and PnP devices. The settings are ISA/EISA or PCI/PnP.

Reserved Memory Size

This option specifies the size of the memory area reserved for legacy ISA adapter cards. The settings are Disabled, 16K, 32K, or 64K.

Reserved Memory Address

This option specifies the beginning address (in hex) of the reserved memory area. The specified ROM memory area is reserved for use by legacy ISA adapter cards. This option does not appear if the Reserved Memory Size option is set to Disabled. The settings are C0000, C4000, C8000, CC000, D0000, D4000, D8000, or DC000.

PCI Device Search Order

This option changes the BIOS scan order of the PCI slot - from first to last or last to first. The settings are First-Last or Last-First.

BIOS Devnode for Shadow RAM

This option is used for some add-on card ROMs which do not claim the correct memory range that they occupy. The settings are Disabled or Enabled.

Peripheral Setup

Peripheral Setup options are displayed by choosing Peripheral Setup from the AMIBIOS Setup main menu. All Peripheral Setup options are described here.

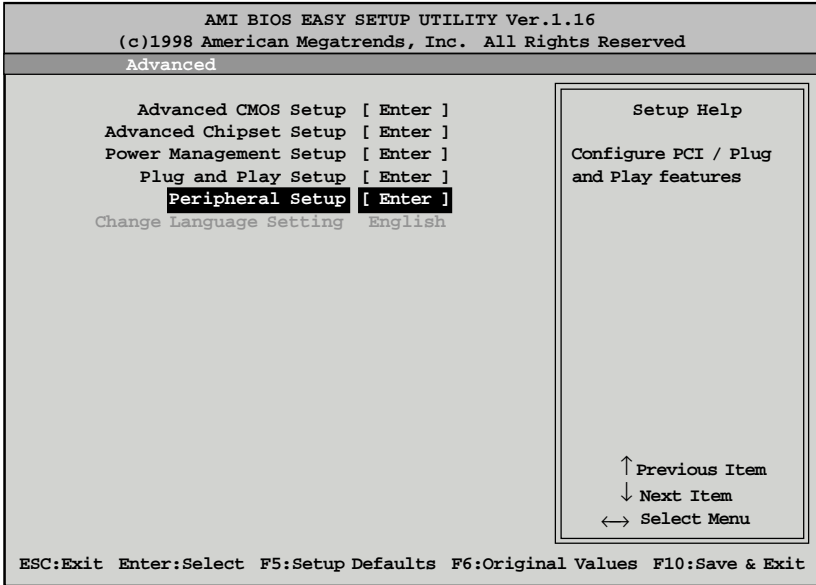

BIOS

Peripheral Setup Default Settings Chart

Setting Option	Optimal Default	Fail-Safe Default
OnBoard SCSI	Enabled	Enabled
Power Interruption	Disabled	Disabled
Overclock Warning Message	Enabled	Enabled
Keyboard Wake-up Function	Disabled	Disabled
CPU1 Current Temperature	N/A	N/A
CPU2 Current Temperature	N/A	N/A
LM 79 IN 0	2.01	2.01
LM 79 IN 1	2.00	2.00
LM 79 IN 2	3.34	3.34
LM 79 IN 3	+5.02	+5.02
LM 79 IN 4	+11.91	+11.91
LM 79 IN 5	-11.98	-11.98
LM 79 IN 6	-5.18	-5.18
LM 79 Fan1	N/A	N/A

Settings Chart (Continued)

Setting Option	Optimal Default	Fail-Safe Default
LM 79 Fan2	3515	3515
Onboard FDC	Auto	Auto
Onboard Serial Port 1	3F8h	3F8h
Onboard Serial Port 2	2F8h	2F8h
Serial Port 2 Mode	Normal	Normal
*IR Duplex Mode	N/A	N/A
*IR Receiver Pin	IRRX1	IRRX1
Onboard Parallel Port	378	378
Parallel Port Mode	Normal	Normal
*EPP Version	N/A	N/A
*IR Duplex Mode	N/A	N/A
*IR Receiver Pin	IRRX1	IRRX1
Onboard Parallel Port	378	378
Parallel Port IRQ	7	7
*Parallel Port DMA Channel	N/A	N/A
Onboard IDE	Both	Both

* Setting Option not selectable

Onboard SCSI

Select 'Enabled' to use onboard SCSI. The settings are Enabled or Disabled.

Power Interruption

The settings are Enabled or Disabled.

Overclock Warning Message

When enabled, this option sends a warning message if the CPU is overclocked. The settings are Enabled or Disabled.

Keyboard Wake-up Function

This option allows for system power-on via the keyboard. The settings are Enabled or Disabled.

Onboard FDC

Set this option to Enabled to enable the floppy drive controller on the motherboard. The settings are Auto, Enabled, or Disabled.

Onboard Serial Port1

This option specifies the base I/O port address of serial port 1. The settings are Auto, Disabled, 3F8h, 2F8h, 3E8h, or 2E8h.

Onboard Serial Port2

This option specifies the base I/O port address of serial port 2. The settings are Auto, Disabled, 3F8h, 2F8h, 3E8h, or 2E8h.

Serial Port2 Mode

This option specifies the operating mode for serial port 2. This option will not appear if the Onboard Serial Port2 option is set to Disabled, or is set to Auto and your system does not have an onboard serial port 2. The settings are Normal, Sharp-IR, IrDA, and Consumer.

IR Transmission Mode

This option specifies the infrared transmission method. This option will not appear if the Serial Port2 Mode option is set to Normal. The settings are Full or Half.

Mode	Description
Full Duplex	Data is transmitted in two directions at once. Any data you send will not appear on your screen until it has been received by the other device and sent back to you. Full duplex is the faster of the two modes.
Half Duplex	Data is transmitted in only one direction at a time. Any data you send will be instantly displayed on your screen. Half duplex mode is easier for the devices to execute. Not all IR-capable devices can handle full duplex mode.

IR Receiver Pin

This option specifies which pin will act as the receiver for IR data transmission. This option will not appear if the Serial Port2 Mode option is set to Normal. The only setting is IRRX1.

OnBoard Parallel Port

This option specifies the base I/O port address of the parallel port on the motherboard. The settings are Auto, Disabled, 378, or 278.

Parallel Port Mode

This option specifies the parallel port mode. The settings are:

Setting	Description
Normal	The normal parallel port mode is used.
Bi-Dir	Use this setting to support bidirectional transfers on the parallel port.
EPP	The parallel port can be used with devices that adhere to the Enhanced Parallel Port (EPP) specifications. EPP uses the existing parallel port signals to provide asymmetric bidirectional data transfer driven by the host device.
ECP	The parallel port can be used with devices that adhere to the Extended Capabilities Port (ECP) specifications. ECP uses the DMA protocol to achieve data transfer rates of up to 2.5 Megabits per second. ECP provides symmetric bidirectional communication.

EPP Version

This option specifies the Enhanced Parallel Port specification version number that is used in the system. This option only appears if the Parallel Port Mode option is set to EPP. The settings are 1.7 or 1.9. Version 1.9 is common on newer devices; consult your device's user information for the appropriate port type. There are no default settings.

Parallel Port IRQ

This option specifies the IRQ used by the parallel port, and only appears if OnBoard Parallel Port is set to 278 or 378. The settings are 5 or 7.

Parallel Port DMA Channel

This option is only available if the setting for the Parallel Port Mode option is set to ECP and the OnBoard Parallel Port option is set to 378, 278, or 3BC. This option sets the DMA channel used by the parallel port. The settings are 0 through 7 in increments of one.

Onboard IDE

This option specifies the IDE channel used by the onboard IDE controller. The settings are Disabled, Primary, Secondary, or Both.

Supervisor and User Security

You can limit access to the Setup Program or to the system using the Supervisor and User password options (the Supervisor password gives you access to the Setup Program and the system; the User password, only to the system). Note that you must create a supervisor password before you create a user password.

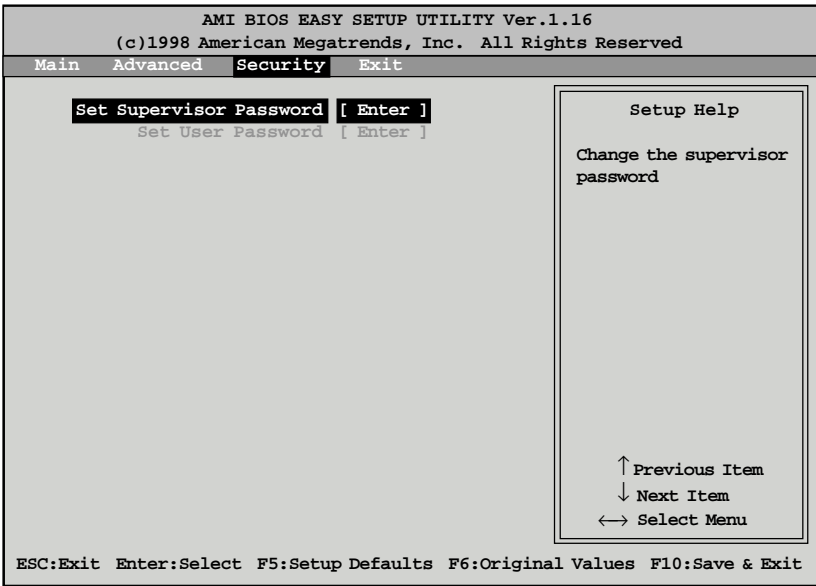

BIOS

When you select the Supervisor Security option, a dialog box will appear, allowing you to enter a password. You may either type the password in, or click on the onscreen buttons. Your password must be between one and six characters long.

Once you have entered your new password, you will be asked to confirm it. If the two passwords do not match, you will be prompted to enter a new password, and then to confirm it. This will continue until you enter the same series of characters both times. Once this is accomplished, a dialog box will appear and notify you that the Supervisor Password has been installed. You may then select the User Security option and enter a password for the user.

You can enter a new User password at any time simply by selecting the User Security option, and typing in a new password. To enter a new Supervisor

password, select the Supervisor Security option. You will be asked to enter the current password. After you do so, you will be prompted to enter the new password.

In either the Supervisor or User Security options, pressing <Enter> once when asked for a new password, and a second time when asked to confirm the new password, will uninstall the existing password. Note that uninstalling the Supervisor password uninstalls the User password as well.

Language Utility

Currently, the BIOS Setup program is available only in English.

Flash Writer Utility

The AMI Flash Writer Utility is now included in the AMIBIOS, and so it is simpler to upgrade the BIOS of your mainboard. The system BIOS is stored on a flash EEPROM ROM chip on the mainboard which can be erased and reprogrammed by following the directions on the following page.

1. From the DOS prompt, rename the BIOS file that you have downloaded to “amiboot.rom” and copy it on to a floppy disk.
2. Insert the floppy disk with the BIOS upgrade into the A: drive.
3. Turn the power off.
4. While holding the <Ctrl> and <Home> keys, turn the power on. The system will begin to read from the A: drive, and write the BIOS information contained on the floppy disk in that drive to the EEPROM ROM chip. When the BIOS has been totally reprogrammed, the system will reboot with the new BIOS in operation.
5. If the system does not reboot in three minutes, power down the system wait a few seconds, and then turn the power back on again. You will be prompted to press <F1> to run Setup. You may check your settings at this time, or simply save and exit the program.

chapter 4

System Resources

Beep Codes

Fatal errors, which halt the boot process, are communicated through a series of audible beeps. If AMIBIOS POST can initialize the system video display, it displays the error message. Displayed error messages, in most cases, allow the system to continue to boot. Displayed error messages are described on pages 89-90. See the top of the next page for the beep code chart.

Beeps	Error Message	Description
1	Refresh Failure	The memory refresh circuitry is faulty.
2	Parity Error	Parity error in the base memory (the first 64 KB block) of memory.
3	Base 64 KB Memory Failure	Memory failure in first 64 KB.
4	Timer Not Operational	A memory failure in the first 64 KB of memory, or Timer 1 is not functioning.
5	Processor Error	The CPU generated an error.
6	8042 - Gate A20 Failure	Cannot switch to protected mode.
7	Processor Exception Interrupt Error	The CPU on the CPU Card generated an exception interrupt.
8	Display Memory Read/Write Error	The system video adapter is either missing or its memory is faulty. This is not a fatal error.
9	ROM Checksum Error	The ROM checksum value does not match the value encoded in AMBIOS.
10	CMOS Shutdown Register Read/Write Error	The shutdown register for CMOS RAM has failed.
11	Cache Memory Bad — Do Not Enable Cache	The cache memory test failed. Cache memory is disabled. Do not press <Ctrl> <Alt> <Shift> <+> to enable cache memory.

Troubleshooting System Problems

If the computer beeps...

1, 2, or 3 times...

then...

reseat the memory SIMMs or DIMMs. If the system still beeps, replace the memory.

6 times...

reseat the keyboard controller chip. If it still beeps, replace the keyboard controller. If it still beeps, try a different keyboard, or replace the keyboard fuse, if there is one.

8 times...

there is a memory error on the video adapter. Replace the video adapter, or the RAM on the video adapter.

9 times...

the BIOS ROM chip is bad. The system probably needs a new BIOS ROM chip.

11 times...

reseat the cache memory on the motherboard. If it still beeps, replace the cache memory.

4, 5, 7, or 10 times...

the motherboard must be replaced.

Displayed Error Messages

If an error occurs after the system display has been initialized, the error message will be displayed as follows:

```

ERROR Message Line 1
ERROR Message Line 2
Press <F1> to continue
    
```

and the system will halt. The system will not halt if the Wait for <F1> If Any Error option in Advanced Setup is Disabled.

RUN SETUP UTILITY

may also appear. Press <F1> to run WINBIOS Setup if this message appears.

Error Message	Explanation
8042 Gate-A20 Error	Gate A20 on the keyboard controller (8042) is not working. Replace the 8042.
Address Line Short!	Error in the address decoding circuitry.
C: Drive Error	No response from drive C:. Run the AMIDiag Hard Disk Utility. Check the C: hard disk type in Standard Setup.
C: Drive Failure	No response from hard disk drive C:. Replace the drive.
Cache Memory Bad, Do Not Enable Cache!	Cache memory is defective. Run AMIDiag.
CH-2 Timer Error	An AT system has two timers. There is an error in timer 2.
CMOS Battery State Low	CMOS RAM is powered by a battery. The battery power is low. Replace the battery.
CMOS Checksum Failure	CMOS RAM checksum is different than the previous value. Run WINBIOS Setup.
CMOS System Options Not Set	The values stored in CMOS RAM have been destroyed. Run WINBIOS Setup.
CMOS Display Type Mismatch	The video type in CMOS RAM does not match the type detected. Run WINBIOS Setup.
CMOS Memory Size Mismatch	The amount of memory found by AMIBIOS is different than the amount in CMOS RAM. Run WINBIOS Setup.
CMOS Time and Date Not Set	Run Standard Setup to set the date and time.
D: Drive Error	No response from drive D:. Run the AMIDiag Hard Disk Utility. Check the hard disk type in Standard Setup.

Error Message	Explanation
D: drive failure	No response from hard disk drive D:. Replace the drive.
Diskette Boot Failure	The boot diskette in drive A: cannot be used to boot the system. Use another boot diskette and follow the screen instructions.
Display Switch Not Proper	Some systems require a video switch be set to either color or monochrome. Turn the system off, set the switch properly, then power on.
DMA Error	Error in the DMA controller.
DMA 1 Error	Error in the first DMA channel.
DMA 2 Error	Error in the second DMA channel.
FDD Controller Failure	AMIBIOS cannot communicate with the floppy disk drive controller. Check all appropriate connections after the system is powered down.
HDD Controller Failure	AMIBIOS cannot communicate with the hard disk drive controller. Check all appropriate connections after the system is powered down.
INTR1 Error	Interrupt channel 1 failed POST.
INTR2 Error	Interrupt channel 2 failed POST.
Invalid Boot Diskette	AMIBIOS can read the diskette in floppy drive A:, but it cannot boot the system with it. Use another boot diskette and follow the screen instructions.
Keyboard Is Locked...Unlock It	The keyboard lock on the system is engaged. The system must be unlocked to continue to boot.
Keyboard Error	The keyboard has a timing problem. Make sure a Keyboard Controller AMIBIOS is installed. Set Keyboard in Advanced Setup to Not Installed to skip the keyboard POST routines.
KB/Interface Error	There is an error in the keyboard connector.
No ROM BASIC	Cannot find a proper bootable sector on either drive A: or C:. AMIBIOS cannot find ROM Basic.
Off Board Parity Error	Parity error in memory installed on an adapter card in an expansion slot. The format is: OFF BOARD PARITY ERROR ADDR = (XXXX) XXXX is the hex address where the error occurred. Run AMIDiag to find and correct memory problems.
On Board Parity Error	Parity error in motherboard memory. The format is: ON BOARD PARITY ERROR ADDR = (XXXX) XXXX is the hex address where the error occurred. Run AMIDiag to find and correct memory problems.
Parity Error ????	Parity error in system memory at an unknown address. Run AMIDiag to find and correct memory problems.

Appendix 1

CPU Retention Module Options

Tyan offers two different options for securing Intel's Pentium II and Celeron CPUs onto the motherboard. Each option provides retention for both older Pentium II's as well as newer Pentium II's (including Slot 1 type Celeron).

OPTION 1:

Two different types of retention modules are included in the motherboard package. For older versions of Pentium II, use the retention module shown in Figure 1. For newer versions of Pentium II CPUs (including Slot 1 type Celeron and SECC2 CPUs), use the retention module shown in Figure 2. (Screws for the retention modules are provided.)

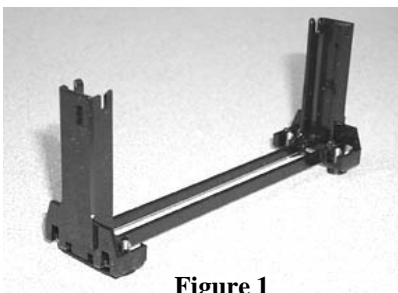

Figure 1

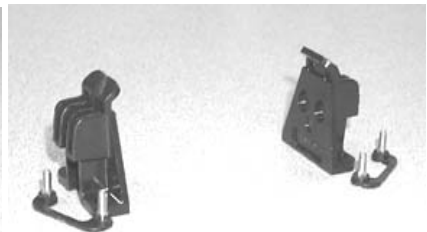

Figure 2

OPTION 2:

One universal retention module package is included in the motherboard package. This type of retention module adapts to most versions of SECC2-type Pentium II CPUs - see Figure 3. (Screws for the retention modules are provided)

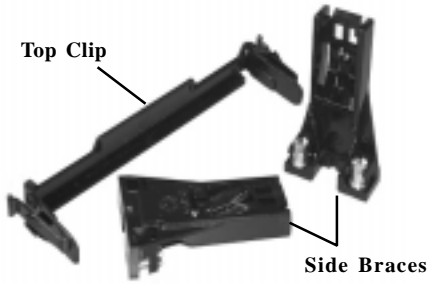

Figure 3

appendix 2

Adaptec Ultra2 LVD SCSI

1. INTRODUCTION

With the dual channel onboard Ultra2 SCSI connectors, you can connect up to 30 SCSI peripherals, such as hard disk drives, scanners, CD-ROM drives, and tape drives. This guide provides instructions for

- Connecting SCSI peripherals
- Installing the AIC7986 software

The motherboard has two independent Ultra2 LVD SCSI channels and each has a maximum throughput of 80MBytes/sec.

Support for Non-Ultra2 SCSI Devices

The LVD signaling used for Ultra2 devices operates differently than single-ended signaling used on Ultra, Fast, and Fast Wide SCSI devices. Ultra2 SCSI devices are designed with multimode capability so that if a single-ended device is connected to the LVD Ultra2 SCSI bus, the Ultra2 devices automatically switch to single-ended mode. When an Ultra2 SCSI device operates in single-ended mode it is subject to the cable distance limitations and signal noise problems of that interface.

Adaptec recommends that single-ended Ultra and earlier devices be kept on a separate channel than the LVD Ultra2 devices. This will permit the Ultra2 devices to operate at full speed and cable distances. The motherboard has a standard narrow SCSI (50-pin) connector to simplify connecting single-ended devices.

Board Layout

The following diagram shows the major SCSI connectors and jumpers for the motherboard.

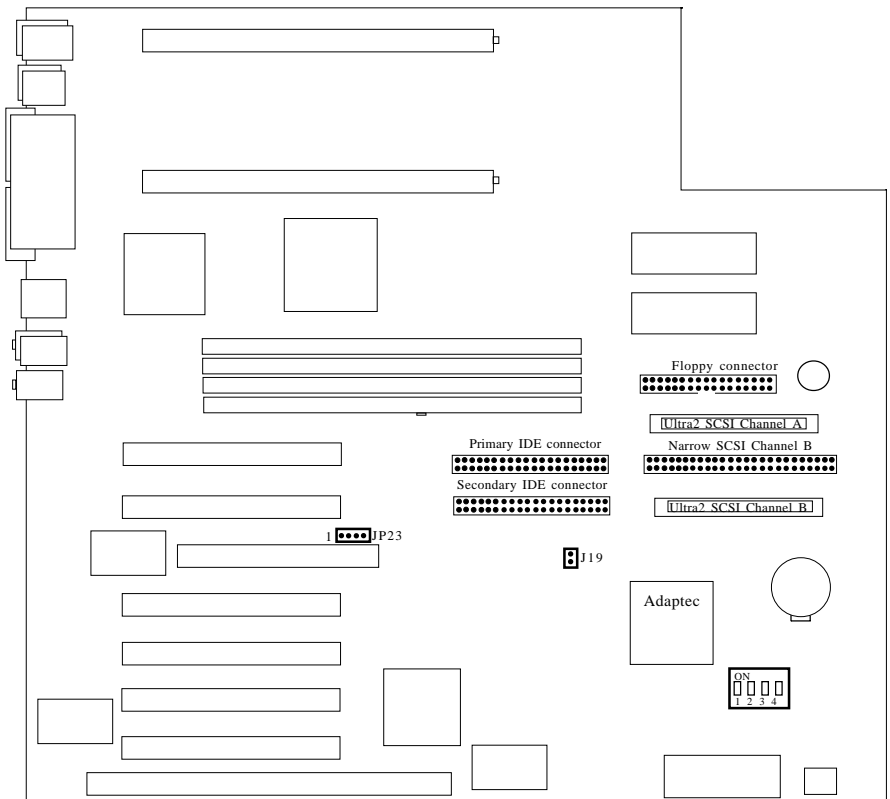

2. Setting Up SCSI Peripherals

Setting up SCSI peripherals before attaching them to the SCSI connectors typically involves setting SCSI IDs and termination, mounting internal peripherals inside your computer, and connecting power cables to each peripheral. Since setup can vary from peripheral to peripheral, always refer to the peripheral's documentation for specific instructions. Below are some guidelines for setting SCSI IDs and termination on your peripherals.



NOTE: If you refer to the peripheral's documentation for installation instructions, be sure to return to this document to continue with installation of the software included in the package.

Check the SCSI IDs

The motherboard SCSI connectors and each peripheral you connect to it requires a unique SCSI ID number ranging from 0 to 15 on each channel. ID numbers don't have to be sequential, as long as the connector and each peripheral has a different number for each channel.

Each SCSI channel on the motherboard is preset to ID 7 and should not be changed. If you will be booting from a SCSI hard disk, it's best to set the disk's ID at 0 or 1. Most SCSI hard disks come from the factory preset to ID 0. The IDs for internal peripherals are usually set with jumpers; external peripherals are usually set with a switch on the back of the peripheral.

Terminate the Ends

To ensure reliable communication on the SCSI bus, the peripheral at the end of each cable, or the end of the cable itself, must have a terminator installed (or enabled). The peripherals between the ends of each cable must have the terminator removed (or disabled).



NOTE: When connecting Ultra2 SCSI peripherals, it is important to note that the necessary termination of the SCSI bus is done either on the end of the cable (with a permanent terminator) or a separate terminating connector. Ultra SCSI and earlier single-ended devices had the ability to terminate the bus directly from the device. Using an Ultra SCSI terminator on an LVD Ultra2 SCSI bus will force the bus to single-ended mode, limiting the speed and cable distance. For this reason be sure that you have the necessary Ultra2 cable or terminator before installing the Ultra2 SCSI devices.

3. Connecting SCSI Peripherals

A total of 30 SCSI peripherals can be connected to the onboard SCSI connector, with 15 on each channel. Before connecting peripherals to the connectors, be sure to also review “Setting Up SCSI Peripherals” on the previous page.

Connecting Internal Cables for Ultra2 SCSI Devices

When connecting internal Ultra2 SCSI peripherals there are special SCSI cables necessary to sustain the higher speeds of LVD signaling. If your cables are not marked, you can identify most Ultra2 SCSI cables as having twisted pairs of the flat ribbon cable in between the device connectors. These cables will usually have a terminator built into the end of the cable.

The motherboard has two separate Ultra2 SCSI channels. Each channel will connect to a separate cable. Follow these steps to connect your internal peripherals:



NOTE: We recommend keeping your Ultra2 peripherals separate from your non-Ultra2 peripherals. Connecting a non-Ultra2 peripheral to an Ultra2 SCSI bus forces the Ultra2 SCSI channel and any attached peripherals to drop down to Ultra SCSI performance levels (40 MBytes/sec).

STEP 1: Locate a 68-pin internal Ultra2 SCSI cable. (It should look similar to the cable below.)

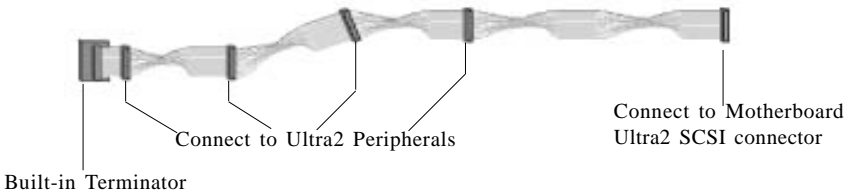

STEP 2: Plug the long end of the cable(s) to the Ultra2 connector(s) on the motherboard - Channel A or B. (refer to the board layout for connector location).

STEP 3: Plug the remaining connectors to your internal Ultra2 SCSI peripherals.



NOTE: Internal Ultra2 SCSI peripherals come from the factory without termination. Proper termination is provided by the built-in terminator at the end of the Ultra2 internal SCSI cable.

Connecting Internal Cables for Non-Ultra2 SCSI Devices

Internal cables for single-ended SCSI devices do not have special twists or terminators built into the cable ends. If you are connecting non-Ultra2 SCSI devices, use a channel separate from the Ultra2 SCSI devices you just connected. The motherboard has a special 50-pin narrow connector to more easily support narrow Ultra and earlier devices if you so choose.

If you are connecting Wide SCSI peripherals you will need a 68-pin cable. If you are connecting narrow SCSI peripherals you will need a 50-pin cable. When connecting the 50-pin cable to peripherals ensure that the colored edge of the cable connects to pin 1 of both the device and the motherboard SCSI connector.

STEP 1: Locate a 68-pin or 50-pin internal Ultra SCSI cable.

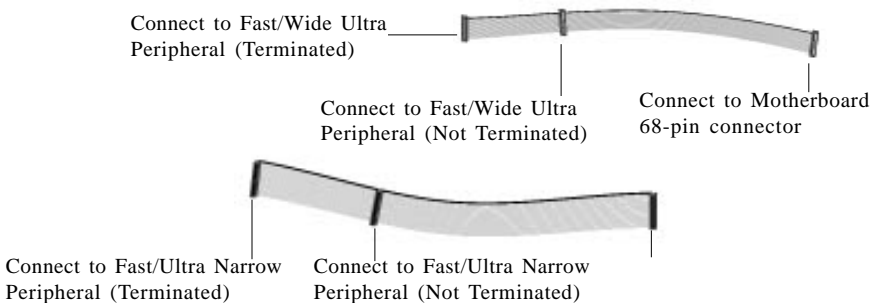

STEP 2: Plug the long end of the cable to the 68-pin motherboard connector if the cable is 68-pin or plug the long end of the cable to the 50-pin motherboard connector if the cable is 50-pin.

STEP 3: Plug the other end of the cable to a terminated Fast/Wide Ultra SCSI peripheral (if 68-pin) or a terminated Fast/Ultra Narrow SCSI peripheral (if 50-pin).

STEP 4: To connect a second peripheral, plug the middle connector of the cable to the peripheral. The peripheral must not be terminated.

Connecting the External Cable for SCSI Devices

Use a 68-pin external Ultra2 SCSI connector to connect your external Ultra2 peripherals. Each Ultra2 SCSI peripheral connects to the next in a daisy chain. Therefore each external peripheral will require an external cable.

As an option, Tyan provides an external Ultra2 SCSI connector that can be inserted in an expansion slot. The cable end of the external SCSI connector can either be plugged into the Ultra2 SCSI motherboard connector, or it can be connected to the end of a 68-pin Ultra SCSI cable (be sure to take off the cable terminator first).



NOTE: You have the option to connect either Ultra2 SCSI or Ultra SCSI (and earlier) devices externally. However, mixing both Ultra2 SCSI and non-Ultra2 SCSI on the same channel will cause all devices on that channel to operate in Ultra SCSI (single-ended) mode with the limits of the cable and speeds of that interface.

STEP 1: Connect one end of an external SCSI cable to the external Ultra2 connector at the back of the computer.

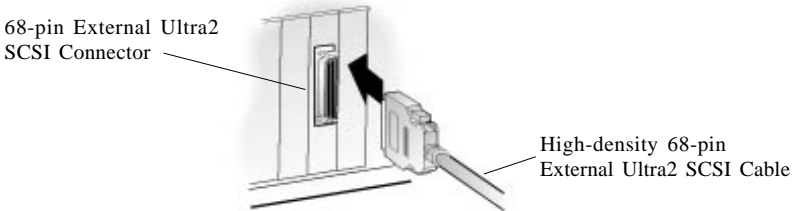

STEP 2: Connect the other end of the cable to a SCSI connector on the back of an external peripheral. If you are installing only one external peripheral, terminate the peripheral and skip to Step 4.

STEP 3: Connect other external peripherals by connecting each peripheral to the previous one until all peripherals are connected. The peripheral at the end of the chain must be the only external peripheral terminated.



STEP 4: Connect all power cables to the external peripherals.



4. Additional Termination Information

The last physical device on the end of each SCSI bus cable must be terminated. Termination must be disabled for all other devices in the middle of the cables. Ultra2 SCSI peripherals *do not* have built-in termination, but Ultra and Fast/Wide devices do have termination that must be checked. For more information refer to the owners manuals for each SCSI device.

The host adapter will automatically enable or disable termination as necessary.

When installed in multiple computer configurations, i.e. clusters, you can force the motherboard to enable termination even when power to the computer is OFF. This would enable the other computers in the cluster to continue to operate the shared SCSI devices even when the computer

supplying termination at the other end of the bus is shut down. By default, the motherboard is built with the onboard termination Enabled.

5. Installing AIC7896 SCSI Software

To install the AIC7896 SCSI software (drivers), go to the section below for the operating system installed on your computer (for example, Computers with Windows 95/98). If the operating system is not yet installed, install it now. Refer to your operating system documentation for instructions.

NOTE: If you have installed a new SCSI hard drive in a computer running Windows or DOS, you must partition and format the drive with the DOS FDISK and FORMAT commands before it can be used. Refer to your Windows and DOS documentation for instructions.



important

Computers with Windows 98 Installed

1. Click on the Start Button on the Task bar and Select Settings, Control Panel. Under the Control Panel, select System, Device Manager, Other Device.
2. Double click the "PCI SCSI bus controller"
3. Click on "Driver" and then "Update Driver" buttons.
4. Click "Next"
5. Select "Search for a better driver than the one your device is using now"
6. Click "Next" and select "Specify a location"
7. At the command prompt, type **A:\win9X** and click "Next". Where A: is the AIC-7896 driver disk provided by Tyan.
8. Windows will copy driver from the floppy disk.
9. Repeat the steps above for the secondary SCSI channel.
10. Reboot the system when prompted.

Computers with Windows 95 Installed

1. Click on the Start Button on the Task bar and Select Settings, Control Panel. Under the Control Panel, select System, Device Manager, Other Device.
2. Double click the "PCI SCSI bus controller"
3. Click on "Driver" and then "Update Driver" buttons.
4. Click "Next"
5. Select "Yes (Recommended)" and click the "Next" button

6. Click "Other Location"
7. At the command prompt, type **A:\win9X** and click "OK". Where A: is the AIC-7896 driver disk provided by Tyan.
8. Click "Finish"
9. A dialog box "Please insert the disk labeled 7800 family manager set installation disk" will appear. Click "OK"
10. At the command prompt, type **A:\win9x** and click "OK"
11. Windows will copy driver from the floppy disk.
12. Repeat the steps above for secondary SCSI channel.
13. Reboot the system when prompted.

Computers with Windows NT Installed

1. Use the three floppy disks that come with Windows NT 4.0 for installation.
2. After the second floppy disk finishes loading, NT will ask for a mass storage device. At this point, you can have Windows NT install the Adaptec 7896 driver from the disk provided by Tyan.
3. Follow the NT installation instructions.

Computers with NetWare, OS/2, SCO UNIX, and UnixWare

The 7800 Family Manager Set included in the package allows you to install drivers for NetWare, OS/2, SCO UNIX, and UnixWare. Refer to the 7800 Family Manager Set User's Guide for installation instructions.

5. Troubleshooting

If you have any problems during the installations, check the following items first:

- Are all SCSI devices powered on?
- Are all SCSI cables and power cables properly connected?
- Does each device on the SCSI bus have a unique SCSI ID?
- Does the total SCSI cable length exceed the maximum allowable length?
- Is the SCSI chain properly terminated?

Appendix 3

Glossary

ACPI (Advanced Configuration and Power Interface) is a power management specification that allows the operating system to control the amount of power distributed to the computer's devices. Devices not in use can be turned off, reducing unnecessary power expenditure.

AGP (Accelerated Graphics Port) is a PCI-based interface which was designed specifically for demands of 3D graphics applications. The 32-bit AGP channel directly links the graphics controller to the main memory. While the channel runs at only 66MHz, 2X supports data transmission during both the rising and falling ends of the clock cycle, yielding an effective speed of 133MHz.

The **AT** was the original form factor of IBM's PC.

ATAPI (AT Attachment Packet Interface), also known as IDE or ATA, is a drive implementation that includes the disk controller on the device itself. It allows CD-ROMs and tape drives to be configured as master or slave devices, just like hard drives.

The **ATX** form factor was designed to replace the AT form factor. It improves on the AT design by rotating the board ninety degrees, so that the IDE connectors are closer to the drive bays, and the CPU is closer to the power supply and cooling fan. The keyboard, mouse, serial, USB, and parallel ports

are built in.

Bandwidth refers to carrying capacity. The greater the bandwidth, the more data the bus, phone line, or other electrical path, can carry. Greater bandwidth, then, also results in greater speed.

A **BBS (Bulletin Board System)** is a computer system with a number of modems hooked up to it which acts as a center for users to post messages and access information.

The **BIOS (Basic Input/Output System)** program resides in the ROM chip, and provides the basic instructions for controlling your computer's hardware. Both the operating system and application software use BIOS routines to ensure compatibility.

A **buffer** is a portion of RAM which is used to temporarily store data, usually from an application, though it is also used when printing, and in most keyboard drivers. The CPU can manipulate data in a buffer before copying it, all at once, to a disk drive. While this improves system performance--reading to or writing from a disk drive a single time is much faster than doing so repeatedly--there is the possibility of losing your data should the system crash. Information stored in a buffer is temporarily stored, not permanently saved.

A **bus** is a data pathway. The term is used especially to refer to the connection between the processor and system memory, and between the processor and PCI or ISA local buses.

Bus mastering allows peripheral devices and IDEs to access the system memory without going through the CPU (similar to DMA channels).

A **cache** is a temporary storage area for data that will be needed often by an application. Using a cache lowers data access times, since the needed information is stored in the SRAM instead of in the slower DRAM. Note that the cache is also much smaller than your regular memory: a typical cache size is 512KB, while you may have as much as 1GB of regular memory.

Cache size refers to the physical size of the cache onboard. This should not be confused with the cacheable area, which is the total amount of memory which can be scanned by the system in search of data to put into the cache. A typical setup would be a cache size of 512KB, and a cacheable area of 512MB. In this case, up to 512MB of the main memory onboard is capable of being

cached. However, only 512KB of this memory will be in the cache at any given moment. Any main memory above 512MB could never be cached.

Closed and open jumpers Jumpers and jumper pins are active when they are On or Closed, and inactive when they are Off or Open.

CMOS Complementary Metal-Oxide Semiconductors are chips that hold the basic start-up information for the BIOS.

The **COM port** is another name for the serial port, which is so-called because it transmits the eight bits of a byte of data along one wire, and receives data on another single wire (that is, the data is transmitted in serial form, one bit after another). Parallel ports transmit the bits of a byte on eight different wires at the same time (that is, in parallel form, eight bits at the same time).

DIMM Dual In-line Memory Modules are a faster and more capacious form of RAM than SIMMs, and do not need to be installed in pairs.

DIMM bank DIMM banks are sometimes called DIMM sockets, because the physical slot and the logical unit are the same. That is, one DIMM module fits into one DIMM socket, which is capable of acting as a memory bank.

DMA Direct Memory Access channels are similar to IRQs. DMA channels allow hardware devices (like sound cards or keyboards) to access the main memory without involving the CPU. This frees up CPU resources for other tasks. As with IRQs, it is vital that you do not double up devices on a single line. Plug and Play devices will take care of this for you.

In **Doze mode**, only the CPU's speed is slowed.

DRAM Dynamic RAM is a widely available, very affordable form of RAM which has the unfortunate tendency to lose data if it is not recharged regularly (every few milliseconds). This refresh requirement makes DRAM slower three to ten times slower than non-recharged RAM such as SRAM.

EDO RAM (Extended Data-Out RAM) speeds access to memory locations by assuming that memory addresses are static: the next time it looks for a bit of data, it will be at the same spot, or one nearby.

EEPROM Electrically Erasable Programmable ROM, also called Flash BIOS, is a

ROM chip which can, unlike normal ROM, be updated. This allows you to keep up with changes in the BIOS programs without having to buy a new chip. TYAN's BIOS updates can be found at <http://www.tyan.com/html/drivers.html>

ESCD (Extended System Configuration Data) is a format for storing information about Plug and Play devices in the system BIOS. This information helps properly configure the system each time it boots.

Firmware is low level software that controls the system hardware.

Form factor is an industry term for the size, shape, power supply type, and external connector type of the PCB (personal computer board) or motherboard. The standard form factors are the AT and ATX, although TYAN also makes some Baby-AT boards.

A **Global timer** is an onboard hardware timer, such as the Real Time Clock.

Handshaking is a form of encryption. One system, typically the server, sends an encryption scheme to another agent, typically a client. Thus, the client's data is protected during transmittal to the server.

HDD stands for **Hard Disk Drive**.

H-SYNC controls the horizontal properties of the monitor.

IC (Integrated Circuit) is the formal name for the computer chip.

IDE Integrated Device (or Drive) Electronics is a simple, self-contained hard drive interface. It can handle drives up to 8.4GB in size. Almost all IDEs sold now are in fact Enhanced IDEs (EIDEs).

IDE INT (IDE Interrupt) is a hardware interrupt signal that goes to the IDE.

I/O Input/Output is the connection between your computer and another piece of hardware (mouse, keyboard, etc.).

IRQ An Interrupt Request is an electronic request that runs from a hardware device to the CPU. The interrupt controller assigns priorities to incoming requests and delivers them to the CPU. It is important that there is only one device hooked up to each IRQ line; doubling up devices on IRQ lines can lock

up your system. Happily, Plug and Play operating systems take care of these details for you.

ISA stands for **I**ndustry **S**tandard **A**rchitecture. ISA is a slower 8- or 16-bit BUS (data pathway).

Latency is the amount of time that one part of a system spends waiting for another part to catch up. This is most common when the system sends data out to a peripheral device, and is waiting for the peripheral to send some data back (peripherals tend to be slower than onboard system components).

NVRAM ROM and **EEPROM** are both examples of **Non-Volatile RAM**, memory that holds its data without power. **DRAM**, in contrast, is volatile.

OEMs (**O**riginal **E**quipment **M**anufacturers) like Compaq or IBM package other companies' motherboards and hardware inside their case and sell them.

The **parallel port** transmits the bits of a byte on eight different wires at the same time (that is, in parallel form, eight bits at the same time).

PCI stands for **P**eripheral **C**omponent **I**nterconnect. PCI is a 32-bit local bus (data pathway) which is faster than the ISA bus. Local buses are those which operate within a single system (as opposed to a network bus, which connects multiple systems).

The **PCI PIO** (**PCI P**rogrammable **I**nput/**O**utput) modes are the data transfer modes used by IDE drives. These modes use the CPU for data transfer (DMA channels do not). PCI refers to the type of bus used by these modes to communicate with the CPU.

PCI-to-PCI bridge allows you to connect multiple PCI devices onto one PCI slot.

Pipeline burst SRAM is a fast secondary cache. It is used as a secondary cache because SRAM is slower than SDRAM, but usually larger. Data is cached first to the faster primary cache, and then, when the primary cache is full, to the slower secondary cache.

Pipelining improves system performance by allowing the CPU to begin executing a second instruction before the first is completed. A pipeline can be likened to an assembly line, with a given part of the pipeline repeatedly

executing a set part of an operation on a series of instructions.

PM timers (Power Management timers) are software timers that count down the number of seconds or minutes until the system times out and enters sleep, suspend, or doze mode.

PnP is an acronym for Plug and Play, a design standard that has become ascendant in the industry. Plug and Play devices require little set-up to use. Novice end users can simply plug them into a computer that is running on a Plug and Play-aware operating system (such as Windows 95), and go to work. Devices and operating systems that are not Plug and Play require you to reconfigure your system each time you add or change any part of your hardware.

The term **RAM (Random Access Memory)**, while technically referring to a type of memory where any byte can be accessed without touching the adjacent data, is often used to refer to the system's main memory. This memory is available to any program running on the computer.

ROM (Read-Only Memory) is a storage chip which contains the BIOS (Basic Input/Output System), the basic instructions required to boot the computer and start up the operating system.

SDRAM (Synchronous Dynamic RAM) is so-called because it can keep two sets of memory addresses open simultaneously. By transferring data alternately from one set of addresses, and then the other, SDRAM cuts down on the delays associated with non-synchronous RAM, which must close one address bank before opening the next.

The **serial port** is so called because it transmits the eight bits of a byte of data along one wire, and receives data on another single wire (that is, the data is transmitted in serial form, one bit after another).

SIMM Single In-line Memory Modules are the most common form of RAM. They must be installed in pairs, and do not have the carrying capacity or the speed of DIMMs.

SIMM bank/socket SIMM sockets are the physical slots into which you stick SIMM modules. A pair of SIMM sockets form a SIMM bank, and act as a unit. If only one socket is filled, the bank will not operate.

In **Sleep/Suspend mode**, all devices except the CPU shut down.

SRAM Static RAM, unlike DRAM, does not need to be refreshed in order to prevent data loss. Thus, it is faster, and more expensive.

In **Standby mode**, the video and fixed disk drive shut down; all other devices operate normally.

UltraDMA/33 is a fast version of the old DMA channel. UltraDMA is also called UltraATA. Without UltraDMA your system cannot take advantage of the higher data transmission rates of the new UltraATA hard drives.

Universal Serial Bus or USB, is a versatile port. This one port type can function as a serial, parallel, mouse, keyboard, or joystick port. It is fast enough to support video transfer, and is capable of supporting up to 127 daisy-chained peripheral devices.

VGA (Video Graphics Array) is the PC video display standard.

V-SYNC controls the vertical properties of the monitor.

WOL (Wake-on LAN) is a feature which allows remote power up through a LAN connection when used in conjunction with a WOL compliant network adapter and appropriate software. The system “listens” to network activity even when the computer is off. Special “wake-up” packets sent by another computer causes the adapter to signal the computer to power up and run a predefined program.

ZIF socket Zero Insertion Force sockets make it possible to insert CPUs without damaging the sensitive pins. The CPU is lightly placed in an open ZIF socket, and the metal lever pulled down. This shifts the processor over and down, guiding it into place on the board.

Notice for the USA

Compliance Information Statement (Declaration of Conformity Procedure) DoC
FCC Part 15: This Device complies with Part 15 of the FCC Rules.

Operation is subject to the following conditions:

1) this device may not cause harmful interference, and
2) this device must accept any interference received including interference that may cause undesired operation. If this equipment does cause harmful interference to radio or television reception, which can be determined by turning the equipment off and on, the user is encouraged to try one or more of the following measures:

- Reorient or relocate the receiving antenna.
- Increase the separation between the equipment and receiver.
- Plug the equipment into an outlet on a circuit different from that of the receiver.
- Consult the dealer or an experienced radio/television technician for help.

Notice for Canada

This apparatus complies with the Class B limits for radio interference as specified in the Canadian Department of Communications Radio Interference Regulations.

Cet appareil est conforme aux normes de Classe B d'interférence radio tel que spécifié par le Ministère Canadien des Communications dans les règlements d'interférence radio.

Notice for Europe (CE Mark)

This product is in conformity with the Council Directive 89/336/EEC, 92/31/EEC (EMC).

CAUTION: Lithium Batteries included with this board. Danger of explosion if battery is incorrectly replaced. Replace only with the same or equivalent type recommended by manufacturer. Dispose of used batteries according to manufacturer instructions.

Document # D1341-110

Jumper Settings Quick Reference

CPU Speed Settings (Switch S4)

Multiplier (set Jmprs on board)	Bus Speed (set in BIOS)	CPU speed	1	2	3	4
3.5	100	350	ON	OFF	OFF	ON
4	100	400	OFF	ON	ON	ON
4.5	66 100	300 450	OFF	ON	OFF	ON
5	66 100	333 500	OFF	OFF	ON	ON
5.5	66 100	366 550	OFF	OFF	OFF	ON
6	66 100	400 600	ON	ON	ON	OFF
6.5	66	433	ON	ON	OFF	OFF
7	66	466	ON	OFF	ON	OFF

JP32 Connector Pinout

VCC	1	2	Power LED
HDD LED	3	4	Sleep LED
Ground	5	6	Power On/Off
Reset	7	8	Ground
VCC	9	10	No Connect
IR Receive	11	12	VCC
Ground	13	14	No Connect
IR Transmill	15	16	VCC
No Connect	17	18	No Connect

J9, J10, J11, J12 Audio / Video Connector Pinouts

	1	2	3	4
J9 - MPEG Input	MPEG LRCLK	MPEG BCLK	MPEG Data In	Ground
J10 - Modem Audio	Phone	Ground	Ground	Mono Out
J11 - TV Card Audio	In-Left	Ground	Ground	In-Right
J12 - CD Audio Connector	CD_IN-Left	Ground	Ground	CD_IN-Right

J15 Front Panel Assignment

Pins	1-2	6-10	13-16	18-20	22-23	24-27
Function	Power On/Off	IR Connector	HDD LED	Power LED	Reset Switch	Speaker
Assignment	1=Power On/Off 2=GND	6=VCC 8=IR RX 9=GND 10=IR TX 11=Mode	15=- cathode 16=+ anode	18=GND 20=+	22=GND 23=Reset	24=VCC 26=Internal Speaker 27=-

JP25 Onboard Network Interface Enable / Disable

	Enable	Disable
JP25	OFF	ON

JP24 Onboard Sound Enable / Disable

	Enable	Disable
JP24	OFF	ON

JP19 Onboard SCSI Enable / Disable

	Enable	Disable
J19	OFF	ON

Fan 1 - Fan 5 Pinout

Pin	1	2	3
	Ground	+12V	Speed

JP23 SCSI LED Pinout

Pin	1	2	3	4
	VCC	SCSI LED	SCSI LED	VCC

JP33 Wake-On Ring Connector

Pin	1	2	3
	+5 VSB	Ground	WOR

JP9 CMOS Clear / Reset Password

	Default	Reset
JP9	1-2	2-3

See pages 16-20 for details on Jumpers.