



SY-5SSM

Super 7™

Motherboard

Pentium® Class CPU supported
SiS530 PCI/AGP Motherboard
Micro-ATX Form Factor
3D AGP & Audio On-board

User's Guide
&
Technical Reference

About This Guide

This User's Guide is for assisting system manufacturers and end users in setting up and installing the Motherboard. Information in this guide has been carefully checked for reliability; however, no guarantee is given as to the correctness of the contents. The information in this document is subject to change without notice.

Copyright Notice

Copyright 1998, Soyo Computer Inc. All rights reserved. This manual is copyrighted by Soyo Computer Inc. You may not reproduce, transmit, transcribe, store in a retrieval system, or translate into any language, in any form or by any means, electronic, mechanical, magnetic, optical, chemical, manual or otherwise, any part of this publication without express written permission of Soyo Computer Inc.

Trademarks

Soyo is a registered trademark of Soyo Computer Inc. All trademarks are the property of their owners.

Disclaimer

Soyo Computer Inc. makes no representations or warranties regarding the contents of this manual. We reserve the right to revise the manual or make changes in the specifications of the product described within it at any time without notice and without obligation to notify any person of such revision or change. The information contained in this manual is provided for general use by our customers. Our customers should be aware that the personal computer field is the subject of many patents. Our customers should ensure that their use of our products does not infringe upon any patents. It is the policy of Soyo Computer Inc. to respect the valid patent rights of third parties and not to infringe upon or assist others to infringe upon such rights.

Restricted Rights Legend

Use, duplication, or disclosure by the Government is subject to restrictions set forth in subparagraph (c)(1)(ii) of the Rights in Technical Data and Computer Software clause at 252.277-7013.

Product Rights

Products mentioned in this manual are mentioned for identification purpose only. Product names appearing in this manual may or may not be registered trademarks or copyrights of their respective companies.

If you need any further information, please come to our home page on the Internet. The address is "<http://www.soyo.com.tw>".

Edition: December 1998
Version 1.0
5SSM SERIAL

FC Tested To Comply
With FCC Standards
FOR HOME OR OFFICE USE

100% POST CONSUMER
RECYCLED PAPER

Table of Contents

SY-5SSM MOTHERBOARD LAYOUT 1

CHAPTER 1 INTRODUCTION..... 1

1-1 KEY FEATURES 2

1-2 HANDLING THE MOTHERBOARD 5

1-3 ELECTROSTATIC DISCHARGE PRECAUTIONS..... 5

CHAPTER 2 HARDWARE SETUP 6

2-1 PREPARATIONS6

2-2 UNPACKING THE MOTHERBOARD7

2-3 INSTALLATION GUIDE.....8

CHAPTER 3 BIOS SETUP UTILITY 36

3-1 STANDARD CMOS SETUP 38

3-2 BIOS FEATURES SETUP 41

3-3 CHIPSET FEATURES SETUP 47

3-4 POWER MANAGEMENT SETUP 51

3-5 PNP/PCI CONFIGURATION SETUP 57

3-6 LOAD SETUP DEFAULTS 60

3-7 LOAD BIOS DEFAULTS 60

3-8 INTEGRATED PERIPHERALS 61

3-9 SUPERVISOR PASSWORD 66

3-10 USER PASSWORD..... 67

3-11 IDE HDD AUTO DETECTION 68

CHAPTER 4 DRIVERS INSTALLATION..... 69

CHAPTER 5 ONBOARD VGA AND AUDIO..... 73

CHAPTER 6 SIS VGA DRIVER INSTALLATION 79

CHAPTER 7 ESS™AUDIO DRIVER INSTALLATION..... 81

SY-5SSM Motherboard Layout

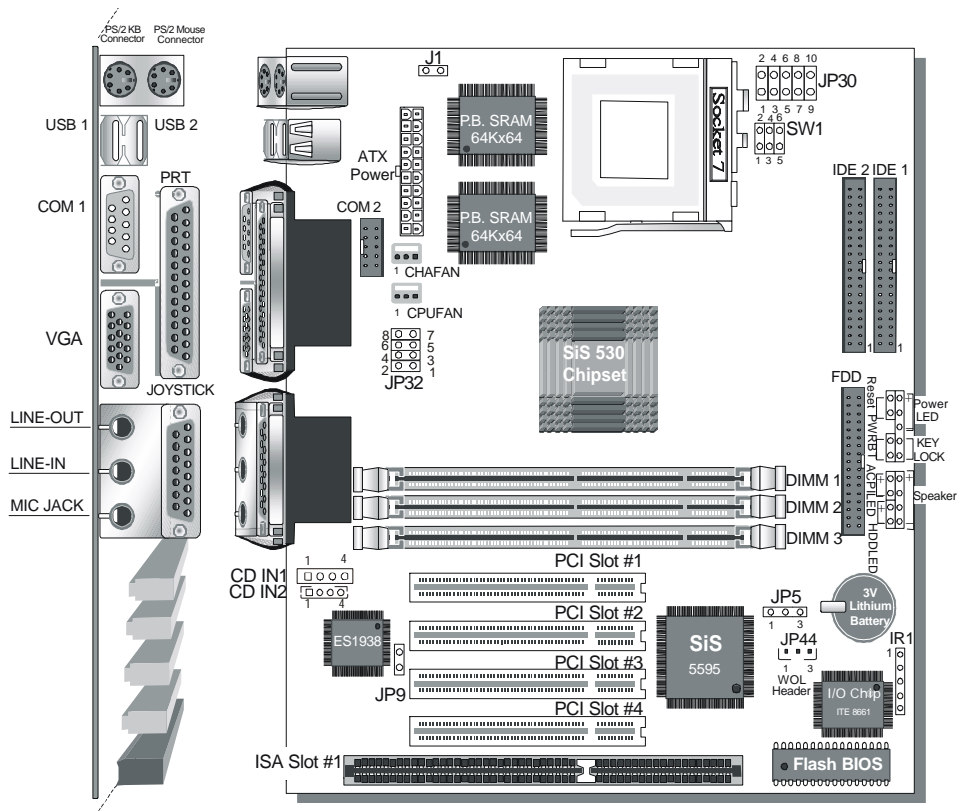

Back Panel

SY-5SSM Platform

Chapter 1

INTRODUCTION

The **SY-5SSM** AGP/PCI Motherboard is a high-performance MICRO-ATX form-factor system board. **SY-5SSM** uses the SiS530 PCI Chipset technology and supports Pentium® class processors. This Motherboard is fully compatible with industry standards and adds many technical enhancements.

1-1 KEY FEATURES

- Integrated 3D AGP accelerator supports UMA or non-UMA (option)
- 3D PnP PCI Audio onboard
- 1 MB L2 cache on board
- Supports CPU voltage from 2.0V to 3.5V in 0.1V increment
- PC98, ACPI, Ultra DMA 33/66
- Power-on by modem or alarm
- Supports Wake-On-LAN (WOL)
- Supports power-off by hot-key
- 3 x 32-bit bus mastering PCI slots
- 1 x 32-bit bus slaving PCI slot
- 2 x USB ports
- 1 x IrDA port
- Supports multiple-boot function
- Supports Pentium® class CPU with host bus clock of 66/100 MHz
- Supports system memory up to 768MBytes

SY-5SSM PLATFORM FEATURES

Board Size	4-layer PCB, 22x24.4cm(8.7"x9.6"), MICRO-ATX Form Factor
Socket 7	Socket for Pentium® class CPUs with host bus frequency of 66/100MHz; Supports: <ul style="list-style-type: none">➤ Intel Pentium® Processors P54C/P55C (100-233MHz)➤ Cyrix 6x86™(PR166+-PR200+), Cyrix 6x86 MX™(PR166-PR266) and Cyrix M II™ (300~350)➤ AMD K5™(PR100-PR166), and AMD K6™(166-300) and AMD K6™2 (266~450)➤ IDT WinChip™C6/W2 (200/225MHz)
Chipset	SiS530 PCI/AGP Bus Chipset 3D AGP accelerator integrated
ATX Power	20-pin Male Connector
CPUFAN	3-pin CPU Cooling Fan Connector
CHAFAN	3-pin Chassis Cooling Fan Connector
Memory	DIMM Bank (DIMM1 & DIMM2 & DIMM3) <ul style="list-style-type: none">➤ 168-pin Unbuffered SDRAM DIMM Module➤ Supports 8~256MB DIMM in each Bank➤ Supports ECC configuration
BIOS	System BIOS built-in, Award BIOS <ul style="list-style-type: none">➤ APM, ACPI and "Plug-and-Play" function➤ Supports multiple-boot function
PCI Slots	3 x 32-bit Bus Mastering Slots 1 x 32-bit Bus Slaving Slots
ISA Slots	1 x 16-bit ISA Slots
IDE1, IDE2	2 x 40-pin Bus Mastering E-IDE/ATAPI Ports <ul style="list-style-type: none">➤ IDE1: Primary IDE Device Connector➤ IDE2: Secondary IDE Device Connector➤ Supports Ultra DMA 33/66
FDC	1 Floppy Disk Drive (FDD) Port (Supports 1.2MB/1.44MB/2.88MB and LS120/3-mode FDD)
COM2	1 x 9-pin RS-232 Serial Connector
IR1	5-pin Serial Infrared Device Connector
Keylock	5-pin KeyLock Connector
Reset	2-pin Reset Switch Connector
Speaker	4-pin PC Speaker Connector

ACPI_LED	2-pin ACPI LED Connector
HDD_LED	2-pin IDE Device LED Connector
PWRBT	ATX Power On/Off Switch 2-pin Connector
J1	CPU Burst Mode Jumper
JP5	CMOS Clear Jumper
JP9	Enable/Disable Onboard Sound Function Jumpers
CD IN1,CD IN2	2 x CD Line-in 4-pin Connectors
JP30	CPU Voltage Selection Jumper
JP32	CPU Host Bus Frequency Jumpers
SW1	CPU Multiplier Jumpers
JP44	WOL (Wake-On-LAN) 3-pin Connector

BACK-PANEL FEATURES

PRT	1 x Onboard 25-pin Female Parallel Printer Port
COM1	1 x Onboard RS-232 Serial Port
PS/2 KB	1 x Onboard PS/2 Keyboard Connector
PS/2 Mouse	1 x Onboard PS/2 Mouse Connector
USB1, USB2	2 x Onboard USB (Universal Serial Bus) Connectors
VGA	1 x Onboard 15-pin VGA Port
JOYSTICK	1 x Onboard 15-pin Joystick Port
LINE-OUT	1 x Onboard Line-out Audio Stereo Jack
LINE-IN	1 x Onboard Line-in Audio Stereo Jack
MIC JACK	1 x Onboard Microphone Stereo Jack

1-2 HANDLING THE MOTHERBOARD

To avoid damage to your Motherboard, follow these simple rules while unpacking:

- Before handling the Motherboard, ground yourself by grasping an unpainted portion of the system's metal chassis.
- Remove the Motherboard from its anti-static packaging. Hold the Motherboard by the edges and avoid touching its components.
- Check the Motherboard for damage. If any chip appears loose, press carefully to seat it firmly in its socket.



Warning: Do not apply power if the Motherboard appears damaged. If there is damage to the board, contact your dealer immediately.

1-3 ELECTROSTATIC DISCHARGE PRECAUTIONS

Make sure to ground yourself before handling the Motherboard or other system components. Electrostatic discharge can easily damage the components. Note that you must take special precautions when handling the Motherboard in dry or air-conditioned environment.

To protect your equipment from electrostatic discharge, take the following precautions:

- Do not remove the anti-static packaging until you are ready to install.
- Ground yourself before removing any system component from its protective anti-static packaging. (To ground yourself, grasp the expansion slot covers or other unpainted portions of the computer chassis.)
- Frequently ground yourself while working or use a grounding strap.

Chapter 2

HARDWARE SETUP

Congratulations on your purchase of **SY-5SSM** Super 7™ Motherboard. You are about to install and connect your new Motherboard.



Note: Do not unpack the Motherboard from its protective anti-static packaging until you have made the following preparations.

2-1 Preparations

Gather and prepare all the following hardware equipment to complete the installation successfully:

1. Pentium processor with CPU cooling fan.
2. DIMM memory module
3. Computer case and chassis with adequate power supply unit
4. Monitor
5. Keyboard
6. Pointing Device (PS/2 mouse)
7. Speaker(s) (optional)
8. Disk Drives: HDD, CD-ROM, Floppy drive ...
9. External Peripherals: Printer, Plotter, and Modem (optional)
10. Internal Peripherals: Modem and LAN cards (optional)

Frequently Asked Questions:

- **Do I need to install a VGA card?**
- **Do I also need to install a sound card?**

The answer is NO to both questions above, since, for your convenience, the SY-5SSM Motherboard already features one built-in VGA port and three built-in audio-stereo ports (Line-out, Line-in, Microphone).

Notice: If you plan on using the onboard VGA and intend to install only one DRAM memory module, then this single DRAM **must be** installed in bank DIMM1.

- **What kind of speaker can connect to "Line-out" port?**

This Motherboard requires a speaker with built-in amplifier to generate proper output sound volume.

2-2 Unpacking the Motherboard

When unpacking the Motherboard, check for the following items:

- The **SY-5SSM** SiS530 PCI/AGP Motherboard
- This *Quick Start Guide* *
- The Installation CD-ROM *
- One IDE Device Flat Cable
- One Floppy Disk Drive Flat Cable
- One serial port flat cable with a 9-pin connector

* If your board comes with a driver disc and a paper manual, the Quick Start Guide and the CD-ROM are not included in the package.



Warning: Do not unpack the Motherboard from its anti-static packaging until you are ready to install it.

Like most electronic equipment, your Motherboard may be damaged by electrostatic discharge. To avoid permanent damage to components ground yourself while working by using a grounding strap. Otherwise, ground yourself frequently by touching the unpainted portion of the computer chassis to drain the static charges.

Handle the Motherboard carefully, holding it by the edges. You are now ready to start the installation.

2-3 Installation Guide

We will now begin the installation of the Motherboard. Please follow the step-by-step procedure designed to lead you to a complete and correct installation.

Step 1. CPU Installation

Follow these instructions to install your Pentium® class processor correctly.

Locate the CPU socket labeled Socket 7 on your Motherboard and note the distinctive pinhole arrangement.

Note the corresponding pinhole arrangement on the processor.

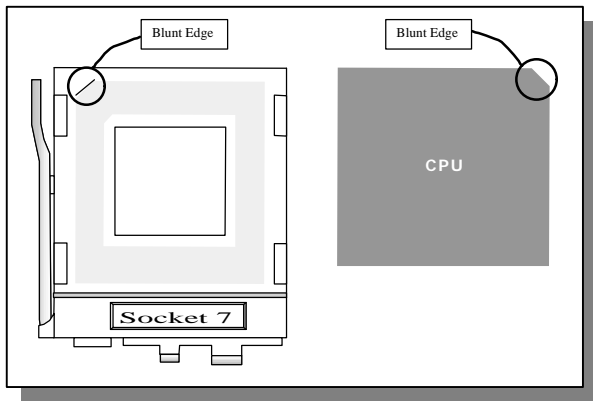

Follow these steps to install the CPU in the Socket 7:

1. Lift the socket handle up to a vertical position.
2. Align the blunt edge of the CPU with the matching pinhole distinctive edge on the socket.
3. Seat the processor in the socket completely and without forcing.
4. Then close the socket handle to secure the CPU in place.

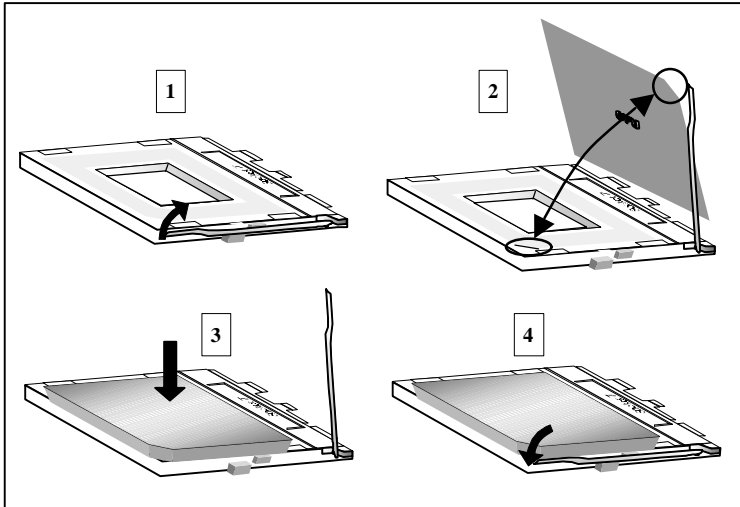

Step 2. CPU Fan Installation

Your Pentium® processor kit comes with a cooling fan. Mount the fan on the processor according to the instructions provided by the manufacturer. The fan is a key component that will ensure system stability. The fan prevents overheating, therefore prolonging the life of your CPU.

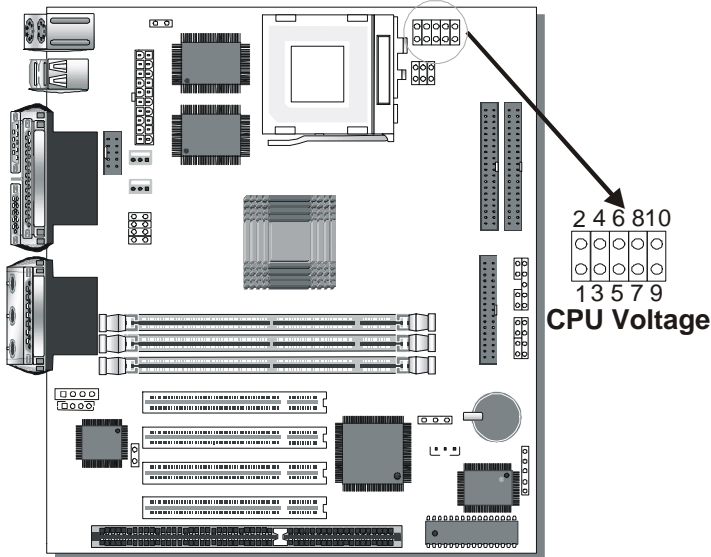

Note: Remember to connect the fan to the appropriate power source.

Step 3. CPU Voltage Setting (JP30)

Please verify the correct voltage with your dealer before installation. Use the following tables to set JP30 to the proper "Voltage Value", according to the specifications marked on your CPU: This Motherboard comes with pre-configured setting of CPU voltage. However the voltage of your CPU maybe different with the default setting.

- **CPU VOLTAGE SETTING (JP30)**

JP30 are the only jumpers that you need t4o set for your CPU voltage on this Motherboard.

There are two kinds of CPU voltages currently on the market depending on the CPU manufacturer:

- Single Voltage (CPU: P54C, AMD-K5, Cyrix 6x86, IDT WinChip C6/W2)
- Dual Voltage (CPU: P55C, AMD-K6, AMD-K6-2 Cyrix 6x86L, Cyrix 6x86MX, Cyrix M II)









Those processors may come in various voltages on different markets. Therefore, always make sure you know the type of the CPU you are installing and adjust the settings on JP30 accordingly.

This Motherboard supports CPU voltages from 2.0 to 3.52V in 0.1V increments. Use the following tables to set the CPU voltage jumpers JP30 to match the voltage value of your CPU:



CPU Voltage Setting: JP30

Voltage Value	1-2	3-4	5-6	7-8	9-10
single 3.5V*	open	short	short	short	short
single 3.3V	open	short	short	open	short
dual 3.2V	open	short	short	open	open
dual 3.1V	open	short	open	short	short
dual 3.0V	open	short	open	short	open
dual 2.9V	open	short	open	open	short
dual 2.8V	open	short	open	open	open
dual 2.7V	open	open	short	short	short
dual 2.6V	open	open	short	short	open
dual 2.5V	open	open	short	open	short
dual 2.4V	open	open	short	open	open
dual 2.3V	open	open	open	short	short
dual 2.2V	open	open	open	short	open
dual 2.1V	open	open	open	open	short
dual 2.0V	short	short	short	short	open

Voltage Settings for Various Processors

Processor Voltage Setting	Voltage Value: JP30
Intel P54C - 100 Intel P54C - 133	 Vcore:3.3V V _{I/O} :3.3V
Intel P54C - 166 Intel P54C - 200	 Vcore:3.5V V _{I/O} :3.5V
Intel P55C - 166 Intel P55C - 200 Intel P55C - 233	 Vcore:2.8V V _{I/O} :3.3V
AMD K5 - PR100 AMD K5 - PR133 AMD K5 - PR166	 Vcore:3.5V V _{I/O} :3.5V
AMD K6 166 AMD K6 200	 Vcore:2.9V V _{I/O} :3.3V
AMD K6 233	 Vcore:3.2V V _{I/O} :3.3V
AMD K6 266 AMD K6 300 AMD K6-2 266 AMD K6-2 300 AMD K6-2 333 AMD K6-2 350 AMD K6-2 366 AMD K6-2 380 AMD K6-2 400	 Vcore:2.2V V _{I/O} :3.3V
AMD K6-2 450	 Vcore:2.3V V _{I/O} :3.3V

Voltage Settings for Various Processors (continued)

Processor Voltage Setting	Voltage Value: JP30
Cyrix 6x86(L) PR166+ Cyrix 6x86(L) PR200+	The Cyrix 6x86(L) come in several versions with different voltages. Please ask your dealer for the correct voltage.
Cyrix 6x86MX-PR166* Cyrix 6x86MX-PR200* Cyrix 6x86MX-PR233* Cyrix 6x86MX-PR266* Cyrix M II 300* Cyrix M II 333* Cyrix M II 350*	 <p>Vcore:2.9V V_{I/O}:3.3V</p>
IDT WinChip C6/W2-200 IDT WinChip C6/W2-225	 <p>Vcore:3.5V V_{I/O}:3.5V</p>
* Set the proper CPU voltage according to the marking on the CPU.	

Step 4. CPU Frequency Setting (SW1,JP32)

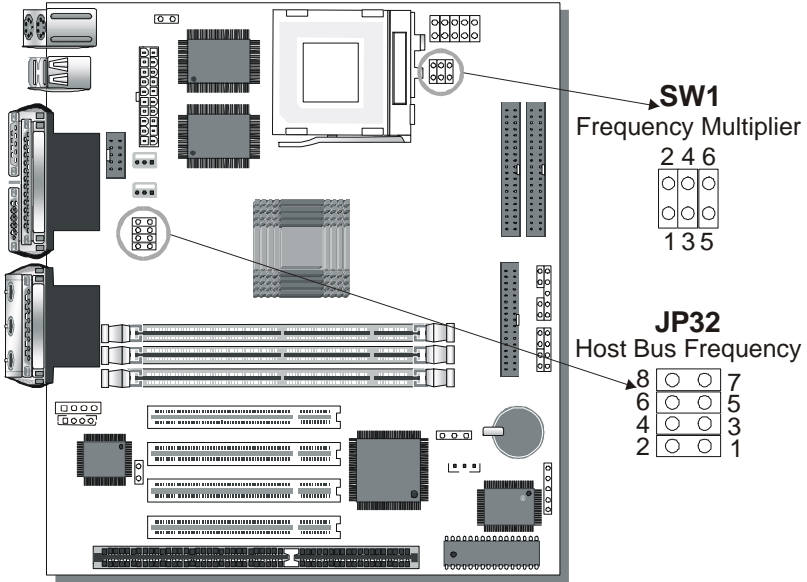

The SY-5SSM Motherboard is designed to support most Pentium® class processors currently on the market. Jumpers SW1 and JP32 are used to configure the Motherboard frequency parameters to match the working frequency of your CPU.

● CPU FREQUENCY & SDRAM frequency SETTING (SW1,JP32)

Configure the SW1 jumpers to the settings that match your CPU speed. Refer to the following tables to set the Frequency Multiplier and Host Bus Frequency of your CPU:

Frequency Multiplier: SW1

Multiplier	1-2	3-4	5-6
1.5/3.5x	open	open	open
2.0x	short	open	open
2.5x	short	short	open
3.0x	open	short	open
4.0x	short	open	short
4.5x	short	short	short
5.0x	open	short	short
5.5x	open	open	short















Host Bus Frequency & SDRAM frequency: JP32

Host Bus Frequency	PCI	SDRAM	1-2	3-4	5-6	7-8
66MHz	33MHz	66MHz	open	short	short	short
75MHz	30MHz	75MHz	open	short	short	open
83MHz	33MHz	55MHz	short	short	short	open
		83MHz	open	short	open	short
90MHz	30MHz	90MHz	short	short	short	short
95MHz	31.7MHz	63.4MHz	short	short	open	short
		95MHz	open	short	open	open
100MHz	33MHz	100MHz	open	open	short	short
105MHz	35MHz	70MHz	short	open	short	short
112MHz	37.5MHz	75MHz	short	open	short	open
		112MHz	open	open	short	open
124MHz	31MHz	82.6MHz	short	open	open	short
		124MHz	open	open	open	short
133MHz	33MHz	88.9MHz	short	open	open	open
		133MHz	open	open	open	open

Example: If the working frequency of your CPU is 133MHz, then select Multiplier=2.0x and Host Bus Frequency=66Mhz accordingly.

Please refer to the following table that gives you the correct frequency settings for the specific brand and model of CPU you are installing on this Motherboard.

Frequency Settings for Intel® Processors

Processor Frequency Setting	Ratio	Bus Clock	PCI Clock	CPU Host Bus Setting: JP32	Frequency Multiplier: SW1
Intel P54C - P100	1.5 x	66MHz	33MHz		
Intel P54C - P133	2.0 x	66MHz	33MHz		
Intel P54C - P166	2.5 x	66MHz	33MHz		
Intel P54C - P200	3.0 x	66MHz	33MHz		
Intel P55C - P166	2.5 x	66MHz	33MHz		
Intel P55C - P200	3.0 x	66MHz	33MHz		
Intel P55C - P233	3.5 x	66MHz	33MHz		

** Set the proper CPU frequency according to the marking on the CPU.

Frequency Settings for AMD™Processors

Processor Frequency Setting	Ratio	Bus Clock	PCI Clock	CPU Host Bus Setting: JP32	Frequency Multiplier: SW1
AMD K5 - PR100	1.5 x	66MHz	33MHz		
AMD K5 - PR133	2.0 x	66MHz	33MHz		
AMD K5 - PR166	2.5 x	66MHz	33MHz		
AMD K6 - 166	2.5 x	66MHz	33MHz		
AMD K6 - 200	3.0 x	66MHz	33MHz		
AMD K6 - 233	3.5 x	66MHz	33MHz		
AMD K6 - 266	4.0 x	66MHz	33MHz		
AMD K6 - 300	4.5 x	66MHz	33MHz		
AMD K6-2 266	4.0 x	66MHz	33MHz		
AMD K6-2 300	4.5 x	66MHz	33MHz		
AMD K6-2 300	3.0 x	100MHz	33MHz		
AMD K6-2 333	5.0 x	66MHz	33MHz		

** Set the proper CPU frequency according to the marking on the CPU.

Frequency Settings for AMD™Processors (Continued)











Processor Frequency Setting	Ratio	Bus Clock	PCI Clock	CPU Host Bus Setting: JP32	Frequency Multiplier: SW1
AMD K6-2 333	3.5 x	95MHz	31.7MHz	8 7 6 5 4 3 2 1	2 4 6 1 3 5
AMD K6-2 350	3.5 x	100MHz	33MHz	8 7 6 5 4 3 2 1	2 4 6 1 3 5
AMD K6-2 366	5.5 x	66MHz	33MHz	8 7 6 5 4 3 2 1	2 4 6 1 3 5
AMD K6-2 380	4.0 x	95MHz	31.7	8 7 6 5 4 3 2 1	2 4 6 1 3 5
AMD K6-2 400	4.0 x	100MHz	33MHz	8 7 6 5 4 3 2 1	2 4 6 1 3 5
AMD K6-2 450	4.5 x	100MHz	33MHz	8 7 6 5 4 3 2 1	2 4 6 1 3 5

** Set the proper CPU frequency according to the marking on the CPU.

Frequency Settings for Cyrix™Processors











Processor Frequency Setting	Ratio	Bus Clock	PCI Clock	CPU Host Bus Setting: JP32	Frequency Multiplier: SW1
Cyrix 6x86 - PR166+	2.0 x	66MHz	33MHz		
Cyrix 6x86 - PR200+	2.0 x	75MHz	30MHz		
Cyrix MX - PR166**	2.0 x	66MHz	33MHz		
Cyrix MX - PR200**	2.5 x	66MHz	33MHz		
Cyrix MX - PR200**	2.0 x	75MHz	30MHz		
Cyrix MX - PR233**	2.5 x	75MHz	30MHz		
Cyrix MX - PR266**	2.5 x	83MHz	33MHz		
Cyrix M II - 300**	3.5 x	66MHz	33MHz		
Cyrix M II - 300**	3.0 x	75MHz	30MHz		
Cyrix M II - 333**	4.0 x	66MHz	33MHz		
Cyrix M II - 333**	3.5 x	75MHz	30MHz		
Cyrix M II - 333**	3.0 x	83MHz	33MHz		

Frequency Settings for Cyrix™Processors (Continued)

Processor Frequency Setting	Ratio	Bus Clock	PCI Clock	CPU Host Bus Setting: JP32	Frequency Multiplier: SW1
Cyrix M II - 333**	2.5 x	100MHz	33MHz	8  7 6  5 4  3 2  1	 2 4 6 1 3 5
Cyrix M II - 350**	3.0 x	100MHz	33MHz	8  7 6  5 4  3 2  1	 2 4 6 1 3 5

** Set the proper CPU frequency according to the marking on the CPU.
Over specification is not guaranteed.

Frequency Settings for IDT™Processors

Processor Frequency Setting	Ratio	Bus Clock	PCI Clock	CPU Host Bus Setting: JP32	Frequency Multiplier: SW1
IDT WinChip C6/W2-200	3.0 x	66MHz	33MHz	8  7 6  5 4  3 2  1	 2 4 6 1 3 5
IDT WinChip C6/W2-225	3.0 x	75MHz	30MHz	8  7 6  5 4  3 2  1	 2 4 6 1 3 5

** Set the proper CPU frequency according to the marking on the CPU.

Step 5. DRAM Module Installation

This Motherboard supports three DIMM banks from 8 to 256 MB with no other restrictions on memory configurations. You can install the memory in any combination without having to rely on a memory configuration table. Memory configuration is therefore "table-free" in any memory bank.

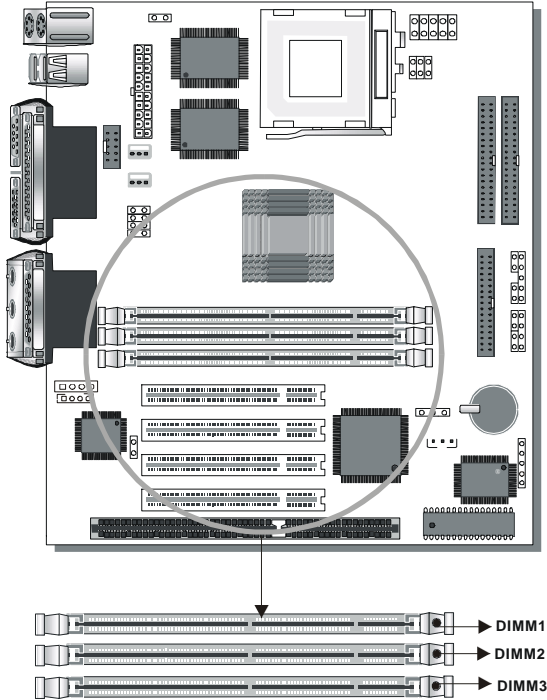

This Motherboard supports SDRAM memory modules.

● MEMORY CONFIGURATION

This Motherboard features 3 x DIMM Banks for 168-pin 3.3V unbuffered DIMM modules

Your board comes with three DIMM sockets, providing support for up to 768MB of main memory using DIMM modules from 8MB to 256MB. For 66MHz host bus CPUs use 12ns or faster DIMM modules; for 83MHz or faster host bus CPUs use 8ns modules.

Memory configuration Table

MEMORY CONFIGURATION	DIMM Banks		
	DIMM 1	DIMM 2	DIMM 3
RAM Type	SDRAM	SDRAM	SDRAM
Single RAM Module Size (MB)	8/16/32/64/128/256	8/16/32/64/128/256	8/16/32/64/128/256

Step 6. IDE Device Installation (HDD, CD-ROM)

This Motherboard offers two primary and secondary IDE device connectors (IDE1, IDE2.) It can support up to four high-speed HDD or CD-ROM.

Connect one side of the 40-pin flat cable to the IDE device (HDD or CD-ROM) and plug the other end to the primary (IDE1) or secondary (IDE2) directionally keyed IDE connector on the Motherboard.

This Motherboard can support up to four HDDs.

Note: This motherboard supports Ultra DMA 33 and Ultra DMA66 hard drives. Ultra ATA/66 hard drive requires a special 40-pin, 80-conductor cable.

Step 7. Floppy Drive Installation

The system supports 5 possible floppy drive types: 720 KB, 1.2 MB, 1.44 MB, 2.88 MB, and LS-120. In addition, this Motherboard supports a 3-mode (720KB/1.25MB/1.44MB) floppy commonly used in Japan.

Connect one side of the 34-pin flat cable to the floppy drive and plug the other end to the floppy drive connector on the Motherboard.

This Motherboard can support up to 2 floppy drives.

Step 8. Front Panel Connections

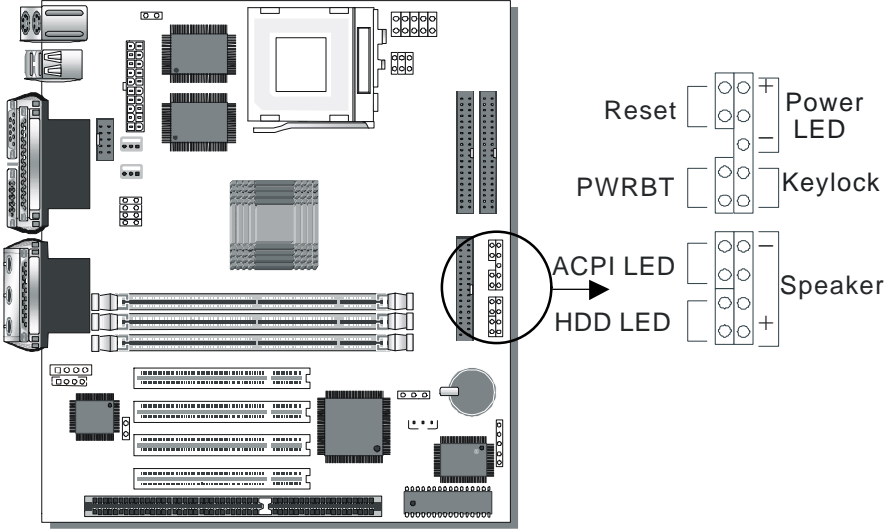

Plug the computer case's front panel devices to the corresponding connectors on the Motherboard.

1. Power LED & KeyLock

Plug the Power LED cable into the 5-pin Keylock connector. Some systems may feature a KeyLock function with a front panel switch for enabling or disabling the keyboard. Connect the KeyLock switch to the 5-pin Keylock connector on the Motherboard. Please install according to the following pin assignment: pin 1,3 are for Power LED and pin 4,5 are for Keylock.

2. Reset

Plug the Reset push-button cable into the 2-pin Reset connector on the Motherboard. Pushing the Reset button on the front panel will

cause the system to restart the boot-up sequence.

3. Speaker

Attach the 4-pin PC speaker cable from the case to the Speaker connector on the Motherboard.

4. ACPI/APM LED

Connecting the 2-pin ACPI LED cable to the corresponding ACPI/APM connector on the motherboard.

In full power on state, this LED will be always turned on.

In low power (suspend) state, this LED will be blinking.

5. IDE LED

Attach the 2-pin IDE device LED cable to the corresponding IDE LED connector on the Motherboard. This will cause the LED to lighten when an IDE (HDD, CD-ROM) device is active.

6. ATX Power On/Off Switch

Attach the 2-pin momentary type switch to the PWRBT connector for turning On or Off your ATX power supply.

Step 9. Back Panel Connections

All external devices such as the keyboard, printer, PS/2 mouse, modem, USB, monitor, joystick and audio devices (speakers/headphones, microphone and CD/cassette player) can be plugged directly onto the Motherboard back panel.

Only after you have fixed and locked the Motherboard to the computer case can you start connecting the external peripheral devices.

When connecting an external device, use the following figure to locate and identify which back panel connector to plug the device to.

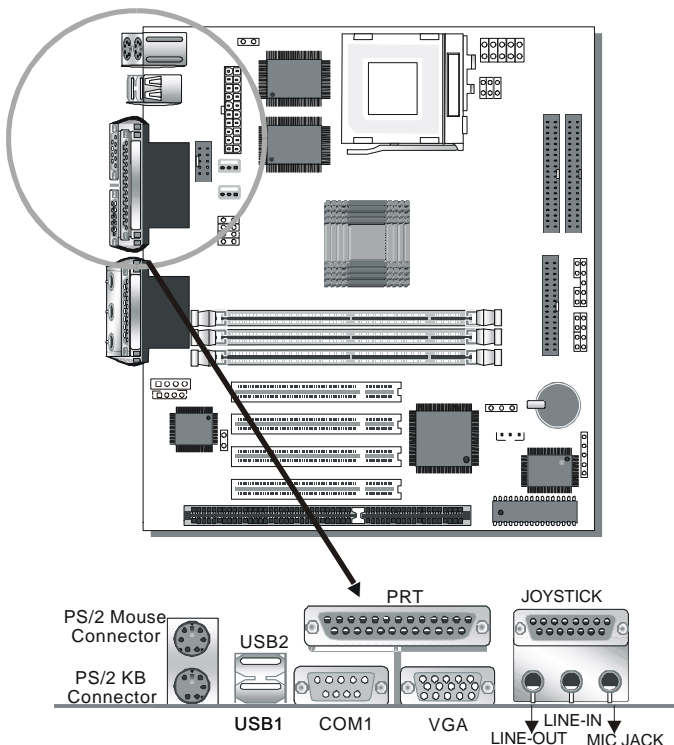

1. Onboard Serial Port COM1

External peripherals that use serial transmission scheme include:

- serial mouse,

- and modem.

Plug the serial device cables directly into the COM1 9-pin male connector located at the rear panel of the Motherboard.

2. Parallel Port PRT

This parallel port is used to connect the printer or other parallel devices.

Plug the parallel device cable into the 25-pin female connector located at the rear panel of the Motherboard.

3. PS/2 Keyboard

Plug the keyboard jack directly into the 6-pin female PS/2 keyboard connector located at the rear panel of the Motherboard.

4. PS/2 Mouse

Similarly, plug the mouse jack directly into the 6-pin female PS/2 mouse connector.

5. Universal Serial Bus USB1/USB2

This Motherboard provides two USB ports for your additional devices. Plug the USB device jack into the available USB connector USB1 or USB2.

- USB devices under Win98 are allowed.
- With Win95, use the flow HCI V1.1 specifications.

6. VGA monitor connector

Plug the monitor cable into the 15-pin female VGA connector located at the rear panel of the motherboard.

7. Onboard Joystick port/audio

This Motherboard provides Joystick port and audio.

- Attach the joystick cable to the 15-pin JOYSTICK port at the rear panel of your motherboard.
- This Motherboard features three built-in audio-stereo ports (labeled line-in, line-out, and mic jack) convenient to directly plug-in all your external audio devices.

Step 10. Other Connections

1. Serial Port COM 2

In addition to the onboard serial connector COM1 located at the rear panel, your Motherboard comes with a second serial port COM2 equipped with a flat cable and external connector.

The Motherboard package includes one serial port flat cable with a 9-pin connector.

Plug the 9-pin end of the flat cable into the COM2 serial connector on the Motherboard, as shown in the figure below, then fix the external 9-pin connector to the rear panel of the computer case. Then plug your serial device cable directly into this 9-pin male connector located at the back of your computer.

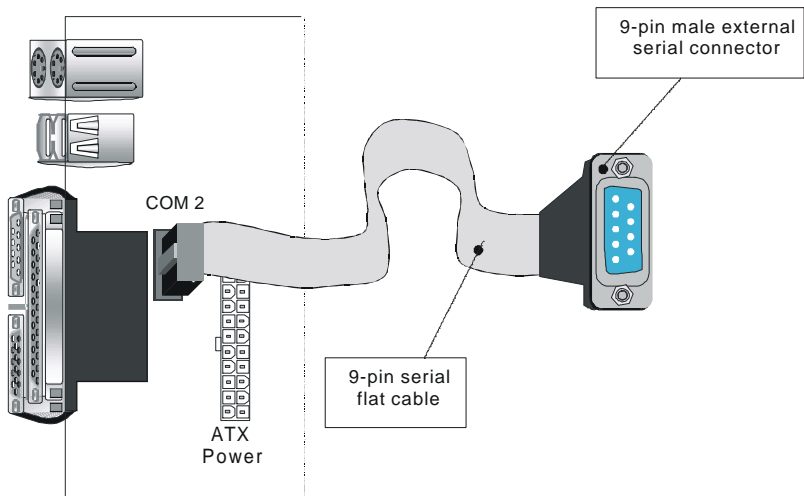

2. Wake-On-LAN (WOL)

Attach the 3-pin connector from the LAN card which supports the Wake-On-LAN (WOL) function to the JP44 connector on the Motherboard. This WOL function lets users wake up the connected computer through the LAN card.

Please install according to the following pin assignment:

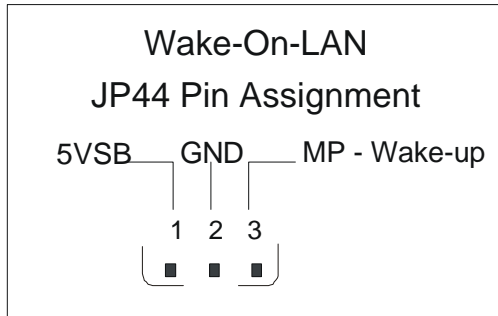

3. Infrared (IR1)

Plug the 5-pin infrared device cable to the IR1 connector. This will enable the infrared transfer function. This Motherboard meets both the ASKIR and HPSIR specifications.

Please install according to the following pin assignment:

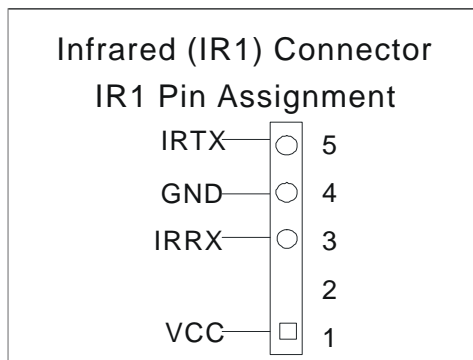

4. CD Line-in (CDIN1,CDIN2)

This Motherboard provides two CD-Line in connectors. Please connect the 4-pin audio cable from your CD-ROM drive to either CDIN1 or CDIN2. (It fits in only one, depending on the cable that came with your CD-ROM drive)

Please install according to the following pin assignment:

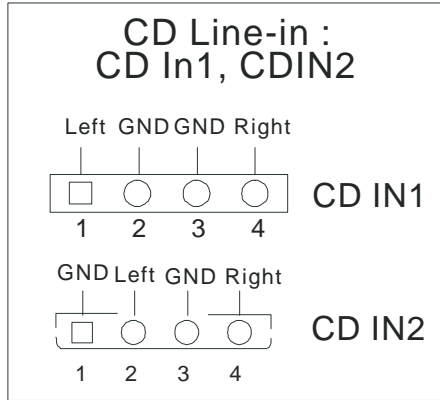

5. Other Display Cards

Insert other types of VGA cards into the PCI or ISA expansion slots according to card specifications.

Step 11. CPU Cooling Fan Installation

After you have seated the CPU cooling fan properly on the processor, attach the 3-pin fan cable to the CPUFAN connector on the Motherboard.

To avoid damage to the system, install according to the following pin assignment:

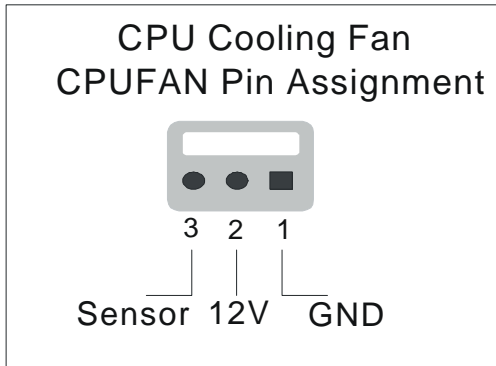

Step 12. Chassis Cooling Fan Installation

After you have seated the Chassis cooling fan properly on the processor, attach the 3-pin fan cable to the CHAFAN connector on the Motherboard.

To avoid damage to the system, install according to the following pin assignment:

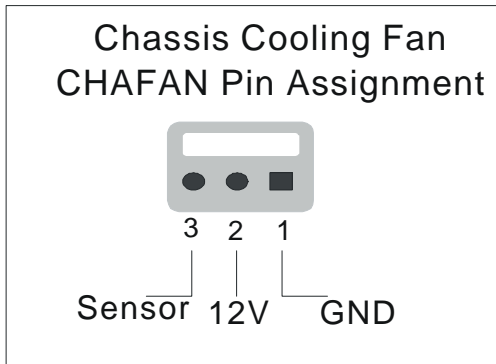

Step 13. ATX Power Supply

Plug the connector from the power directly into the 20-pin male ATX PW connector on the Motherboard, as shown in the following figure.

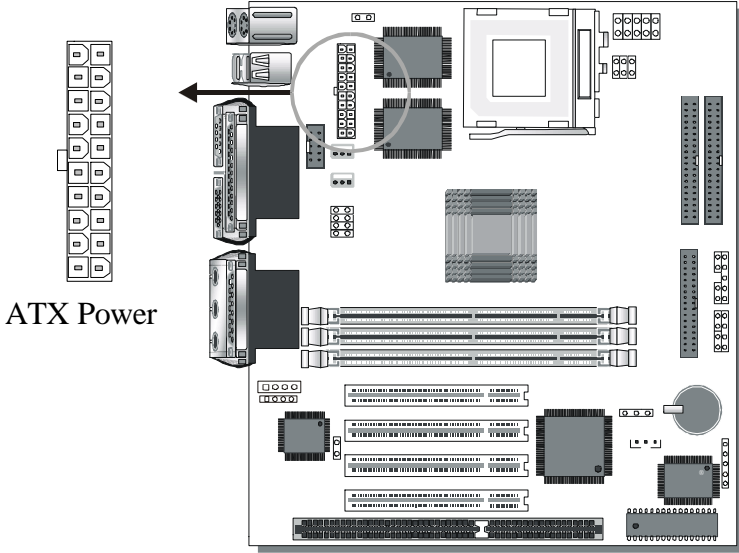

Warning: Follow these precautions to preserve your Motherboard from any remnant currents when connecting to ATX power supply:



Turn off the power supply and unplug the power cord of the ATX power supply before connecting to ATX PW connector.

The Motherboard requires a power supply with at least 200 Watts and a "power good" signal. Make sure the ATX power supply can take at least 10 mA* load on the 5V Standby lead (5VSB) to meet the standard ATX specification.

* **Note:** If you use the Wake-On-LAN (WOL) function, make sure the ATX power supply can support at least 720 mA on the 5V Standby lead (5VSB).

Please install the ATX power according to the following pin assignment:

ATX Power

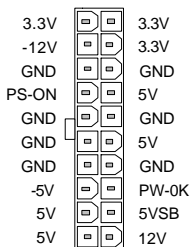



➤ **Pay special care to the directionality.**

Step 14. Select the CPU Burst Mode (J1)

There are two types of CPU burst modes according to manufacturer design:

- Interleave Burst (CPU: Intel P54C/P55C, AMD K5/K6/K6-2, IDT WinChip)
- Linear Burst(CPU: Cyrix 6x86/L/MX/M II)



CPU Burst Mode	Interleave	Linear
	Intel® P54C/P55C AMD™K5/K6/K6-2 IDT WinChip	Cyrix™6x86/L/MX/MII
J1 Setting	When using Intel or AMD CPUs. 	When using Cyrix type of CPU. 

If you are using a Cyrix™6x86/L/MX/M II series CPU, set the burst mode to Linear by shorting jumper J1, and follow the following steps to select the correct Linear burst mode in BIOS:

1. During the boot-up initial sequence, press the [Delete] key to enter the BIOS setup menu.
2. Select the [CHIPSET FEATURES SETUP] section in BIOS.
3. In the [CHIPSET FEATURES SETUP] sub-menu, set the [Linear Burst] field to [Enabled].
4. Press [Esc] to return to the BIOS main menu.
5. Then choose [Save & Exit Setup] to re-boot your computer.

Step 15. CMOS Clearing (JP5)

After you have turned off your computer, clear the CMOS memory by momentarily shorting pins 2-3 on jumper JP5, for a few seconds. Then restore JP5 to the initial 1-2 jumper setting in order to recover and retain the default settings.

CMOS Clearing	Clear CMOS Data	Retain CMOS Data
JP5 Setting	Short pin 2-3 for a few seconds to clear the CMOS 	Short pin 1-2 to retain new settings 
Note: You must unplug the ATX power cable from the ATX power connector when performing the CMOS Clear operation.		

Step 16. Set the Onboard Sound Options (JP9)

The onboard audio features of your Motherboard are controlled by jumpers JP9

Choose the available sound options among the following table:

Sound Settings	JP9
Onboard Sound: Enable	short
Onboard Sound: Disable	open

Step 17. MULTI I/O ADDRESSES

Default settings for multi-I/O addresses are as follows:

Port	I/O Address	IRQ	Status
LPT1	378H	7	ECP + EPP
COM1	3F8H	4	
COM2	2F8H	3	



Warning: If a default I/O address conflicts with other I/O cards such as sound card, you must change one of the I/O addresses to remedy to this address conflict. (I/O addresses can be adjusted from the BIOS Setup Utility)

Step 18. CACHE CONFIGURATION

This Motherboard has a built-in 1MB Level 2 Pipelined Burst cache onboard to improve the system performance. The cacheable system memory size is 128MB.

Step 19. Power On

You have now completed the hardware installation of your Motherboard successfully.

1. Turn the power on
2. To enter the BIOS Setup Utility, press the key while the system is performing the diagnostic checks,



Note: If you have failed to enter the BIOS, wait until the boot up sequence is completed. Then push the RESET button and press key again at the beginning of boot-up, during diagnostic checks.

Repeat this operation until you get the following screen.

3. The BIOS Setup screen appears:

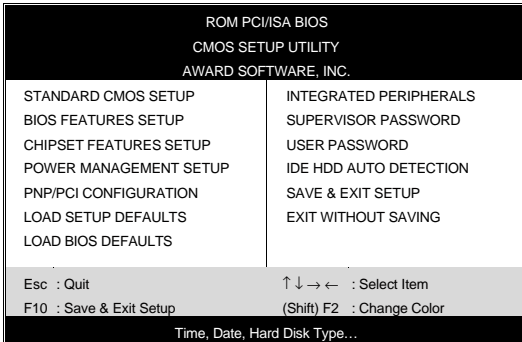

You are now ready to configure your system with the BIOS setup program. Go to Chapter 3: **BIOS SETUP**

Chapter 3

BIOS SETUP UTILITY

This Motherboard's BIOS setup program uses the ROM PCI/ISA BIOS program from Award Software Inc.

To enter the Award BIOS program's Main Menu:

1. Turn on or reboot the system.
2. After the diagnostic checks, press the [Del] key to enter the Award BIOS Setup Utility.

ROM PCI/ISA BIOS CMOS SETUP UTILITY AWARD SOFTWARE, INC.	
STANDARD CMOS SETUP	INTEGRATED PERIPHERALS
BIOS FEATURES SETUP	SUPERVISOR PASSWORD
CHIPSET FEATURES SETUP	USER PASSWORD
POWER MANAGEMENT SETUP	IDE HDD AUTO DETECTION
PNP/PCI CONFIGURATION	SAVE & EXIT SETUP
LOAD SETUP DEFAULTS	EXIT WITHOUT SAVING
LOAD BIOS DEFAULTS	
Esc : Quit	↑↓→← : Select Item
F10 : Save & Exit Setup	(Shift) F2 : Change Color
Time, Date, Hard Disk Type...	

Selecting items

- Use the arrow keys to move between items and select fields.
- From the Main Menu press arrow keys to enter the selected submenu.

Modifying selected items

- Use the [Up]/[Down] keys to modify values within the selected fields. Some fields let you enter values directly.

Hot Keys: Function keys give you access to a group of commands throughout the BIOS utility.

Function	Command	Description
F1	Help	Gives the list of options available for each item.
Shift F2	Color	Change the color of the display window.
F5	Old values	Restore the old values. These are the values that the user started the current session with.
F6	Load BIOS Defaults	Loads all options with the BIOS Setup default values.
F7	Load Setup Defaults	Loads all options with the Power-On default values.
F10	Save & Exit Setup	Saves your changes and reboots the system.
[Esc]	Quit	Lets you return at anytime and from any location to the Main Menu.

SAVE AND EXIT SETUP

Select the [SAVE & EXIT SETUP] option from the Main Menu to save data to CMOS and exit the setup utility. This option saves all your changes and causes the system to reboot.

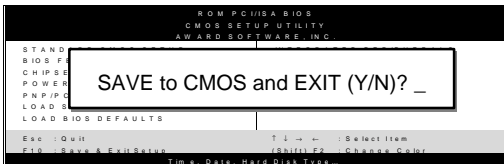

Type [Y] to save the changes and exit or [N] to return to the Main Menu and keep current values.

EXIT WITHOUT SAVING

Selecting the [EXIT WITHOUT SAVING] option allows you to abandon all data and exit setup, therefore ignoring all your changes.

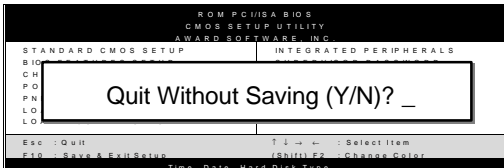

Type [Y] to abandon changes and exit or [N] to return to the Main Menu and keep current values.

3-1 STANDARD CMOS SETUP

Select the [STANDARD CMOS SETUP] option from the Main Menu and press [Enter] key.

ROM PCI/ISA BIOS								
STANDARD CMOS SETUP								
AWARD SOFTWARE, INC.								
Date (mm:dd:yy)	: Fri, May 29 1998							
Time (hh:mm:ss)	: 9 : 42 : 43							
HARD DISKS	TYPE	SIZE	CYLS	HEAD	PRECOMP	LANDZ	SECTOR	MODE
Primary Master	: AUTO	0	0	0	0	0	0	AUTO
Primary Slave	: None	0	0	0	0	0	0	----
Secondary Master	: None	0	0	0	0	0	0	----
Secondary Slave	: None	0	0	0	0	0	0	----
Drive A : 1.44M, 3.5 in.				Base Memory: 640K				
Drive B : None				Extended Memory: 3328K				
Floppy 3 Mode Support : Disabled				Other Memory: 128K				
Video : EGA/VGA				Total Memory: 4096K				
Halt On : All Errors								
Esc : Quit	↑ ↓ → ←	: Select Item			PU/PD/+/-	: Modify		
F1 : Help	(Shift) F2	: Change Color			F3	: Toggle Calendar		

This screen allows you to modify the basic CMOS settings. After you have completed the changes, press [Esc] key to return to the Main Menu.

3-1.1 Date & Time

	Display	Setting	Please Note
Date	mm/dd/yyyy	Type the current date	You can also the PUp/PDn keys to toggle
Time	hh:mm:ss	Type the current time	24-hour clock format 3:15 PM is displayed as 15:15:00

3-1.2 Hard Disks Type & Mode

Choose the type and mode for the hard disks that you have already installed.

Primary (Secondary) Master & Slave	Setting	Description	Note
Type	Auto	BIOS detects hard disk type automatically.	Default
	1-47	Selects standard hard disk type.	
	User	User defines the type of hard disk.	
Mode	Auto	BIOS detects hard disk mode automatically.	Default
	Normal	Normal IDE hard disk	<528MB
	LBA	Enhanced IDE hard disk	>528MB
	Large	Large IDE hard disk (for certain hard disk)	



Note: If you have any questions on your hard disk type or mode, ask your hard disk provider or previous user for details.

3-1.3 Floppy Drives

Floppy Drives	Setting	Description	Note
Drives A & B	360KB, 5.25 in.		
	1.2MB, 5.25 in.		
	720KB, 3.5 in.		
	1.44MB, 3.5 in.		Default
	2.88MB, 3.5 in.		
	None	Not installed	
Floppy 3-Mode Support	Disabled		Default
	Drive A Drive B Both	Supports 3-mode floppy diskette: 740KB/1.25MB/1.44MB on selected disk drive.	Special disk drive commonly used in Japan

3-1.4 Video

Select the video mode: EGA/VGA (Default), CGA 40, CGA 80, Mono (Monochrome).

3-1.5 Halt On

When the BIOS detects system errors, this function will stop the system. Select which type of error will cause the system halt: All Errors (Default), No Errors, All But Diskette, All But Keyboard, All But Disk/Key.

3-2 BIOS FEATURES SETUP

Select the [BIOS FEATURES SETUP] option from the Main Menu and press [Enter] key.

ROM PCI/ISA BIOS	
BIOS FEATURES SETUP	
AWARD SOFTWARE, INC.	
Virus Warning	: Disabled
CPU Internal Cache	: Enabled
External Cache	: Enabled
Quick Power On Self Test	: Enabled
Boot Sequence	: A, C, SCSI
Swap Floppy Drive	: Disabled
Boot Up NumLock Status	: On
Memory Parity /ECC Check	: Enabled
Typematic Rate Setting	: Disabled
Typematic Rate (Chars/Sec)	: 6
Typematic Delay (Msec)	: 250
Security Option	: Setup
PCI/VGA Palette Snoop	: Disabled
Assign IRQ For VGA	: Enabled
OS Select For DRAM > 64MB	: Non-OS2
HDD S.M.A.R.T capability	: Disabled
Report No FDD For WIN 95	: No
Video BIOS Shadow	: Enabled
C8000-CBFFF Shadow	: Disabled
CC000-CFFFF Shadow	: Disabled
D0000-D3FFF Shadow	: Disabled
D4000-D7FFF Shadow	: Disabled
D8000-DBFFF Shadow	: Disabled
DC000-DFFFF Shadow	: Disabled
ESC : Quit ↑ ↓ → ← : Select Item F1 : Help PU/PD/+/- : Modify F5 : Old Values (Shift) F2 : Color F6 : Load BIOS Defaults F7 : Load Setup Defaults	

After you have completed the changes, press [Esc] key and follow the instructions on your screen to save your settings or exit without saving.

3-2.1 Virus Warning

	Setting	Description	Note
Virus Warning	Disabled		Default
	Enabled	Enable this option to protect the boot sectors and partition tables of your hard disk. Any attempt to write to them will the system to halt and display a warning message.	

3-2.2 Cache Memory Options

	Setting	Description	Note
CPU Internal Cache	Disabled		
	Enabled	Enables the CPU's internal cache.	Default
External Cache	Disabled		
	Enabled	Enables the external memory.	Default

3-2.3 System Boot Control Settings

System Boot Control Settings	Setting	Description	Note
Quick Power On Self Test	Disabled		
	Enabled	Provides a fast POTS at boot-up.	Default
Boot Sequence	A, C, SCSI	Choose the boot sequence adapted to your needs, for example: ● [A, C, SCSI] means the BIOS will look for an operating system first in drive A, then in drive C, and eventually in SCSI device.	
	C, A, SCSI		
	C, CD-ROM, A		
	CD-ROM, C, A		
	D, A, SCSI		
	E, A, SCSI		
	F, A, SCSI		
	SCSI, A, C		
	SCSI, C, A		
	C only		
LS/ZIP, C			
Swap Floppy Drive	Disabled		Default
	Enabled	Changes the sequence of A and B drives.	
Boot Up NumLock Status	On	Puts numeric keypad in NumLock mode at boot-up.	Default
	Off	Puts numeric keypad in arrow key mode at boot-up.	
Memory Parity Check/ ECC Check	Enabled	This allows to perform a redundancy check on the parity bit in the data strings. This method is used for error detection when the parity is not found.	Default
	Disabled		

3-2.4 Typematic Settings

Typematic Settings	Setting	Description	Note
Typematic Rate Setting	Disabled		Default
	Enabled	Enables to adjust the keystroke repeat rate.	
The following [Typematic Rate] and [Typematic Delay] fields are active only if [Typematic Rate Setting] is set to [Enabled]			
Typematic Rate (Chars/Sec)	6 (Char/sec)	Choose the rate at which a character is repeated when holding down a key.	Default
	8 (Char/sec)		
	10 (Char/sec)		
	12 (Char/sec)		
	15 (Char/sec)		
	20 (Char/sec)		
	30 (Char/sec)		
Typematic Delay (Msec)	250 (msec)	Choose how long after you press a key down the character begins repeating.	Default
	500 (msec)		
	750 (msec)		
	1000 (msec)		

3-2.5 Other Control Options

Other Control Options	Setting	Description	Note
Security Option	Setup	Use this feature to prevent Unauthorized system boot-up or use of BIOS Setup. "Setup", If a password is set, the password prompt only appears if you attempt to enter the Setup program.	Default
	System	Each time the system is booted the password prompt appears.	
PCI/VGA Palette Snoop	Disabled		Default
	Enabled	The color of the monitor may be altered when using an MPEG card. Enable this option to restore the monitor's normal color.	
Assign IRQ For VGA	Disabled		
	Enabled		Default
OS Select for DRAM>64MB	OS2	When using an OS2 operating system.	
	Non-OS2	When using another, non-OS2 operating system.	Default
HDD S.M.A.R.T. capability	Disabled		Default
	Enabled		
Report No FDD For WIN 95	No	Windows will reserve INT 6 for your FDD, whether it is Disabled or not.	Default
	Yes	Windows will release IRQ line 6 (normally used by the Floppy Disk Drive) after you disable you on-board FDD and set this field to [Yes].	

Other Control Options (Continued)

Other Control Options	Setting	Description	Note
Video or Adapter BIOS Shadow	Disabled		
	Enabled	The BIOS is shadowed in a 16K segment if it is enabled and if it has BIOS present. These 16 segments can be shadowed from ROM to RAM. BIOS shadow copies BIOS code from slower ROM to faster RAM. BIOS can then execute from RAM.	Default

3-3 CHIPSET FEATURES SETUP



Caution: Change these settings only if you are already familiar with the Chipset.

The [CHIPSET FEATURES SETUP] option changes the values of the chipset registers. These registers control the system options in the computer.

ROM PCI/ISA BIOS	
CHIPSET FEATURES SETUP	
AWARD SOFTWARE, INC.	
Auto Configuration	: Enabled
Ref/Act Command Delay	: 6T
Refresh Queue Depth	: 12
RAS Precharge Time	: 3T
RAS to CAS Delay	: 3T
Linear Mode SRAM Support	:Disable
ECC Function Support	: Enabled
AGP Aperture Size	: 64MB
System BIOS Cacheable	: Enabled
Video BIOS Cacheable	: Enabled
Memory Hole at 15M-16M	: Disabled
Spread Spectrum	: Disable
ESC : Quit ↑ ↓ → ← : Select Item F1 : Help PU/PD/+/- : Modify F5 : Old Values (Shift) F2 : Color F6 : Load BIOS Defaults F7 : Load Setup Defaults	

After you have completed the changes, press [Esc] and follow the instructions on your screen to save your settings or exit without saving.

The following table describes each field in the CHIPSET FEATURES SETUP Menu and how to configure each parameter.

CHIPSET FEATURES SETUP

CHIPSET FEATURES	Setting	Description	Note
Auto Configuration	Disabled		
	Enabled	It is strongly recommended to enable this option so that the system automatically sets all chipset feature options on the left panel of the screen (except for cache update & BIOS cacheable).	Default
The following fields are READ-ONLY if [Auto Configuration] is set to [Enabled]			
Ref/Act Command Delay	6T	Set the DRAM clock of the refresh command to refresh/active command delay.	Default
	5T,7T, 8T		
Refresh Queue Depth	12	Set the depth of refresh queue.	Default
	0, 4, 8,		
RAS Precharge Time	3T	The precharge time is the number of cycles it takes for the RAS to accumulate its charge before DRAM refreshes. If insufficient time is allowed, refresh may be incomplete and the DRAM may fail to retain data.	Default
	2T, 4T, 5T		
RAS to CAS Delay	3T 2T,4T,5T	When DRAM is refreshed, both rows and columns are addressed separately. This setup item allows you to determine the timing of the transition from RAS (row address strobe) to CAS (column address strobe).	Default

CHIPSET FEATURES SETUP (Continued)

CHIPSET FEATURES	Setting	Description	Note
Linear Mode SRAM Support	Disable	Select <i>Enabled</i> if your system contains a CPU that requires linear mode (e.g., Cyrix M1/M2 CPU).	Default
	Enable		
ECC Function Support	Disabled	Enable/Disable the ECC (error-correcting code) function support.	
	Enabled		Default
AGP Aperture Size	64MB 4 MB, 8MB, 16 MB, 32 MB, 128 MB, 256 MB	Select the size of the Accelerated Graphics Port (AGP) aperture. The aperture is a portion of the PCI memory address range dedicated for graphics memory address space. Host cycles that hit the aperture range are forwarded to the AGP without any translation.	Default
System BIOS Cacheable	Disabled		
	Enabled	The ROM area F0000H-FFFFFH is cacheable.	Default
Video BIOS Cacheable	Disabled		
	Enabled	The video BIOS C0000H-C7FFFH is cacheable.	Default

CHIPSET FEATURES SETUP (Continued)

CHIPSET FEATURES	Setting	Description	Note
Memory Hole At 15M-16M	Disabled		Default
	Enabled	Some interface cards will map their ROM address to this area. If this occurs, select [Enabled] in this field.	
	0.5-8 MB		
Spread Spectrum	Disabled		Default
	0.25%(Cntr)	When using Spread Spectrum 0.25%(Cntr) for FCC or DOC testing.	
	0.50%(Down)	When using Spread Spectrum 0.50%(Down) for FCC or DOC testing.	

3-4 POWER MANAGEMENT SETUP

The [POWER MANAGEMENT SETUP] sets the system's power saving functions.

ROM PCI/ISA BIOS			
POWER MANAGEMENT SETUP			
AWARD SOFTWARE, INC.			
ACPI function	: Enabled	VGA Activity	: Enabled
Power Management	: User Define	IRQ [2-7,9-15], NMI	: Enabled
Video Off Option	: Susp, Stby -> Off	IRQ 8 Break Suspend	: Disabled
Video Off Method	: V/H SYNC+Blank	Power Button Over Ride	: Instant-Off
Switch Function	: Break/Wake	Power ON by Ring	: Enabled
Doze Speed (div by)	: 2/8		
Standby Speed (div by)	: 1/8	KB Power ON Password	: Enter
MODEM Use IRQ	: 9	power up by Alarm	: Disabled
Hot Key Function AS	: Power Off		
** PM Timers **			
HDD Off After	: Disabled		
Doze Mode	: Disabled		
Standby Mode	: Disabled		
Suspend Mode	: Disabled		
** PM Events **			
HDD Ports Activity	: Enabled	ESC : Quit	↑ ↓ → ← : Select Item
COM Ports Activity	: Enabled	F1 : Help	PU/PD/+/- : Modify
LPT Ports Activity	: Enabled	F5 : Old Values (Shift) F2	: Color
		F6 : Load BIOS Defaults	
		F7 : Load Setup Defaults	

After you have completed the Power Management Setup, press [Esc] to return to the Main Menu.

3-4.1 Power Management Controls

Power Management Controls	Setting	Description	Note
ACPI function	Disabled		Default
	Enabled	Enabled if you use Windows 98 and want to use ACPI	
Power Management	User Define	Lets you define the HDD and system power down times.	
		Doze timer Standby timer Suspend timer	
	Min Saving	40 Min 40 Min 40 Min	
	Max Saving	20 Sec 20 Sec 20 Sec	
Video Off Option	Suspend ->Off	The monitor will be switched off in suspend mode,	Default
	All Modes ->Off	the monitor will be switched off in all power saving modes	
	Always On		
Video Off Method	V/H SYNC+Blank	Selects the method by which the monitor is blanked.	Default
	Blank screen DPMS Supported		
Switch Function	Break/Wake	You can choose whether or not to permit your system to enter complete Suspend mode. Suspend mode offers greater power savings, with a correspondingly longer awakening period.	Default
	Deturbo, Break, Disabled		
Doze Speed (div by)	2/8	Sets the CPU's speed during Doze mode. The speed is reduced to a fraction of the CPU's normal speed.	Default
	1~8		

Power Management Controls (Continued)

Power Management Controls	Setting	Description	Note
Stdby Speed (div by)	1/8	Select a divisor to reduce the CPU speed during <i>Standby</i> mode to a fraction of the full CPU speed. The speed is reduced to a fraction of the CPU's normal speed.	Default
	1~8		
Modem Use IRQ	3	Assigns an IRQ# to the modem device.	Default
	3-11, NA		
Hot Key Function As	Power Off	Enables to power off the system by pressing the appropriate hot-key combination: Ctrl + Alt + ← (BackSpace)	Default
	Disabled		
	Suspend		

3-4.2 PM Timers

PM Timers	Setting	Description	Note
The following [HDD Power Down] field may be configured only if [Power Management] is set to [User Define]			
HDD Off After	Disabled	By default, this item is	Default
	1-15Min	Disabled, meaning that no matter the mode the rest of the system, the hard drive will remain ready. Otherwise, you have a range of choices from 1 to 15 minutes or Suspend.	Some older model HDDs may not support this advanced function.
The following [Doze Mode] field may be configured only if [Power Management] is set to [User Define]			
Doze Mode	Disable		Default
	10Sec 1Min- 4Hour	When the set time has elapsed, BIOS sends a command to the system to enter Doze Mode.	System clock drops to 33MHz.
The following [Standby Mode] field may be configured only if [Power Management] is set to [User Define]			
Standby Mode	Disable		Default
	10Sec 1Min- 4Hour	When enabled and after the set time of system inactivity, all devices except the CPU will be shut off.)	
The following [Suspend Mode] field may be configured only if [Power Management] is set to [User Define]			
Suspend Mode	Disable		Default
	10Sec 1Min- 4Hour	When enabled and after the set time of system inactivity, all devices except the CPU will be shut off.)	

3-4.3 PM Events

PM Events	Setting	Description	Note
HDD Ports Activity	Disabled		
	Enabled	When set to Enabled (default), any event occurring at a HDD (serial) port will awaken a system which has been powered down.	Default
COM Ports Activity	Disabled		
	Enabled	When set to Enabled (default), any event occurring at a hard or floppy drive port will awaken a system which has been powered down.	Default
LPT Ports Activity	Disabled		
	Enabled	When set to Enabled (default), any event occurring at a LPT (printer) port will awaken a system which has been powered down.	Default
VGA Activity	Disabled		Default
	Enabled	When set to Enabled (default), any event occurring at VGA will awaken a system which has been powered down.	
<p><i>The IRQ's, Interrupt ReQuests, which can be exempted much as the COM ports and LPT ports above can. When an I/O device wants to gain the attention of the operating system, it signals this by causing an IRQ to occur. When the operating system is ready to respond to the request, it interrupts itself and performs the service.</i></p> <p>When set Enabled, activity will neither prevent the system from going into a power management mode nor awaken it.</p>			
IRQ [3-7,9-15], NMI	Disabled		
	Enabled		Default

PM Events (Continued)

PM Events	Setting	Description	Note
IRQ 8 Break Suspend	Disabled		Default
	Enabled	You can <i>Enable</i> or <i>Disable</i> monitoring of IRQ8 (the Real Time Clock) so it does not awaken the system from Suspend mode.	
Power Button Over Ride	Delay 4 Sec	You could press the power button for more than 4 seconds forces the system to enter the Soft-Off state when the system has "hung."	
	Instant-Off		Default
Power ON by Ring	Disabled		
	Enabled	When you select <i>Enabled</i> , a signal from ring returns the system to Full On state.	Default
KB Power ON Password	Enter	When you set a password for keyboard, The password you set the keyboard that returns the system to Full On state.	Default
Power Up by Alarm	Disabled		Default
	Enabled	When you select <i>Enabled</i> , the following fields appear. They let you set the alarm that returns the system to Full On state.	

3-5 PNP/PCI CONFIGURATION SETUP

This option sets the Motherboard's PCI Slots.

ROM PCI/ISA BIOS			
PNP/PCI CONFIGURATION SETUP			
AWARD SOFTWARE, INC.			
Resources Controlled By	: Manual	PCI IRQ Activated By	: Level
Reset Configuration Data	: Disabled	Assign IRQ For USB	: Enabled
IRQ-3 assigned to	: Legacy ISA	Slot 1 Use IRQ No.	: Auto
IRQ-4 assigned to	: Legacy ISA	Slot 2 Use IRQ No.	: Auto
IRQ-5 assigned to	: PCI/ISA PnP	Slot 3 Use IRQ No.	: Auto
IRQ-7 assigned to	: Legacy ISA	Slot 4 Use IRQ No.	: Auto
IRQ-9 assigned to	: PCI/ISA PnP		
IRQ-10 assigned to	: PCI/ISA PnP		
IRQ-11 assigned to	: PCI/ISA PnP		
IRQ-12 assigned to	: PCI/ISA PnP		
IRQ-14 assigned to	: Legacy ISA		
IRQ-15 assigned to	: Legacy ISA		
DMA-0 assigned to	: PCI/ISA PnP		
DMA-1 assigned to	: PCI/ISA PnP		
DMA-3 assigned to	: PCI/ISA PnP	ESC : Quit	↑ ↓ → ← : Select Item
DMA-5 assigned to	: PCI/ISA PnP	F1 : Help	PU/PD/+/- : Modify
DMA-6 assigned to	: PCI/ISA PnP	F5 : Old Values	(Shift) F2 : Color
DMA-7 assigned to	: PCI/ISA PnP	F6 : Load BIOS Defaults	
		F7 : Load Setup Defaults	



Note: Starred (*) items will disappear when the [Resources Controlled By] option is set to [Auto].

After you have completed the PCI Slot Configuration, press [Esc] and follow the instructions on your screen to save your settings or exit without saving.

3-5.1 PNP/PCI Configuration Controls

PNP/PCI Controls	Setting	Description	Note
Resources Controlled By	Manual	BIOS does not manage PCI/ISA PnP card IRQ assignment. Requires to assign IRQ-# and DMA-# to PCI or ISA PnP manually. IRQ-3,4,5,7,9,10,11,12,14,15 assigned to: _ DMA-0,1,3,5,6,7 assigned to: _	
	Auto	The Plug-and-Play BIOS auto manages PCI/ISA PnP card IRQ assignment automatically.	Recommended
Reset Configuration Data	Disabled	Retain PnP configuration data in BIOS.	Default
	Enabled	Reset PnP configuration data in BIOS.	

3-5.2 PNP/PCI Configuration Setup

PNP/PCI Setup	Setting	Description	Note
If [Resources Controlled By] is set to [Manual]			
IRQ-# and DMA-# assigned to:	PCI/ISA PnP	Choose IRQ-# and DMA-# assigned to PCI/ISA PnP card.	IRQ-3,4,5,7,9,10,11,12,14,15 DMA-0,1,3,5,6,7
	Legacy ISA	Choose IRQ-# and DMA-# assigned to Legacy ISA card.	IRQ-3,4,5,7,9,10,11,12,14,15 DMA-0,1,3,5,6,7
PCI IRQ Activated No.	Level	This sets the method by which the PCI bus recognizes that an IRQ service is being requested by a device.	Default
	Edge		
Assign IRQ For USB	Disabled		
	Enabled	Enable RSB IRQ	Default

3-5.3 PNP/PCI Configuration Setup

PNP/PCI Setup	Setting	Description	Note
Under this item the user can assign an IRQ to a PCI slot. However, there under some conditions the IRQ will not be assigned as selected under this item:			
1. IRQs 0, 1, 2, 6, 8, 13 can NOT be assigned, because they are fixed.			
2. IRQs 5, 9, 10, 11 are available			
3. IRQs 3,4,7,12,14 and 15 will only be assigned if they are free. See the table below on how to free them:			
Interrupt Line	How to set the BIOS to release the IRQ to the PnP Interrupt pool:		
	PnP / PCI configuration	Integrated Peripherals	
IRQ 15	IRQ 15: PCI / ISA PnP	On-Chip Secondary PCI IDE:	disabled
IRQ 14	IRQ 14: PCI / ISA PnP	On-Chip Primary PCI IDE:	disabled
IRQ 12	IRQ 12: PCI / ISA PnP	<i>Interrupt 12 will be released by the PnP BIOS automatically if the PS/2 Mouse Port is not used.</i>	
IRQ 7	IRQ 7: PCI / ISA PnP	Onboard parallel port:	disabled
IRQ 4	IRQ 4: PCI / ISA PnP	Onboard Serial port 1:	disabled
IRQ 3	IRQ 3: PCI / ISA PnP	Onboard Serial port 2:	disabled
4. Your OS may reassign another interrupt to a PCI slot after BIOS passes control to the OS, especially if you use Windows 95, 98 or NT.			
Slot 1/2/3/4 Use IRQ NO.	Auto		Default

3-6 LOAD SETUP DEFAULTS

Select the [LOAD SETUP DEFAULTS] option from the Main Menu to load the system values you have previously saved. This option is recommended if you need to reset the system setup and to retrieve the old values.

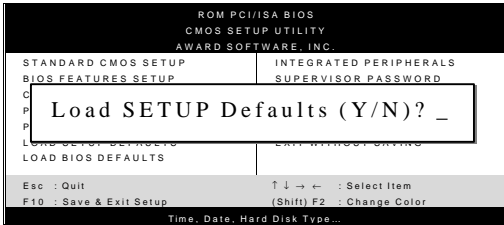

Type [Y] to use the Setup Defaults followed by [Enter] or otherwise [N] to return to the Main Menu and keep current values.

3-7 LOAD BIOS DEFAULTS

Select the [LOAD BIOS DEFAULTS] option from the Main Menu to load the system default values. BIOS Defaults values are adjusted to yield high performance.

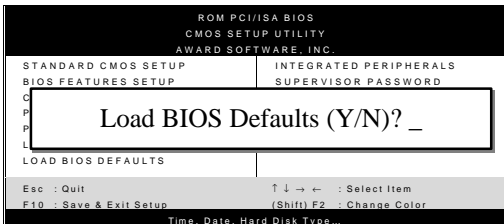

Type [Y] to use the Setup Defaults followed by [Enter] or otherwise [N] to return to the Main Menu and keep current values.



Warning: If you run into any problems after loading BIOS DEFAULTS, please load the SETUP DEFAULTS for stable performance.

3-8 INTEGRATED PERIPHERALS



Caution: Change these settings only if you are already familiar with the Chipset.

The [INTEGRATED PERIPHERALS] option changes the values of the chipset registers. These registers control the system options in the computer.

The following screen shows default settings.

ROM PCI/ISA BIOS			
INTEGRATED PERIPHERALS			
AWARD SOFTWARE, INC.			
Internal PCI/IDE	: Both	Onboard Parallel Port	: 378
IDE Primary Master PIO	: Auto	Parallel Port Mode	: SPP
IDE Primary Slave PIO	: Auto		
IDE Secondary Master PIO	: Auto	PS/2 mouse function	: Enabled
IDE Secondary Slave PIO	: Auto	USB Controller	: Enabled
Primary Master UDMA	: Auto	USB Keyboard Support	: Disabled
Primary Slave UDMA	: Auto		
Secondary Master UDMA	: Auto	Init Display First	: PCI Slot
Secondary Slave UDMA	: Auto	VGA Shared Memory Size	: 2 MB
IDE Burst Mode	: Enabled	Current CPU Temperature	: 28 ½ C / 82 ½ F
IDE Data Port Post Write	: Disabled	Current FAN1 Speed	: 0 RPM
IDE HDD Block Mode	: Enabled	Current FAN2 Speed	: 0 RPM
Onboard FDC Controller	: Enabled	+12 (V) :	0 V +5(v) : 0 V
Onboard Serial Port 1	: 3F8/IRQ4	3.3 (V) :	0 V vcc(v) : 0 V
Onboard Serial Port 2	: 2F8/IRQ3		
IR Address Select	: Disabled	ESC : Quit	↑ ↓ → ← : Select Item
		F1 : Help	PU/PD/+/- : Modify
		F5 : Old Values	(Shift) F2 : Color
		F6 : Load BIOS Defaults	
		F7 : Load Setup Defaults	

The following tables describe each field in the INTEGRATED PERIPHERALS Menu and provide instructions on how to configure the IDE controls, FDC controls, and the onboard serial and parallel ports.

3-8.1 IDE Device Controls

IDE Controls	Setting	Description	Note
Internal PCI/IDE	Both	Selects which PCI IDE controller to use.	Default
	Disabled		
	Primary		
	Secondary		
The following fields may be configured only if [Internal PCI/IDE] is set to [Both], [Primary], or [Secondary].			
IDE > Primary Master PIO > Primary Slave PIO > Secondary Master PIO > Secondary Slave PIO > Primary Master UltraDMA > Primary Slave UltraDMA > Secondary Master U-DMA > Secondary Slave U-DMA	Mode 0-4	0 is the slowest speed 4 is the fastest speed	
	Auto	For better performance and stability, we suggest you use the Auto setting to set the HDD control timing.	Default
	Disabled		
	Auto	Select Auto to enable Ultra DMA Mode support.	Default
The following field may be configured only if [Internal PCI/IDE] is set to [Both], [Primary], or [Secondary].			
IDE Burst Mode	Disabled		
	Enabled	Select this option if your hard disk support this function.	Default
IDE Data Port Post Write	Disabled		
	Enabled	Select this option if your hard disk support this function.	Default
IDE HDD Block Mode	Disabled		
	Enabled	Invokes multi-sector transfer instead of one sector per transfer. Not all HDDs support this function.	Default

3-8.2 FDC Controls

FDC Controls	Setting	Description	Note
Onboard FDC controller	Disabled	Turn off the on-board floppy controller	
	Enabled	Use the on-board floppy controller	Default

3-8.3 Onboard Serial Ports

Onboard Serial Ports	Setting	Description	Note
Onboard Serial Port 1 Onboard Serial Port 2	Disabled		
	3F8/IRQ4	Choose serial port 1 & 2's I/O address.	Default (port 1)
	2F8/IRQ3	Do not set port 1 & 2 to the same address except for Disabled or Auto.	Default (port 2)
	3E8/IRQ4		
	2E8/IRQ3		
Auto			

3-8.4 IR Address

IR Address	Setting	Description	Note
IR Address Select	Disabled		Default
	3F8H, 2F8H, 3E8H, 2E8H	Select IR address.	

3-8.5 Onboard Parallel Ports

Onboard Parallel Ports	Setting	Description	Note
Onboard Parallel Port	378	Choose the printer I/O address.	Default
	Disabled		
	3BC		
	278		

3-8.6 Parallel Ports

Parallel Ports	Setting	Description	Note
Parallel Port Mode	ECP + EPP	The mode depends on your external device that connects to this port.	Default
	Normal		
	EPP		
	ECP		

3-8.7 PS/2 mouse Controls

PS/2 mouse Controls	Setting	Description	Note
PS/2 mouse function	Disabled	If your system has a PS/2 mouse port and you install a serial pointing device, select <i>Disabled</i> .	Default
	Enabled		

3-8.8 USB Controls

USB Controls	Setting	Description	Note
USB Controller	Disabled	Select <i>Enabled</i> if your system contains a Universal Serial Bus (USB) controller and you have USB peripherals.	Default
	Enabled		
USB Keyboard Support	Disabled	Select Enabled if your system contains a Universal Serial Bus (USB) controller and you have a USB keyboard.	Default
	Enabled		

3-8.9 Init Display Controls

Init Display Controls	Setting	Description	Note
Init Display First	PCI Slot	Choose which card – AGP Display card or PCI VGA card – to initialize first.	Default

3-8.10 VGA Shared Control Setting

VGA Shared Control Setting	Setting	Description	Note
VGA Shared Memory Size	2 MB 4-8 MB None	VGA memory size shared with system memory.	Default

3-8.11 CPU Device Monitoring

CPU Device Monitoring	Setting	Description	Note
Current CPU/System Temperature	°C/°F	Show the current status of CPU temperature.	
Current FAN1/ FAN2 Speed	1/2 RPM	These fields display the <i>current</i> speed of up to two fans, if your computer contains a monitoring system.	
+12V,3.3V, +5V,Vcore	V	These fields display the <i>current</i> voltage of up to seven voltage input lines, if your computer contains a monitoring system.	

3-9 SUPERVISOR PASSWORD

Based on the setting you have made in the [Security Option] of the [BIOS FEATURES SETUP] section, the password prevents access to the system or the setup program by unauthorized users. Follow this procedure to set a new password or disable the password:

1. Choose [BIOS FEATURES SETUP] in the Main Menu and press [Enter]. Select the [Security Options] item and set the field to:
 - a. [System]: The password is required every time the system is booted. This means only a person who knows the password can use this computer.
 - b. [Setup]: The password is required only when you attempt to enter the BIOS Setup program.
2. Choose [SUPERVISOR PASSWORD] from the Main Menu and press [Enter]. The following prompt appear:

Enter Password:



Warning: If you forget or lose the password, the only way to access the system is to set jumper JP5 to clear the CMOS RAM. All setup information is lost and you must run the BIOS setup program again.



Note: If you do not wish to use the password function, press [Enter] directly and the following message appears:

Password Disabled!!

- 3. Enter your new password and press [Enter]. The following message appears, prompting to confirm the new password:

Confirm Password:

- 4. Re-enter your password and then press [Enter] to exit to the Main Menu.

This diagram outlines the password selection procedure:

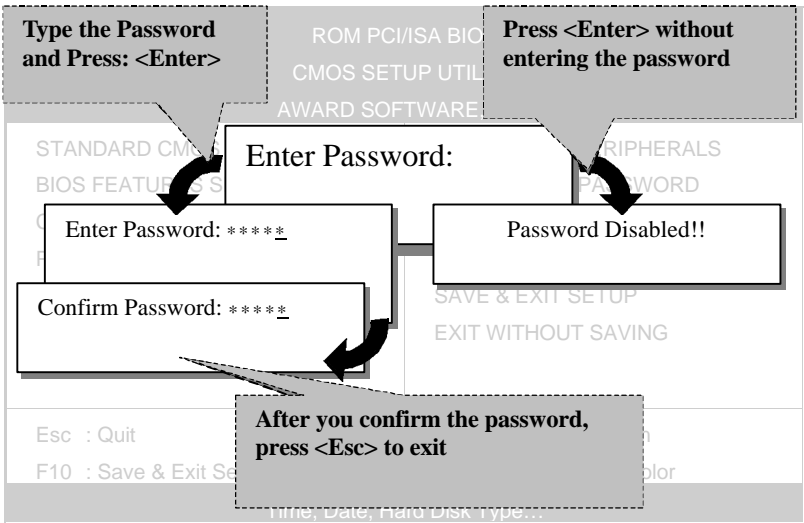

3-10 USER PASSWORD

When the user password option is on, you are not allowed to change any setting in the [CMOS SETUP UTILITY] except for changing the user's password.

The password setting procedure is similar to that for the [SUPERVISOR PASSWORD] (Refer to section 3-9).

3-11 IDE HDD AUTO DETECTION

This Main Menu function automatically detects the hard disk type and configures the STANDARD CMOS SETUP accordingly.

**ROM PCI/ISA BIOS
CMOS SETUP UTILITY
AWARD SOFTWARE, INC.**

HARD DISKS TYPE SIZE CYLS HEAD PRECOMP LANDZ SECTOR MODE

Primary Master :

Select Primary Master Option (N=Skip) : N

OPTIONS	SIZE	CYLS	HEAD	PRECOMP	LANDZ	SECTOR	MODE
2(Y)	1707	827	64	0	3308	63	LBA
1	1707	3309	16	65535	3308	63	NORMAL
3	1707	827	64	65535	3308	63	LARGE

Note: Some Oses(SCO-UNIX Before v5.0) must use "NORMAL" for installation

ESC : Skip



Note: This function is only valid for IDE type of hard disk drives.

Chapter 4

DRIVERS INSTALLATION

Your SY-5SSM Super 7™ Motherboard comes with a CD-ROM labeled "SOYO CD." The SOYO CD contains the user's manual file for your new Motherboard, the drivers software available for installation, and a database in HTML format with information on SOYO Motherboards and other products.

Step 1. Insert the SOYO CD into the CD-ROM drive. The SOYO CD will auto-run, and the SOYO CD Start Up Menu will display as shown below.

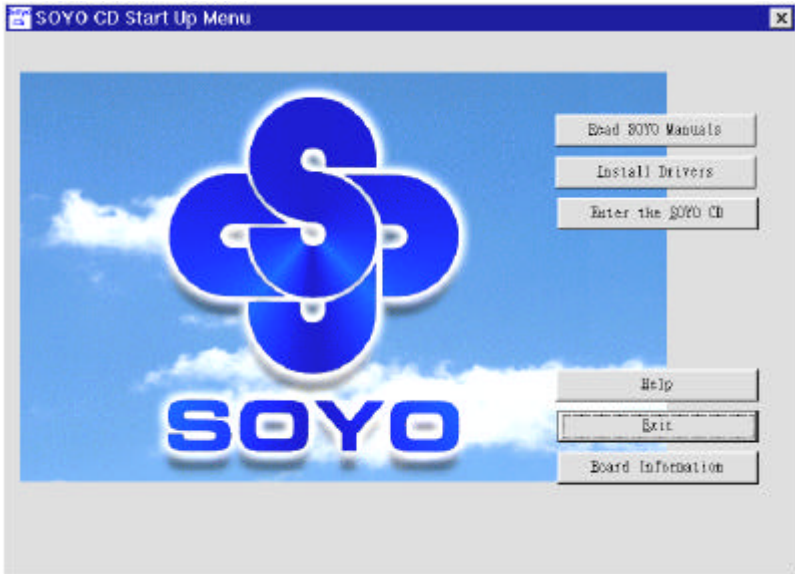

(SOYO CD Start Up Program Menu)

The SOYO CD Start Up Program automatically detects which SOYO Motherboard you own and displays the corresponding model name.

Step 2. Install Drivers and Utilities

Click the Install Drivers button to display the list of drivers software that can be installed with your Motherboard. The Start Up program displays the drivers available for the particular model of Motherboard you own.

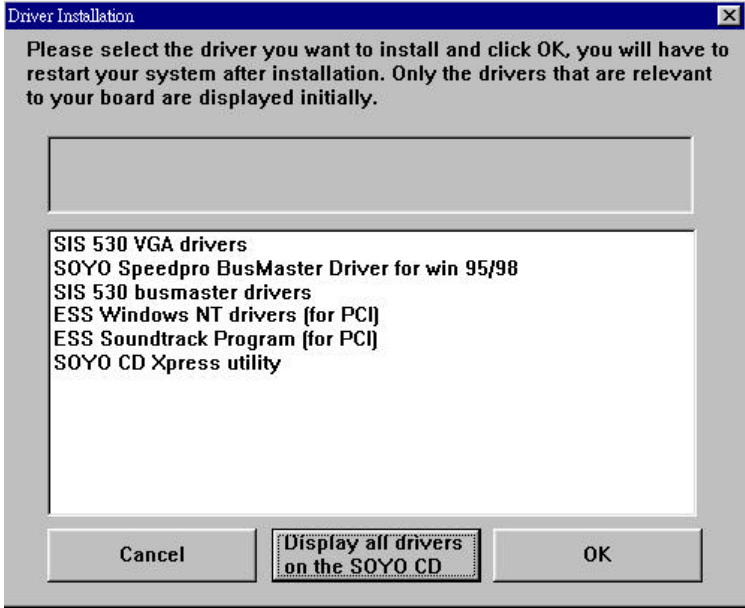

(Driver Installation Menu)

We recommend that you only install those drivers. A short description of all available drivers follows:

➤ **SiS 530 VGA drivers**

The SiS VGA driver for windows 95/98 must be installed to make use of your on board VGA function. (For WinNT read the instructions in back of the Manual)

➤ **SOYO SpeedPro BusMaster Driver for Windows 95/98**

Without the busmaster drivers the CPU will need to be involved every time data is read from or written to the Harddisk. The busmaster drivers make use of DMA (Direct Memory Access) to relieve the CPU of this burden, thus speeding up the system. The SOYO SpeedPro driver makes use of an advanced caching algorithm, which gives it an advantage over other busmaster drivers.



Note: If you install the SOYO SpeedPro busmaster drivers, you can NOT install the SiS busmaster drivers.

➤ **SiS 530 busmaster drivers**

The SiS Busmaster drivers for Windows 95/98 will speed up your harddisk. Only install ONE type of busmaster driver and first uninstall your previous busmaster drivers before installing a new version. (For Windows NT read the instructions in the back of the Manual)

➤ **ESS Windows NT drivers (for PCI)**

These are the Windows NT drivers for the on board soundchip. Make sure to first install these drivers before installing the ESS Soundtrack Program. For the Windows 95/98 ESS drivers please read the installation steps in the back of this manual.

➤ **ESS Soundtrack Program (for PCI)**

With this application program the user can make use of the on board sound chip. Before installing the ESS Soundtrack Program, you MUST first install the ESS drivers for Windows 9x or NT.

➤ **SOYO CD Xpress utility**

This utility will enhance your CD-ROM Drive data-throughput by using space on the Harddisk as cache. This way application programs can access data faster. This utility is suitable for Windows 95/98.

Select which driver you want to install and click **OK**, or click **Cancel** to return to the main menu. When the installation program of a driver starts running the SOYO-CD will exit. After finishing the installation, restart the SOYO-CD and install the next driver.

Note: Once you have selected a driver, the system will automatically exit the SOYO CD to begin the driver installation program. When the installation is complete, most drivers require to restart your system before they can become active.

If you want to see all the drivers available on the SOYO –CD, click the Display all drivers on the SOYO CD button. Do NOT install drivers that are not suitable for your board, otherwise your system may crash.

Step 3. Enter the SOYO CD

Click the **Enter SOYO CD** button to enter the SOYO HTML database. The Start Up program will activate the default HTML browser installed on your system (for example, Internet Explorer or Netscape) to visualize the contents of the SOYO CD.

The SOYO CD contains useful information about your Motherboard and other SOYO products available in as many as eleven different languages. For your convenience, this information is available in HTML format, similar to the format widely used on the Internet.

**(SOYO CD HTML Database in English*)**

(* The list of menu options may vary between languages)

Note: If no HTML browser is installed on your system, the Start Up program will prompt you on whether or not you would like to install the Internet Explorer* browser. Click YES to install the HTML browser. After the installation is complete, please restart your system. Then re-run the SOYO CD and you will be able to browse the SOYO HTML database.

(* Internet Explorer is a Microsoft Trademark)

Chapter 5

Onboard VGA and Audio

5-1 Onboard VGA

This Motherboard offers an onboard Video Graphics Accelerator (VGA), provided by the SiS530 chipset and related application programs.

Note: Please refer to Chapter 5 - *SiS VGA Driver Installation* for a detailed procedure on how to install the video driver depending on the particular environment (Win NT 4.0, Win 95/98) installed on your system.

Features

- Shared system memory area: 2MB to 8MB
- Support 32-bit AGP 1.0 bus standard
- Built-in 64-bit BITBLT graphics engine
- Built-in programmable 24-bit true-color RAMDAC
- Support SGRAM/SDRAM
- Support the super high resolution graphics modes:
 - ◆ 640x480 4/8/16/32 bpp @85Hz NI
 - ◆ 800x600 8/16/32 bpp @ 85Hz NI
 - ◆ 1024x768 8/16/32 bpp @ 85Hz NI
 - ◆ 1280x1024 8/16/32 bpp @ 85 Hz NI (32-bpp mode for local frame buffer only)
 - ◆ 1600x1200 8/16 bpp @ 256 colors 85Hz NI (16-bpp mode for local frame buffer only)
 - ◆ Supports virtual screen up to 2048x2048
 - ◆ Supports 80/132 columns text modes

Video Functions

- Support single frame buffer architecture to save the DRAM cost
- Support graphics/video overlay function by color-key and/or chroma-key operations
- Support multi-format Video For windows such as YUV420, YUV422, RGB565, and RGB555
- Support YUV-to-RGB color space conversion
- Support Microsoft Video For Windows
- Support DCI Drivers
- Support Direct Draw Drivers
- Support Direct MPEG Drivers

Connecting to the VGA Port

To connect your computer screen, attach one end of the video cable supplied with your VGA monitor to the corresponding port at the back of the monitor and plug the other end into the 15-pin VGA port at the back panel of the Motherboard.

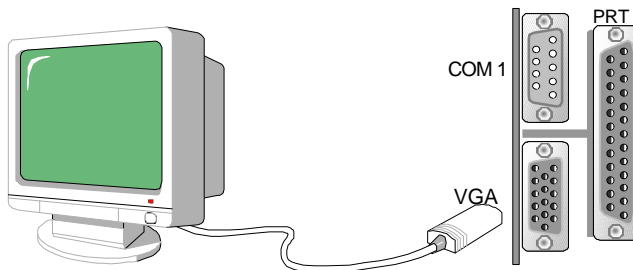

5-2 Onboard Joystick Port

A joystick, in computer graphics, is a lever with at least two degrees of freedom used as an input device. The joystick is normally used as a locator in at least a 2-D plane.

The joystick device is most widely used in video games applications. Attach the joystick cable to the 15-pin JOYSTICK port at the rear panel of your Motherboard.

5-3 Onboard Audio

This Motherboard features three built-in audio-stereo ports (labeled line-in, line-out, and mic jack) convenient to directly plug-in all your external audio devices. Your SY-5SSM Motherboard is making use of the ES1938 sound chipset technology and applications programs.

Note: Please refer to *Chapter 7- ES1938 Audio Driver Installation* for a detailed procedure on how to install the audio driver depending on the particular environment (DOS, Win NT 4.0, Win 9x, Win 3.1) installed on your system.

Features

- Single, high performance, mixed-signal, 16-bit stereo VLSI chip
- PCI bus specification, revision 2.1
- Full native DOS games compatibility, via three technologies:
 - TDMA
 - DDMA
 - PC/PCI
- High-Quality ESFM music synthesizer
- Dynamic range (SNR) over 80 dB
- Integrated Spatializer ® 3-D audio effects processor

Software Support

- Windows 3.1
- Windows 95/98
- Windows NT 4.0
- Windows Sound System
- All DOS-based Games

Compatibility

- Sound Blaster™
- Sound Blaster Pro™
- Sound Blaster 16™ Emulation
- Windows Sound System™

Connecting your Audio Devices

You can connect audio devices to the following ports:

- headphones or pre-amplified speakers to the "line-out" port;
- a line-in device such as CD/Cassette player to the "line-in" port;
- a microphone to the "mic" port.

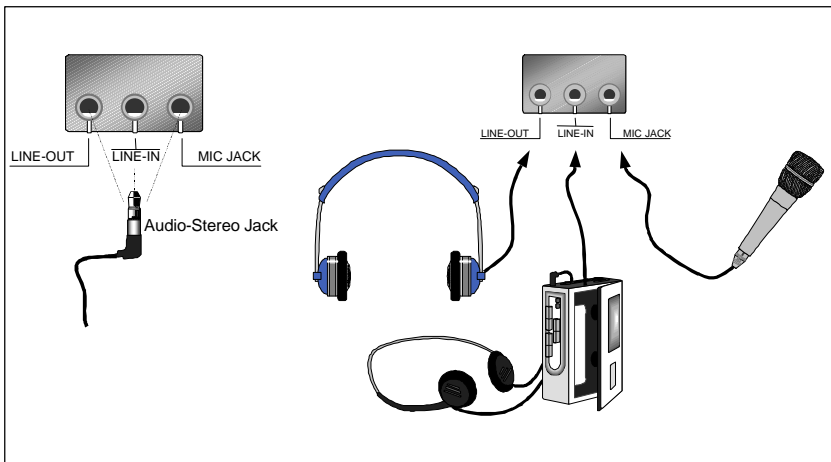

Connecting Speakers

You can connect external speakers to the "Line-out" port on your SY-5SSM Motherboard.

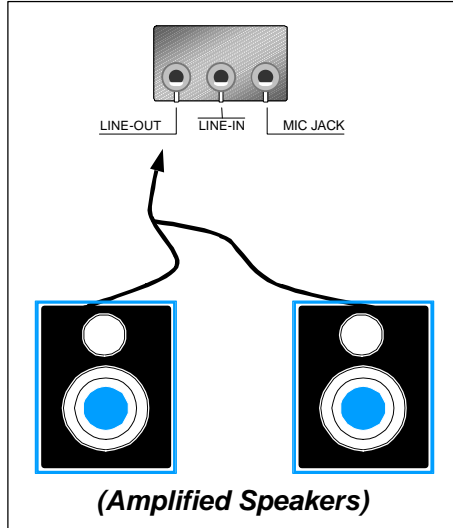

Note: This Motherboard requires a speaker with **built-in amplifier (Amplified Speaker)** to generate proper output sound volume.

Using the ESS Audio Driver

To access the ESS TMSound Mixer audio driver controls, follow these steps:

1. Open the Windows 95/98 **[Start]** menu.
2. Select **[Programs]**, **[Accessories]**, and **[Multimedia]** path.
3. Find and click the **[Volume Control]** option to run the application.

The audio control panel appears as shown in the following figure. The audio mixer gives control of the sound inputs of all audio devices. You can adjust the internal volume and balance of each individual audio device. Also, this audio mixer lets you apply ave sound effects.



Important: The **[Playback]** volume controls the master output sound volume of your system. Depending on the speaker you use you will need to adjust both the volume control on the speaker itself and the audio volume control menu under Windows 95/98 to get the proper sound output.

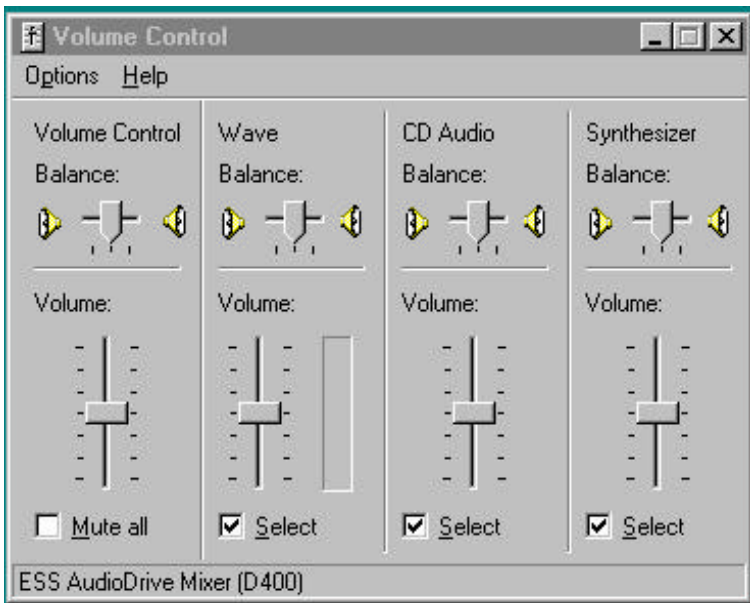

Chapter 6

SIS VGA DRIVER INSTALLATION

Introduction

Your SY-5SSM Motherboard is equipped with the SiS530 chipset that offers extended graphics and text modes capabilities. To make use the advanced features of the SiS530 chipset, you will need to install software drivers and application programs included on the CD-ROM.

This section describes how to perform the SiS VGA driver installation for **Microsoft Windows NT** environment. The Windows 95/98 drivers can be installed automatically through the SOYO CD. Refer to page 16. For other application programs, and if you are using an operating system other than WinNT, please refer to the *SiS VGA Driver Installation* section in *SY-5SSM Motherboard User's Guide and Technical Reference* online manual included on the CD-ROM.

Windows NT Drivers

Driver Files

The enclosed SiS 530 Windows NT drivers files are:

- ◆ **SiS530.INT**
- ◆ **SiS530P.SYS**
- ◆ **SiS530V.DII**

All the 16-color, 256-color, 32K/64K-color, and 16M-color drivers are available.

Installation

1. Click [Start] menu and select [Control Pane] from Settings group.
2. Select [Display] icon.

3. Select [Settings] index in the display properties sheet.
4. Select [Change Display Type] button.
5. Select [Change ..] button in [Adapter Type] group.
6. Select [Have Disk] button.
7. Place CD-ROM disk into the CD drive.
8. When the [Install from Disk] dialog box appears, type the directory storing the drivers and click [OK]. The directory in the CD-ROM is at
D:\DRIVER\SI530VGA\WINNT40.
9. The [Select Device] dialog box will appear, showing the driver. Click on [OK] and the driver will be installed.
10. Select [Close] or [Apply] button from display properties sheet.
11. A message will appear stating you must restart the Windows 95 system, select [Yes] to restart.
12. After restarting, Windows 95 will run on 640x480x256 color, 75NI.

Selecting Resolution, Color Depth and Refresh Rate

1. Click [Start] menu and select Control Panel from Settings group.
2. Select Display icon.
3. Select Settings.
4. Select Color Palette to change between 16 colors, 256 colors, Hi color, and True color.
5. To select desktop resolution size, go to the Desktop area and use the slide bar to change resolution from 640x480, 800x600, 1024x768, and 1280x1024.
6. Select Display Modes.
7. Select value in Refresh rate list box to change the screen refresh rate.
8. Click [OK] or [Apply].

Chapter 7

ESS TMAUDIO DRIVER INSTALLATION

This section describes how to perform the ESS TMaudio driver installation in **Windows® 95/98** environment. The Windows NT drivers can be installed automatically through the SOYO CD. Refer to page 16.

After first installing Windows® 95/98, follow these steps:

1. From the desktop, click [Start] menu and select [Control Panel] from [Settings] group.
2. Select the [System] icon.
3. Select the [Device Manager] tab; use the scroll bar to locate the following devices and, if these entries exist, remove them:

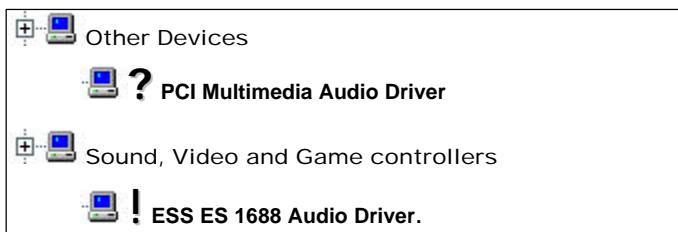

Note: To remove a device, highlight the item you want to take out from your system and press the [Remove] button.

4. Then, click [Refresh].
5. Insert the SOYO CD into the CD-ROM drive.
6. When the “Update Driver Wizard” appears, click [Next].
7. The installation wizard will prompt you on the location of the new audio driver you want to install. Click [Other Location].
8. Click the [Browse] button.
9. Select the “D:\DRIVERS\ESS-PCI\Win9x” path, and click [OK].
10. Now let Windows® 95/98 automatically copy the .inf driver files and configure the ESS sound chip.

This completes the Windows® 95/98 installation. The program will continue to load and when it is complete, you should hear the Windows® 95/98 start-up wave file.

