

# 5SMM

## USER'S MANUAL

- ❑ Support Intel Pentium, MMX, Cyrix/IBM 6x86MX, MII, AMD K6, K6-2, K6-III & IDT Winchip II CPUs.
- ❑ Support auto detect four positive Voltages and Fan Speed.
- ❑ Support 66/75/83/90/95 MHz and 100MHz.
- ❑ System power on by Keyboard: If your ATX power supply supports 300 mA 5V Stand-By current(dependent on the specification of keyboards), you can power on your system by entering password from the Keyboard after setting the "Keyboard power on" jumper (JP2) and password in CMOS Setup.
- ❑ Support Modem Ring On .(Include internal Modem and external modem on COM A )
- ❑ Support Wake on Lan(The ATX power supply supports larger than 720 mA 5V Stand-By current).
- ❑ ESS SOLO-1 ES1938S PCI Sound On Board.
- ❑ Integrated 2D/3D super AGP VGA.
- ❑ Support shared memory for Video Display; When shared memory is used, the system memory (SDRAM DIMM) must be installed in DIMM 1; ⌘
- ❑ Support Ultra DMA 33/66.

Pentium<sup>®</sup> Processor PCI - ISA BUS MAINBOARD  
REV. 1.2 Second Edition

R-12-02-090505



The author assumes no responsibility for any errors or omissions which may appear in this document nor does it make a commitment to update the information contained herein.

\*THIRD-PARTY BRANDS AND NAMES ARE THE PROPERTY OF THEIR RESPECTIVE OWNERS.

May. 5, 1999 Taipei, Taiwan

---

**I. CPU Jumper Setting Table:**

SW: CPU INT./ EXT. FREQ. RATIO

O: ON

X: OFF

SW2	4	5	6	7	8	SW2	4	5	6	7	8
1.3V	X	X	X	X	O	2.5V	O	X	O	X	X
1.4V	X	O	X	X	O	2.6V	X	O	O	X	X
1.5V	X	X	O	X	O	2.7V	O	O	O	X	X
1.6V	X	O	O	X	O	2.8V	X	X	X	O	X
1.7V	X	X	X	O	O	2.9V	O	X	X	O	X
1.8V	X	O	X	O	O	3.0V	X	O	X	O	X
1.9V	X	X	O	O	O	3.1V	O	O	X	O	X
2.0V	X	O	O	O	O	3.2V	X	X	O	O	X
2.1V	O	X	X	X	X	3.3V	O	X	O	O	X
2.2V	X	O	X	X	X	3.4V	X	O	O	O	X
2.3V	O	O	X	X	X	3.5V	O	O	O	O	X
2.4V	X	X	O	X	X	---	---	---	---	---	---

SW2	1	2	3
X1.5	X	X	X
X2	O	X	X
X2.5	O	O	X
X3	X	O	X
X3.5	X	X	X
X4	O	X	O
X4.5	O	O	O
X5	X	O	O
X5.5	X	X	O

**SW 1 :**

<b>CPU</b>	<b>SDRAM</b>	<b>PCI</b>	<b>1</b>	<b>2</b>	<b>3</b>	<b>4</b>
66.8	66.8	33.4	O	O	O	X
75	75	30	X	O	O	X
83.3	83.3	33.3	O	X	O	X
95	95	31.7	X	X	O	X
100	100	33.4	O	O	X	X
112	112	37.3	X	O	X	X
124	124	31	O	X	X	X
133	133	33.3	X	X	X	X
90	90	30	O	O	O	O
83	55.5	33.3	X	O	O	O
95	63.3	31.7	O	X	O	O
66.8	100	33.3	X	X	O	O
105	105	35	O	O	X	O
112	74.7	37.3	X	O	X	O
124	82.7	31	O	X	X	O
133.3	88.9	33.3	X	X	X	O

◆Note: It's strongly recommended that set the system speed according to your hardware configuration: CPU, SDRAM, Cards, etc.

**II. Quick Installation Guide:****O: ON****X: OFF**

SWITCH		SW 2								SW 1			
CPU	SW	S1	S2	S3	S4	S5	S6	S7	S8	1	2	3	4
1. Pentium <sup>®</sup> 133 MHz		O	X	X	O	O	O	O	X	O	O	O	X
2. Pentium <sup>®</sup> 166 MHz		O	O	X	O	O	O	O	X	O	O	O	X
3. Pentium <sup>®</sup> 200 MHz		X	O	X	O	O	O	O	X	O	O	O	X
4. Intel MMX-166MHz		O	O	X	X	X	X	O	X	O	O	O	X
5. Intel MMX-200MHz		X	O	X	X	X	X	O	X	O	O	O	X
6. Intel MMX-233MHz		X	X	X	X	X	X	O	X	O	O	O	X
7. AMD-K6/166 (2.9V)		O	O	X	O	X	X	O	X	O	O	O	X
8. AMD-K6/200 (2.9V)		X	O	X	O	X	X	O	X	O	O	O	X
9. AMD-K6/233 (3.2V)		X	X	X	X	X	O	O	X	O	O	O	X
10. AMD-K6/233 (66*3.5 2.2V)		X	X	X	X	O	X	X	X	O	O	O	X
11. AMD-K6/266 (66*4 2.2V) AMD-K6-2/266 (66*4 2.2V)		O	X	O	X	O	X	X	X	O	O	O	X
12. AMD-K6/300 (66*4.5 2.2V)		O	O	O	X	O	X	X	X	O	O	O	X
13. AMD-K6/300 (100*3 2.2V) AMD-K6-2/300 (100*3 2.2V)		X	O	X	X	O	X	X	X	O	O	X	X
14. AMD-K6-2/333 (66*5 2.2V)		X	O	O	X	O	X	X	X	O	O	O	X
15. AMD-K6-2/333 (95*3.5 2.2V)		X	X	X	X	O	X	X	X	X	X	O	X
16. AMD-K6-2/350 (100*3.5 2.2V)		X	X	X	X	O	X	X	X	O	O	X	X
17. AMD-K6-2/366 (66*5.5 2.2V) *		X	X	O	X	O	X	X	X	O	O	O	X
18. AMD-K6-2/380 (95*4 2.2V)		O	X	O	X	O	X	X	X	X	X	O	X
19. AMD-K6-2/400 (100*4 2.2V)		O	X	O	X	O	X	X	X	O	O	X	X
20. AMD-K6-2/450 (100*4.5 2.4V)		O	O	O	X	X	O	X	X	O	O	X	X
21. AMD-K6-2/475 (95*5 2.4V) *		X	O	O	X	X	O	X	X	X	X	O	X
22. AMD-K6-2/500 (100*5 2.4V) *		X	O	O	X	X	O	X	X	O	O	X	X

5SMM

23. AMD-K6-III/400 (100*4 2.4V)	O	X	O	X	X	O	X	X	O	O	X	X
24. AMD-K6-III/450 (100*4.5 2.4V) *	O	O	O	X	X	O	X	X	O	O	X	X
SWITCH	SW 2								SW 1			
CPU \ SW	S1	S2	S3	S4	S5	S6	S7	S8	1	2	3	4
25. AMD-K6-III/475 (95*5 2.4V) *	X	O	O	X	X	O	X	X	X	X	O	X
26. AMD-K6-III/500 (100*5 2.4V) *	X	O	O	X	X	O	X	X	O	O	X	X
27. Cyrix/IBM 6x86MX-PR166 (66*2 2.9V)	O	X	X	O	X	X	O	X	O	O	O	X
28. Cyrix/IBM 6x86MX-PR200 (66*2.5 2.9V)	O	O	X	O	X	X	O	X	O	O	O	X
29. Cyrix/IBM 6x86MX-PR200 (75*2 2.9V)	O	X	X	O	X	X	O	X	X	O	O	X
30. Cyrix/IBM 6x86MX-PR233 (66*3 2.9V)	X	O	X	O	X	X	O	X	O	O	O	X
31. Cyrix/IBM 6x86MX-PR233 (75*2.5 2.9V)	O	O	X	O	X	X	O	X	X	O	O	X
32. Cyrix/IBM 6x86MX-PR233 (83*2 2.9V)	O	X	X	O	X	X	O	X	O	X	O	X
33. Cyrix/IBM 6x86MX-PR266 (66*3.5 2.9V)	X	X	X	O	X	X	O	X	O	O	O	X
34. Cyrix/IBM 6x86MX-PR266 (75*3 2.9V)	X	O	X	O	X	X	O	X	X	O	O	X
35. Cyrix/IBM 6x86MX-PR266 (83*2.5 2.9V)	O	O	X	O	X	X	O	X	O	X	O	X
36. Cyrix Mc 4PR300 (66*3.5 2.9V)	X	X	X	O	X	X	O	X	O	O	O	X
37. Cyrix Mc 4PR333 (66*4 2.9V)	O	X	O	O	X	X	O	X	O	O	O	X
38. Cyrix Mc 4PR333 (83*3 2.9V)	X	O	X	O	X	X	O	X	O	X	O	X
39. Cyrix Mc 4PR333 (75*3.5 2.9V)	X	X	X	O	X	X	O	X	X	O	O	X
40. Cyrix Mc 4PR366 (100*2.5 2.9V)	O	O	X	O	X	X	O	X	O	O	X	X
41. Cyrix Mc 4PR350 *	X	O	X	O	X	X	O	X	O	O	O	O
42. Cyrix Mc 4PR366 *	O	X	O	O	X	X	O	X	X	O	O	X

43. Cyrix Mc $\Phi$ PR366 * (83*3.5 2.9V)	X	X	X	O	X	X	O	X	O	X	O	X
44. Cyrix Mc $\Phi$ PR366 * (100*3 2.9V)	X	O	X	O	X	X	O	X	O	O	X	X
SWITCH	SW 2								SW 1			
CPU \ SW	S1	S2	S3	S4	S5	S6	S7	S8	1	2	3	4
45. Cyrix Mc $\Phi$ PR400 * (90*4 2.9V)	O	X	O	O	X	X	O	X	O	O	O	O
46. Cyrix Mc $\Phi$ PR400 * (100*3.5 2.9V)	X	X	X	O	X	X	O	X	O	O	X	X
47. IDT Winchip II-200 (66*3 3.5V)	X	O	X	O	O	O	O	X	O	O	O	X
48. IDT Winchip II-200 * (100*2 3.5V)	O	X	X	O	O	O	O	X	O	O	X	X
49. IDT Winchip II-225 (75*3 3.5V)	X	O	X	O	O	O	O	X	X	O	O	X
50. IDT Winchip II-233 * (66*3.5 3.5V)	X	X	X	O	O	O	O	X	O	O	O	X
51. IDT Winchip II-233 * (100*2.33 3.5V)	X	O	O	O	O	O	O	X	O	O	X	X
52. IDT Winchip II-266 * (66*4 3.5V)	O	X	O	O	O	O	O	X	O	O	O	X
53. IDT Winchip II-266 * (100*2.66 3.5V)	X	X	O	O	O	O	O	X	O	O	X	X
54. IDT Winchip II-300 * (100*2.5 3.5V)	O	O	X	O	O	O	O	X	O	O	X	X

\* Note: If Cyrix 6x86 is being used, please check the CPU Date Code after 605.

● The default setting is 100\*3 at 2.2V for AMD K6/300 and AMD K6-2/300

CPU \ SW	S1	S2	S3	S4	S5	S6	S7	S8	1	2	3	4
AMD-K6/300 (100*3 2.2V) AMD-K6-2/300 (100*3 2.2V)	X	O	X	X	O	X	X	X	O	O	X	X

● The settings of the processors marked with "\*" above are just for your reference, these processors have not been tested yet !



☞ The black part in the picture is the white extruding piece of the DIP switch.

1. Pentium<sup>®</sup> Processor 133 MHz

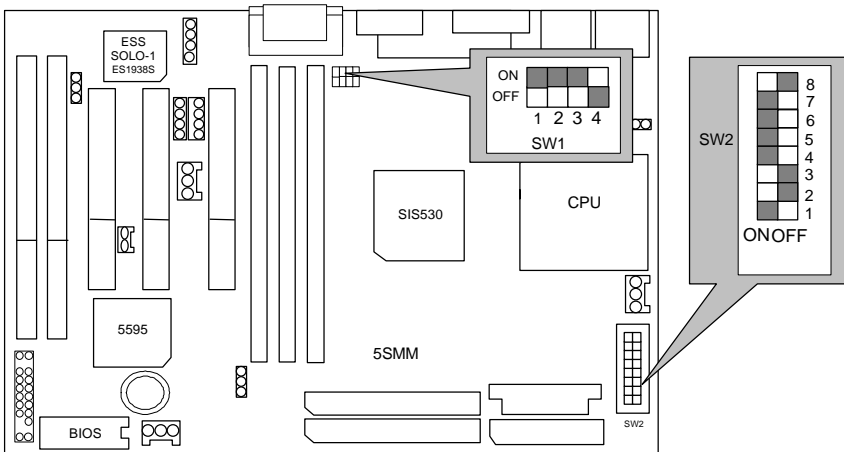

2. Pentium<sup>®</sup> Processor 166 MHz

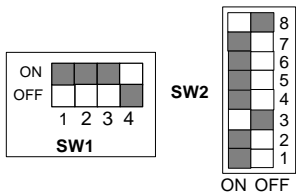

3. Pentium<sup>®</sup> Processor 200 MHz

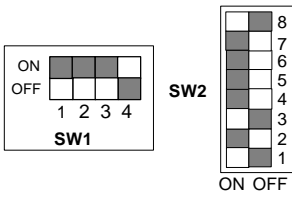

4. Intel MMX-166 MHz

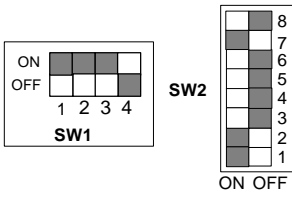

5. Intel MMX-200 MHz

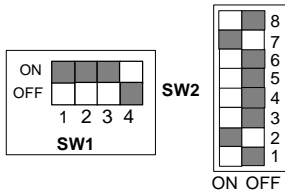

6. Intel MMX-233 MHz

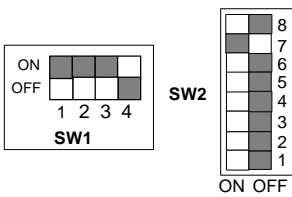

7. AMD-K6/166 (2.9V)

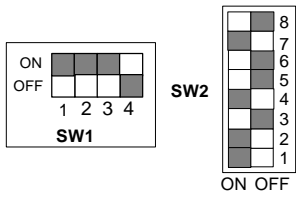

8. AMD-K6/200 (2.9V)

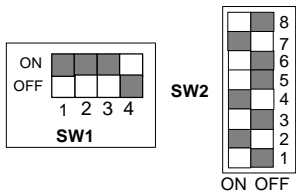

9. AMD-K6/233 (3.2V)

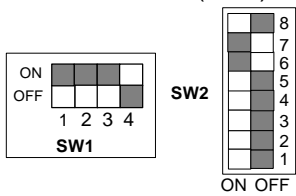

10. AMD-K6/233 (2.2V 66\*3.5)

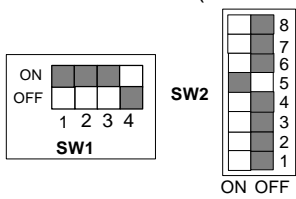

11. AMD-K6/266 (2.2V 66\*4); AMD-K6-2/266 (2.2V 66\*4)

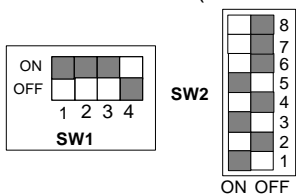

12. AMD-K6/300 (2.2V 66\*4.5)

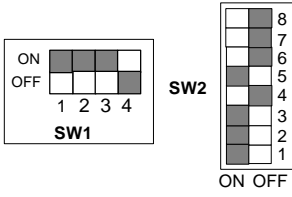

13. AMD-K6/300 (2.2V 100\*3); AMD-K6-2/300 (2.2V 100\*3)

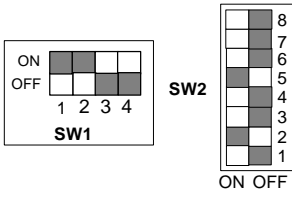

14. AMD-K6-2/333 (2.2V 66\*5)

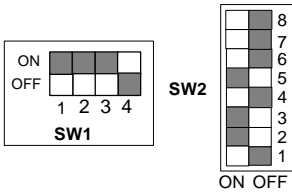

15. AMD-K6-2/333 (2.2V 95\*3.5)

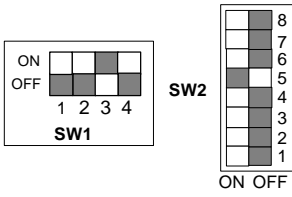

16. AMD-K6-2/350 (2.2V 100\*3.5)

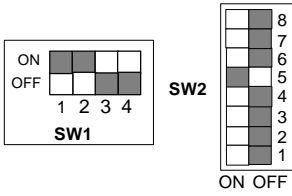

17. AMD-K6-2/366 (2.2V 66\*5.5)

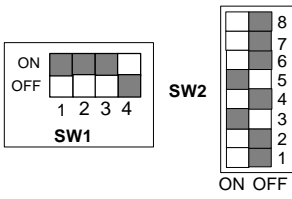

18. AMD-K6-2/380 (2.2V 95\*4)

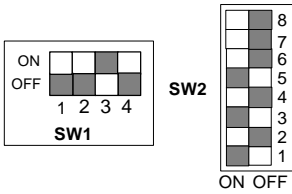

19. AMD-K6-2/400 (2.2V 100\*4)

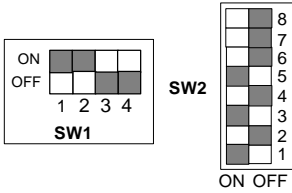

20. AMD-K6-2/450 (2.4V 100\*4.5)

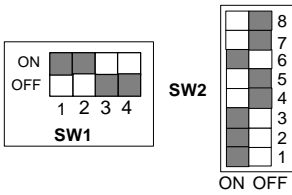

21. AMD-K6-2/475 (2.4V 95\*5)

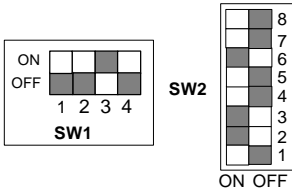

22. AMD-K6-2/500 (2.4V 100\*5)

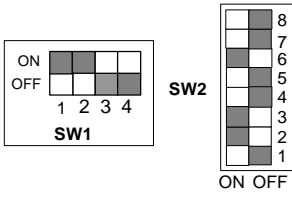

23. AMD-K6-III/400 (2.4V 100\*4)

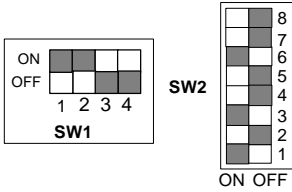

24. AMD-K6-III/450 (2.4V 100\*4.5)

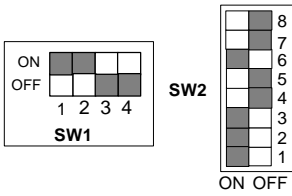

25. AMD-K6-III/475 (2.4V 95\*5)

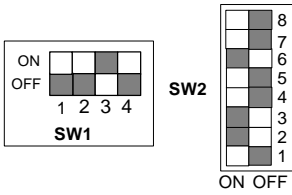

26. AMD-K6-III/500 (2.4V 100\*5)

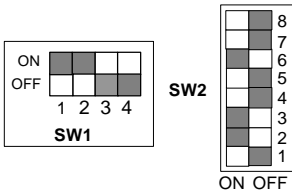

27. Cyrix / IBM 6x86MX-PR166 (2.9V 66\*2)

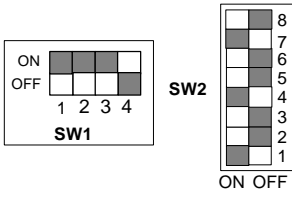

28. Cyrix / IBM 6x86MX-PR200 (2.9V 66\*2.5)

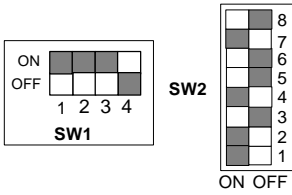

29. Cyrix / IBM 6x86MX-PR200 (75\*2 2.9V)

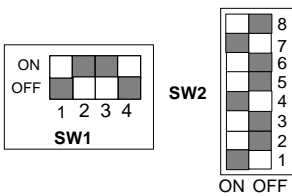

30. Cyrix / IBM 6x86MX-PR233 (2.9V 66\*3)

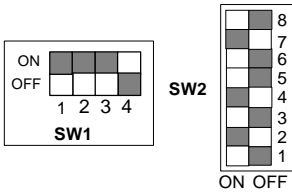

31. Cyrix / IBM 6x86MX-PR233 (2.9V 75\*2.5)

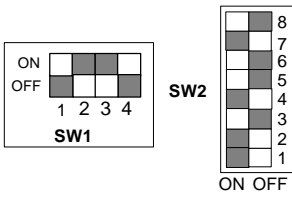

32. Cyrix / IBM 6x86MX-PR233 (2.9V 83\*2)

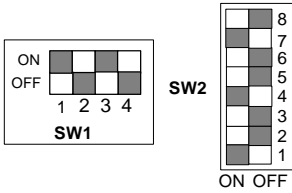

33. Cyrix / IBM 6x86MX-PR266 (2.9V 66\*3.5)

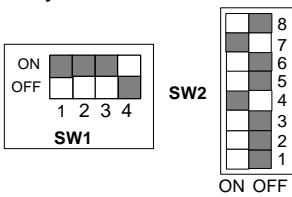

34. Cyrix / IBM 6x86MX-PR266 (2.9V 75\*3)

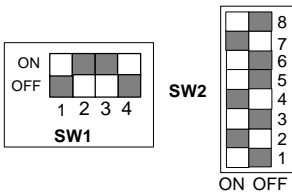

35. Cyrix / IBM 6x86MX-PR266 (2.9V 83\*2.5)

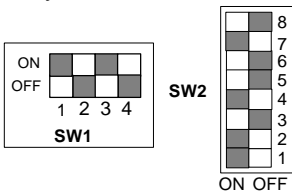

36. Cyrix MII-PR300 (2.9V 66\*3.5)



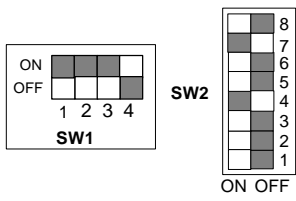

37. Cyrix MII-PR333 (2.9V 66\*4)

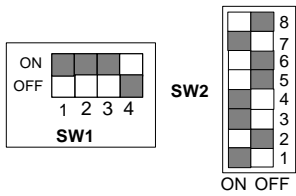

38. Cyrix MII-PR333 (2.9V 83\*3)

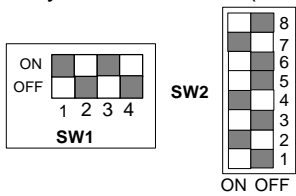

39. Cyrix MII-PR333 (2.9V 75\*3.5)

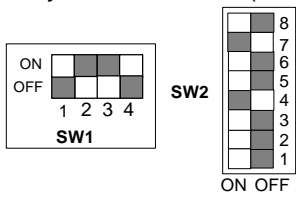

40. Cyrix MII-PR366 (2.9V 100\*2.5)

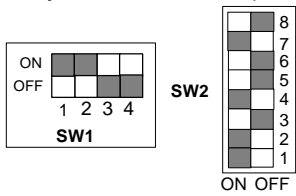

41. Cyrix MII-PR350 (2.9V 90\*3)

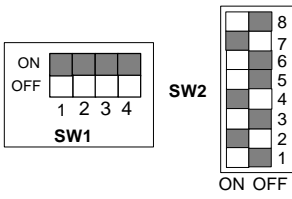

42. Cyrix MII-PR366 (2.9V 75\*4)

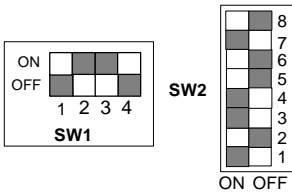

43. Cyrix MII-PR366 (2.9V 83\*3.5)

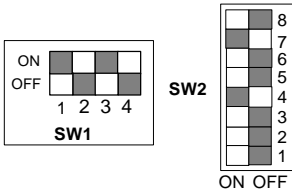

44. Cyrix MII-PR366 (2.9V 100\*3)

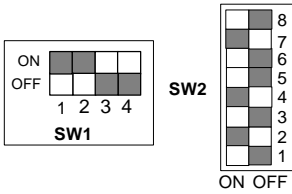

45. Cyrix MII-PR400 (2.9V 90\*4)

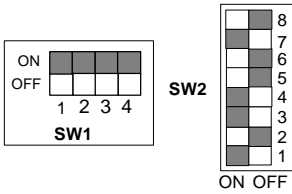

46. Cyrix MII-PR400 (2.9V 100\*3.5)

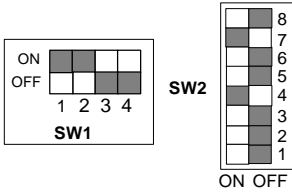

47. IDT Winchip II-200 (3.5V 66\*3)

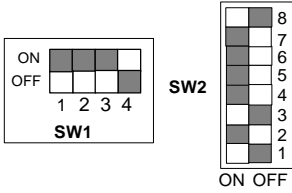

48. IDT Winchip II-200 (3.5V 100\*2)

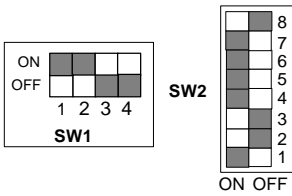

49. IDT Winchip II-225 (3.5V 75\*3)

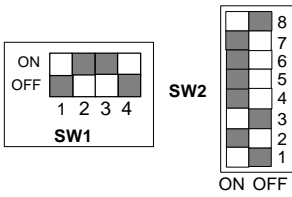

50. IDT Winchip II-233 (3.5V 66\*3.5)

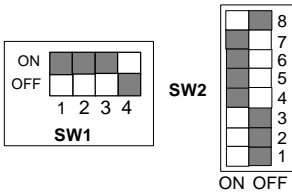

51. IDT Winchip II-233 (3.5V 100\*2.33)

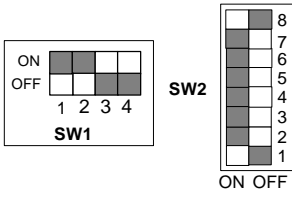

52. IDT Winchip II-266 (3.5V 66\*4)

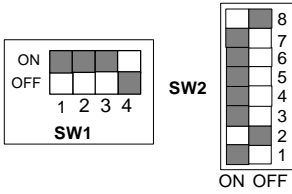

53. IDT Winchip II-266 (3.5V 100\*2.66)

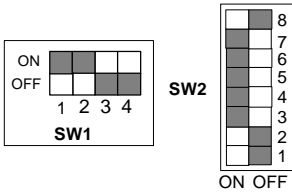

54. IDT Winchip II-300 (3.5V 100\*2.5)

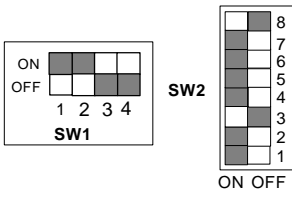

### III. Quick Installation Guide of Jumper setting:

SPK : Speaker Connector

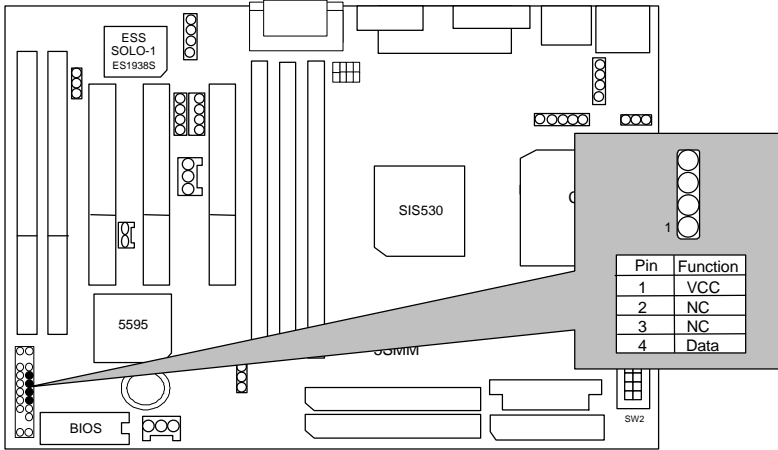

RE : Reset Switch

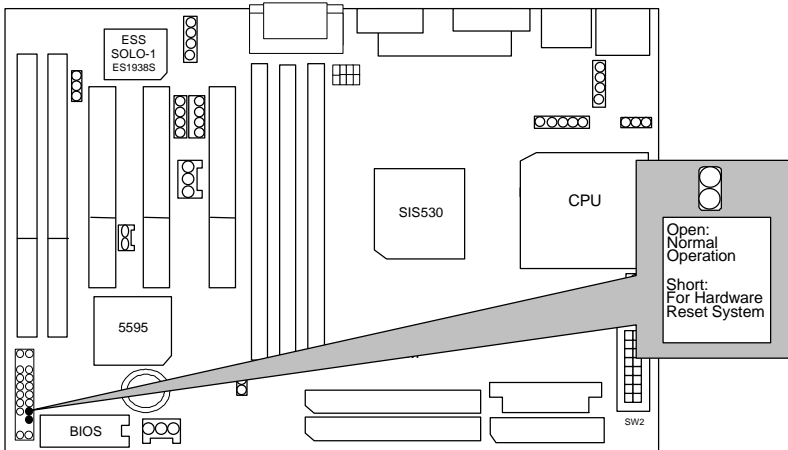

**PWR LED : Power LED**

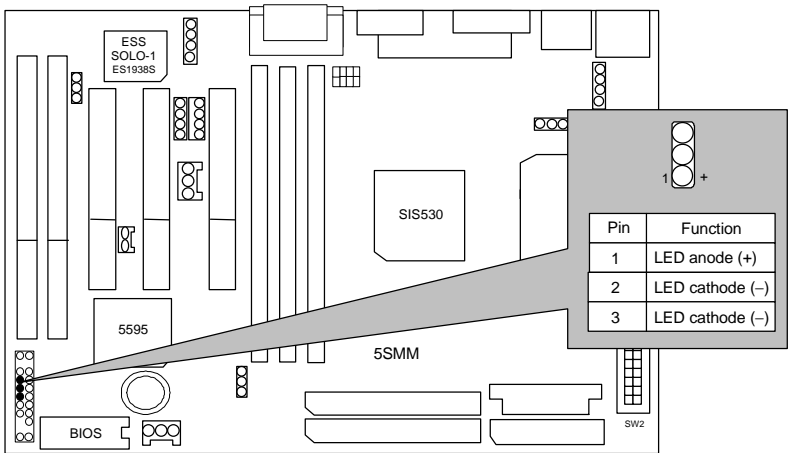

**HD : IDE Hard Disk Active LED**

5SMM

---

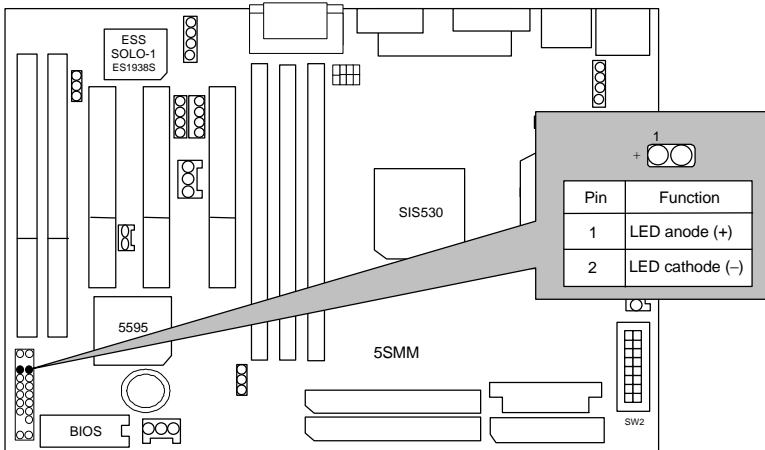

GN : Green Function Switch

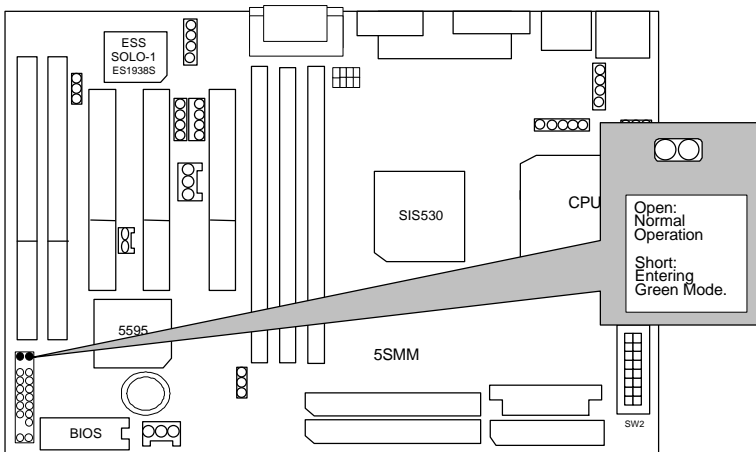

GD : Green LED

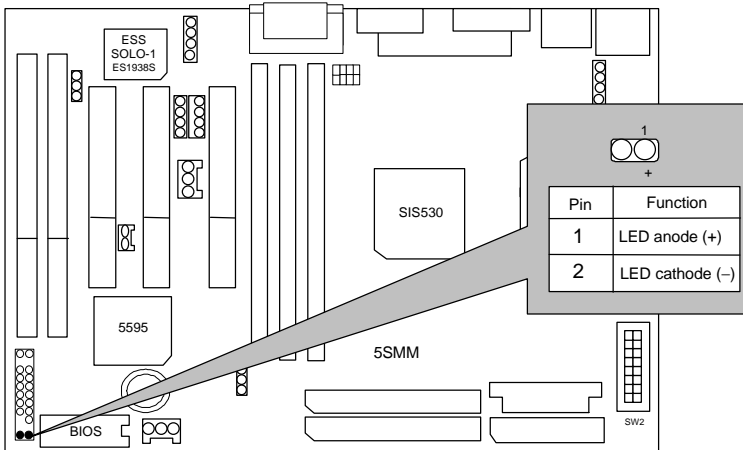

**PW : Power On/Off Switch**

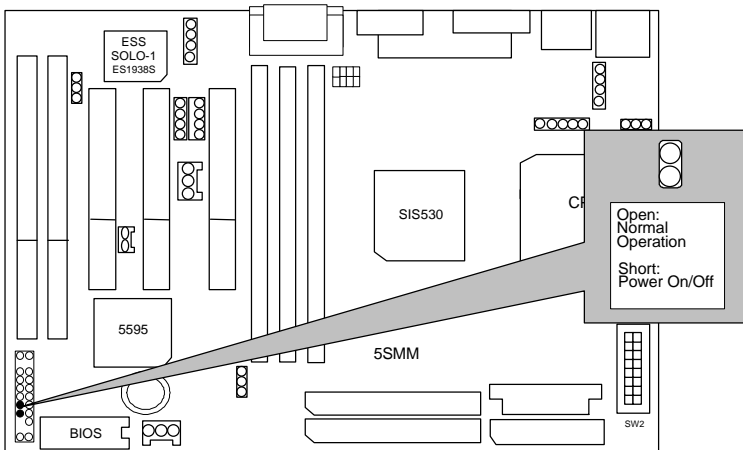

**ATX Power Connector**



5SMM

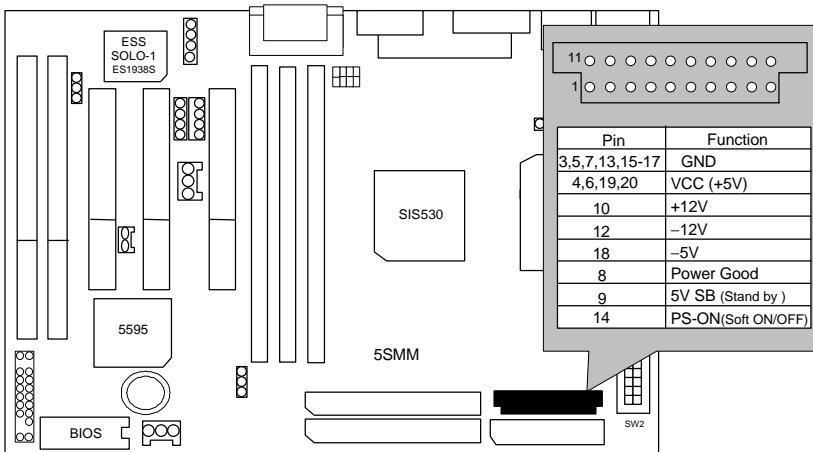

FAN 1 : CPU Cooling Fan Power Connector

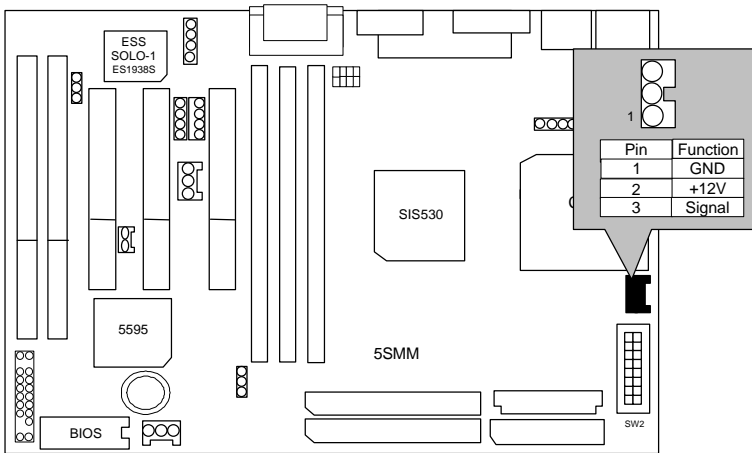

FAN2 : SYSTEM FAN

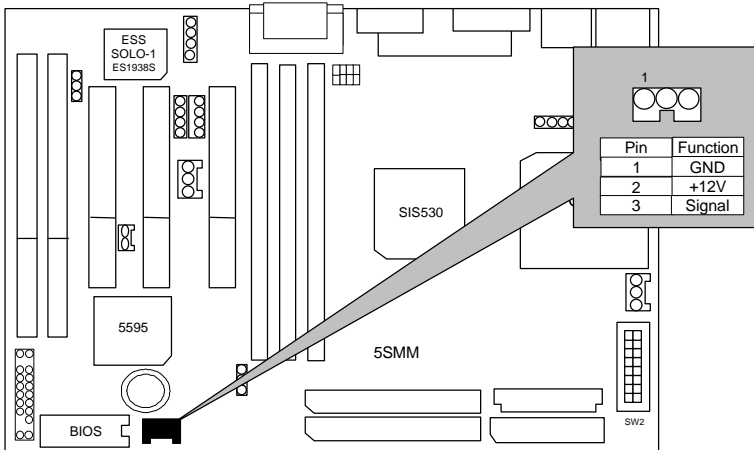

**JP4: Wake On Lan**

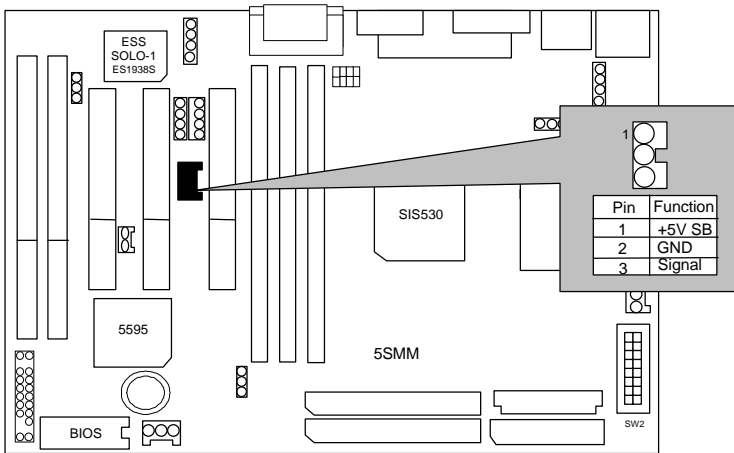

**LPT / COM A / VGA PORT**

5SMM

---

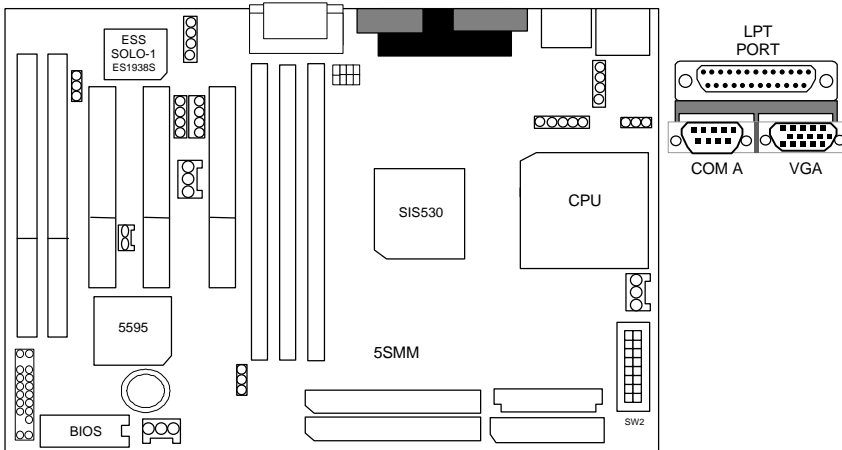

USB : USB Port

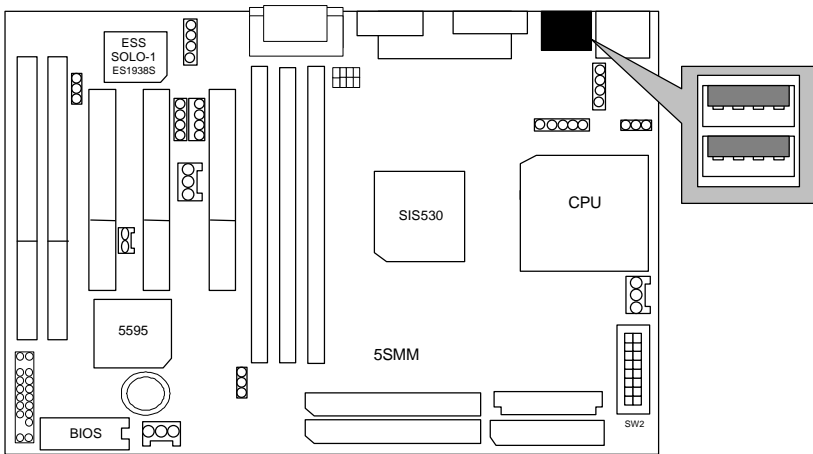

PS/2 : PS/2 Mouse / Keyboard Connector

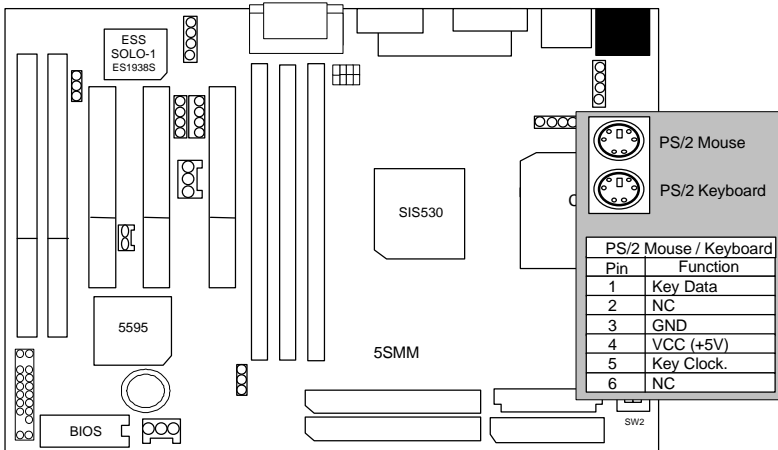

FLOPPY : FLOPPY PORT

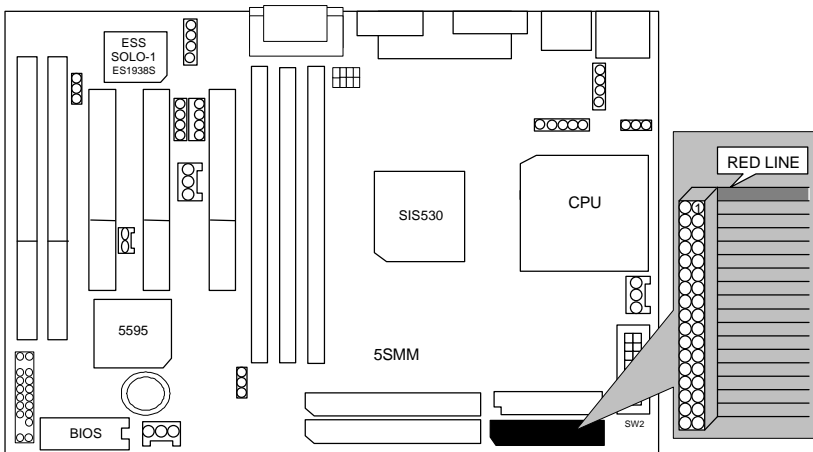

IDE 1 : For Primary IDE port

5SMM

---

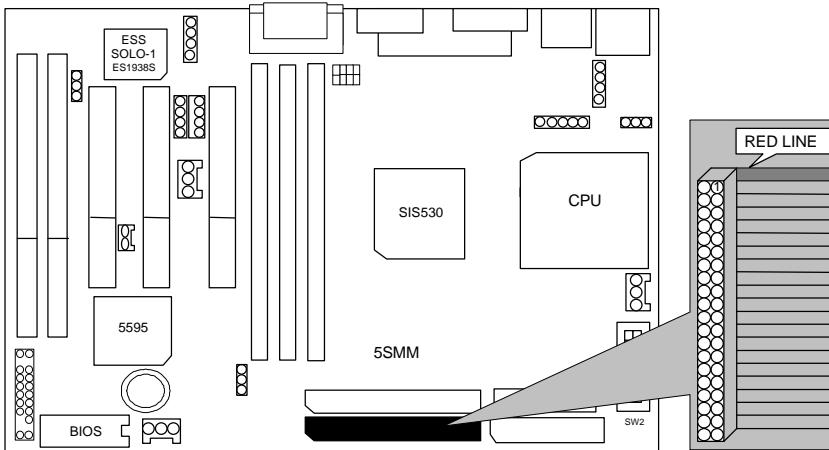

IDE 2 : For Secondary IDE port

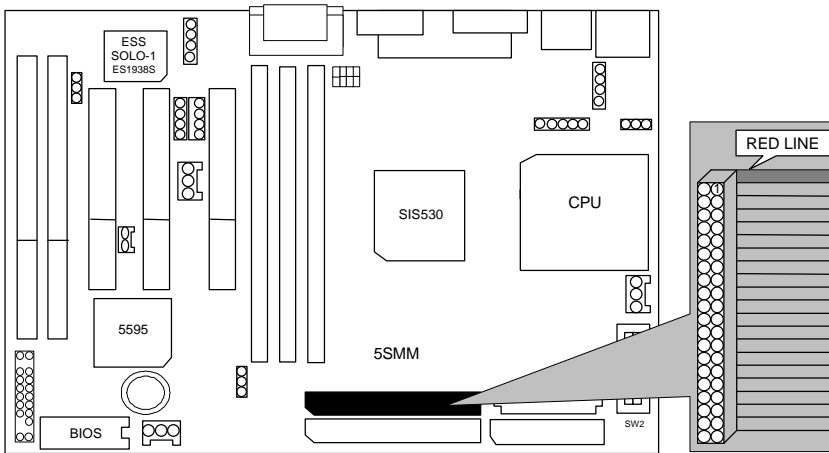

GAME & AUDIO PORT (External)

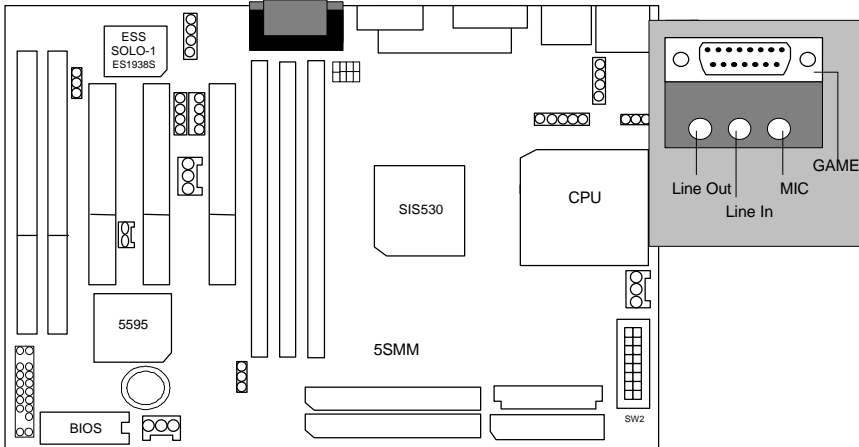

IR : Infrared Connector (Optional)

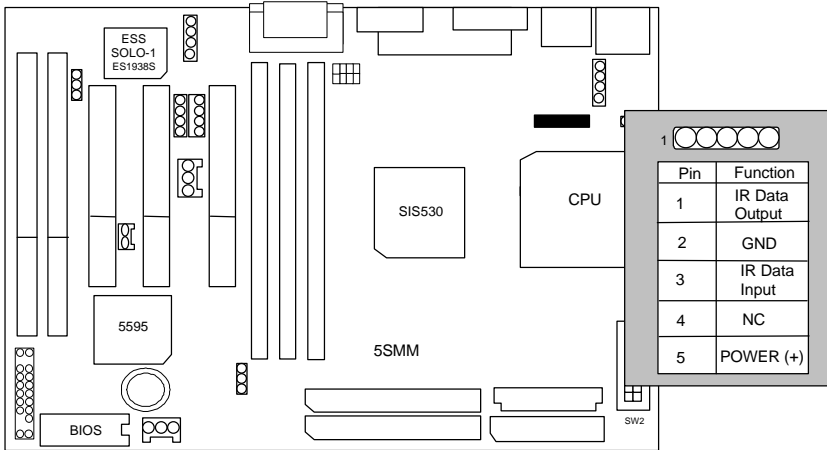

JP2 : Keyboard Power On Select

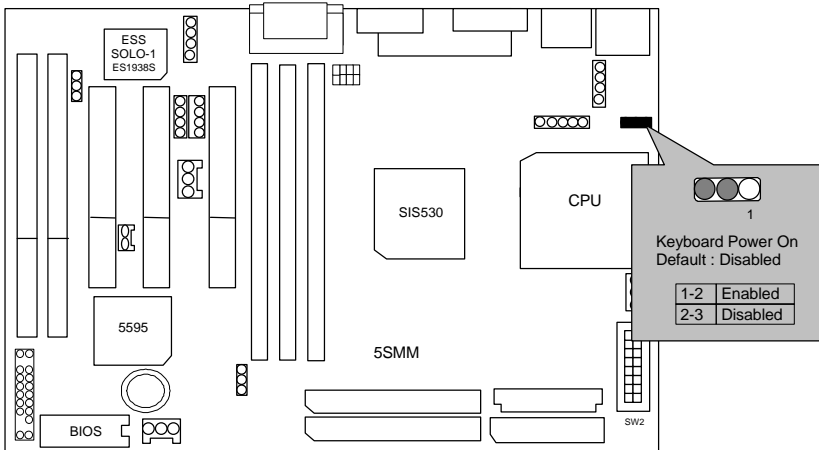

J1 / J2 : CD Audio Line-in Connector

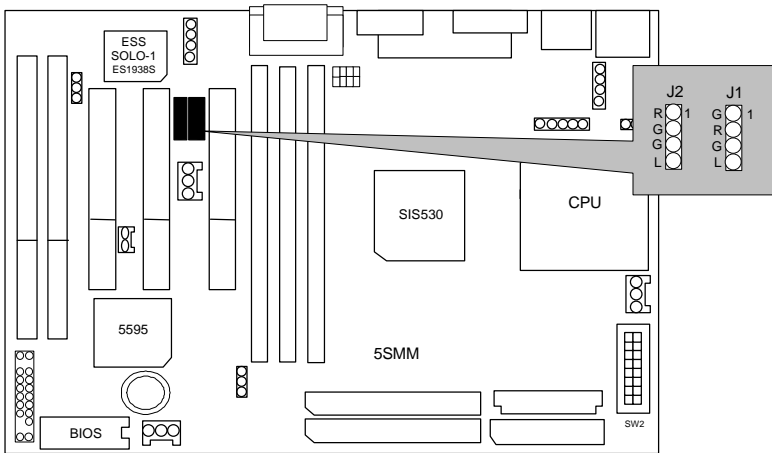

JP1 : On-Board Sound Function Selection

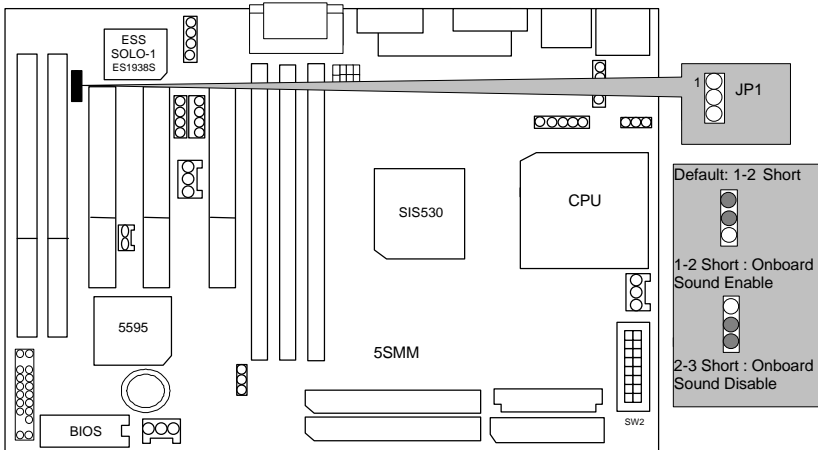

JP7 : CLEAR CMOS Function

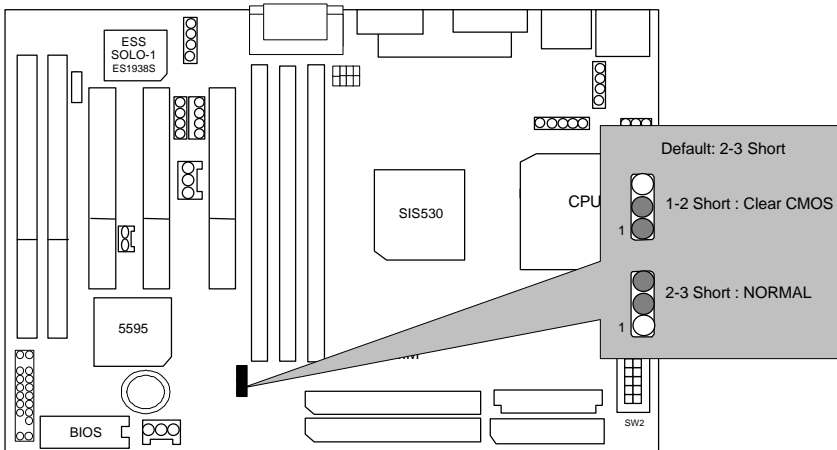



**JP5 : Internal MODEM Wake Up**

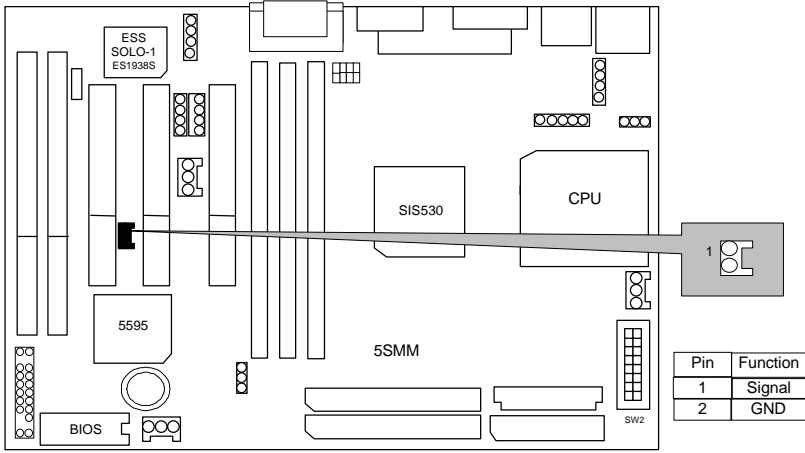

**J9 : PS/2 Mouse By Connector (Optional)**

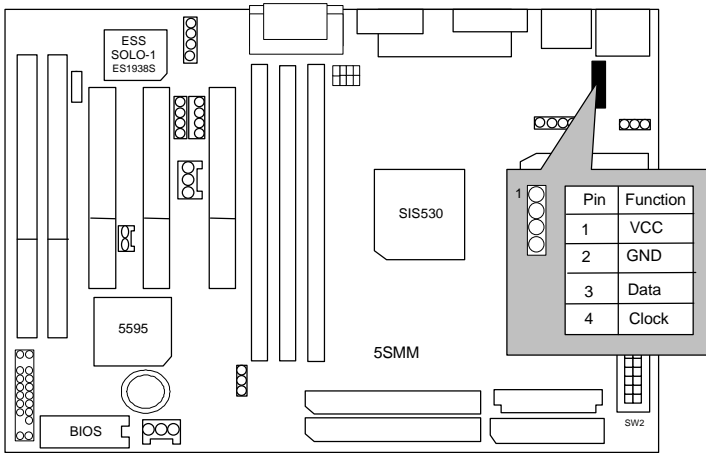

TEL :The Connector is for Modem with internal Voice Connector

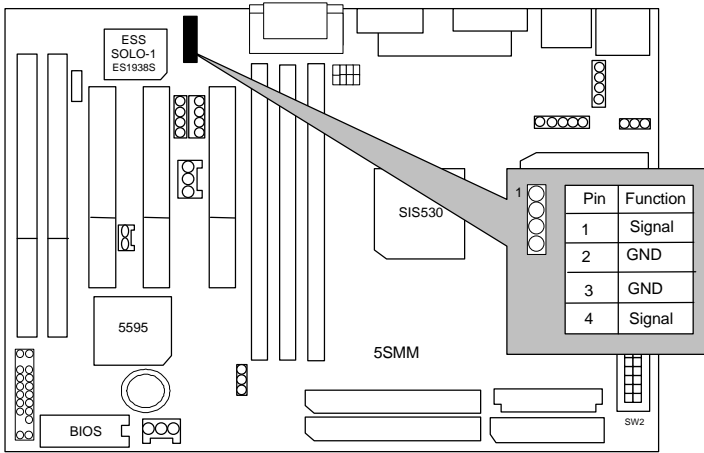

BAT1 : For Battery

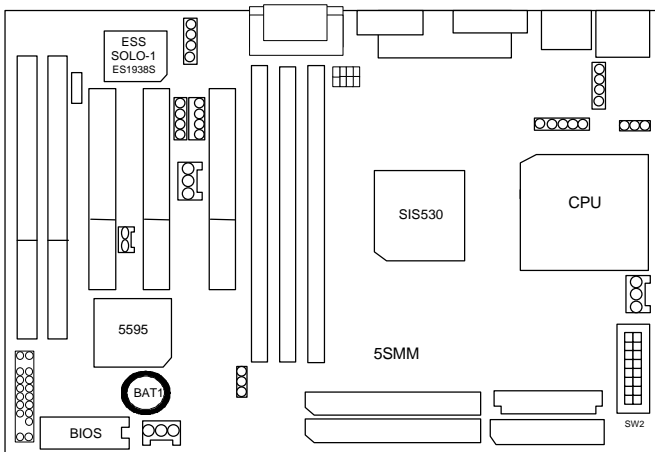

- ⚠ Danger of explosion if battery is incorrectly replaced.
- ⚠ Replace only with the same or equivalent type recommended by the manufacturer.
- ⚠ Dispose of used batteries according to the manufacturer's instructions.

### III. Top Performance Test Setting:

Users have to modify the value for each item in chipset features as follow

```
ROM PCI/ISA BIOS (2A51MG09)
CHIPSET FEATURES SETUP
AWARD SOFTWARE, INC.

Auto Configuration      : Enabled
Refresh Rate Control   : 15.6us
Ref/Act Command Delay  : 5T
RAS Precharge Time     : 2T
RAS to CAS Delay       : 2T
ISA Bus Clock Frequency: PCICLK/4
SDRAM CAS Latency      : 2T
SDRAM WR Retire Rate   : X-1-1-1
DRAM Opt RAS Precharge : Enabled
PCI Peer Concurrency   : Enabled
Read Prefetch Memory RD: Enabled
CPU to PCI Burst Mem. WR: Enabled
CPU to PCI Post Write  : Enabled
AGP Aperture Size      : 64MB
System BIOS Cacheable  : Enabled
Video BIOS Cacheable   : Enabled
Memory Hole at 15M-16M : Disabled
Linear Mode SRAM Support: Disabled

PCI Post Write Buffer   : Disabled
PCI Delayed Transaction: Enabled
Auto Detect DIMM/PCI Clk: Disabled
Spread Spectrum        : Disabled

ESC : Quit          ↑↓↓↑ : Select Item
F1  : Help          PU/PD/+/- : Modify
F5  : Old Values (Shift)F2 : Color
F6  : Load BIOS Defaults
F7  : Load Setup Defaults
```

for top performance setting.

- \*\* Each value of items as above depends on your hardware configuration : CPU , SDRAM , Cards , etc.  
Please modify each value of items If your system does not work properly.

## PERFORMANCE LIST

The following list of performance data is the testing results of some popular benchmark testing programs.

These data are just referred by users, and there is no responsibility for different testing data values gotten by users. (The different Hardware & Software configuration will result in different benchmark testing results.)

- CPU Pentium® Processor MMX-233 MHz, Cyrix 6x86MX-PR333, AMD K6-3 400, AMD K6-2 450
- DRAM (32 x 3) MB SDRAM (MICRON MT48LC2M8A-8)
- CACHE SIZE 512 KB
- DISPLAY Onboard SIS530 AGP Card
- STORAGE Onboard IDE (Seagate ST34520A)
- O.S. Windows® NT 4.0
- DRIVER Display Driver at 1024 x 768 x 64K colors x 75Hz.  
SIS Bus Master IDE Driver

Processor	Intel-MMX 233MHz (66x3.5)	AMD K6-2 450 (100x4.5)	AMD K6-3 400 (100x4)	Cyrix 6x86MX- PR333 (83x3)
Winbench99 CPU mark32	312	555	1220	470
FPU Winmark	876	1480	1360	573
Business Disk	3270	3750	4320	3680
Hi-End Disk	8280	9520	10500	9520
Business Graphics	53.8	82.9	111	89.1
Hi-End Graphics	106	199	319	187
Winstone99 Business	13.1	20.2	27	19.1
Hi-End	11.4	18.5	23.9	14.6