

Chapter 1

INTRODUCTION

The MS-6111 is a high-performance personal computer mainboard based on the Pentium® II processor.

The mainboard uses the highly integrated Intel® 82440LX chipset to support the PCI/ISA and Green standards, and to provide the Host/AGP bridge. The Intel® 82371AB chipset integrates all system control functions such as ACPI (Advanced Configuration and Power Interface). The ACPI provides more Energy Saving Features for the OSPM(OS Direct Power Management) function. The 82371AB chipset also improves the IDE transfer rate by supporting Ultra DMA/33 IDE that transfers data at the rate of 33MB/s.

The mainboard also supports the LM78 System Hardware Monitor Controller as optional function. The LM78 function includes: CPU /power supply/chassis fan revolution detect, CPU/system voltage monitor, system temperature monitor, and chassis intrusion detect(optional).

1.1 Mainboard Features

CPU

- Slot 1 for Pentium® II processor
- Supports 200MHz, 233MHz, 266MHz, 300MHz, and 333MHz.
- Core/Bus ratios are x2, x2.5, x3, x3.5, x4, x4.5, x5, x5.5, x6 and higher.

Switching Voltage Regulator

- On-board switching mode DC-DC Step Down Regulator.
- Conforms to Intel® VRM ver 8.1 specifications.
- Over-Voltage and Over-Current protection.

Chip Set

- Intel® 82440LX PCI Chipset.

Clock Generator

- 66.6MHz clocks are supported.

Main Memory

- Supports eight memory banks using four 168-pin unbuffered DIMM sockets.
- Supports a maximum memory size of 512MB with SDRAM, or 1GB with EDO.
- Supports ECC(Error Check Correct) and EC(Multiple-Bit Error Correction) function.
- Supports 3.3v Extended Data Output (EDO) and SDRAM DIMM.

Slots

- One AGP(Accelerated Graphics Port) slot.
 - AGP specification compliant
 - AGP 66/133MHz 3.3v device support
- Four 32-bit Master PCI Bus slots and three 16-bit ISA bus slots wherein one shared slot that can be used as ISA or PCI.
- Supports 3.3v/5v PCI bus Interface.

On-Board IDE

- An IDE controller on the Intel® 82371AB PCI Chipset provides IDE HDD/CD-ROM with PIO, Bus Master and Ultra DMA/33 operation modes.
- Can connect up to four IDE devices.

On-Board Peripherals

- On-Board Peripherals include:
 - 1 floppy port supports 2 FDD with 360K, 720K, 1.2M, 1.44M and 2.88Mbytes.
 - 2 serial ports (COMA + COMB)
 - 1 parallel port supports SPP/EPP/ECP mode
 - 2 USB ports
 - 1 IrDA connector for Fast IrDA(reserved).

BIOS

- The mainboard BIOS provides “Plug & Play” BIOS which detects the peripheral devices and expansion cards of the board automatically.
- The mainboard provides a Desktop Management Interface(DMI) function which records your mainboard specifications.

On-Board System Hardware Monitor(LM78)

- CPU/Power Supply/Chassis Fan Revolution Detect
- CPU Fan Control (the fan will automatically stop when the system enters suspend mode)
- System Voltage Detect
- CPU Overheat Warning (reserved)
- Chassis Intrusion Detect(reserved)
- Display Actual Current Voltage

RTC

- Non-Volatile RTC.

Keyboard Connector

- PS/2® keyboard interface and PS/2® mouse interface.

Dimension

- ATX Form Factor: 30cm(L) x 23cm(W) x 4 layers PCB.
- Double deck I/O connectors, compatible with Intel® Venus Mainboard.

Mounting

- 9 mounting holes.

1.2 Mainboard Layout

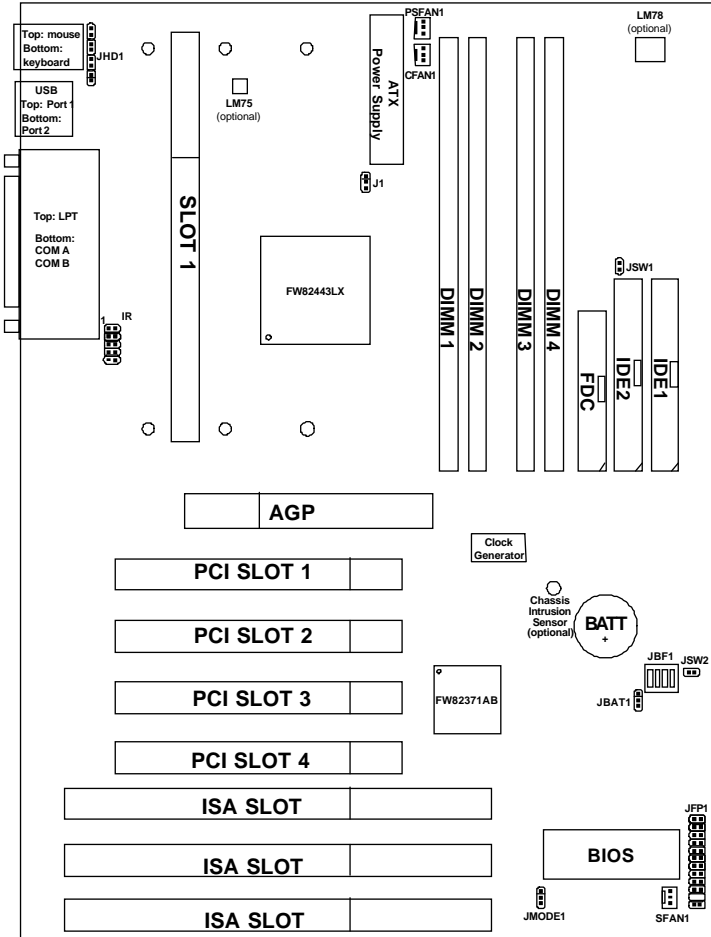

MS-6111

Chapter 2

HARDWARE INSTALLATION

2.1 Central Processing Unit: CPU

The mainboard operates with **Intel® Pentium® II processor**. The mainboard uses a CPU Slot called Slot 1 for easy CPU installation and a DIP switch (JBF1) to set the proper speed for the CPU. The CPU should always have a Heat Sink and a cooling fan attached to prevent overheating.

2.1-1 CPU Installation Procedures

There are two kinds of Pentium® II processors that is currently used: the OEM Pentium® II processor and the Boxed Pentium® II processor. OEM Pentium® II processor has no Heat Sink, Fan and Heat Sink Support, while the Boxed Pentium® II processor is provided with Heat Sink w/ fan and Heat Sink Support.

A. OEM Pentium® II processor Installation Procedures

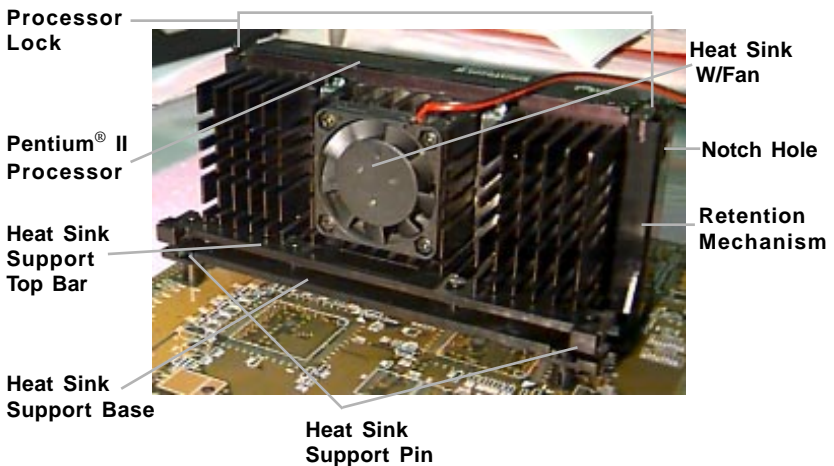

Required Things:

Pentium® II processor - Processor.

***Retention Mechanism(RM)** - Plastic Guide that holds the S.E.C. Cartridge in the Slot 1 connector.

***Heat Sink Support Base (HSSBASE)** - Plastic support bar mounted to the mainboard under the ATX heatsink.
(One leg is always bigger than the other one)

***Heat Sink Support Pin (HSSPIN)** - Plastic pins inserted through the HSSBASE to secure it to the mainboard (2 required per Assembly).

***Heat Sink Support Top Bar (HSSTOP)** - Plastic bar that clips onto the HSSBASE through the fins on the ATX heatsink.

****Heat Sink w/ fan** - Heat Sink that can be attached to the **Pentium® II processor** with metal clip.

Note: * Provided by MSI mainboard.

** Provided by Special request.



Step 1: Place the bubble bag that came with your mainboard or use any soft material like Styrofoam underneath the mainboard. Find a flat surface to do the installation.

Step 2: Install the Retention Mechanism.

Look for the key on Slot 1, and match it with the Notch Key on the Retention Mechanism for the proper direction. Then, insert the Two Keylock of the Retention Mechanism into the two holes on the sides of Slot 1. Take note that one hole is wider than the other. The Retention Mechanism will only fit in one direction.

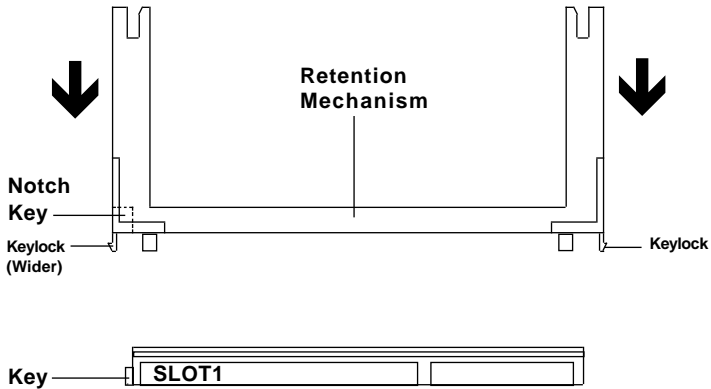

Push the Retention Mechanism onto the mainboard, until you hear a “click” sound. Check for a perfect fit.

Step 3: Install the Heat Sink Support Base.

Look for the Two holes across Slot 1, and match it with the Two legs of the Heat Sink Support Base for the proper direction. Take note that one hole/leg is bigger than the other. The Four top pins of the Heat Sink Support Base should also be oriented towards Slot 1.

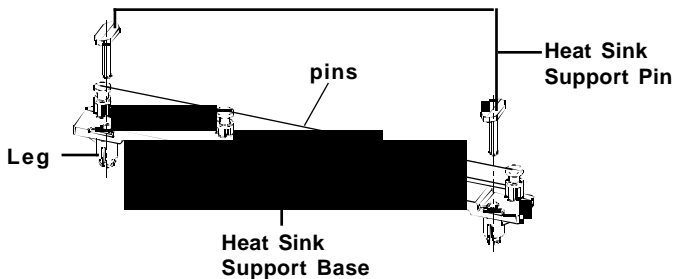

Push the Heat Sink Support Base onto the mainboard, until you hear a click sound. Check for a perfect fit.

Step 4: Install the Heat Sink Support Pin.

Push the Heat Sink Support Pins onto the two holes of the Heat Sink Support Base. Check for a perfect fit. These pins are used to secure the Heat Sink Support Base.

Step 5: Install the Heat Sink with Fan to the Processor.

Push down the metal clips, so that they are in line with the back of the Heat Sink. Be careful, so as not to detach the metal clips from the Heat Sink.

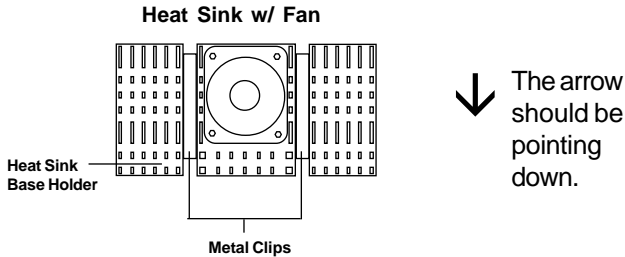

In case the metal clips are detached from the Heat Sink, re-attach them. Look for the arrow on the metal clip. This arrow should be pointing down and aligned with the Heat Sink Support Base Holder.

Attach the Heat Sink to the processor.

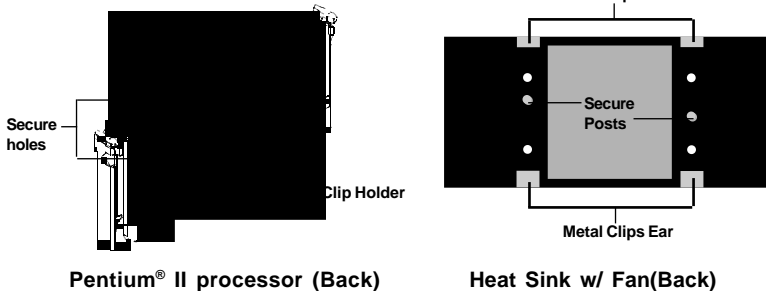

- Look at the back of the Heat Sink and take note of the 2 secure posts. Insert these 2 Secure posts to the 2 secure holes on the back of the processor.
 - Align the ears of the metal clips with the clip holders on the back of the processor. Use a screw driver to push the metal clips onto the clip holders. Check for a perfect fit.
-

Step 6: Install the Processor.

Unlock the Processor by pushing in the Processor Locks.



Insert the Processor like inserting a PCI or an ISA card.

Step 7: Lock the Processor Locks.

Secure the CPU by pulling the Processor Locks out.

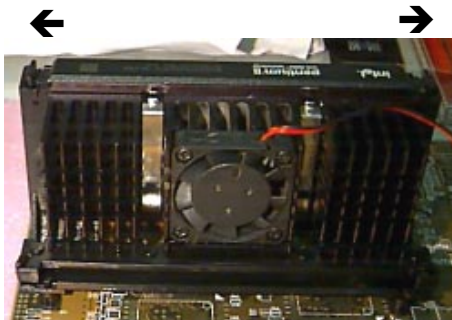

Step 8: Install the Heat Sink Support Top Bar.

Push the Heat Sink Support Top Bar to the Heat Sink Support Base, Until you hear a “click” sound. Check for a perfect fit.



**Heatsink
Support Top
Bar**

The installation is now complete.

B. Boxed Pentium® II processor Installation Procedures

The Boxed Pentium® II processor has a built-in Fan and Heat Sink. It also has a Heat Sink Support. So if you're going to use a Boxed processor, all you need is the Retention Mechanism.

Step 1: Place the bubble bag that came with your mainboard or use any soft material like Styrofoam underneath the mainboard. Find a flat surface to do the installation.

Step 2: Install the Retention Mechanism.

Look for the key on Slot 1, and match it with the Notch Key on the Retention Mechanism for the proper direction. Then, insert the Two Keylock of the Retention Mechanism into the two holes on the sides of Slot 1. Take note that one hole is wider than the other. The Retention Mechanism will only fit in one direction.

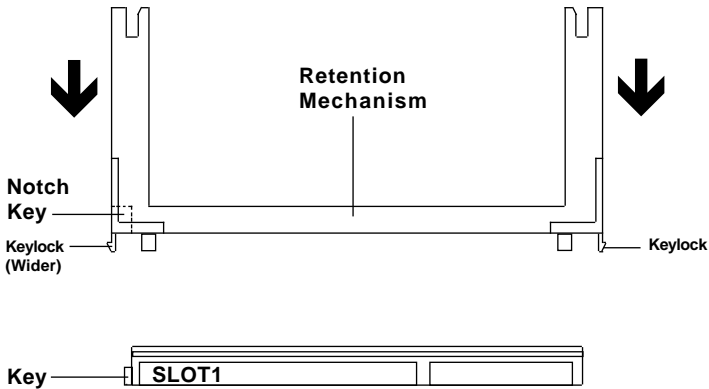

Push the Retention Mechanism onto the mainboard, until you hear a “click” sound. Check for a perfect fit.

Step 3: Install the Heat Sink Support Base.

Look for the 2 holes across Slot 1, and match it with the 2 Heat Sink Support Base. Take note that one hole/base is bigger than the other.

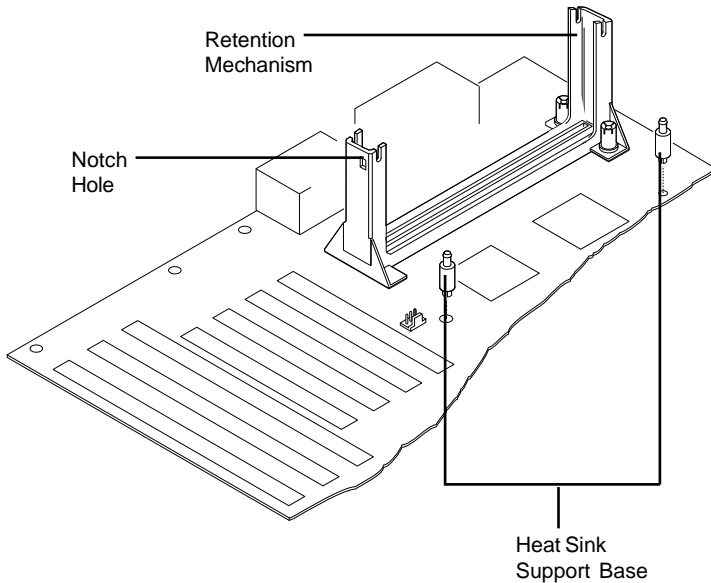

Push the Heat Sink Support Base onto the mainboard, until you hear a click sound. Check for a perfect fit.

Step 4: Install the Heat Sink Support.

Attach the 2 Heat Sink Supports to the sides of the Processor. These Heat Sink Supports will fit in any direction, so be sure that the Heat Sink Support Locks are oriented outwards for the proper direction.

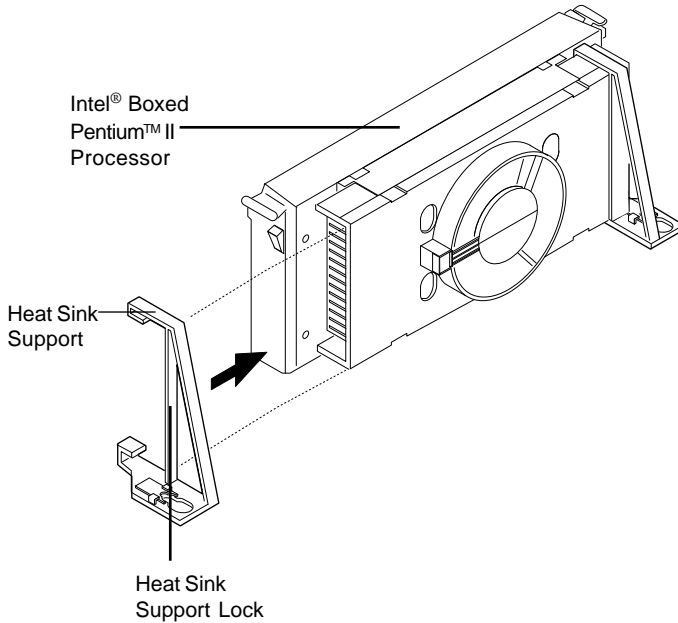

Step 5: Unlock the Processor Locks and Heat Sink Support Locks.

Push in the Processor Locks. Open the Heat Sink Support Locks.

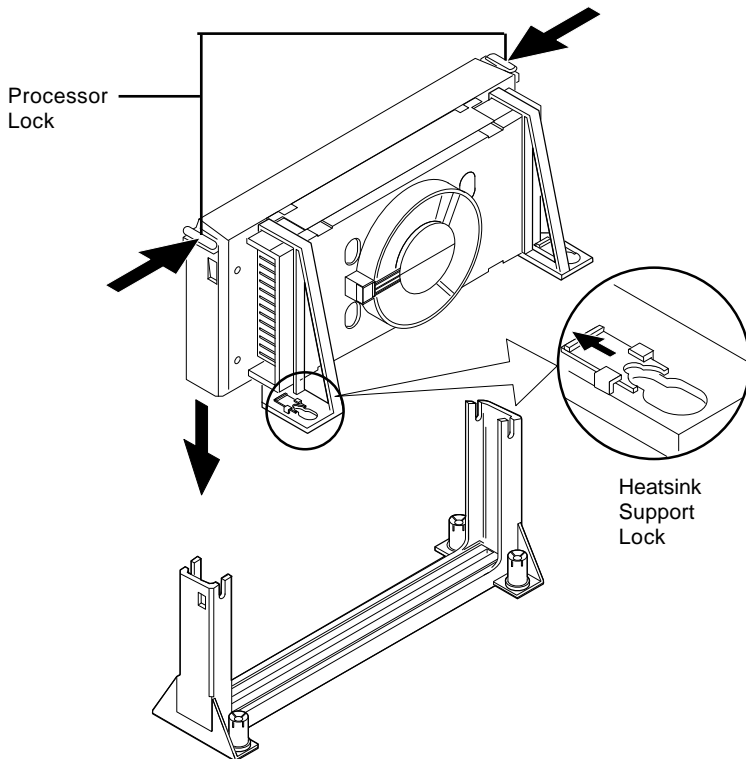

Step 6: Insert the Processor like inserting a PCI or an ISA card.

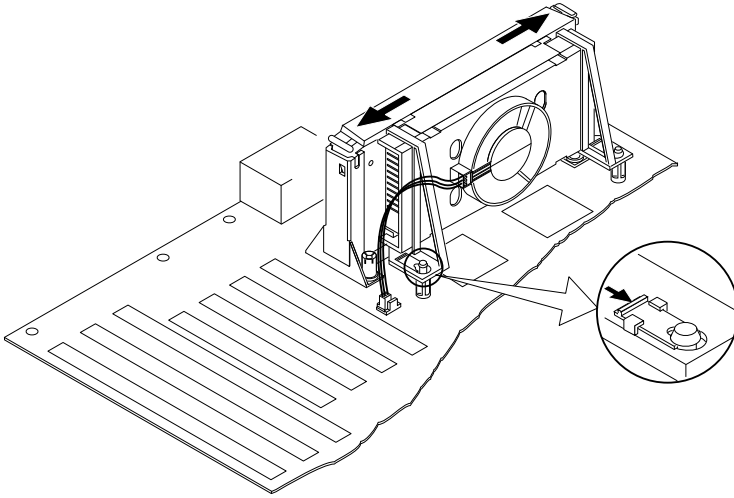

Step 7: Lock the Processor Locks and Heat Sink Support Locks

Secure the CPU by pushing out the Processor Locks. Close the Heat Sink Support Locks.

The installation is now complete.

2.1-2 CPU Speed Setting: JBF1

To adjust the speed of the CPU, you must know the specification of your CPU (*always ask the vendor for CPU specification*). Then look at **Table 2.1** (**200 ~ 333MHz Intel® Pentium® II processor**) for proper setting.

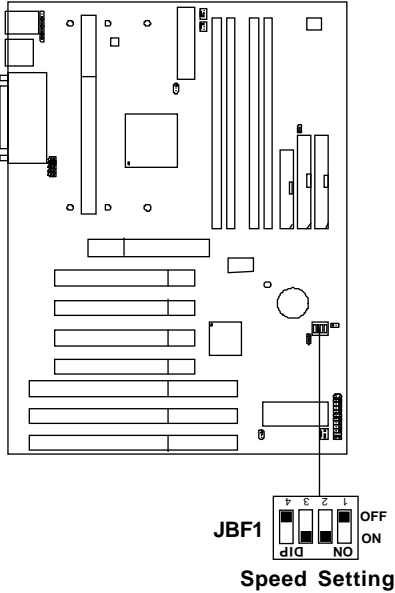
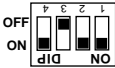
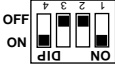
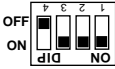
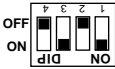
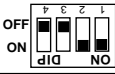
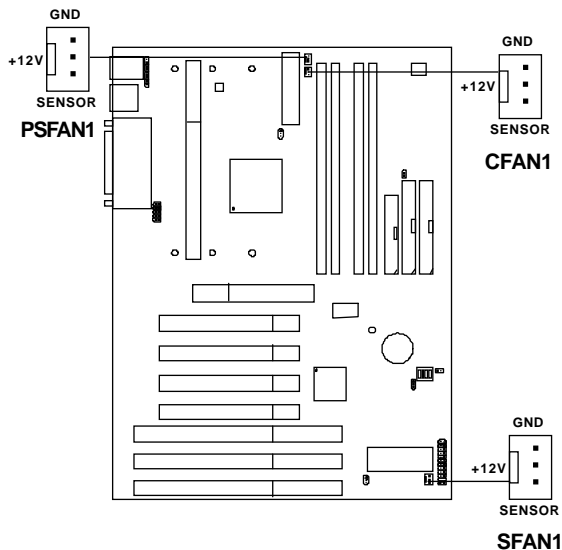

Table 2.1 200 ~ 333MHz Intel® Pentium® II processor

CPU Type	CPU SPEED JBF1
200MHz	
233MHz	
266MHz	
300MHz	
333MHz	

2.1-3 CPU Fan Power Connectors: CFAN1/SFAN1/PSFAN1

These connectors support system cooling fan with +12V. It supports three pin head connector. When connecting the wire to the connector, always take note that the red wire is the positive and should be connected to the +12V, the black wire is Ground and should be connected to GND. If your mainboard has LM78 chipset on-board, you must use a specially designed fan with speed sensor to take advantage of LM78's CPU fan control.



- PSFAN1** : Power Supply Fan
CFAN1 : CPU Fan
SFAN1 : System(Chassis) Fan

For fans with fan speed sensor, every rotation of the fan will send out 2 pulses. LM78 will count and report the fan rotation speed.

- Note:**
1. **SFAN1 and PSFAN1** are the Power and Chassis Cooling Fan Speed Connector (reserved for LM78 System Hardware Monitor Option.)
 2. Always consult vendor for proper CPU cooling fan.

2.2 Flash ROM Programming Voltage: JMODE1

This jumper is for setting the Voltage of the Flash ROM BIOS.

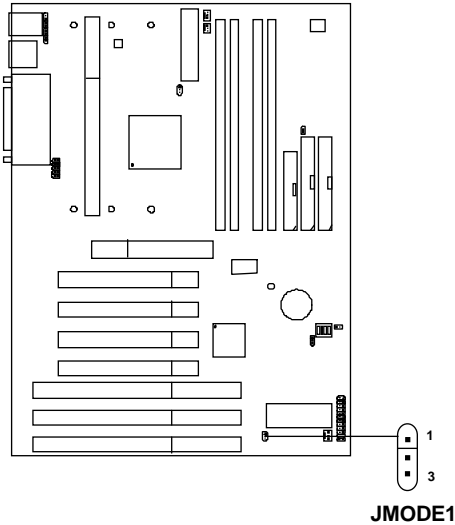

Voltage Setting

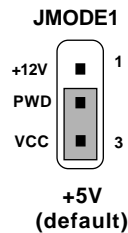
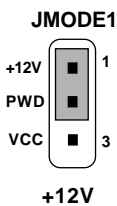

- Note:**
- Short 1-2 pin, if you're using Intel® or MXIC® flash memory and you want to flash the ROM data.
 - Short 2-3 pin, if you're using Intel® or MXIC® flash memory for normal operation.
 - Leave JMODE1 open, if you're using Winbond® flash memory.

2.3 External Battery Connector: JBAT1

A battery must be used to retain the mainboard configuration in CMOS RAM. If you use the on-board battery, you must short 1-2 pins of JBAT1 to keep the CMOS data.

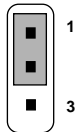
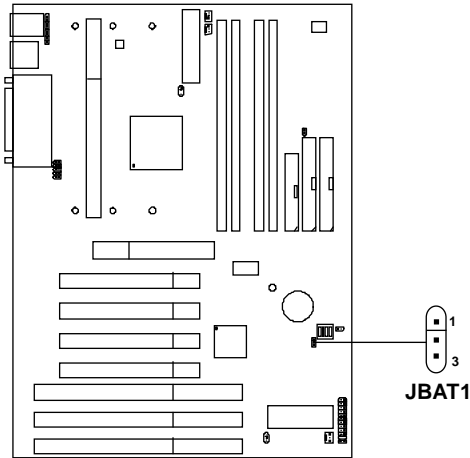

Keep Data

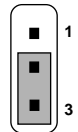

Clear Data

Note: You can clear CMOS by shorting 2-3 pin, while the system is off. Then, return to 1-2 pin position. Avoid clearing the CMOS while the system is on; it will damage the mainboard.

2.4 Memory Installation

2.4-1 Memory Bank Configuration

The mainboard supports a maximum of 1 GB of memory for EDO and 512MB for SDRAM: It provides four 168-pin **unbuffered** DIMMs (Double In-Line Memory Module) sockets. It supports 8 MB to 256 MB of memory. The memory module can be either SDRAM or EDO (Extended Data Output) Mode DRAM. A DIMM consists of two Banks and may have a maximum of 256 MB of memory.

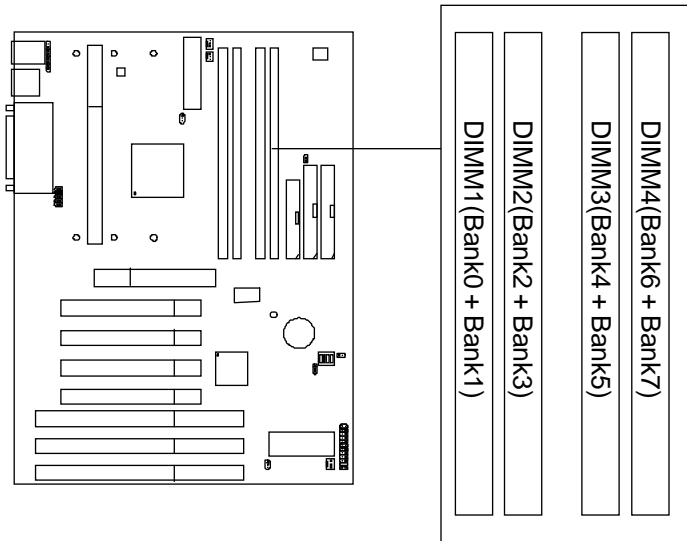

Note: FP(Fast Page) & BEDO(Burst EDO) are not supported.

2.4-2 Memory Installation Procedures

A. How to install a DIMM Module

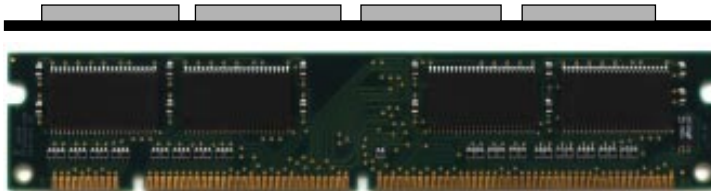

Single Sided DIMM

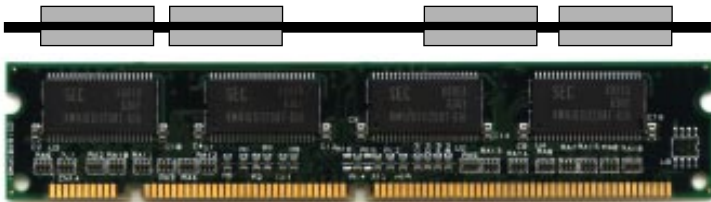

Double Sided DIMM

1. The DIMM slot has a two Notch Key “VOLT and DRAM”, so the DIMM memory module can only fit in one direction.
2. Insert the DIMM memory module vertically into the DIMM slot. Then push it in.

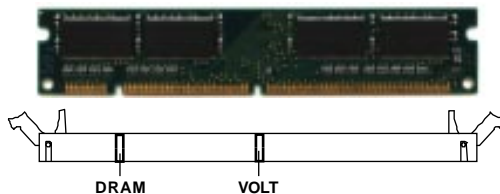

3. Close the plastic clip at the side of the DIMM slot.

Note: You can only use a 3.3 volt DIMM module (EDO or SDRAM).

2.4-1 Memory Population Rules

1. You can use any kind of DIMM **except for FP and BEDO**.
2. You can only used an **unbuffered** DIMM.
3. To operate properly, at least one 168-pin DIMM module must be installed.
4. This mainboard supports Table Free memory, so memory can be installed on DIMM1, DIMM2, DIMM3 or DIMM 4 in any order.
5. You can only use a 3.3 volt DIMM.
6. The DRAM addressing and the size supported by the mainboard is shown next page.



If three or four double-side DIMMs is used, you must use a DIMM with 16/18pcs of DRAM per DIMM, it should also have MA Buffers on the DIMM. (MS-5927 16/32M or MS-5928 64/128M)

Table 2.4-1 440LX EDO DRAM Addressing

DRAM Tech.	DRAM Density & Width	DRAM Addressing	Address Size		MB/SIMM	
			Row	Column	Single no. Side(S) pcs.	Double no. Side(D) pcs.
4M	1Mx4	SYMM	10	10	4MBx8	8MBx16
16M	1Mx16	SYMM	10	10	4MBx2	8MBx4
	1Mx16	ASYM	12	8	4MBx2	8MBx4
	2Mx8	ASYM	11	10	8MBx4	16MBx8
	2Mx8	ASYM	12	9	8MBx4	16MBx8
	4Mx4	SYMM	11	11	16MBx8	32MBx16
	4Mx4	ASYM	12	10	16MBx8	32MBx16
64M	2Mx32	ASYM	11	10	8MBx1	16MBx2
	2Mx32	ASYM	12	9	8MBx1	16MBx2
	2Mx32	ASYM	13	8	8MBx1	16MBx2
	4Mx16	SYMM	11	11	16MBx2	32MBx4
	4Mx16	ASYM	12	10	16MBx2	32MBx4
	8Mx8	ASYM	12	11	32MBx4	64MBx8
	16Mx4	SYMM	12	12	64MBx8	128MBx16

Table 2.4-2 440LX SDRAM Addressing

DRAM Tech.	DRAM Density & Width	DRAM Addressing	Address Size		MB/DIMM	
			Row	Column	Single no. Side(S) pcs.	Double no. Side(D) pcs.
16M	1Mx16	ASYM	11	8	8MBx4	16MBx8
	2Mx8	ASYM	11	9	16MBx8	32MBx16
	4Mx4	ASYM	11	10	32MB	64MB
64M	2Mx32	ASYM	11	9	32MBx2	64MBx4
	2Mx32	ASYM	12	8	16MBx2	32MBx4
	4Mx16	ASYM	11	10	32MB	64MB
	4Mx16	ASYM	13	8	32MB	64MB
	8Mx8	ASYM	13	9	64MB	128MB
	16Mx4	ASYM	13	10	128MB	256MB
64M	2Mx32	ASYM	11	8		
	4Mx16	ASYM	12	8		
	8Mx8	ASYM	12	9		
	16Mx4	ASYM	12	10		

2.5 Case Connector: JFP1

The Turbo LED, Hardware Reset, Key Lock, Power LED, Speaker and HDD LED are all connected to the JFP connector block.

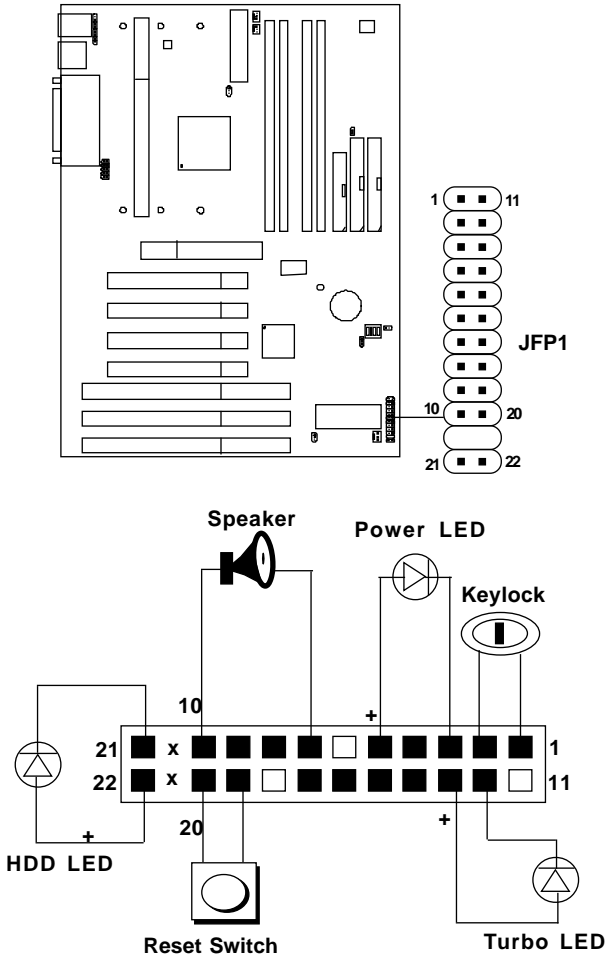

Figure 2.1

2.5-1 Turbo LED

The Turbo LED is always ON. You can connect the Turbo LED from the system case to this pin. (See Figure 2.1)

2.5-2 Hardware Reset

Reset switch is used to reboot the system rather than turning the power ON/OFF. Avoid rebooting while the HDD LED is lit. You can connect the Reset switch from the system case to this pin. (See Figure 2.1)

2.5-3 Keylock

Keylock allows you to disable the keyboard for security purposes. You can connect the keylock to this pin. (See Figure 2.1)

2.5-4 Power LED

The Power LED is always lit while the system power is on. You can connect the Power LED from the system case to this pin. (See Figure 2.1)

2.5-5 Speaker

Speaker from the system case is connected to this pin. (See Figure 2.1)

2.5-6 HDD LED

HDD LED shows the activity of a hard disk drive. Avoid turning the power off while the HDD led is lit. You can connect the HDD LED from the system case to this pin. (See Figure 2.1).

2.6 Floppy Disk Connector: FDC

The mainboard also provides a standard floppy disk connector FDC that supports 360K, 720K, 1.2M, 1.44M and 2.88M floppy disk types. These connectors support the provided floppy drive ribbon cable.

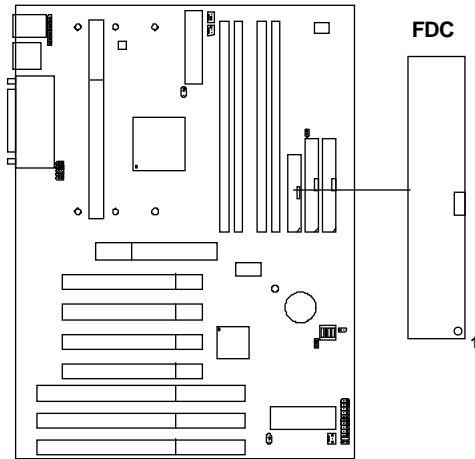

2.7 Hard Disk Connectors: IDE1 & IDE2

The mainboard has a 32-bit Enhanced PCI IDE Controller that provides PIO mode 0~4, Bus Master, and Ultra DMA/33 function. It has two HDD connectors IDE1 (primary) and IDE2 (secondary). You can connect up to four hard disk drives, CD-ROM, 120MB Floppy (reserved for future BIOS) and other devices to IDE1 and IDE2. These connectors support the provided IDE hard disk cable.

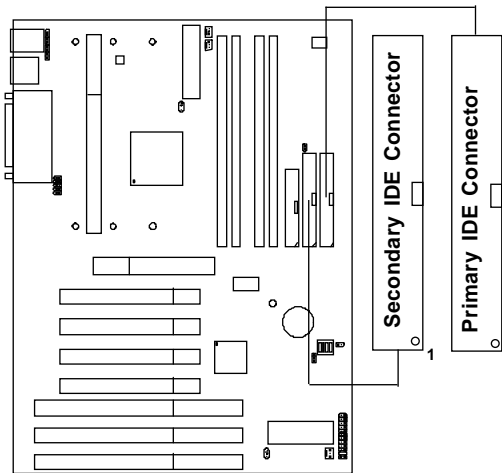

IDE1(Primary IDE Connector)

The first hard drive should always be connected to IDE1. IDE1 can connect a Master and a Slave drive. You must configure second hard drive to Slave mode by setting the jumper accordingly.

IDE2(Secondary IDE Connector)

IDE2 can also connect a Master and a Slave drive.

2.8 Power Supply

2.8-1 ATX 20-pin Power Connector: JWR1

This connector supports the power button on-board. Using the ATX power supply, functions such as Modem Ring Wake-Up and Soft Power Off are supported by this mainboard.

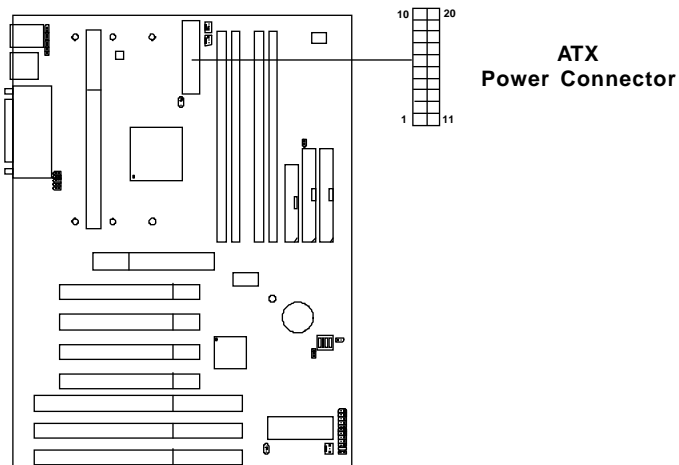

ATX Power Connector Pin Description

20	19	18	17	16	15	14	13	12	11
5V	5V	-5V	GND	GND	GND	PS_ON	GND	-12V	3.3V
12V	5V_SB	PW_OK	GND	5V	GND	5V	GND	3.3V	3.3V
10	9	8	7	6	5	4	3	2	1

2.8-2 Remote Power On/Off Switch: JSW1/JSW2

Connect to a 2-pin push button switch. Every time the switch is shorted by pushing it once, the power supply will change its status from OFF to ON.

During ON stage, push once and the system goes to sleep mode: pushing it more than 4 seconds will change its status from ON to OFF. If you want to change the setup, you could go to the BIOS Power Management Setup.

This is used for ATX type power supply.

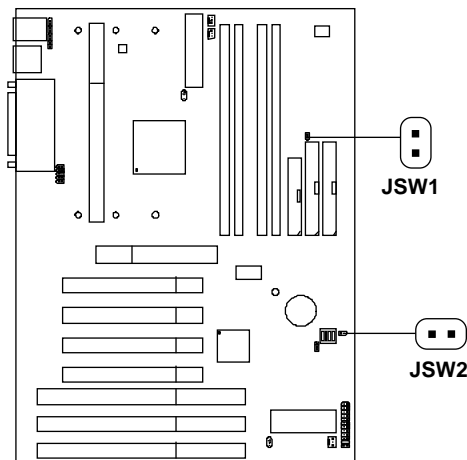

Note: The two switches are provided by the mainboard for your convenience, so you can use any of them. The two switches have the same feature.

2.9 IrDA Infrared Module Connector: IR

The mainboard provides two 5-pin infrared (IR) connectors for IR modules. These connectors are for optional wireless transmitting and receiving infrared module. You must configure the setting through the BIOS setup to use the IR function. FIR and Consumer IR are reserved functions.

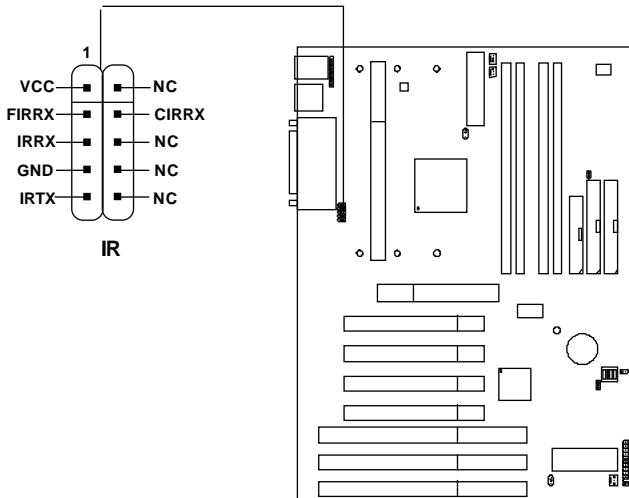

2.10 Serial Port Connectors: COM A & COM B

The mainboard has two 9-pin male DIN connectors for serial ports COM A and COM B. These two ports are 16550A high speed communication ports that send/receive 16 bytes FIFOs. You can attach a mouse or a modem cable directly into these connectors.

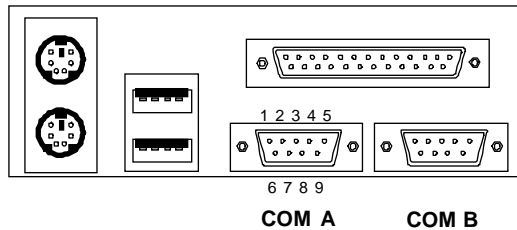

Pin Definition

Pin #	Definition
1	DCD (Data Carry Detect)
2	SIN (Serial In or Receive Data)
3	SOUT (Serial Out or Transmit Data)
4	DTR (Data Terminal Ready)
5	GND
6	DSR (Data Set Ready)
7	RTS (Request To Send)
8	CTS (Clear To Send)
9	RI (Ring Indicate)

2.11 Parallel Port Connector: LPT

The mainboard provides a 25 pin female centronic connector for LPT. A parallel port is a standard printer port that also supports Enhanced Parallel Port(EPP) and Extended capabilities Parallel Port(ECP). See connector and pin definition below:

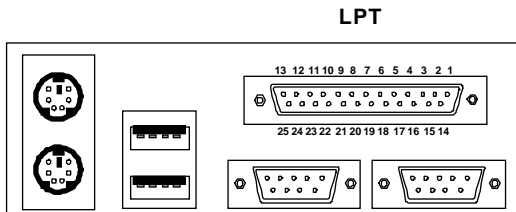

Pin Definition

PIN #	DEFINITION	PIN #	DEFINITION
1	STROBE	14	AUTO FEED#
2	DATA0	15	ERR#
3	DATA1	16	INIT#
4	DATA2	17	SLIN#
5	DATA3	18	GND
6	DATA4	19	GND
7	DATA5	20	GND
8	DATA6	21	GND
9	DATA7	22	GND
10	ACK#	23	GND
11	BUSY	24	GND
12	PE	25	GND
13	SELECT		

2.12 Mouse Connector: JKBMS1

The mainboard provides a standard PS/2[®] mouse mini DIN connector for attaching a PS/2[®] mouse. You can plug a PS/2[®] mouse directly into this connector. The connector location and pin definition are shown below:

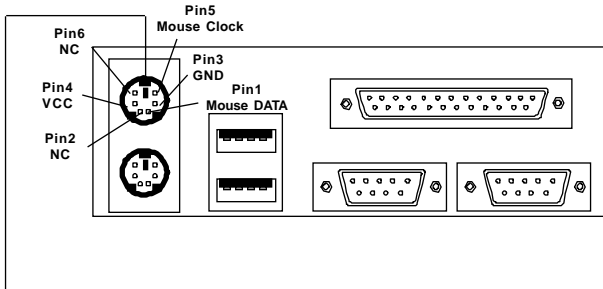

PS/2[®] Mouse (6-pin Female)

2.13 Keyboard Connector: JKBMS1

The mainboard provides a standard PS/2[®] keyboard mini DIN connector for attaching a keyboard. You can plug a keyboard cable directly into this connector.

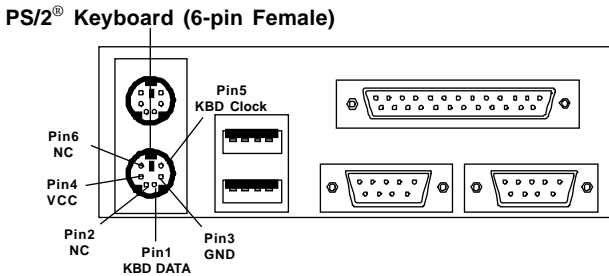

2.14 USB Connector: USB

The mainboard provides a **UHCI (Universal Host Controller Interface) Universal Serial Bus root** for attaching USB devices like: keyboard, mouse and other USB devices. You can plug the USB device directly to this connector.

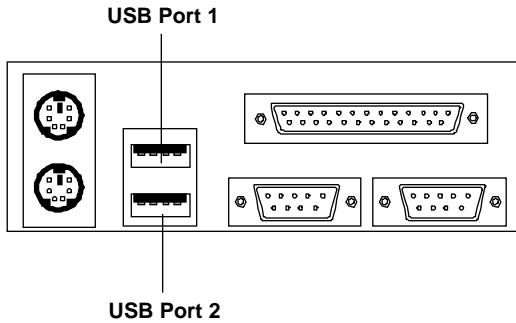

2.15 Keyboard and Mouse Pin Connectors: JHD1

These connectors are used by some special customer. They can use these connectors to customize remote control module for keyboard and mouse. Default settings are pin 1-2, 3-4, 5-6, and 7-8 short respectively.

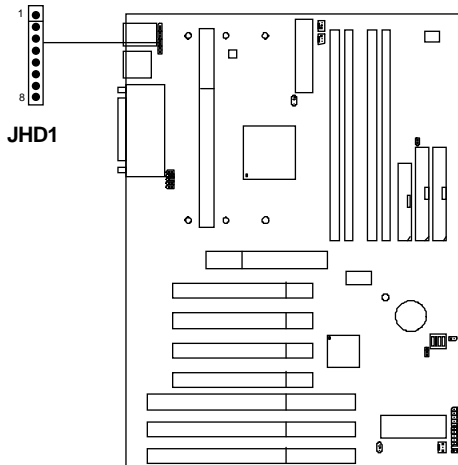

JHD1 PIN DEFINITION

- PIN1: KBDCLK_1
- PIN2: KBDCLK_2
- PIN3: KBDDATA_1
- PIN4: KBDDATA_2
- PIN5: MSDATA_1
- PIN6: MSDATA_2
- PIN7: MSCLK_1
- PIN8: MSCLK_2

Chapter 3

AMI® BIOS USER GUIDE

The system configuration information and chipset register information is stored in the CMOS RAM. This information is retained by a battery when the power is off. Enter the BIOS setup (if needed) to modify this information.

The following pages will describe how to enter BIOS setup, and all about options.

3.1 Enter BIOS Setup

Enter the AMI® setup Program's Main Menu as follows:

1. Turn on or reboot the system. The following screen appears with a series of diagnostic check.

```
AMIBIOS (C) 1996 American Megatrends Inc.  
AGIOMS VXXX XXXXXX
```

```
Hit <DEL> if you want to run setup
```

```
(C) American Megatrends Inc.  
61-XXXX-001169-00111111-071592-i82440FX-H
```

2. When the "Hit " message appears, press key to enter the BIOS setup screen.
3. After pressing key, the BIOS setup screen will appear.

Note: *If you don't want to modify CMOS original setting, then don't press any key during the system boot.*

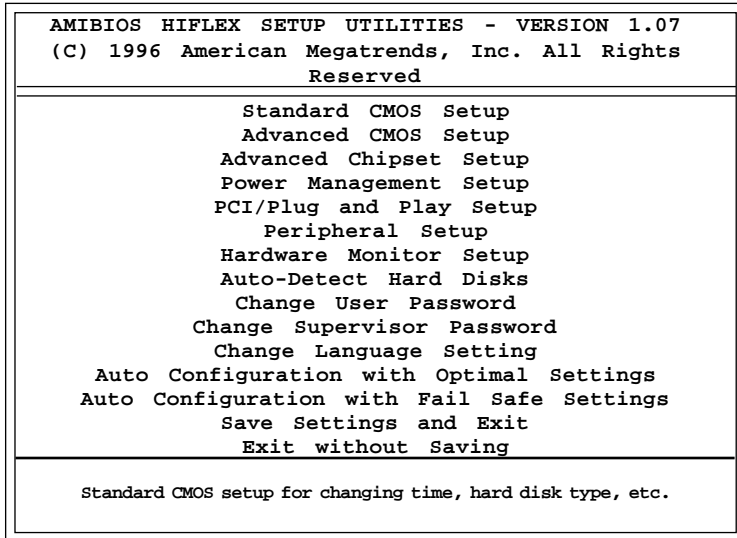

4. Use the <Up> and <Down> key to move the highlight scroll up or down.
5. Use the <ENTER> key to select the option.
6. To exit, press <ESC>. To save and exit, press <F10>.
7. Section 3.2 to 3.7 will explain the option in more details.

3.2 Standard CMOS Setup

1. Press <ENTER> on "Standard CMOS Setup" of the main menu screen .

```

AMIBIOS SETUP - STANDARD CMOS SETUP
(C)1996 American Megatrends, Inc. All Rights Reserved

```

```

Date (mm/dd/yyyy): Mon Jul 28, 1997
Time (hh/mm/ss): 17:09:25

Floppy Drive A: 1.44 MB 3 1/2
Floppy Drive B: Not Installed

```

	Type	Size	Cyln	Head	WPcom	Sec	LBA Mode	Blk Mode	PIO Mode	32Bit Mode
Pri Master	:Auto						ON	ON	AUTO	ON
Pri Slave	:Auto						ON	ON	AUTO	ON
Sec Master	:Auto						ON	ON	AUTO	ON
Sec Slave	:Auto						ON	ON	AUTO	ON

```

Boot Sector Virus Protection Disabled

```

```

Month : Jan-Dec          ESC:Exit :Sel
Day   : 01-31           PgUp/PgDn:Modify
Year  : 1901-2099      F2/F3:Color

```

2. Use <Up> and <Down> to choose the item and <PgUp> and <PgDn> keys to modify the highlighted item.
3. After you have finished with the Standard CMOS Setup, press <ESC> to go back to the main menu.

3.3 Advanced CMOS Setup

1. Press <ENTER> on “Advanced CMOS Setup” of the main menu

AMIBIOS SETUP - ADVANCED CMOS SETUP		
(C) 1996 American Megatrends, Inc. All Rights Reserved		
Quick Boot	Disabled	Available Options: Enabled Disabled
1st Boot Device	FLOPPY	
2nd Boot Device	IDE-0	
3rd Boot Device	CD-ROM	
Try Other Boot Devices	Yes	
Floppy Access Control	Read-Write	
Hard Disk Access Control	Read-Write	
S.M.A.R.T. for Hard Disks	Disabled	
BootUp Num-Lock	On	
Floppy Drive Swap	Disabled	
Floppy Drive Seek	Disabled	
PS/2 Mouse Support	Enabled	
Primary Display	VGA/EGA	
Password Check	Setup	
Boot to OS/2	No	
System BIOS Cacheable	Enabled	
C000, 16k Shadow	Cached	
C400, 16k Shadow	Cached	
C800, 16k Shadow	Disabled	
CC00, 16k Shadow	Disabled	
D000, 16k Shadow	Disabled	
D400, 16k Shadow	Disabled	
D800, 16k Shadow	Disabled	
DC00, 16k Shadow	Disabled	
		ESC:Exit :Sel PgUp/PgDn:Modify F2/F3:Color

2. Use <Up> and <Down> to choose the item and <PgUp> and <PgDn> keys to modify the highlighted item.
3. After you have finished with the Advanced CMOS Setup, press <ESC> to go back to the main menu.

Description of the item on screen follows:**Quick Boot**

Set this option to Enabled to permit AMI® BIOS to boot within 5 seconds. This option replaces the old ABOVE 1 MB Memory Test option. The Optimal default setting is Enabled. The Fail-Safe default setting is Disabled.

1st Boot Device/2nd Boot Device/3rd Boot Device

This option sets the sequence of boot drives.

The settings are:

IDE0	The system will boot from the first HDD.
IDE1	The system will boot from the Second HDD.
IDE2	The system will boot from the Third HDD.
IDE3	The system will boot from the Fourth HDD.
F(optical)	The system will boot from LS-120(120M Floppy).
SCSI	The system will boot from the SCSI.
Network	The system will boot from the Network drive.
CD-ROM	The system will boot from the CD-ROM.
Disable	Disable this sequence.

Try other Boot Devices

This option sets the device boot, if all the Four Boot Devices failed.

Floppy Access Control

This option sets the Floppy to Read-only or Read-Write.

HDD Access Control

This option sets the HDD to Read-only or Read-Write. During Read-only, if you try to write on the HDD, the system will halt.

S.M.A.R.T. for Hard Disks

This option sets the SMART Function for the Hard Disk. The Hard Disk has to have SMART function for this feature to take effect.

Boot up Num Lock

When this option is set to Off, AMI® BIOS turns off the Num Lock key when the system is powered on. The end user can then use the arrow keys on both the numeric keypad and the keyboard. The settings are On or Off. The optimal default and Fail-Safe default settings are On.

Floppy Drive Swap

Set this option to Enabled to specify that floppy drives A: and B: are swapped. The setting are Enabled and Disabled. The Optimal and Fail-Safe default settings are Disabled.

Floppy Drive Seek

When this option is set to Enabled, AMI® BIOS performs a Seek command on floppy drive A: before booting the system. The settings are Enabled and Disabled. The Optimal and Fail-Safe default settings are Disabled.

PS/2® Mouse Support

When this option is set to Enabled, AMI® BIOS supports a PS/2-type mouse. The settings are Enabled and Disabled. The Optimal and Fail-Safe default settings are Enabled.

Primary Display

This option configures the primary display subsystem in the computer. The settings are Mono(monochrome), 40CGA, 80CGA or VGA/EGA. The optimal and Fail-Safe default settings are VGA/EGA.

Password Check

This option specifies the type of AMI® BIOS password protection that is implemented. The Optimal and Fail-Safe default settings are Setup.

Boot to OS/2®

Set this option to Enabled to permit the BIOS to run properly, if OS/2® is to be used with > 64MB of DRAM. The settings are Enabled or Disabled. The Optimal and Fail-safe default settings are Disabled.

System BIOS Cacheable

AMI® BIOS always copies the system BIOS from ROM to RAM for faster execution. Set this option to Enabled to permit the contents of the F0000h RAM memory segment to be written to and read from cache memory. The settings are Enabled or Disabled. The Optimal default setting is Enabled. The Fail-Safe default setting is Disabled.

C000, 16K Shadow/C400, 16k Shadow

These options specify how the contents of the video ROM are handled. The settings are:

Disabled - the Video ROM is not copied to RAM.

Cached - the contents of the video ROM from C0000h - C7FFFh are not only copied from ROM to RAM; it can also be written to or read from cache memory.

Shadow - the Contents of the video ROM from C0000h - C7FFFh are copied(shadowed) from ROM to RAM for faster execution.

The Optimal and Fail-Safe default setting is Cached.

C800, 16k Shadow/CC00, 16k Shadow/D000, 16K Shadow/D400, 16k Shadow/D800, 16k Shadow/DC00, 16K Shadow

These options specify how the contents of the adaptor ROM named in the option title are handled. The ROM area that is not used by ISA adapter cards will be allocated to PCI adapter cards. The settings are;

Disabled - The specified ROM is not copied to RAM.

Cache - The contents of the ROM area are not only copied from ROM to RAM for faster execution, it can also be written to or read from cache memory.

Shadow - The contents of the ROM area are copied from ROM to RAM for faster execution.

The Optimal and Fail-Safe default settings are Disabled.

3.4 Advanced Chipset Setup

1. Press <ENTER> on “Advanced Chipset Setup” of the main menu screen.

AMIBIOS SETUP - ADVANCED CHIPSET SETUP		
(C) 1996 American Megatrends, Inc. All Rights Reserved		
Auto Configure EDO DRAM Timing	Enabled	Available Options:
EDO DRAM Speed (ns)	60	Enabled
EDO Read Burst Timing	x222	Disabled
EDO Write Burst Timing	x222	
EDO RAS Precharge Timing	3 clocks	
EDO RAS to CAS Delay	3 clocks	
MA wait State	Fast	
***** SDRAM Timing *****		
SDRAM RAS to CAS Delay	2 Clks	
SDRAM CAS Latency	3 Clks	
SDRAM RAS Precharge Time	2 Clks	
DRAM Integrity Mode	Non ECC	
VGA Frame Buffer USWC	Disabled	
PCI Frame Buffer USWC	Disabled	
Fixed Memory Hole	Disabled	
CPU To PCI IDE Posting	Enabled	
USWC Write I/O Post	Disabled	
AGP Aperture Size	64 MB	
USB Passive Release	Enabled	
PIIX4 Passive Release	Enabled	
PIIX4 Delayed Transaction	Enabled	
USB Function	Enabled	
USB Keyboard Legacy Support	Disabled	
		ESC:Exit :Sel
		PgUp/PgDn:Modify
		F2/F3:Color

2. Use <Up> and <Down> to choose the item and <PgUp> and <PgDn> keys to modify the highlighted item.
3. After you have finished with the Advanced Chipset Setup, press <ESC> to go back to the main menu.

Description of the item on screen follows:**Auto Configure EDO DRAM Timing**

Choose Enabled(default) will automatically configure the DRAM timing depending on the “DRAM Speed” selection. Choose disable to customize setup.

EDO DRAM Speed (ns)

This option specifies the RAS access time (in nanoseconds) for the DRAM used in the computer. The settings are 50,60 or 70. The Optimal default setting is 60 and the Fail-Safe default setting is 70.

EDO DRAM Read Burst Timing

Choose DRAM read burst timing for the customize setup. B stand for BEDO DRAM, E stand for EDO DRAM and F stand for FAST PAGE DRAM.

EDO DRAM Write Burst Timing

Choose DRAM write burst timing for the customize setup.

EDO RAS Precharge Timing

This option defines the RAS# precharge requirements for the EDO memory type in 66MHz clocks.

EDO RAS to CAS Delay

This operation decide the delay in assertion of CAS#(SCAS#) from assertion of RAS#(SRAS#) in 66MHz.

MA Wait State

This option selects Fast or Slow MA bus timing. The Slow timing is equal to Fast+1, in term of clock number for EDO DRAM.

SDRAM RAS to CAS Delay

This operation decide the delay in assertion of CAS#(SCAS#) from assertion of RAS#(SRAS#) in 66MHz.

SDRAM CAS Latency

This option determines the CAS latency time parameter of SDRAM. The settings are 2 clks or 3 clks.

SDRAM RAS Precharge Time

This option defines the RAS# precharge requirements for the SDRAM memory type in 66MHz clocks.

DRAM Integrity Mode

During ECC, this will enable the DRAM ECC mechanism that allows detection of single-bit and multiple-bit errors and recovery of single-bit errors. During EC, the ECC logic will calculate 8-bit pattern written along with 64-bit data into the main memory. During Read operation, 8-bit ECC code is read along with 64-bit data and error checking is performed. No correction of data will take place in this operation mode. During Disabled, this will disable the ECC mechanism.

Note: If you choose ECC or EC modes, you must use a DIMM with ECC byte.

VGA Frame Buffer USWC

The Pentium® II processor supports the Uncacheable Speculatable Write-Combining (USWC) memory type. The processor provides a write-combining with buffering strategy for write operation. This is useful for frame buffering. Writing to USWC memory can be buffered and combined in the processors write-combining buffer (WCB). The WCBs are viewed as a special purpose outgoing write buffers, rather than a cache. The WCBs are written into memory to allocate a different address, or after executing a serializing, locked, or I/O instructions.

During Enabled, this will enable the processor memory location A000 and B000 segment as USWC memory type.

PCI Frame Buffer USWC

The Pentium® II processor supports the Uncacheable Speculatable Write-Combining (USWC) memory type. The processor provides a write-combining with buffering strategy for write operation. This is useful for frame buffering. Writing to USWC memory can be buffered and combined in the processors write-combining buffer (WCB). The WCBs are viewed as a special purpose outgoing write buffers, rather than a cache. The WCBs are written into memory to allocate a different address, or after executing a serializing, locked, or I/O instructions.

During Enabled, this will enable the processor memory location C000 and DFFF segment as USWC memory type.

DRAM Refresh Queue

Choose Enabled, the system will provide 4-deep refresh queue. All refresh request are queued, with the 4th refresh request being the priority request. All refresh requests are priority when the refresh queue is Disabled.

Fixed Memory Hole

This option allows the end user to specify the location of a memory hole. The cycle matching the selected memory hole will be passed to the ISA bus. If Enabled, the selected hole is not remapped.

CPU To PCI IDE Posting

Set this option to Enabled to enable posted messages from the CPU to the PCI bus or IDE controller. The settings are Enabled or Disabled. The Optimal and Fail-Safe default settings are Enabled.

USWC Write I/O Post

Set this option to Enabled to use USWC(Uncacheable, Speculatable, Write-Combined) memory. The settings are Enabled or Disabled. The Optimal and Fail-Safe default settings are Disabled.

AGP Aperture Size

This option determines the effective size of the graphics aperture used in the particular PAC configuration. The AGP aperture is memory-mapped, while graphics data structure can reside in a graphics aperture. The aperture range should be programmed as not cacheable in the processor cache, accesses with the aperture range are forwarded to the main memory, then PAC will translate the original issued address via a translation table that is maintained on the main memory. The option allows the selection of an aperture size of 4MB, 8MB, 16MB, 32MB, 64MB, 128MB, and 256MB.

USB Passive Release

During Enabled, this will allow the PIIX4® to use passive release(look at PIIX4® Passive Release) while transferring control information or data for USB transaction. During Disabled, PIIX4® will perform PCI accesses for USB without using passive release.

PIIX4® Passive Release

The PIIX4® ISA bridge support GAT (Guaranteed Access Time) mode, which will now violate the spirit of the PCI specification. The systems provides a programmable passive release mechanism to meet the required master latencies. During Enabled, ISA masters may see long delays in accessing PCI memory, including the main DRAM array. The ISA GAT mode is also not supported during enable. ISA masters must honor IOCHRDY.

PIIX4® Delayed Transaction

During Enabled, the PIIX4® delay transaction mechanism is enabled when the PIIX4® is the target of a PCI transaction. A read cycle from Host to PCI is immediately retrived due to any pending PCI to DRAM cycle. During Disabled, a read cycle from Host to PCI is waited until time-out due to any pending PCI to DRAM cycle.

USB Function

Set this option to Enabled or Disabled the on-chip USB controller.
The Optional and Fail-Safe default settings are Disabled.

USB Keyboard Legacy Support

Set this option to Enabled or Disabled USB keyboard/mouse.
The Optional and Fail-Safe default settings are Disabled.

3.5 Power Management Setup

1. Press <ENTER> on “Power Management Setup” of the main menu screen.

AMIBIOS SETUP - POWER MANAGEMENT SETUP		
(C) 1996 American Megatrends, Inc. All Rights Reserved		
Power Management / APM	Disabled	Available Options:
Green PC Monitor Power State	Stand By	Enabled
Video Power Down Mode	Suspend	Disabled
Hard Disk Power Down Mode	Stand By	
Standby Time Out	Disabled	
Suspend Time Out	Disabled	
Throttle Slow Clock Ratio	50-62.5%	
Modem Use IO Port	N/A	
Modem Use IRQ	N/A	
Display Activity	Ignore	
Device 6(Serial Port 1)	Monitor	
Device 7(Serial Port 2)	Monitor	
Device 8(Parallel Port)	Ignore	
Device 5(Floppy Disk)	Monitor	
Device 0(Primary master IDE)	Monitor	
Device 1(Primary slave IDE)	Ignore	
Device 2(Secondary master IDE)	Monitor	
Device 3(Secondary slave IDE)	Ignore	
System Thermal	Ignore	
Thermal Slow Clock Ratio	50-62.5%	
CPU Critical Temperature	40°C/104°F	ESC:Exit :Sel
Power Button Function	ON/OFF	PgUp/PgDn:Modify
Power Supply Type	ATX	F2/F3:Color

Ring Resume From Soft-Off	Disabled
RTC Alarm Resume From Soft-Off	Disabled
RTC Alarm Date	15
RTC Alarm Hour	12
RTC Alarm Minute	50
RTC Alarm Second	30

2. Use <Up> and <Down> to choose the item and <PgUp> and <PgDn> keys to modify the highlighted item.
3. After you have finished with the Power Management Setup, press <ESC> to go back to the main menu.

Description of the item on screen follows:**Power Management/APM**

Set this option to Enabled to enable the Intel® 82440LX ISA power management features and APM(Advanced Power Management). The settings are Enabled, Inst-On(instant-on) or Disabled. The Optimal and Fail-Safe default settings are Disabled.

Green PC Monitor Power State

This option specifies the power state that the green PC-compliant video monitor enters when AMI® BIOS places it in a power savings state after the specified period of display inactivity has expired. The settings are Off, Standby, Suspend or Disabled. The Optimal and Fail-Safe default settings are Standby.

Video Power Down Mode

This option specifies the power conserving state that the VESA VGA video subsystem enters after the specified period of display inactivity has expired. The settings are Disabled, Standby or Suspend. The Optimal and Fail-Safe default settings are Standby.

Hard Disk Power Down Mode

This option specifies the power conserving state that the hard disk drive enters after the specified period of hard drive inactivity has expired. The settings are Disabled, Standby or Suspend. The Optimal and Fail-Safe default settings are Disabled.

Standby Time Out

This option specifies the length of a period of system inactivity while in Full power on state. When this length of time expires, the computer enters Standby power state. The settings are Disabled, 1 min, 2 min, 3 min, 4 min, 5 min, 6 min, 7 min, 8 min, 9 min, 10 min, 11 min, 12 min, 13 min, 14 min or 15 min. The Optimal and Fail-Safe default settings are Disabled.

Suspend Time Out

This option specifies the length of a period of system inactivity while in Standby state. When this length of time expires, the computer enters Suspend power state. The settings are Disabled, 1 min, 2 min, 3 min, 4 min, 5 min, 6 min, 7 min, 8 min, 9 min, 10 min, 11 min, 12 min, 13 min, 14 min or 15 min. The Optimal and Fail-Safe default settings are Disabled.

Throttle Slow Clock Ratio

This option specifies the speed at which the system clock runs in power saving states. The settings are expressed as a ratio between the normal CPU clock speed and the CPU clock speed when the computer is in the power-conserving state.

Modem Use IO Port

This indicates which IO port will be used by the Modem(if there is a Modem).

Modem Use IRQ

This indicates which IRQ no. will be used by the Modem(if there is a Modem).

Display Activity/Device 6/Device 7/Device 8/Device 5/Device 0/Device 1/Device 1/Device 2/Device 3/System Thermal

When set to Monitor, these options enable event monitoring on the specified hardware interrupt request line. If set to Monitor and the computer is in a power saving state, AMI® BIOS watches for activity on the specified IRQ line. The computer enters the full on power state if any activity occurs.

AMI® BIOS reloads the Standby and Suspend timeout timers if activity occurs on the specified IRQ line.

Power Button Function

During Suspend, if you push the switch one time, the system goes into suspend mode and if you push it more than 4 seconds, the system will be turned off. During On/Off, the system will turn off once you push the switch.

Ring Resume from Soft-Off

During Disabled, the system will ignore any incoming call from the modem. During Enabled, the system will boot up if there's an incoming call from the modem.

Note: If you have change the setting, you must let the system boot up until it goes to the operating system. Then, power off the system. This function will work the next time you power on.

RTC Alarm Resume From Soft-Off

This function is for setting the Date, Hour, Minute, and Second for your computer to boot up. During Disabled, you cannot use this function. During Enabled, Choose the Date, Hour, Minute, and Second:

RTC Alarm Date	Choose which day the system will boot up.
RTC Alarm Hour	Choose which hour the system will boot up.
RTC Alarm Minute	Choose which minute the system will boot up.
RTC Alarm Second	Choose which second the system will boot up.

Note: If you have change the setting, you must let the system boot up until it goes to the operating system. Then, power off the system. This function will work the next time you power on.

3.6 PCI/Plug and Play Setup

1. Press <ENTER> on “PCI/Plug and Play Setup” of the main menu screen.

AMIBIOS SETUP - PCI/PLUG AND PLAY SETUP		
(C) 1996 American Megatrends, Inc. All Rights Reserved		
Plug and Play Aware O/S	No	Available Options:
PCI Latency Timer (PCI Clocks)	64	Enabled
PCI VGA Palette Snoop	Disabled	Disabled
Allocate IRQ to PCI VGA	Yes	
PCI IDE Busmaster	Disabled	
OffBoard PCI IDE Card	Auto	
OffBoard PCI IDE Primary IRQ	Disabled	
OffBoard PCI IDE Secondary IRQ	Disabled	
DMA Channel 0	PnP	
DMA Channel 1	PnP	
DMA Channel 3	PnP	
DMA Channel 5	PnP	
DMA Channel 6	PnP	
DMA Channel 7	PnP	
IRQ3	PCI/PnP	
IRQ4	PCI/PnP	
IRQ5	PCI/PnP	
IRQ7	PCI/PnP	
IRQ8	PCI/PnP	
IRQ9	PCI/PnP	
IRQ10	PCI/PnP	
IRQ11	PCI/PnP	ESC:Exit :Sel
IRQ12	PCI/PnP	PgUp/PgDn:Modify
IRQ14	PCI/PnP	F2/F3:Color
IRQ15	PCI/PnP	
Reserved Memory Size	Disabled	
Reserved Memory Address	C8000	

2. Use <Up> and <Down> to choose the item and <PgUp> and <PgDn> keys to modify the highlighted item.
3. After you have finished with the PCI/Plug and Play Setup, press <ESC> to go back to the main menu.

Description of the item on screen follows:**Plug and Play Aware O/S**

Set this option to Yes if the operating system in this computer is aware of and follows the Plug and Play specification. Currently, only Windows 95® is PnP-aware. The settings are Yes or No. The Optimal and Fail-Safe default settings No.

PCI Latency Timer (PCI Clocks)

This option specifies the latency timings (in PCI clocks) for all PCI devices on the PCI bus. The settings are 32, 64, 96, 128, 160, 192, 224 or 248. The Optimal and Fail-Safe default settings are 64.

PCI VGA Palette Snoop

When this option is set to Enabled, multiple VGA devices operating on different buses can handle data from the CPU on each set of palette registers on every video device. Bit 5 of the command register in the PCI device configuration space is the VGA Palette Snoop bit (0 is disabled). For example, if there are two VGA devices in the computer (one PCI and ISA) and the Bit settings are:

Disabled - Data read and written by the CPU is only directed to the PCI VGA device's palette registers.

Enabled - Data read and written by the CPU is directed to both the PCI VGA device's palette registers and the ISA VGA device palette registers, permitting the palette registers of both devices to be identical.

This option must be set to Enabled if an ISA adapter card requires VGA palette snooping. The settings are Enabled or Disabled. The Optimal and Fail-Safe default settings are Disabled.

Allocate IRQ to PCI VGA

Choose the IRQ to be assigned to the PCI VGA display adapter card. The Optimal and Fail-Safe default setting is No.

PCI IDE BusMaster

Set this option to Enabled to specify that the IDE controller on the PCI local bus includes a bus mastering capability. The settings are Enabled or Disabled. The Optimal and Fail-Safe default settings are Disabled.

Offboard PCI IDE Card

This option specifies if an offboard PCI IDE controller adapter card is installed in the computer. You must specify the PCI expansion slot on the mainboard where the offboard PCI IDE controller is installed. If an offboard PCI IDE controller is used, the onboard IDE controller is automatically disabled. The settings are Auto(AMI® BIOS automatically determines where the offboard PCI IDE controller adapter card is installed), Slot1, Slot2, Slot3 or Slot4. The Optimal and Fail-Safe settings are Auto.

If an offboard PCI IDE controller adapter card is installed in the computer, you must also set the Offboard PCI IDE Primary IRQ and Offboard PCI IDE Secondary IRQ options.

**Offboard PCI IDE Primary IRQ/
Offboard PCI IDE Secondary IRQ**

These options specify the PCI interrupt used by the Primary (or Secondary) IDE channel on the offboard PCI IDE controller. The settings are Disabled, Hardwired, INTA, INTB, INTC or INTD. The Optimal and Fail-Safe default settings are Disabled.

DMA Channel 0/1/3/5/6/7

These options specify the bus that the specified DMA channel is used. These options allow you to reserve DMAs for legacy ISA adapter cards.

These options determine if AMI® BIOS should remove a DMA from the available DMAs passed to devices that are configurable by the system BIOS. The available DMA pool is determined by reading the ESCD NVRAM. If more DMAs must be removed from the pool, the end user can use these options to reserve the DMA by assigning an ISA/EISA setting to it.

IRQ3/IRQ4/IRQ5/RQ7/IRQ9/IRQ10/IRQ11/IRQ14/IRQ15

These options specify the bus that the specified IRQ line is used on. These options allow you to reserve IRQs for legacy ISA adapter cards.

These options determine if AMI® BIOS should remove an IRQ from the pool of available IRQs passed to devices that are configurable by the system BIOS. The available IRQ pool is determined by reading the ESCD NVRAM. If more IRQs must be removed from the pool, the end user can use these options to reserve the IRQ by assigning an ISA/EISA setting to it. Onboard I/O is configured by AMI® BIOS. All IRQs used by onboard I/O are configured as PCI/PnP. If all IRQs are set to ISA/EISA and IRQ14 and 15 are allocated to the onboard PCI IDE, IRQ9 will still be available for PCI and PnP devices, because at least one IRQ must be available for PCI and PnP devices. The settings are ISA/EISA or PCI/PnP. The Optimal and Fail-Safe default settings are IRQ3 through 7 are ISA/EISA. The Optimal and Fail-Safe default settings PCI/PnP.

Reserved Memory Size/Reserved Memory Address

Some ISA cards have ROM at 0C000h~0D000h segments, but in a non-standard format. So Plug & Play BIOS can't detect it. The end user needs to set it up manually. Setting these options under this condition, will inform the BIOS which location and how many location is occupied.

3.7 Peripheral Setup

1. Press <ENTER> on “Peripheral Setup” of the main menu screen.

AMIBIOS SETUP - PERIPHERAL SETUP		
(C) 1996 American Megatrends, Inc. All Rights Reserved		
OnBoard FDC	Auto	Available Options:
OnBoard Serial PortA	Auto	Enabled
OnBoard Serial PortB	Auto	Disabled
IR Port Support	Disabled	
IR Mode Select	SIR	
IR Base Address Select	2E8	
IR IRQ Select	10	
IR DMA Select	Disabled	
OnBoard Parallel Port	Auto	
Parallel Port Mode	EPP	
EPP Version	N/A	
Parallel Port IRQ	7	
Parallel Port DMA Channel	N/A	
Keyboard to wake-up System	Disabled	
Keyboard to wake-up System	Disabled	
Onboard IDE	Reserved	
		ESC:Exit :Sel PgUp/PgDn:Modify F2/F3:Color

2. Use <up> and <down> to choose the item and <PgUp> and <PgDn> keys to modify the highlighted item.
3. After you have finished with the Peripheral Setup, press <ESC> to go back to the main menu.

Description of the item on screen follows:

Onboard FDC

Choose Auto, for the BIOS to automatically detect the device

If the ISA add-on card has	Onboard FDC to be set at
FDC exist	Disabled
none FDC exist	Enabled

Choose Enabled, Enabling onboard FDC.

Choose Disabled, Disabling onboard FDC.

The Optimal and Fail-Safe default settings are Auto.

Onboard Serial Port A/Onboard Serial Port B

Choose 3F8, for the BIOS to automatically detect the device.

If the ISA add-on card has				Onboard Serial port to be set at			
COM1 (I/O:3F8H)	COM2 (I/O:3F8H)	COM3 (I/O:3E8H)	COM4 (I/O:2E8H)	PORT1	IRQ ASSIGNED	PORT2	IRQ ASSIGNED
✓	✓	✓	✓	DISABLED	X	DISABLED	X
✓	✓	X	X	COM3	4	COM4	3
X	X	✓	✓	COM1	4	COM2	3
✓	X	X	✓	COM2	3	COM3	4
X	✓	✓	X	COM1	4	COM4	3
✓	✓	✓	X	COM4	3	DISABLED	X
✓	✓	X	✓	COM3	4	DISABLED	X
✓	X	✓	✓	COM2	3	DISABLED	X
X	✓	✓	✓	COM1	4	DISABLED	X
X	X	X	X	COM1	4	COM2	3
✓	X	X	X	COM2	3	COM3	4
X	✓	X	X	COM1	4	COM3	4
X	X	✓	X	COM1	4	COM2	3
X	X	X	✓	COM1	4	COM2	3

Note: *If the onboard serial port interrupt and ISA add-on card interrupt are in conflict, the serial port will not work properly. Please disable one of the devices.*

IR Port Support

Choose Auto, the BIOS will automatically assigned onboard port for IR.

IR Mode Select

This option is for selecting address mode for IR.

IR Base Address Select

This option will assigned which base address will be used by IR

IR IRQ Select

This option is for selecting the IRQ for the IR.

IR DMA Select

This option is for selecting the DMA for the IR.

Onboard Parallel Port

Choose Auto, the BIOS automatically assigned onboard parallel port to the available parallel port or disabled.

If the ISA add-on card has			Onboard parallel port to be set as	
LPT1 I/O:378H	LPT2 I/O:278H	LPT3 I/O:3BCH	PORT ASSIGNED	IRQ ASSIGNED
✓	✓	✓	Disabled	X
✓	✓	X	LPT3	5
✓	X	✓	LPT2	5
X	✓	✓	LPT1	7
✓	X	X	LPT2	5
X	✓	X	LPT1	7
X	X	✓	LPT1	7
X	X	X	LPT1	7

Note: *If the onboard parallel port interrupt and ISA add-on card interrupt are in conflict, the parallel port will not work properly. Please disable one of the devices.*

EPP Version

This option is for setting which EPP version will be used. The settings are 1.7 and 1.9.

Parallel Port Mode

This option allows user to choose the operating mode of the onboard parallel port. The settings are Normal, SPP/EPP or ECP mode.

Parallel Port IRQ

If the onboard parallel mode is not on auto mode, the user can select the interrupt line for onboard parallel port. We suggest that the user select the interrupt for the onboard parallel port as shown below:

Onboard parallel port set at	Parallel Port IRQ
LPT1(378H)	7
LPT2(278H)	5
LPT3(3BCH)	5

Parallel Port DMA Channel

This option allows user to choose DMA channel 1 to 3 for the onboard parallel port on ECP mode.

Keyboard to wake-up System

During Enabled, if there is any activity on the keyboard, the system will change from suspend to ON. During Disabled, this function will not work. (This is reserved for future "New Super I/O -W83977TF)

PS/2 mouse to wake-up System

During Enabled, if there is any activity on the mouse, the system will change from suspend to ON. During Disabled, this function will not work. (This is reserved for future "New Super I/O -W83977TF)

Onboard IDE

Set this option to enable or disable on board IDE controller.

3.8 Hardware Monitor Setup

The Hardware Monitor Setup is used to monitor the Current CPU temperature, CPU Fan speed, Chassis Fan Speed, Power fan speed, Vcore, and etc.

AMIBIOS SETUP - HARDWARE MONITOR SETUP	
(C) 1996 American Megatrends, Inc. All Rights Reserved	
--System Hardware Monitor--	
Current CPU Temperature	30°C/100°F
Current CPU Fan Speed	5273RPM
Current Chassis Fan Speed	0 RPM
Current Power Fan Speed	0 RPM
Vcore	0.512V
Vtt	0.016V
Vio	0.032V
+5,000V	0.000V
+12,000V	0.243V
-12,000V	-0.222V
-5,000V	-0.144V
Available Options:	
Enabled	
Disabled	
ESC:Exit :Sel	
PgUp/PgDn:Modify	
F2/F3:Color	