



# **SY-K7V DRAGON Motherboard**

\*\*\*\*\*

K7 Ath1on & Duron

Processor supported

VIA KT266 AGP/PCI Motherboard

100/133 MHz Front Side Bus supported

ATX Form Factor

\*\*\*\*\*

## **User's Manual**

Copyright © 2001 by Soyo Computer Inc.

**Trademarks:**

Soyo is the registered trademark of Soyo Computer Inc. All trademarks are the properties of their owners.

**Product Rights:**

All names of the product and corporate mentioned in this publication are used for identification purposes only. The registered trademarks and copyrights belong to their respective companies.

**Copyright Notice:**

All rights reserved. This manual has been copyrighted by Soyo Computer Inc. No part of this manual may be reproduced, transmitted, transcribed, translated into any other language, or stored in a retrieval system, in any form or by any means, such as by electronic, mechanical, magnetic, optical, chemical, manual or otherwise, without permission in writing from Soyo Computer Inc.

**Disclaimer:**

Soyo Computer Inc. makes no representations or warranties regarding the contents of this manual. We reserve the right to amend the manual or revise the specifications of the product described in it from time to time without obligation to notify any person of such revision or amend. The information contained in this manual is provided to our customers for general use. Customers should be aware that the personal computer field is subject to many patents. All of our customers should ensure that their use of our products does not infringe upon any patents. It is the policy of Soyo Computer Inc. to respect the valid patent rights of third parties and not to infringe upon or to cause others to infringe upon such rights.

**Restricted Rights Legend:**

Use, duplication, or disclosure by the Government is subject to restrictions set forth in subparagraph (c)(1)(ii) of the Rights in Technical Data and Computer Software clause at 252.277-7013.

**About This Guide:**

This Quick Start Guide can help system manufacturers and end users in setting up and installing the Motherboard. Information in this guide has been carefully checked for reliability; however, to the correctness of the contents there is no guarantee given. The information in this document is subject to amend without notice.

For further information, please visit our **Web Site** on the Internet. The address is "<http://www.soyo.com.tw>".

**Edition: August 2001**  
**Version 1.1**  
**K7V DRAGON SERIAL**

**FC** Tested To Comply  
With FCC Standards  
FOR HOME OR OFFICE USE

**100%** POST CONSUMER  
RECYCLED PAPER

# Table of Contents

<b>CHAPTER 1</b>	<b>MOTHERBOARD DESCRIPTION.....</b>	<b>1</b>
1-1	INTRODUCTION.....	1
1-2	KEY FEATURES .....	1
1-3	HANDLING THE MOTHERBOARD .....	4
1-4	ELECTROSTATIC DISCHARGE PRECAUTIONS.....	5
1-5	SY-K7V DRAGON MOTHERBOARD LAYOUT.....	6
1-6	SY-K7V DRAGON MOTHERBOARD COMPONENTS .....	7
1-7	MICROPROCESSOR.....	9
1-8	MEMORY .....	10
1-9	CHIPSET.....	11
1-10	I/O INTERFACE CONTROLLER.....	15
1-11	HARDWARE MONITOR.....	18
1-12	WAKE ON LAN TECHNOLOGY .....	18
<b>CHAPTER 2</b>	<b>HARDWARE INSTALLATION .....</b>	<b>19</b>
2-1	PREPARATIONS.....	19
2-2	UNPACKING THE MOTHERBOARD .....	20
2-3	INSTALLATION GUIDE .....	21
2-3.1	<i>CPU Installation .....</i>	<i>22</i>
2-3.2	<i>DDR RAM Memory Module Installation.....</i>	<i>26</i>
2-3.3	<i>Motherboard Connector.....</i>	<i>27</i>
2-3.4	<i>Jumper Setting (RAID_IDE) .....</i>	<i>43</i>
2-3.5	<i>CMOS Clear (JP5).....</i>	<i>44</i>
2-3.6	<i>Power On .....</i>	<i>44</i>
2-3.7	<i>Quick BIOS Setup.....</i>	<i>45</i>
2-3.8	<i>Troubleshooting at First Start .....</i>	<i>47</i>
2-3.9	<i>Power Off.....</i>	<i>50</i>
<b>CHAPTER 3</b>	<b>BIOS SETUP UTILITY .....</b>	<b>51</b>

3-1	SOYO COMBO SETUP .....	54
3-2	STANDARD CMOS SETUP .....	58
3-3	ADVANCED BIOS FEATURES .....	62
3-4	ADVANCED CHIPSET FEATURES .....	66
3-5	INTEGRATED PERIPHERALS.....	74
3-6	POWER MANAGEMENT SETUP .....	80
3-7	PNP/PCI CONFIGURATIONS.....	86
3-8	PC HEALTH STATUS .....	89
3-9	LOAD FAIL-SAFE DEFAULTS .....	91
3-10	LOAD OPTIMIZED DEFAULTS.....	92
3-11	SET SUPERVISOR PASSWORD .....	93
3-12	SET USER PASSWORD .....	94
<b>CHAPTER 4 DRIVERS INSTALLATION .....</b>		<b>96</b>
<b>CHAPTER 5 VIA ONBOARD LAN DRIVER INSTALLATION.....</b>		<b>101</b>
<b>CHAPTER 6 AUDIO DRIVER INSTALLATION .....</b>		<b>104</b>
<b>CHAPTER 7 PROMISE RAID FAMILY DRIVER INSTALLATION....</b>		<b>105</b>
<b>CHAPTER 8 ULTRA FAMILY DRIVER INSTALLATION.....</b>		<b>107</b>
<b>APPENDIXA FASTTRAK-100-LITE MANUAL .....</b>		<b>109</b>
<b>APPENDIXB C-MEDIA 6 CHANNEL AUDIO SOLUTION MANUAL ...</b>		<b>170</b>
<b>APPENDIXC CONTACT INFORMATION .....</b>		<b>198</b>

## Chapter 1

# MOTHERBOARD DESCRIPTION

### 1-1 INTRODUCTION

The **SY-K7V DRAGON** AGP/PCI Motherboard is a high-performance Socket A ATX form-factor system board. The **SY-K7V DRAGON** uses VIA Chipset technology and supports Socket A class processors. This Motherboard is fully compatible with industry standards and adds many technical enhancements.

### 1-2 KEY FEATURES

#### ➤ CPU SUPPORT

The SY-K7V DRAGON supports THE FOLLOWING AMD<sup>®</sup> K7 CPUs:

- Supports 200/266 MHz Front Side Bus DDR(Double Data Rate) transfer on Athlon (750MHz~1.4GHz) / Duron<sup>™</sup> (600MHz~950MHz)

New released AMD Socket A CPUs will very likely be supported by the SY-K7V DRAGON as well.

#### ➤ CPU SETTINGS

The SY-K7V DRAGON provides the user with a very complete and convenient CPU setting environment. The CPU settings are all adjusted through the special SOYO COMBO page in the BIOS, therefore rendering the use of jumpers obsolete.

##### ■ CPU FSB Frequency

The SY-K7V DRAGON supports a wide range of CPU FSB frequency settings: (CPU FSB Frequency can be setup by 1MHz increment)

- ◆ 100~132MHz for 100MHz FSB CPU
- ◆ 133~233MHz for 133MHz FSB CPU

This ensures that the SY-K7V DRAGON has an overwhelming overclocking potential.



■ **CPU Multiplier**

The SY-K7V DRAGON supports a wide range of multipliers:

6.0x, 6.5x, 7.0x, 7.5x, 8.0x, 8.5x, 9.0x, 9.5x, 10.0x, 10.5x, 11.0x, 11.5x, 12.0x, 13.0x and 14.0x.

➤ **EXPANDABILITY**

The SY-K7V DRAGON provides all the standard expansion slots, and many more additional expansion features:

◆ **Expansion slots**

- 1 x master AGP Pro slot
- 5 x 32-bit bus master PCI slots

◆ **Enhanced IO**

- Floppy disk controller
- 2x EIDE controllers with support for up to 4 Ultra DMA 33/66 /100 devices
- Standard/EPP/ECP parallel port
- 2x 16550 compatible serial ports
- IrDA compatible infrared port
- 6x USB (Universal Serial Bus) connectors
- PS/2 mouse connector
- PS/2 keyboard connector

➤ **IDE RAID FUNCTION**

The K7V DRAGON supports striping (RAID 0), mirroring (RAID 1) or function as regular IDE port.

➤ **C-MEDIA HARDWARE AUDIO**

Supports 4/5/5.1 speakers and DLS based wave table music. Also provides professional SPDIF IN/OUT non-distortion digital interface.

➤ **LAN ON-BOARD**

Supports 10/100 Mbps base-T Ethernet.

➤ **SMART CARD READER**

Compliant with Personal Computer Smart Card(PC/SC) Working Group standard. Supports Smart Card insertion power-on feature.

## ➤ **ADVANCED FUNCTIONS**

The SY-K7V DRAGON supports advanced functions such as:

### ■ **Wake-On-LAN**

Supports Wake-On-LAN (*Some advanced network cards can wake the system up over the network, the WOL connector is provided by the SY-K7V DRAGON to support this function*).

### ■ **Multiple boot**

The SY-K7V DRAGON supports booting from devices such as CD-ROM.

### ■ **Power on by modem or alarm**

If the SY-K7V DRAGON system is in suspend mode, it can be switched back on through the modem or RTC alarm through this function. This opens a lot of possibilities, such as remote access that switches the system on only after the modem receives a call.

## ➤ **FAIL SAFE**

The SY-K7V DRAGON comes with added functionality to make managing the system easy and safe

### ◆ **Hardware Monitor**

The integrated Hardware Monitor IC and Hardware doctor software enables the user to monitor system voltages, temperatures and FAN speeds. This makes sure that the user is full control of the system

### ◆ **Power Failure Resume Function**

This function can be set in the BIOS, and determines whether the system will automatically turn on again after a power failure. This function is indispensable for server systems that need to always be on line.

### ◆ **5VSB Indicator**

This green LED gives an indication of the presence of the 5V Standby voltage. This voltage is always fed into the motherboard and is used for functions such as WOL.

➤ **SOYO Bonus Pack CD-ROM**

➤ **COMPLIANCE**

The SY-K7V DRAGON complies with all important industry standards. The following underlines the reliability of the SY-K7V DRAGON, a motherboard to trust.

- PC99, ACPI compliant

➤ **USER FRIENDLY**

- SOYO COMBO Setup
- Jumperless design
- You can set up the following options through the BIOS setup
  - CPU FSB frequency
  - CPU multiplier
  - CPU Vcore voltage
  - DDR RAM Clock

### 1-3 HANDLING THE MOTHERBOARD

To avoid damage to your Motherboard, follow these simple rules while unpacking:

- Before handling the Motherboard, ground yourself by grasping an unpainted portion of the system's metal chassis.
- Remove the Motherboard from its anti-static packaging. Hold the Motherboard by the edges and avoid touching its components.
- Check the Motherboard for damage. If any chip appears loose, press carefully to seat it firmly in its socket.



**Warning:** Do not apply power if the Motherboard appears damaged. If there is damage to the board, contact your dealer immediately.

---





## **1-4 ELECTROSTATIC DISCHARGE PRECAUTIONS**

Make sure to ground yourself before handling the Motherboard or other system components. Electrostatic discharge can easily damage the components. Note that you must take special precautions when handling the Motherboard in dry or air-conditioned environment.

To protect your equipment from electrostatic discharge, take the following precautions:

- Do not remove the anti-static packaging until you are ready to install.
- Ground yourself before removing any system component from its protective anti-static packaging. (To ground yourself, grasp the expansion slot covers or other unpainted portions of the computer chassis.)
- Frequently ground yourself while working or use a grounding strap.
- Handle the Motherboard by its edges and avoid touching its components.

## 1-5 SY-K7V DRAGON MOTHERBOARD LAYOUT

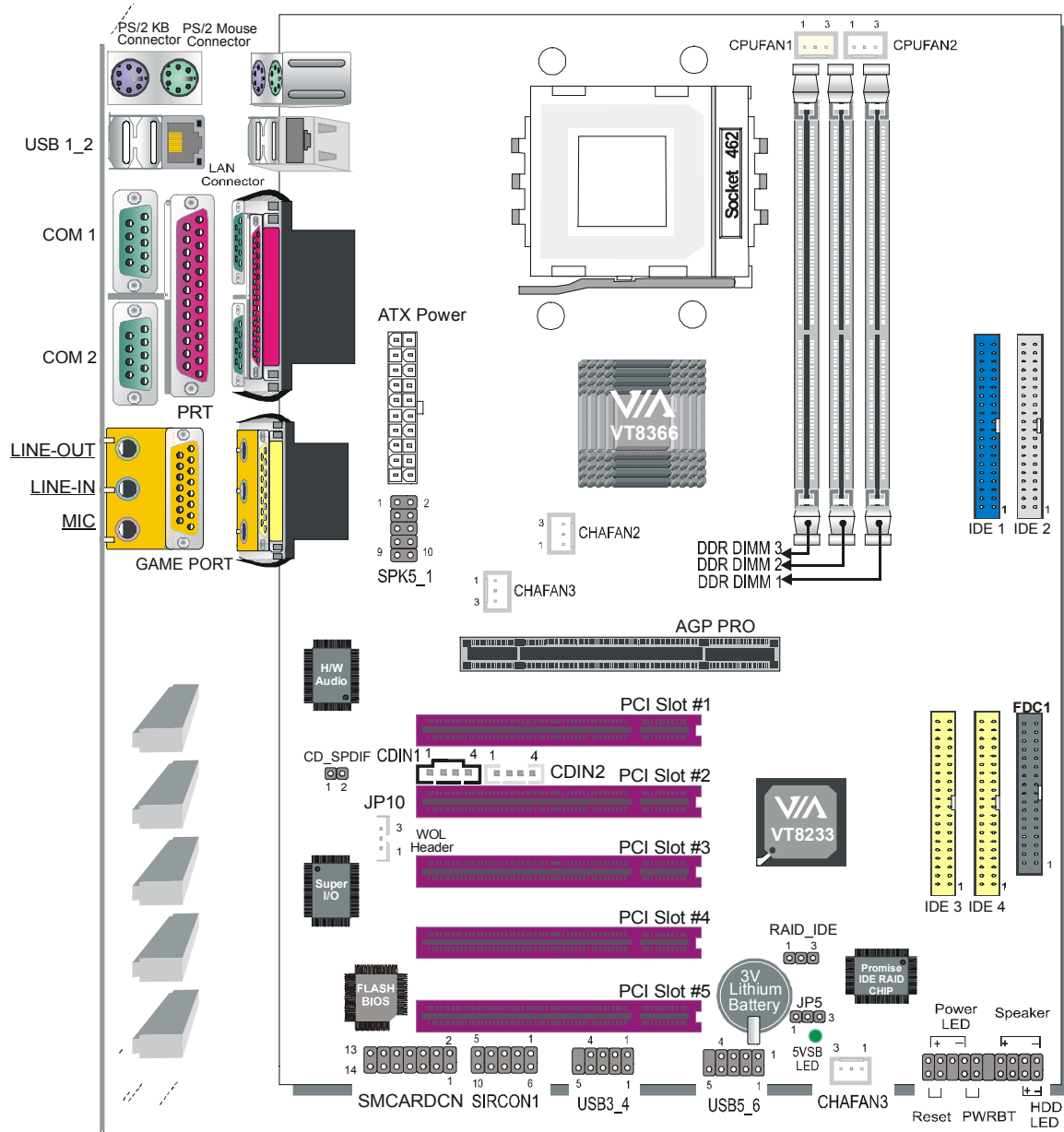

Back Panel

SY-K7V DRAGON Platform

### 1-6 SY-K7V DRAGON MOTHERBOARD COMPONENTS

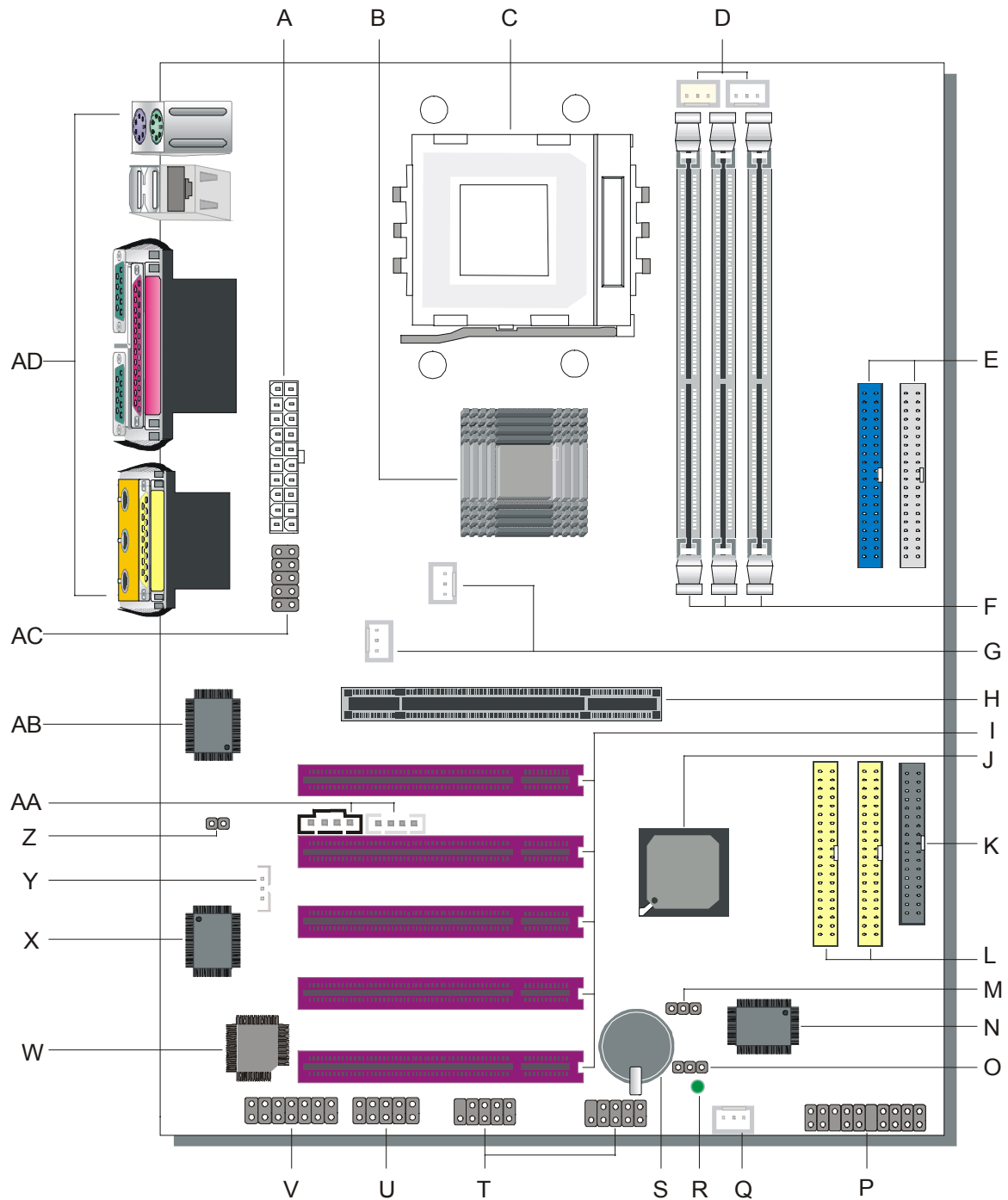

- A ATX Power Supply Connector**
- B VIA VT8366 North Bridge Chip**
- C Socket A Connector**
- D CPU Cooling Fan Connector**
- E Bus Mastering EIDE/ATAPI Ports**
- F DDR DIMM Banks**
- G Chassis Cooling Fan Connector**
- H AGP Pro Slot**
- I 32-bit PCI Mastering Slots**
- J VIA VT8233 South Bridge Chip**
- K Floppy Disk Drive (FDD) Port**
- L IDE RAID Ports**
- M IDE RAID Jumper**
- N Promise IDE RAID Chip**
- O CMOS Clear Jumper**
- P Front Panel Connectors**
- Q Chassis Cooling Fan Connector**
- R 5V Stand-By Indicator LED**
- S 3V Lithium Battery**
- T USB Ports**
- U Serial Infrared (IrDA) Device Header**
- V Smart Card Reader Connector**
- W Flash BIOS**
- X Super I/O Chip**
- Y Wake-On-LAN (WOL) Header**
- Z CD\_SPDIF Connector**
- AA CD-IN Connector**
- AB H/W Onboard Audio Chip**
- AC SPK5\_1 Connector**
- AD Back panel Connectors**

## **1-7 MICROPROCESSOR**

The motherboard supports a single Socket A processor. The processor's VID pins automatically program the voltage regulator on the motherboard to the required processor voltage. In addition, the front side bus speed (100 MHz and 133 MHz) is automatically selected. The motherboard supports all current Socket A processor speeds, voltages, and bus frequencies.

### **1-7.1 Microprocessor Packaging**

The CPU is packaged in a 462 pin PGA package. A CPU fan must be used to ensure adequate cooling.

### **1-7.2 Second Level Cache**

The second-level cache is located on the substrate of the CPU package. The cache includes 0KB/128KB or 512 KB of synchronous pipelined burst static RAM. All supported onboard memory can be cached.

### **1-7.3 Microprocessor Upgrades**

The motherboard can be upgraded with Socket A processors that run at higher speeds. When upgrading the processor, use the BIOS configuration mode to change the processor speed.

## 1-8 MEMORY

### ➤ Main Memory

The motherboard has three DDR DIMM sockets. DDR RAM can be installed in one, two, or three sockets. Using the serial presence detect (SPD) data structure, programmed into an E<sup>2</sup>PROM on the DDR DIMM, the BIOS can determine the DDR RAM's size and speed. Minimum DDR DIMM memory size is 64 MB; maximum DDR DIMM memory size is 256/512 MB. Memory size and speed can vary between sockets.

The motherboard supports the following memory features:

- DRAM interface synchronous with host CPU (100/133 MHz) or AGP (66MHz) for most flexible configuration
- DRAM interface may be faster than CPU by 33 MHz to allow use of 133 MHz memory with 100 MHz FSB
- Concurrent CPU, AGP, and V-Link access
- Supports DDR RAM memory types only
- Flexible row and column addresses. 64-bit data width only
- 2.5V SSTL-2 DRAM interface for DDR RAM
- Optional bank-by-bank ECC (single-bit error correction and multi-bit error detection) or EC (error checking only) for DRAM integrity
- Supports maximum 6-bank interleave (i.e., 8 pages open simultaneously); banks are allocated based on LRU
- Independent DDR RAM control for each bank
- Four cache lines (16 quadwords) of CPU to DRAM write buffers
- Four cache lines of CPU to DRAM read prefetch buffers
- Read around write capability for non-stalled CPU read
- Speculative DRAM read before snoop result
- Burst read and write operation
- x-1/2-1/2-1/2-1-1/2-1/2-1/2 back-to-back accesses for DDR SDRAM
- Supports DDR SDRAM CL 2/2.5 and 1T/2Tper command
- Decoupled and burst DRAM refresh with staggered RAS timing. CAS before RAS or self refresh

## **1-9 CHIPSET**

### ➤ VIA Apollo KT266

The **KT266 / VT8366 and VT8233** chipset is a high performance, cost-effective and energy efficient system controller for the implementation of AGP / PCI desktop personal computer systems based on 64-bit Socket-A (AMD Athlon) processors.

The KT266 chip set consists of the VT8366 system controller (552 pin BGA) and the VT8233 V-Link south bridge (376 pin BGA). The VT8366 Host system controller provides superior performance between the CPU, DRAM, AGP bus, and V-Link bus with pipelined, burst, and concurrent operation. The VT8233 V-Link Client controller is a highly integrated PCI / LPC controller.

Its internal bus structure is based on 33 MHz PCI bus that provides 2x bandwidth compare to previous generation PCI / ISA bridge chips. The VT8233 also provides a 266MB/sec bandwidth Host/Client V-Link interface with V-Link-PCI and V-Link-LPC controllers. It supports five PCI slots of arbitration and decoding for all integrated functions and LPC bus.

The VT8366 supports eight banks of DDR SDRAM up to 4 GB. The DRAM controller supports standard Synchronous DRAM (SDRAM), and Virtual Channel SDRAM (VC SDRAM) SDRAM in a flexible mix / match manner, or it can be configured to support Double-Data-Rated (DDR) SDRAM mode. The DDR DRAM interface allows zero wait state bursting between the DRAM and the data buffers at 66 / 100 / 133 MHz. The eight banks of DRAM can be composed of an arbitrary mixture of 1M / 2M / 4M / 8M / 16M / 32M / 64M xN DRAMs. The DRAM controller also supports optional ECC (single-bit error correction and multi-bit detection) or EC (error checking) capability separately selectable on a bank-by-bank basis. The DRAM controller can run either synchronous or pseudo-synchronous mode with the host CPU bus frequency (100 / 133 MHz).

The VT8366 Host system controller also supports full AGP v2.0 capability for maximum bus utilization including 2x and 4x mode transfers, SBA

(SideBand Addressing), Flush/Fence commands, and pipelined grants. An eight level request queue plus a four level post-write request queue with thirty-two and sixteen quadwords of read and write data FIFO's respectively are included for deep pipelined and split AGP transactions. A single-level GART TLB with 16 full associative entries and flexible CPU / AGP / PCI remapping control is also provided for operation under protected mode operating environments. Both Windows-95 VXD and Windows-98 / NT5 miniport drivers are supported for interoperability with major AGP-based 3D and DVD-capable multimedia accelerators.

The VT8366 Host system controller supports two 32-bit 3.3 system buses (one AGP and one V-Link) that are synchronous / pseudo-synchronous to the CPU bus. The chip also contains a built-in bus-to-bus bridge to allow simultaneous concurrent operations on each bus. Five levels (doublewords) of post write buffers are included to allow for concurrent CPU and V-Link operation. For V-Link Host operation, forty-eight levels (doublewords) of post write buffers and sixteen levels (doublewords) of prefetch buffers are included for concurrent V-Link bus and DRAM/cache accesses. When combined the V-Link Host / Client controllers, it realizes a complete PCI sub-system and supports enhanced PCI bus commands such as Memory-Read-Line, Memory-Read-Multiple and Memory-Write-Invalid commands to minimize snoop overhead. In addition, advanced features are supported such as snoop ahead, snoop filtering, L1 write-back forward to PCI master, and L1 write-back merged with PCI post write buffers to minimize PCI master read latency and DRAM utilization. Delay transaction and read caching mechanisms are also implemented for further improvement of overall system performance.

The 376-pin Ball Grid Array VT8233 Client V-Link PCI / LPC controller supports four levels (doublewords) of line buffers, type F DMA transfers and delay transaction to allow efficient PCI bus utilization and (PCI-2.1 compliant). The VT8233 integrated PCI controller and PCI arbitration for up to five PCI slots. One of the PCI REQ / GNT pair can be configured as high-priority to better support a low latency PCI bus master device. The



VT8233 integrated networking MAC controller with standard MII interface to an external PHY for 10/100Mb base-T Ethernet or 1/10Mb PNA home networking.

The VT8233 also includes an integrated keyboard controller with PS2 mouse support, integrated DS12885 style real time clock with extended 256 byte CMOS RAM, integrated master mode enhanced IDE controller with full scatter / gather capability and extension to UltraDMA-33/66/100 for 33/66/100 MB/sec transfer rate, integrated USB interface with root hubs and six function ports with built-in physical layer transceivers, Distributed DMA support, and OnNow / ACPI compliant advanced configuration and power management interface.

For sophisticated power management, the Apollo KT266 chipset provides independent clock stop control for the CPU / SDRAM, PCI, and AGP buses and Dynamic CKE control for powering down of the SDRAM. A separate suspend-well plane is implemented for the SDRAM control signals for Suspend-to-DRAM operation. Coupled with the VT8233 south bridge chip, a complete power conscious PC main board can be implemented with no external TTLs.

The Apollo KT266 chipset is ideal for high performance, high quality, high energy efficient and high integration desktop and notebook AGP / PCI / LPC computer systems.

The VT8233 South Bridge is a high integration, high performance, power-efficient, and high compatibility device that supports Intel and non-Intel based processor to V-Link bus bridge functionality to make a complete Microsoft PC99-compliant PCI/ISA system. In addition to complete ISA extension bus functionality, the VT8233 includes standard intelligent peripheral controllers:

- a) IEEE 802.3 compliant 10 / 100 Mbps PCI bus master Ethernet MAC with standard MII interface to external PHYceiver.
- b) Master mode enhanced IDE controller with dual channel DMA engine and interlaced dual channel commands. Dedicated FIFO coupled with

scatter and gather master mode operation allows high performance transfers between PCI and IDE devices. In addition to standard PIO and DMA mode operation, the VT8233 also supports the UltraDMA-33 standard to allow reliable data transfer rates up to 33 MB/sec throughput. The VT8233 also supports the UltraDMA-66 / 100 standard. The IDE controller is SFF-8038i v1.0 and Microsoft Windows-family compliant.

- c) Universal Serial Bus controller that is USB v1.1 and Universal HCI v1.1 compliant. The VT8233 includes the root hub with six function ports with integrated physical layer transceivers. The USB controller allows hot plug and play and isochronous peripherals to be inserted into the system with universal driver support. The controller also implements legacy keyboard and mouse support so that legacy software can run transparently in a non-USB-aware operating system environment.
- d) Keyboard controller with PS2 mouse support.
- e) Real Time Clock with 256 byte extended CMOS. In addition to the standard ISA RTC functionality, the integrated RTC also includes the date alarm, century field, and other enhancements for compatibility with the ACPI standard.
- f) Notebook-class power management functionality compliant with ACPI and legacy APM requirements. Multiple sleep states (power-on suspend, suspend-to-DRAM, and suspend-to-Disk) are supported with hardware automatic wake-up. Additional functionality includes event monitoring, CPU clock throttling and stop (Intel processor protocol), PCI bus clock stop control, modular power, clock and leakage control, hardware-based and software-based event handling, general purpose I/O, chip select and external SMI.
- g) Full System Management Bus (SMBus) interface.
- h) Integrated bus-mastering dual full-duplex direct-sound AC97-link-compatible sound system.
- i) Plug and Play controller that allows complete steerability of all PCI

interrupts and internal interrupts / DMA channels to any interrupt channel. One additional steerable interrupt channel is provided to allow plug and play and reconfigurability of on-board peripherals for Windows family compliance.

The VT8233 also enhances the functionality of the standard ISA peripherals. The integrated interrupt controller supports both edge and level triggered interrupts channel by channel. The integrated DMA controller supports type F DMA in addition to standard ISA DMA modes. Compliant with the PCI-2.2 specification, the VT8233 supports delayed transactions and remote power management so that slower ISA peripherals do not block the traffic of the PCI bus. Special circuitry is built in to allow concurrent operation without causing dead lock even in a PCI-to-PCI bridge environment. The chip also includes eight levels (doublewords) of line buffers from the PCI bus to the ISA bus to further enhance overall system performance.

## **1-10 I/O INTERFACE CONTROLLER**

The motherboard uses the ITE 8705 LPC Super-I/O controller which features:

- Supports 2 serial ports, IR port, parallel port, and floppy disk controller functions
- Two UARTs for Complete Serial Ports
  - Even, odd, stick or no parity bit generation and detection
  - Programmable baud rate generator
  - High speed baud rate (230Kbps, 460Kbps) support
  - Independent transmit/receiver FIFOs
  - Modem Control
  - Plug and play with 96 base IO address and 12 IRQ options
- One dedicated IR port
  - Third serial port dedicated to IR function
  - IR function either through the two complete serial ports or the third dedicated port
  - Infrared-IrDA (HPSIR) and ASK (Amplitude Shift Keyed) IR

- Multi-mode parallel port
  - Standard mode, ECP and EPP support
  - Plug and play with 192 base IO address, 12 IRQ and 4 DMA options
- Floppy Disk Controller
  - 16bytes of FIFO
  - Data rates up to 1Mbps
  - Perpendicular recording driver support
  - Plug and play with 48 base IO address, 12 IRQ and 4 DMA options

The Setup program provides configuration option for the I/O controller.

### **1-10.1 Serial Ports**

The motherboard has two 9-pin D-Sub serial port connectors located on the back panel. The NS16C5450-compatible UARTs support data transfers at speeds up to 115.2 Kbits/sec with BIOS support.

### **1-10.2 Parallel Port**

The connector for the multimode bi-directional parallel port is a 25-pin D-Sub connector located on the back panel of the motherboard. In the Setup program, there are four options for parallel port operation:

- Compatible (standard mode)
- Bi-directional (PS/2 compatible)
- Bi-directional EPP. A driver from the peripheral manufacturer is required for operation.
- Bi-directional high-speed ECP

### **1-10.3 Diskette Drive Controller**

The I/O controller is software compatible with the 82077 diskette drive controller and supports both PC-AT and PS/2 modes. In the Setup program, the diskette drive interface can be configured for the following diskette drive capacities and sizes.

- 360 KB, 5.25-inch
- 1.2 MB, 5.25-inch

- 720 KB, 3.5-inch
- 1.2 MB, 3.5-inch (driver required)
- 1.25-1.44 MB, 3.5-inch
- 2.88 MB, 3.5-inch

### **1-10.4 PS/2 Keyboard and Mouse Interface**

PS/2 keyboard and mouse connectors are located on the back panel of the motherboard. The +5 V lines to keyboard and mouse connectors are protected with a fuse that prevents motherboard components from being damaged when an over-current condition occurs.



#### **Note**

*The mouse and keyboard can be plugged into either PS/2 connector. Power to the computer should be turned off before a keyboard or mouse is connected or disconnected.*

The keyboard controller contains code, which provides the traditional keyboard and mouse control functions, and also supports Power On/Reset password protection. Power On/Reset password can be specified in the BIOS Setup program.

The keyboard controller also supports the hot-key sequence <Ctrl><Alt><Del>, software reset. This key sequence resets the computer's software by jumping to the beginning of the BIOS code and running the Power On Self Test (POST).

### **1-10.5 Infrared Support**

On the front panel I/O connector, there are six pins that support Hewlett Packard HSDL-1000 compatible infrared (IR) transmitters and receivers. In the Setup program, Serial Port B can be directed to a connected IR device. (In this case, the Serial Port B connector on the back panel cannot be used.) The IR connection can be used to transfer files to or from portable devices like laptops, PDAs, and printers. The Infrared Data Association (IrDA) specification supports data transfers of 115Kbits/sec at a distance of 1 meter.

## **1-11 HARDWARE MONITOR**

The optional hardware monitor subsystem provides low-cost instrumentation capabilities. The features of the hardware monitor subsystem include:

- An integrated ambient temperature sensor
- Fan speed sensors, which monitor the fan 1 and fan 2 connector.
- Power supply voltage monitoring to detect levels above or below acceptable values

When suggested ratings for temperature, fan speed, or voltage are exceeded, an interrupt is activated. The hardware monitor component connects to the SMBus.

## **1-12 WAKE ON LAN TECHNOLOGY**

Wake on LAN technology enables remote wakeup of the computer through a network. Wake on LAN technology requires a PCI add-in network interface card (NIC) with remote wakeup capabilities. The remote wakeup connector on the NIC must be connected to the onboard Wake on LAN connector. The NIC monitors network traffic at the Ethernet interface; upon detecting a Magic Packet, the NIC asserts a wakeup signal that powers up the computer. This feature uses the Wake on LAN connector.

### **⚠ CAUTION**

For Wake on LAN, the 5-V standby line for the power supply must be capable of delivering  $+5V \pm 5\%$  at 720 mA. Failure to provide adequate standby current when implementing Wake on LAN can damage the power supply.

## Chapter 2

# HARDWARE INSTALLATION

Congratulations on your purchase of **SY-K7V DRAGON** Motherboard. You are about to install and connect your new Motherboard.



---

**Note:** Do not unpack the Motherboard from its protective anti-static packaging until you have made the following preparations.

---

### 2-1 PREPARATIONS

Gather and prepare all the following hardware equipment to complete the installation successfully:

1. Socket A processor with built-in CPU cooling fan (boxed type)



---

**Note:** This Motherboard supports non-boxed type CPUs. The heavier CPU cooling fan requires the installation of a CPU support stand.

---

2. DDR RAM module (s)
3. Computer case and chassis with adequate power supply unit
4. Monitor
5. PS/2 Keyboard
6. Pointing Device (PS/2 mouse)
7. Speaker(s) (optional)
8. Disk Drives: HDD, CD-ROM, Floppy drive...
9. External Peripherals: Printer, Plotter, and Modem (optional)
10. Internal Peripherals: Modem and LAN cards (optional)

## 2-2 UNPACKING THE MOTHERBOARD

When unpacking the Motherboard, check for the following items:

- ◆ The SY-K7V DRAGON KT266 AGP/PCI Motherboard



- ◆ The M/B, RAID, AUDIO user manual



- ◆ The Installation CD-ROM



- ◆ SOYO Bonus Pack CD-ROM



- ◆ 3 IDE Device ATA 66 Flat Cable

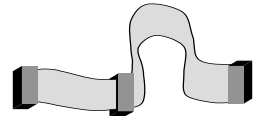

- ◆ One Floppy Disk Drive Flat Cable

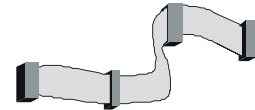

- ◆ One Audio Connector Card



- ◆ One Flat Cable for Audio Card



- ◆ One Heat Sink Compound



**Warning:** Do not unpack the Motherboard from its anti-static packaging until you are ready to install it.



Like most electronic equipment, your Motherboard may be damaged by electrostatic discharge. To avoid permanent damage to components ground yourself while working by using a grounding strap. Otherwise, ground yourself frequently by touching the unpainted portion of the computer chassis to drain the static charges.

Handle the Motherboard carefully, holding it by the edges.

You are now ready to start the installation.

### **2-3 INSTALLATION GUIDE**

We will now begin the installation of the Motherboard. Please follow the step-by-step procedure designed to lead you to a complete and correct installation.



---

**Warning:** Turn off the power to the Motherboard, system chassis, and peripheral devices before performing any work on the Motherboard or system.

---

**BEGIN THE INSTALLATION**

## 2-3.1 CPU Installation



### FOC ( Fan-Off Control )

The newly designed SOYO “FOC” is based on the concept of total protection for CPU, which is very different from currently seen on the market. The H/W control function is used to see a passive security system of monitoring and warning. S/W Simultaneous Signal Follow-ups techniques and Auto Power Off System are included to prevent all possible damage caused by the MAL-functioning of the CPU fan. With the help of “O/S On Time Monitoring And Warning” function, provided by the H/W monitoring system, the double-protection purpose is achieved.

“FOC” includes the following functions:

- (1) **Simultaneous Signal Follow Ups:** Before the system enters the O/S, H/W will detect the signals of the CPU fan pins, get their revolution information and send it to the BIOS.
- (2) **Auto Power Off System:** If the BIOS gets the information of CPU fan revolution, it goes on working normally. If not, it will inform the system and have the power supply disconnected immediately. Thus, the CPU is protected from over heating.

**Note:** The following must be observed to secure the normal functioning of “Fan-Off Control”:

- 1. FOC only works on CPUFAN 1.**
2. CPU fan with sensor pins must be used.
3. CPU fans approved by AMD are strongly recommended.
4. The “HOT KEY” function is provided for the CPU fans without sensor pins, to avoid the power off. Users may press the “Insert” key to jump over the “Power Off” mode; go to the BIOS and disable “FOC”. Now system can be booted normally.

We provide the following User-Friendly protection features:

1. **Fan-Off Control** : The motherboard detects the status of the CPU fan and protects the CPU by automatically disconnecting the power supply. The default value of this function is Enable. After booting up, the user may disable it.
2. **Heat Dissipation Paste**: Heat Dissipation Paste is included for all Socket-A motherboards, to enhance the heat dissipation capability.

Furthermore, we strongly recommend our users to enable the function of H/W monitoring in the BIOS. This function, together with the FOC, provide the total protection to the CPU and allow it to maximize its performance.

**Mark your CPU Frequency**: Record the working frequency of your CPU that should be clearly marked on the CPU cover.

**200MHz FSB DDR transfer on Athlon**

<input type="checkbox"/> 750 MHz (100x7.5)	<input type="checkbox"/> 800 MHz (100x8.0)	<input type="checkbox"/> 850 MHz (100x8.5)	<input type="checkbox"/> 900 MHz (100x9.0)
<input type="checkbox"/> 950 MHz (100x9.5)	<input type="checkbox"/> 1000 MHz(100x10.0)	<input type="checkbox"/> 1.1GHz (100x11.0)	<input type="checkbox"/> 1.2GHz(100x12.0)

**200MHz FSB DDR transfer on Duron**

<input type="checkbox"/> 600 MHz (100x6.0)	<input type="checkbox"/> 650 MHz (100x6.5)	<input type="checkbox"/> 700 MHz (100x7.5)	<input type="checkbox"/> 750 MHz (100x7.5)
<input type="checkbox"/> 800 MHz (100x8.0)	<input type="checkbox"/> 850 MHz (100x8.5)	<input type="checkbox"/> 900 MHz (100x9.0)	<input type="checkbox"/> 950 MHz (100x9.5)

**266MHz Front Side Bus DDR transfer on Athlon**

<input type="checkbox"/> 1GHz (133x7.5)	<input type="checkbox"/> 1.13GHz(133x8.5)	<input type="checkbox"/> 1.2GHz(133x9.0)	<input type="checkbox"/> 1.3GHz(133x10.0)	<input type="checkbox"/> 1.4GHz(133x10.5)
---	---	--	---	---

**CPU Mount Procedure:** To mount the AMD® K7 Athlon & Duron™ processor that you have purchased separately, follow these instructions.

1. Lift the socket handle up to a vertical position.

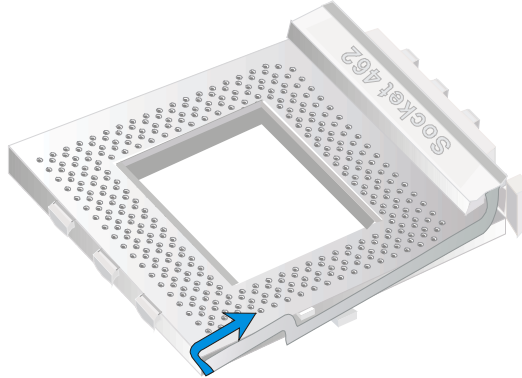

2. Align the blunt edge of the CPU with the matching pinhole distinctive edge on the socket.

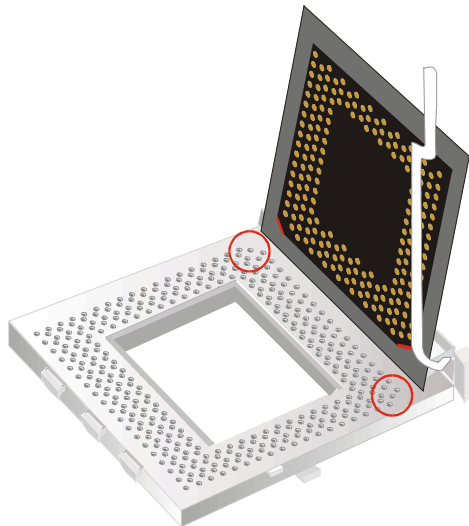

3. Seat the processor in the socket completely and without forcing.

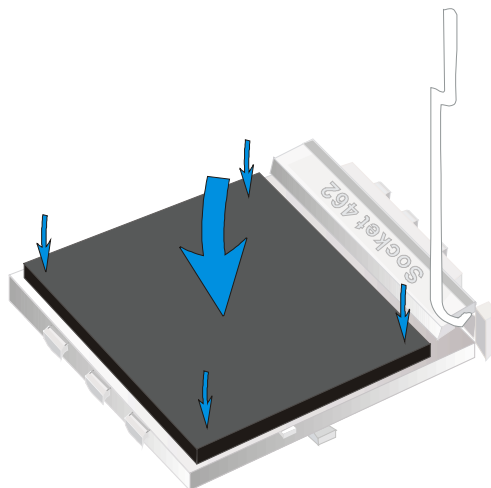

4. Then close the socket handle to secure the CPU in place.

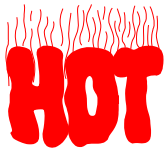
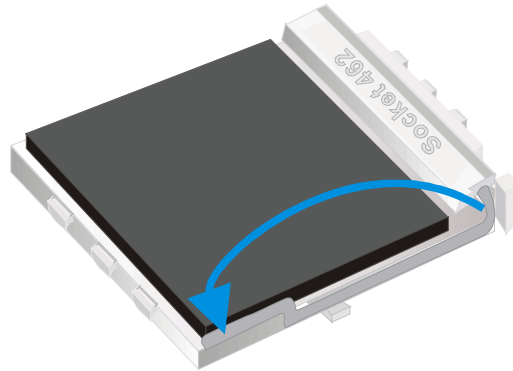

---

Remember to connect the CPU Cooling Fan to the appropriate power connector on the Motherboard. *The fan is a key component that will ensure system stability. The fan prevents overheating, therefore prolonging the life of your CPU.*

---

### 2-3.1.1 CPU Fan Installation

Your Socket A processor kit comes with a cooling fan. Mount the fan on the processor according to the instructions provided by the manufacturer. The fan is a key component that will ensure system stability. The fan prevents overheating, therefore prolonging the life of your CPU.



---

**Note:** Remember to connect the fan to the appropriate power source.

---

### 2-3.2 DDR RAM Memory Module Installation

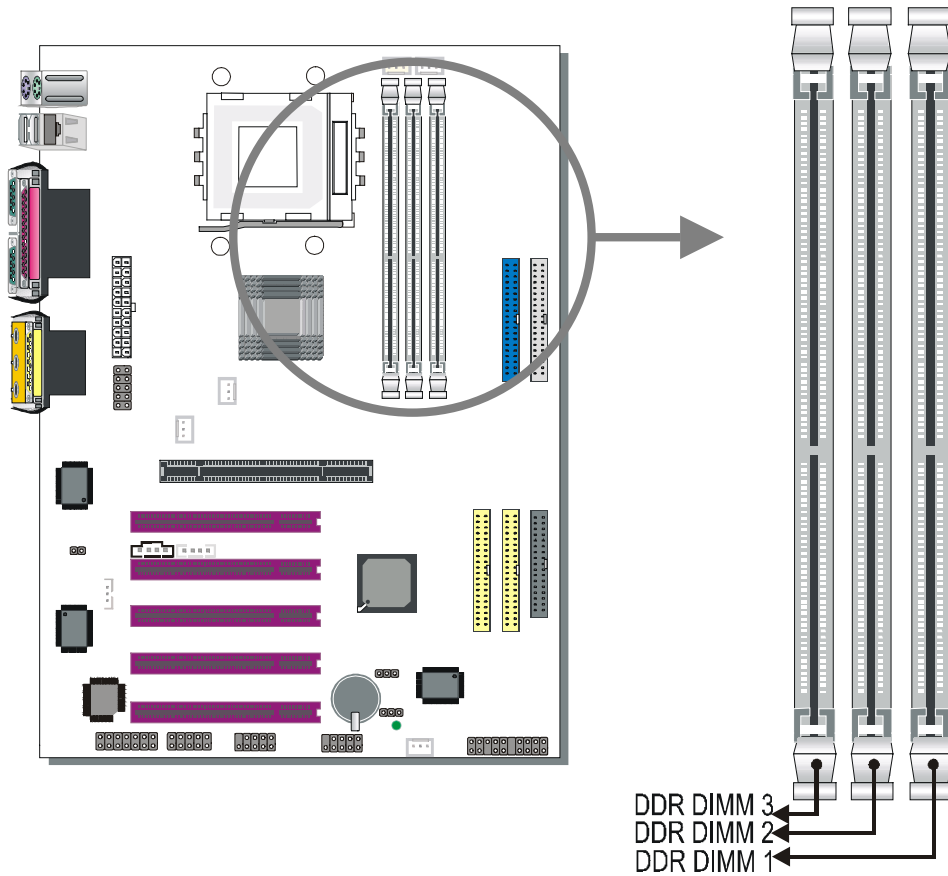

Your board comes with three DIMM sockets, providing support for up to 3GB of main memory using unbuffered DIMM modules from 64MB to 1GB. On this motherboard, DRAM speed can be set independent from the CPU front side bus speed. Depending on the DRAM clock speed setting in the BIOS setup, appropriate memory modules must be used. For 100MHz DRAM speed, use PC1600 memory; for 133MHz DRAM speed, use PC2100 memory.

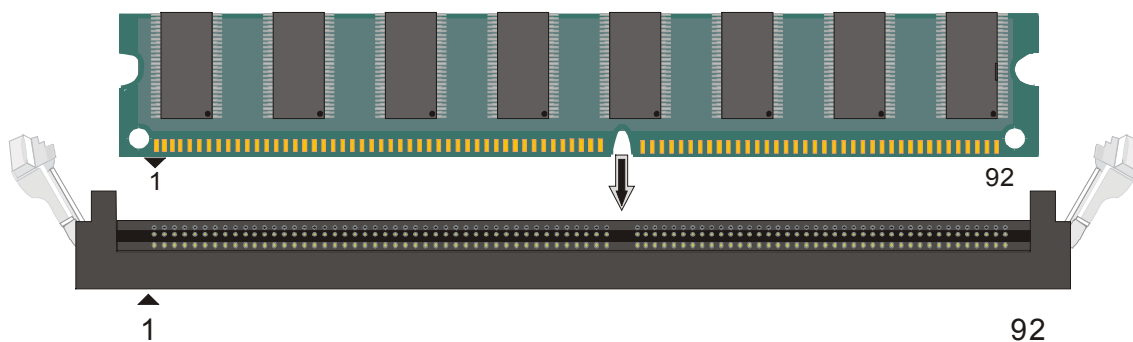

**Memory Configuration Table**

Number of Memory Modules	DIMM 1	DIMM 2	DIMM 3
RAM Type	DDR RAM		
Memory Module Size (MB)	64 / 128 / 256 / 512 / 1024 MB		

**2-3.3 Motherboard Connector**

**2-3.3.1 IDE Device Installation (HDD, CD-ROM)**

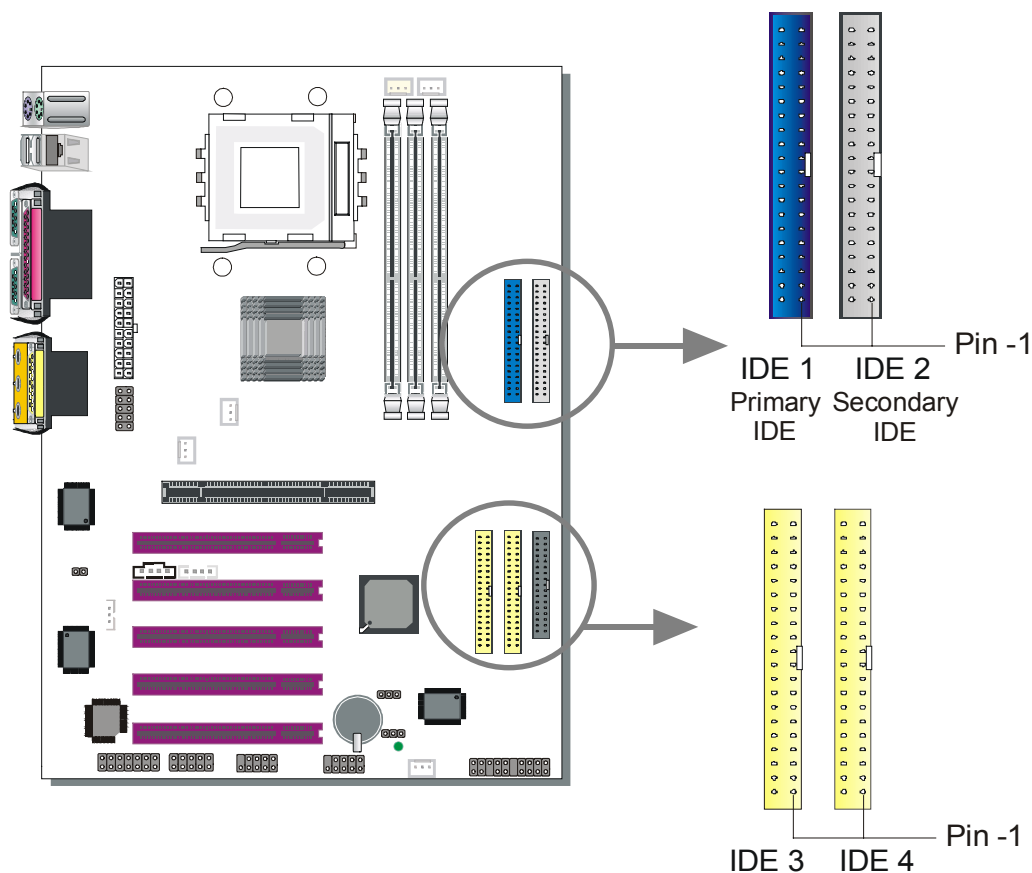

This Motherboard offers two primary and secondary IDE device connectors (IDE1, IDE2). It can support up to four high-speed Ultra DMA 33/66/100HDD or CD-ROM.

Connect one side of the ATA66/100 flat cable to the IDE device (HDD or CD-ROM) and plug the other end to the primary (IDE1) or secondary (IDE2) directionally keyed IDE connector on the Motherboard. The ATA66/100 cable is backward compatible with ATA33 HDDs.

This Motherboard can support up to 8 HDDs.

There are four HDD connectors (IDE1, IDE2, IDE3, IDE4) on motherboard. IDE3 & IDE4 are provided for IDE RAID function. Please refer to 2-3.4 on page 43 and the FASTTRAK-100-LITE Manual for more information on IDE RAID function.

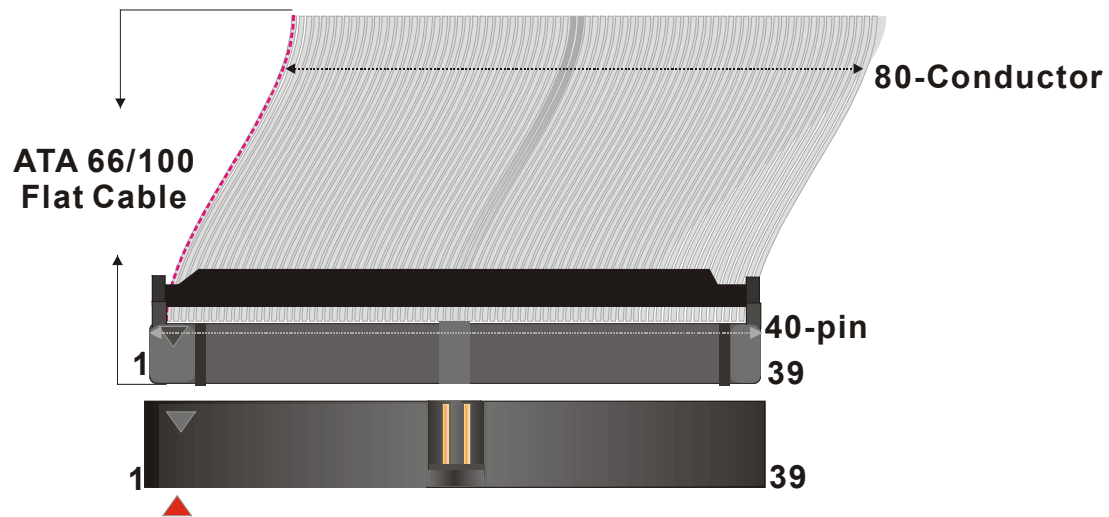



### 2-3.3.2 Floppy Drive Installation

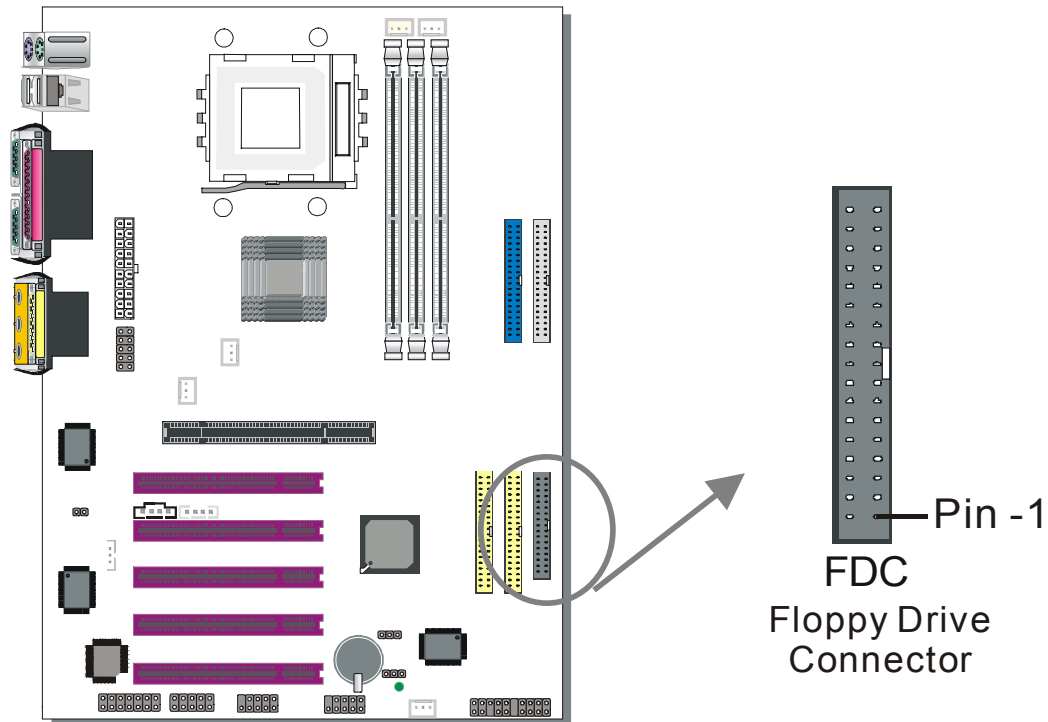

The system supports 5 possible floppy drive types: 720 KB, 1.2 MB, 1.44 MB, 2.88 MB, and LS-120.

Connect one side of the 34-pin flat cable to the floppy drive and plug the other end to the floppy drive connector on the Motherboard.

This Motherboard can support up to 1 floppy drives.

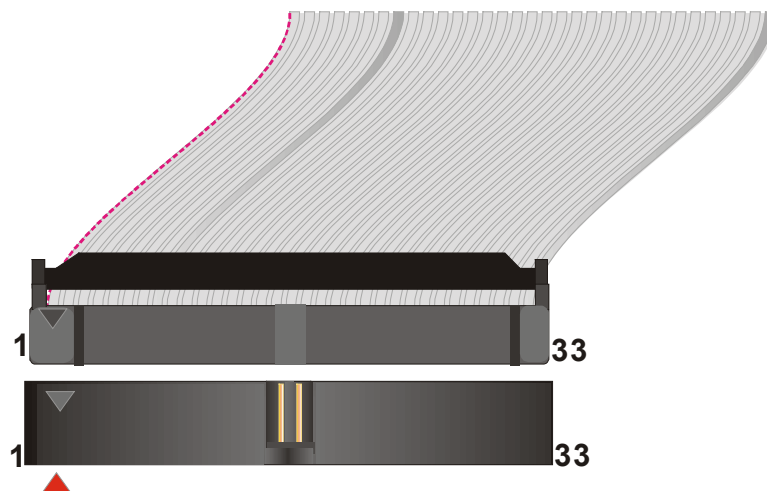

### 2-3.3.3 Front Panel Connections

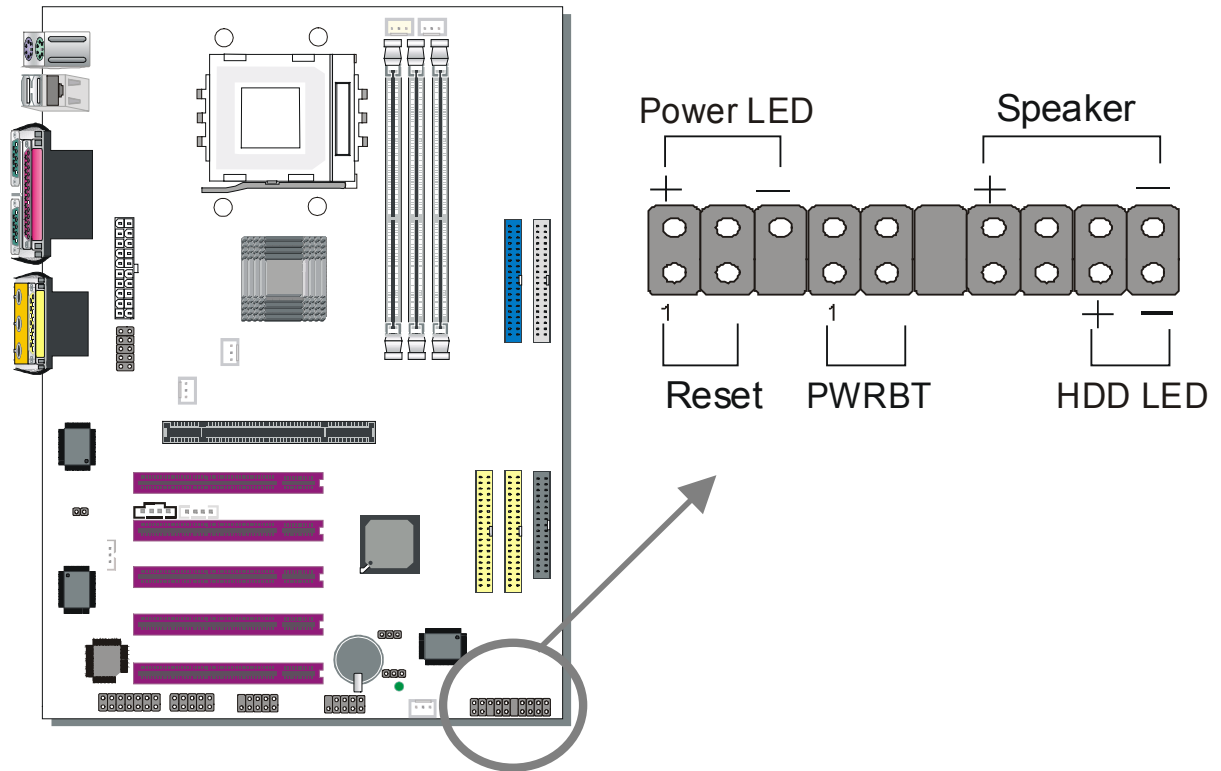

Plug the computer case's front panel devices to the corresponding headers on the Motherboard.

#### 1. Power LED

Please install according to the following pin assignment: pin 1,3 are for Power LED.

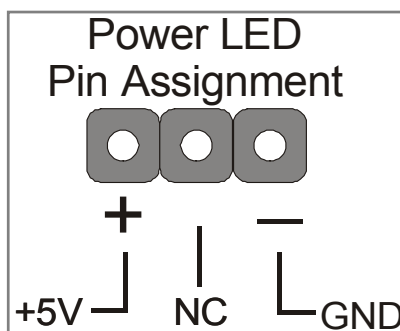

## 2. Reset

Plug the Reset push-button cable into the 2-pin Reset header on the Motherboard. Pushing the Reset button on the front panel will cause the system to restart the boot-up sequence.

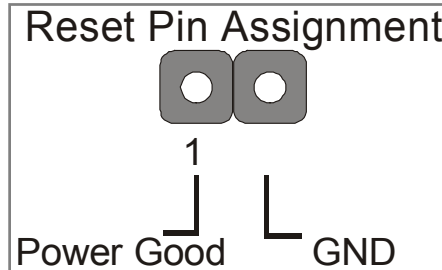

## 3. Speaker

Attach the 4-pin PC speaker cable from the case to the Speaker header on the Motherboard.

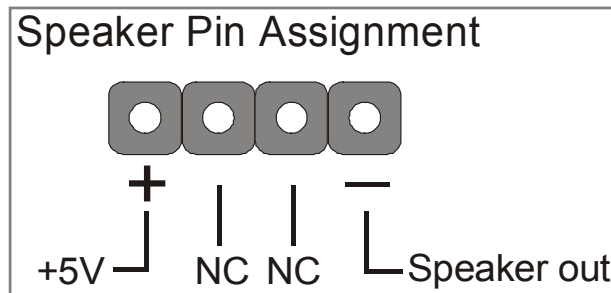

## 4. IDE LED

Attach the 2-pin IDE device LED cable to the corresponding IDE LED header on the Motherboard. This will cause the LED to light up when an IDE (HDD, CD-ROM) device is active.

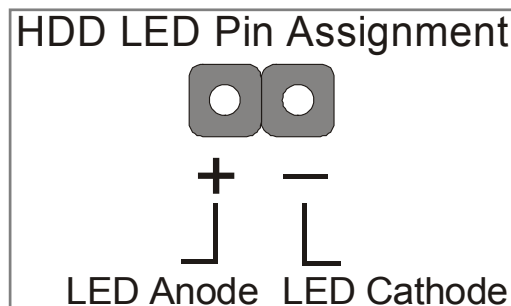

### 5. ATX Power On/Off Switch

Attach the 2-pin momentary type switch to the PWRBT header for turning On or Off your ATX power supply.

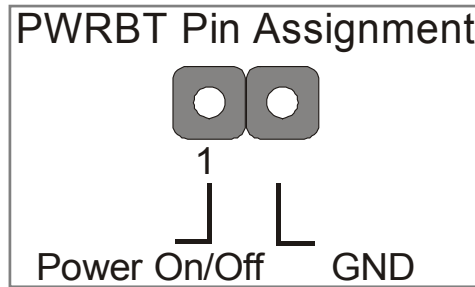

### 2-3.3.4 Back Panel Connections

All external devices such as the PS/2 keyboard, PS/2 mouse, printer, modem, USB can be plugged directly onto the Motherboard back panel. Only after you have fixed and locked the Motherboard to the computer case can you start connecting the external peripheral devices.

When connecting an external device, use the following figure to locate and identify which back panel connector to plug the device to.

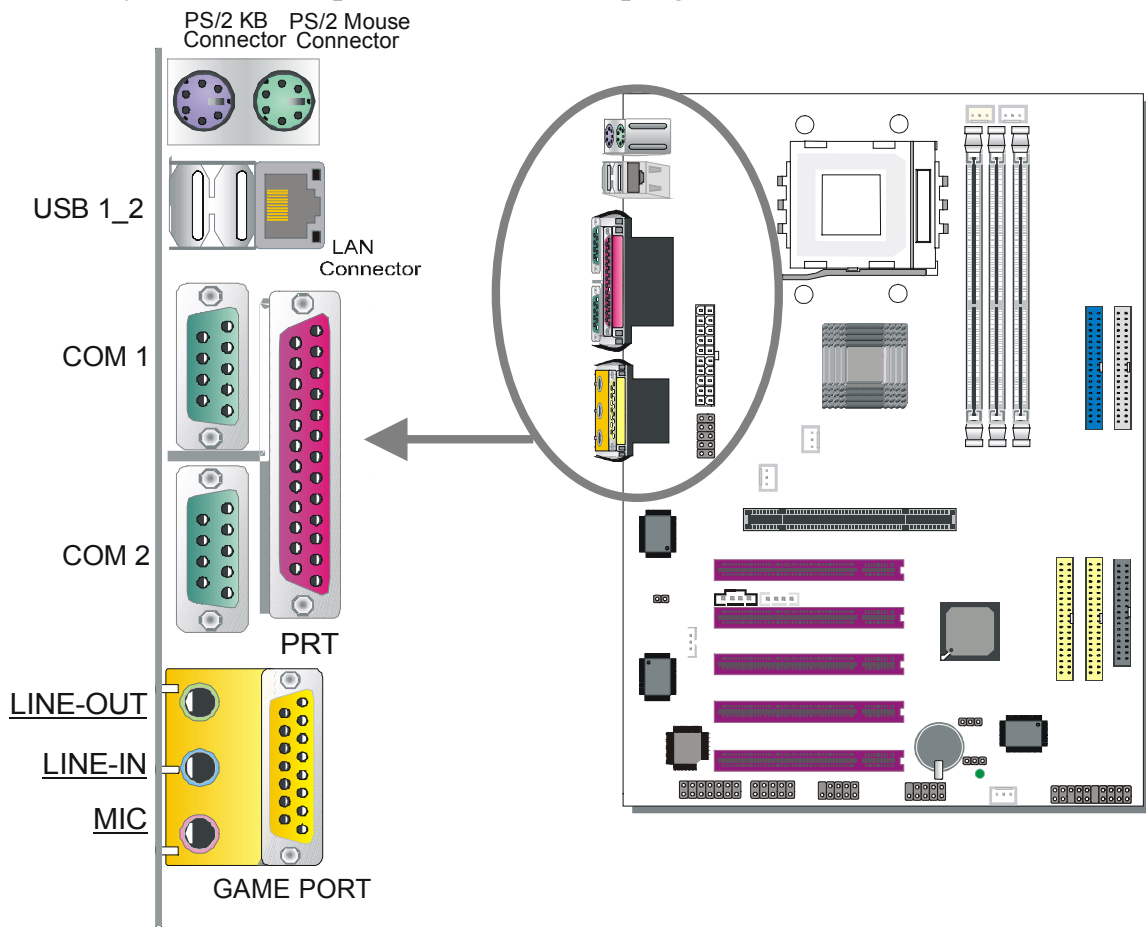

### 1. Onboard Serial Ports COM1/COM2

External peripherals that use serial transmission scheme include:

- serial mouse,
- and modem.

Plug the serial device cables directly into the COM1/COM2 9-pin male connectors located at the rear panel of the Motherboard.

### 2. Parallel Port PRT

This parallel port is used to connect the printer or other parallel devices.

Plug the parallel device cable into the 25-pin female connector located at the rear panel of the Motherboard.

### 3. PS/2 Keyboard

Plug the keyboard jack directly into the 6-pin female PS/2 keyboard connector located at the rear panel of the Motherboard.

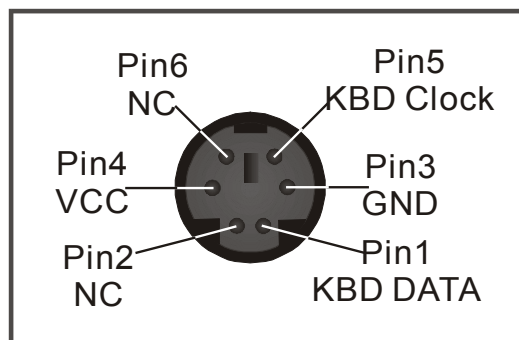

### 4. PS/2 Mouse

Similarly, plug the mouse jack directly into the 6-pin female PS/2 mouse connector.

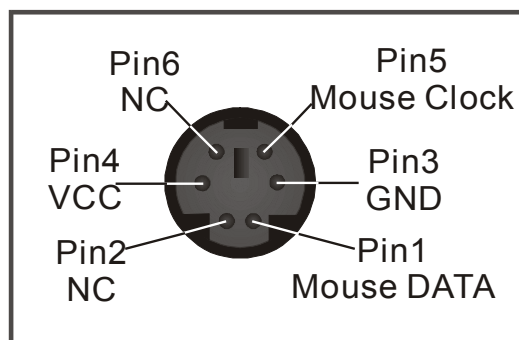

**5. Universal Serial Bus USB1/USB2 (USB3/USB4 ; USB5/USB6)**

This Motherboard provides four USB ports for your additional devices. Plug the USB device jack into the available USB connector USB1 or USB2.

- Standard device drivers come with the Win98 for commonly used USB devices.
- With Win95, use the flow UHCI specifications. To use USB devices under Win95, usually you have to install the device that driver comes with the USB device you have purchased.

USB3, USB4, USB5 and USB6 are available. To make use of these USB ports, purchase a USB cable from your dealer. The lay-out of USB3/USB4 and USB5/USB6 are as follows:

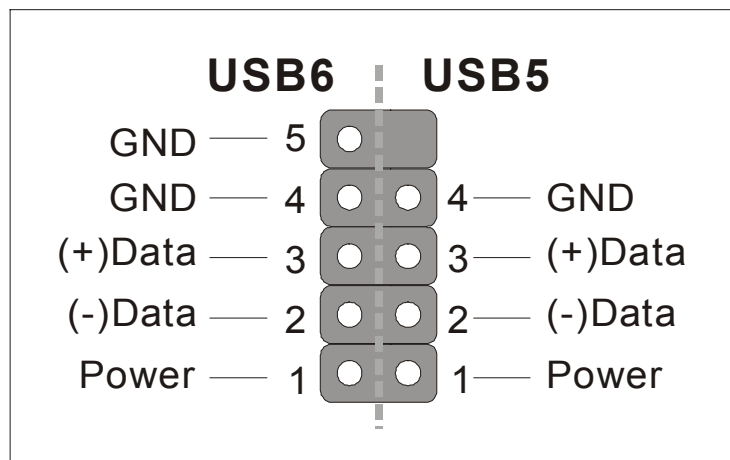
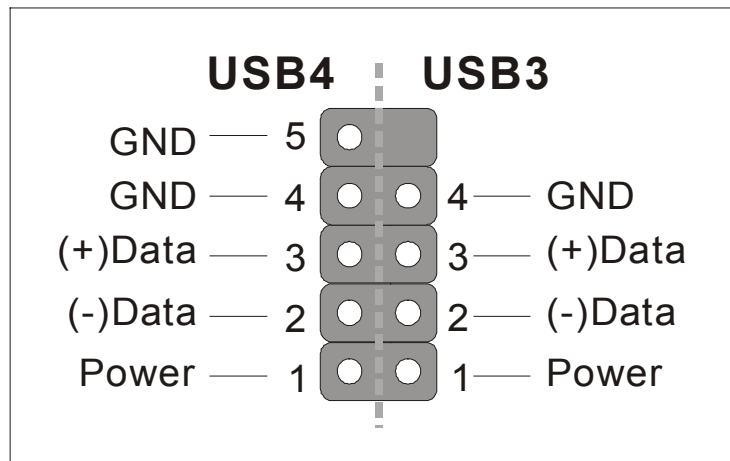

## **6. Onboard Game port/audio**

This Motherboard provides Joystick port and audio.

- Attach the joystick cable to the 15-pin GAME port at the rear panel of you motherboard.
- This Motherboard features three built-in audio-stereo ports (labeled line-in, line-out, and mic jack) convenient to directly plug-in all your external audio devices.

### 2-3.3.5 Other Connections

#### 1. Wake-On-LAN (WOL)

Attach the 3-pin connector from the LAN card which supports the Wake-On-LAN (WOL) function to the JP10 header on the Motherboard. This WOL function lets users wake up the connected computer through the LAN card.

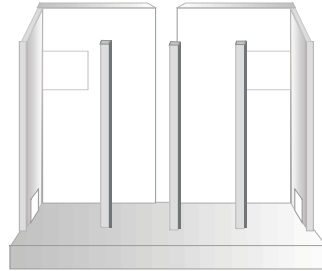

Please install according to the following pin assignment:

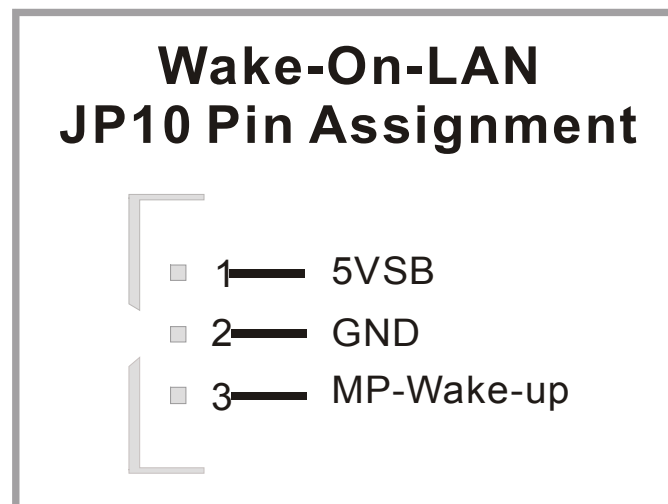





### 3. Cooling Fan Installation

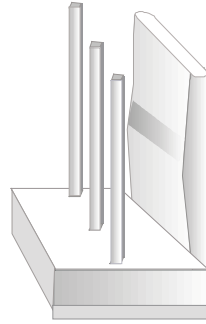

#### (1) CPU Cooling Fan (CHAFAN1,CHAFAN2)

After you have seated the CPU properly on the processor, attach the 3-pin fan cable to the CPUFAN connector on the Motherboard. The fan will stop when the system enters into Suspend Mode. (Suspend mode can be enabled from the BIOS Setup Utility, [POWER MANAGEMENT] menu.) To avoid damage to the system, install according to the following pin assignment:

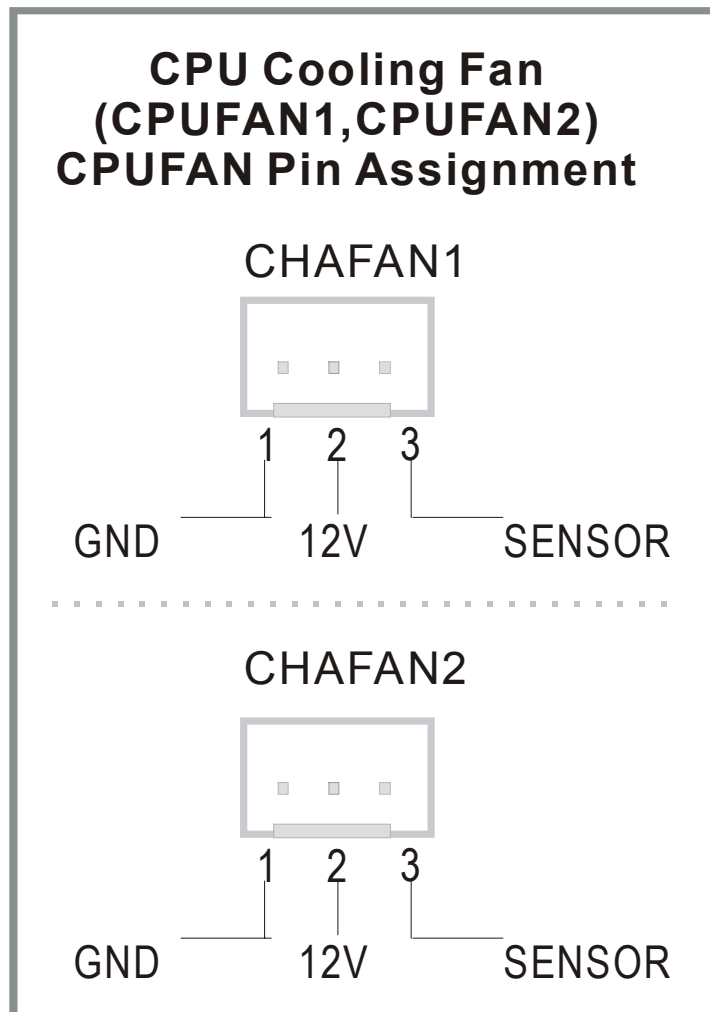

**(2) Chassis Cooling Fan (CHAFAN1,CHAFAN2,CHAFAN3)**

Some chassis also feature a cooling fan. This Motherboard features a CHAFAN connector to provide 12V power to the chassis fan. Connect the cable from the chassis fan to the CHAFAN 3-pin connector. Install according to the following pin assignment:

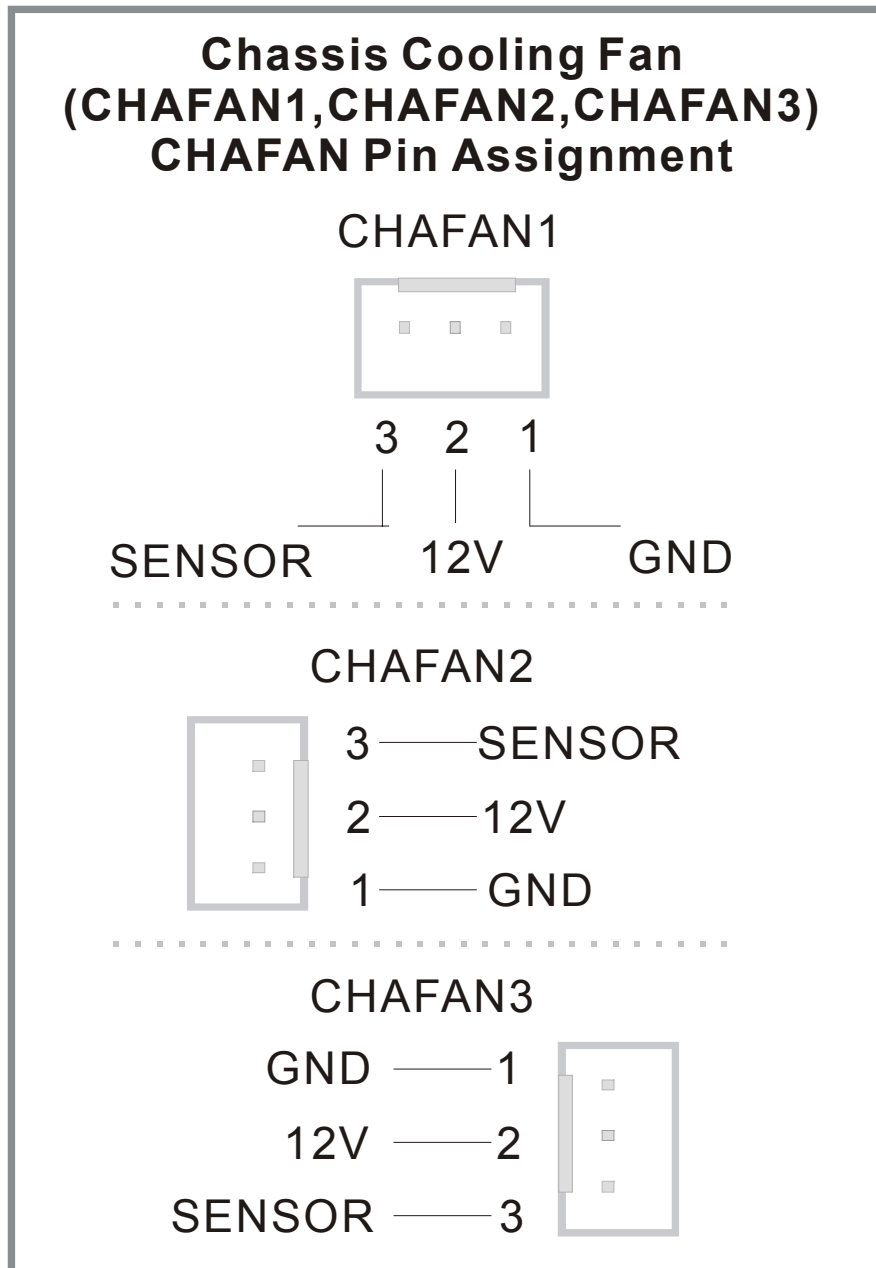

**Note:** CPUFAN must be installed for this Motherboard, CHAFAN is optional.

#### 4. CD Line-in (CDIN1,CDIN2)

This Motherboard provides two CD-Line in connectors. Please connect the 4-pin audio cable from your CD-ROM drive to either CDIN1 or CDIN2. (It fits in only one, depending on the cable that came with your CD-ROM drive)

Please install according to the following pin assignment:

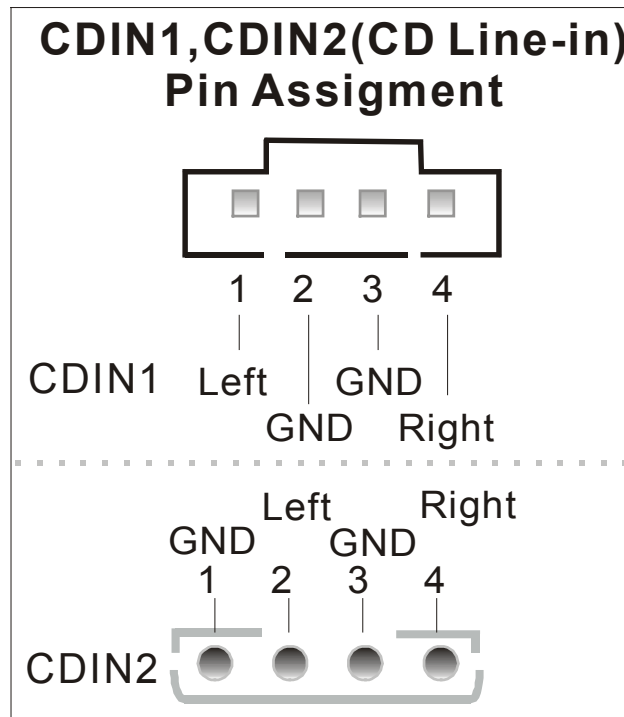

#### 5. Smart Card Reader

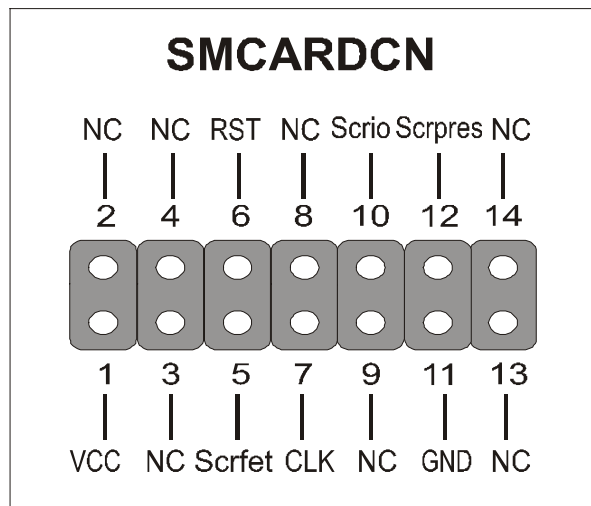

### 6. SPK5\_1

Please refer to the c-media 6 channel Audio solution Manual for more information on AUDIO function.

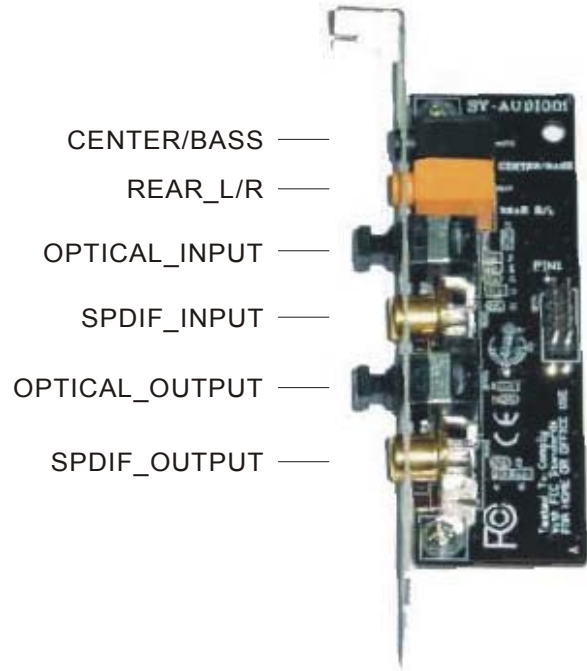
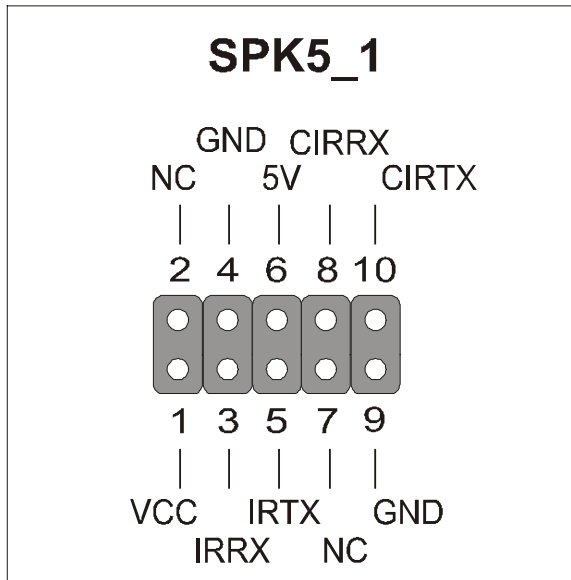

### 7. CD\_SPDIF

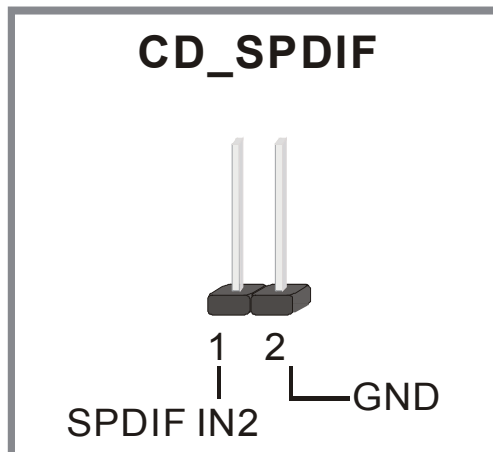

### 2-3.3.6 AGP Pro Slot

This motherboard supports AGP 2x/4x/Pro VGA CARD.



**Note:** DO NOT remove the safety tab underneath it if you will be using an AGP card without a retention notch. Removing may cause the card to shift and may cause damage to your card, slot, and motherboard. Remove ONLY when you will be using an AGP Pro card. You can use a pen tip to remove the tab from the bay.

### 2-3.3.7 ATX Power Supply

Plug the connector from the power directly into the 20-pin male ATX PW connector on the Motherboard, as shown in the following figure.

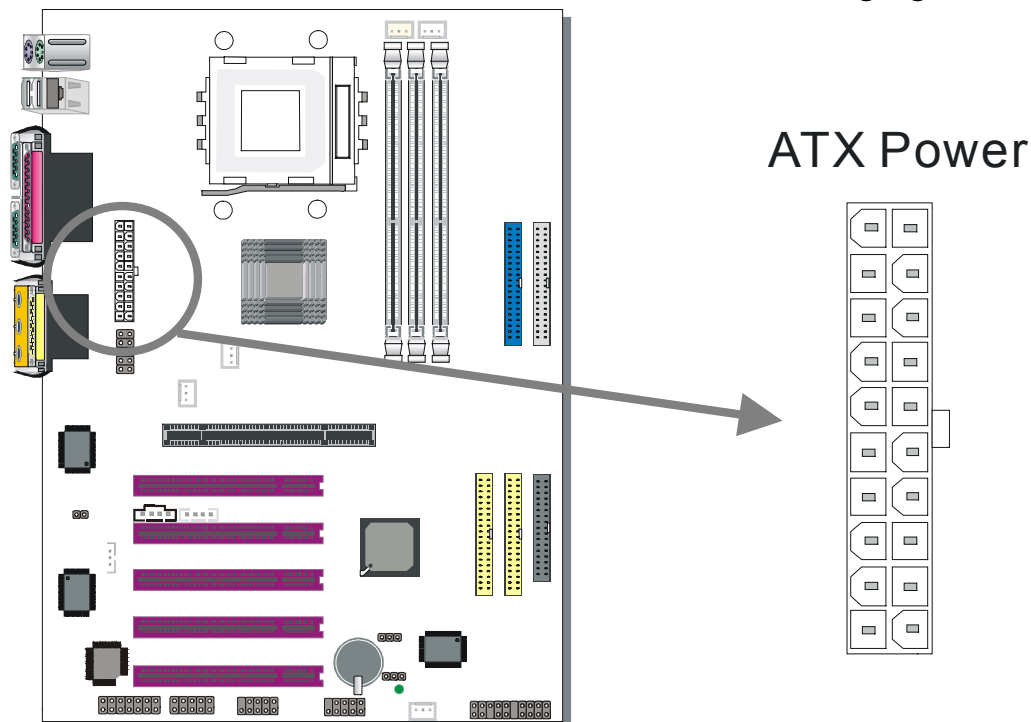

**Warning:** Follow these precautions to preserve your Motherboard from any remnant currents when connecting to ATX power supply:

**Turn off the power supply and unplug the power cord of the ATX power supply before connecting to ATX PW connector.**

The Motherboard requires a power supply with at least 200 Watts and a "power good" signal. Make sure the ATX power supply can take at least 720 mA \* load on the 5V Standby lead (5VSB) to meet the standard ATX specification.

\* **Note:** If you use the Wake-On-LAN (WOL) function, make sure the ATX power supply can support at least 720 mA on the 5V Standby lead (5VSB).

Please install the ATX power according to the following pin assignment:

### ATX Power

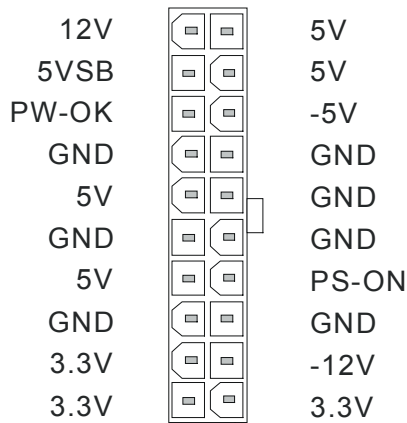



➤ **Pay special care to the directionality.**

## 2-3.4 Jumper Setting

### RAID\_IDE(IDE3,4) Function Selector

- Short pin 1-2 enables RAID function on IDE 3,4 port.
  - Short pin 2-3 enables regular IDE, RAID function is disabled.
- IDE 3,4 will function as normal IDE port (need to install Ultra Family Driver), please check page 107.

RAID Function	Enable	Disable
<b>RAID_IDE</b>	Short pin 1-2 to support RAID 0 or 1 	Short pin 2-3 support Ultra 33/66/100 

### 2-3.5 CMOS Clear (JP5)

In some cases the CMOS memory may contain wrong data, follow the steps below to clear the CMOS memory.

3. Clear the CMOS memory by momentarily shorting pin 2-3 on jumper JP5. This jumper can be easily identified by its white colored cap.
4. Then put the jumper back to 1-2 to allow writing of new data into the CMOS memory.

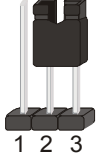
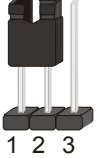
CMOS Clearing	Clear CMOS Data	Retain CMOS Data
JP5 Setting	Short pin 2-3 for at least 5 seconds to clear the CMOS 	Short pin 1-2 to retain new settings 
<p><i>Note: You must unplug the ATX power cable from the ATX power connector when performing the CMOS Clear operation.</i></p>		

### 2-3.6 Power On

You have now completed the hardware installation of your Motherboard successfully.

1. Turn the power on
2. To enter the BIOS Setup Utility, press the <DEL> key while the system is performing the diagnostic checks,



**Note:** If you have failed to enter the BIOS, wait until the boot up sequence is completed. Then push the RESET button and press <DEL> key again at the beginning of boot-up, during diagnostic checks.



Repeat this operation until you get the following screen.

3. The BIOS Setup screen appears:

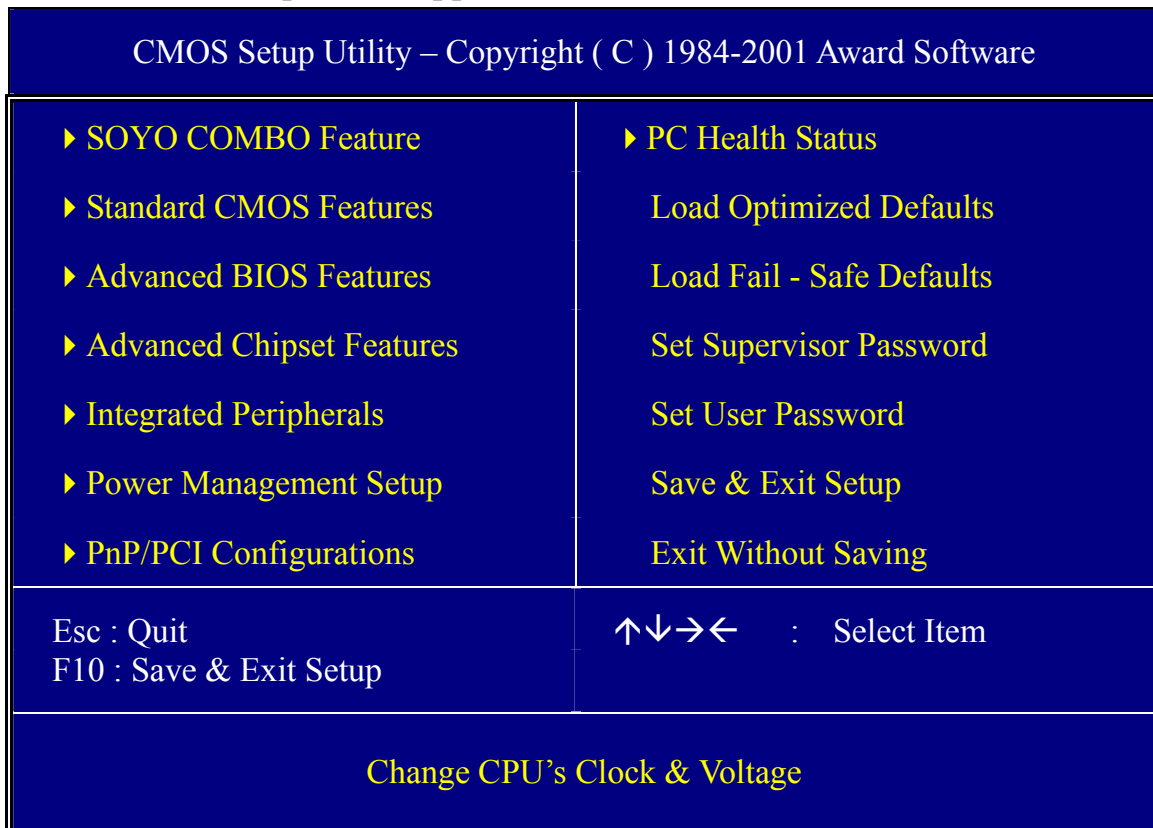

### 2-3.7 Quick BIOS Setup

This Motherboard does not use any hardware jumpers to set the CPU frequency. Instead, CPU settings are software configurable with the BIOS [SOYO COMBO FEATURE]. The [SOYO COMBO FEATURE] combines the main parameters that you need to configure, all in one menu, for a quick setup in BIOS.

After the hardware installation is complete, turn the power switch on, then press the <DEL> key during the system diagnostic checks to enter the Award BIOS Setup program. The CMOS SETUP UTILITY will be shown on the screen. Then, follow these steps to configure the CPU settings.

**Step 1. Select [STANDARD CMOS SETUP]**

Set [Date/Time] and [Floppy drive type], then set [Hard Disk Type] to “Auto”.

**Step 2. Select [LOAD OPTIMIZED DEFAULTS]**

Select the “LOAD OPTIMIZED DEFAULTS” menu and type “Y” at the prompt to load the BIOS optimal setup.

**Step 3. Select [SOYO COMBO FEATURE]**

Set the [CPU Clock] to 100/133MHz, depending on the Front Side Bus of your CPU.

To overclock your CPU’s Front Side Bus, [CPU Clock 1MHz STEP] enables you to overclock your CPU Front Side Bus in 1MHz increment or you can input the desired FSB value of the CPU.

*Note:* The maximum FSB you can overclock for a 100MHz FSB CPU is 132MHz and 233MHz for 133MHz FSB CPU.

**Step 4. Select [SAVE & EXIT SETUP]**

Press <Enter> to save the new configuration to the CMOS memory, and continue the boot sequence.

## **2-3.8 Troubleshooting at First Start**

### **USB Issues**

**Can I use USB port 3\_4 and port 5\_6 for keyboard resume function?**

This M/B has 6 USB ports, but only the 2 at the back panel can be used for USB keyboard resume function.

### **Video (no display) related issues**

**I built a new computer system using a Soyo board and nothing happens when turning it on, no video and no beeps from the PC speaker. What is happening and how can it be fixed?**

No screen and no beeps mean that your CPU and motherboard do not work at all. It could be that the CPU is not seated correctly or that a component on the M/B is grounded (shorted) with the case. Also make sure to check the voltage setting switch (110V/220V) on the back of the power supply. To isolate the problem do the following:

1. Press and hold down on the “Ins” (insert) key while turning on the computer until you get video. If you do not get video then,
2. Double-check jumpers setting on you motherboard and remove all add-on cards, unplug all hard-disk and floppy-disk drive cables and see if you can hear some beeps. If you still do not get any beeps, then try putting the motherboard on the table (to isolate it from the case) with the CPU and speaker only, and give it one more try.

**I hear a series of beeps and I do not get anything from my monitor. What could be wrong?**

The following lists some basic beep codes and their possible meanings:

- One long beep and 3 very short beeps - The video card is not detected by the motherboard. Please re-seat your video card. If you are using an AGP card, please push your AGP card down real hard. You may have to push VERY hard without the AGP card mounting screw. Make sure not to insert the card the other way around.

- Continuous beeps – One or more of the memory modules is not seated correctly in its socket.

**My PCI VGA card works fine with my system, but when I put in a new AGP card, it does not give me any video. Is my AGP slot bad?**

This is a common problem with AGP video cards. The reason is that your AGP card did not get seated into the AGP slot fully and firmly. Please push your AGP card down into the socket real hard, it should snap twice. You may have to unscrew the AGP card to allow the card to go further down. Do take care not to damage the card by using too much force.

**I get distorted video my AGP card right after I save my bios. Why is that?**

The cause is likely that your AGP card is not running at the correct bus speed. To fix this, please clear the CMOS via JP5 and if it still does not work, please upgrade your motherboard bios to the latest version.

## **BIOS Issues**

**Where can I find the BIOS revision of my mainboard?**

It will be displayed on the up-left corner on the screen during boot-up. It will show as your board type followed by the revision number, such as 5EH\_2CA1 (meaning revision 2CA1 for the SY-5EH board) or 6BA+ IV\_2AA2 which means SY-6BA+ IV motherboard with 2AA2 bios.

**Where can I find the latest BIOS of my motherboard?**

Please go to the technical support page of one of the SOYO websites (Taiwan: [www.soyo.com.tw](http://www.soyo.com.tw)), and look up your motherboard to find the latest BIOS revision.

## **Hard disk, floppy drive, CD-ROM etc**

**When I boot up my new computer I got "floppy boot failure" and the LED on the floppy stays on**

Make sure the red wire of floppy ribbon cable goes to Pin1 on the floppy drive side (don't trust the "key lock" or "notch") and use the end-connector of the cable (don't use middle one).

## **Modem issues**

**I get an "I/O Conflict" message when I turn on my system and I can not get my modem to work**

What you need to do is to disable 'COM2' (or UART2 or serial port 2) in the bios under integrated peripheral setup.

**I have installed my modem drivers several times and I still cannot get my modem to work. Why?**

If you are sure that the modem driver has been installed correctly, then you need to install the south bridge driver from the SOYO CD, this is because Windows does not properly recognize relatively new chipsets.

## **Audio Issues**

**How can I disable the on-board Audio ?**

Set the "Onboard 6Ch H/W Audio" option in the BIOS to disable this option can be found under SOYO COMBO Feature.

**In Device Manager, I keep getting yellow exclamation signs on my sound port even though I have installed my sound driver several times and I could not get my sound card to work. What is wrong?**

It is likely that you did not have the correct driver installed. If you are sure that the correct sound driver has been installed, then please install the 'VIA 4 in 1' driver for the motherboard.

**The sound is working in my system, but when I play CD music from the CD-ROM, I do not get any sound. What is wrong?**

This is because the 3-wire audio cable from the CD-ROM to the sound card is not connected or it is loose.

**The sound and everything else works fine except that the recorder and microphone do not work. What is wrong?**

This is because the recorder and microphone in the Windows are not enabled. Please go to sound properties and enable them.

## **Lock up (freeze)**

**When I boot up my system, everything works fine. It sees my CPU and memory, detects my hard drive, floppy drive and CD-ROM but locks up at "Verify DMI pool data... ", and it won't go any further. What should I do?**

Please clear the CMOS via JP5 then choose 'load optimized default' in the bios and save the bios and exit. Next, unplug all other add-on cards except the video card and floppy drive controller, and see if it can boot from floppy. Then put back the peripherals one by one to identify which one causes the lockup.

**I can not get my board to run properly.**

Please make sure you have the latest bios and driver from the SOYO web site at: <http://www.soyo.com>

**I can not use my SCSI card on PCI slot#2, what's the problem?**

Move the SCSI card to another PCI slot, PCI slot#2 and the on-board RAID share the same INT, or disable the on-board RAID.

## **RAID Issues**

**I can not use RAID function on IDE 3\_4.**

Please check RAID\_IDE jumper setting on page 43.

## **2-3.9 Power Off**

There are two possible ways to turn off the system:

1. Use the **Shutdown** command in the **Start Menu** of Windows 95/98 to turn off your computer.
2. Press the mechanical power-button and **hold down for over 4 seconds**, to shutdown the computer. If you press the power-button for less than 4 seconds, then your system will enter into **Suspend Mode**.

You are now ready to configure your system with the BIOS setup program. Go to *Chapter 3: BIOS SETUP*

---

## Chapter 3

# BIOS SETUP UTILITY

This Motherboard's BIOS setup program uses the ROM PCI/ISA BIOS program from Award Software Inc.

To enter the Award BIOS program's Main Menu:

1. Turn on or reboot the system.
2. After the diagnostic checks, press the [Del] key to enter the Award BIOS Setup Utility.

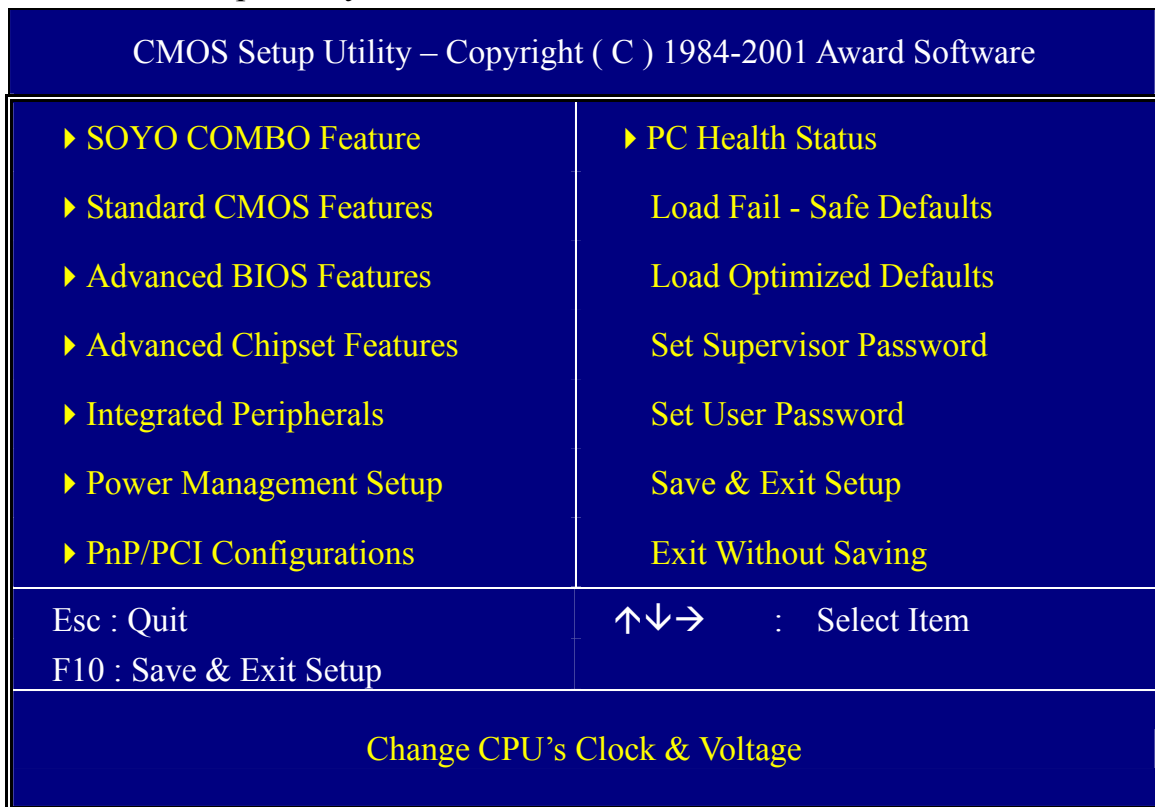

### Selecting items

- Use the arrow keys to move between items and select fields.
- From the Main Menu press arrow keys to enter the selected submenu.

### Modifying selected items

- Use the [Up]/[Down] keys to modify values within the selected fields. Some fields let you enter values directly.

**Hot Keys:** Function keys give you access to a group of commands throughout the BIOS utility.

<b>Function</b>	<b>Command</b>	<b>Description</b>
<b>F1</b>	General Help	Gives the list of options available for each item.
<b>F5</b>	Previous Values	Restore the old values. These are the values that the user started the current session with.
<b>F6</b>	Load Fail-Safe Defaults	Loads all items with the most conservative values.
<b>F7</b>	Load Optimized Defaults	Loads all options with the optimize values.
<b>F10</b>	Save	Saves your changes and reboots the system.
<b>[Esc]</b>	Exit	Returns at anytime and from any location to the Main Menu.
<b>[Enter]</b>	Select	Will display a overlapping window with all options for the current item.
<b>[+/-/PU/PD]</b>	Value	Using the +, -, Page Up and Page Down keys the user can toggle the value of the current item.



## SAVE AND EXIT SETUP

Select the [SAVE & EXIT SETUP] option from the Main Menu to save data to CMOS and exit the setup utility. This option saves all your changes and causes the system to reboot.

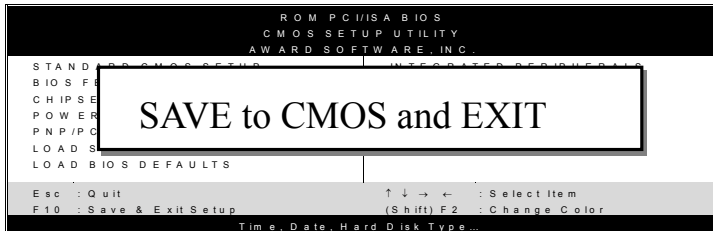

Type [Y] to save the changes and exit or [N] to return to the Main Menu and keep current values.

## EXIT WITHOUT SAVING

Selecting the [EXIT WITHOUT SAVING] option allows you to abandon all data and exit setup, therefore ignoring all your changes.

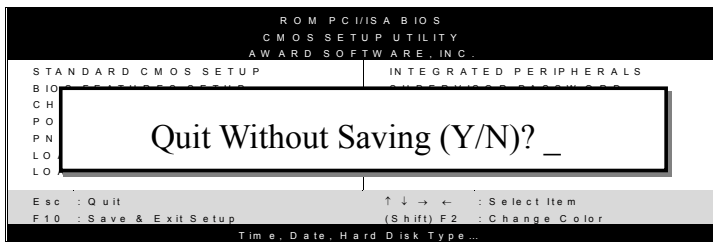

Type [Y] to abandon changes and exit or [N] to return to the Main Menu and keep current values.

### 3-1 SOYO COMBO SETUP

This Motherboard does not use any hardware jumpers to set the CPU frequency. Instead, CPU settings are software configurable with the BIOS [SOYO COMBO SETUP].

After the hardware installation is complete, turn the power switch on, then press the <DEL> key during the system diagnostic checks to enter the Award BIOS Setup program. The CMOS SETUP UTILITY will display on screen. Then, select the [SOYO COMBO SETUP] option from the main menu and press the <Enter> key.

CMOS Setup Utility – Copyright ( C ) 1984-2001 Award Software SOYO COMBO Feature		
Auto Detect DIMM/PCI Clk	Enabled	Item Help Menu Level ▶
Spread Spectrum	Disabled	
CPU Frequency Select	100 MHz	
Frequency 1MHz Stepping	100	
CPU Ratio Select	Auto	
CPU Vcore Select	Default	
Quick Power On Self Test	Enabled	
First Boot Device	Floppy	
Second Boot Device	HDD-0	
Third Boot Device	LS120	
Boot Other Device	Enabled	
RAID/ATA & SCSI Boot Order	RAID/ATA, SCSI	
C . I . H . 4-WAY Protection	Enabled	
Onboard Promise IDE RAID	Disabled	
Onboard 6Ch H/W Audio	Enabled	
VIA OnChip LAN	Enabled	
System Performance	Normal	

↑↓→ Move	Enter:Select	+/-/PU/PD:Value	F10:Save	ESC:Exit	F1:General Help
F5:Previous Values		F6:Fail-Safe Defaults		F7: Optimized Defaults	

The [SOYO COMBO SETUP] menu combines the main parameters that you need to configure, all in one menu, for a quick setup in BIOS.

## SOYO COMBO Feature

	Setting	Description	Note
<b>Auto Detect DIMM/PCI Clk</b>	Disabled	When enabled, this item will auto detect if the DIMM and PCI socket have devices and will send clock signal to DIMM and PCI devices. When disabled, it will send the clock signal to all DIMM and PCI socket.	Default
	Enabled		
<b>Spread Spectrum</b>	Disabled	This item allows you to Disabled / Enabled the spread spectrum modulate.	Default
	Enabled		
<b>CPU Frequency Select</b>	100 MHz	Chose 100MHz/133MHz, depending on the Front Side Bus of your CPU.	Default
	133 MHz		
<b>Frequency 1MHz Stepping</b>	100	Press "Page Up" / "Page Down" key to Over Clock the CPU Front Side Bus in 1MHz increment or Press "Enter" key, then type the desired CPU Front Side Bus.	
<b>CPU Ratio Select</b>	Auto	Allows you to select your CPU Ratio.	Default
	6.0 x, 6.5 x, 7.0 x, 7.5 x, 8.0 x, 8.5x, 9.0 x, 9.5 x, 10.0 x, 10.5 x, 11.0 x, 11.5 x, 12.0 x, 13.0 x, 14.0 x		

**CPU Vcore Select**

	Setting		Description	Note
<b>CPU Vcore Select</b>	Default	+0.200V	This function adjust the CPU voltage.	Default
	+0.025V	+0.225V		
	+0.050V	+0.250V		
	+0.075V	-0.025V		
	+0.100V	-0.050V		
	+0.125V	-0.075V		
	+0.150V	-0.100V		
	+0.175V			

**Quick Power On Self Test**

	Setting	Description	Note
<b>Quick Power On Self Test</b>	Disabled		
	Enabled	Provides a fast POST at boot-up.	Default

**System Boot Control Settings**

System Boot Control Settings	Setting	Description	Note
<b>First /Second/Third Boot Device</b>	Floppy	Select Your Boot Device Priority	
	LS/ZIP		
	HDD-0		
	SCSI		
	CDROM		
	HDD-1		
	HDD-2		
	HDD-3		
	LAN		
	Disabled		
<b>Boot Other Device</b>	Disabled	Select Your Boot Device Priority	Default
	Enabled		
<b>RAID/ATA &amp; SCSI Boot Order</b>	RAID/ATA, SCSI	Select Your RAID/ATA & SCSI Boot Device Priority.	Default
	SCSI, RAID/ATA		

### C.I.H. 4-WAY Protection Settings

	Setting	Description	Note
<b>C.I.H. 4-WAY Protection</b>	Disabled	When set to enabled, the BIOS can only be programmed through AWDFLASH, making sure that any virus is unable to program the system BIOS. Set to disable the BIOS can be programmed the traditional way.	Default
	Enabled		

### Onboard Promise IDE RAID

	Setting	Description	Note
<b>Onboard Promise IDE RAID</b>	Enabled	Enabled/Disabled Onboard IDE H/W RAID.	Default
	Disabled		

### Onboard 6Ch H/W Audio

	Setting	Description	Note
<b>Onboard 6Ch H/W Audio</b>	Enabled	Enabled/Disabled Onboard 6Ch H/W Audio.	Default
	Disabled		

### VIA OnChip LAN

	Setting	Description	Note
<b>VIA OnChip LAN</b>	Enabled	Enabled/Disabled Onboard H/W LAN.	Default
	Disabled		

### System Performance

	Setting	Description	Note
<b>System Performance</b>	Normal	Adjust your computer performance.	Default
	Maximum		

### 3-2 STANDARD CMOS SETUP

Select the [STANDARD CMOS SETUP] option from the Main Menu and press [Enter] key.

CMOS Setup Utility – Copyright ( C ) 1984-2001 Award Software Standard CMOS Features		
Date (mm:dd:yy) Time (hh:mm:ss)	Mon, Jan 1 2001 1 : 1 : 8	Item Help
▶ IDE Primary Master ▶ IDE Primary Slave ▶ IDE Secondary Master ▶ IDE Secondary Slave	Maxtor 52049H3 None LTN485S None	Menu Level ▶ Change the day, month, year and century.
Drive A Floppy 3 Mode Support	1.44M, 3.5 in. Disabled	
Video Halt On	EGA/VGA All Errors	
Base Memory Extended Memory Total Memory	640K 130048K 131072K	
↑↓→ Move	Enter:Select	+/-/PU/PD:Value
F5:Previous Values	F6:Fail-Safe Defaults	F7: Optimized Defaults
F10:Save	ESC:Exit	F1:General Help

This screen allows you to modify the basic CMOS settings.

After you have completed the changes, press [Esc] key to return to the Main Menu.

This Main Menu function automatically detects the hard disk type and configures the [Standard CMOS Features] accordingly.

**CMOS Setup Utility – Copyright ( C ) 1984-2001 Award Software**  
**IDE Primary Master**

IDE HDD Auto-Detection	Press Enter	Item Help
IDE Primary Master	Auto	Menu Level ▶
Capacity	0 MB	
Access Mode	Auto	
Cylinder	0	
Head	0	
Precomp	0	
Landing Zone	0	
Sector	0	

↑↓→:Move	Enter:Select	+/-/PU/PD:Value	F10:Save	ESC:Exit	F1:General Help
F5:Previous Values	F6:Fail-Safe Defaults	F7: Optimized Defaults			



**Note:** This function is only valid for IDE type of hard disk drives.

### Date & Time

	Display	Setting	Please Note
<b>Date</b>	mm/dd/yyyy	Type the current date	You can also the PUp/PDn keys to toggle
<b>Time</b>	hh:mm:ss	Type the current time	24-hour clock format 3:15 PM is displayed as 15:15:00

## Hard Disks Type & Mode

Choose the type and mode for the hard disks that you have already installed.

Primary (Secondary) Master & Slave	Setting	Description	Note
<b>IDE HDD Auto-Detection</b>	Press Enter	To auto-detect the HDD's size, head... on this channel	
<b>IDE Primary Slave (User Type)</b>	Auto	BIOS detects hard disk type automatically.	Default
	User	User defines the type of hard disk.	
	None		
<b>Access Mode</b>	Auto	BIOS detects hard disk mode automatically.	Default
	Normal	Normal IDE hard disk	<528MB
	LBA	Enhanced IDE hard disk	>528MB
	Large	Large IDE hard disk (for certain hard disk)	



**Note:** If you have any questions on your hard disk type or mode, ask your hard disk provider or previous user for details.

## Floppy Drives

Floppy Drives	Setting	Description	Note
<b>Drives A</b>	360KB, 5.25 in.		Default
	1.2MB, 5.25 in.		
	720KB, 3.5 in.		
	1.44MB, 3.5 in.		
	2.88MB, 3.5 in.		
	None	Not installed	
<b>Floppy 3-Mode Support</b>	Disabled		Default
	Drive A	Supports 3-mode floppy diskette: 740KB/1.2MB/ 1.44MB on selected disk drive.	Special disk drive commonly used in Japan



**Others Optional**

	<b>Setting</b>	<b>Description</b>	<b>Note</b>
<b>Video</b>	EGA/VGA	Select the video mode.	Default
	CGA 40		
	CGA 80		
	MONO (Monochrome)		
<b>Halt On</b>	ALL Errors	When the BIOS detects system errors, this function will stop the system. Select which type of error will cause the system halt.	Default
	No Errors		
	All, But Keyboard		
	All, But Diskette		
	All, But Disk/Key		

### 3-3 ADVANCED BIOS FEATURES

Select the [Advanced BIOS Features] option from the Main Menu and press [Enter] key.

CMOS Setup Utility – Copyright ( C ) 1984-2001 Award Software  
Advanced BIOS Features

Virus Warning CPU Internal Cache External Cache Boot Up Floppy Seek Boot Up NumLock Status Gate A20 Option Typematic Rate Setting x Typematic Rate (Chars/Sec) x Typematic Delay (Msec) Security Option OS Select For DRAM > 64MB HDD S.M.A.R.T. Capability Video BIOS Shadow EPA LOGO SELECT Small Logo (EPA) Show	Disabled Enabled Enabled Enabled On Fast Disabled 6 250 Setup Non-OS2 Disabled Enabled LOGO-0 Enabled	<p style="text-align: center;">Item Help</p> <hr/> <p style="text-align: center;">Menu Level ▶</p> <p>Allows you to choose the VIRUS warning feature for IDE Hard Disk boot sector protection. If this function is enabled and someone attempt to write data into this area, BIOS will show a warning message on screen and alarm beep.</p>
---	---	---

↑↓→ Move	Enter:Select	+/-/PU/PD:Value	F10:Save	ESC:Exit	F1:General Help
F5:Previous Values	F6:Fail-Safe Defaults	F7: Optimized Defaults			

After you have completed the changes, press [Esc] key and follow the instructions on your screen to save your settings or exit without saving.

#### Virus Warning

	Setting	Description	Note
<b>Virus Warning</b>	Disabled	If set to enabled, the Paragon Anti-Virus. Function will scan your boot drive for boot virusses. If a boot virus is detected, the BIOS will display a warning message.	Default
	Enabled		

### Cache Memory Options

	Setting	Description	Note
<b>CPU Internal Cache</b>	Disabled		
	Enabled	Enables the CPU's internal cache.	Default
<b>External Cache</b>	Disabled		
	Enabled	Enables the external memory.	Default

### Boot Up Floppy Seek

	Setting	Description	Note
<b>Boot Up Floppy Seek</b>	Disabled	Seeks disk drives during boot up. Disabling speeds boot up.	
	Enabled		Default

### Boot Up NumLock Status

	Setting	Description	Note
<b>Boot Up NumLock Status</b>	On	Puts numeric keypad in NumLock mode at boot-up.	Default
	Off	Puts numeric keypad in arrow key mode at boot-up.	

### Gate A20 Options

	Setting	Description	Note
<b>Gate A20 Options</b>	Normal	Lets chipset control GateA20.	
	Fast	A pin in the keyboard controller controls GateA20.	Default

## Typematic Settings

Typematic Settings	Setting	Description	Note
<b>Typematic Rate Setting</b>	Disabled	Keystrokes repeat at a rate determined by the keyboard.	Default
	Enabled	When enabled, the typematic rate and typematic delay can be selected.	
The following [Typematic Rate] and [Typematic Delay] fields are active only if [Typematic Rate Setting] is set to [Enabled]			
<b>Typematic Rate</b>	6 (Char/sec)	Choose the rate at which a character is repeated when holding down a key.	Default
	8 (Char/sec)		
	10 (Char/sec)		
	12 (Char/sec)		
	15 (Char/sec)		
	20 (Char/sec)		
	24 (Char/sec)		
	30 (Char/sec)		
<b>Typematic Delay</b>	250 (msec)	Choose how long after you press a key down the character begins repeating.	Default
	500 (msec)		
	750 (msec)		
	1000 (msec)		

## Security Option

Use this feature to prevent unauthorized system boot-up or use of BIOS Setup. The following table describes the security settings.

	Setting	Description	Note
<b>Security Option</b>	System	Each time the system is booted, the password prompt appears.	
	Setup	If a password is set, the password prompt only appears when you attempt to enter the BIOS Setup program.	Default

## Other Control Options

Other Control Options	Setting	Description	Note
<b>OS Select for DRAM&gt;64MB</b>	OS2	When using an OS2 operating system.	
	Non-OS2	When using another, non-OS2 operating system.	Default
<b>HDD S.M.A.R.T Capability</b>	Disabled	Enable this field when your HDD supports the S.M.A.R.T. function. Consult your HDD provider for details.	Default
	Enabled		
<b>Video BIOS Shadow</b>	Disabled	The BIOS is shadowed in a 16K segment if it is enabled and if it has BIOS present. These 16 segments can be shadowed from ROM to RAM. BIOS shadow copies BIOS code from slower ROM to faster RAM. BIOS can then execute from RAM.	Default
	Enabled		
<b>EPA LOGO SELECT</b>	LOGO-0	Allows user to display SOYO logo or own logo. Logo-0 Shows SOYO logo. Logo-1 Shows user logo (Default Blank).	Default
	LOGO-1		
<b>Small Logo(EPA) Show</b>	Disabled	Set Enabled to Show Logo(EPA).	
	Enabled		Default

### 3-4 ADVANCED CHIPSET FEATURES

Select the [Advanced Chipset Features] option from the Main Menu and press [Enter] key.



**Caution:** Change these settings only if you are already familiar with the Chipset.

The [Advanced Chipset Features] option changes the values of the chipset registers. These registers control the system options in the computer.

CMOS Setup Utility – Copyright ( C ) 1984-2001 Award Software  
 Advanced Chipset Features

<ul style="list-style-type: none"> <li>▶ DRAM Clock/Driver Control</li> <li>▶ AGP &amp; P2P Bridge Control</li> <li>▶ CPU &amp; PCI Bus Control</li> <li>Memory Hole</li> <li>System BIOS Cacheable</li> <li>Video RAM Cacheable</li> </ul>	Press Enter Press Enter Press Enter Disabled Disabled Disabled	Item Help <hr/> Menu Level ▶
---	---	---------------------------------

↑↓→Move	Enter:Select	+/-/PU/PD:Value	F10:Save	ESC:Exit	F1:General Help
F5:Previous Values		F6:Fail-Safe Defaults			F7: Optimized Defaults

After you have completed the changes, press [Esc] and follow the instructions on your screen to save your settings or exit without saving. The following table describes each field in the Advanced Chipset Features Menu and how to configure each parameter.



## CHIPSET FEATURES SETUP

CHIPSET FEATURES	Setting	Description	Note
<b>Memory Hole</b>	Disabled		Default
	15M-16M	Some interface cards will map their ROM address to this area. If this occurs, select [15M-16M] in this field.	
<b>System BIOS Cacheable</b>	Disabled		
	Enabled	The ROM area F0000H-FFFFFFH is cacheable.	Default
<b>Video RAM Cacheable</b>	Disabled		Default
	Enabled	When synchronous DRAM is installed, the number of clock cycles of CAS latency depends on the DRAM timing. Do not reset this field from the default value specified by the system designer	

### 3-4.1 DRAM Clock/Drive Control



**Caution:** Change these settings only if you are already familiar with the Chipset.

The [DRAM Clock/Drive Control] option changes the values of the chipset registers. These registers control the system options in the computer.

CMOS Setup Utility – Copyright ( C ) 1984-2001 Award Software DRAM Clock/Drive Control		
Current FSB Frequency	100 MHz	Item Help Menu Level ▶
Current DRAM Frequency	133 MHz	
DRAM Clock	By SPD	
DRAM Timing	manual	
x SDRAM Cycle Length	2.5	
x Bank Interleave	Disabled	
Precharge to Active(Trp)	3T	
DRAM Command Rate	2T Command	
↑↓→:Move    Enter:Select    +/-/PU/PD:Value    F10:Save    ESC:Exit    F1:General Help F5:Previous Values    F6:Fail-Safe Defaults    F7: Optimized Defaults		

After you have completed the changes, press [Esc] and follow the instructions on your screen to save your settings or exit without saving.



## DRAM Clock/Drive Control

	Setting	Description	Note
<b>DRAM Clock</b>	100	This item allows you to control the DRAM speed.	
	133		
	By SPD		Default
<b>DRAM Timing</b>	By SPD	If enable the DRAM will auto detect the DRAM timing.	
	Manual		Default
<b>SDRAM Cycle Length</b>	2.5	When synchronous DRAM is installed, the number of clock cycles of CAS latency depends on the DRAM timing. Do not reset this field from the default value specified by the system designer.	Default
	2		
<b>Bank Interleave</b>	Disabled	Increase DRAM performance.	
	2 Bank		Default
	4 Bank		
<b>Precharge to Active(Trp)</b>	2T	Increase DRAM performance.	
	3T		Default
<b>DRAM Command Rate</b>	2T Command	Increase DRAM performance.	Default
	1T Command		

### 3-4.2 AGP & P2P Bridge Control



**Caution:** Change these settings only if you are already familiar with the Chipset.

The [AGP & P2P Bridge Control] option changes the values of the chipset registers. These registers control the system options in the computer.

CMOS Setup Utility – Copyright ( C ) 1984-2001 Award Software					
AGP & P2P Bridge Control					
AGP Aperture Size	64M	Item Help  Menu Level ▶			
AGP Mode	4X				
AGP Driving Control	Auto				
x AGP Driving Value	DA				
AGP Fast Write	Disabled				
AGP Master 1 WS Write	Disabled				
AGP Master 1 WS Read	Disabled				
AGP Post Write	Enabled				
↑↓→:Move	Enter:Select	+/-/PU/PD:Value	F10:Save	ESC:Exit	F1:General Help
F5:Previous Values		F6:Fail-Safe Defaults		F7: Optimized Defaults	

After you have completed the changes, press [Esc] and follow the instructions on your screen to save your settings or exit without saving.

### 3-4.3 AGP & P2P Bridge Control

	Setting	Description	Note
<b>AGP Aperture Size</b>	64M	Select the size of Accelerated Graphics Port (AGP) aperture. The aperture is a portion of the PCI memory address range dedicated for graphics memory address space. Host cycles that hit the aperture range are forwarded to the AGP without any translation.	Default
	4M, 8M, 16M, 32M, 128M, 256M.		
<b>AGP Mode</b>	1X	This item allows you to enable / disable the AGP-4X Mode.	Default
	2X		
	4X		
<b>AGP Driving Control</b>	Auto	This item allows you to adjust the AGP driving force. Choose <i>Manual</i> to key in a AGP Driving Value in the next selection. This field is recommended to set in Auto for avoiding any error in your system.	Default
	Manual		
<b>AGP Driving Value</b>	Min=0000 ~ Max=00FF	This item allows you to adjust the AGP driving force.	
<b>AGP Fast Write</b>	Disabled	The VIA chipset will use fast write to AGP if this item is enabled. Not all AGP cards support fast write.	Default
	Enabled		
<b>AGP Master 1 WS Write</b>	Disabled	When <i>Enabled</i> , writes to the AGP(Accelerated Graphics Port) are executed with one wait states.	Default
	Enabled		
<b>AGP Master 1 WS Read</b>	Disabled	When <i>Enabled</i> , read to the AGP (Accelerated Graphics Port) are executed with one wait states.	Default
	Enabled		
<b>AGP Post Write</b>	Disabled	Enabled/Disabled AGP Post Write.	Default
	Enabled		

### 3-4.4 CPU & PCI Bus Control



**Caution:** Change these settings only if you are already familiar with the Chipset.

The [CPU & PCI Bus Control] option changes the values of the chipset registers. These registers control the system options in the computer.

CMOS Setup Utility – Copyright ( C ) 1984-2001 Award Software CPU & PCI Bus Control														
PCI Master 0 WS Write	Enabled	Item Help Menu Level ▶												
PCI Post Write	Enabled													
PCI Delay Transaction	Disabled													
<table border="0"> <tr> <td>↑↓→:Move</td> <td>Enter:Select</td> <td>+/-/PU/PD:Value</td> <td>F10:Save</td> <td>ESC:Exit</td> <td>F1:General Help</td> </tr> <tr> <td colspan="2">F5:Previous Values</td> <td colspan="2">F6:Fail-Safe Defaults</td> <td colspan="2">F7: Optimized Defaults</td> </tr> </table>			↑↓→:Move	Enter:Select	+/-/PU/PD:Value	F10:Save	ESC:Exit	F1:General Help	F5:Previous Values		F6:Fail-Safe Defaults		F7: Optimized Defaults	
↑↓→:Move	Enter:Select	+/-/PU/PD:Value	F10:Save	ESC:Exit	F1:General Help									
F5:Previous Values		F6:Fail-Safe Defaults		F7: Optimized Defaults										

After you have completed the changes, press [Esc] and follow the instructions on your screen to save your settings or exit without saving.

**CPU & PCI Bus Control**

	Setting	Description	Note
<b>PCI Master 0 WS Write</b>	Disabled		
	Enabled	When <i>Enabled</i> , writes to the PCI bus are executed with zero wait states.	Default
<b>PCI Post Write</b>	Disabled		
	Enabled	This item allows you to enabled/disabled the PCI post write.	Default
<b>PCI Delay Transaction</b>	Disabled		
	Enabled	The chipset has an embedded 32-bit posted write buffer to support delay transactions cycles. Select <i>Enabled</i> to support compliance with PCI specification version 2.1.	Default

### 3-5 INTEGRATED PERIPHERALS

Select the [Integrated Peripherals] option from the Main Menu and press [Enter] key.



**Caution:** Change these settings only if you are already familiar with the Chipset.

The [INTEGRATED PERIPHERALS] option changes the values of the chipset registers. These registers control the system options in the computer. The following screen shows setup default settings.

CMOS Setup Utility – Copyright ( C ) 1984-2001 Award Software  
 Integrated Peripherals

▶ VIA OnChip IDE Device ▶ SuperIO Device Init Display First OnChip USB Controller USB Keyboard Support IDE HDD Block Mode	Press Enter Press Enter AGP 1 USB Port Disabled Enabled	Item Help <hr/> Menu Level ▶
--	--	---------------------------------

↑↓→ Move	Enter:Select	+/-/PU/PD:Value	F10:Save	ESC:Exit	F1:General Help
F5:Previous Values		F6:Fail-Safe Defaults		F7: Optimized Defaults	

After you have completed the changes, press [Esc] and follow the instructions on your screen to save your settings or exit without saving.

### INTEGRATED PERIPHERALS

	Setting	Description	Note
<b>Init Display First</b>	PCI Slot	Choose which card – AGP	
	AGP	Display card or PCI VGA card – to initialize first.	Default

## INTEGRATED PERIPHERALS

	Setting	Description	Note
<b>OnChip USB Controller</b>	All Disabled	This should be enabled if your system has a USB installed on the system board and you want to use it. Even when so equipped, if you add a higher performance controller, you will need to disable this feature. Port 1 means USB1&2 Port 2 means USB3&4 Port 3 means USB5&6	Default
	All Enabled		
	1&2 USB Port		
	2&3 USB Port		
<b>USB Keyboard Support</b>	3&1 USB Port	Select <i>Enabled</i> if your system contains a Universal Serial Bus (USB) controller and you have a USB keyboard.	Default
	1 USB Port		
	2 USB Port		
<b>IDE HDD Block Mode</b>	3 USB Port	Invokes multi-sector transfer instead of one sector per transfer. Not all HDDs support this function.	Default
	Disabled		
	Enabled		

### 3-5.1 VIA OnChip IDE Device



**Caution:** Change these settings only if you are already familiar with the Chipset.

The [VIA OnChip IDE Device] option changes the values of the chipset registers. These registers control the system options in the computer.

The following screen shows setup default settings.

CMOS Setup Utility – Copyright ( C ) 1984-2001 Award Software			
VIA OnChip IDE Device			
OnChip IDE Channel0		Enabled	Item Help
OnChip IDE Channel1		Enabled	
IDE Prefetch Mode		Enabled	Menu Level ▶
Primary Master	PIO	Auto	
Primary Slave	PIO	Auto	
Secondary Master	PIO	Auto	
Secondary Slave	PIO	Auto	
Primary Master	UDMA	Auto	
Primary Slave	UDMA	Auto	
Secondary Master	UDMA	Auto	
Secondary Slave	UDMA	Auto	

↑↓→:Move	Enter:Select	+/-/PU/PD:Value	F10:Save	ESC:Exit	F1:General Help
F5:Previous Values		F6:Fail-Safe Defaults		F7: Optimized Defaults	

After you have completed the changes, press [Esc] and follow the instructions on your screen to save your settings or exit without saving.



## VIA OnChip IDE Device

	Setting	Description	Note
<b>On-Chip PCI IDE</b> ➤ <b>Primary</b> ➤ <b>Secondary</b>	Disabled	Turn off the on-board IDE	
	Enabled	Use the on-board IDE	Default
<b>IDE</b> ➤ <b>Primary Master PIO</b> ➤ <b>Primary Slave PIO</b> ➤ <b>Secondary Master PIO</b> ➤ <b>Secondary Slave PIO</b>	mode 0-4	0 is the slowest speed 4 is the fastest speed	
	Auto	For better performance and stability, we suggest you use the Auto setting to set the HDD control timing.	Default
<b>IDE</b> ➤ <b>Primary Master UDMA</b> ➤ <b>Primary Slave UDMA</b> ➤ <b>Secondary Master UDMA</b> ➤ <b>Secondary Slave UDMA</b>	Disabled		
	Auto	Select Auto to enable Ultra DMA Mode support.	Default

### 3-5.2 SuperIO Device



**Caution:** Change these settings only if you are already familiar with the Chipset.

The [SuperIO Device] option changes the values of the chipset registers. These registers control the system options in the computer. The following screen shows setup default settings.

CMOS Setup Utility – Copyright ( C ) 1984-2001 Award Software  
 SuperIO Device

Onboard FDD Controller Onboard Serial Port 1 Onboard Serial Port 2 UART Mode Select x UR2 Duplex Mode Onboard Parallel Port Parallel Port Mode x ECP Mode Use DMA	Enabled 3F8/IRQ4 2F8/IRQ3 Normal Half 378/IRQ7 SPP 3	Item Help <hr/> Menu Level ▶
--	---	---------------------------------

↑↓→:Move	Enter:Select	+/-/PU/PD:Value	F10:Save	ESC:Exit	F1:General Help
F5:Previous Values	F6:Fail-Safe Defaults	F7: Optimized Defaults			

After you have completed the changes, press [Esc] and follow the instructions on your screen to save your settings or exit without saving.

#### SuperIO Device

	Setting	Description	Note
<b>Onboard FDD controller</b>	Disabled	Turn off the on-board floppy controller	
	Enabled	Use the on-board floppy controller	Default

**SuperIO Device**

	Setting	Description	Note
<b>Onboard Serial Port 1 / Serial Port 2</b>	Disabled		
	3F8/IRQ4	Choose serial port 1 & 2's I/O address.	Default (port 1)
	2F8/IRQ3	Do not set port 1 & 2 to the same address except for Disabled or Auto.	Default (port 2)
	3E8/IRQ4		
	2E8/IRQ3		
	Auto		
<b>UART Mode</b>	IrDA	The second serial port offers these InfraRed interface modes.	
	ASKIR		
	Normal		Default
	SCR	SCR mean Smart Card Reader.	
If [UART Mode Select] is set to [IrDA]/[ASKIR]			
<b>UR2 Function Duplex</b>	Half	Choose [Half] or [Duplex] to set UR2 in half duplex mode or full duplex mode respectively. Refer to your IR device specifications to select the suitable mode.	Default
	Full		
<b>Onboard Parallel Port</b>	Disabled	Choose the printer I/O address.	
	378/IRQ7		Default
	278/IRQ5		
	3BC/IRQ7		
<b>Parallel Port Mode</b>	SPP	The mode depends on your external device that connects to this port.	Default
	EPP		
	ECP		
	ECP+EPP		
If [Parallel Port Mode] is set to [ECP] or [ECP+EPP] mode			
<b>ECP Mode use DMA</b>	3	Choose DMA3	Default
	1	Choose DMA1	

### 3-6 POWER MANAGEMENT SETUP

The [POWER MANAGEMENT SETUP] sets the system's power saving functions.

CMOS Setup Utility – Copyright ( C ) 1984-2001 Award Software  
Power Management Setup

▶ ACPI Suspend Type	S1 (POS)	Item Help Menu Level ▶
Power Management Option	User Define	
HDD Power Down Suspend Mode	Disable	
Video Off Option	Disable	
Video Off Method	Suspend -> Off	
MODE Use IRQ	V/H SYNC+Blank	
Soft-Off by PWRBTN	3	
State After Power Failure	Instant-Off	
State After Power Failure	Off	
▶ IRQ/Event Activity Detect	Press Enter	

↑↓→ Move    Enter:Select    +/-/PU/PD:Value    F10:Save    ESC:Exit    F1:General Help  
 F5:Previous Values    F6:Fail-Safe Defaults    F7: Optimized Defaults

CMOS Setup Utility – Copyright ( C ) 1984-2001 Award Software  
IRQ/Event Activity Detect

PS2KB Wakeup	Disabled	Item Help Menu Level ▶
VGA	OFF	
LPT & COM	LPT/COM	
HDD & FDD	ON	
PCI Master	OFF	
PowerOn by PCI Card	Disabled	
Wake Up On LAN/Ring	Disabled	
RTC Alarm Resume	Disabled	
x Date (of Month)	0	
x Resume Time (hh:mm:ss)	0 : 0 : 0	
▶ IRQs Activity Monitoring	Press Enter	

↑↓→ Move    Enter:Select    +/-/PU/PD:Value    F10:Save    ESC:Exit    F1:General Help  
 F5:Previous Values    F6:Fail-Safe Defaults    F7: Optimized Defaults

After you have completed the Power Management Setup, press [Esc] to return to the Main Menu.

## Power Management Controls

	Setting	Description	Note
<b>ACPI Suspend Type</b>	S1(POS)	The system will enter the S1 state during suspend. (Low latency wake up)	Default
<b>Power Management Option</b>	User Define	Lets you define the system power down times.	Default
	Min Saving		15 Min
	Max Saving		1 Min
<b>HDD Power Down</b>	Disabled	Lets you define the system power down times.	Default
	1Min, 2Min, 3Min, 4Min, 5Min, 6Min, 7Min, 8Min, 9Min, 10Min, 11Min, 12Min, 13Min, 14Min, 15Min		
<b>Suspend Mode</b>	Disabled	Lets you define the system power down times.	Default
	1Min, 2Min, 4Min, 6Min, 8Min, 10Min, 20Min, 30Min, 40Min, 1Hour,		
<b>Video Off Option</b>	Suspend --> Off	When enabled, this feature allows the VGA adapter to operate in a power saving mode.	Default
	Always On		
	All Modes --> Off		
<b>Video Off Method</b>	V/H Sync+Blank	Selects the method by which the monitor is blanked.	Default
	Blank screen		
	DPMS Support		

**Power Management Controls (Continued)**

	Setting	Description	Note
<b>MODEM Use IRQ</b>	3	Assigns an IRQ# to the modem device.	Default
	3-11, NA		
<b>Soft-Off by PWR-BTTN</b>	Instant-off		Default
	Delay 4 Sec.	Turns off the system power 4 seconds after pushing the power button.	
<b>State After Power Failure</b>	On	The system will switch on when power comes back after a power failure.	
	Off	The system will remain off when power comes back after a power failure.	Default
	Auto	The system will return to the state it was in before the power failure when power returns. (i.e: If the system was on, it will switch on again, if it was off, it will remain off)	
<b>IRQ/Event Activity Detect</b>	Press Enter	Select items that will wake up your system when in one of sleep modes. Press enter to go the select item page.	

## IRQ/Event Activity Detect

	Setting	Description	Note
<b>PS2KB Wakeup</b>	Disabled	You can set the PS2KB Hotkey to Wakeup system.	Default
	Ctrl+F1~F12		
	Power		
	Wake		
<b>LPT &amp; COM</b>	LPT/COM	When <i>On of</i> LPT & COM, any activity from one of the listed system peripheral devices or IRQs wakes up the system.	Default
	NONE, LPT, COM		
<b>HDD &amp; FDD</b>	OFF	When <i>On of</i> HDD & FDD, any activity from one of the listed system peripheral devices wakes up the system.	Default
	ON		
<b>PCI Master</b>	OFF	When <i>On of</i> PCI Master, any activity from one of the listed system peripheral devices wakes up the system	Default
	ON		
<b>PowerOn by PCI Card</b>	Disabled	If enabled any PCI interrupt will wake up the system.	Default
	Enabled		
<b>Wake Up On LAN/Ring</b>	Disabled	An input signal on the serial Ring Indicator (RI) line (in other words, an incoming call on the modem/LAN) awakens the system from a soft off state.	Default
	Enabled		
<b>RTC Alarm Resume</b>	Disabled	The system ignores the alarm.	Default
	Enabled	Set alarm to power on the system by the date (1-31) or time (hh:mm:ss). If the date is set to [0], the system will self-power on by alarm everyday at the set time.	

### 3-6.1 IRQs Activity Monitoring

This option sets the IRQs Activity Monitoring.

CMOS Setup Utility – Copyright ( C ) 1984-2001 Award Software		
IRQs Activity Monitoring		
Primary INTR	ON	Item Help  Menu Level ▶
IRQ3 (COM 2)	Enabled	
IRQ4 (COM 1)	Enabled	
IRQ5 (LPT 2)	Enabled	
IRQ6 (Floppy Disk)	Enabled	
IRQ7 (LPT 1)	Enabled	
IRQ8 (RTC Alarm)	Disabled	
IRQ9 (IRQ2 Redir)	Disabled	
IRQ10 (Reserved)	Disabled	
IRQ11 (Reserved)	Disabled	
IRQ12 (PS/2 Mouse)	Enabled	
IRQ13 (Coprocessor)	Enabled	
IRQ14 (Hard Disk)	Enabled	
IRQ15 (Reserved)	Disabled	

↑↓→ Move	Enter:Select	+/-/PU/PD:Value	F10:Save	ESC:Exit	F1:General Help
F5:Previous Values	F6:Fail-Safe Defaults	F7: Optimized Defaults			

After you have completed the changes, press [Esc] and follow the instructions on your screen to save your settings or exit without saving.



## IRQs Activity Monitoring

Wake Up Events	Setting	Description	Note
<b>Primary INTR</b>	ON	When set to <i>On</i> , any event occurring at will awaken a system which has been powered down.	Default
	OFF		
<b>IRQs Activity Monitoring (Press Enter)</b>	Enabled	IRQ3(COM2), IRQ4(COM1), IRQ5(LPT2), IRQ6(Floppy Disk), IRQ7(LPT1), IRQ12(PS/2 mouse), IRQ13(Coprocessor), IRQ14(HardDisk)	
	Disabled	IRQ8 (RTC Alarm), IRQ9(IRQ2 Redir), IRQ10( Reserved), IRQ11(Reserved), IRQ15 (Reserved)	

### 3-7 PNP/PCI CONFIGURATIONS

This option sets the Motherboard's PCI Slots.

CMOS Setup Utility – Copyright ( C ) 1984-2001 Award Software PNP/PCI Configurations					
PNP OS Installed	NO	Item Help  Menu Level ▶  Select Yes if you are using a Plug and Play capable operating system Select No if you need the BIOS to configure non-boot devices.			
Reset Configuration Data	Disabled				
Resources Controlled By	Auto (ESCD)				
x IRQ Resources	Press Enter				
PCI/VGA Palette Snoop	Disabled				
Assign IRQ For VGA	Enabled				
Assign IRQ For USB	Enabled				
INT Pin 1 Assignment	Auto				
INT Pin 2 Assignment	Auto				
INT Pin 3 Assignment	Auto				
INT Pin 4 Assignment	Auto				
↑↓→ Move	Enter:Select	+/-/PU/PD:Value	F10:Save	ESC:Exit	F1:General Help
F5:Previous Values		F6:Fail-Safe Defaults		F7: Optimized Defaults	



**Note:** Starred (\*) items will disappear when the [Resources Controlled By] option is set to [Auto].

After you have completed the PCI Slot Configuration, press [Esc] and follow the instructions on your screen to save your settings or exit without saving.

**PNP/PCI Configuration Controls**

<b>PNP/PCI Controls</b>	<b>Setting</b>	<b>Description</b>	<b>Note</b>
<b>PnP OS Installed</b>	Yes	Set this field to [Yes] if you are running Windows 95, which is PnP compatible.	
	No	If the OS you are running does not support PnP configuration.	Default (If there is any doubt, set this field to [No])
<b>Reset Configuration Data</b>	Disabled	Retain PnP configuration data in BIOS.	Default
	Enabled	Reset PnP configuration data in BIOS.	
<b>Resources Controlled By</b>	Manual	BIOS does not manage PCI/ISA PnP card IRQ assignment. Requires to assign IRQ-# to PCI or ISA PnP manually. IRQ-3,4,5,7,9,10,11,12,14,15 assigned to: _ DMA-0,1,3,5,6,7 assigned to: _	
	Auto (ESCD)	The Plug-and-Play BIOS auto manages PCI/ISA PnP card IRQ assignment automatically.	Recommended
If [Resources Controlled By] is set to [Manual]			
<b>IRQ Resource (Press Enter)</b>	PCI Device	Choose IRQ-# assigned to PCI/ISA PnP card.	IRQ-3,4,5,7,9,10,11,12,14,15
	Reserved	Choose IRQ-# assigned to Legacy ISA card.	IRQ-3,4,5,7,9,10,11,12,14,15
Under this item the user can assign an IRQ to a PCI slot. However, there under some conditions the IRQ will not be assigned as selected under this item: 1. IRQs 0, 1, 2, 6, 8, 13 can NOT be assigned, because they are fixed. 2. IRQs 5, 9, 10, 11 are available 3. IRQs 3,4,7,12,14 and 15 will only be assigned if they are free. See the table below on how to free them:			

### PNP/PCI Configuration Setup (Continued)

PNP/PCI Setup	Setting	Description	Note
Interrupt Line	How to set the BIOS to release the IRQ to the PnP Interrupt pool:		
	PnP / PCI configuration	Integrated Peripherals	
IRQ 15	IRQ 15: <b>PCI / ISA PnP</b>	On-Chip Secondary PCI IDE:	<b>disabled</b>
IRQ 14	IRQ 14: <b>PCI / ISA PnP</b>	On-Chip Primary PCI IDE:	<b>disabled</b>
IRQ 12	IRQ 12: <b>PCI / ISA PnP</b>	<i>Interrupt 12 will be released by the PnP BIOS automatically if the PS/2 Mouse Port is not used.</i>	
IRQ 7	IRQ 7: <b>PCI / ISA PnP</b>	Onboard parallel port:	<b>disabled</b>
IRQ 4	IRQ 4: <b>PCI / ISA PnP</b>	Onboard Serial port 1:	<b>disabled</b>
IRQ 3	IRQ 3: <b>PCI / ISA PnP</b>	Onboard Serial port 2:	<b>disabled</b>
4. Your OS may reassign another interrupt to a PCI slot after BIOS passes control to the OS, especially if you use Windows 95, 98 or NT.			
<b>Assign IRQ For VGA/USB</b>	Disabled	BIOS will assign IRQ for VGA/USB port.	
	Enabled	BIOS won't assign IRQ for VGA/USB port.	Default
5. Your OS may reassign another interrupt to a PCI slot after BIOS passes control to the OS, especially if you use Windows 95, 98 or NT.			
<b>INT Pin 1/2/3/4 Assignment</b>	Auto	Set to Auto the BIOS will using IRQs Automatically.	Default

### MULTI I/O ADDRESSES

Default settings for multi-I/O addresses are as follows:

Port	I/O Address	IRQ	Status
<b>LPT1</b>	378H	7	ECP/EPP
<b>COM1</b>	3F8H	4	
<b>COM2</b>	2F8H	3	



**Warning:** If a default I/O address conflicts with other I/O cards such as sound card, you must change one of the I/O addresses to remedy to this address conflict. (I/O addresses can be adjusted from the BIOS Setup Utility)

### 3-8 PC HEALTH STATUS

This option sets the Motherboard's PC Health Status.

CMOS Setup Utility – Copyright ( C ) 1984-2001 Award Software		
PC Health Status		
Vcore	1.77 V	Item Help Menu Level ▶
VCC 2.5V	2.46 V	
3.3 V	3.32 V	
+ 5 V	4.94 V	
+ 12 V	12.16 V	
- 12 V	(-)12.19 V	
- 5 V	(-) 5.05 V	
5VSB	4.94V	
Current CPU Temp.	44 ° C	
Current SYS Temp.	37 ° C	
Current CPUFAN1 Speed	4440 RPM	
Current CHAFAN1 Speed	0 RPM	
FOC (Fan-Off Control)	Enabled	

↑↓→ Move	Enter:Select	+/-/PU/PD:Value	F10:Save	ESC:Exit	F1:General Help
F5:Previous Values	F6:Fail-Safe Defaults	F7: Optimized Defaults			

After you have completed the changes, press [Esc] key and follow the instructions on your screen to save your settings or exit without saving.

## CPU Device Monitoring

CPU Device Monitoring	Setting	Description	Note
<b>Vcore Vcc 2.5V, 3.3V, +5V, +12V, -12V, -5V, 5VSB</b>	V	Show the current voltage status.	
<b>Current CPU Temp.</b>	°C/°F	Show the current status of CPU temperature.	
<b>Current SYS Temp.</b>	°C/°F	Show the current status of the System temperature.	
<b>Current CPUFAN/ CHAFAN Speed</b>	RPM	Show the current status of CPU/CHA Fan.	
<b>FOC (Fan-Off Control)</b>	Disabled	If enable, this function protect user's CPU from overheating in an event there's a problem with the CPU FAN. The user should also plug the CPU FAN power on the CPU FAN1 pin. If not, system will auto shutdown.	Default
	Enabled		

### 3-9 LOAD FAIL-SAFE DEFAULTS

Select the [Load Fail-Safe Defaults] option from the Main Menu to load the system values you have previously saved. This option is recommended if you need to reset the system setup and to retrieve the old values.

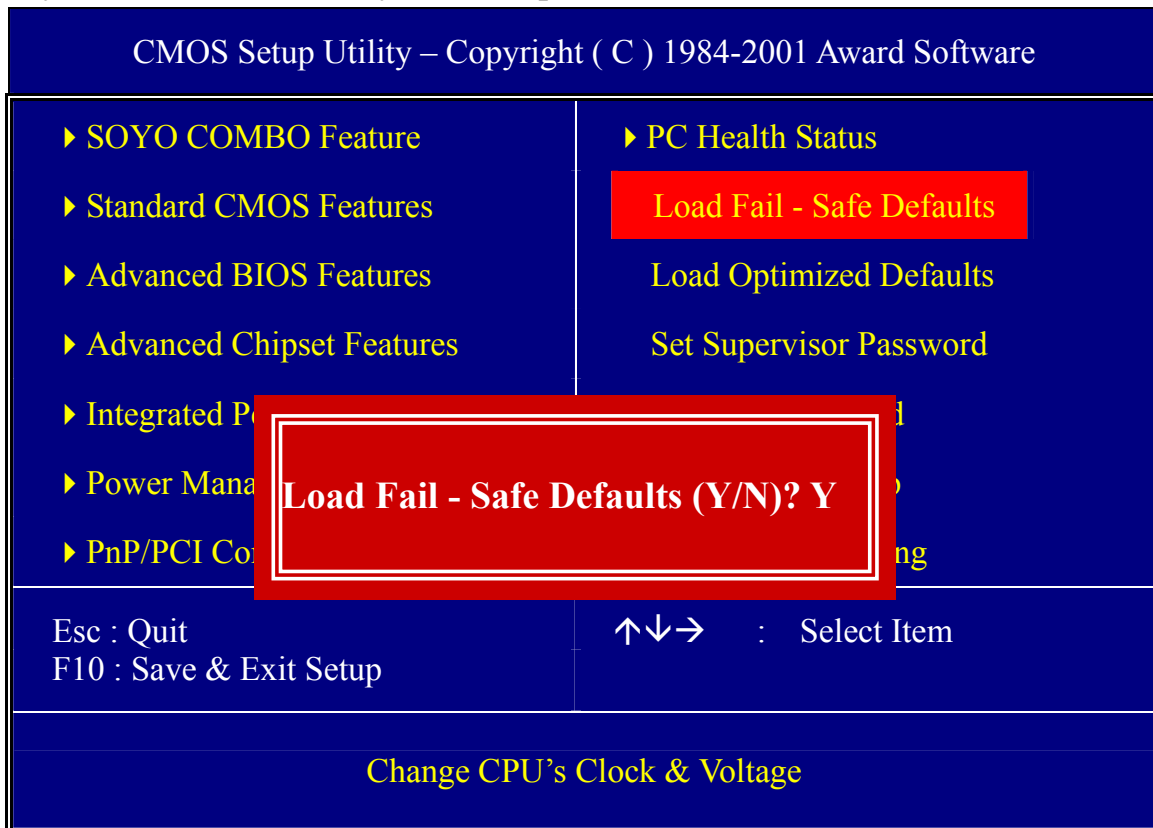

Type [Y] to use the Setup Defaults followed by [Enter] or otherwise [N] to return to the Main Menu and keep current values.



**Warning:** If you run into any problem after changing the BIOS configuration, please load the Fail-Safe Defaults for stable performance.

### 3-10 LOAD OPTIMIZED DEFAULTS

Select the [Load Optimized Defaults] option from the Main Menu to load the system values you have previously saved. This option is recommended if you need to reset the system setup and to retrieve the old values.

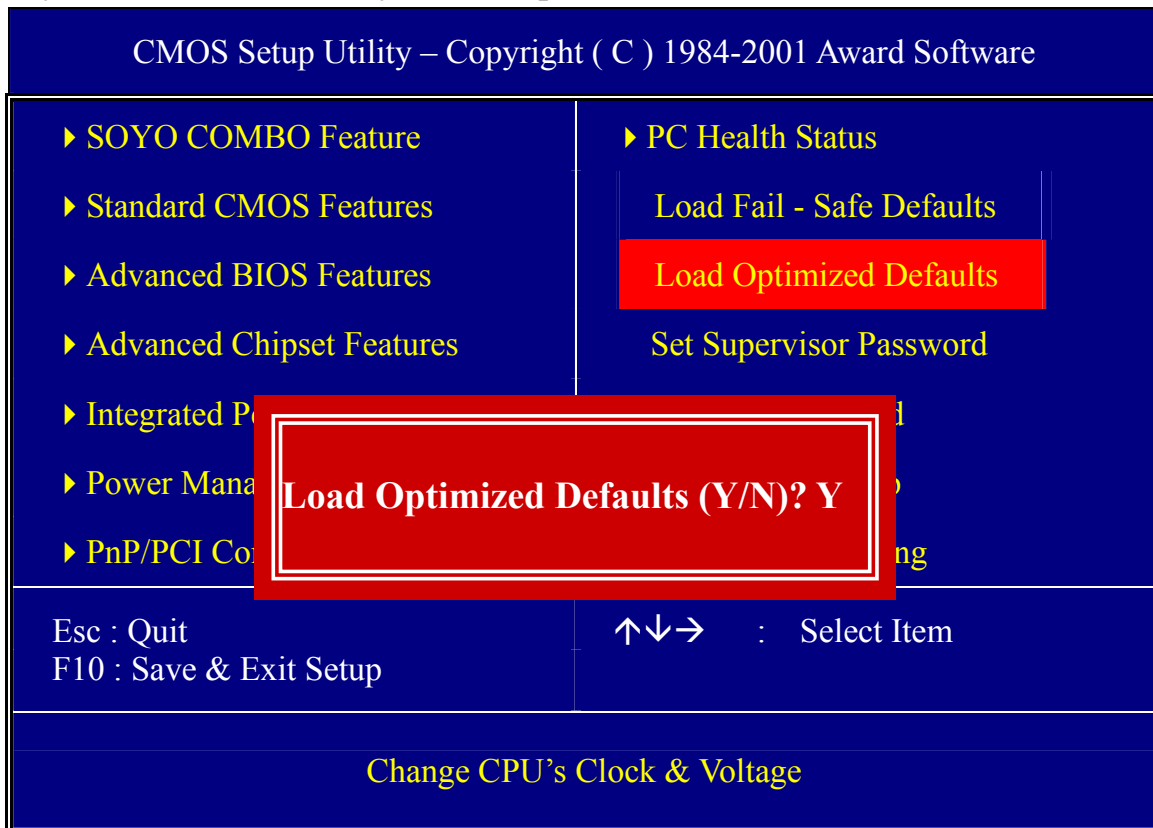

Type [Y] to use the Setup Defaults followed by [Enter] or otherwise [N] to return to the Main Menu and keep current values.



**Warning:** If you run into any problem after changing the BIOS configuration, please load the Fail-Safe Defaults for stable performance.



### 3-11 SET SUPERVISOR PASSWORD

Based on the setting you have made in the [Security Option] of the [BIOS FEATURES SETUP] section, the password prevents access to the system or the setup program by unauthorized users. Follow this procedure to set a new password or disable the password:

1. Choose [BIOS FEATURES SETUP] in the Main Menu and press [Enter]. Select the [Security Options] item and set the field to:
  - a. [System]: The password is required every time the system is booted. This means only a person who knows the password can use this computer.
  - b. [Setup]: The password is required only when you attempt to enter the BIOS Setup program.
2. Choose [SUPERVISOR PASSWORD] from the Main Menu and press [Enter]. The following prompt appear:

Enter Password:



---

**Warning:** If you forget or lose the password, the only way to access the system is to set jumper JP5 to clear the CMOS RAM. All setup information is lost and you must run the BIOS setup program again.

---



---

**Note:** If you do not wish to use the password function, press [Enter] directly and the following message appears:

Password Disabled!!

---

3. Enter your new password and press [Enter]. The following message appears, prompting to confirm the new password:

Confirm Password:

4. Re-enter your password and then press [Enter] to exit to the Main Menu.

This diagram outlines the password selection procedure:

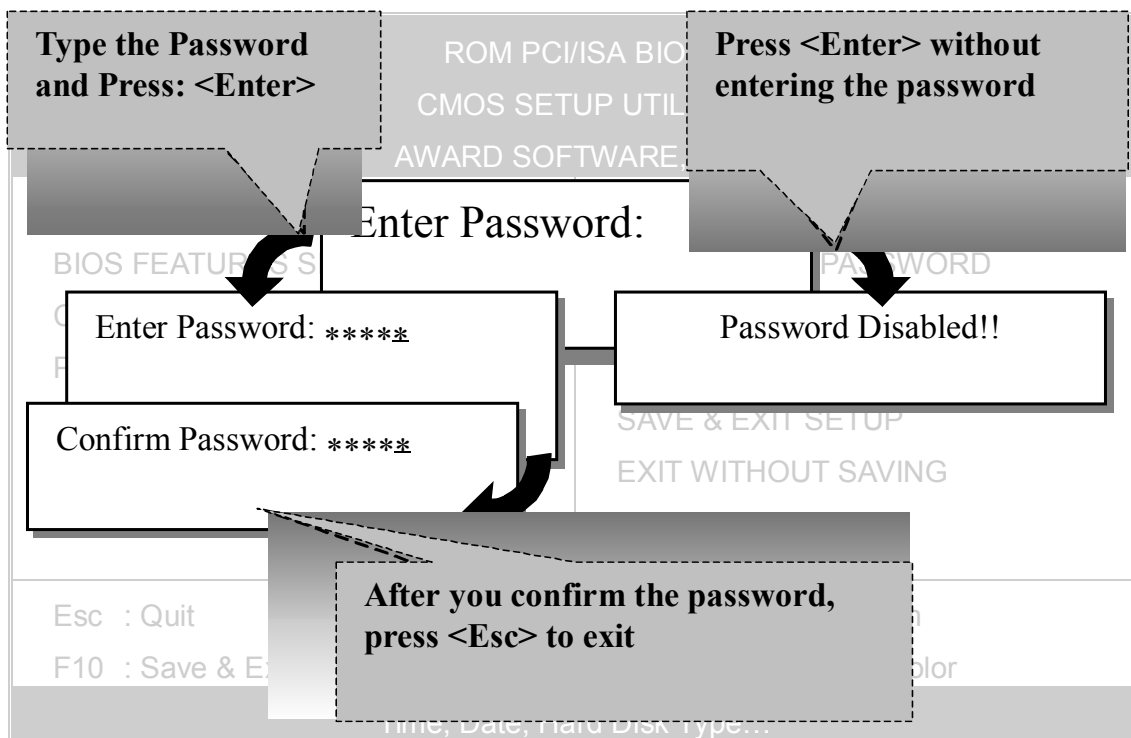

### 3-12 SET USER PASSWORD

When the user password option is on, you are not allowed to change any setting in the [CMOS SETUP UTILITY] except for changing the user's password.

The password setting procedure is similar to that for the [SUPERVISOR PASSWORD] (Refer to section 3-9).

## Boot Menu

Boot Menu enables user to boot-up on different boot device without going into the BIOS setup.

*To enable boot Menu, press “ESC” after memory initialization, user will see a device menu, in which user can choose the device they wish to boot from.*

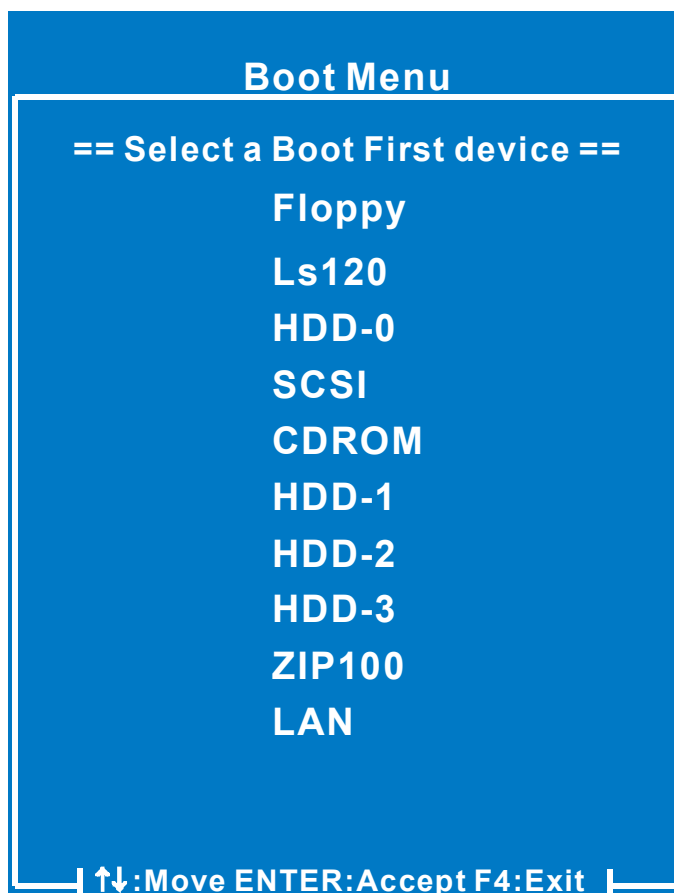

## Chapter 4

# DRIVERS INSTALLATION



**The SOYO-CD will NOT autorun if you use it on an Operating System other than Windows 98/98SE/ME.**

Your SY-K7V DRAGON Motherboard comes with a CD-ROM labeled "SOYO CD." The SOYO CD contains (1) the user's manual file for your new Motherboard, (2) the drivers software available for installation, and (3) a database in HTML format with information on SOYO Motherboards and other products.

### **Step 1. Insert the SOYO CD into the CD-ROM drive**

If you use Windows 2000 or NT, the SOYO-CD will not detect your motherboard type. In that case the following dialog will pop up, please choose your motherboard and press OK. Now the SOYO-CD Start Up Menu will be shown.

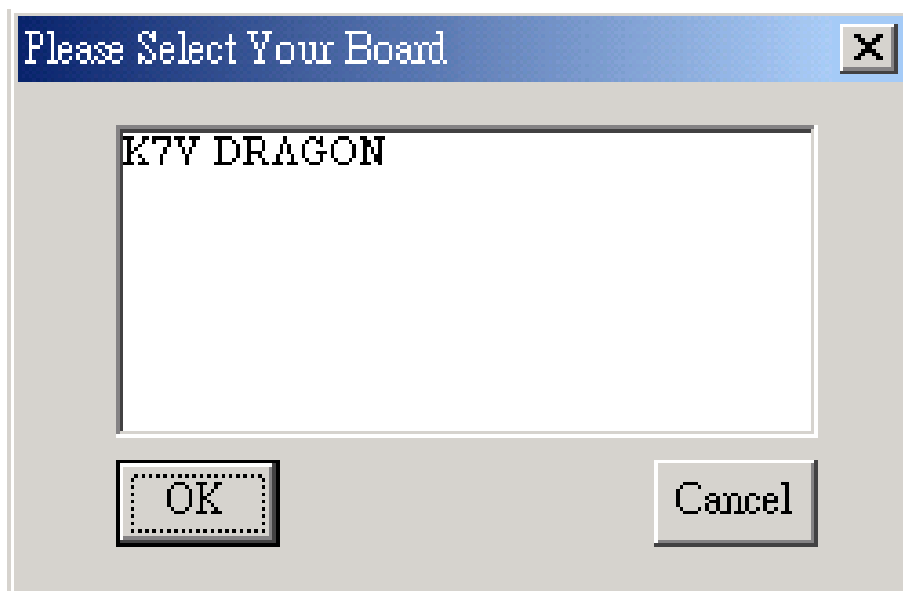

**(SOYO CD Start Up Program Menu)**

If you use Windows 95/98/ME, the SOYO CD Start Up Program automatically detects which SOYO Motherboard you own and displays the corresponding model name.

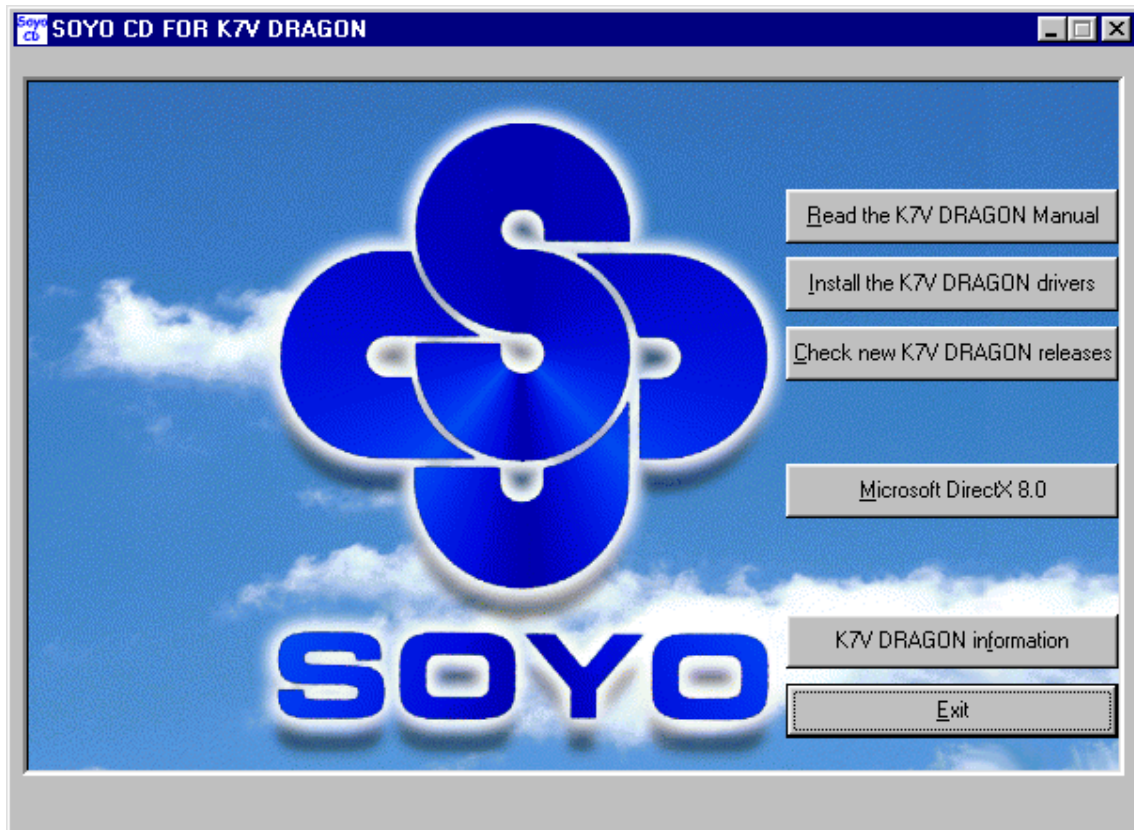

The user's manual files included on the SOYO CD are in PDF (Postscript Document) format. In order to read a PDF file, the appropriate Acrobat Reader software must be installed in your system.

**Note:** The Start Up program automatically detects if the Acrobat Reader utility is already present in your system, and otherwise prompts you on whether or not you want to install it. You must install the Acrobat Reader utility to be able to read the user's manual file. Follow the instructions on your screen during installation, then once the installation is completed, restart your system and re-run the SOYO CD.

## Step 2. Install Drivers and Utilities

Click the **Install Drivers** button to display the list of drivers software that can be installed with your Motherboard. The Start Up program displays the drivers available for the particular model of Motherboard you own. We recommend that you only install those drivers.

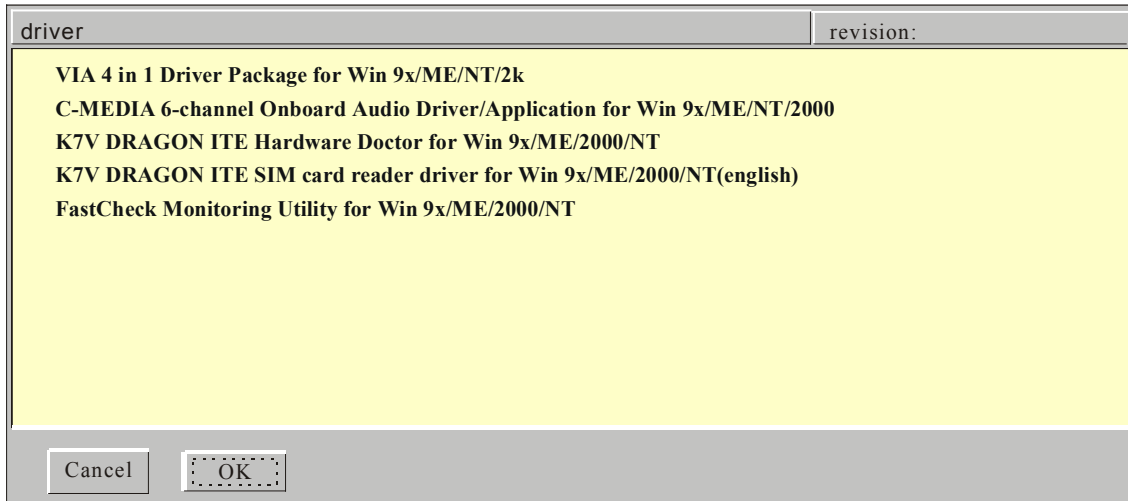

### (Driver Installation Menu)

A short description of all available drivers follows:

#### ➤ **VIA 4in1 Driver Package for Win 9x/ME/NT/2k**

VIA 4 In 1 driver includes four system drivers to improve the performance and maintain the stability of systems using VIA chipsets. These four drivers are :

VIA Registry (INF) Driver, VIA AGP VxD driver, VIA ATAPI Vendor Support Driver and VIA PCI IRQ Miniport Driver. For Windows NT users, the VIA IDE Bus Mastering driver is the only driver to be installed in your system.

A description of 4 drivers follows:

#### — **Bus Master PCI IDE Driver**

The ATAPI IDE driver enables the performance enhancing bus mastering functions on ATA-capable Hard Disk Drives and ensures IDE device compatibility.

**—AGP VxD Driver**

VIA AGP VxD Driver is to be installed if you are using an AGP VGA device. VIAGART.VXD will provide service routines to your VGA driver and interface directly to hardware, providing fast graphical access.

**—VIA Chipset Functions Registry**

VIA Registry (INF) Driver is to be installed under Windows. The driver will enable the VIA Power Management function.

**—IRQ remapping utility (This driver is installed automatically)**

VIA PCI IRQ Miniport Driver is to be installed under Windows 98 only, it sets the system's PCI IRQ routing sequence.

**➤ C-MEDIA 6-channel Onboard Audio Driver/Application for Win 9x/ME/NT/2000**

1. The driver supports 2/4/6 speakers 3D positional audio.
2. The application is include *CD Player/MIDI Player/MP3/Wave Player/Mixer* with the control over your PC's audio functions.

**➤ K7V ITE Hardware Doctor for Win 9x/ME/2000/NT**

Your motherboard comes with a hardware monitoring IC. By installing this utility Temperature, Fan speed and Voltages can be monitored. It is also possible to set alarms when current system values exceed or fall below pre-set values.

**➤ K7V ITE SIM card reader driver for Win 9x/ME/2000/NT (english)**

If you have reader card, it must be installed.

Select which driver you want to install and click **OK**, or click **Cancel** to abort the driver installation and return to the main menu.

**Note :** Once you have selected a driver, the system will automatically exit the SOYO CD to begin the driver installation program. When the installation is complete, most drivers require to restart your system before they can become active.

➤ **FastCheck Monitoring Utility for Win 9x/ME/2000/NT**

The FastCheck Monitoring utility is used to monitor or perform maintenance on a FastCheck Mirrored (RAID 1) or Striped/Mirrored (RAID 0/1)

array. Visual and audible messages are available to warn of possible problems with the disk array or controller.

**Step 3. Check the Latest Releases**

Click the 'Check the latest Releases' button to go the SOYO Website to automatically find the latest BIOS, manual and driver releases for your motherboard. This button will only work if your computer is connected to the internet through a network or modem connection. Make sure to get your modem connection up before clicking this button.

*(\* Internet Explorer is a Microsoft Trademark)*



## Chapter 5

### VIA ONBOARD LAN DRIVER INSTALLATION

#### ***Installing the VIA Onboard LAN Drivers under Windows 98SE***

1. Move the cursor to my computer icon.
2. Click mouse right button then select "properties".
3. Click "Device Manager", then click "other devices".
4. Select "PCI other net controller", then Double click it.
5. You will see the "Driver" item above this window, then click it.
6. Click on "Update Driver".
7. Click on "Next".
8. Select the following directory.
9. The directory is in SOYO CD: \LAN\VIA\W98 then click ok and you will need windows 98 second Edition CD to complete the installation, put it in your CD-ROM.
10. After informing windows of the driver directory the driver will be installed Restart your system after installation.

#### ***Installing the VIA Onboard LAN Drivers under Windows ME (Because Windows ME can detect VIA LAN driver automatic, so this installation is for update LAN driver)***

1. Move the cursor to my computer icon.
2. Click mouse right button then select "properties".
3. Click "Device Manager", then click "Network adapters".
4. Select "VIA LAN driver", then Double click it.
5. You will see the "Driver" item above this window, then click it.
6. Click on "Update Driver".
7. Click on "Next".

8. Select the following directory.
9. The directory is in SOYO CD: \LAN\VIA\WME and click ok.
10. After informing windows of the driver directory the driver will be installed Restart your system after installation.

### ***Installing the VIA Onboard LAN Drivers under Windows NT***

1. Double click the Network icon in the control panel then click "Yes".
2. Click on "Next".
3. Click on "Select from list".
4. Click on "Have Disk".
5. The install Driver dialog box will appear and request the path of the location of the drivers to be installed. Enter D:\LAN\VIA\WNT40 (where D: is your CD-ROM) then press "ok".
6. You will need the windows NT CD to complete the installation.
7. After informing windows NT will display a dialog box asking your to restart your system, click "Yes" right now.

### ***Installing the VIA Onboard LAN Drivers under Windows 2000***

1. Move the cursor to my computer icon.
2. Click mouse right button then select "properties".
3. Select "Hard ware" item, click it.
4. Select "Device Manager", click it.
5. Under other device you will see a yellow Mark, then Double click "Ethernet controller".
6. Click on "Reinstall Driver".
7. Click on "Next".
8. Click on "Next".
9. The LAN driver directory is in SOYO CD: \LAN\VIA\W2000.

---

***Installing the VIA Onboard LAN Drivers under Windows 95OSR2***

1. Move the cursor to my computer icon.
2. Press mouse right button select "properties", then click it.
3. Click "Device Manager".
4. Double click "other devices".
5. Double click "PCI Ethernet Controller".
6. You will see the "Driver" item, click it.
7. Click "Update Driver".
8. Click on "Next".
9. Select "other Locations", click it.
10. Click "Browse"
11. The LAN driver directory is in SOYO CD: \LAN\VIA\W95OSR2 then press "ok".
12. You need windows 95OSR2 CD to complete the installation.
13. When you finish, installing LAN card driver. Restart your system.

## Chapter 6

### **AUDIO DRIVER INSTALLATION**

#### ***Audio Driver Installation for Windows NT***

1. Click my computer.
2. Click control panel.
3. Click multimedia and select devices then press.
4. Click ADD and press OK.
5. The audio driver path is in SOYO CD:  
`\audio\cmi8738_6ch\NT40\drv.`

## Chapter 7

### PROMISE RAID FAMILY DRIVER INSTALLATION



**Note:** When you need to use RAID function on IDE3 and 4, you must connect compatible IDE device with slot IDE3 and 4.

#### ***Promise RAID Family Drivers for Windows 98SE***

1. Move cursor to my computer icon.
2. Press mouse right button then press "properties".
3. Press "Device Manager".
4. You will see an exclamation mark of yellow color at PCI RAID Controller.
5. Click it.
6. Press driver then press update driver.
7. Press next then press next.
8. The RAID driver path is in SOYO CD: \Raid\Promise\Raid Family Driver\Win9x-ME.

#### ***Promise RAID Family Drivers for Windows ME***

1. Move cursor to my computer icon.
2. Press mouse right button then press "properties".
3. Press "Device Manager".
4. You will see an exclamation mark of yellow color at PCI RAID Controller.
5. Click PCI RAID Controller.
6. Press driver then press update driver.
7. The RAID driver path is in SOYO CD: \Raid\Promise\Raid Family Driver\Win9x-ME.



### ***Promise RAID Family Drivers for Windows 2000***

1. First, please copy all files of folder under SOYO CD:  
    \`Raid\promise\Raid Family Driver\Win2000`, and `Fasttrak`, `readme.txt`,  
    and `txtsetup.oem`, 3 files under SOYO CD: \`Raid\promise\Raid`  
    \`Family Driver\` to floppy disk for Win2000 Raid install.
2. When you into the system install screen, press "F6" key first.
3. Then press "S" key.
4. Insert floppy disk for 2000 driver to "A:" disk, then press "Enter" to  
    continue.
5. Select "Win2000 Promise Fasttrak 100 (tm) Lite Controller" then  
    press "Enter".
6. Press "Enter" to continue 2000 setup.

### ***Promise RAID Family Drivers for Windows NT 4.0***

1. First, please copy all files of folder under SOYO CD:  
    \`Raid\promise\Raid Family Driver\NT4`, and `Fasttrak`, `readme.txt`,  
    and `txtsetup.oem`, 3 files under SOYO CD: \`Raid\promise\Raid`  
    \`Family Driver\` to floppy disk for WinNT Raid install.
2. When you into the system install screen, press "F6" key first.
3. Then press "S" key.
4. Select "Other", then press "Enter".
5. Insert floppy disk for NT driver to "A:" disk, then press "Enter".
6. Select "WinNT Promise Fasttrak 100 (tm) Lite Controller" then press  
    "Enter".
7. Press "Enter" to continue NT setup.

## Chapter 8

### ULTRA FAMILY DRIVER INSTALLATION



**Note:** When you need to use regular IDE function on IDE3 and 4, you must connect compatible IDE device with slot IDE3 and 4.

#### **Ultra Family Driver for Windows 98SE**

1. Move cursor to my computer icon.
2. Press mouse right button, then press "properties".
3. Press "Device Manager".
4. You will see an exclamation mark of yellow color at PCI mass storage controller in other devices.
5. Click it.
6. Click "Driver" button, then click "Update Driver" button.
7. Press next, then press next.
8. The ultra family driver path is in SOYO CD: \Raid\Promise\  
ultra family Driver\Win95-98.
9. Click OK, then restart your system.

#### **Ultra Family Driver for Windows NT4.0**

1. First, please copy all files of folder under SOYO CD:  
\Raid\promise\Ultra Family Driver\NT4, and Ultra, readme.txt, and  
txtsetup.oem, 3 files under SOYO CD: \Raid\promise\Ultra Family  
Driver\ to floppy disk for WinNT Ultra100 install.
2. When you into the system install screen, press "F6" key first.
3. Then press "S" key.
4. Select "Other", then press "Enter".
5. Insert floppy disk for NT driver to "A:" disk, then press "Enter".
6. Select "WinNT Promise Ultra100 (tm) Controller(PDC20265R)",  
then press "Enter".
7. Press "Enter" to continue NT setup.

### **Ultra Family Driver for Windows ME**

1. Move cursor to my computer icon.
2. Press mouse right button, then press "properties".
3. Press "Device Manager".
4. You will see an exclamation mark of yellow color at PCI mass storage controller in other devices.
5. Click it.
6. Click "Driver" button, then click "Update Driver" button.
7. Select specify the location of the driver [Advanced], then click next..
8. The ultra family driver path is in SOYO CD: \Raid\Promise\  
ultra family Driver\WINME.
9. Click finish, then restart your system.

### **Ultra Family Driver for Windows 2000**

1. First, please copy all files of folder under SOYO CD:  
\Raid\promise\Ultra Family Driver\Win2000, and Ultra, readme.txt,  
and txtsetup.oem, 3 files under SOYO CD: \Raid\promise\Ultra  
Family Driver\ to floppy disk for Win2000 Ultra100 install.
2. When you into the system install screen, press "F6" key first.
3. Then press "S" key.
4. Insert floppy disk for 2000 driver to "A:" disk, then press "Enter" to  
continue.
5. Select "Win2000 Promise Ultra100 (tm) Controller(PDC20265R)",  
then press "Enter".
6. Press "Enter" to continue 2000 setup.





# ***APPENDIX A***

# ***FASTTRAK100***

## Introduction

### WHAT IS THE FASTTRAK100-LITE RAID CONTROLLER?

*FastTrak100-Lite provides a cost-effective, high performance onboard RAID solution that adds performance and/or reliability to PC desktops and/or servers using Ultra ATA/100, Ultra ATA/66, or EIDE drives.*

*FastTrak100-Lite supports striping (RAID 0) or mirroring (RAID 1) for master only.*

*With striping, identical drives can read and write data in parallel to increase performance. Mirroring increases read performance through load balancing and elevator sorting while creating a complete backup of your files.*

*A FastTrak100-Lite striped array can double the sustained data transfer rate of Ultra ATA/100 drives. FastTrak100-Lite fully supports Ultra ATA/100 specification of up to 100 MB/sec per drive, depending on individual drive specifications.*

*FastTrak100-Lite also offers fault tolerant, data redundancy for entry-level network file servers or simply for desktop PC users wanting to continually protect valuable data on their PC. FastTrak100-Lite offers RAID 1 mirroring (for two drives) to protect data. Should a drive that is part of a mirrored array fail, FastTrak100-Lite uses the mirrored drive (which contains identical data) to assume all data handling. When a new replacement drive is later installed, FastTrak100-Lite rebuilds data to the new drive from the mirrored drive to restore fault tolerance.*

FastTrak100-Lite's bootable BIOS supports individual drives larger than 8.4GB. With FAT32 and NTFS partitioning, the array can be addressed as one large single volume.

## KEYS FEATURES AND BENEFITS

The following information offers an overview of the major features of FastTrak100-Lite. It is divided into two areas: Advanced Hardware Design, and Compatibility.

<b>Advanced Hardware Design</b>	
<b>Features</b>	<b>Benefits</b>
Supports data striping (RAID 0) or mirroring (RAID 1)	Provides dramatic increase in drive performance and/or fault tolerant options. Offers performance customization and data rebuilds from the BIOS menu.
Supports Ultra DMA 5/4/3/2/1/0, DMA 2/1/0	Burst data transfer rates up to 100MB/sec from Ultra ATA/100 drives to boost overall system performance.
PCI Plug-n-Play, PCI Interrupt sharing and <i>coexists</i> with motherboard IDE controllers	Easy to install; support four ATA drives on the FastTrak100-Lite while still supporting 4 devices on motherboard ATA controller.
Supports concurrent dual IDE controller operation	Drive workload is distributed in parallel between members of the array.
Supports IDE bus master operation	Allows multitasking during disk transfers which increase CPU efficiency. The CPU is free to process tasks during IDE data transfers through the PCI Bus to/from system memory.
Utilizes FastBuild™ auto-menu from the FastTrak100-Lite BIOS	Offers pre-set application specific settings which can be optimized for Desktop, Server, or A/V Editing. Has "Auto Setup" option for quick and easy array builds.
Displays status and error checking messages during boot-up	Notifies user of possible errors and allows for recovery of mirrored drive arrays directly from FastBuild™.
Mirroring supports automatic background rebuilds	Fault tolerance can be restored automatically without rebooting

<b>Compatibility</b>	
<b>Features</b>	<b>Benefits</b>
Complies with PCI v2.1 Local Bus standard	Provides highest level of hardware compatibility.
Compliant with PCI IDE Bus Master standard. PCI IDE Bus Master support for Windows 98/95, Windows NT 3.5x, 4.0	Provides 32-bit I/O, IDE Bus Master, and Ultra ATA performance for optimal system performance.
Compatible with Ultra ATA/100, Ultra ATA/66, Ultra ATA/33, EIDE	Works with newest and current IDE drive specifications.
Features LBA and Extended Interrupt13 drive translation in controller onboard BIOS	Breaks capacity barriers for support of drives greater than 8.4GB in capacity. Offers flexible storage options for space demanding applications.

## Getting Started

*This section is designed to get you started for installation of your FastTrak100-Lite.*



**WARNING:** Before installing the driver into an existing system, backup any necessary data. Failure to follow this accepted PC practice could result in data loss.

### INSTALLING THE HARD DRIVES



**WARNING:** If you wish to include your current bootable drive using the Windows NT 4.x or Windows 2000 operating system as part of a bootable Mirrored (RAID 1) array on your FastTrak100-Lite, do NOT connect the hard drive to the FastTrak100-Lite controller yet. You MUST install the Windows NT4 or 2000 driver software first to this drive while it is still attached to your regular IDE port.

Hard drives must be Ultra ATA/100, Ultra ATA/66, Ultra ATA/33, EIDE and/or Fast ATA-2 compatible to operate with FastTrak100-Lite RAID. For optimal performance, install all **identical** drives of the same model and capacity. The drives' **matched performance** allows the array to function better as a single drive.

1. *Promise recommends using identical drive as part of a FastTrak100-Lite array. If striping for performance, use two new drives. If mirroring for protection, you can use two new drives OR use an existing drive and a new drive (the new drive must be the same size or larger than the existing drive).*

2. Configure the jumpers of the hard drive you're preparing to connect to the FastTrak100-Lite using the correct "Master / Slave" or "Cable-Select" settings in the positions described in the table below.

**NOTE:** Sometimes the Master drive with no slave attached is called "Single." The master slave setting differentiates two drives chained on the same connector.

<i>Jumper Settings</i>		
<i># of Drives</i>	<i>IDE Channel 1</i>	<i>IDE Channel 2</i>
<i>1</i>	<i>M</i>	<i>----</i>
<i>2</i>	<i>M</i>	<i>M</i>
<i>3</i>	<i>M &amp; S</i>	<i>M</i>
<i>4</i>	<i>M &amp; S</i>	<i>M &amp; S</i>

*M = Master, S = Slave*

3. Install the hard drives into the hard drive bays of your system, including the power cables.
4. Attach one Ultra ATA cable to each hard drive. Then attach one cable to the IDE port on the FastTrak100-Lite. The colored edge of the cable(s) indicates pin 1, and the blue cable connector must be attached to the FastTrak100-Lite IDE port.



**NOTE:** You must use an 80-wire, 40-pin cable when connecting an Ultra ATA/100 hard drive to the FastTrak100-Lite IDE port.

## Checking CMOS Settings

For the FastTrak100-Lite to be the bootable IDE controller, confirm in the Standard CMOS Setup that the First Boot Device is set for "SCSI".

## CREATING YOUR DISK ARRAY

*You will now use the FastBuild BIOS utility to create your array using the attached drives. There are three different scenarios in creating this array. You can create an array for performance, you can create a Security array using new hard drives*

(recommended), or you can create a Security array using an existing hard drive and a new hard drive.



**WARNING:** If creating a Security array using an existing hard drive, backup any necessary data. Failure to follow this accepted PC practice could result in data loss.

1. *Boot your system. If this is the first time you have booted with the FastTrak100-Lite and drives installed, the Promise onboard BIOS will display the following screen.*

FastTrak100-Lite (tm) BIOS Version 1.xx (Build xxxx)  
(c) 1995-2000 Promise Technology, Inc. All Rights Reserved.

No array defined . . .

Press <Ctrl-F> to enter FastBuild (tm) Utility  
Or press <ESC> key to continue booting the system.

2. *Press <Ctrl-F> keys to display the FastBuild (tm) Utility Main Menu*
3. *Press "1" to display the Auto Setup Menu below. This is the fastest and easiest method to creating your first array.*

*FastBuild (tm) Utility 1.xx (c) 1995-2000 Promise Technology, Inc.*

*[Auto Setup Options Menu]*

Optimize Array for:                      Performance  
Typical Application usage:              A/V Editing

[ Auto Setup Configuration ]

Mode .....Stripe  
Drives used in Array .....2  
Array Disk Capacity..... 16126

[ Keys Available ]

[↑] Up [↓] Down    [←, →, Space] Change Option    [ESC] Exit    [Ctrl-Y] Save

## Creating an Array for Performance

**NOTE:** *FastTrak100-Lite* allows users to create striped arrays with 1, 2 drives.

To create an array for best performance, follow these steps:

1. Using the Spacebar, choose “Performance” under the **Optimize Array for** section.
2. Select how you will use your PC most under the **Typical Application usage** section. The choices are A/V Editing, Server, and Desktop (the default).
3. Press <Ctrl-Y> keys to Save and create the array.
4. Reboot your system.
5. Once the array has been created, you will need to FDISK and format the array as if it were a new single hard drive.
6. Proceed to install the FastTrak RAID Drivers from the SOYO CD.

## Creating a Security Array With New Drives

**NOTE:** *FastTrak100-Lite* permit only two drives to be used for a single Mirrored array in Auto Setup.

To create an array for data protection using new hard drives, follow these steps:

1. Using the Spacebar, choose “Security” under the **Optimize Array for** section.
2. Press <Ctrl-Y> keys to Save your selection.
3. The window below will appear.

Do you want the disk image to be duplicated to another? (Yes/No) Y - Create and Duplicate N - Create Only
---

4. Press “N” for the Create Only option.
5. A window will appear almost immediately confirming that your Security array has been created. Press any key to reboot the system

Array has been created. <Press Any Key to Reboot>
--

6. Proceed with normal FDISK and format procedures as if you had just installed a new hard drive.
7. Once the arrayed drives have been formatted, proceed to install your OS & then the FastTrak RAID Drivers from the SOYO CD.

## Creating a Security Array With An Existing Data Drive

**NOTE:** FastTrak100-Lite permits only two drives to be used for a single Mirrored array in Auto Setup.

*You would use this method if you wish to use a drive that already contains data and/or is the bootable system drive in your system. You will need another drive of identical or larger storage capacity.*



**WARNING:** Backup any necessary data before proceeding. Failure to follow this accepted PC practice could result in data loss.



**WARNING:** If you wish to include your current bootable drive using the Windows NT 4.x or Windows 2000 operating system as part of a bootable Mirrored (RAID 1) array on your FastTrak100-Lite, do NOT connect the hard drive to the FastTrak100-Lite controller yet. You MUST install the Windows NT4 or 2000 driver first to this drive while it is still attached to the regular IDE port. For all other Operating Systems, proceed here.

*Follow these steps:*

1. *Using the Spacebar, choose “Security” under the **Optimize Array for** section.*
2. *Press <Ctrl-Y> keys to Save your selection. The window below will appear.*

Do you want the disk image to be duplicated to another? (Yes/No) Y - Create and Duplicate N - Create Only
---

3. *Press “Y” for the Create and Duplicate option. The window below will appear asking you to select the Source drive to use. FastBuild will copy all data from the Source drive to the Target drive.*



Source Disk		
Channel:ID (MB)	Drive Model	Capacity
Target Disk		
Channel:ID Capacity (MB)	Drive Model	
[Please Select A Source Disk]		
Channel:ID (MB)	Drive Model	Capacity
1 :Master	QUANTUMCR8.4A	8063
2 :Master	QUANTUMCR8.4A	8063
[↑] Up [↓] [ESC] Exit [Ctrl-Y] Save		

- Use the arrow keys to choose which drive contains the existing data to be copied.
- Press [Ctrl-Y] keys to Save selection and start duplication. The following progress screen will appear.

```

Start to duplicate the image . . .
Do you want to continue? (Yes/No)
Y – Continue  N – Abort

```

- Select “Y” to continue. If you choose “N” , you will be returned to step 1.
- Once complete, the following screen will appear confirming that your Security array has been created. Press any key to reboot the system

```

Array has been created.
<Press Any Key to Reboot>

```

- Proceed to install your OS & the FastTrak RAID drivers from the SOYO CD.

# Using FastBuild™ Configuration Utility

The FastBuild™ Configuration Utility offers several menu choices to create and manage the drive array on the FastTrak100-Lite. For purposes of this manual, it is assumed you have already created an array in the previous chapter and now wish to make a change to the array or view other options.

## VIEWING FASTTRAK100-LITE BIOS SCREEN

*When you boot your system using the FastTrak100-Lite on-board RAID with drives installed, the FastTrak BIOS will detect the drives attached and show the following screen.*

```
FastTrak100-Lite (tm) BIOS Version 1.xx (Build xx)
(c) 1995-2000 Promise Technology, Inc. All Rights Reserved.

Scanning IDE drives . . . . .
```

*If an array exists already, the BIOS will display the following screen showing the card's BIOS version and status of the array.*

```
FastTrak100-Lite (tm) BIOS Version 1.xx (Build xxxx)
(c) 1995-2000 Promise Technology, Inc. All Rights Reserved.

ID           MODE   SIZE   TRACK-MAPPING   STATUS
1 *         2+0 Stripe 16126M       611/128/32     Functional

Press <Ctrl-F> to enter FastBuild (tm) Utility....
```

*The array status consists of three possible conditions: Functional, Critical, Offline.*

**Functional** - *The array is operational.*

**Critical** - A mirrored array contains a drive that has failed or disconnected. The remaining drive member in the array is functional. However, the array has temporarily lost its ability to provide fault tolerance. The user should identify the failed drive through the FastBuild™ Setup utility, and then replace the problem drive.

**Offline** - A striped array has 1 drive that has failed or been disconnected. When the array condition is “offline,” the user must replace the failed drive(s), then restore data from a backup source.

## NAVIGATING THE FASTBUILD™ SETUP MENU

When using the menus, these are some of the basic navigation tips: Arrow keys highlights through choices; [Space] bar key allows to cycle through options; [Enter] key selects an option; [ESC] key is used to abort or exit the current menu.

### Using the Main Menu

This is the first option screen when entering the FastBuild™ Setup.

*FastBuild (tm) Utility 1.xx (c) 1995-2000 Promise Technology, Inc.*

*[ Main Menu ]*

*Auto Setup ..... [ 1 ]*

*View Drive Assignments..... [ 2 ]*

*View Array..... [ 3 ]*

*Delete Array..... [ 4 ]*

*Rebuild Array..... [ 5 ]*

*Controller Configuration..... [ 6 ]*

*[ Keys Available ]*

Press 1...6 to Select Option    [ESC] Exit

To create a new array automatically, follow the steps under “Creating Arrays Automatically”. SOYO recommends this option for most users.

To view drives assigned to arrays, see “Viewing Drive Assignments”.

To delete an array (but not delete the data contained on the array), see “Deleting An Array”.

To rebuild a mirrored array, see “Rebuilding an Array”.

To view controller settings, see “Viewing Controller Configuration”.



**NOTE:** After configuring an array using FastBuild, you should FDISK and format the arrayed drive(s) if you are using new, blank drives. Depending on the type of array you are using.

## CREATING ARRAYS AUTOMATICALLY

The Auto Setup <1> selection from the Main Menu can intuitively help create your disk array. It will assign all available drives appropriate for the disk array you are creating. After making all selections, use Ctrl-Y to Save selections. FastBuild will automatically build the array.

*FastBuild (tm) Utility 1.xx (c) 1995-2000 Promise Technology, Inc.*

*[Auto Setup Options Menu]*

Optimize Array for:                   Performance  
Typical Application usage:           A/V Editing

[ Auto Setup Configuration ]

Mode .....Stripe  
Spare Drive Count..... 1  
Drives used in Array.....2  
Array Disk Capacity..... 16126

[ Keys Available ]

[↑] Up [↓] Down    [←, →, Space] Change Option    [ESC] Exit    [Ctrl-Y] Save

## Optimize Array For

Select whether you want Performance (RAID 0), Security (RAID 1) under the “Optimize Array for” setting.

### Performance (RAID 0 Striping)

*Supports the maximum performance. The storage capacity equals the number of drives times the capacity of the smallest drive in the disk array.*

**NOTE:** FastTrak100-Lite permits striped arrays using 1, 2 drive attached in Auto Setup mode.

### Security (RAID 1 Mirroring)

*Creates a mirrored (or fault tolerant) array for data security.*

**NOTE:** Under the Security setting, FastTrak100-Lite permits two drives to be used for a single Mirrored array only.

## Defining Typical Application Usage

*Allows the user to choose the type of PC usage that will be performed in order to optimize how FastTrak100-Lite handles data blocks to enhance performance. Your choice will determine the block size used. You may choose from: A/V Editing (for audio/video applications, or any similar application that requires large file transfers), Server (for numerous small file transfers), or Desktop (a combination of large and small file sizes).*

**NOTE:** *If you wish to customize the settings of individual disk arrays (such as block size), you must manually create disk arrays with the Define Array <3> option from the Main Menu.*

## VIEWING DRIVE ASSIGNMENTS

The View Drive Assignments <2> option in the Main Menu displays whether drives are assigned to a disk arrays or are unassigned.

Under the “Assignment” column, drives are labeled with their assigned disk array or shown as “Free” if unassigned. Such “Free” drives can be used for a future array or used as a spare drive when a drive fails in a mirrored array. Unassigned drives are not accessible by the OS. The menu also displays the data transfer mode that relates to speed used by each drive (U5 refers to 100MB/sec transfers, U4 refers to 66MB/sec transfers, etc...)

*FastBuild (tm) Utility 1.xx (c) 1995-2000 Promise Technology, Inc.*  
[ View Drive Assignments ]

Channel:ID	Drive Model	Capacity(MB)	Assignment	Mode	
1 : Master	QUANTUMCR8.4A	8063	Array 1	U5	
1 : Slave	QUANTUMCR8.4A	8063	Free		U5
2 : Master	QUANTUMCR8.4A	8063	Array 1	U5	

[ Keys Available ]

[↑] Up [↓] Down [ESC] Exit Mode (U=UDMA, P=PIO, D=DMA)

### MANUALLY CREATING AN ARRAY

The Define Array <3> option from the Main Menu allows users to begin the process of manually defining the drive elements and RAID levels for one or multiple disk arrays attached to FastTrak100-Lite. Users will commonly create one or two drive arrays with FastTrak100-Lite, though this can support a maximum of four arrays<sup>1</sup>.

**NOTE:** For most installations, Promise recommends the <1> Auto Setup for easy disk array creation.

---

<sup>1</sup> A user may use a single drive in either striping or spanning mode with FastTrak100. In this rare scenario, the card will create an individual array ID but will offer conventional controller performance, depending on the drive type. At a later time, a second drive can be added to the array and the array re-created to support RAID 1 mirroring.

*FastBuild (tm) Utility 1.xx (c) 1995-2000 Promise Technology, Inc.*  
[Define Array Menu]

<b>Array No</b>	<b>RAID Mode</b>	<b>Total Drv</b>	<b>Capacity(MB)</b>
<b>Status</b>			
Array 1	Stripe	2	16126
Functional			
Array 2	—	—	—
Array 3	—	—	—
Array 4	—	—	—

[ Keys Available ]

Note: \* — Bootable Array

[↑] Up [↓] Down [ESC] Exit [Enter] Select [Space] Change Boot Drive

1. To manually create an array from the Define Array Menu, use the arrow keys to highlight the array number you wish to define, and press [Enter] to select.
2. The Define Array Menu will next appear that allows drive assignments to the disk array (see next page).

### Selecting Array Type

1. Under the Definition section of this menu, highlight the Array # for which you want to assign a RAID level.
2. Use the [Space] key to cycle through three array types: Performance (RAID 0 Striping), Security (RAID 1 Mirroring).

*FastBuild (tm) Utility 1.xx (c) 1995-2000 Promise Technology, Inc.*  
[ Define Array Definition Menu ]

<b>Array No</b>	<b>RAID Mode</b>	<b>Total Drv</b>	<b>Capacity(MB)</b>
<b>Status</b> Array 1 Functional	Stripe	2	16126

Stripe Block: 64 KB

[ Drive Assignments ]

<b>Channel:ID</b>	<b>Drive Model</b>	<b>Capacity (MB)</b>
<b>Assignment</b> 1 : Master	QUANTUMCR8.4A	8063
1 : Slave	QUANTUMCR8.4A	8063
2 : Master	QUANTUMCR8.4A	8063

[ Keys Available ]

[↑] Up [↓] Down [ESC] Exit [Space] Select [Ctrl-Y] Save

### Selecting Stripe Block

For RAID 0 Striped arrays only, you may manually select the “stripe block size.” Use the Spacebar to scroll through choices progressing as follows (1, 2, 4, 8 , 16 . . . 1024).

The size selected affects how FastTrak100-Lite sends and retrieves data blocks from the drives. You will need to perform your own testing to determine how the data block size is affecting your particular use of the array. In general, a larger block size is better when handling large data transfers (such as in A/V editing or graphics) while a smaller block size is better when handling e-mail and other common server data. The default is 64K.

### Assigning Drive(s) to Array

1. Under the [ Drive Assignments ] section, highlight a drive using the [↑] Up [↓] keys.



2. *With the [Space] bar key, change the Assignable option to “Y” to add the drive to the disk array.*
3. *Press <Ctrl-Y> to save the disk array information. Depending on the array type selected, the following scenarios will take place:*
  - a) If choosing a Striping, array, the initial Define Array Menu screen will appear with the arrays defined. From there you may ESC to exit and return to the Main Menu of FastBuild.
  - b) If you selected a Mirroring array for two drives, there is an additional window that appears as described in order to create the array. To do this you will use either two brand new drives, or one drive that contains existing data that you wish to mirror.

## **Creating A Mirrored Array Using New Drives**

As described in the Drive Assignments Option section above, if you selected a mirroring array and wish to use two new assigned drives, follow the directions here.

1. After assigning new drives to a Mirroring array and saving the information with <Ctrl-Y>, the window below will appear.

Do you want the disk image to be duplicated to another? (Yes/No) Y - Create and Duplicate N - Create Only
---

2. Press “N” for the Create Only option.
3. A window will appear almost immediately confirming that your Security array has been created. Press any key to reboot the system

Array has been created. <Press Any Key to Reboot>
--

## Adding Fault Tolerance to an Existing Drive

FastTrak100-Lite will create a mirrored array using an existing system drive with data. You must assign the existing drive and another drive of same or larger capacity to the Mirroring array. The BIOS will send the existing data to the new blank drive.



**WARNING:** Backup any necessary data before proceeding. Failure to follow this accepted PC practice could result in data loss.



**WARNING:** If you wish to include your current bootable drive using the Windows NT 4.x or Windows 2000 operating system as part of a bootable Mirrored (RAID 1) array on your FastTrak100-Lite, do NOT connect the hard drive to the FastTrak100-Lite controller yet. You MUST install the Windows NT4 or 2000 driver software first (see page 133) to this drive while it is still attached to the regular IDE port. For all other Operating Systems, proceed here.

1. *After assigning the drives to a Mirroring array, press <Ctrl-Y> keys to Save your selection. The window below will appear.*

Do you want the disk image to be duplicated to another? (Yes/No) Y - Create and Duplicate N - Create Only
---

2. *Press "Y" for the Create and Duplicate option. The window below will appear asking you to select the Source drive to use. FastBuild will copy all data from the Source drive to the Target drive.*



## Making a FastTrak100-Lite Disk Array Bootable



**WARNING:** In order for you to boot from an array on the FastTrak100-Lite, your PC or server must be configured in the CMOS Setup to use the FastTrak100-Lite as a bootable device (versus the onboard controller or another add-in card).

1. Once you have returned to the Define Array Menu window, you will see the array(s) you have created. You now may use the menu to select which previously-defined array will be used as the bootable array.

```
FastBuild (tm) Utility 1.xx DELL (c) 1995-2000 Promise Technology, Inc.
[ Define Array Menu ]

  Array No      RAID Mode    Total Drv  Capacity(MB)
  Status
*  Array 1      Stripe        2          13044
Functional

Note: * — Bootable Array

[↑] Up [↓] Down  [ESC] Exit  [Enter] Select  [Space] Change Boot Drive
```

2. Highlight the array which you want to boot from using the [↑] Up [↓] Down keys.
3. Press the [Space] bar key.
4. An \* asterisk will appear next to the array number indicating it as bootable. The system will now recognize this array as the first array seen
5. The system will then use this bootable array as the (fixed) boot C: drive.

**NOTE:** The bootable array must contain your configured operating system.

### DELETING AN ARRAY

The Delete Array <4> Menu option allows for deletion of disk array assignments. This is not the same as deleting data from the drives themselves. If you delete an array by accident (and before it has been used again), the array can normally be recovered by defining the array identically as the deleted array.



**WARNING:** Deleting an existing disk array could result in its data loss. Make sure to record all array information including the array type, the disk members, and stripe block size in case you wish to undo a deletion.

*FastBuild (tm) Utility 1.xx (c) 1995-2000 Promise Technology, Inc.*  
[ Delete Array Menu ]

Array No	RAID Mode	Total Drv	Capacity(MB)
Array 1 Status Functional	Stripe		16126
Array 2	—	—	—
Array 3	—	—	—
Array 4	—	—	—

[ Keys Available ]

[↑] Up [↓] Down      [ESC] Exit      [Del] Delete

1. To delete an array, highlight the Array you wish to delete and press the [Del] key.
2. The View Array Definition menu will appear (see below) showing which drives are assigned to this array.

*FastBuild (tm) Utility 1.xx (c) 1995-2000 Promise Technology, Inc.*  
[ Define Array Menu ]

Array No	RAID Mode	Total Drv	Capacity(MB)
Array 1	_____	_____	_____
Stripe Block: 64 KB			
[ Drive Assignments ]			
Channel:ID	Drive Model		Capacity (MB)
<b>Assignment</b>			
1 : Master	QUANTUMCR8.4A	8063	Y
2 : Master	QUANTUMCR8.4A	8063	Y

3. Confirm yes to the following warning message with the <Ctrl-Y> key to continue array deletion:

Are you sure you want to delete this array?  
Press Ctrl-Y to Delete, others to Abort

4. After deleting the array, you should create a new array using Auto Setup or the Define Array menu from the FastBuild Main Menu.

## REBUILDING A MIRRORED ARRAY

The Rebuild Array <5> Menu option is necessary to recover from an error in a mirrored disk array. You will receive an error message when booting your system from the FastTrak BIOS.

**NOTE:** Drives MUST be replaced if they contain any physical errors.

Follow these steps *BEFORE* using the Rebuild Array menu option:

1. On bootup, the FastTrak100-Lite Startup BIOS will display an error message identifying which drive has failed.
2. Press <Ctrl-F> keys to enter FastBuild Main Menu.
3. Select submenu Define Array <3>.
4. Select the failed array and identify the Channel and ID of the failed drive.
5. Power off and physically remove the failed drive.
6. Replace the drive with an identical model.
7. Reboot the system and enter the FastBuild Main Menu.
8. Select the <5> Rebuild Array option. The following screen will appear.

<i>FastBuild (tm) Utility 1.xx (c) 1995-2000 Promise Technology, Inc.</i>				
[ Rebuild Array Menu ]				
Array No	RAID Mode	Total Drv	Capacity(MB)	Status
Array 1	Mirror		2	16126
Critical				
Array 2	—	—		
	—		—	
Array 3	—	—		
	—		—	
Array 4	—	—		
	—		—	
[ Keys Available ]				
[↑] Up [↓] Down [ESC] Exit [Enter] Select				

9. Highlight the array whose Status is “Critical”.
10. Press [Enter]. The following screen will then appear.

*FastBuild (tm) Utility 1.xx (c) 1995-2000 Promise Technology, Inc.*

[ Rebuild Array Menu ]

<b>Array No</b>	<b>RAID Mode</b>	<b>Total Drv</b>	<b>Status</b>
Array 2	Mirror	2	Critical

Stripe Block: Not Available

[ Select Drive for Rebuild ]

<b>Channel:ID</b>	<b>Drive Model</b>	<b>Capacity (MB)</b>
1 : Slave	QUANTUMCR8.4A	8063

[ Keys Available ]

[↑] Up [↓] Down [ESC] Exit [Enter] Select

11. Under [Select Drive for Rebuild], highlight the replacement drive.
12. Press [Enter] and confirm that the data will be copied on to the selected drive. All data on the replacement drive will be written over with mirrored information from the array drive. A progress bar will appear as below.

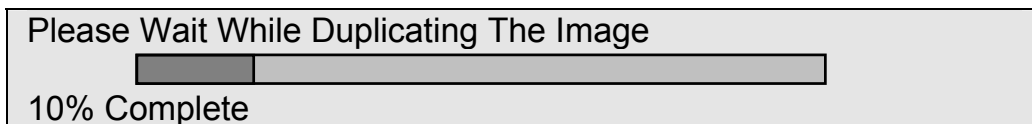

13. Once the rebuild process is complete, the user will be asked to reboot the system.

## VIEWING CONTROLLER SETTINGS

The Controller Configuration <6> menu selection allows you to enable or disable the FastTrak100-Lite BIOS from halting (the default) if it detects an error on boot up. You may also view the system resources (Interrupt and I/O port address) of FastTrak's data channels.



*FastBuild (tm) Utility 1.xx (c) 1995-2000 Promise Technology, Inc.*

[ Adapter Configuration - Options ]

Halt On Error:    Enable

[ System Resources Configuration ]

Channel 1 (IDE1)                    Interrupt : A/I/O    Port : FFF0

Channel 2 (IDE2)                    Interrupt : A/I/O Port    : FFA8

[ Keys Available ]

[←, →, Space] Change Option    [ESC] Exit

### ***Halting FastTrak BIOS On Bootup Errors***

*The [Adapter Configuration – Options] section allows you to enable or disable FastTrak100-Lite to Halt operation at the BIOS startup screen should an error be detected. This is the only option that can be changed on this screen.*

## **Installing Drivers**

This section details the FastTrak100-Lite driver installation when used with various operating systems. The software includes the driver necessary to identify FastTrak100-Lite to the operating system.

- For Windows 2000, see below.
- For Windows 95/98, see page 136.
- For Windows 4.x, see page 139

### **WINDOWS 2000**

#### **Installing Driver During New Windows 2000 Installation**

- 1a. Floppy Install: Boot the computer with the Windows 2000 installation diskettes.
- 1b. Floppyless Install: Boot from floppy and type “WINNT”. After files have been copied, the system will reboot. On the reboot, press <F6> after

the message “Setup is inspecting your computer’s hardware configuration...” appears.

- 1c. CD-ROM Install: Boot from the CD-ROM. Press <F6> after the message “Press F6 if you need to install third party SCSI or RAID driver” appears.
2. When the “Windows 2000 Setup” window is generated, press “S” to Specify an Additional Device(s)
3. Press “O” to select “Other” and press the “Enter” key.
4. Insert the diskette\* into drive A: and press “Enter” key.
5. Choose “Win2000 FastTrak100-Lite” from the list that appears on screen, then press the “Enter” key.
6. The Windows 2000 Setup screen will appear again saying “Setup will load support for the following mass storage devices:” The list will include “Promise FastTrak100-Lite”..

*NOTE: If you need to specify any additional devices to be installed, do so at this time. Once all devices are specified, continue to step 7.*

7. From the Windows 2000 Setup screen, press the Enter key. Setup will now load all device files and then continue the Windows 2000 installation.

\* Copy the FastTrak Win2000 drivers from the SOYO CD to a floppy disk.

## Installing Driver in Existing Windows 2000 System



**WARNING:** If you will be moving the boot drive containing the existing Windows 2000 operating system to a mirrored RAID 1 array on the FastTrak100-Lite, the FastTrak100-Lite driver **MUST** be loaded to the hard drive while it is still attached to the regular IDE port. Do not attach this drive or any other hard drive to the FastTrak100-Lite controller card before completing this step.

*During first boot in Window 2000, setup will show a “New Hardware Found” dialog box. Under Windows 2000, the “PCI Mass Storage Controller” will be displayed.*

1. In the dialog box, choose “Driver from disk provided by hardware manufacturer” button.
2. In the CD-Rom drive, insert the SOYO CD Driver.
3. Type “D:\RAID\promise\Driver\Win2000” in the text box. Press “Enter”.  
Assuming the D: is your CD-Rom.
4. Choose “Win2000 FastTrak100-Lite Controller” from the list that appears on screen, then press the “Enter” key.
5. The Windows 2000 Setup screen will appear again saying “Setup will load support for the following mass storage devices – Win2000 Promise FastTrak100-Lite controller”. The FastTrak100-Lite driver will now be copied on to the system and entered into the Windows 2000 driver database.
6. When the "System Settings Change" dialog box appears, remove the floppy diskette and click on “Yes” to restart the system. Windows 2000 will then restart for the driver installation to take effect.

## Windows 95/98

### Installing Drivers During Windows 95/98 Installation

The following three sections detail the installation of the FastTrak100-Lite drivers while installing Windows 95/98. If you're installing the FastTrak100-Lite drivers on a system with Windows 95/98 already installed, see "Installing Drivers with Existing Windows 95/98" on page 138.

#### Windows 98

1. After making an array & configuring the hard drive(s), partition and format your hard drive(s), if necessary.
2. Install Windows 98 normally.
3. After installation, go the "Start" menu and choose "Settings."
4. From the "Settings" menu, choose "Control Panel."
5. In the "Control Panel" window, double-click on the "System" icon.
6. In the "System" window, choose the "Device Manager" tab.
7. In the hierarchical display under "Other Devices" is a listing for "PCI RAID Controller." Choose it and then press the "Properties" button.
8. Choose the "Driver" tab in the "Properties" window, choose "Update Driver," and then press "Next."
9. Choose "Search for a better driver than the one your device is using now (recommended)," then press "Next."
10. Insert the "SOYO CD" into the CD-Rom drive, then press "Next."
11. Choose "Specify Location," and then type "D:\RAID\promise\Driver\Win9x-ME" in the text box. Assuming D: is your CD-Rom.
12. Press the "Next" button. A message informing you that Windows 98 has found "Win95-98 FastTrak100-Lite (tm) Controller" should appear.
13. Press "Next," then "Finish," then "Yes" when asked if you want to restart your computer.

## Windows 95

1. After making an array & configuring the hard drives, partition and format your hard drive(s), if necessary.
2. Install Windows 95 normally.
3. After installation, go to the “Start” menu and choose “Settings.”
4. From the “Settings” menu, choose “Control Panel.”
5. In the “Control Panel” window, double-click on the “System” icon.
6. In the “System” window, choose the “Device Manager” tab.
7. In the hierarchical display under “Other Devices” is a listing for “PCI Mass Storage Controller.” Choose it and then press the “Properties” button.
8. Choose the “Driver” tab in the “Properties” window, and then press the “Update Driver” button.
9. When asked if you want Windows to search for the driver, choose “Yes (recommended).”
10. Insert the “SOYO CD” into the CD-Rom drive, then press “Next.”
11. When Windows informs you that it was unable to find the drivers, press “Other Locations...”
12. In the “Select Other Location” dialog box, type “D:\RAID\promise\Driver\Win9x-ME”. Assuming D: is your CD-Rom drive.
13. Press the “Next” button. A message informing you that Windows 95 has found “Win95-98 FastTrak100-Lite (tm) Controller” should appear then press “Finish”
14. Choose “Yes” when asked if you wish to restart the system.

## **Installing Drivers with Existing Windows 95/98**

The following three sections detail the installation of FastTrak100-Lite drivers on a system that has Windows 95/98 already installed. If you're installing the FastTrak100-Lite drivers on a system during a Windows 95/98 installation, see "Installing Drivers During Windows 95/98 Installation" on page 136.

### **Windows 98**

1. The "Add New Hardware Wizard" will appear, informing you that it has found a "PCI RAID Controller."
2. Check the "Search for the best driver for your device" box and click the Next button.
3. Check the "Specify a Location" box and click Next button.
4. Type "D:\RAID\promise\Driver\Win9x-ME" in the text box. Assuming that D: is your CD-Rom.
5. Insert the "SOYO CD" in the CD-Rom drive.
6. Click on "Next." The Add New Hardware wizard will say it has found "Win95-98 FastTrak100-Lite controller".
7. Click on "Next," and then on "Finish."
8. Choose "Yes" when asked if you want to restart your computer.

### **Windows 95**

1. After making an array and configuring the hard drives, power up the system and boot Windows.
2. The "Update Device Drive Wizard" will appear, informing you that it has found a "PCI Mass Storage Controller."
3. Insert the "SOYO CD" in the CD-Rom drive.
4. Type "D:\RAID\promise\Driver\Win9x-ME" in the text box, then click on "Next." Assuming the D: is your CD-Rom. Windows will inform you that it has found the "Win95-98 FastTrak100-Lite controller".
5. Click on "Finish" and re-start the system.

## **Confirming Driver Installation in Windows 98/95**

To confirm that the driver has been properly loaded in Win 95/98, perform the following steps:

1. Choose "Settings" from the "Start" menu.
2. Choose "Control Panel," and then double-click on the "System" icon.
3. Choose the "Device Manager" tab, and then click the "+" in front of "SCSI & RAID controllers." "Win95-98 Promise FastTrak100-Lite controller" should appear

## **WINDOWS NT4**

### **Installing Drivers During Windows NT 4.0 Installation**

1. Start the system installation by booting from the Windows NT disk:
  - a) Floppy install: boot the system with the Windows NT installation diskettes.
  - b) Floppyless install: boot from floppy and type "WINNT /B". After files have been copied, the system will reboot. On the reboot, press the "F6" key when the message "Setup is inspecting your computer's hardware configuration..." appears.
  - c) CD-ROM disk install: boot from the CD-ROM disk and press the "F6" key when the message "Setup is inspecting your computer's hardware configuration..." appears.
2. When the "Windows NT Setup" window is generated, press "S" to Specify an Additional Device(s).
3. Press "O" to select "Other" and press the "Enter" key.
4. Insert the diskette\* into drive A: and press the "Enter" key.
5. Choose "Win NT FastTrak100-Lite (tm) Controller" from the list that appears on screen, then press the "Enter" key.

6. The Windows NT Setup screen will appear again saying "Setup will load support for the following mass storage devices." The list will include "Win NT FastTrak100-Lite (tm) controller".

*NOTE:* If you need to specify any additional devices to be installed, do so at this time. Once all devices are specified, continue to step 7.

7. From the Windows NT Setup screen, press the Enter key. Setup will now load all device files and then continue the Windows NT installation.
8. After a successful installation, the "SCSI Adapter Setup" box will show that the "Win NT FastTrak100-Lite (tm) Controller" driver has been installed.

\* Copy the Windows NT drivers from the SOYO CD to a floppy disk.

### Installing Driver with Existing Windows NT 4.0



**WARNING:** If you plan to move your boot drive to a mirrored RAID 1 FastTrak array, hard drives should NOT be connected to the FastTrak100-Lite controller before performing the following procedure. The FastTrak100-Lite drivers must be loaded on the system hard drive (running under the existing hard drive controller) before any hard drives are connected to the FastTrak100-Lite controller card.

1. Choose "Settings" from the "Start" menu.
2. Choose "Control Panel" from the "Settings" menu.
3. Double-click on the "SCSI Adapters" icon, which generates the "SCSI Adapters" dialog box.
4. Choose "Drivers," and then press "Add."
5. In the "Install Drivers" dialog box, press "Have Disk..."



6. When the “Install From Disk” appears, insert the “SOYO CD” in the CD-Rom drive.
7. Type “D:\RAID\promise\Driver\Win9x-ME” in the text box window, then choose “OK.” Assuming that D: is your CD-Rom.
8. When the “Install Driver” dialog box appears, select “Win NT FastTrak100-Lite Controller” and then press “OK.”
9. When the “Select SCSI Adapter Option” dialog box appears, press “Install.”
10. After a successful installation, the “SCSI Adapter Setup” box will show that the “Win NT FastTrak100-Lite Controller” has been installed.
11. Power off your system and install the hard disk in the FastTrack-100-Lite Controller.

#### **Removing the Driver from Windows NT 4.x**

1. In “Start” Button choose “Control Panel” in “Setup” group.
2. In “Control Panel,” select “SCSI Adapter,” next choose “Drivers” label
3. Choose “Remove” button.
4. After successful removing, the “SCSI Adapter Setup” box will show that “Win NT FastTrak100-Lite RAID Controller” has been removed.

# Using The FastCheck™ Monitoring Utility

You can monitor the operating status of all arrays and drives configured on the FastTrak100-Lite using the supplied FastCheck monitoring utility for Windows-based operating systems. FastCheck generates visual and audible messages alerting you of possible problems with the disk array or controller.

*FastCheck visually identifies the physical location of attached drives on the FastTrak100-Lite by IDE channel (1 or 2) and setting (Master/Slave/Cable-Select).*

*It also displays which drives are included as part of individual arrays.*

*Administrators can customize FastCheck to maintain operating logs and event notification, set Password access to the utility, and schedule maintenance on Mirrored (RAID 1) or a Striped/Mirrored (RAID 0/1) arrays.*

## INSTALLING FASTCHECK

1. *From the Start Button on the Windows Taskbar, choose Run.*
2. *Insert Promise FastCheck Utility Diskette.*
3. *In the Run dialog box, type in "A:\\" and click OK.*

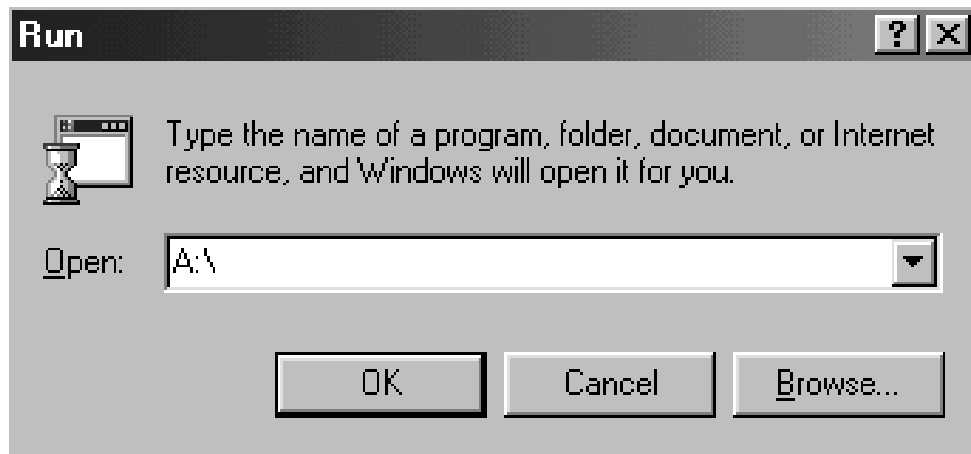

4. *Follow the directions from the setup program.*
5. *During installation, click YES when prompted to run the utility on every startup. If NO is selected, FastCheck will not initialize during startup. You may manually execute the utility via the Start button.*

**NOTE:** Promise recommends to have FastCheck load during Startup. This insures you that it will be ready to post alerts on errors.

## RUNNING FASTCHECK

As described in the Installation section, the default option for FastCheck is to load during startup of Win95/98/NT/2000. It appears minimized on the taskbar under Win 95/98/NT4/2000/Millennium (see below).



To start FastCheck, double-click on the FastCheck icon on the taskbar (above) or you may also use the Taskbar Start/Promise/FastTrak/FastCheck menus shown below.



## CLOSING FASTCHECK

Once FastCheck is opened (either automatically on startup or manually), the monitoring utility remains running in the background even if the user “closes” the FastCheck window.

To completely shut down FastCheck, perform the following steps.

1. Right-click the FastCheck icon on the Taskbar.
2. Select Exit from the pop-up window.

3. FastCheck will no longer be running and will no longer be monitoring the array.

## USING FASTCHECK ARRAY WINDOW

Once FastCheck is selected, the FastCheck Monitoring Utility window will appear. The main pane has three information window tabs: Array, Controller, and Options. The user can switch screens by clicking on the tab. The Array Window is the active screen by default as shown below:

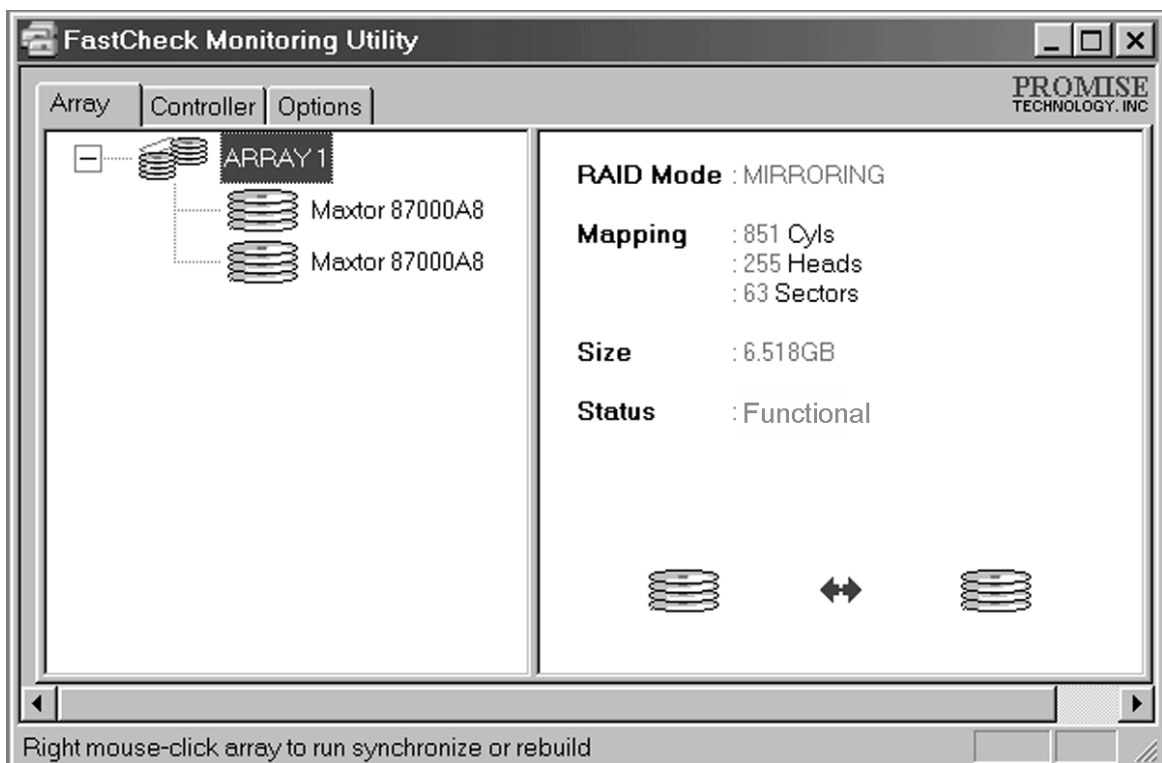

The Array Window (see above) displays information about the arrays configured on your FastTrak100-Lite through the FastBuild BIOS. From this window, you can also perform data Synchronization of mirrored arrays, or Rebuild data from one drive to a replacement drive within a mirrored array.

While the Array Window does not allow you to change the array configurations directly, it clearly identifies which drives are associated with each array shown in the left pane.

## Viewing Array Information

*By left-clicking on the Array #, the right pane shows the following information categories for that array:*

**RAID mode:** *(Striping, Mirroring, Mirroring & Striping, Spanning)*

**Mapping:** *(similar to physical drive specifications) describing # of cylinders, heads, and sectors of the array's "virtual" drive as seen by the system*

**Size:** *Storage capacity of the array*

**Status:** *(Functional, Critical, Offline)*

**Functional:** *Means the array is providing full functionality*

**Critical:** *Used only in reference to a Mirroring array (RAID 1). A problem has been detected in one of the drives of the array and the drive has been taken "offline." However, a "critical" array will continue to save and retrieve data from the remaining working drive(s). SOYO recommends replacing the failed drive as soon as possible since a "Critical" array offers no data redundancy.*

**Offline:** *This would appear most commonly within a RAID 0 or Spanning array. The "Offline" results from a drive having failed which has taken the entire array "offline." In this case, you have likely lost data. Fix/replace the drive that has failed, then restore data from a backup source.*

## Viewing Arrayed Drive Information

*By left-clicking on a drive member of an array in the left pane, the right pane shows the following information categories for that drive:*

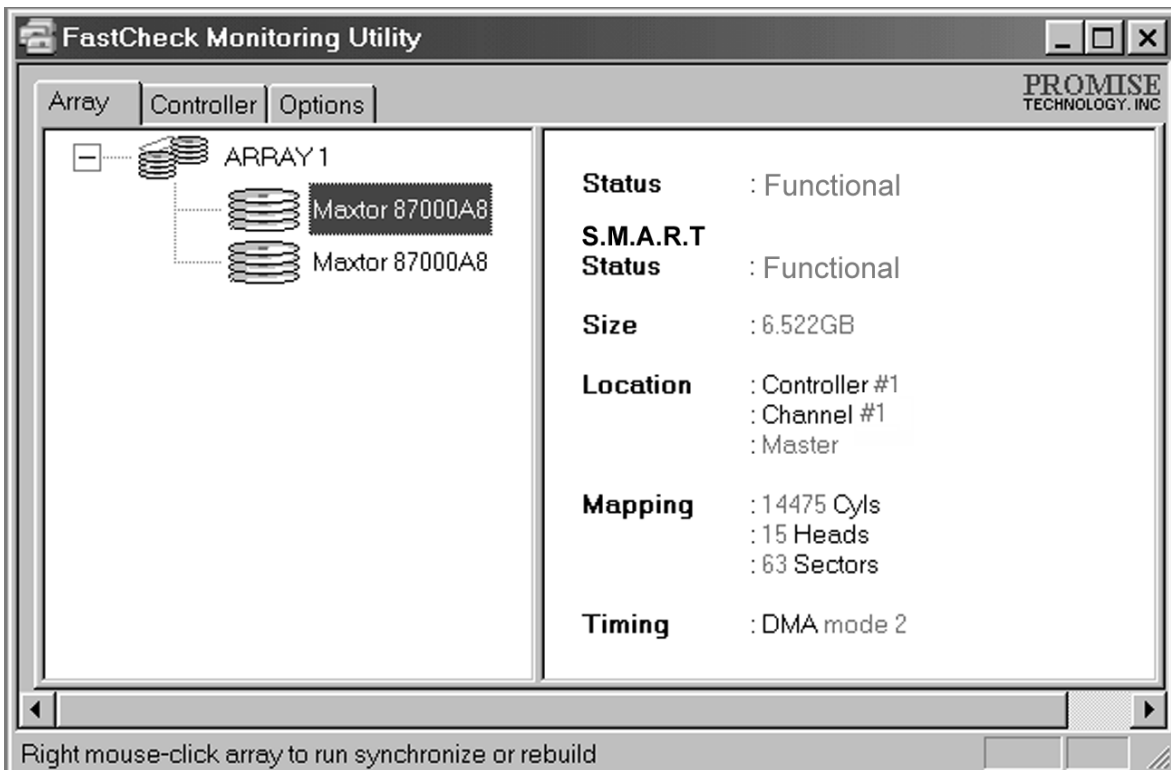

*Status (also shown under the Array Window) can be Functional, Critical, or Offline. The meanings are shown below.*

**Functional:** Means the drive is working normally

**Critical:** A problem has been detected in the drive and the drive taken offline as part of a mirroring array. Mirrored arrays will continue to function without the drive. Fix/replace the drive that has failed, then restore data from a backup source.

**Offline:** Drives that are NOT identified as “bad” may be taken offline if part of a Striping or Spanning array containing a “bad” drive. These drives do NOT need to be replaced, however.

**S.M.A.R.T. Status:** *Indicates whether attached hard drive implements Self-Monitoring Analysis & Reporting Technology to predict drive failure*

**Size:** *Indicates capacity of individual drive*

**Location:** *Shows physical location of drive. Indicates on which IDE channel (1 or 2), and whether drive is Master or Slave on cable. This allows user to identify drives for removal/replacement.*

**Mapping:** Indicates physical parameters of drive (cylinders, heads, sectors)

**Timing:** Shows selection of drive timing (directly related to burst speed)  
based on type of drive and cable used.

## Using Array Pull-down Menu

At the bottom of the Array window, it indicates to right-click on an Array to perform synchronization or rebuild operations. Right-clicking displays the following pull-down menu:

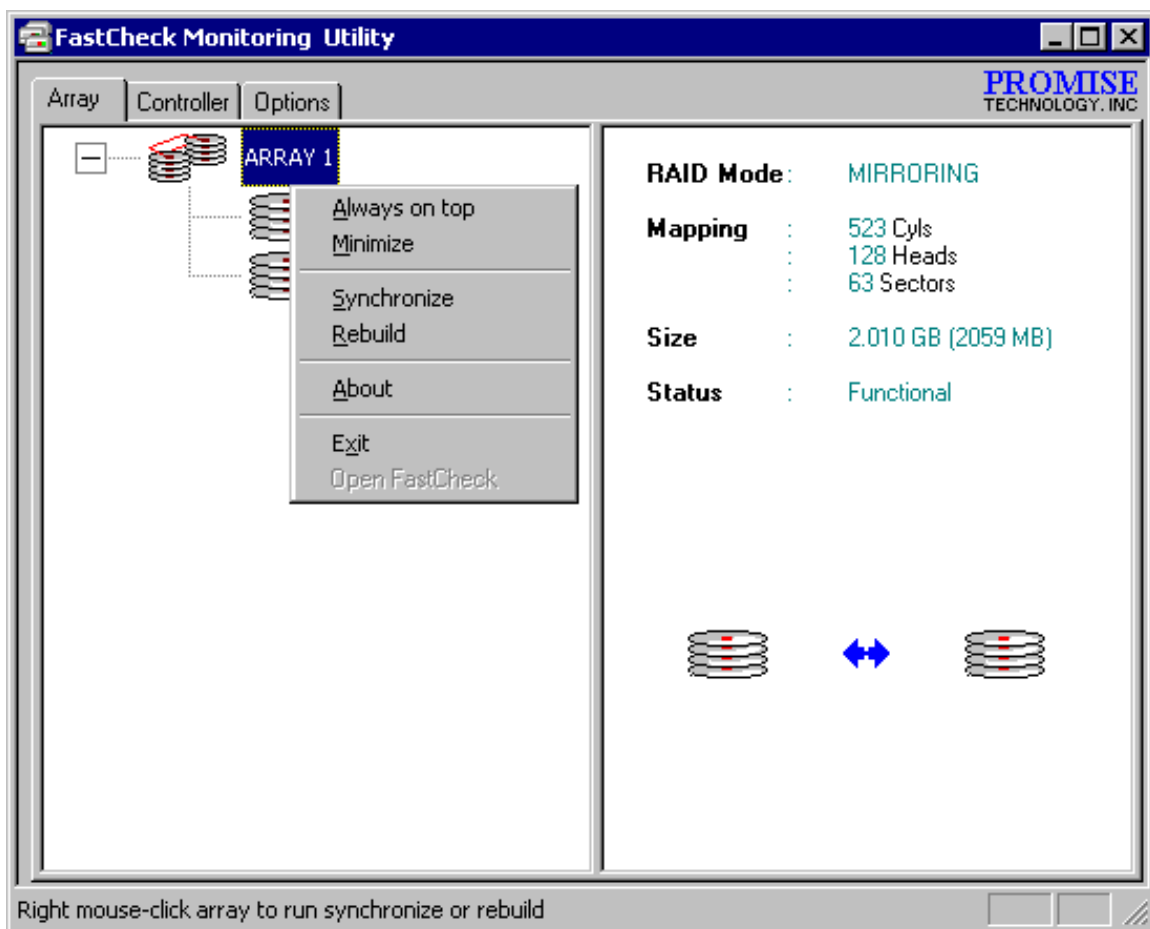

From this menu, users may choose to have the Window Always **Appear** on Top of applications, **Minimize**, **Synchronize** mirrored drives, **Rebuild** a mirrored array, use **About** to check FastCheck version #, or **Exit** the onscreen window.

## SYNCHRONIZING AN ARRAY

Synchronization is a periodic maintenance procedure for Mirroring (RAID 1) arrays to maintain data consistency on all mirrored drives. In operation, array synchronization compares data on the mirrored drives for any differences. If there are differences detected, data from the primary drive(s) is automatically copied to the secondary drive(s). This assures that all mirrored drives will contain the exact information.

**NOTE:** You may instead choose to schedule array synchronization automatically under the Options Tab view versus manually initiating synchronization.

1. To synchronize, choose the Array Tab View (see figure on previous page).
2. Right-click on the array you wish to synchronize and choose “Synchronize” from the context menu.
3. Click “Yes” to initiate Synchronization (see below) when the Confirmation window appears. To cancel this option, click the No button.

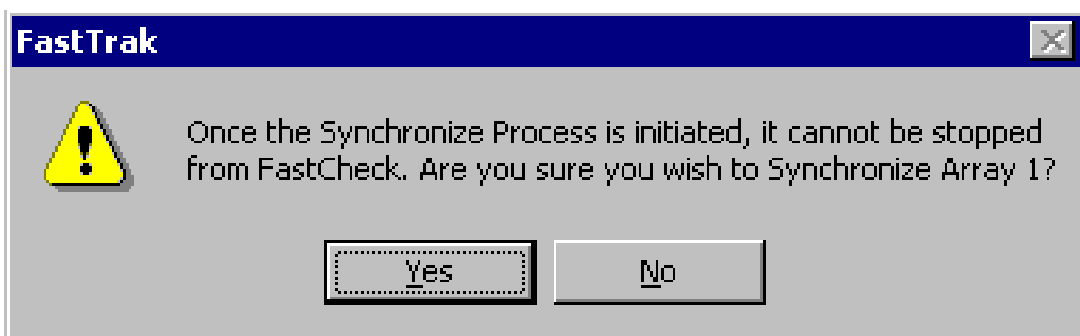

**WARNING:** Once initiated, synchronization can NOT be halted in order to prevent data errors.



4. *Once Synchronization is confirmed, the following information screen appears. Click OK button or close the window to proceed.*

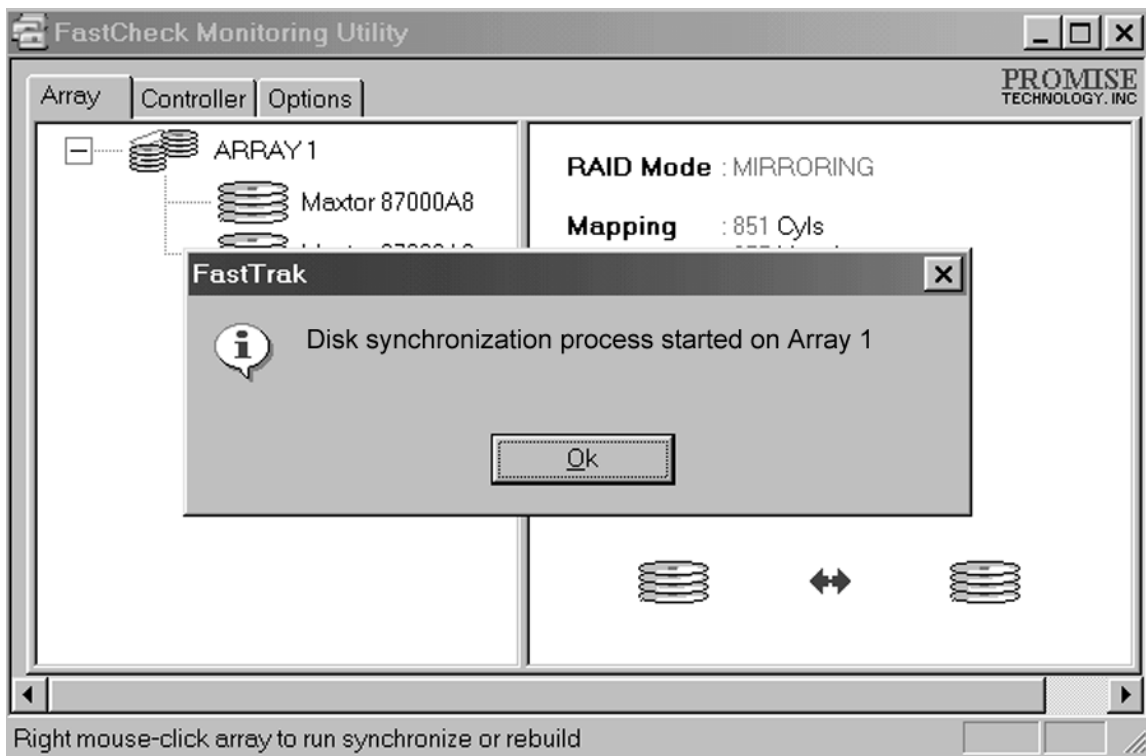

**NOTE:** During Array Synchronization, users may continue to access the working array and perform normal PC functions. However, system performance will be slightly degraded and the process will take longer.

5. *A progress bar will appear at the bottom of the FastCheck Monitoring window showing synchronization in progress and the percentage that has been completed.*



## REBUILDING AN ARRAY

This command effectively copies or overwrites data from an existing data drive in the array on to a blank drive. The operation will be typically used when a failed drive has been replaced with a new drive as part of a mirrored array.

1. To perform a Rebuild, choose the Array Tab View.
2. Right click the array number and choose Rebuild from the context menu.
3. Once Rebuild is selected, you will be asked to “Initialize Rebuild process on Array #” by clicking OK.

### Using Rebuild Wizard

1. *Initiating rebuild array will open the Rebuild Wizard Step 1 screen shown below.*
2. *Select the Target drive which will receive data. Make sure you select the blank new or replacement drive. The unselected drive will contain “good” data. It will be the remaining working drive of an array, or a system drive containing existing data that you wish to mirror.*

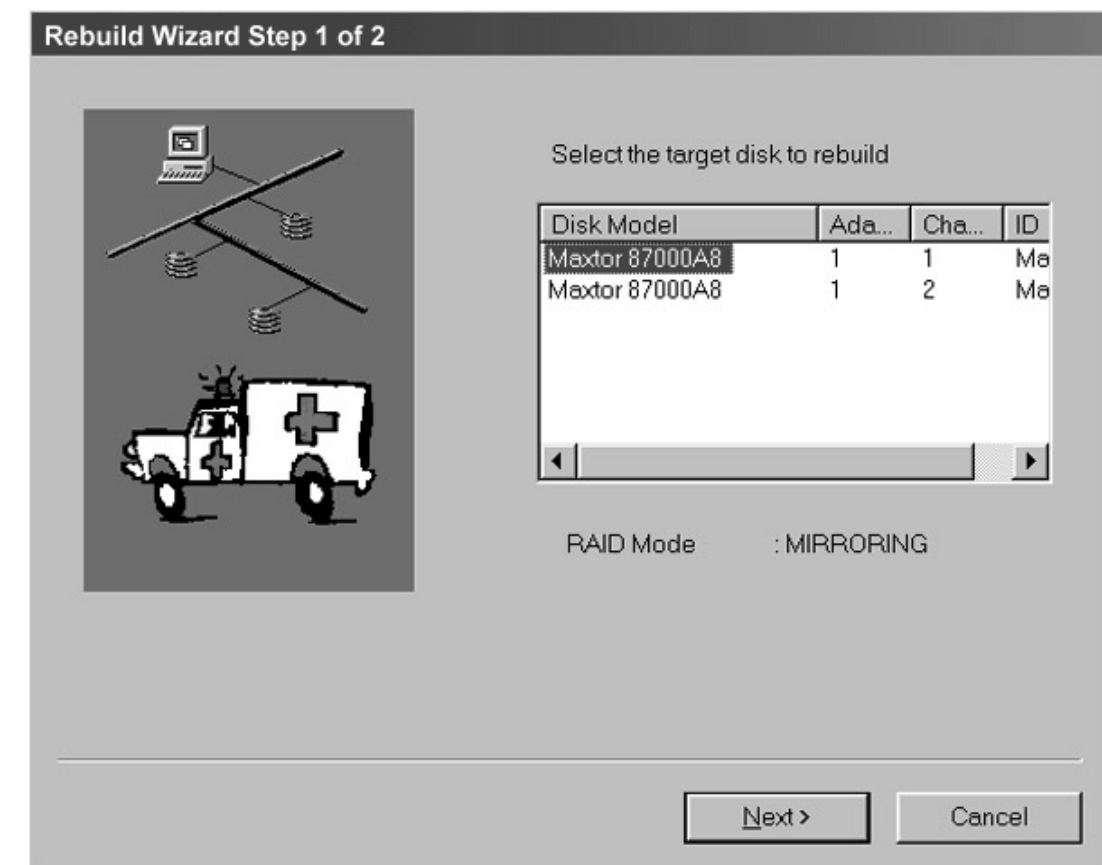



**WARNING:** Make absolutely sure and double-check which drive is which. If data exists on the target drive, it will be over-written.

3. Click the *Next* button to proceed to *Rebuild Wizard Step 2* (see next page) or *Cancel* button to stop.

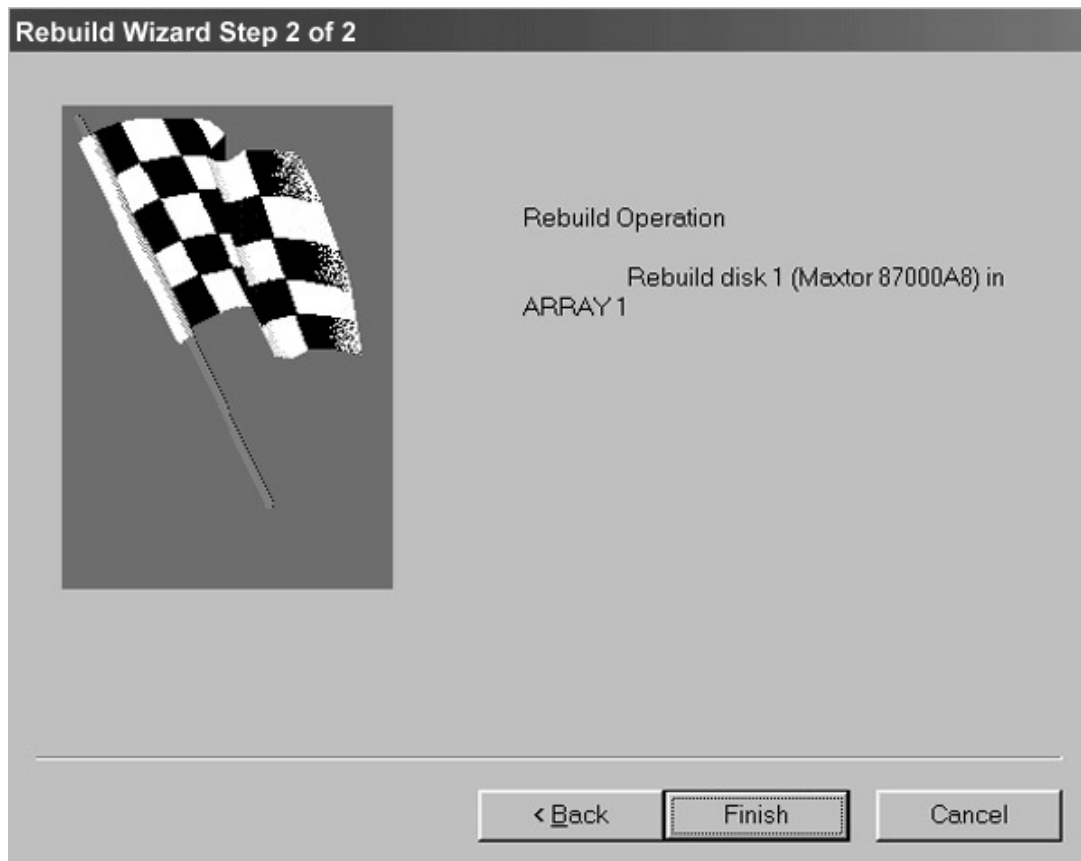

4. *Rebuild Wizard Step 2* confirms the *Target* or “*Rebuild*” disk by *Array #* and *drive ID*.
5. Click *Finish* button to initiate physical *Rebuild*, *Back* button to review *Step 2*, or *Cancel* button to *Stop*. A final confirmation window appears as below:

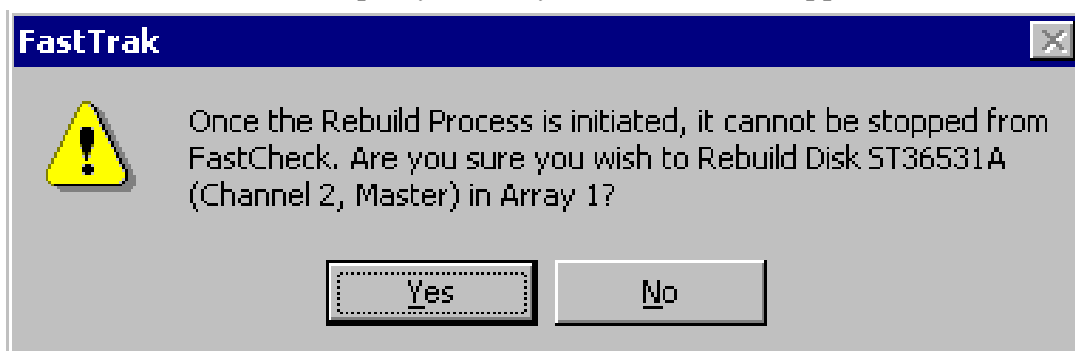

6. Click “Yes” to initiate Rebuild. To cancel this option, click the No button.



**WARNING:** Once initiated, Array Rebuild can NOT be halted in order to prevent data errors.

**NOTE:** During Array Rebuild, users may continue to access the array and perform normal PC functions however the array will NOT provide data redundancy until Rebuild is completed. If you choose to continue using the PC during rebuild, system performance will be slightly degraded and the process will take longer.

7. Once Array Rebuild has begun, users are returned to the FastCheck Monitoring window. A progress bar showing the rebuild progress in percentage will appear at the bottom of the FastCheck Monitoring window.



**NOTE:** When a “spare” unassigned drive is present on the FastTrak100-Lite, a rebuild will automatically be performed from the remaining working drive.

## USING CONTROLLER WINDOW

Clicking on the Controller tab, will reveal the Controller Window. This displays physical information about the location of FastTrak100-Lite, data channels on the card, and the attached drives.

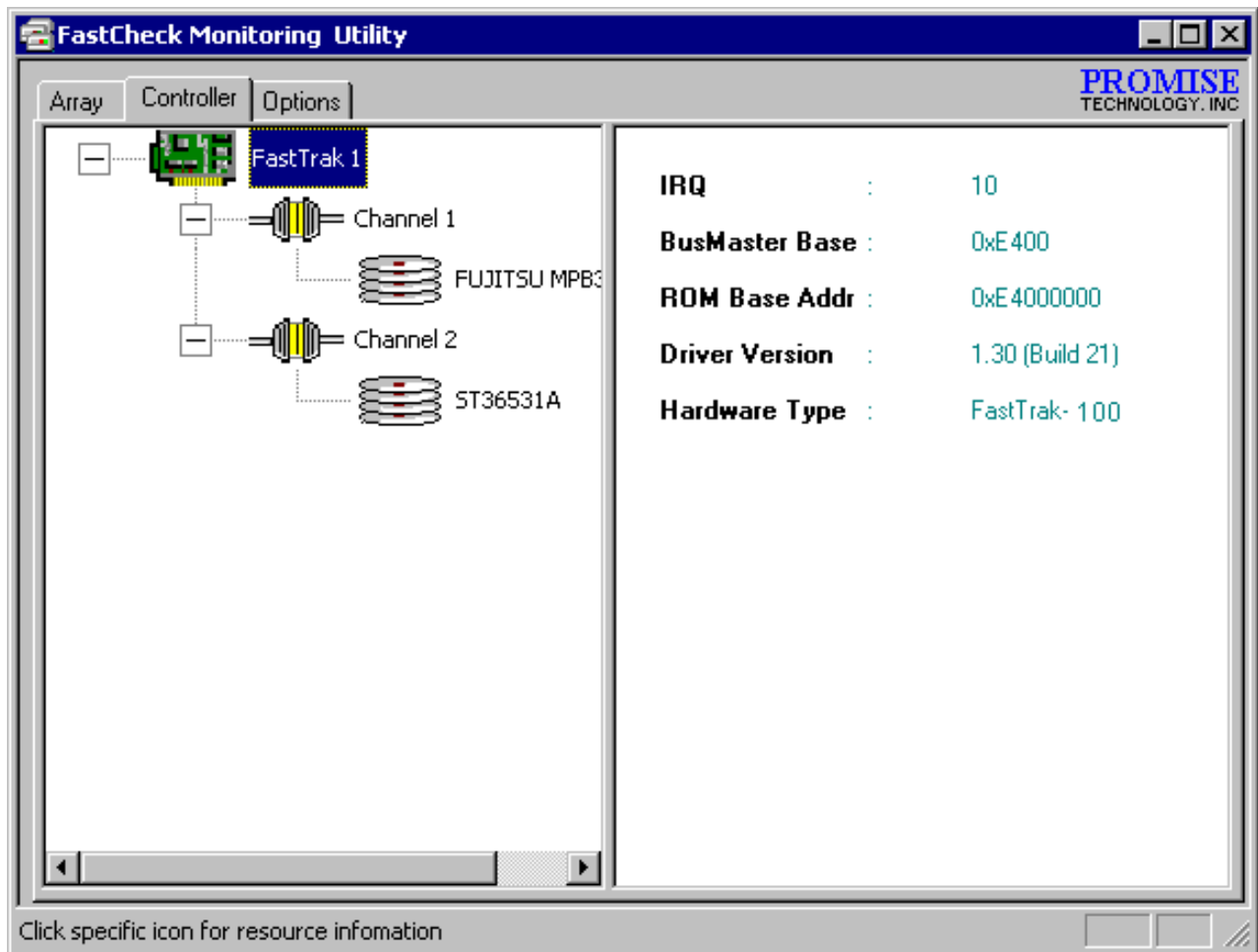

## Viewing Controller Card Information

*By left-clicking on the FastTrak controller icon, the right pane shows the following information categories for that array:*

**IRQ:** Identifies interrupt request assigned to PCI slot

**Bus Master Base:** Shows base address in hex numbering for board's bus master Input/Output function

**ROM Base Address:** Shows base address in hex numbering for FastTrak's Flash ROM chip

**Driver Version:** Identifies which version of the Promise FastTrak100-Lite driver you have installed.

**Hardware Type:** Identifies which FastTrak model is installed.

## Viewing IDE Channel Information

Left-clicking on a given Channel icon or # in the left pane, will show the Base IO addresses of the channel in the right pane (used for troubleshooting).

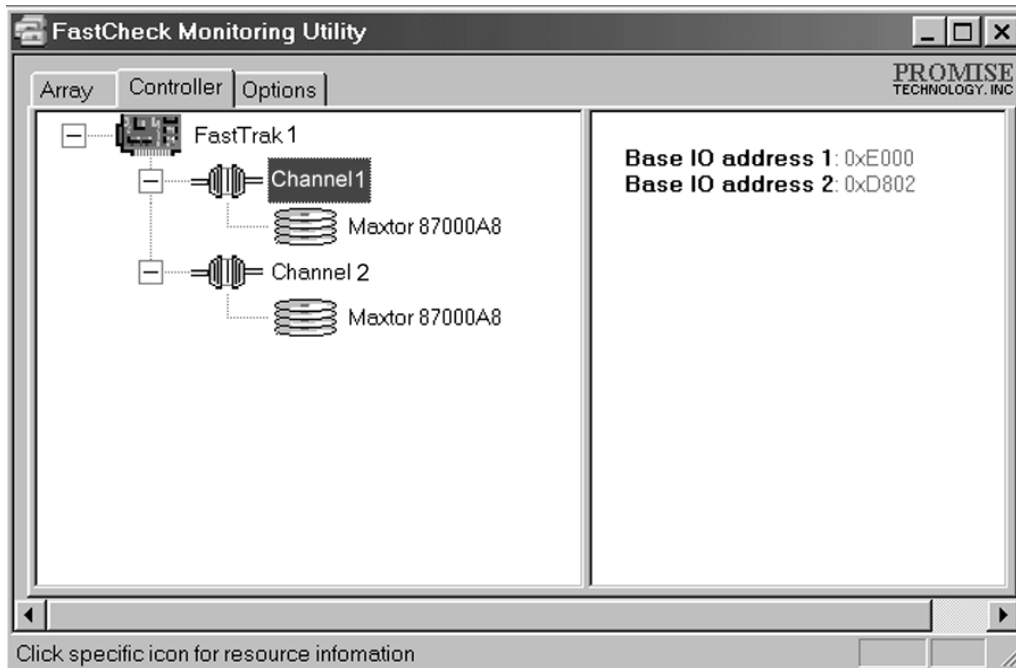

## Viewing Drive Information

Left-clicking on a given Drive icon or ID in the left pane, will show similar information categories as the Array Window Drive Information in the right pane.

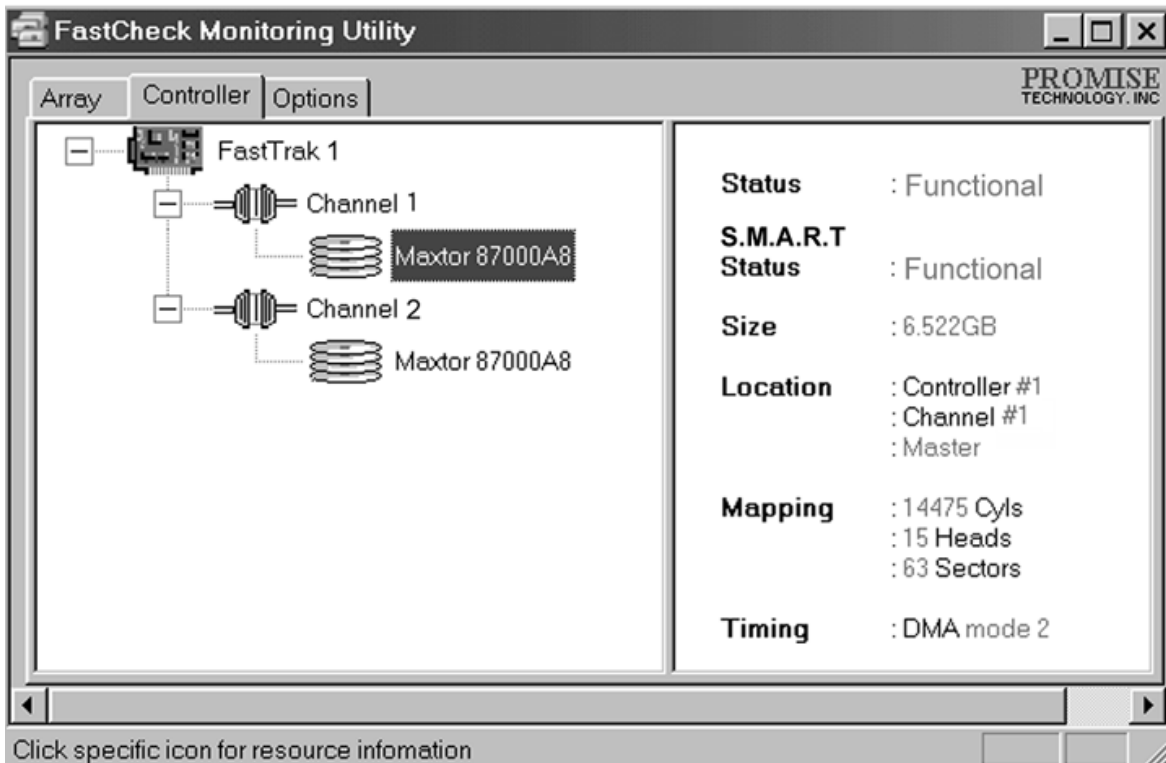

*Status* (also shown under the Array Window) can be *Functional*, *Critical*, or *Offline*. The meanings are shown below.

**Functional:** Means the drive is working normally

**Critical:** A problem has been detected in the drive and the drive taken offline as part of a mirroring array. Mirrored arrays will continue to function without the drive. Fix/replace the drive that has failed, then restore data from a backup source.

**Offline:** Drives that are NOT identified as “bad” may be taken offline if part of a Striping or Spanning array containing a “bad” drive. These drives do NOT need to be replaced, however.

*S.M.A.R.T. Status:* Indicates whether attached hard drive implements Self-Monitoring Analysis & Reporting Technology to predict drive failure

*Size:* Indicates capacity of individual drive

*Location:* Shows physical location of drive. Indicates on which IDE channel (1 or 2), and whether drive is Master or Slave on cable. This allows user to identify drives for removal/replacement.

*Mapping:* Indicates physical parameters of drive (cylinders, heads, sectors)

**Timing:** Shows selection of drive timing (directly related to burst speed) based on type of drive and cable used.

## USING OPTIONS WINDOW

Clicking on the Options tab reveals the Options Window. Array administrators can customize the FastCheck Monitoring Utility in four major areas: Notification, Array Synchronization Scheduling, setting Password, Desktop Appearance. Most options relate to Mirroring arrays (RAID 1).

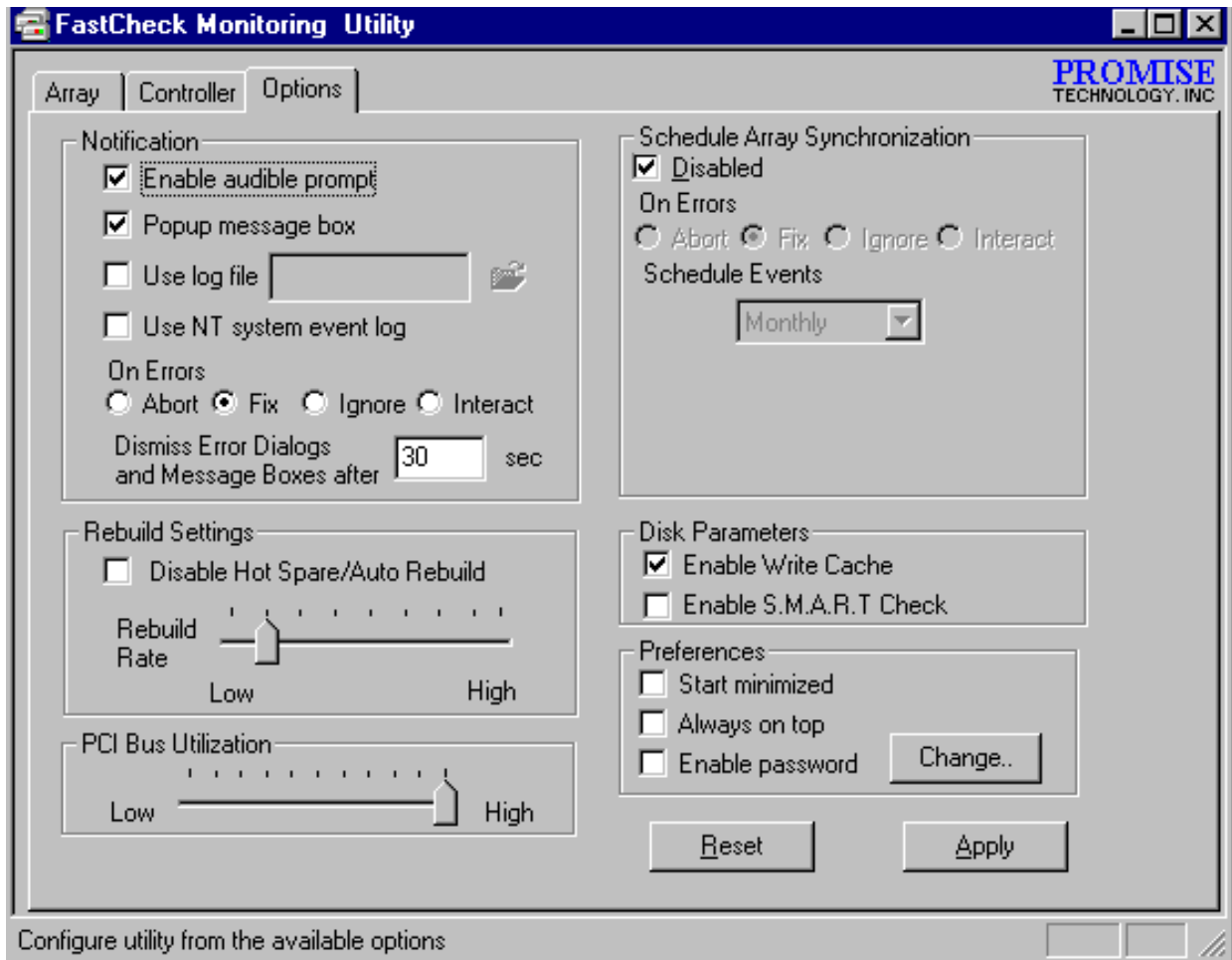

## Selecting Notification Options

This section of the Options windows allows users to select how they are notified of a system event. A System Event includes driver-initiated Rebuilds (automatic rebuild using a “hot” spare standby drive), user-initiated manual Rebuilds or manual Synchronization, and Error-Handling reporting for these processes.

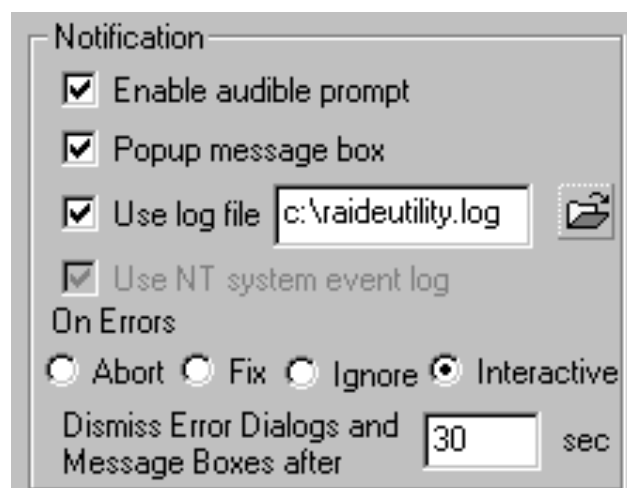



**Enable audible prompt** checkbox turns on/off an audible alarm of an event (typically a drive failure, or completion of rebuild or synchronization).

**Popup message box** checkbox turns on/off the appearance of an event message box that would typically indicates a drive failure, or completion of rebuild or synchronization.

**Use log file** checkbox allows writing operating event logs of the array activity (alerts and status reports) to a given file name and directory. If a file name is used but the path left blank, the default directory is the same as the FastCheck Utility (typically C:\Program Files\Promise\FastTrak100-Lite).

**Use NT system event log** checkbox is greyed out under Windows 95/98/2000/Millennium automatically. Under Windows NT4, it permits user to write array logging to NT's own event log.

1. To view FastCheck events under Windows NT, go to Start/Programs/Administrative Tools/Event Viewer.
2. In the Event Viewer, choose "Log" from the menu bar, then check "Application." Any events generated by FastCheck will appear under the Source column as "FastCheck."

**On Errors** section offers four radio button choices for the user to select what procedure they would like to perform if an Error is detected during automatic/manual Rebuilds or manual Synchronization. There are three types of errors that FastTrak100-Lite detects -- a data mismatch between the primary and secondary drive, a physical media error on source or target drive, or a total disk failure. The options for handling Errors are as follows:

**Abort:** stops any Synchronization or Rebuild process if an error is encountered.

**Fix:** in most cases, FastTrak100-Lite automatically can correct errors. The method of correction varies depending on the type of error.

**Ignore:** FastTrak100-Lite will log the event error and continue the rebuild or synchronization process. Use this setting if you want to detect the presence of errors, but do not want to fix these errors at the time. The user may then decide what to do about the error(s) detected.



**WARNING:** This may result in mismatched drives under RAID 1.

**Interactive:** By checking this option, a selection window will appear each time an error is detected asking the user whether they want to Abort, Fix, or Ignore the error (see Troubleshooting section).

**Dismiss Error Dialogs** designates the length of time (in seconds) that a Message box or Error Dialog box appears on screen.

## Scheduling Array Synchronization

This section of the Options Window allows a user to schedule when and how often FastTrak100-Lite will perform synchronization maintenance of a mirrored array.

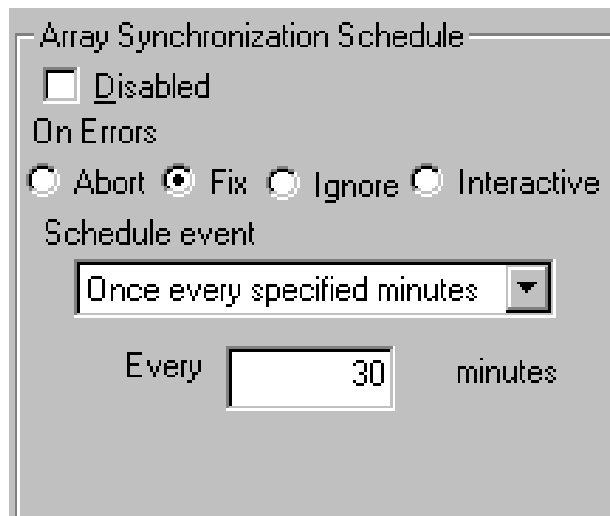

Array Synchronization Schedule

Disabled

On Errors

Abort  Fix  Ignore  Interactive

Schedule event

Once every specified minutes ▼

Every  minutes

**Disable** checkbox is checked (the default) to turn off automated scheduling of synchronization. When unchecked, the Scheduling section will be highlighted (see above).

**On Errors** section offers four radio button choices for the user to select what procedure they would like to perform if an Error is detected during a scheduled Synchronization. There are three types of errors that FastTrak100-Lite detects -- a data mismatch between the primary and secondary drive, a physical media error on source or target drive, or a total disk failure. The options for handling Errors are as follows:

**Abort:** stops the Synchronization process if an error is encountered.

**Fix:** in most cases, FastTrak100-Lite automatically can correct errors. The method of correction varies depending on the type of error (see Appendix under Error Correction Methodology).

**Ignore:** FastTrak100-Lite will log the event error and continue the synchronization process. (Warning: this may result in mismatched drives under RAID 1). Use this setting if you want to detect the presence of errors, but do not want to fix these errors at the time. The user may then decide what to do about the error(s) detected.

**Interactive:** By checking this option, a selection window will appear each time an error is detected asking the user whether they want to Abort, Fix, or Ignore the error (see Troubleshooting for more details).

**Schedule event** drop down box allows scheduling synchronization by minute, by hour, by day, by week, or by month. If enabled, the default is By Month. This allows synchronization to take place during an off-hour when the system is either not in use or not at peak demand.

**Start time** designates hr/min/ am/pm

**On the** designates day of week or by ordinal (1st, 2nd, 3rd...) selection.

## Setting Rebuild Options

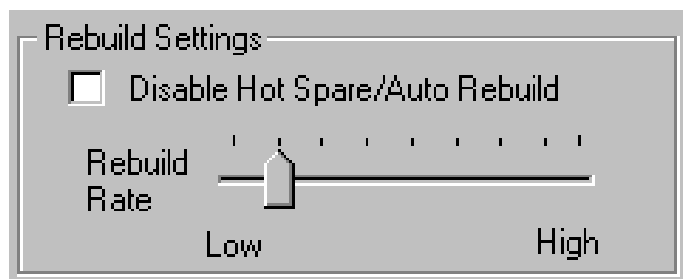

**Disable Hot Spare/Auto Rebuild** checkbox turns off the use of a “hot” spare drive and automatic rebuilding of a mirrored array. The default is unchecked (or enable Hot Spare/Auto Rebuild).

**Rebuild Rate** assigns the amount of importance that FastTrak100-Lite gives to mirroring data from one drive to another in the background. A “high” setting assigns most of FastTrak100-Lite’s resources to the rebuild process at the expense of responding to ongoing read/write data requests by the operating system. A “low” setting gives priority to ongoing read/write data requests by the operating system at the expense of the rebuild process and will typically result in longer rebuild times. The setting shown above is the default.

### Setting PCI Bus Utilization Option

**NOTE:** *In most cases, a user does not need to change this setting since FastTrak100-Lite’s data handling rarely conflicts with another PCI device. However, certain brands of video capture cards can produce a “glitch” on play back of A/V files that may require adjusting the default setting devices (see Tips for Audio/Video Editing for more information).*

This section of the Options Window allows a user to change how much time the FastTrak100-Lite holds on to the PCI bus to transfer data.

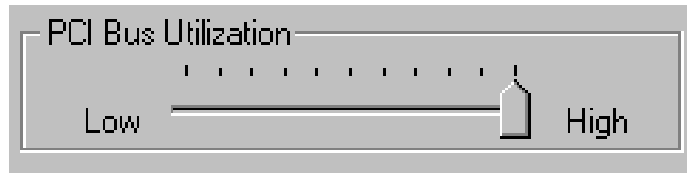

The default setting of “High” on the slider bar means FastTrak100-Lite holds on to the PCI bus longer for data transfers to occur. A setting of “Less” reduces the time which FastTrak100-Lite occupies on the PCI bus and frees that time for use by other PCI devices.

Once a bus setting has been selected, click the Apply button on the Options window to implement changes immediately.

### **Setting Disk Param(eters) Option**



**Enable Write Cache** checkbox allows user to enable/disable write cache for hard drives that include this performance feature. FastCheck automatically recognizes such drives and enables the feature as the default setting. For drives that do not use write caching, this option is automatically greyed out.

**Enable S.M.A.R.T. Check** checkbox tells FastCheck to regularly monitor each drive to assure that drive failure prediction is functioning. The default is unchecked, meaning FastCheck will not monitor this function.

## Setting Screen Preferences

This section controls how the FastCheck utility screen is displayed and sets the security password to protect the administrative settings.



**Start Minimized** checkbox allows user to have FastCheck appear on the toolbar only on startup. Click on the icon to see the FastCheck utility screen.

**Always on Top** checkbox tells the Utility to appear above all programs until closed or minimized manually.

**Enable Password** checkbox in the Preferences section turns on/off use of a Password every time the FastCheck Monitoring Utility icon is selected or the program is run from the Start menu. Disabling use of a current password requires password entry (see Creating Password on next page).

## Creating Password

1. To create a password, check the **Enable Password** checkbox in the Preferences section. The “Set Password” window will appear.

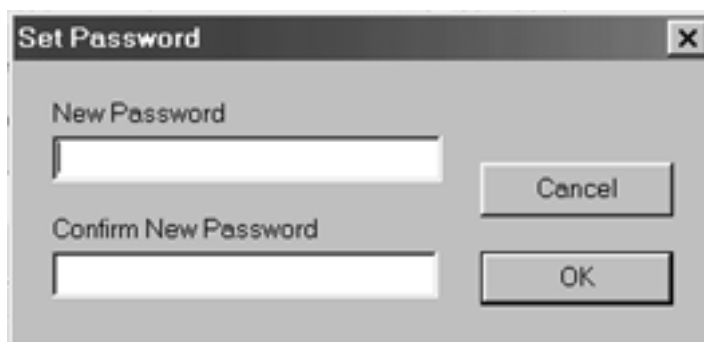

2. Type the password you want to use. Press the Tab key or click to retype the same password in the “Confirm New Password” section. Click the OK button.

**NOTE:** Remember to record the password you use in a secure place in case you forget it.

3. A confirmation screen will appear saying that “Password Checking is Enabled”. Click the OK button.
4. Once the password feature is enabled, the following menu will appear before the FastCheck window can be opened. is enabled, the following menu will appear on each use of FastCheck.

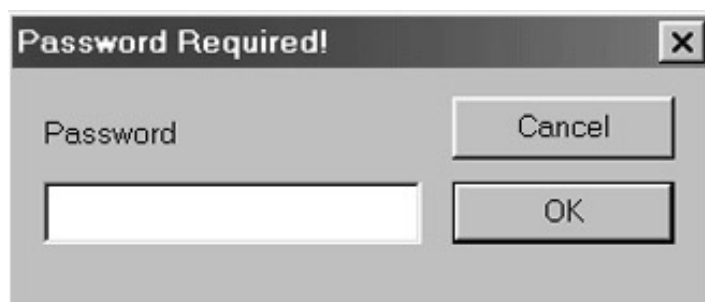

### **Changing Password**

1. *Input the original password you first created to gain access to FastCheck.*
2. *Click on Options tab, then click on the Change button in the Password section. The Set Password screen will appear (see figure in step 3 above).*
3. *Type the password you want to use. Press the Tab key or click to retype the same password in the “Confirm New Password” section.*
4. *Click OK button.*

### **Disabling Password**

1. *Input the original password you first created to gain access to FastCheck.*
2. *Click on Options tab*
3. *Uncheck the “Enable Password” checkbox. Click Apply button on Options window.*

## Frequently Asked Questions

*This section lists frequently asked questions involving pre-installation, drive issues, installation, and post-installation.*

### PRE-INSTALLATION

(Speed, Device Types, Capacity, Cabling)

**Q: What kind of hard drives can I use for a FastTrak100-Lite array?**

A: You can use any IDE/EIDE hard drive(s) to create arrays on the FastTrak100-Lite. You should use matching drives for multiple-drive arrays to maximize capacity usage as well as performance. Ultra ATA/100 drives are recommended for highest performance.

**Q: Will APM (Advanced Power Management) work with HDDs on the FastTrak100-Lite?**

A: APM will not work with HDDs on the FastTrak100-Lite. This is because the system sees the card as a SCSI card.

**Q: Can I use ATAPI devices on the FastTrak100-Lite controller?**

A: No. There is no driver layer on the FastTrak100-Lite controller which will support ATAPI packet messages.

**Q: Will the FastTrak100 Lite work with a 37Mhz or 41Mhz PCI bus speed?**

A: The current PCI 2.1 specification is for a 33Mhz PCI bus speed. The FastTrak100-Lite is designed around the specification. In most cases, a higher PCI bus speed will result in a variety of different errors. While some people have been able to get these higher speeds to work, since it is out of specification we cannot support it.

**Q: How can I change the resources that the FastTrak uses?**



A: The FastTrak100-Lite is fully PnP. This means all the resources that it uses are given to it by the PnP BIOS on the motherboard. The FastTrak100-Lite does support IRQ sharing, but this will not work unless ALL the concerned devices support the feature. If your motherboard allows you to control the assignment of these resources, you may be able to remedy the problem by “playing around” with them. You can also try resetting the configuration data in your CMOS. This is usually an option in the PnP section of your CMOS. Otherwise, the only way you might be able to affect these assignments is to switch the PCI slot that the card is in.

**Q: How does the FastTrak100-Lite RAID controller provide storage and/or data protection with their arrays?**

A: FastTrak100-Lite implements three different types of RAID levels as follows:

**RAID 0 (stripe)**

**For capacity** -- The FastTrak100-Lite array will be as big as the smallest HDD in the array times however many HDDs are in the array. Any larger HDDs will simply be truncated. The truncated space on the bigger HDDs will then be unusable.

**For sustained data transfers** -- Using FastTrak100-Lite, a RAID 0 array consisting of two HDDs will transfer at about twice the speed of the slowest HDD in the array. A RAID 0 array consisting of four HDDs will transfer at about three times the speed of the slowest HDD in the array.

**RAID 1 (mirror)**

**For capacity** -- The FastTrak100-Lite array will be as big as the smallest HDD in the array. The larger HDD will simply be truncated. The truncated space on the bigger HDD will then be unusable.

**For sustained data transfers** -- The FastTrak100-Lite array will write data at the rate of the slowest HDD in the array. The FastTrak100-Lite array will read data at twice the rate of the slowest HDD in the array.

## DRIVE ISSUES

**Q: Can I add a drive to a FastTrak100-Lite RAID array via hot-swap and dynamically adjust the array size/configuration?**

A: No. The FastTrak100-Lite system does not support dynamically adjustable RAID size/configurations.

**Q: Do the HDDs on the FastTrak100-Lite have to be the same size?**

A: The HDDs that you use with the FastTrak100-Lite do not have to be the same size. If the sizes differ, the FastTrak100-Lite will “adjust” the HDDs so that they are compatible. Basically, it will truncate the bigger HDD so the sizes match. Any unused space that results from this is unusable, so don’t use HDDs that differ too much. It’ll work, but it’s a waste.

**Q: Can I take a set of drives which make up an array created on one FastTrak100-Lite server and move it to another FastTrak100-Lite server?**

A: Yes. All FastTrak100-Lite controllers read the arrays the same way. Once the drives are all connected, you must restart the system for it to recognize the newly-inserted array configuration.

**Q: Can I take a drive used in a FastTrak100-Lite array and access it directly with a different controller, such as the one integrated on the motherboard?**

A: Yes, but only under certain configurations. The following array configurations will allow the drive(s) to be accessed individually on another controller: mirror (RAID 0), single drive striped (RAID 1), or

single drive spanned (JBOD). Multiple drives striped or spanned will not work. Also, the controller must address the drives as LBA, not CHS.

**Q: If I have a problem with one of the drives on the FastTrak100-Lite, how can I low level format it to correct the problem?**

A: Do NOT do this. Low-level formatting IDE drives is unnecessary and generally does not correct problems which might be experienced during use. Errors such as bad sectors or ECC/CRC failure are best remedied by completely replacing the drive. For this reason, drives attached to the FastTrak100-Lite controller should NOT be low level formatted.

**Q: Do I have to install disk management software on my array in order to access the full storage capacity of drives?**

A: No! Disk management software would only complicate things. The array should be fully addressable by your O/S as it is. Remember that some operating systems have varying limits on the sizes of partitions and logical drives that can be defined. Consult your O/S documentation about partitioning larger drives.

**Q: What system BIOS CMOS settings do I use for the drives on the FastTrak100-Lite controller?**

A: None. The drives on the FastTrak100-Lite controller are supported by the FastTrak100-Lite BIOS and/or an O/S drivers, not by your system BIOS.

**Q: How do I partition/format my FastTrak100-Lite RAID array?**

A: The FastTrak100-Lite “fools” the system into thinking that it’s dealing with a single HDD. Therefore, anything that you can do to a single HDD can also be done to a FastTrak100-Lite array. You can, and should, use the FDISK and FORMAT utilities to partition/format the

array. You can partition the array however you see fit. You can format the array with whatever file system you wish.

## **INSTALLATION ISSUES**

(Capacity, Booting)

**Q: Why are some drives recognized by the FastTrak100-Lite Array Setup utilities with only partial capacity?**

A: Some hard drive models are shipped with a jumper that reduces the addressable capacity of the drive to prevent problems with older systems which won't support larger drives. Consult the documentation accompanying the hard drive to set the jumper appropriately in order to utilize the full capacity of the drive.

**Q: How can I change the system boot sequence in order to boot from the FastTrak100-Lite array?**

A: The boot sequence is controlled by the system BIOS. As far as the system BIOS is concerned, the FastTrak100-Lite controller and defined arrays are categorized as a "SCSI" device (even though the BIOS will not attempt to access the FastTrak100-Lite as any type of SCSI device). This allows you to set the boot sequence in your BIOS CMOS setup utility to boot from "SCSI" (an add-in controller like the FastTrak100-Lite) first, rather than "IDE" (an IDE controller built onto the motherboard or one which effectively replaces it). If there are multiple SCSI add-in controllers in the system, then the boot sequence among them will be determined exclusively by their PCI slot priority. PCI slot #1 will be first, slot #2 second, etc. Put the FastTrak100-Lite controller in the PCI slot where it will be accessed ahead of other SCSI controllers if you want to boot from the array.

**Q: How can I change the boot sequence between a PCI SCSI card and the FastTrak100-Lite RAID array?**

A: Since all PCI devices are all PnP, it is difficult to determine which device is addressed first. Some newer motherboard BIOSes may use advanced options that identify devices and allow you to select which device will be assigned resources first. Otherwise you may have to physically switch the device cards on the PCI slots so that the boot device is in the highest priority slot number (see previous question). If you do not require the FastTrak100-Lite BIOS to boot from an array and it is only to be used through a driver under the O/S, one simpler solution would be to disable the FastTrak100-Lite BIOS so that it does not affect the boot sequence at all.

## **POST-INSTALLATION**

(Memory Managers, FDISK)

**Q: Why does my system reboot after the QEMM driver loads from CONFIG.SYS?**

A: The problem lies in the QEMM “Stealth” feature. This feature places the drive information from the DOS System area into the upper reaches of RAM where Windows resides. This causes the FastTrak100-Lite to lose track of its drives when asked to execute the next line in the CONFIG.SYS file. This forces the reboot that you see. Disable QEMM’s stealth feature to correct this problem.

**Q: Why can’t I see the drives on the FastTrak100-Lite under FDISK?**

A: The FastTrak100-Lite controller is dedicated to RAID array management and does not provide any means of addressing individual hard drives through the Int 13h interface used by FDISK. In order to access drives on the FastTrak100-Lite from MSDOS at all, you must first create a RAID array.

## **APPENDIX B**

### **Overview and Acknowledgments**

*C-Media 6 Channel Audio offers a new generation in audio solution: it utilizes the state-of-the-art CRL® 3D Audio technology(HRTF 3D positional audio), and supports Microsoft® DirectSound ® 3D and Aureal®'s A3D® interfaces. Better yet, it supports 2/4/6 speakers and DLS based (DownLoadable Sound) wave table music synthesizer which supports the DirectMusic®. Besides being legacy audio SB pro® compatible and providing professional SPDIF IN/OUT non-distortion digital interface, it also supports MPU-401 interface, dual game ports, etc. What we provide at the side card are line-in/rear speaker jack, microphone jack, audio output jack, SPDIF/OUT jack, and 15pin D-SUB multiplexed joystick/MIDI connector.*

- **Special Features**

1. Full-duplex playback and recording. Built-in 16-bit CODEC.
2. HRTF 3D positional audio, supporting both DirectSound 3D® & A3D® interfaces. Also supports earphones, 2/4/6 channel speakers mode.
3. Support Windows 98 /Windows 2000 and Windows NT 4.0.
4. Built-in 32 OHM Earphone buffer.
5. MPU-401 Game/Midi port and legacy audio SB Pro support.
6. Downloadable Wave Table Synthesizer, supporting Direct Music®.

#### **Digital Audio (SPDIF IN/OUT)**

1. Up to 24-bit stereo 44KHz sampling rate; voice playback/recording.
2. Full-duplex playback and recording. 120dB audio quality measured.
3. Auto detectable SPDIF/IN signal level from 0.5V to 5V.

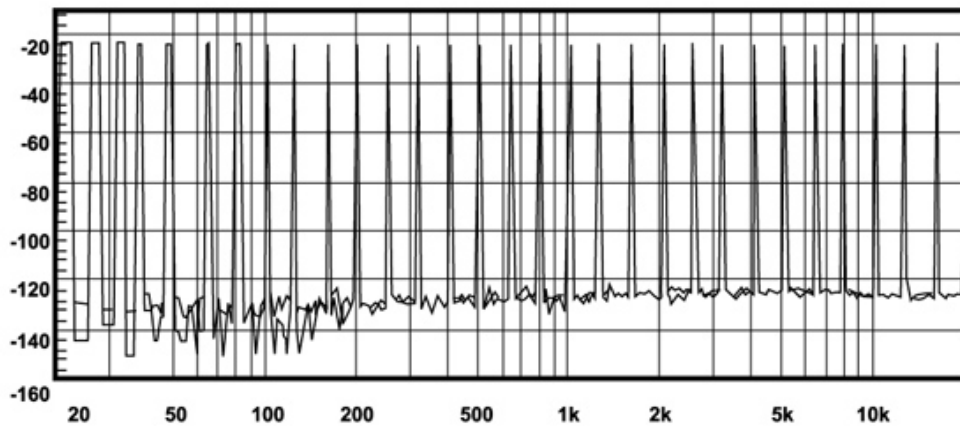

120dB audio quality in playback, recording, and bypass modes.

- **Stereo Mixer**

1. Stereo analog mixing from CD-Audio and Line-in
2. Stereo digital mixing from Voice, FM/Wave-table, and Digital CD-Audio
3. Mono mixing from MIC. Software adjustable volume.

- **Game and MIDI Interface**

1. Fully compatible with MPU-401 Midi UART and Sound Blaster Midi mode/Standard IBM PC joystick/game port (dual channels)

## **Driver Install/Un-installation**

### **WIN95/98/ME/2000 INSTALLATION**

Check page 98 for installation procedure.

### **WIN95/98/ME/2000 UN-INSTALLATION**

1. Click "Start".
2. Select "Program."

3. Find “Uninstall device drivers and applications” program in PCI audio applications.
4. Run it.
5. Follow the on-screen instructions to uninstall the device drivers or applications.

## **WINDOWS NT 4.0 INSTALLATION**

Check page 104 for installation procedure.

# **Windows Applications**

## **AUDIO RACK (FOR WDM DRIVER)**

By means of a user-friendly interface(as easy as operating your home stereo system), this PCI audio rack provides you with control over your PC’s audio functions, including the advantage of 4/6 speakers mode enable/disable, and perfect digital sound(SPDIF ) input input /output control.



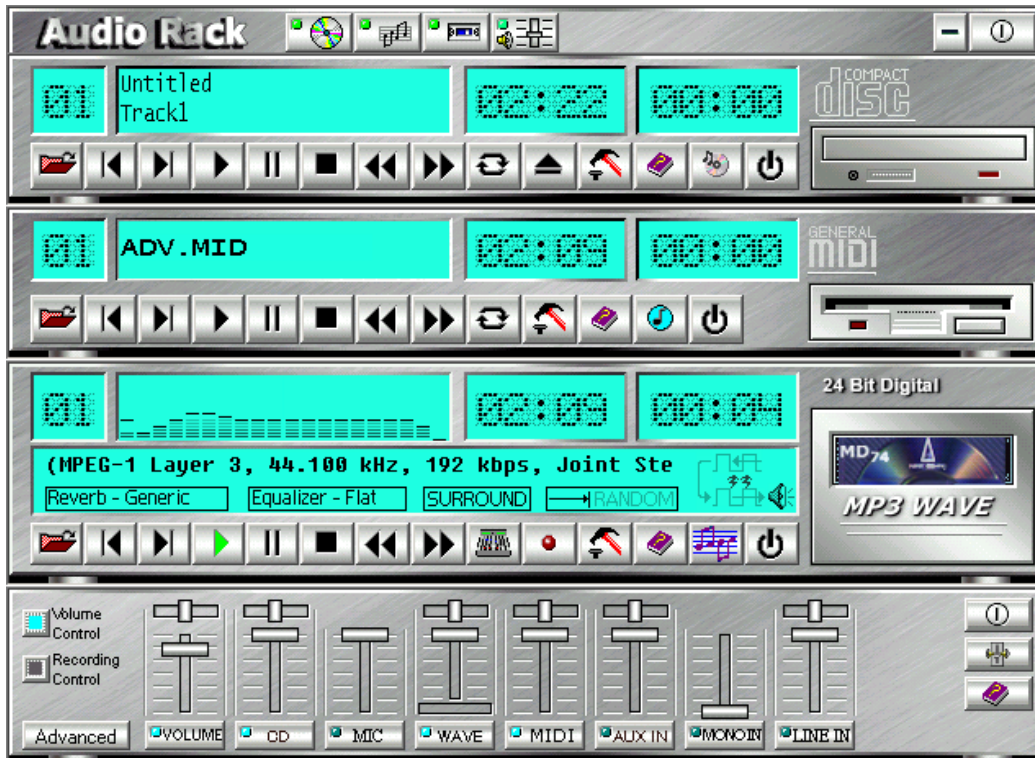

## Control Center

This Audio Rack consists of several major components:

**Control Center:** Controls the display of the PCI Audio Rack components.



**CD Player** can play standard audio CDs, and allow you to create your own playlist.

**MIDI Player** can play MIDI files, \*.mid/\*.rmi, and allow you to create your own playlist.

**MP3/Wave Player** can play mp3, wave, and MPEG-1 files. It provides EAX and equalizer to improve the sound effects when you playback the audio files. If you want to sing a song, MP3/Wave Player also provides a Karaoke function. MP3/Wave Player can record input signals and save it in a wave file as well.

**Mixer** controls the volume level of your audio inputs and outputs.

### Showing or Hiding Audio Rack Components

To show or hide a component from the display, click the component button(s) listed on the top.

## CD Player

**CD Player:** Plays standard audio CDs, and allows you to create your own playlist.

---



**Current Track field** shows the number of the currently selected CD track.

**CD title and track name field** shows CD title and track name. You can modify CD title and track name in [Playlist] function.

**Total length field** displays the total length of the selected track in minutes and seconds.

**Playback time field** displays the current playback time.

### Button Function



**Playlist:** You can select or move tracks of audio CD from and into the playlist. The title of CD and the name of tracks can be modified as well. Playlist dialog will save and show them automatically when you want to play the same CD.

record input signals and save it in a wave file as well.

**Mixer** controls the volume level of your audio inputs and outputs.

### Showing or Hiding Audio Rack Components

To show or hide a component from the display, click the component button(s) listed on the top.

---

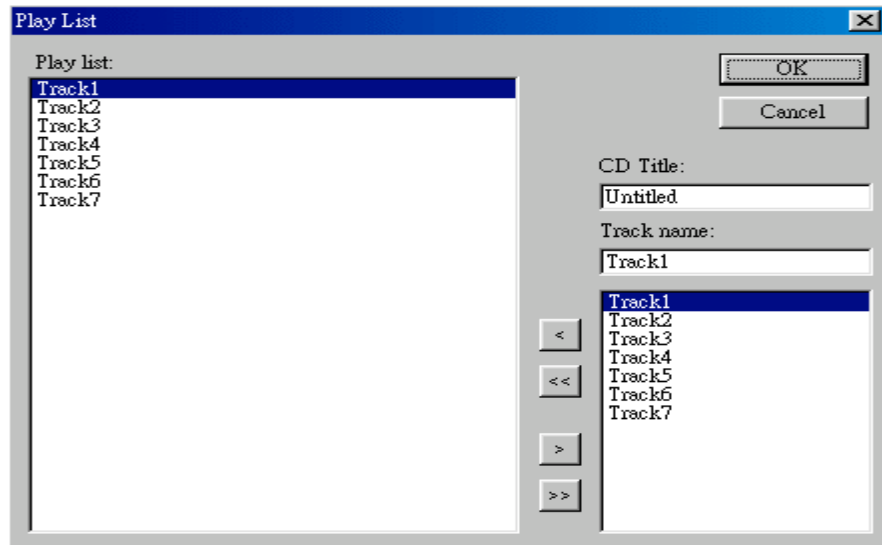

**Previous song:** Loads the previous track of playlist. If current track is the first track, the last track will become the current track.



**Next song:** Loads the next track of playlist. If current track is the last track, the first track will become the current track.



**Playback:** Starts to playback the current track.



**Pause/Restart:** Pauses or restarts the current playback action.



**Stop:** Stops playback.



**Playback backward for 10 seconds:** Playback the current to 10 seconds before.



**Playback forward for 10 seconds:** Playback the current to 10 seconds after.



**Loop:** Playbacks the tracks over and over again.



**Eject:** Opens the CD-ROM drive to change the audio CD.



**Setting:** Selects the CD-ROM drive which analog output is connected to the Analog-CD in of your sound card. If your CD-ROM does not connect to the analog CD input wire, please use device manager to change the property of your CD-ROM.



**Help:** Shows the help screen for detailed button function descriptions.



**About:** Shows software version and copyright information.



**Exit:** Stops and leaves the CD player.

## *MIDI Player*

**MIDI Player** can play MIDI files, \*.mid/\*.rmi, and allow you to create your own playlist.



**Current file field** shows the number of the currently selected MIDI files.

**File name field** shows the file name.

**Total length field** displays the total length of the selected file in minutes and seconds.

**Playback time field** displays the current playback time.

## Button Function



**Playlist:** allows you to insert, remove, and record the MIDI files into and from the playlist. You can save the playlist into a file as well.

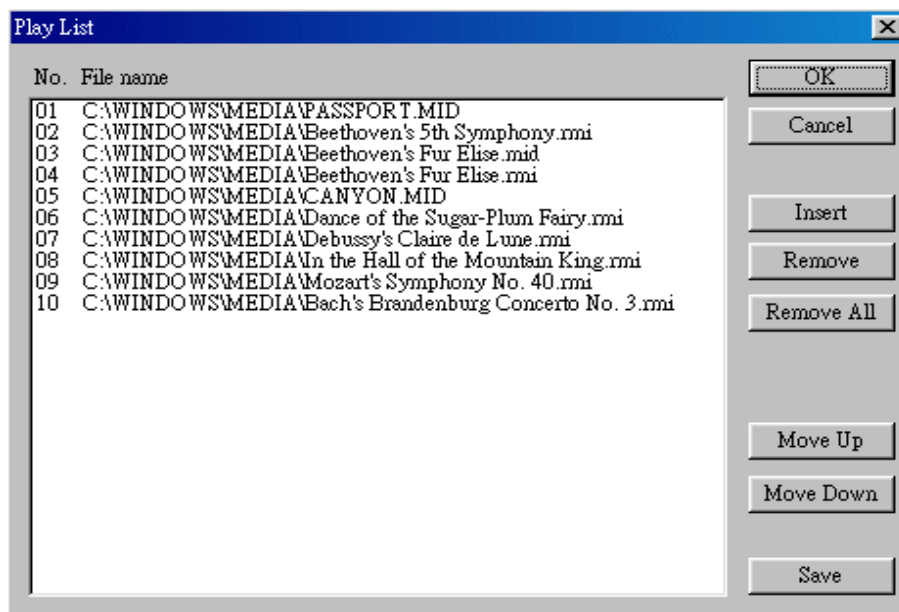

**Previous song:** Loads the previous MIDI file of playlist. If current file is the first MIDI file, the last one will become the current selection.



**Next song:** Loads the next MIDI file of playlist. If current file is the last one, the first file will become the current selection.



**Playback:** Starts to playback the current MIDI file.



**Pause/Restart:** Pauses or restarts the current playback action.

**Stop:** Stops playback.



**Playback Backward for 10 seconds:** Playback the current to 10 seconds before.



**Playback Forward 10 seconds:** Playback the current to 10 seconds after.



**Loop:** Playbacks the MIDI files of the playlist over and over again.



**Setting:** Selects the output device you want to use to playback the MIDI files.

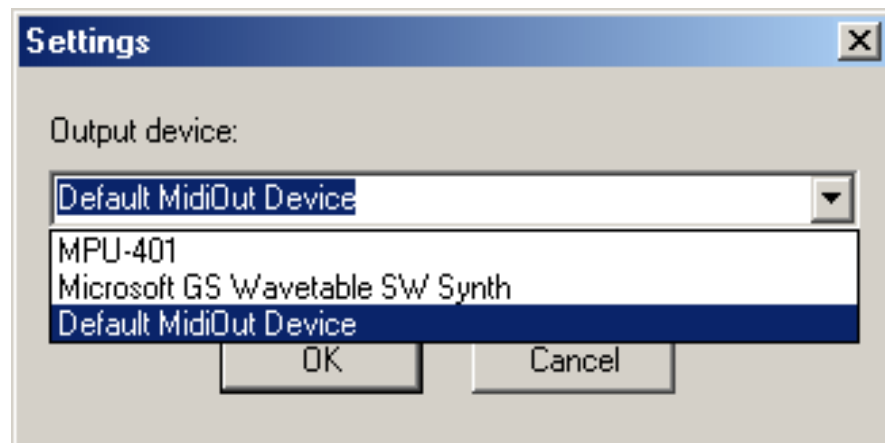

**Help:** Shows the help screen for detailed button function descriptions.



**About:** Shows software version and copyright information.



**Exit:** Stops and leaves the MIDI Player.

# MP3/Wave Player

**MP3/Wave Player** can play mp3, wave, and MPEG-1 files. It provides EAX and equalizer to improve the sound effects when you playback the audio files. MP3/ Wave Player can record input signals and save it into a wave file as well.

---



**Current file field** shows the number of the currently selected audio files in the playlist.

**Frequency display field** shows the frequency distribution.

**Total length field** displays the total length of the currently selected file in minutes and seconds.

**Playback time field** displays the current playback time.

**File name and status field** displays the file name, audio format, sound effects selection, playback mode, Karaoke mode, and SPDIF status.

## Button Function



**Playlist:** Playlist allows you to insert, remove, and record the audio files into and from the playlist. The audio files include wave, MP3, and MPEG-1 encoding files.

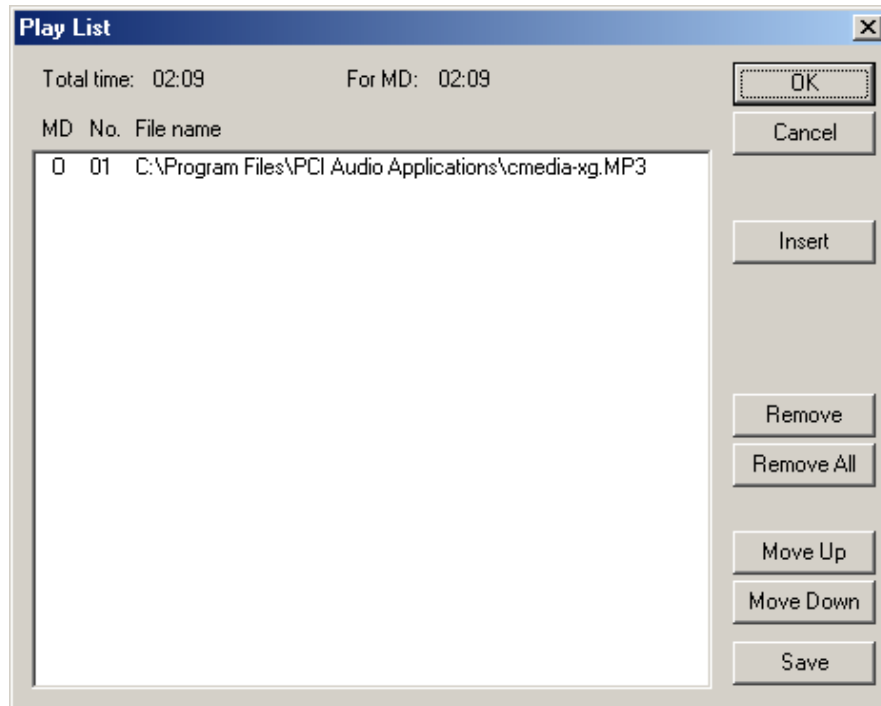

**Previous song:** Loads the previous audio file of playlist. If current file is the first file, the last one will become the current selection.



**Next song:** Loads the next audio file of playlist. If current file is the last one, the first file will become the current selection.



**Playback:** Starts to playback the current audio file.



**Pause/Restart:** Pauses or restarts the current playback action.



**Stop:** Stops playback.



**Playback backward for 10 seconds:** Playback the current to 10 seconds before.



**Playback forward for 10 seconds:** Playback the current to 10 seconds after.





**Sound effector.** You can use this function to modify the special effect of the song being played. Currently, these effectors can only be used for 44.1 KHz, 16-bit format.

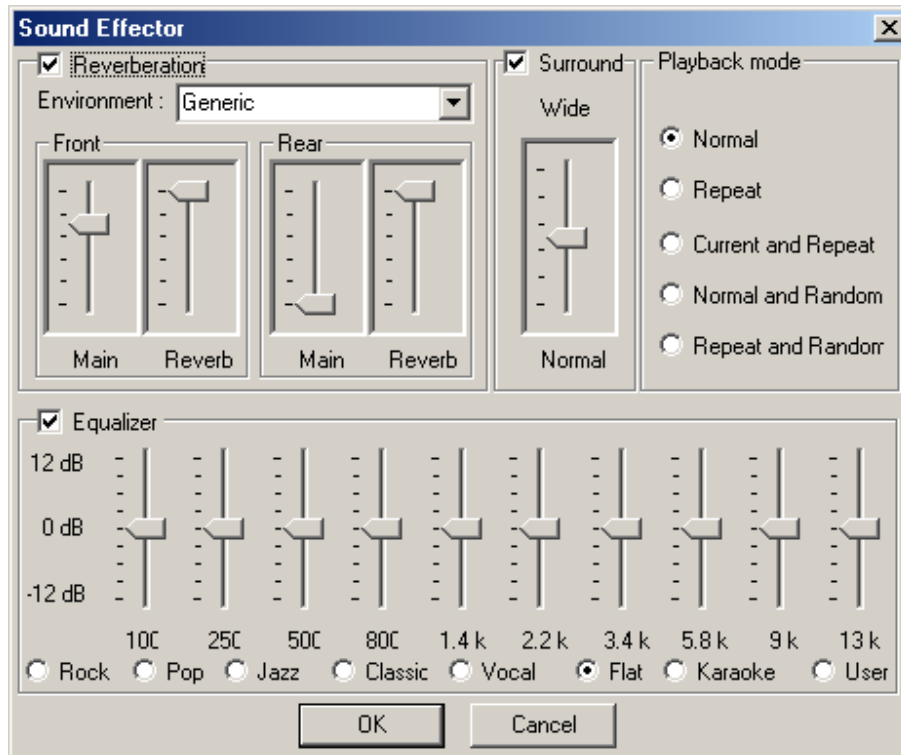

**Setting:** You can use this dialog to set the playback parameters and the status of SPDIF IN/OUT. For more information of SPDIF, please refer to the Appendixes C and D.

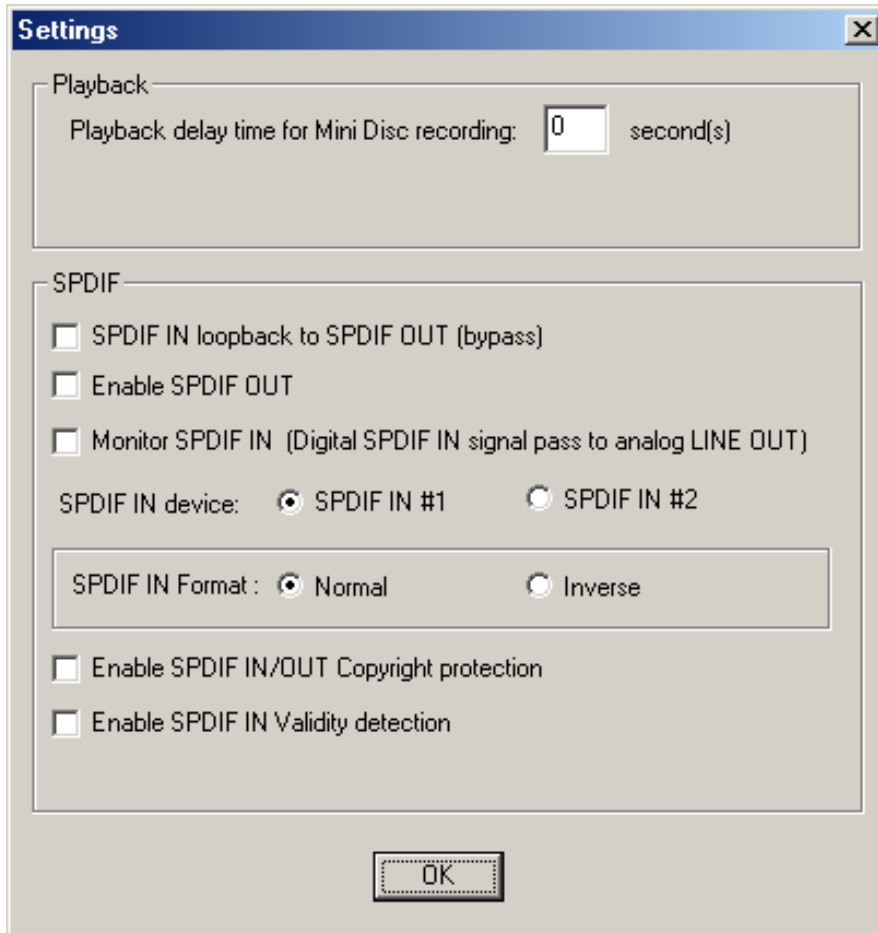

**Recording:** You can use this function to record a wave file from any recording channel.

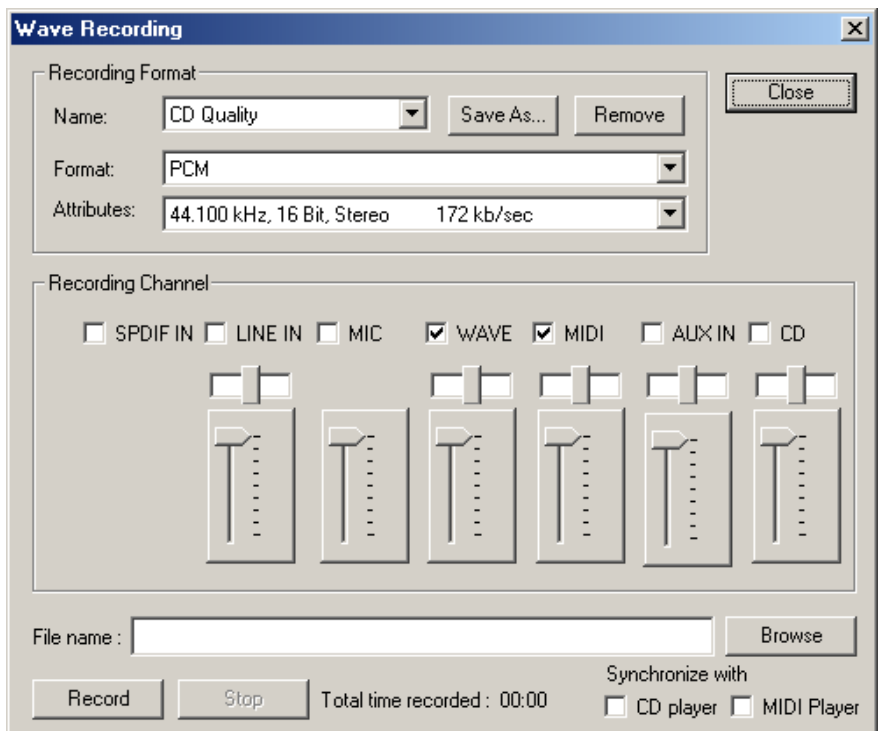



**Help:** Shows the help screen for detailed button function descriptions.



**About:** Shows software version and copyright information.



**Exit:** Stops and leaves the MP3/Wave Player.

## Mixer

### Volume Control



For each output signal, the control slider regulates the loudness whereas a horizontal slider the balance between the two speakers. The mute button can temporarily stop the output without changing slider positions. A button with a lit LED means the output is available, and vice versa. Several output signals can usually be enabled at once.

**Volume:** This is the master control over all outputs. The power of an output signal is determined by both of the volume slider and the slider for the individual output. To modify all the outputs, adjust the volume slider. To change individual output(s), adjust its(their) slider(s).

**CD:** Regulates the CD drive audio input level.

**MIC:** Regulates the input level of microphone.

**WAVE:** Regulates wave (voice) playback levels.

**MIDI:** Regulates the MIDI music play level.

**AUX IN:** Regulates the Auxiliary input play level.

**MONO IN:** Regulates the Mono input level.

**LINE IN:** Regulates the Line-In levels.

**Advanced:** Regulates the advanced settings.

## Recording Control



For each input signal, a control slider regulates the loudness whereas a horizontal slider the balance between the two channels. The select button can temporarily select input signal without changing slider positions. A button with a lit LED means it is available, and vice versa.

**CD:** Regulates the CD drive audio input level.

**MIC:** Regulates the input level of microphone.

**WAVE:** Regulates wave (voice) playback level.

**FM:** Regulates the FM music play level.

**AUX IN:** Regulates the Auxiliary input play level.

**LINE IN:** Regulates the Line-In level.

**SPDIF IN:** Enables the recording from SPDIF in. SPDIF-in is mutually exclusive with other input signals.

**Advanced:** Regulates the advanced settings.

## Advanced - SPDIF

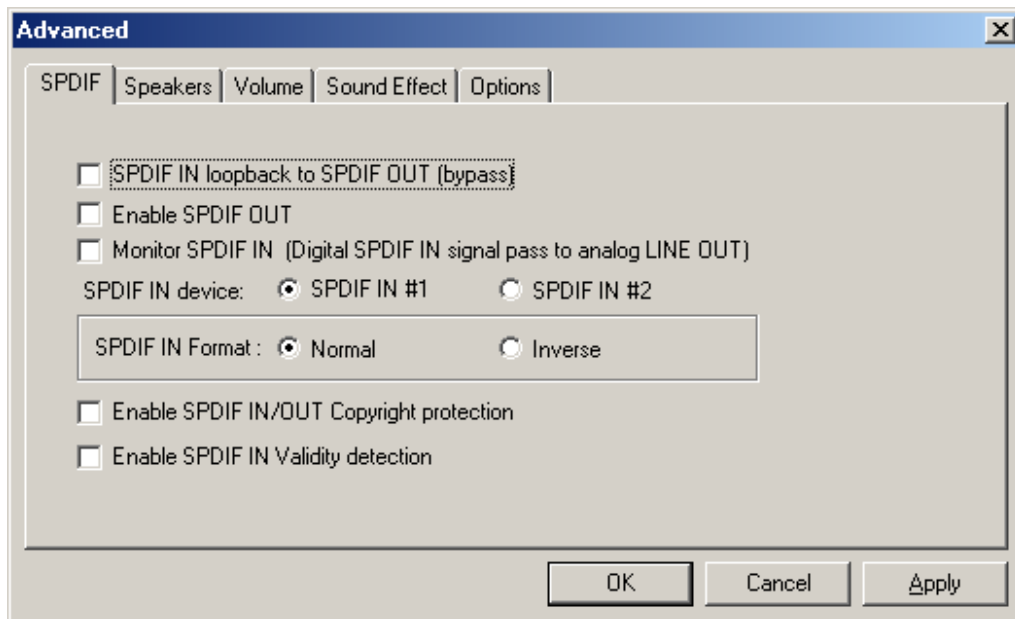

SPDIF dialog provides a full control over SPDIF IN/OUT functions. You can use these settings to connect your computer to other pieces of audio device, such as: Mini Disc players, amplifiers...etc. For more information of SPDIF, please refer to the Appendixes C and D.

## Advanced - Speakers

Speakers dialog provides an interface allowing you to set your speakers configurations. First, You should make sure what model type your speakers are, and what the correct configurations are. And this dialog also shows the current status and functions of the phone jacks of your audio device. You can always refer to this to make sure whether or not the connections of your speakers and microphone are correct.

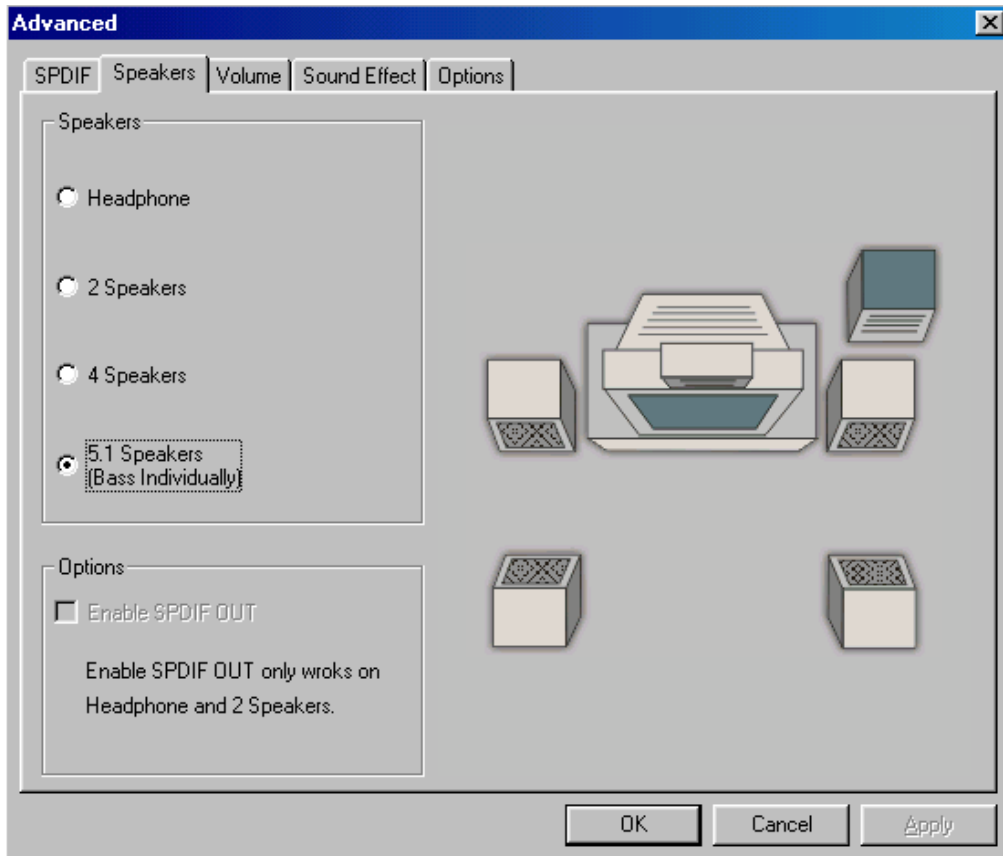

## Advanced - Volume

Volume dialog provides a full control over the volume of the six channels digital output. You can adjust the volume of your speakers in this dialog. Please note that the volume of analog path is not controlled by this function.

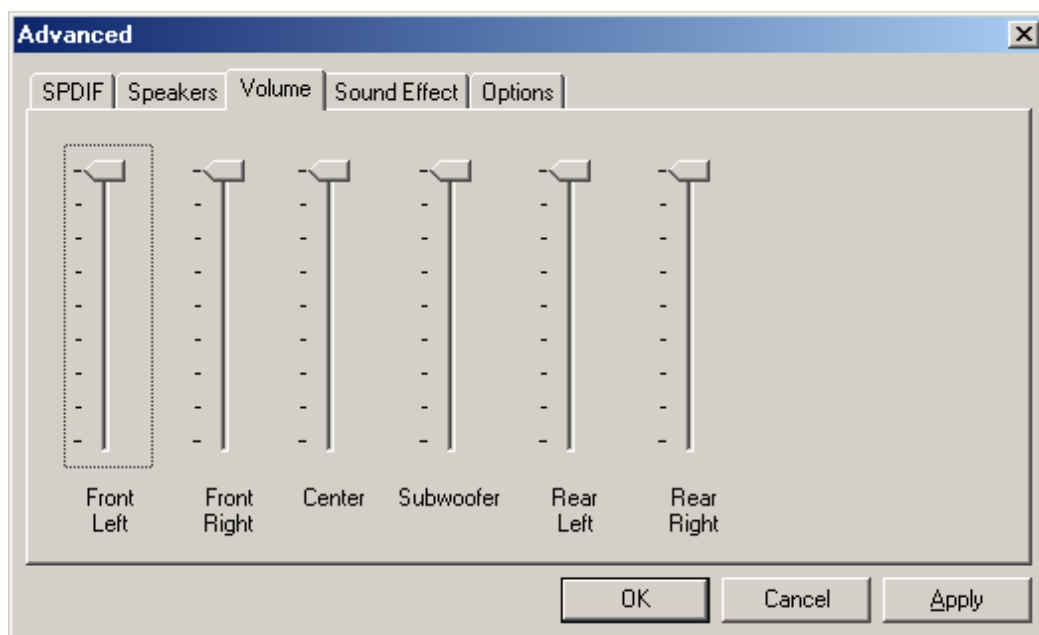

## Advanced - Sound effects

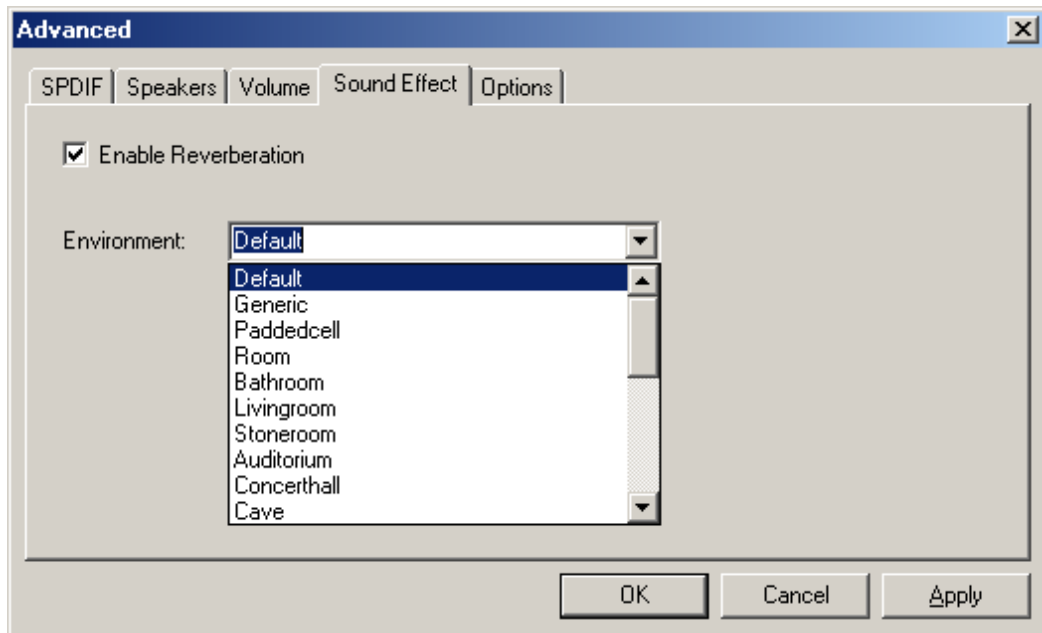

Sound effects dialog allows you to modify the special effects of the song and game being played. Currently, these effectors can only be used for the player or the game which utilizes DirectSound 2D and 3D to playback their music.

## Advanced - Options

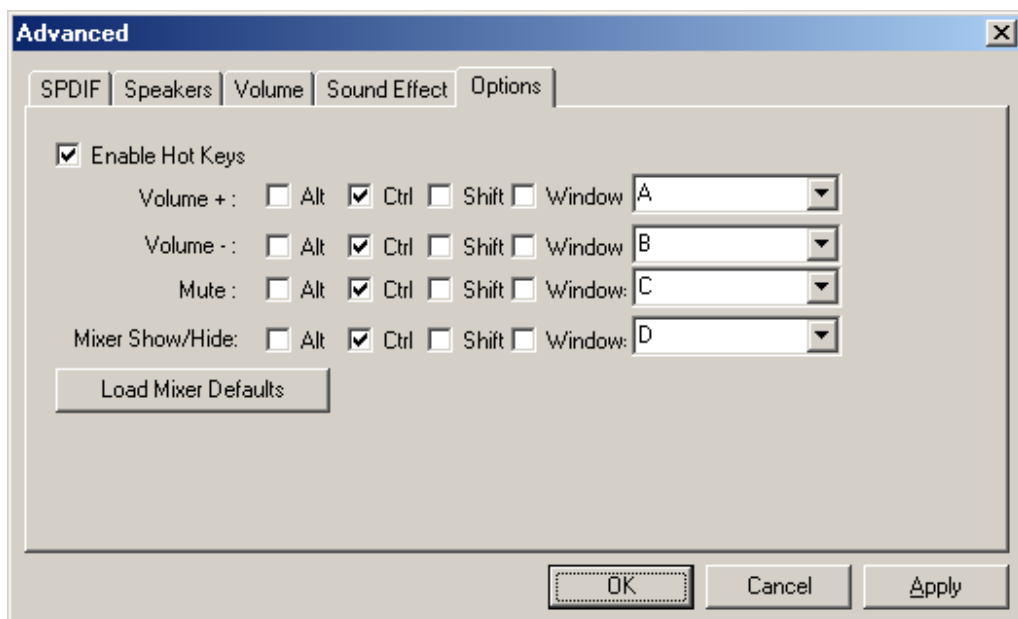

Options dialog provides a hot key setting to control the Mixer in an easy way. Please note that other applications might be affected by this if you use the same hot key setting.

Please use 'Load Mixer Defaults' to change all settings to default values.

## **MULTI-CHANNEL AUDIO DEMO**

CMI8738 PCI-Based C3DX Audio Chip provides many advanced functions, such as:

- \* HRTF-based CRL<sup>®</sup> 3D extensional/positional audio; API compatible with Microsoft<sup>®</sup> DirectSound<sup>®</sup> 3D and Aureal<sup>®</sup> A3D API. Supports rear side speakers; C3DX positional audio in 4/6CH speakers mode. (5.1 CH, DVD AC-3<sup>®</sup> home theater available).
- \* Compatible with EAX<sup>™</sup> (Environment Audio eXtention).
- \* KARAOKE ascending/descending keys, Echo.
- \* Supports Center/Subwoofer side speakers. (for chip model 039 and the following models).

To let everyone avail himself/herself of the above functions, a user-friendly interface(Multi-Channel Audio Demo) was designed with the following functions:

1. 4 CH speakers mode, including Demo1 and Demo2.
2. EAX<sup>™</sup> (Environment Audio eXtention) support.
3. HRTF-based CRL<sup>®</sup> 3D extensional/positional audio.
4. KARAOKE ascending/descending keys, Echo, and microphone ascending/descending keys.
5. 6 CH speakers mode, including Demo1 and Demo2. (for chip models 039 and the following models).



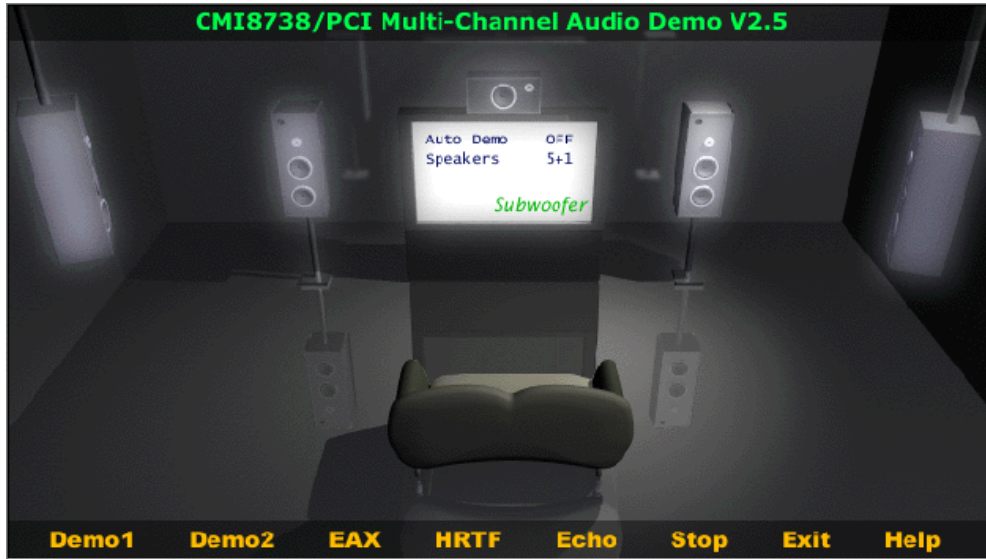

## Speakers and Microphone Connection

Before running this demo program, you have to connect the speakers to the correct phone jacks.

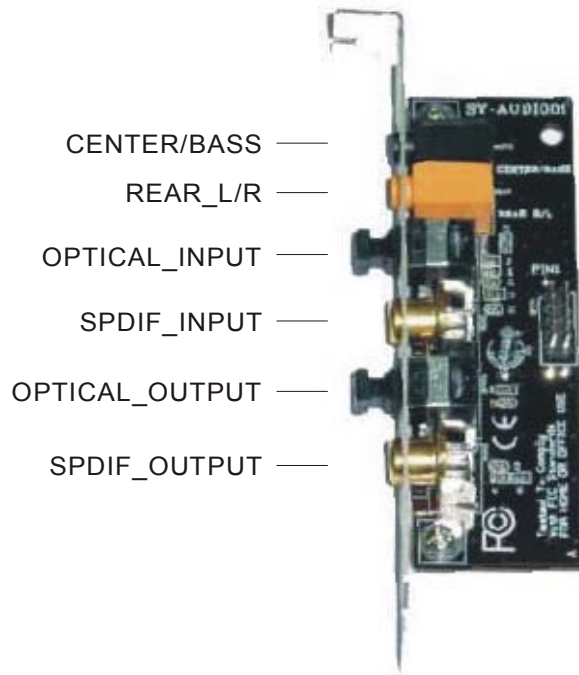

## **How to Enable 4/ 5/ 5.1 Speakers**

You have to activate the "Mixer" program and enable the "4-Speaker", "5 Speakers", or "5.1 Speakers" mode to let the audio driver recognize your rear or center/subwoofer speakers, and have the front/rear/center/subwoofer speakers work. The audio driver will activate the audio chip to output different sounds from the front/rear/center/subwoofer speakers based on different playback formats. For more information, please refer to the 5.1.5 Mixer Advanced-Speakers dialog.

## **How to Adjust the Microphone Volume**

You have to use the microphone when availing yourself of the "Echo" function. If the microphone is on and is very close to the speakers, it will cause feedback between the two. Also, unusual high frequencies or buzzing sounds might be heard from the speakers. To avoid this, you have to adjust the microphone volume in both recording and playback. Sometimes you might have to adjust the main and Wave volume as well. Please left-click the mouse to adjust the microphone(MIC) in both Volume and Recording Control.

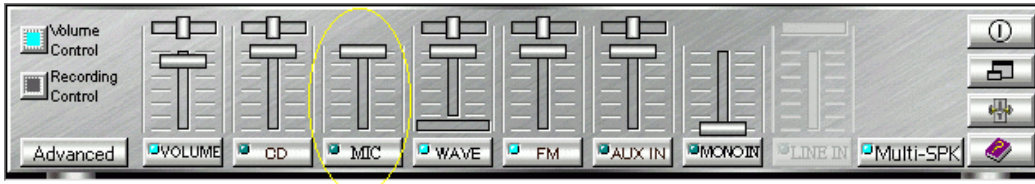

## Test Your Speakers Connection

To make sure that the front and the rear speakers are correctly connected, you can use the following program to testify individual speaker output. Move cursor to whichever speaker you want to test and left-click the mouse. If the setup is correct, you can hear music coming from that speaker alone. Each music output is different for distinction.

The Center and Subwoofer speakers are only supported by chip model 039 and the following models.



## Demonstrations

Demo1 and Demo 2 are specially design for 4-speaker system demonstration. Select Demo 1 and/or Demo 2 by left-clicking the mouse. Sit back and relax, and let the music take control.

How was it like? Isn't it fantastic??? If you don't have 4-speaker system, hurry up and buy yourself one right away!



## EAX

Monotonous footsteps generate distinctive sound effects in different environments. In this Demo, you can hear a lady wearing high heels walk in different surroundings: generic environment, bathroom, sewer pipe, and underwater. Left-click the mouse to activate this Demo and feel the differences.





## HRTF

HRTF stands for Head Related Transfer Functions, and it is a set of audio filters varying locations of sound effects (spatial hearing cues) in three-dimension measured from the listener's eardrum.

This technology and special digital signal processing are used to recreate spatial hearing cues, making our ears hear realistic and three-dimensional sounds coming from a pairs of loud speakers or headphones.

When you activate this Demo, you can hear a helicopter fly around you clockwise for three times.

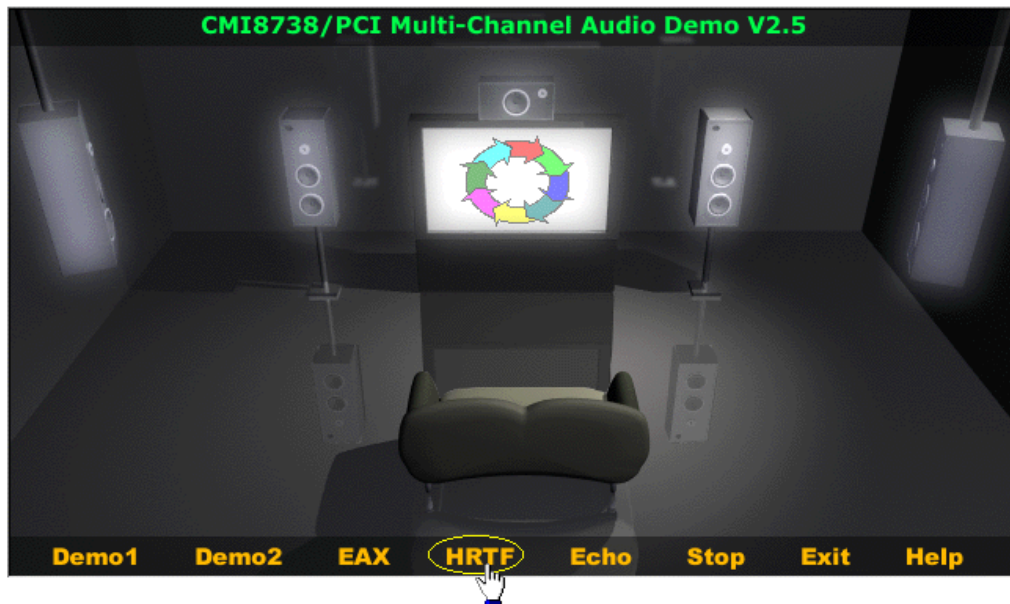

## Echo

Like to sing along with Karaoke? It might occur to you to use your PC for this. However, when you turn on the microphone, play the song, and ready to sing, you see that the effect is not as good as expected. Why? Echo is the answer. To help you solve this problem, this demo is designed to include the Echo function. Please left-click the upper right of the demo screen as shown below, and choose your own music file to play. Please note the file type has to be MP3 file.

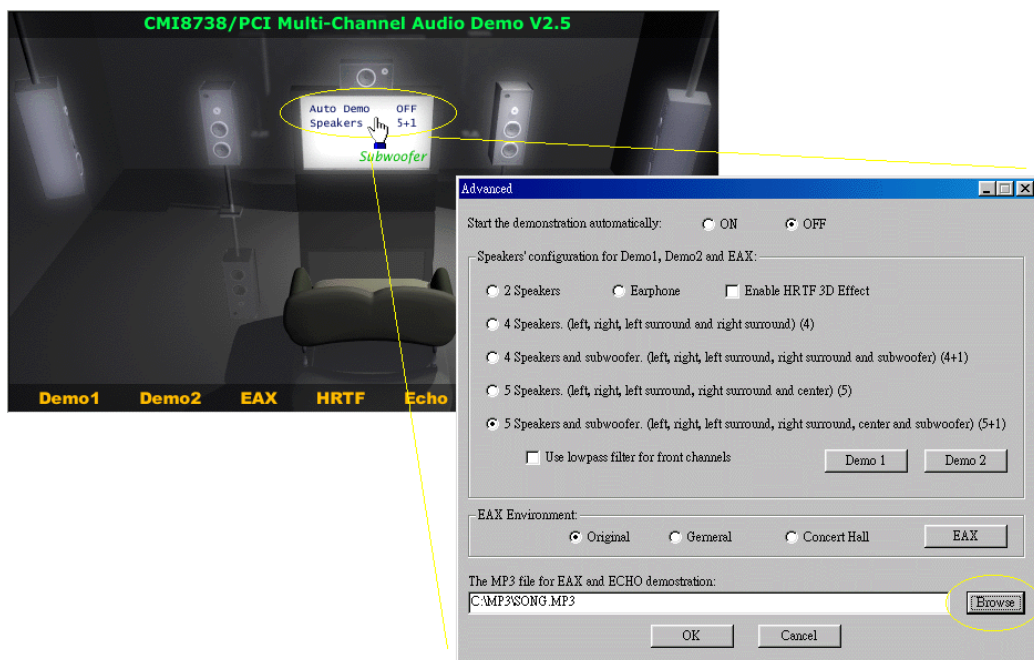

Please left-click "Echo" to activate the function. For pitch adjustment, please use  $\uparrow$  and  $\downarrow$  keys on the keyboard. For microphone pitch adjustment, please use "+" and "-" keys on the numeric keyboard. To resume the original, please use  $\leftarrow$  and  $\rightarrow$  keys.

## Using MP3/Wave Player to Work With Mini Disc Recording

MP3/Wave Player is an easy and powerful tool for Mini Disc recording. Besides allowing you to create your own playlist, it also provides a control interface of SPDIF IN/OUT of C-Media's sound card. The following 4 steps can help you create your album into Mini Disc easily.

- STEP 1.** Using optical fiber to connect the sound card and the MD player. MD player will start to do the recording and turning on the SYNC mode. (See above 1. Output A. PC to MD player)
  
- STEP 2.** To execute MP3/Wave Player and modify the play list. You should select those files whose format can be recognized by the MD Player. You can also change the sound effects if you like. (See also 5.1.4.)
  
- STEP 3.** In 'Setting' dialog, check 'Enable SPDIF-OUT', input the playback delay time, and select 5 Vp-p (Optical). Please note that in playback, if there is no lapse longer than three seconds between each track, the MD player can not recognize the tracks and will record all of them into one. It is recommended that you set the lapse time to 3~5 seconds to meet all type of MD player requirements.

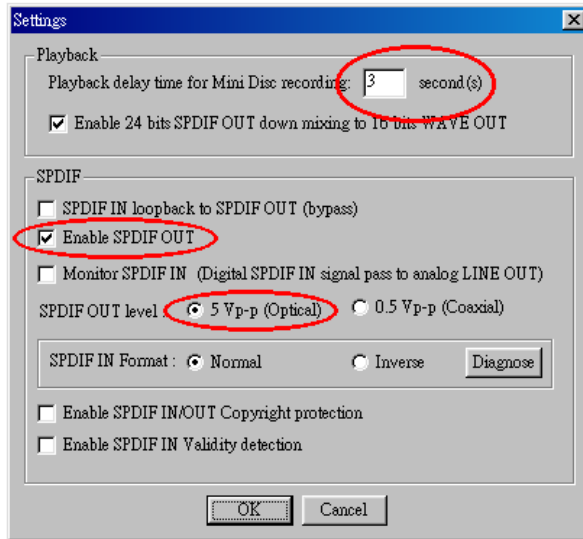

**STEP 4.** Start to play the songs. You will see that the MD player starts to do the recording as well.



## Recording from SPDIF-IN

The optical module can be connected to SPDIF-IN device, such as the portable CD-ROM player, the CD-ROM drive, the MD Player, to name a few. The Windows application and the MP3/Wave player can be used to do the recording of the signal from SPDIF-IN. The recording steps are as follows:

- STEP 1.** Use optical fiber or coaxial to connect the sound card and SPDIF-IN device. (See also Appendix C 2. Input)
- STEP 2.** Execute MP3/Wave Player. In 'Setting' dialog, select 5 Vp-p (Optical) or 0.5 Vp-p (Coaxial).
- STEP 3.** In 'Wave Recording' dialog, you should select the recording format and SPDIF-IN recording channel. Then input the file name. Before recording, please turn on your SPDIF-IN device and start to playback. Finally, press 'Record' to start the recording process.

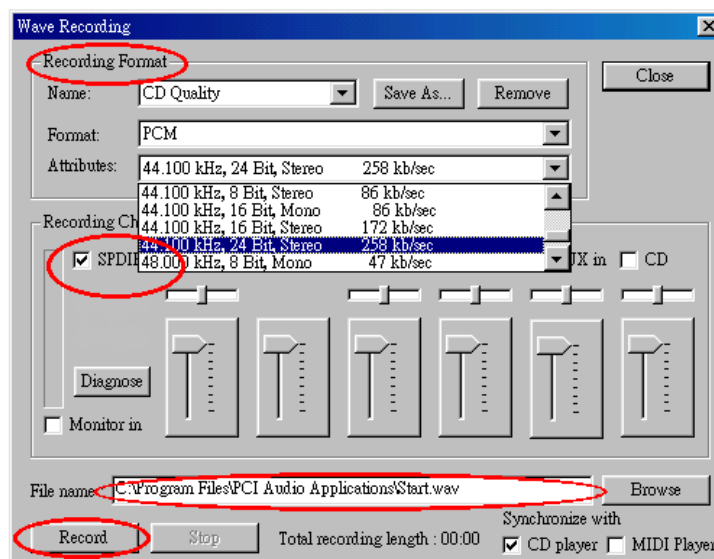

## **APPENDIX C**

### **How to contact us:**

- If you are interested in our products, please contact the SOYO sales department in the region you live.
- If you require Technical Assistance, please contact our Technical Support in the region you live.

SOYO prefers Email as communication medium, remember to *always add to the email the country that you live in.*

### **TAIWAN**

SOYO COMPUTER INC.

---

No. 21 Wu-Kung 5 Rd., Hsin  
Chuang City, Taipei Hsien,  
Taiwan, R.O.C

---

TEL: 886-2-22903300

FAX: 886-2-22983322

<http://www.soyo.com/>

Email: [info@mail.soyo.com](mailto:info@mail.soyo.com)

### **JAPAN**

SOYO COMPUTER

---

SOYO BLDG, 1-23-14,  
Hyakunincho, Shinjyuku-ku,  
Tokyo Japan 169-0073

---

TEL: 81-3-3368-2188

FAX: 81-3-3368-2199

<http://www.soyo.co.jp/>

Email: [support@soyo.co.jp](mailto:support@soyo.co.jp)

### **USA**

SOYO INC.

---

41484 Christy Street, Fremont,  
CA 94538, USA

---

TEL: 1-510-226-7696

FAX: 1-510-226-9218

<http://www.soyousa.com/>

Email : [sales@soyousa.com](mailto:sales@soyousa.com)

### **CHINA**

GING MEI JEI LTD

---

Room 304, Phoenix Mansion, No.  
165 Haidian Road, Haidian  
Distnct, Beijing 100080, China

---

TEL: 86-10-6251-0089

FAX: 86-10-6251-0311

<http://www.soyo.com.cn/>

Email: [soyo@public.bat.net.cn](mailto:soyo@public.bat.net.cn)

### **GM**

SOYO Deutschland GmbH  
(SAAT Technology GmbH)

---

August-Wilhelm-Kuhnholz-Str.  
15 D-26135 Oldenburg (Oldb),  
Germay

---

TEL: 49-441-209-100

FAX: 49-441-203-442

<http://www.soyo.de/>

Email: [sales@soyo.de](mailto:sales@soyo.de)

### **KOREA**

SOYO TECHNOLOGY CO.,  
LTD.

---

3 rd, F1, Wonhyo Bldg, 46-1,  
Wonhyoro 3 Ga, yongsan Ku,  
Seoul Korea

---

TEL: 882-716-2850

FAX: 882-704-2619

<http://www.soyo.co.kr/>

Email: [soyo@soyo.co.kr](mailto:soyo@soyo.co.kr)

**Hong Kong**

Soyo (H.K.) Ltd.

---

5C, Big Star Centre, 8 Wang  
Kwong Road, Kowloon Bay,  
Kowloon, HK

---

TEL: 852-2710-9810

FAX: 852-2710-9078

<http://www.soyo.com.hk/>

Email: [soyo@hkstar.com](mailto:soyo@hkstar.com)