



SY-7VDA

Motherboard

VIA Cyrix III, Intel Pentium® III & Celeron™

Processor supported

VIA PRO266 AGP/PCI Motherboard

66/100/133 MHz Front Side Bus supported

ATX Form Factor

User's Manual

Copyright © 2001 by Soyo Computer Inc.

Trademarks:

Soyo is the registered trademark of Soyo Computer Inc. All trademarks are the properties of their owners.

Product Rights:

All names of the product and corporate mentioned in this publication are used for identification purposes only. The registered trademarks and copyrights belong to their respective companies.

Copyright Notice:

All rights reserved. This manual has been copyrighted by Soyo Computer Inc. No part of this manual may be reproduced, transmitted, transcribed, translated into any other language, or stored in a retrieval system, in any form or by any means, such as by electronic, mechanical, magnetic, optical, chemical, manual or otherwise, without permission in writing from Soyo Computer Inc.

Disclaimer:

Soyo Computer Inc. makes no representations or warranties regarding the contents of this manual. We reserve the right to amend the manual or revise the specifications of the product described in it from time to time without obligation to notify any person of such revision or amend. The information contained in this manual is provided to our customers for general use. Customers should be aware that the personal computer field is subject to many patents. All of our customers should ensure that their use of our products does not infringe upon any patents. It is the policy of Soyo Computer Inc. to respect the valid patent rights of third parties and not to infringe upon or to cause others to infringe upon such rights.

Restricted Rights Legend:

Use, duplication, or disclosure by the Government is subject to restrictions set forth in subparagraph (c)(1)(ii) of the Rights in Technical Data and Computer Software clause at 252.277-7013.

About This Guide:

This Quick Start Guide can help system manufacturers and end users in setting up and installing the Motherboard. Information in this guide has been carefully checked for reliability; however, to the correctness of the contents there is no guarantee given. The information in this document is subject to amend without notice.

For further information, please visit our **Web Site** on the Internet. The address is "<http://www.soyo.com.tw>".

Edition: May 2001

Version 1.2

7VDA SERIAL

FC Tested To Comply
With FCC Standards
FOR HOME OR OFFICE USE

100% POST CONSUMER
RECYCLED PAPER

Table of Contents

CHAPTER 1 MOTHERBOARD DESCRIPTION1

- 1-1 INTRODUCTION1
- 1-2 KEY FEATURES1
- 1-3 HANDLING THE MOTHERBOARD4
- 1-4 ELECTROSTATIC DISCHARGE PRECAUTIONS5
- 1-5 SY-7VDA MOTHERBOARD LAYOUT6
- 1-6 SY-7VDA MOTHERBOARD COMPONENTS.....7
- 1-7 MICROPROCESSOR.....9
- 1-8 MEMORY.....10
- 1-9 CHIPSET 11
- 1-10 I/O INTERFACE CONTROLLER15
- 1-11 HARDWARE MONITOR.....18
- 1-12 WAKE ON LAN TECHNOLOGY19

CHAPTER 2 HARDWARE INSTALLATION.....20

- 2-1 PREPARATIONS20
- 2-2 UNPACKING THE MOTHERBOARD21
- 2-3 INSTALLATION GUIDE22
 - 2-3.1 *CPU Installation..... 23*
 - 2-3.2 *DDR RAM Memory Module Installation..... 26*
 - 2-3.3 *Motherboard Connector..... 28*
 - 2-3.4 *CMOS Clear (JP5) 42*
 - 2-3.5 *Power On 43*
 - 2-3.6 *Quick BIOS Setup..... 44*
 - 2-3.7 *Troubleshooting at First Start 46*
 - 2-3.8 *Power Off..... 49*

CHAPTER 3 BIOS SETUP UTILITY50

- 3-1 SOYO COMBO SETUP53
- 3-2 STANDARD CMOS SETUP56

3-3	ADVANCED BIOS FEATURES.....	59
3-4	ADVANCED CHIPSET FEATURES.....	63
3-5	INTEGRATED PERIPHERALS	71
3-6	POWER MANAGEMENT SETUP	79
3-7	PNP/PCI CONFIGURATIONS	85
3-8	PC HEALTH STATUS.....	88
3-9	LOAD FAIL-SAFE DEFAULTS.....	90
3-10	LOAD OPTIMIZED DEFAULTS.....	91
3-11	SET SUPERVISOR PASSWORD.....	92
3-12	SET USER PASSWORD	93
3-13	IDE HDD AUTO DETECTION	94
CHAPTER 4 THE SOYO CD		96

Chapter 1

MOTHERBOARD DESCRIPTION

1-1 INTRODUCTION

The **SY-7VDA** AGP/PCI Motherboard is a high-performance, Socket 370 support ATX form-factor system board. The **SY-7VDA** uses VIA Chipset technology and supports Socket 370 class processors. This Motherboard is fully compatible with industry standards and adds many technical enhancements.

1-2 KEY FEATURES

➤ CPU SUPPORT

The SY-7VDA supports a wide range of INTEL CPUs:

- FSB 66MHz: Celeron™(400-700MHz)
- FSB 100MHz: Pentium® III (500-850MHz)
- FSB 133MHz: Pentium® III (533MHz-1.13GHz)

Supports Via Cyrix processors

- FSB 100MHz: Cyrix III (500MHz-600MHz)

New released Intel Socket 370 CPUs will very likely be supported by the SY-7VDA as well.

➤ CPU SETTINGS

The SY-7VDA provides the user with a very complete and convenient CPU setting environment. The CPU settings are all adjusted through the special SOYO COMBO page in the BIOS, therefore rendering the use of jumpers obsolete.

■ CPU FSB Frequency

The SY-7VDA supports an incredibly wide range of CPU FSB frequency settings:

66, 75, 81, 83, 90, 95, 100, 105, 110, 112, 113, 115, 117, 118, 120, 122, 124, 126, 133, 135, 137, 138, 140, 142, 144, 150 and 155 MHz.

This ensures that the SY-7VDA has an overwhelming overclocking potential.

■ **CPU Multiplier**

The SY-7VDA supports a wide range of multipliers:

2.0x, 2.5x, 3.0x, 3.5x, 4.0x, 4.5x, 5.0x, 5.5x, 6.0x, 6.5x, 7.0x, 7.5x and 8.5x

➤ **EXPANDABILITY**

The SY-7VDA provides all the standard expansion slots, and many more additional expansion features:

◆ **Expansion slots**

- 1 x 32-bit bus master AGP slot
- 5 x 32-bit bus master PCI slots

◆ **Enhanced IO**

- Floppy disk controller
- 2x EIDE controllers with support for up to 4 Ultra DMA 33/66 /100 devices
- Standard/EPP/ECP parallel port
- 2x 16550 compatible serial ports
- IrDA compatible infrared port
- 6x USB (Universal Serial Bus) connectors
- PS/2 mouse connector
- PS/2 keyboard connector

➤ **ADVANCED FUNCTIONS**

The SY-7VDA supports advanced functions such as:

■ **Wake-On-LAN**

Supports Wake-On-LAN (*Some advanced network cards can wake the system up over the network, the WOL connector is provided by the SY-7VDA to support this function*).

■ **Multiple boot**

The SY-7VDA supports booting from devices such as CD-ROM.

■ **Power on by modem or alarm**

If the SY-7VDA system is in suspend mode, it can be switched back on through the modem or RTC alarm through this function. This opens a lot of possibilities, such as remote access that switches the system on only after the modem receives a call.

➤ **FAIL SAFE**

The SY-7VDA comes with added functionality to make managing the system easy and safe

◆ **Hardware Monitor**

The integrated Hardware Monitor IC and Hardware doctor software enables the user to monitor system voltages, temperatures and FAN speeds. This makes sure that the user is full control of the system

◆ **Power Failure Resume Function**

This function can be set in the BIOS, and determines whether the system will automatically turn on again after a power failure. This function is indispensable for server systems that need to always be on line.

◆ **5VSB Indicator**

This green LED gives an indication of the presence of the 5V Standby voltage. This voltage is always fed into the motherboard and is used for functions such as WOL.

➤ **SOYO Bonus Pack CD-ROM**

➤ **COMPLIANCE**

The SY-7VDA complies with all important industry standards. The

following underlines the reliability of the SY-7VDA, a motherboard to trust.

- PC99, ACPI compliant

➤ **USER FRIENDLY**

- SOYO Combo Setup
- Jumperless design
- You can set up the following options through the BIOS setup
 - CPU FSB frequency
 - CPU multiplier
 - CPU Vcore voltage
 - PCI clock
 - AGP Clock
 - DDR RAM Clock

1-3 HANDLING THE MOTHERBOARD

To avoid damage to your Motherboard, follow these simple rules while unpacking:

- Before handling the Motherboard, ground yourself by grasping an unpainted portion of the system's metal chassis.
- Remove the Motherboard from its anti-static packaging. Hold the Motherboard by the edges and avoid touching its components.
- Check the Motherboard for damage. If any chip appears loose, press carefully to seat it firmly in its socket.



Warning: Do not apply power if the Motherboard appears damaged. If there is damage to the board, contact your dealer immediately.

1-4 ELECTROSTATIC DISCHARGE PRECAUTIONS

Make sure to ground yourself before handling the Motherboard or other system components. Electrostatic discharge can easily damage the components. Note that you must take special precautions when handling the Motherboard in dry or air-conditioned environment.

To protect your equipment from electrostatic discharge, take the following precautions:

- Do not remove the anti-static packaging until you are ready to install.
- Ground yourself before removing any system component from its protective anti-static packaging. (To ground yourself, grasp the expansion slot covers or other unpainted portions of the computer chassis.)
- Frequently ground yourself while working or use a grounding strap.
- Handle the Motherboard by its edges and avoid touching its components.

1-5 SY-7VDA MOTHERBOARD LAYOUT

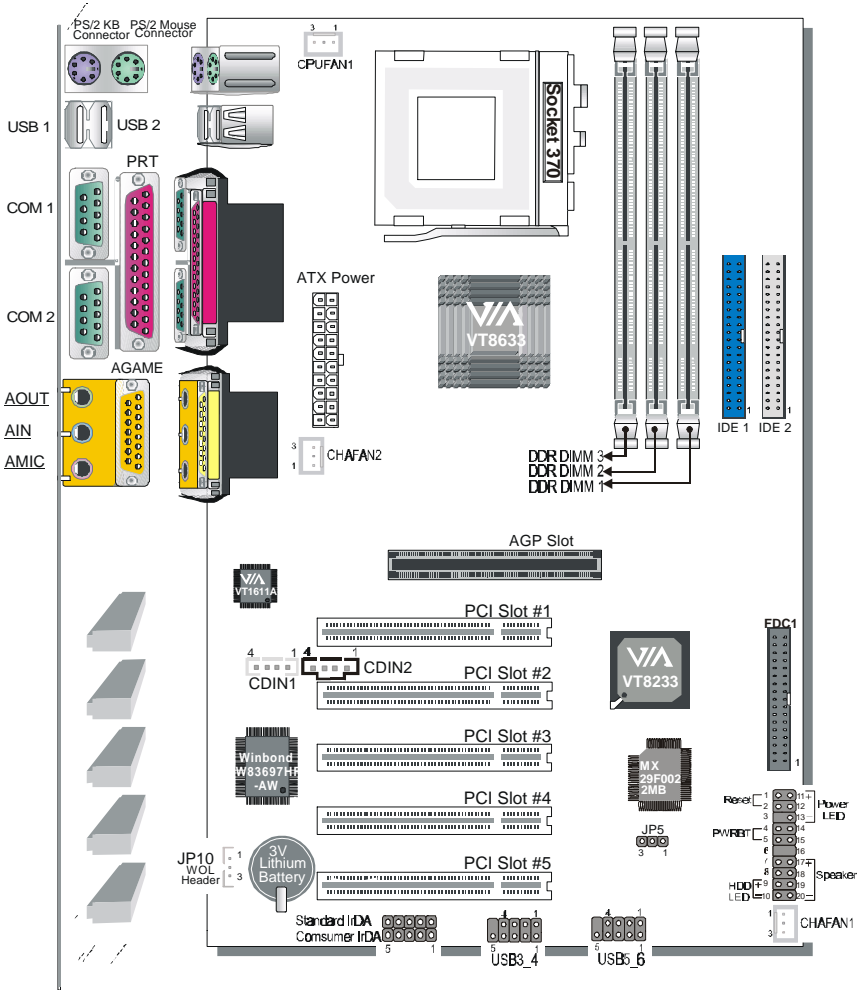

Back Panel

SY-7VDA Platform

1-6 SY-7VDA MOTHERBOARD COMPONENTS

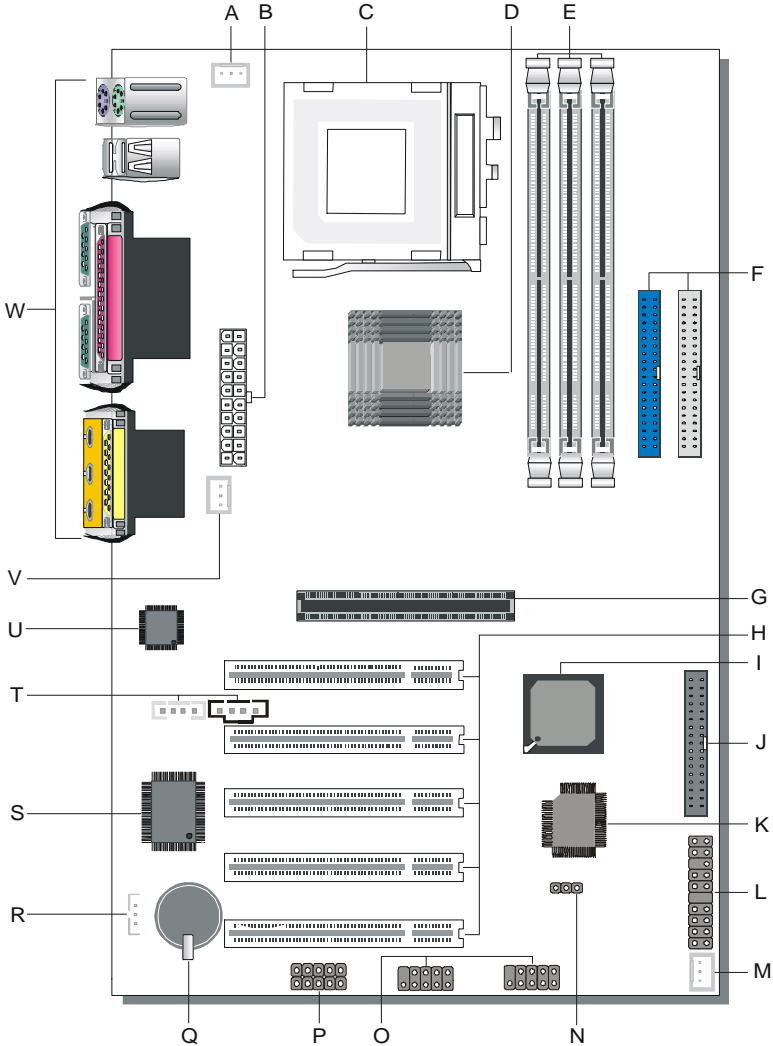

- A CPU Cooling Fan Connector**
- B ATX Power Supply Connector**
- C Socket 370 Connector**
- D Via VT8633 North Bridge chip**
- E DDR DIMM Banks**
- F Bus Mastering e-IDE/ATAPI Ports**
- G 32-bit AGP Slot**
- H 32-bit PCI Mastering Slots**
- I Via VT8233 South Bridge Chip**
- J Floppy Disk Drive (FDD) Port**
- K Flash BIOS**
- L Front panel connectors**
- M Chassis Cooling Fan**
- N CMOS Clear Jumper**
- O USB Ports**
- P Serial Infrared (IrDA) Device Header**
- Q 3V Lithium Battery**
- R Wake-On-LAN (WOL) Header**
- S Winbond W83697HF-AW LPC I/O Chip**
- T CD-IN Connectors**
- U Via VT1611A**
- V Chassis Cooling Fan**
- W Back panel Connectors**

1-7 MICROPROCESSOR

The motherboard supports a single Socket 370 processor. The processor's VID pins automatically program the voltage regulator on the motherboard to the required processor voltage. In addition, the front side bus speed (100 MHz and 133 MHz) is automatically selected. The motherboard supports all current Socket 370 processor speeds, voltages, and bus frequencies.

1-7.1 Microprocessor Packaging

The CPU is packaged in a 370 pin PGA package. A fan must be used to ensure adequate cooling.

1-7.2 Second Level Cache

The second-level cache is located on the substrate of the CPU package. The cache includes 0KB/128KB or 512 KB of synchronous pipelined burst static RAM. All supported onboard memory can be cached.

1-7.3 Microprocessor Upgrades

The motherboard can be upgraded with Socket 370 processors that run at higher speeds. When upgrading the processor, use the BIOS configuration mode to change the processor speed.

1-8 MEMORY

1-8.1 Main Memory

The motherboard has three DDR DIMM sockets. DDR RAM can be installed in one, two, or three sockets. Using the serial presence detect (SPD) data structure, programmed into an E²PROM on the DDR DIMM, the BIOS can determine the DDR RAM's size and speed. Minimum DDR DIMM memory size is 64 MB; maximum DDR DIMM memory size is 256/512 MB. Memory size and speed can vary between sockets.

The motherboard supports the following memory features:

- DRAM interface synchronous with host CPU (66/100/133 MHz) or AGP (66MHz) for most flexible configuration
- DRAM interface may be faster than CPU by 33 MHz to allow use of PC1600/2100 memory modules with 66MHz Celeron or use of PC1600/2100 with 100MHz Pentium II or Pentium III
- Concurrent CPU, AGP, and PCI access
- Supports DDR RAM memory types only
- Flexible row and column addresses. 64-bit data width only
- 2.5V SSTL-2 DRAM interface for DDR RAM
- Optional bank-by-bank ECC (single-bit error correction and multi-bit error detection) or EC (error checking only) for DRAM integrity
- Supports maximum 16-bank interleave (i.e., 16 pages open simultaneously); banks are allocated based on LRU
- Independent DDR RAM control for each bank
- Seamless DRAM command scheduling for maximum DRAM bus utilization (e.g., precharge other banks while accessing the current bank)
- Four cache lines (16 quadwords) of CPU to DRAM write buffers
- Four cache lines of CPU to DRAM read prefetch buffers
- Read around write capability for non-stalled CPU read
- Speculative DRAM read before snoop result
- Burst read and write operation
- x-1/2-1/2-1/2-1-1/2-1/2 back-to-back accesses for DDR SDRAM

- Supports DDR SDRAM CL 2/2.5/3 and 1T/per command
- Decoupled and burst DRAM refresh with staggered RAS timing.
- CAS before RAS or self refresh

1-9 CHIPSET

➤ VT8633

The Pro266 chipset is a high performance, cost-effective and energy efficient chip set for the implementation of AGP / V-Link / PCI / LPC desktop personal computer systems from 66 MHz, 100 MHz and 133 MHz based on 64-bit Socket-370 and Slot-1 (Intel Pentium-III and Celeron) super-scalar processors.

The Pro266 chip set consists of the VT8633 V-Link DDR Host system controller (552 pin BGA) and the VT8233 highly integrated V-Link Client PCI/LPC controller (376 pin BGA). The Host system controller provides superior performance between the CPU, DRAM, AGP bus, and V-Link interface with pipelined, burst, and concurrent operation. The VT8233 V-Link Client controller is a highly integrated PCI / LPC controller. Its internal bus structure is based on 66 MHz PCI bus that provides 2x bandwidth compare to previous generation PCI/ISA bridge chips. The VT8233 integrated Client V-Link controller with 266MB/S bandwidth between Host/Client V-Link interface, provides a V-Link-PCI and V-Link-LPC controller. It supports five PCI slots arbitration and decoding for all integrated functions and LPC bus.

The VT8633 supports eight banks of SDR / DDR SDRAMs up to 4 GB. The DRAM controller supports standard Synchronous DRAM (SDRAM), and Virtual Channel SDRAM (VC SDRAM or VCM) SDRAM in a flexible mix / match manner, or it can be configured to support Double-Data-Rated (DDR) SDRAM mode. The SDR/DDR DRAM interface allows zero wait state bursting between the DRAM and the data buffers at 66 / 100 / 133 MHz. The eight banks of DRAM can be composed of an arbitrary mixture of 1M / 2M / 4M / 8M / 16M / 32M / 64M xN DRAMs. The DRAM controller also supports optional ECC (single-bit error

correction and multi-bit detection) or EC (error checking) capability separately selectable on a bank-by-bank basis. The DRAM controller can run either synchronous or pseudo-synchronous mode with the host CPU bus frequency (66 / 100 / 133 MHz).

The VT8633 Host system controller also supports full AGP v2.0 capability for maximum bus utilization including 2x and 4x mode transfers, SBA (SideBand Addressing), Flush/Fence commands, and pipelined grants. An eight level request queue plus a four level post-write request queue with thirty-two and sixteen quadwords of read and write data FIFO's respectively are included for deep pipelined and split AGP transactions. A single-level GART TLB with 16 full associative entries and flexible CPU / AGP / PCI remapping control is also provided for operation under protected mode operating environments. Both Windows-95 VXD and Windows-98 / NT5 miniport drivers are supported for interoperability with major AGP-based 3D and DVD-capable multimedia accelerators.

The VT8633 Host system controller supports two 32-bit 3.3 system buses (one AGP and one V-Link) that are synchronous / pseudo-synchronous to the CPU bus. The chip also contains a built-in bus-to-bus bridge to allow simultaneous concurrent operations on each bus. Five levels (doublewords) of post write buffers are included to allow for concurrent CPU and V-Link operation. For V-Link Host operation, forty-eight levels (doublewords) of post write buffers and sixteen levels (doublewords) of prefetch buffers are included for concurrent V-Link bus and DRAM / cache accesses. When combined the V-Link Host/Client controllers, it realizes a complete PCI sub-system and supports enhanced PCI bus commands such as Memory-Read-Line, Memory-Read-Multiple and Memory-Write-Invalid commands to minimize snoop overhead. In addition, advanced features are supported such as snoop ahead, snoop filtering, L1 write-back forward to PCI master, and L1 write-back merged with PCI post write buffers to minimize PCI master read latency and DRAM utilization. Delay transaction and read caching mechanisms are also implemented for further improvement of overall system performance.

The 352-pin Ball Grid Array VT8233 Client V-Link PCI / LPC controller supports four levels (doublewords) of line buffers, type F DMA transfers and delay transaction to allow efficient PCI bus utilization and (PCI-2.2 compliant). The VT8233 integrated PCI controller and PCI arbitration for up to five PCI slots. One of the PCI REQ / GNT pair can be configured as high-priority to better support a low latency PCI bus master device. The VT8233 integrated networking MAC controller with standard MII interface to an external PHY for 10 / 100Mb base-T Ethernet or 1 / 10Mb PNA home networking.

The VT8233 also includes an integrated keyboard controller with PS2 mouse support, integrated DS12885 style real time clock with extended 256 byte CMOS RAM, integrated master mode enhanced IDE controller with full scatter / gather capability and extension to UltraDMA-33/66/100 for 33/66/100 MB/sec transfer rate, integrated USB interface with root hubs and six function ports with built-in physical layer transceivers, Distributed DMA support, and OnNow / ACPI compliant advanced configuration and power management interface.

For sophisticated power management, the Pro266 chipset provides independent clock stop control for the CPU / SDRAM, PCI, and AGP buses and Dynamic CKE control for powering down of the SDRAM. A separate suspend-well plane is implemented for the SDRAM control signals for Suspend-to-DRAM operation. Coupled with the VT8233 south bridge chip, a complete power conscious PC main board can be implemented with no external TTLs.

The Pro266 chipset is ideal for high performance, high quality, high energy efficient and high integration desktop and notebook AGP / PCI / LPC computer systems.

➤ **VT8233**

The VT8233 South Bridge is a high integration, high performance, power-efficient, and high compatibility device that supports Intel and non-Intel

based processor to V-Link bus bridge functionality to make a complete Microsoft PC99-compliant PCI/ISA system. In addition to complete ISA extension bus functionality, the VT8233 includes standard intelligent peripheral controllers:

- a) IEEE 802.3 compliant 10 / 100 Mbps PCI bus master Ethernet MAC with standard MII interface to external PHYceiver.
- b) Master mode enhanced IDE controller with dual channel DMA engine and interlaced dual channel commands. Dedicated FIFO coupled with scatter and gather master mode operation allows high performance transfers between PCI and IDE devices. In addition to standard PIO and DMA mode operation, the VT8233 also supports the UltraDMA-33 standard to allow reliable data transfer rates up to 33 MB/sec throughput. The VT8233 also supports the UltraDMA-66 / 100 standard. The IDE controller is SFF-8038i v1.0 and Microsoft Windows-family compliant.
- c) Universal Serial Bus controller that is USB v1.1 and Universal HCI v1.1 compliant. The VT8233 includes the root hub with six function ports with integrated physical layer transceivers. The USB controller allows hot plug and play and isochronous peripherals to be inserted into the system with universal driver support. The controller also implements legacy keyboard and mouse support so that legacy software can run transparently in a non-USB-aware operating system environment.
- d) Keyboard controller with PS2 mouse support.
- e) Real Time Clock with 256 byte extended CMOS. In addition to the standard ISA RTC functionality, the integrated RTC also includes the date alarm, century field, and other enhancements for compatibility with the ACPI standard.
- f) Notebook-class power management functionality compliant with ACPI and legacy APM requirements. Multiple sleep states (power-on suspend, suspend-to-DRAM, and suspend-to-Disk) are supported with hardware automatic wake-up. Additional functionality includes event monitoring,

CPU clock throttling and stop (Intel processor protocol), PCI bus clock stop control, modular power, clock and leakage control, hardware-based and software-based event handling, general purpose I/O, chip select and external SMI.

- g) Full System Management Bus (SMBus) interface.
- h) Integrated bus-mastering dual full-duplex direct-sound AC97-link-compatible sound system.
- i) Plug and Play controller that allows complete steerability of all PCI interrupts and internal interrupts / DMA channels to any interrupt channel. One additional steerable interrupt channel is provided to allow plug and play and reconfigurability of on-board peripherals for Windows family compliance.

The VT8233 also enhances the functionality of the standard ISA peripherals. The integrated interrupt controller supports both edge and level triggered interrupts channel by channel. The integrated DMA controller supports type F DMA in addition to standard ISA DMA modes. Compliant with the PCI-2.2 specification, the VT8233 supports delayed transactions and remote power management so that slower ISA peripherals do not block the traffic of the PCI bus. Special circuitry is built in to allow concurrent operation without causing dead lock even in a PCI-to-PCI bridge environment. The chip also includes eight levels (doublewords) of line buffers from the PCI bus to the ISA bus to further enhance overall system performance.

1-10 I/O INTERFACE CONTROLLER

The motherboard uses the Winbond W83697HF LPC Super-I/O controller which features:

- Supports 2 serial ports, IR port, parallel port, and floppy disk controller functions
- Two UARTs for Complete Serial Ports
 - Even, odd, stick or no parity bit generation and detection

- Programmable baud rate generator
- High speed baud rate (230Kbps, 460Kbps) support
- Independent transmit/receiver FIFOs
- Modem Control
- Plug and play with 96 base IO address and 12 IRQ options
- One dedicated IR port
 - Third serial port dedicated to IR function
 - IR function either through the two complete serial ports or the third dedicated port
 - Infrared-IrDA (HPSIR) and ASK (Amplitude Shift Keyed) IR
- Multi-mode parallel port
 - Standard mode, ECP and EPP support
 - Plug and play with 192 base IO address, 12 IRQ and 4 DMA options
- Floppy Disk Controller
 - 16bytes of FIFO
 - Data rates up to 1Mbps
 - Perpendicular recording driver support
 - Two FDDs with drive swap support
 - Plug and play with 48 base IO address, 12 IRQ and 4 DMA options

The Setup program provides configuration option for the I/O controller.

1-10.1 Serial Ports

The motherboard has two 9-pin D-Sub serial port connectors located on the back panel. The NS16C5450-compatible UARTs support data transfers at speeds up to 115.2 Kbits/sec with BIOS support.

1-10.2 Parallel Port

The connector for the multimode bi-directional parallel port is a 25-pin D-Sub connector located on the back panel of the motherboard. In the Setup program, there are four options for parallel port operation:

- Compatible (standard mode)
 - Bi-directional (PS/2 compatible)
-

- Bi-directional EPP. A driver from the peripheral manufacturer is required for operation.
- Bi-directional high-speed ECP

1-10.3 Diskette Drive Controller

The I/O controller is software compatible with the 82077 diskette drive controller and supports both PC-AT and PS/2 modes. In the Setup program, the diskette drive interface can be configured for the following diskette drive capacities and sizes.

- 360 KB, 5.25-inch
- 1.2 MB, 5.25-inch
- 720 KB, 3.5-inch
- 1.2 MB, 3.5-inch (driver required)
- 1.25-1.44 MB, 3.5-inch
- 2.88 MB, 3.5-inch

1-10.4 PS/2 Keyboard and Mouse Interface

PS/2 keyboard and mouse connectors are located on the back panel of the motherboard. The +5 V lines to keyboard and mouse connectors are protected with a fuse that prevents motherboard components from being damaged when an over-current condition occurs.



Note

The mouse and keyboard can be plugged into either PS/2 connector. Power to the computer should be turned off before a keyboard or mouse is connected or disconnected.

The keyboard controller contains code, which provides the traditional keyboard and mouse control functions, and also supports Power On/Reset password protection. Power On/Reset password can be specified in the BIOS Setup program.

The keyboard controller also supports the hot-key sequence <Ctrl><Alt>, software reset. This key sequence resets the computer's software by jumping to the beginning of the BIOS code and running the Power On Self Test (POST).

1-10.5 Infrared Support

On the front panel I/O connector, there are six pins that support Hewlett Packard HSDL-1000 compatible infrared (IR) transmitters and receivers. In the Setup program, Serial Port B can be direct4d to a connected IR device. (In this case, the Serial Port B connector on the back panel cannot be used.) The IR connection can be used to transfer files to or from portable devices like laptops, PDAs, and printers. The Infrared Data Association (IrDA) specification supports data transfers of 115Kbits/sec at a distance of 1 meter.

1-11 HARDWARE MONITOR

The optional hardware monitor subsystem provides low-cost instrumentation capabilities. The features of the hardware monitor

subsystem include:

- An integrated ambient temperature sensor
- Fan speed sensors, which monitor the fan 1 and fan 2 connector.
- Power supply voltage monitoring to detect levels above or below acceptable values

When suggested ratings for temperature, fan speed, or voltage are exceeded, an interrupt is activated. The hardware monitor component connects to the SMBus.

1-12 WAKE ON LAN TECHNOLOGY

Wake on LAN technology enables remote wakeup of the computer through a network. Wake on LAN technology requires a PCI add-in network interface card (NIC) with remote wakeup capabilities. The remote wakeup connector on the NIC must be connected to the onboard Wake on LAN connector. The NIC monitors network traffic at the Ethernet interface; upon detecting a Magic Packet, the NIC asserts a wakeup signal that powers up the computer. This feature uses the Wake on LAN connector.

⚠ CAUTION

For Wake on LAN, the 5-V standby line for the power supply must be capable of delivering +5V \pm 5 % at 720 mA. Failure to provide adequate standby current when implementing Wake on LAN can damage the power supply.

Chapter 2

HARDWARE INSTALLATION

Congratulations on your purchase of **SY-7VDA** Motherboard. You are about to install and connect your new Motherboard.



Note: Do not unpack the Motherboard from its protective anti-static packaging until you have made the following preparations.

2-1 PREPARATIONS

Gather and prepare all the following hardware equipment to complete the installation successfully:

1. Socket 370 processor with built-in CPU cooling fan (boxed type).



Note: This Motherboard supports non-boxed type CPUs. The heavier CPU cooling fan requires the installation of a CPU support stand.

2. DDR RAM module (s)
3. Computer case and chassis with adequate power supply unit
4. Monitor
5. PS/2 Keyboard
6. Pointing Device (PS/2 mouse)
7. Speaker(s) (optional)
8. Disk Drives: HDD, CD-ROM, Floppy drive ...
9. External Peripherals: Printer, Plotter, and Modem (optional)
10. Internal Peripherals: Modem and LAN cards (optional)

2-2 UNPACKING THE MOTHERBOARD

When unpacking the Motherboard, check for the following items:

-
- ◆ The SY-7VDA PRO266 AGP/PCI Motherboard



-
- ◆ The Quick Start Guide



-
- ◆ The Installation CD-ROM



-
- ◆ SOYO Bonus Pack CD-ROM



-
- ◆ One IDE Device ATA 66 Flat Cable

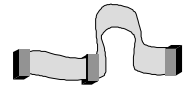

-
- ◆ One Floppy Disk Drive Flat Cable

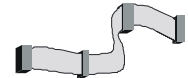

Warning: Do not unpack the Motherboard from its anti-static packaging until you are ready to install it.

Like most electronic equipment, your Motherboard may be damaged by electrostatic discharge. To avoid permanent damage to components ground yourself while working by using a grounding strap. Otherwise, ground yourself frequently by touching the unpainted portion of the computer chassis to drain the static charges.

Handle the Motherboard carefully, holding it by the edges. You are now ready to start the installation.

2-3 INSTALLATION GUIDE

We will now begin the installation of the Motherboard. Please follow the step-by-step procedure designed to lead you to a complete and correct installation.



Warning: Turn off the power to the Motherboard, system chassis, and peripheral devices before performing any work on the Motherboard or system.

BEGIN THE INSTALLATION

2-3.1 CPU Installation

Your SY-7VDA motherboard comes with a CPU retention set kit. The retention set is used to hold the processor attached to the Socket 370 CPU connector on the motherboard.

☑ Mark your CPU Frequency: Record the working frequency of your CPU that should be clearly marked on the CPU cover.

FSB 66MHz

<input type="checkbox"/> 400MHz (66 x 6.0)	<input type="checkbox"/> 466MHz (66 x 7.0)	<input type="checkbox"/> 533MHz (66 x 8.0)	<input type="checkbox"/> 600MHz (66 x 9.0)	<input type="checkbox"/> 667MHz (66 x 10.0)
<input type="checkbox"/> 433MHz (66 x 6.5)	<input type="checkbox"/> 500MHz (66 x 7.5)	<input type="checkbox"/> 566MHz (66 x 8.5)	<input type="checkbox"/> 633MHz (66 x 9.5)	<input type="checkbox"/> 700MHz (66 x 10.5)

FSB 100MHz

<input type="checkbox"/> 500MHz (100 x 5.0)	<input type="checkbox"/> 600MHz (100 x 6.0)	<input type="checkbox"/> 700MHz (100 x 7.0)	<input type="checkbox"/> 800MHz (100 x 8.0)
<input type="checkbox"/> 550MHz (100 x 5.5)	<input type="checkbox"/> 650MHz (100 x 6.5)	<input type="checkbox"/> 750MHz (100 x 7.5)	<input type="checkbox"/> 850MHz (100 x 8.5)

FSB 133MHz

<input type="checkbox"/> 533MHz(133x4.0)	<input type="checkbox"/> 667MHz(133x5.0)	<input type="checkbox"/> 800MHz(133x 6.0)	<input type="checkbox"/> 933MHz(133x 7.0)	<input type="checkbox"/> .13GHz(133x 8.5)
<input type="checkbox"/> 600MHz(133x4.5)	<input type="checkbox"/> 733MHz(133x5.5)	<input type="checkbox"/> 866MHz(133x 6.5)	<input type="checkbox"/> 1000MHz(133x 7.5)	<input type="checkbox"/>

CPU Mount Procedure: To mount the Pentium® & Celeron™ processor & VIA Cyrix processor that you have purchased separately, follow these instructions.

1. Lift the socket handle up to a vertical position.

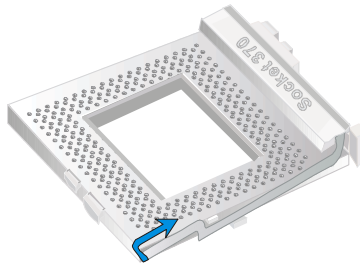

2. Align the blunt edge of the CPU with the matching pinhole distinctive edge on the socket.

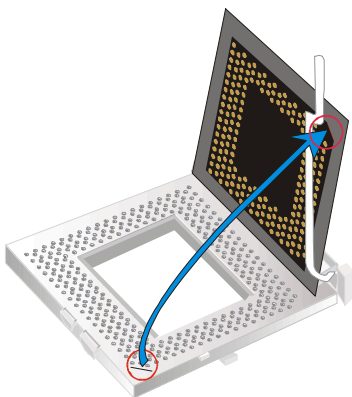

3. Seat the processor in the socket completely and without forcing.

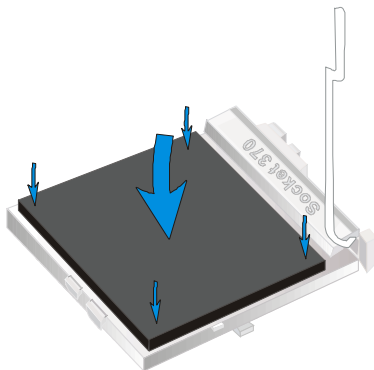

4. Then close the socket handle to secure the CPU in place.

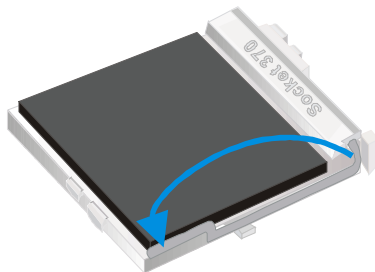



Remember to connect the CPU Cooling Fan to the appropriate power connector on the Motherboard. *The fan is a key component that will ensure system stability. The fan prevents overheating, therefore prolonging the life of your CPU.*

2-3.1.1 CPU Fan Installation

Your Socket 370 processor kit comes with a cooling fan. Mount the fan on the processor according to the instructions provided by the manufacturer. The fan is a key component that will ensure system stability. The fan prevents overheating, therefore prolonging the life of your CPU.



Note: Remember to connect the fan to the appropriate power source.

2-3.2 DDR RAM Memory Module Installation

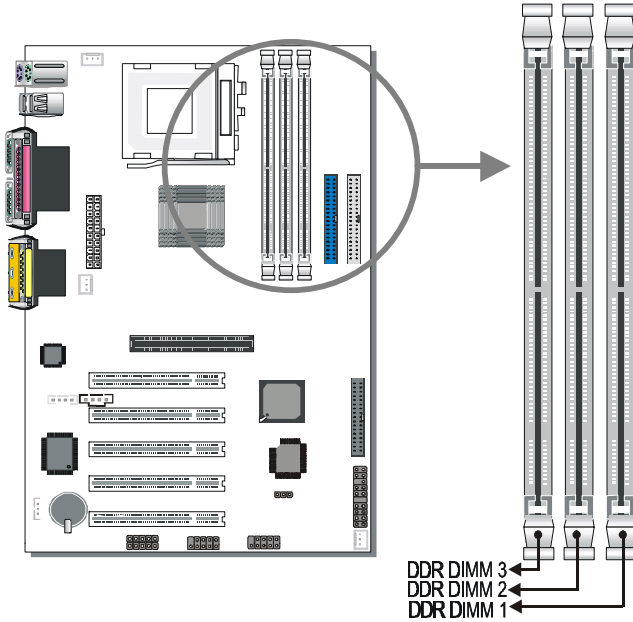

Your board comes with three DIMM sockets, providing support for up to 3GB of main memory using unbuffered and registered DIMM modules from 64MB to 1GB. On this motherboard, DRAM speed can be set independent from the CPU front side bus speed. Depending on the DRAM clock speed setting in the BIOS setup (Chapter 3), appropriate memory modules must be used. For 100MHz DRAM speed, use PC1600 memory; for 133MHz DRAM speed, use PC2100 memory.

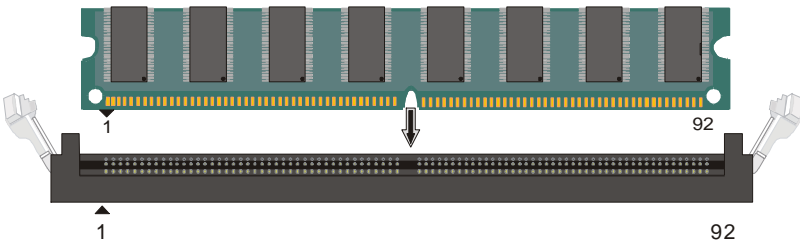



Memory Configuration Table

Number of Memory Modules	DIMM 1	DIMM 2	DIMM 3
RAM Type	DDR RAM		
Memory Module Size (MB)	64 / 128 / 256 / 512 / 1024 MB		

2-3.3 Motherboard Connector

2-3.3.1 IDE Device Installation (HDD, CD-ROM)

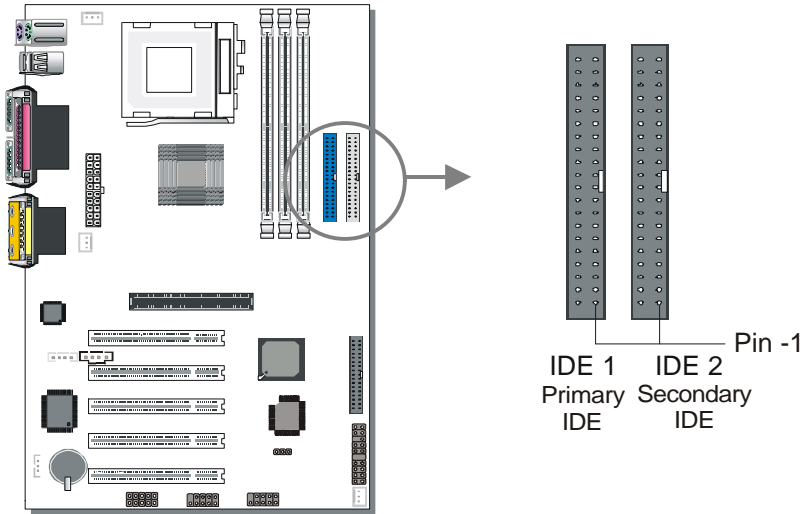

This Motherboard offers two primary and secondary IDE device connectors (IDE1, IDE2). It can support up to four high-speed Ultra DMA 33/66/100HDD or CD-ROM.

Connect one side of the ATA66/100 flat cable to the IDE device (HDD or CD-ROM) and plug the other end to the primary (IDE1) or secondary (IDE2) directionally keyed IDE connector on the Motherboard. The ATA66/100 cable is backward compatible with ATA33 HDDs.

This Motherboard can support up to four HDDs.

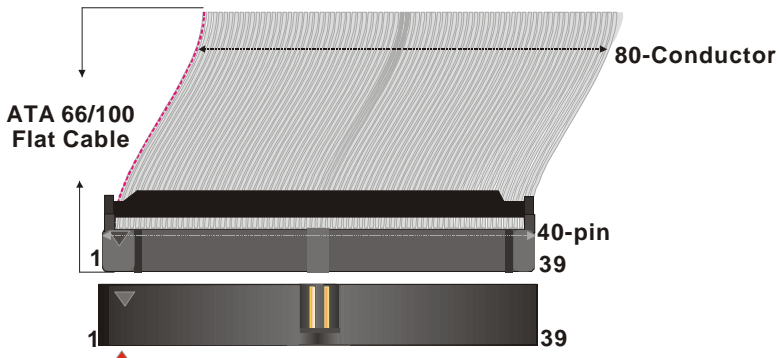

2-3.3.2 Floppy Drive Installation

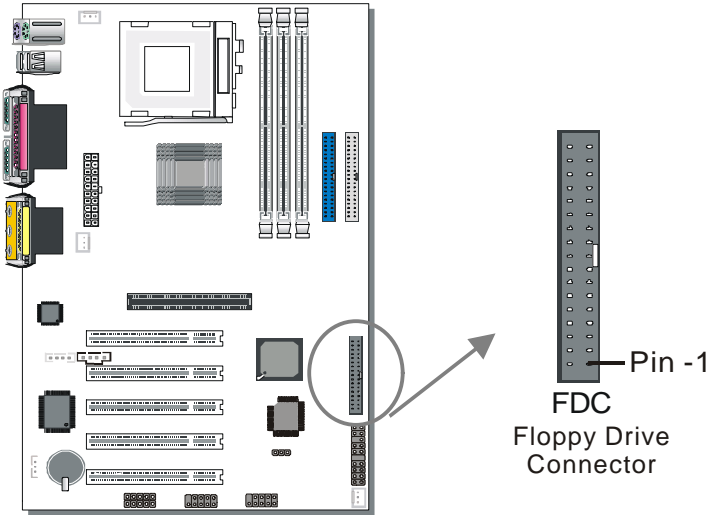

The system supports 5 possible floppy drive types: 720 KB, 1.2 MB, 1.44 MB, 2.88 MB, and LS-120.

Connect one side of the 34-pin flat cable to the floppy drive and plug the other end to the floppy drive connector on the Motherboard.

This Motherboard can support up to 2 floppy drives.

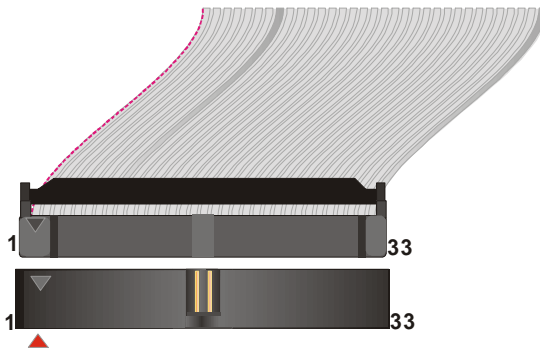

2-3.3.3 Front Panel Connections

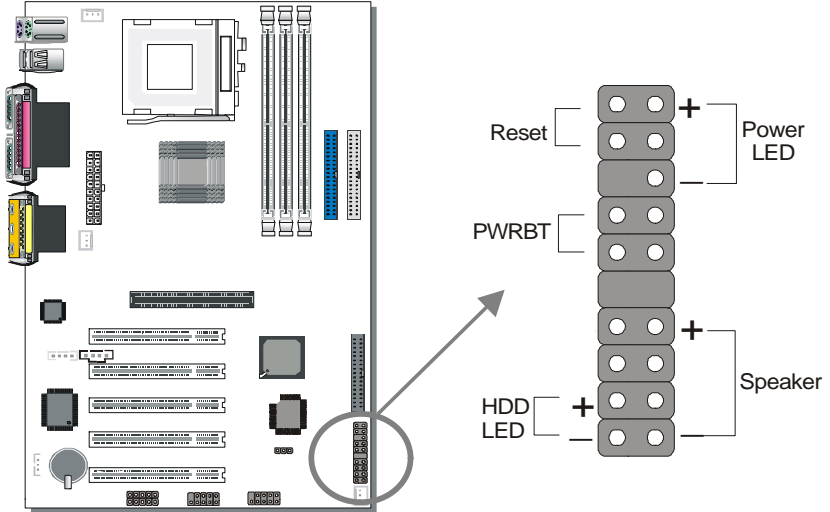

Plug the computer case's front panel devices to the corresponding headers on the Motherboard.

1. Power LED

Please install according to the following pin assignment: pin 1,3 are for Power LED.

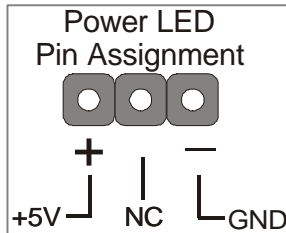

2. Reset

Plug the Reset push-button cable into the 2-pin Reset header on the Motherboard. Pushing the Reset button on the front panel will cause the system to restart the boot-up sequence.

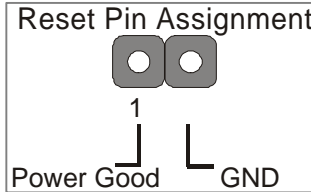

3. Speaker

Attach the 4-pin PC speaker cable from the case to the Speaker header on the Motherboard.

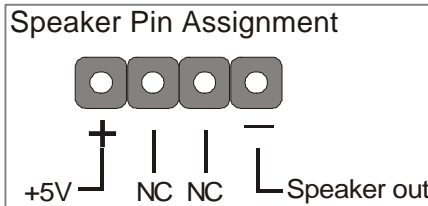

4. IDE LED

Attach the 2-pin IDE device LED cable to the corresponding IDE LED header on the Motherboard. This will cause the LED to light up when an IDE (HDD, CD-ROM) device is active.

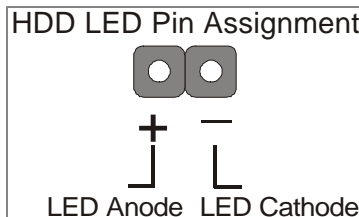

5. ATX Power On/Off Switch

Attach the 2-pin momentary type switch to the PWRBT header for turning On or Off your ATX power supply.

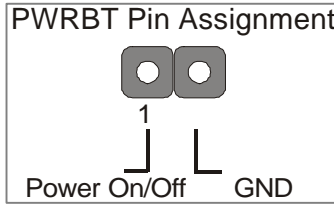

2-3.3.4 Back Panel Connections

All external devices such as the PS/2 keyboard, PS/2 mouse, printer, modem, USB can be plugged directly onto the Motherboard back panel.

Only after you have fixed and locked the Motherboard to the computer case can you start connecting the external peripheral devices.

When connecting an external device, use the following figure to locate and identify which back panel connector to plug the device to.

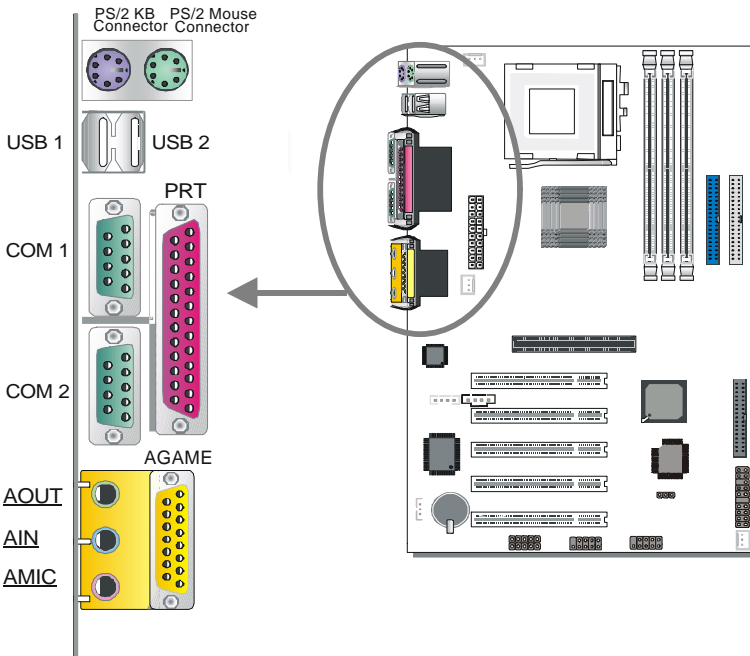

1. Onboard Serial Ports COM1/COM2

External peripherals that use serial transmission scheme include:

- serial mouse,
- and modem.

Plug the serial device cables directly into the COM1/COM2 9-pin male connectors located at the rear panel of the Motherboard.

2. Parallel Port PRT

This parallel port is used to connect the printer or other parallel devices. Plug the parallel device cable into the 25-pin female connector located at the rear panel of the Motherboard.

3. PS/2 Keyboard

Plug the keyboard jack directly into the 6-pin female PS/2 keyboard connector located at the rear panel of the Motherboard.

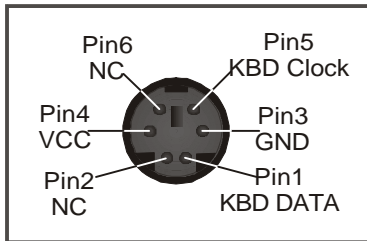

4. PS/2 Mouse

Similarly, plug the mouse jack directly into the 6-pin female PS/2 mouse connector.

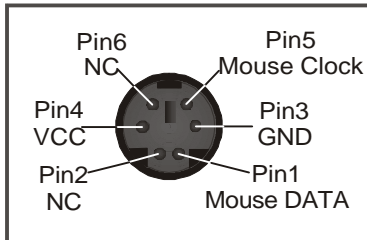

5. Universal Serial Bus USB1/USB2 (USB3/USB4 ESB5/USB6)

This Motherboard provides four USB ports for your additional devices. Plug the USB device jack into the available USB connector USB1 or USB2.

- Standard device drivers come with the Win98 for commonly used USB devices.
- With Win95, use the flow UHCI specifications. To use USB devices under Win95, usually you have to install the device that driver comes with the USB device you have purchased.

USB3, USB4, USB5 and USB6 are available. To make use of these USB ports, purchase a USB cable from your dealer. The lay-out of USB3/USB4 and USB5/USB6 are as follows:

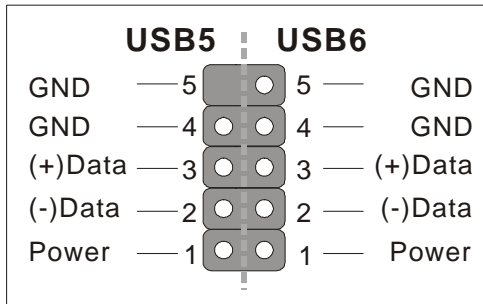
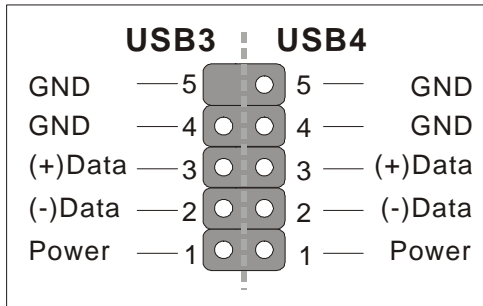

6. Onboard Game port/audio

This Motherboard provides Joystick port and audio.

- Attach the joystick cable to the 15-pin GAME port at the rear panel of you motherboard.
- This Motherboard features three built-in audio-stereo ports (labeled line-in, line-out, and mic jack) convenient to directly plug-in all your external audio devices.

2-3.3.5 Other Connections

1. Wake-On-LAN (WOL)

Attach the 3-pin connector from the LAN card which supports the Wake-On-LAN (WOL) function to the JP10 header on the Motherboard. This WOL function lets users wake up the connected computer through the LAN card.

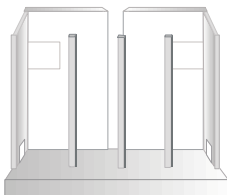

Please install according to the following pin assignment:

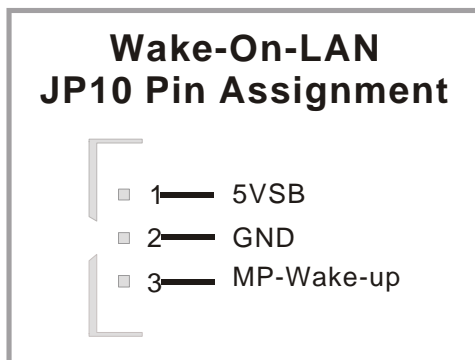

2. Standard Infrared (SIRCON)

Plug the 5-pin infrared device cable to the SIRCON header. This will



enable the infrared transfer function. This Motherboard meets both the ASKIR and HPSIR specifications.

Please install according to the following pin assignment:

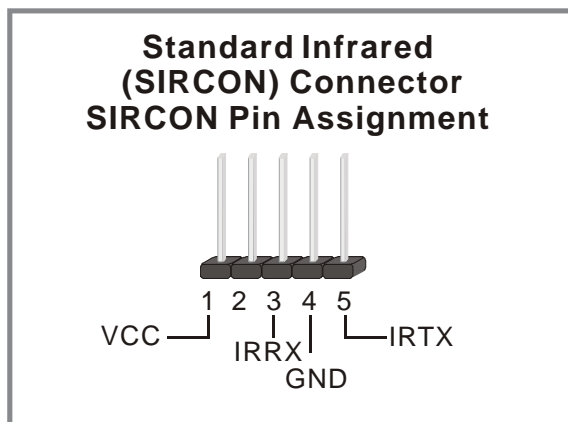

3. Cooling Fan Installation

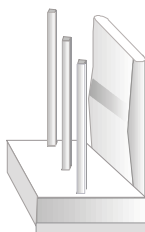

(1) CPU Cooling Fan

After you have seated the CPU properly on the processor, attach the 3-pin fan cable to the CPUFAN connector on the Motherboard. The fan will stop when the system enters into Suspend Mode. (Suspend mode can be enabled from the BIOS Setup Utility, [POWER MANAGEMENT] menu.) To avoid damage to the system, install according to the following pin assignment:

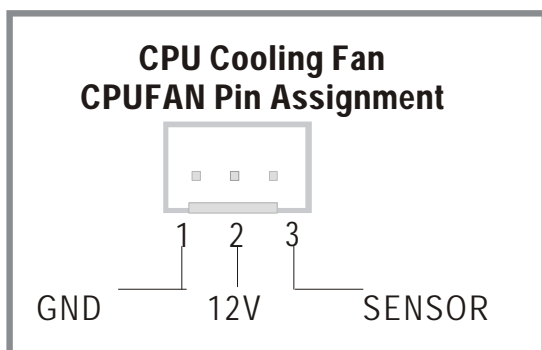

(2) Chassis Cooling Fan (CHAFAN1,CHAFAN2)

Some chassis also feature a cooling fan. This Motherboard features a CHAFAN connector to provide 12V power to the chassis fan. Connect the cable from the chassis fan to the CHAFAN 3-pin connector. Install according to the following pin assignment:

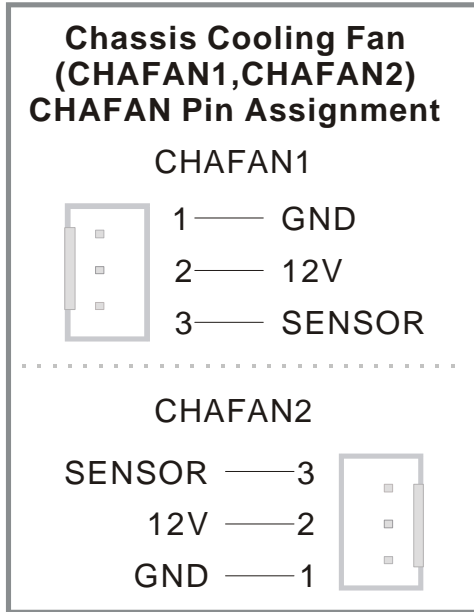

Note: CPUFAN must be installed for this Motherboard, CHAFAN is optional.

4. CD Line-in (CDIN1,CDIN2)

This Motherboard provides two CD-Line in connectors. Please connect the 4-pin audio cable from your CD-ROM drive to either CDIN1 or CDIN2. (It fits in only one, depending on the cable that came with your CD-ROM drive)

Please install according to the following pin assignment:

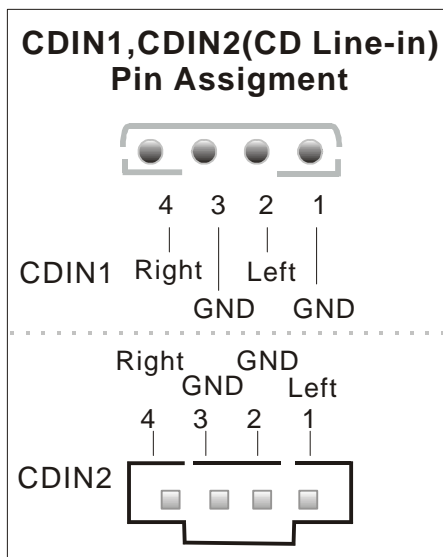

2-3.3.6 AGP VGA Card

Insert the AGP VGA card into the AGP slot. Then connect the monitor information cable to the AGP card back plane external connector. Follow the manufacturer's instructions to perform the AGP VGA drivers installation.

2-3.3.7 ATX Power Supply

Plug the connector from the power directly into the 20-pin male ATX PW connector on the Motherboard, as shown in the following figure.

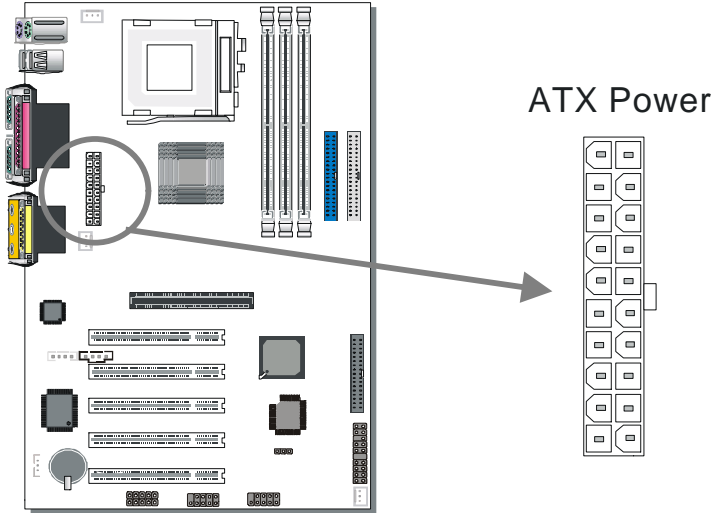

Warning: Follow these precautions to preserve your Motherboard from any remnant currents when connecting to ATX power supply:

Turn off the power supply and unplug the power cord of the ATX power supply before connecting to ATX PW connector.

The Motherboard requires a power supply with at least 200 Watts and a "power good" signal. Make sure the ATX power supply can take at least 720 mA * load on the 5V Standby lead (5VSB) to meet the standard ATX specification.

* **Note:** If you use the Wake-On-LAN (WOL) function, make sure the ATX power supply can support at least 720 mA on the 5V Standby lead (5VSB).

Please install the ATX power according to the following pin assignment:

ATX Power

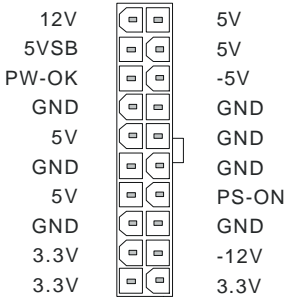



➤ Pay special care to the directionality.

2-3.4 CMOS Clear (JP5)

In some cases the CMOS memory may contain wrong data, follow the steps below to clear the CMOS memory.

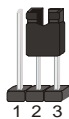
1. Clear the CMOS memory by momentarily shorting pin 2-3 on jumper JP5. This jumper can be easily identified by its white colored cap.
2. Then put the jumper back to 1-2 to allow writing of new data into the CMOS memory.

CMOS Clearing	Clear CMOS Data	Retain CMOS Data
JP5 Setting	Short pin 2-3 for at least 5 seconds to clear the CMOS 	Short pin 1-2 to retain new settings 
<i>Note: You must unplug the ATX power cable from the ATX power connector when performing the CMOS Clear operation.</i>		

2-3.5 Power On

You have now completed the hardware installation of your Motherboard successfully.

1. Turn the power on
2. To enter the BIOS Setup Utility, press the key while the system is performing the diagnostic checks,



Note: If you have failed to enter the BIOS, wait until the boot up sequence is completed. Then push the RESET button and press key again at the beginning of boot-up, during diagnostic checks.



Repeat this operation until you get the following screen.

3. The BIOS Setup screen appears:

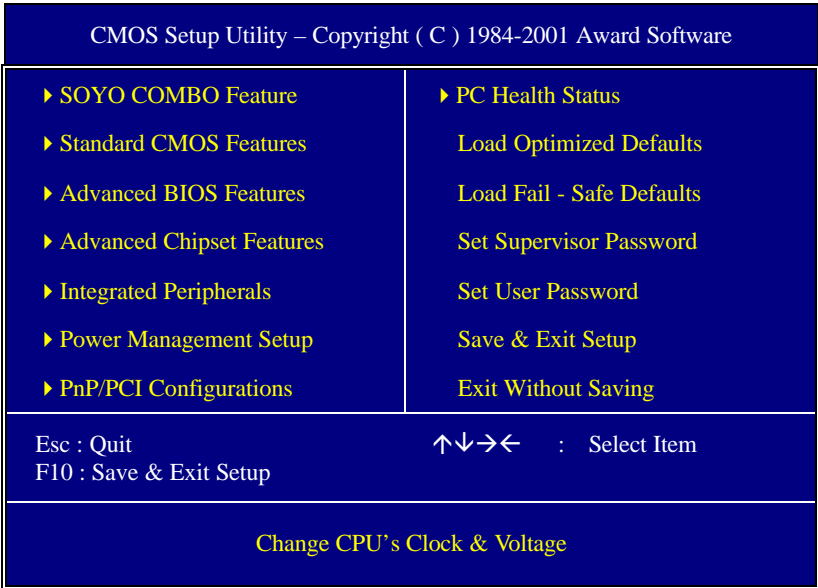

2-3.6 Quick BIOS Setup

This Motherboard does not use any hardware jumpers to set the CPU frequency. Instead, CPU settings are software configurable with the BIOS [SOYO COMBO FEATURE]. The [SOYO COMBO FEATURE] combines the main parameters that you need to configure, all in one menu, for a quick setup in BIOS.

After the hardware installation is complete, turn the power switch on, then press the key during the system diagnostic checks to enter the Award BIOS Setup program. The CMOS SETUP UTILITY will be shown on the screen. Then, follow these steps to configure the CPU settings.

Step 1. Select [STANDARD CMOS SETUP]

Set [Date/Time] and [Floppy drive type], then set [Hard Disk Type] to “Auto”.

Step 2. Select [LOAD OPTIMIZED DEFAULTS]

Select the “LOAD OPTIMIZED DEFAULTS” menu and type “Y” at the prompt to load the BIOS optimal setup.

Step 3. Select [SOYO COMBO FEATURE]

Set the [CPU Frequency Select] field to “Manual”, to be able to change the CPU frequency 1 MHz stepping.

Step 4. Select [SAVE & EXIT SETUP]

Press <Enter> to save the new configuration to the CMOS memory, and continue the boot sequence.

2-3.7 Troubleshooting at First Start

USB Issues

Can I use USB port 3_4 and port 5_6 for keyboard resume function?

This M/B has 6 USB ports, but only the 2 at the back panel can be used for USB keyboard resume function.

Video (no display) related issues

I built a new computer system using a Soyo board and nothing happens when turning it on, no video and no beeps from the PC speaker. What is happening and how can it be fixed?

No screen and no beeps mean that your CPU and motherboard do not work at all. It could be that the CPU is not seated correctly or that a component on the M/B is grounded (shorted) with the case. Also make sure to check the voltage setting switch (110V/220V) on the back of the power supply.

To isolate the problem do the following:

1. Press and hold down on the “Ins” (insert) key while turning on the computer until you get video. If you do not get video then,
2. Double-check jumpers setting on you motherboard and remove all add-on cards, unplug all hard-disk and floppy-disk drive cables and see if you can hear some beeps. If you still do not get any beeps, then try putting the motherboard on the table (to isolate it from the case) with the CPU and speaker only, and give it one more try.

I hear a series of beeps and I do not get anything from my monitor. What could be wrong?

The following lists some basic beep codes and their possible meanings:

- One long beep and 3 very short beeps - The video card is not detected by the motherboard. Please re-seat your video card. If you are using an AGP card, please push your AGP card down real hard. You may have to push VERY hard without the AGP card mounting screw. Make sure not to insert the card the other way around.

- Continuous beeps – One or more of the memory modules is not seated correctly in its socket.

My PCI VGA card works fine with my system, but when I put in a new AGP card, it does not give me any video. Is my AGP slot bad?

This is a common problem with AGP video cards. The reason is that your AGP card did not get seated into the AGP slot fully and firmly. Please push your AGP card down into the socket real hard, it should snap twice. You may have to unscrew the AGP card to allow the card to go further down. Do take care not to damage the card by using too much force.

I get distorted video my AGP card right after I save my bios. Why is that?

The cause is likely that your AGP card is not running at the correct bus speed. To fix this, please clear the CMOS via JP5 and if it still does not work, please upgrade your motherboard bios to the latest version.

BIOS Issues

Where can I find the BIOS revision of my mainboard?

It will be displayed on the up-left corner on the screen during boot-up. It will show as your board type followed by the revision number, such as 5EH_2CA1 (meaning revision 2CA1 for the SY-5EH board) or 6BA+ IV_2AA2 which means SY-6BA+ IV motherboard with 2AA2 bios.

Where can I find the latest BIOS of my motherboard?

Please go to the technical support page of one of the SOYO websites (Taiwan: www.soyo.com.tw), and look up your motherboard to find the latest BIOS revision.

Hard disk, floppy drive, CD-ROM etc

When I boot up my new computer I got "floppy boot failure" and the LED on the floppy stays on

Make sure the red wire of floppy ribbon cable goes to Pin1 on the floppy drive side (don't trust the "key lock" or "notch") and use the end-connector of the cable (don't use middle one).

Modem issues

I get an "I/O Conflict" message when I turn on my system and I can not get my modem to work

What you need to do is to disable 'COM2' (or UART2 or serial port 2) in the bios under integrated peripheral setup.

I have installed my modem drivers several times and I still cannot get my modem to work. Why?

If you are sure that the modem driver has been installed correctly, then you need to install the south bridge driver from the SOYO CD, this is because Windows does not properly recognize relatively new chipsets.

Audio Issues

I do not get any sound from my sound card. What could be wrong?

Please make sure the speaker is connected to the speaker out port on your sound card.

In Device Manager, I keep getting yellow exclamation signs on my sound port even though I have installed my sound driver several times and I could not get my sound card to work. What is wrong?

It is likely that you did not have the correct driver installed. If you are sure that the correct sound driver has been installed, then please install the 'VIA 4 in 1' driver for the motherboard.

The sound is working in my system, but when I play CD music from the CD-ROM, I do not get any sound. What is wrong?

This is because the 3-wire audio cable from the CD-ROM to the sound card is not connected or it is loose.

The sound and everything else works fine except that the recorder and microphone do not work. What is wrong?

This is because the recorder and microphone in the Windows are not enabled. Please go to sound properties and enable them.

Lock up (freeze)

When I boot up my system, everything works fine. It sees my CPU and memory, detects my hard drive, floppy drive and CD-ROM but locks up at "Verify DMI pool data... ", and it won't go any further. What should I do?

Please clear the CMOS via JP5 then choose 'load optimized default' in the bios and save the bios and exit. Next, unplug all other add-on cards except the video card and floppy drive controller, and see if it can boot from floppy. Then put back the peripherals one by one to identify which one causes the lockup.

I can not get my board to run properly.

Please make sure you have the latest bios and driver from the SOYO web site at: <http://www.soyo.com>

2-3.8 Power Off

There are two possible ways to turn off the system:

1. Use the **Shutdown** command in the **Start Menu** of Windows 95/98 to turn off your computer.
2. Press the mechanical power-button and **hold down for over 4 seconds**, to shutdown the computer. If you press the power-button for less than 4 seconds, then your system will enter into **Suspend Mode**.

You are now ready to configure your system with the BIOS setup program. Go to *Chapter 3: BIOS SETUP*



Chapter 3

BIOS SETUP UTILITY

This Motherboard's BIOS setup program uses the ROM PCI/ISA BIOS program from Award Software Inc.

To enter the Award BIOS program's Main Menu:

1. Turn on or reboot the system.
2. After the diagnostic checks, press the [Del] key to enter the Award BIOS Setup Utility.

CMOS Setup Utility – Copyright (C) 1984-2001 Award Software	
<ul style="list-style-type: none"> ▶ SOYO COMBO Feature ▶ Standard CMOS Features ▶ Advanced BIOS Features ▶ Advanced Chipset Features ▶ Integrated Peripherals ▶ Power Management Setup ▶ PnP/PCI Configurations 	<ul style="list-style-type: none"> ▶ PC Health Status Load Fail - Safe Defaults Load Optimized Defaults Set Supervisor Password Set User Password Save & Exit Setup Exit Without Saving
Esc : Quit	↑↓→ : Select Item
F10 : Save & Exit Setup	
Change CPU's Clock & Voltage	

Selecting items

- Use the arrow keys to move between items and select fields.
- From the Main Menu press arrow keys to enter the selected submenu.

Modifying selected items

- Use the [Up]/[Down] keys to modify values within the selected fields. Some fields let you enter values directly.

Hot Keys: Function keys give you access to a group of commands throughout the BIOS utility.

Function	Command	Description
F1	General Help	Gives the list of options available for each item.
F5	Previous Values	Restore the old values. These are the values that the user started the current session with.
F6	Load Fail-Safe Defaults	Loads all items with the most conservative values.
F7	Load Optimized Defaults	Loads all options with the optimize values.
F10	Save	Saves your changes and reboots the system.
[Esc]	Exit	Returns at anytime and from any location to the Main Menu.
[Enter]	Select	Will display a overlapping window with all options for the current item.
[+/-/PU/PD]	Value	Using the +, -, Page Up and Page Down keys the user can toggle the value of the current item.

SAVE AND EXIT SETUP

Select the [SAVE & EXIT SETUP] option from the Main Menu to save data to CMOS and exit the setup utility. This option saves all your changes and causes the system to reboot.

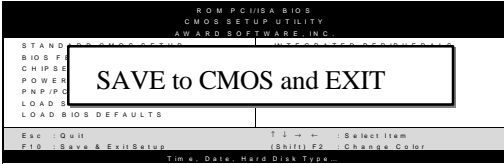

Type [Y] to save the changes and exit or [N] to return to the Main Menu and keep current values.

EXIT WITHOUT SAVING

Selecting the [EXIT WITHOUT SAVING] option allows you to abandon all data and exit setup, therefore ignoring all your changes.

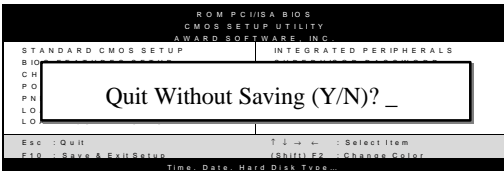

Type [Y] to abandon changes and exit or [N] to return to the Main Menu and keep current values.



3-1 SOYO COMBO SETUP

This Motherboard does not use any hardware jumpers to set the CPU frequency. Instead, CPU settings are software configurable with the BIOS [SOYO COMBO SETUP].

After the hardware installation is complete, turn the power switch on, then press the key during the system diagnostic checks to enter the Award BIOS Setup program. The CMOS SETUP UTILITY will display on screen. Then, select the [SOYO COMBO SETUP] option from the main menu and press the <Enter> key.

CMOS Setup Utility – Copyright (C) 1984-2001 Award Software
SOYO COMBO Feature

Auto Detect DIMM/PCI Clk Enabled Spread Spectrum Disabled CPU Clock 66MHz CPU Ratio X 3 CPU Vcore Select Default Quick Power On Self Test Enabled First Boot Device Floppy Second Boot Device HDD-0 Third Boot Device LS120 Boot Other Device Enabled	Item Help <hr/> Menu Level ▶
--	-----------------------------------

↑↓→:Move Enter:Select +/-/PU/PD:Value F10:Save ESC:Exit F1:General Help
 F5:Previous Values F6:Fail-Safe Defaults F7: Optimized Defaults

The [SOYO COMBO SETUP] menu combines the main parameters that you need to configure, all in one menu, for a quick setup in BIOS.

Quick CPU Frequency Setup

Quick CPU Frequency Setup	Setting	Description	Note
Auto Detect DIMM/PCI Clk	Disabled	When enabled, this item will auto detect if the DIMM and PCI socket have devices and will send clock signal to DIMM and PCI devices. When disabled, it will send the clock signal to all DIMM and PCI socket.	Default
	Enabled		
Spread Spectrum	Disabled	This item allows you to enable/disable the spread spectrum modulate.	Default
	Enabled		
CPU Clock Ratio	After you have selected the host clock, choose the right multiplier for the CPU. Options are: [2, 2.5, 3., 3.5, 4, 4.5, 5, 5.5,6,6.5,7.0,7.5,8.0]. The CPU frequency is then defined as [host clock freq.]x[multiplier], and should the working frequency of your Pentium® III & Pentium® II processor.		

CPU Vcore Select

	Setting	Description	Note
CPU Vcore Select	Default	This function adjust the CPU voltage.	Default
	+0.05V		
	+0.1V		
	+0.2V		
	+0.3V		
	+0.4V		
	-0.05V		
	-0.1V		

Quick Power On Self Test

	Setting	Description	Note
Quick Power On Self Test	Disabled	Provides a fast POST at boot-up.	Default
	Enabled		



System Boot Control Settings

System Boot Control Settings	Setting	Description	Note
First /Second/Third Boot Device	Floppy	Select Your Boot Device Priority	
	LS/ZIP		
	HDD-0		
	SCSI		
	CDROM		
	HDD-1		
	HDD-2		
	HDD-3		
	LAN		
	Disabled		
Boot Other Device	Disabled	Select Your Boot Device Priority	Default
	Enabled		



3-2 STANDARD CMOS SETUP

Select the [STANDARD CMOS SETUP] option from the Main Menu and press [Enter] key.

CMOS Setup Utility – Copyright (C) 1984-2001 Award Software
Standard CMOS Features

Date (mm:dd:yy)	Fri, Mar 9 2001	Item Help
Time (hh:mm:ss)	16 : 40 : 51	
▶ IDE Primary Master	Press Enter None	Menu Level ▶
▶ IDE Primary Slave	Press Enter None	
▶ IDE Secondary Master	Press Enter None	
▶ IDE Secondary Slave	Press Enter None	
Drive A	1.44M, 3.5 in.	
Drive B	None	
Floppy 3 Mode Support	Disabled	
Video	EGA/VGA	
Halt On	All Errors	
Base Memory	640K	
Extended Memory	130048K	
Total Memory	131072K	

↑↓→:Move Enter>Select +/-/PU/PD:Value F10:Save ESC:Exit F1:General Help
 F5:Previous Values F6:Fail-Safe Defaults F7: Optimized Defaults

This screen allows you to modify the basic CMOS settings. After you have completed the changes, press [Esc] key to return to the Main Menu.

Date & Time

	Display	Setting	Please Note
Date	mm/dd/yyyy	Type the current date	You can also the PUp/PDn keys to toggle
Time	hh:mm:ss	Type the current time	24-hour clock format 3:15 PM is displayed as 15:15:00

Hard Disks Type & Mode

Choose the type and mode for the hard disks that you have already installed.

Primary (Secondary) Master & Slave	Setting	Description	Note
IDE HDD Auto-Detection	Press Enter	To auto-detect the HDD's size, head ..on this channel	
	Auto	BIOS detects hard disk type automatically.	Default
IDE Primary Slave (User Type)	User	User defines the type of hard disk.	
	None		
Access Mode	Auto	BIOS detects hard disk mode automatically.	Default
	Normal	Normal IDE hard disk	<528MB
	LBA	Enhanced IDE hard disk	>528MB
	Large	Large IDE hard disk (for certain hard disk)	



Note: If you have any questions on your hard disk type or mode, ask your hard disk provider or previous user for details.

Floppy Drives

Floppy Drives	Setting	Description	Note
Drives A & B	360KB, 5.25 in.		
	1.2MB, 5.25 in.		
	720KB, 3.5 in.		
	1.44MB, 3.5 in.		Default
	2.88MB, 3.5 in.		
	None	Not installed	
Floppy 3-Mode Support	Disabled		Default
	Drive A Drive B Both	Supports 3-mode floppy diskette: 740KB/1.2MB/1.44MB on selected disk drive.	Special disk drive commonly used in Japan



Others Optional

	Setting	Description	Note
Video	EGA/VGA	Select the video mode.	Default
	CGA 40		
	CGA 80		
	MONO (Monochrome)		
Halt On	ALL Errors	When the BIOS detects system errors, this function will stop the system. Select which type of error will cause the system halt.	Default
	No Errors		
	All, But Keyboard		
	All, But Diskette		
	All, But Disk/Key		



3-3 ADVANCED BIOS FEATURES

Select the [Advanced BIOS Features] option from the Main Menu and press [Enter] key.

CMOS Setup Utility – Copyright (C) 1984-2001 Award Software
Advanced BIOS Features

Virus Warning Disabled CPU Internal Cache Enabled External Cache Enabled CPU L2 Cache ECC Checking Enabled Swap Floppy Drive Disabled Boot Up Floppy Seek Enabled Boot Up NumLock Status On Gate A20 Option Fast Typematic Rate Setting Disabled x Typematic Rate (Chars/Sec) 6 x Typematic Delay (Msec) 250 Security Option Setup OS Select For DRAM > 64MB Non-OS2 HDD S.M.A.R.T. Capability Disabled Video BIOS Shadow Enabled	Item Help <hr/> Menu Level ▶
---	---------------------------------

↑↓:Move Enter:Select +/-/PU/PD:Value F10:Save ESC:Exit F1:General Help
 F5:Previous Values F6:Fail-Safe Defaults F7: Optimized Defaults

After you have completed the changes, press [Esc] key and follow the instructions on your screen to save your settings or exit without saving.

Virus Warning

	Setting	Description	Note
Virus Warning	Disabled	If set to enabled, the Paragon Anti-Virus. Function will scan your boot drive for boot virusses. If a boot virus is detected, the BIOS will display a warning message.	Default
	Enabled		



Cache Memory Options

	Setting	Description	Note
CPU Internal Cache	Disabled		
	Enabled	Enables the CPU's internal cache.	Default
External Cache	Disabled		
	Enabled	Enables the external memory.	Default

L2 Cache Memory

	Setting	Description	Note
CPU L2 Cache ECC Checking	Disabled		
	Enabled	This option activates the CPU L2 cache ECC checking function.	Default

Floppy Driver Settings

	Setting	Description	Note
Swap Floppy Drive	Disabled		Default
	Enabled	Changes the sequence of A and B drives.	

Boot Up Floppy Seek

	Setting	Description	Note
Boot Up Floppy Seek	Disabled	Seeks disk drives during boot up. Disabling speeds boot up.	
	Enabled		Default

Boot Up NumLock Status

	Setting	Description	Note
Boot Up NumLock Status	On	Puts numeric keypad in NumLock mode at boot-up.	Default
	Off	Puts numeric keypad in arrow key mode at boot-up.	



Gate A20 Options

	Setting	Description	Note
Gate A20 Options	Normal	Lets chipset control GateA20.	
	Fast	A pin in the keyboard controller controls GateA20.	Default

Typematic Settings

Typematic Settings	Setting	Description	Note
Typematic Rate Setting	Disabled	Keystrokes repeat at a rate determined by the keyboard.	Default
	Enabled	When enabled, the typematic rate and typematic delay can be selected.	

The following [Typematic Rate] and [Typematic Delay] fields are active only if [Typematic Rate Setting] is set to [Enabled]

Typematic Rate	6 (Char/sec)	Choose the rate at which a character is repeated when holding down a key.	Default
	8 (Char/sec)		
	10 (Char/sec)		
	12 (Char/sec)		
	15 (Char/sec)		
	20 (Char/sec)		
	24 (Char/sec)		
30 (Char/sec)			
Typematic Delay	250 (msec)	Choose how long after you press a key down the character begins repeating.	Default
	500 (msec)		
	750 (msec)		
	1000 (msec)		



Security Option

Use this feature to prevent unauthorized system boot-up or use of BIOS Setup. The following table describes the security settings.

Security Option	Setting	Description	Note
	System	Each time the system is booted, the password prompt appears.	
	Setup	If a password is set, the password prompt only appears when you attempt to enter the BIOS Setup program.	Default

Other Control Options

Other Control Options	Setting	Description	Note
OS Select for DRAM>64MB	OS2	When using an OS2 operating system.	
	Non-OS2	When using another, non-OS2 operating system.	Default
HDD S.M.A.R.T Capability	Disabled		Default
	Enabled		
Video BIOS Shadow	Disabled		
	Enabled	The BIOS is shadowed in a 16K segment if it is enabled and if it has BIOS present. These 16 segments can be shadowed from ROM to RAM. BIOS shadow copies BIOS code from slower ROM to faster RAM. BIOS can then execute from RAM.	Default

3-4 ADVANCED CHIPSET FEATURES

Select the [Advanced Chipset Features] option from the Main Menu and press [Enter] key.



Caution: Change these settings only if you are already familiar with the Chipset.

The [Advanced Chipset Features] option changes the values of the chipset registers. These registers control the system options in the computer.

CMOS Setup Utility – Copyright (C) 1984-2001 Award Software
Advanced Chipset Features

<ul style="list-style-type: none"> ▶ DRAM Clock/Driver Control Press Enter ▶ AGP & P2P Bridge Control Press Enter ▶ CPU & PCI Bus Control Press Enter Memory Hole Disabled System BIOS Cacheable Disabled Video RAM Cacheable Disabled Memory Parity/ECC Check Disabled 	<p>Item Help</p> <hr/> <p>Menu Level ▶</p>
--	--

↑↓:Move Enter:Select +/-/PU/PD:Value F10:Save ESC:Exit F1:General Help
 F5:Previous Values F6:Fail-Safe Defaults F7: Optimized Defaults

After you have completed the changes, press [Esc] and follow the instructions on your screen to save your settings or exit without saving. The following table describes each field in the Advanced Chipset Features Menu and how to configure each parameter.

CHIPSET FEATURES SETUP

CHIPSET FEATURES	Setting	Description	Note
Memory Hole	Disabled		Default
	Enabled	Some interface cards will map their ROM address to this area. If this occurs, select [Enabled] in this field.	
System BIOS Cacheable	Disabled		
	Enabled	The ROM area F0000H-FFFFFFH is cacheable.	Default
Video RAM Cacheable	Disabled	When synchronous DRAM is installed, the number of clock cycles of CAS latency depends on the DRAM timing. Do not reset this field from the default value specified by the system designer	Default
	Enabled		
Memory Parity/ECC Check	Disabled		Default
	Enabled	This item enabled to detect the memory parity and Error Checking & Correcting.	

3-4.1 DRAM Clock/Drive Control



Caution: Change these settings only if you are already familiar with the Chipset.

The [DRAM Clock/Drive Control] option changes the values of the chipset registers. These registers control the system options in the computer.

CMOS Setup Utility – Copyright (C) 1984-2001 Award Software
DRAM Clock/Drive Control

Current FSB Frequence	66MHz	Item Help
DRAM Clock	By SPD	
DRAM Timing	By SPD	
x SDRAM Cycle Length	2.5	Menu Level ▶
x Bank Interleave	Disabled	
DRAM Command Rate	2T Command	

↑↓→:Move Enter:Select +/-/PU/PD:Value F10:Save ESC:Exit F1:General Help
F5:Previous Values F6:Fail-Safe Defaults F7: Optimized Defaults

After you have completed the changes, press [Esc] and follow the instructions on your screen to save your settings or exit without saving.



DRAM Clock/Drive Control

	Setting	Description	Note
DRAM Clock /Driver Control	By SPD	This item allows you to control the DRAM speed.	Default
	HCLK-33M		
	HCLK+33M		
DRAM Timing	By SPD	If enable the DRAM will auto detect the DRAM timing.	Default
	Manual		
SDRAM Cycle Length	2.5	When synchronous DRAM is installed, the number of clock cycles of CAS latency depends on the DRAM timing. Do not reset this field from the default value specified by the system designer.	Default
	2		
Bank Interleave	Disabled	Increase DRAM performance.	
	2 Bank		Default
	4 Bank		
DRAM Command Rate	2T Command	Increase DRAM performance.	Default
	1T Command		



3-4.2 AGP & P2P Bridge Control



Caution: Change these settings only if you are already familiar with the Chipset.

The [AGP & P2P Bridge Control] option changes the values of the chipset registers. These registers control the system options in the computer.

CMOS Setup Utility – Copyright (C) 1984-2001 Award Software
AGP & P2P Bridge Control

AGP Aperture Size	64M	Item Help
AGP Mode	4X	
AGP Driving Control	Auto	Menu Level ▶
x AGP Driving Value	DA	
AGP Fast Write	Disabled	
AGP Master 1 WS Write	Disabled	
AGP Master 1 WS Read	Disabled	

↑↓→:Move Enter:Select +/-/PU/PD:Value F10:Save ESC:Exit F1:General Help
F5:Previous Values F6:Fail-Safe Defaults F7: Optimized Defaults

After you have completed the changes, press [Esc] and follow the instructions on your screen to save your settings or exit without saving.



3-4.3 AGP & P2P Bridge Control

	Setting	Description	Note
AGP Aperture Size	64M	Select the size of Accelerated Graphics Port (AGP) aperture. The aperture is a portion of the PCI memory address range dedicated for graphics memory address space. Host cycles that hit the aperture range are forwarded to the AGP without any translation.	Default
	4M, 8M, 16M, 32M, 128M, 256M.		
AGP Mode	1X	This item allows you to enable / disable the AGP-4X Mode.	
	2X		
	4X		Default
AGP Driving Control	Auto	This item allows you to adjust the AGP driving force. Choose <i>Manual</i> to key in a AGP Driving Value in the next selection. This field is recommended to set in Auto for avoiding any error in your system.	Default
	Manual		
AGP Driving Value	Min=0000 ~ Max=00FF	This item allows you to adjust the AGP driving force.	
AGP Fast Write	Disabled	The VIA chipset will use fast write to AGP if this item is enabled. Not all AGP cards support fast write.	Default
	Enabled		
AGP Master 1 WS Write	Disabled		Default
	Enabled	When <i>Enabled</i> , writes to the AGP(Accelerated Graphics Port) are executed with one wait states.	
AGP Master 1 WS Read	Disabled		Default
	Enabled	When <i>Enabled</i> , read to the AGP (Accelerated Graphics Port) are executed with one wait states.	



3-4.4 CPU & PCI Bus Control



Caution: Change these settings only if you are already familiar with the Chipset.

The [CPU & PCI Bus Control] option changes the values of the chipset registers. These registers control the system options in the computer.

CMOS Setup Utility – Copyright (C) 1984-2001 Award Software
CPU & PCI Bus Control

CPU to Write Buffer Enabled PCI Master 0 WS Write Enabled PCI Delay Transaction Disabled	Item Help <hr/> Menu Level ▶
---	-----------------------------------

↑↓:Move Enter:Select +/-/PU/PD:Value F10:Save ESC:Exit F1:General Help
 F5:Previous Values F6:Fail-Safe Defaults F7: Optimized Defaults

After you have completed the changes, press [Esc] and follow the instructions on your screen to save your settings or exit without saving.



CPU & PCI Bus Control

	Setting	Description	Note
CPU to PCI Write Buffer	Disabled	When this field is <i>Enabled</i> , writes from the CPU to the PCI bus are buffered, to compensate for the speed differences between the CPU and the PCI bus. When <i>Disabled</i> , the writes are not buffered and the CPU must wait until the write is complete before starting another write cycle.	Default
	Enabled		
PCI Master 0 WS Write	Disabled	When <i>Enabled</i> , writes to the PCI bus are executed with zero wait states.	Default
	Enabled		
PCI Delay Transaction	Disabled	The chipset has an embedded 32-bit posted write buffer to support delay transactions cycles. Select <i>Enabled</i> to support compliance with PCI specification version 2.1.	Default
	Enabled		

3-5 INTEGRATED PERIPHERALS

Select the [Integrated Peripherals] option from the Main Menu and press [Enter] key.



Caution: Change these settings only if you are already familiar with the Chipset.

The [INTEGRATED PERIPHERALS] option changes the values of the chipset registers. These registers control the system options in the computer. The following screen shows setup default settings.

CMOS Setup Utility – Copyright (C) 1984-2001 Award Software
Integrated Peripherals

<ul style="list-style-type: none"> ▶ VIA OnChip IDE Device Press Enter ▶ VIA OnChip PCI Device Press Enter ▶ VIA SuperIO Device Press Enter Init Display First PCI Slot OnChip USB Controller All Enabled USB Keyboard Support Disabled IDE HDD Block Mode Enabled PWRON After PWR-Fail Off 	<p>Item Help</p> <hr/> <p>Menu Level ▶</p>
---	--

↑↓→:Move Enter:Select +/-:PU/PD:Value F10:Save ESC:Exit F1:General Help
 F5:Previous Values F6:Fail-Safe Defaults F7: Optimized Defaults

After you have completed the changes, press [Esc] and follow the instructions on your screen to save your settings or exit without saving.

INTEGRATED PERIPHERALS

	Setting	Description	Note
Init Display First	PCI Slot	Choose which card – AGP	Default
	AGP	Display card or PCI VGA card – to initialize first.	



INTEGRATED PERIPHERALS

	Setting	Description	Note
OnChip USB Controller	All Disabled	This should be enabled if your system has a USB installed on the system board and you want to use it. Even when so equipped, if you add a higher performance controller, you will need to disable this feature. Port 1 means USB1&2 Port 2 means USB3&4 Port 3 means USB5&6	Default
	All Enabled		
	1&2 USB Port		
	2&3 USB Port		
	3&1 USB Port		
	1 USB Port		
	2 USB Port		
3 USB Port			
USB Keyboard Support	Disabled	Select <i>Enabled</i> if your system contains a Universal Serial Bus (USB) controller and you have a USB keyboard.	Default
	Enabled		
IDE HDD Block Mode	Disabled	Invokes multi-sector transfer instead of one sector per transfer. Not all HDDs support this function.	Default
	Enabled		
PWRON After PWR-Fail	Off	The system will switch on when power comes back after a power failure.	Default
	On	The system will remain off when power comes back after a power failure.	
	Former-Sts	The system will return to the state it was in before the power failure when power returns. (i.e: If the system was on, it will switch on again, if it was off, it will remain off)	



3-5.1 VIA OnChip IDE Device



Caution: Change these settings only if you are already familiar with the Chipset.

The [VIA OnChip IDE Device] option changes the values of the chipset registers. These registers control the system options in the computer.

The following screen shows setup default settings.

CMOS Setup Utility – Copyright (C) 1984-2001 Award Software
VIA OnChip IDE Device

OnChip IDE Channel0	Enabled	Item Help
OnChip IDE Channel1	Enabled	
IDE Prefetch Mode	Enabled	Menu Level ▶
Primary Master PIO	Auto	
Primary Slave PIO	Auto	
Secondary Master PIO	Auto	
Secondary Slave PIO	Auto	
Primary Master UDMA	Auto	
Primary Slave UDMA	Auto	
Secondary Master UDMA	Auto	
Secondary Slave UDMA	Auto	

↑↓:Move Enter:Select +/-:PU/PD:Value F10:Save ESC:Exit F1:General Help
F5:Previous Values F6:Fail-Safe Defaults F7: Optimized Defaults

After you have completed the changes, press [Esc] and follow the instructions on your screen to save your settings or exit without saving.



VIA OnChip IDE Device

	Setting	Description	Note
On-Chip PCI IDE ➤ Primary ➤ Secondary	Disabled	Turn off the on-board IDE	
	Enabled	Use the on-board IDE	Default
IDE ➤ Primary Master PIO ➤ Primary Slave PIO ➤ Secondary Master PIO ➤ Secondary Slave PIO	mode 0-4	0 is the slowest speed 4 is the fastest speed	
	Auto	For better performance and stability, we suggest you use the Auto setting to set the HDD control timing.	Default
IDE ➤Primary Master UDMA ➤Primary Slave UDMA ➤Secondary Master UDMA ➤Secondary Slave UDMA	Disabled		
	Auto	Select Auto to enable Ultra DMA Mode support.	Default

3-5.2 VIA OnChip PCI Device



Caution: Change these settings only if you are already familiar with the Chipset.

The [VIA OnChip PCI Device] option changes the values of the chipset registers. These registers control the system options in the computer.

The following screen shows setup default settings.

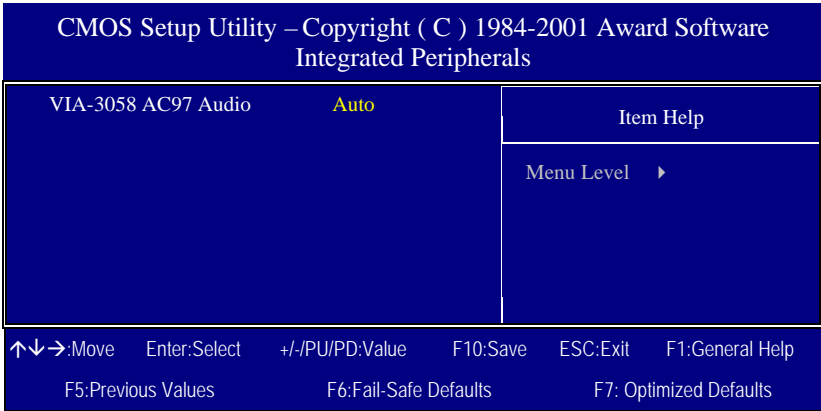

After you have completed the changes, press [Esc] and follow the instructions on your screen to save your settings or exit without saving.

VIA OnChip PCI Device

	Setting	Description	Note
VIA-3058 AC97 Audio	Auto	This item allows you to control the onboard AC 97 audio.	Default
	Disabled		

3-5.3 VIA SuperIO Device



Caution: Change these settings only if you are already familiar with the Chipset.

The [VIA SuperIO Device] option changes the values of the chipset registers. These registers control the system options in the computer. The following screen shows setup default settings.

CMOS Setup Utility – Copyright (C) 1984-2001 Award Software
VIA SuperIO Device

Onboard FDD Controller	Enabled	Item Help Menu Level ▶
Onboard Serial Port 1	3F8/IRQ4	
Onboard Serial Port 2	2F8/IRQ3	
UART Mode Select	Normal	
x RxD , TxD Active	Hi , Lo	
x IR Transmission Delay	Enabled	
x UR2 Duplex Mode	Half	
x Use IR Pins	IR-Rx2Tx2	
Onboard Parallel Port	378/IRQ7	
Parallel Port Mode	SPP	
x ECP Mode Select	EPP1.7	
x ECP Mode Use DMA	3	
Game Port Address	201	
Midi Port Address	330	
Midi Port IRQ	10	

↑↓:Move Enter:Select +/-/PU/PD:Value F10:Save ESC:Exit F1:General Help
F5:Previous Values F6:Fail-Safe Defaults F7: Optimized Defaults

After you have completed the changes, press [Esc] and follow the instructions on your screen to save your settings or exit without saving.

VIA SuperIO Device

	Setting	Description	Note
Onboard FDD controller	Disabled	Turn off the on-board floppy controller	
	Enabled	Use the on-board floppy controller	Default



VIA SuperIO Device

	Setting	Description	Note
Onboard Serial Port 1 / Serial Port 2	Disabled		
	3F8/IRQ4	Choose serial port 1 & 2's I/O address.	Default (port 1)
	2F8/IRQ3	Do not set port 1 & 2 to the same address except for	Default (port 2)
	3E8/IRQ4	Disabled or Auto.	
	2E8/IRQ3		
	Auto		
UART 2 Mode	IrDA	The second serial port offers these InfraRed interface modes.	
	ASKIR		
	Normal		Default
If [UART Mode Select] is set to [IrDA]/[ASKIR]			
RxD, TxD Active	Hi, Hi	This item allows you to determine the active RxD, TxD.	
	Hi, Lo		Default
	Lo, Hi		
	Lo, Lo		
IR Transmission Delay	Disabled	Some IR devices need this item enabled.	
	Enabled		Default
UR2 Function Duplex	Half	Choose [Half] or [Duplex] to set UR2 in half duplex mode or full duplex mode respectively. Refer to your IR device specifications to select the suitable mode.	Default
	Full		
Use IR Pins	RxD2		
	TxD2		
	IR-Rx2Tx2		Default



VIA SuperIO Device

	Setting	Description	Note
Onboard Parallel Port	Disabled	Choose the printer I/O address.	
	378/IRQ7		Default
	278/IRQ5		
	3BC/IRQ7		
Parallel Port Mode	SPP	The mode depends on your external device that connects to this port.	Default
	EPP		
	ECP		
	ECP+EPP		
If [Parallel Port Mode] is set to [ECP] mode			
ECP Mode use	3	Choose DMA3	Default
DMA	1	Choose DMA1	
If [Parallel Port Mode] is set to [EPP] mode			
Parallel Port EPP TYPE	EPP 1.9	Select EPP port type 1.9	
	EPP 1.7	Select EPP port type 1.7	Default

This field controls the onboard legacy audio.

	Setting	Description	Note
Game Port (200-207H)	Disabled	Set this item to enabled to make use of the game port.	
	201		Default
	209		
Midi Port Address	Disabled	Select the I/O address for your MIDI functionality.	
	330		Default
	300		
	290		
Midi Port IRQ	5	Select the IRQ for your MIDI port.	
	10		Default

3-6 POWER MANAGEMENT SETUP

The [POWER MANAGEMENT SETUP] sets the system's power saving functions.

CMOS Setup Utility – Copyright (C) 1984-2001 Award Software
Power Management Setup

▶ ACPI Suspend Type	S1 (POS)	Item Help
Power Management Option	User Define	Menu Level ▶
HDD Power Down	Disable	
Suspend Mode	Disable	
Video Off Option	Suspend -> Off	
Video Off Method	V/H SYNC+Blank	
MODE Use IRQ	3	
Soft-Off by PWRBTN	Instant-Off	
▶ IRQ/Event Activity Detect	Press Enter	

↑↓:Move Enter:Select +/-/PU/PD:Value F10:Save ESC:Exit F1:General Help
F5:Previous Values F6:Fail-Safe Defaults F7: Optimized Defaults

CMOS Setup Utility – Copyright (C) 1984-2001 Award Software
IRQ/Event Activity Detect

PS2KB Wakeup from S3/S4/S5	Disabled	Item Help
USB Resume from S3/S4/S5	Disabled	Menu Level ▶
VGA	OFF	
LPT & COM	LPT/COM	
HDD & FDD	ON	
PCI Master	OFF	
PowerOn by PCI Card	Disabled	
Modem Ring Resume	Disabled	
RTC Alarm Resume	Disabled	
x Date (of Month)	0	
x Resume Time (hh:mm:ss)	Ⓜ Ⓠ Ⓠ	
▶ IRQs Activity Monitoring	Press Enter	

↑↓:Move Enter:Select +/-/PU/PD:Value F10:Save ESC:Exit F1:General Help
F5:Previous Values F6:Fail-Safe Defaults F7: Optimized Defaults

After you have completed the Power Management Setup, press [Esc] to return to the Main Menu.



Power Management Controls

	Setting	Description	Note
ACPI Suspend Type	S1(POS)	The system will enter the S1 state during suspend. (Low latency wake up)	Default
	S3(STR)		
Power Management Option	User Define	Lets you define the system power down times.	Default
	Min Saving		15 Min
	Max Saving		1 Min
HDD Power Down	Disabled	Lets you define the system power down times.	Default
	1Min, 2Min, 3Min, 4Min, 5Min, 6Min, 7Min, 8Min, 9Min, 10Min, 11Min, 12Min, 13Min, 14Min, 15Min		
Suspend Mode	Disabled	Lets you define the system power down times.	Default
	1Min, 2Min, 4Min, 6Min, 8Min, 10Min, 20Min, 30Min, 40Min, 1Hour,		
Video Off Option	Suspend --> Off	When enabled, this feature allows the VGA adapter to operate in a power saving mode.	Default
	Always On		
	All Modes --> Off		
Video Off Method	V/H Sync+Blank	Selects the method by which the monitor is blanked.	Default
	Blank screen		
	DPMS Support		



Power Management Controls (Continued)

	Setting	Description	Note
MODEM Use IRQ	3	Assigns an IRQ# to the modem device.	Default
	3-11, NA		
Soft-Off by PWR-BTTN	Instant-off		Default
	Delay 4 Sec.	Turns off the system power 4 seconds after pushing the power button.	
IRQ/Event Activity	Press Enter	Select items that will wake up your system when in one of sleep modes. Press enter to go the select item page.	

IRQ/Event Activity Detect

	Setting	Description	Note
PS2KB Wakeup from S3/S4/S5	Disabled	You can set the PS2KB Hotkey to Wakeup system from S3/S4/S5	Default
	Ctrl+F1~F12		
	Power		
	Any Key		
USB Resume from S3/S4/S5	Disabled	You can set the USB to Resume system from S3/S4/S5	Default
	Enabled		
LPT & COM	LPT/COM	When <i>On of</i> LPT & COM, any activity from one of the listed system peripheral devices or IRQs wakes up the system.	Default
	NONE, LPT, COM		
HDD & FDD	OFF	When <i>On of</i> HDD & FDD, any activity from one of the listed system peripheral devices wakes up the system.	Default
	ON		
PCI Master	OFF	When <i>On of</i> PCI Master, any activity from one of the listed system peripheral devices wakes up the system	Default
	ON		



IRQ/Event Activity Detect

	Setting	Description	Note
PowerOn by PCI Card	Disabled	If enabled any PCI interrupt will wake up the system.	Default
	Enabled		
Modem Ring Resume	Disabled	An input signal on the serial Ring Indicator (RI) line (in other words, an incoming call on the modem) awakens the system from a soft off state.	Default
	Enabled		
RTC Alarm Resume	Disabled	The system ignores the alarm.	Default
	Enabled	Set alarm to power on the system by the date (1-31) or time (hh:mm:ss). If the date is set to [0], the system will self-power on by alarm everyday at the set time.	



3-6.1 IRQs Activity Monitoring

This option sets the IRQs Activity Monitoring.

CMOS Setup Utility – Copyright (C) 1984-2001 Award Software
IRQs Activity Monitoring

Primary INTR	NO	Item Help Menu Level ▶
IRQ3 (COM 2)	Enabled	
IRQ4 (COM 1)	Enabled	
IRQ5 (LPT 2)	Enabled	
IRQ6 (Floppy Disk)	Enabled	
IRQ7 (LPT 1)	Enabled	
IRQ8 (RTC Alarm)	Disabled	
IRQ9 (IRQ2 Redir)	Disabled	
IRQ10 (Reserved)	Disabled	
IRQ11 (Reserved)	Disabled	
IRQ12 (PS/2 Mouse)	Enabled	
IRQ13 (Coprocesor)	Enabled	
IRQ14 (Hard Disk)	Enabled	
IRQ15 (Reserved)	Disabled	

↑↓→:Move Enter:Select +/-/PU/PD:Value F10:Save ESC:Exit F1:General Help
 F5:Previous Values F6:Fail-Safe Defaults F7: Optimized Defaults

After you have completed the changes, press [Esc] and follow the instructions on your screen to save your settings or exit without saving.

IRQs Activity Monitoring

Wake Up Events	Setting	Description	Note
Primary INTR	ON	When set to <i>On</i> , any event occurring at will awaken a system which has been powered down.	Default
	OFF		
IRQs Activity Monitoring (Press Enter)	Primary	IRQ3(COM2), IRQ4(COM1), IRQ5(LPT2), IRQ6(Floppy Disk), IRQ7(LPT1), IRQ12(PS/2 mouse), IRQ13(Coprocessor), IRQ14(HardDisk)	
	Secondary	IRQ9(IRQ2 Redir), IRQ10(Reserved), IRQ11(Reserved)	
	Disabled	IRQ8 (RTC Alarm), IRQ15 (Reserved)	



3-7 PNP/PCI CONFIGURATIONS

This option sets the Motherboard’s PCI Slots.

CMOS Setup Utility – Copyright (C) 1984-2001 Award Software
PnP/PCI Configurations

PnP OS Installed	NO	Item Help
Reset Configuration Data	Disabled	
Resources Controlled By	Auto (ESCD)	Menu Level ▶ Select Yes if you are using a Plug and Play capable operating system Select No if you need the BIOS to configure non-boot devices
x IRQ Resources	Press Enter	
PCI/VGA Palette Snoop	Disabled	
Assign IRQ For VGA	Enabled	
Assign IRQ For USB	Enabled	

↑↓→:Move Enter:Select +/-/PU/PD:Value F10:Save ESC:Exit F1:General Help
 F5:Previous Values F6:Fail-Safe Defaults F7: Optimized Defaults



Note: Starred (*) items will disappear when the [Resources Controlled By] option is set to [Auto].

After you have completed the PCI Slot Configuration, press [Esc] and follow the instructions on your screen to save your settings or exit without saving.

PNP/PCI Configuration Controls

PNP/PCI Controls	Setting	Description	Note
PnP OS Installed	Yes	Set this field to [Yes] if you are running Windows 95, which is PnP compatible.	
	No	If the OS you are running does not support PnP configuration.	Default (If there is any doubt, set this field to [No])
Reset Configuration Data	Disabled	Retain PnP configuration data in BIOS.	Default
	Enabled	Reset PnP configuration data in BIOS.	
Resources Controlled By	Manual	BIOS does not manage PCI/ISA PnP card IRQ assignment. Requires to assign IRQ-# and DMA-# to PCI or ISA PnP manually. IRQ-3,4,5,7,9,10,11,12,14,15 assigned to: _ DMA-0,1,3,5,6,7 assigned to: _	
	Auto (ESCD)	The Plug-and-Play BIOS auto manages PCI/ISA PnP card IRQ assignment automatically.	Recommended
If [Resources Controlled By] is set to [Manual]			
IRQ-# and DMA-# assigned to:	PCI/ISA PnP	Choose IRQ-# and DMA-# assigned to PCI/ISA PnP card.	IRQ-3,4,5,7,9,10,11,12,14,15 DMA-0,1,3,5,6,7
	Legacy ISA	Choose IRQ-# and DMA-# assigned to Legacy ISA card.	IRQ-3,4,5,7,9,10,11,12,14,15 DMA-0,1,3,5,6,7
Under this item the user can assign an IRQ to a PCI slot. However, there under some conditions the IRQ will not be assigned as selected under this item: 1. IRQs 0, 1, 2, 6, 8, 13 can NOT be assigned, because they are fixed. 2. IRQs 5, 9, 10, 11 are available 3. IRQs 3,4,7,12,14 and 15 will only be assigned if they are free. See the table below on how to free them:			

PNP/PCI Configuration Setup (Continued)

PNP/PCI Setup	Setting	Description	Note
Interrupt Line	How to set the BIOS to release the IRQ to the PnP Interrupt pool:		
	PnP / PCI configuration	Integrated Peripherals	
IRQ 15	IRQ 15: PCI / ISA PnP	On-Chip Secondary PCI IDE:	disabled
IRQ 14	IRQ 14: PCI / ISA PnP	On-Chip Primary PCI IDE:	disabled
IRQ 12	IRQ 12: PCI / ISA PnP	<i>Interrupt 12 will be released by the PnP BIOS automatically if the PS/2 Mouse Port is not used.</i>	
IRQ 7	IRQ 7: PCI / ISA PnP	Onboard parallel port:	disabled
IRQ 4	IRQ 4: PCI / ISA PnP	Onboard Serial port 1:	disabled
IRQ 3	IRQ 3: PCI / ISA PnP	Onboard Serial port 2:	disabled
4. Your OS may reassign another interrupt to a PCI slot after BIOS passes control to the OS, especially if you use Windows 95, 98 or NT.			
Assign IRQ For VGA/USB	Disabled	BIOS will assign IRQ for VGA/USB port.	
	Enabled	BIOS won't assign IRQ for VGA/USB port.	Default
5. Your OS may reassign another interrupt to a PCI slot after BIOS passes control to the OS, especially if you use Windows 95, 98 or NT.			
INT Pin 1/2/3/4 Assignment	Auto	Set to Auto the BIOS will using IRQs Automatically.	Default

MULTI I/O ADDRESSES

Default settings for multi-I/O addresses are as follows:

Port	I/O Address	IRQ	Status
LPT1	378H	7	ECP/EPP
COM1	3F8H	4	
COM2	2F8H	3	



Warning: If a default I/O address conflicts with other I/O cards such as sound card, you must change one of the I/O addresses to remedy to this address conflict. (I/O addresses can be adjusted from the BIOS Setup Utility)



3-8 PC HEALTH STATUS

This option sets the Motherboard's PC Health Status.

CMOS Setup Utility – Copyright (C) 1984-2001 Award Software
PC Health Status

CPU Warning Temp.	Disabled	Item Help Menu Level ▶
Current SYS Temp.	33 °C / 191 °F	
Current CPU Temp.	33 °C / 191 °F	
Current CPUFAN Speed	5192 RPM	
Current CHAFAN Speed	0 RPM	
Vcore	1.98 V	
3.3 V	3.36 V	
+ 5 V	4.97 V	
- 12 V	12.03 V	
+12 V	-12.19 V	
- 5 V	- 4.99 V	
VBAT (V)	3.16V	
5VSB (V)	5.46V	
Shutdown Twmperatuer	Disabled	

↑↓:Move Enter:Select +/-/PU/PD:Value F10:Save ESC:Exit F1:General Help
F5:Previous Values F6:Fail-Safe Defaults F7: Optimized Defaults



Note: Starred (*) items will disappear when the [Resources Controlled By] option is set to [Auto].

CPU Device Monitoring

CPU Device Monitoring	Setting	Description	Note
CPU Warning Temperature	Disabled		Default
	50°C/122°F	Set CPU temperature from 50°C to 70°C. The CPU will slow down when CPU temperature goes beyond the preset value. The CPU will continue to run slow until the temperature returns back within the safe range.	
	53°C/127°F		
	56°C/132°F		
	60°C/140°F		
	63°C/145°F		
	66°C/150°F		
70°C/158°F			
Current CPU Temp.	°C/°F	Show the current status of CPU temperature.	
Current System Temp.	°C/°F	Show the current status of the system temperature.	
Current CPUFAN/ CHAFAN Speed	RPM	Show the current status of CPU Fan	
Vcore 3.3V, +5V, +12V, -12V, -5V, VBAT(V), 5VSB(V)	V	Show the current voltage status.	
Shutdown Temperature	Disabled	This item allows you to set up the CPU shutdown Temperature. This item only effective under Windows 98 ACPI mode.	Default
	60°C/140°F,		
	65°C/149°F, 70°C/158°F,		

3-9 LOAD FAIL-SAFE DEFAULTS

Select the [Load Fail-Safe Defaults] option from the Main Menu to load the system values you have previously saved. This option is recommended if you need to reset the system setup and to retrieve the old values.

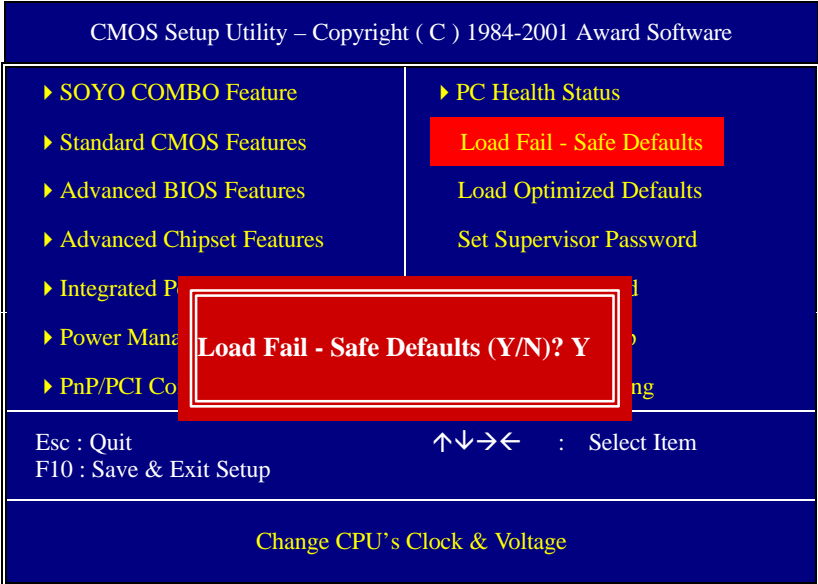

Type [Y] to use the Setup Defaults followed by [Enter] or otherwise [N] to return to the Main Menu and keep current values.



Warning: If you run into any problem after changing the BIOS configuration, please load the Fail-Safe Defaults for stable performance.

3-10 LOAD OPTIMIZED DEFAULTS

Select the [Load Optimized Defaults] option from the Main Menu to load the system values you have previously saved. This option is recommended if you need to reset the system setup and to retrieve the old values.

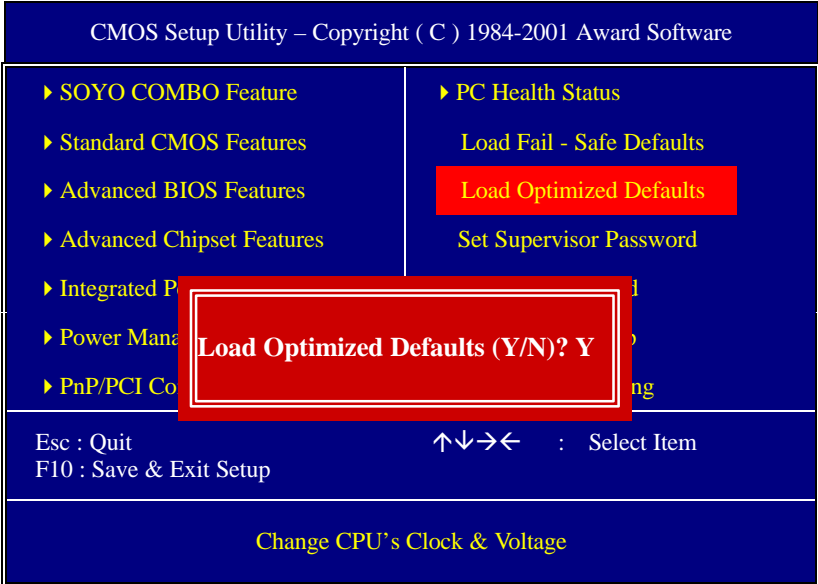

Type [Y] to use the Setup Defaults followed by [Enter] or otherwise [N] to return to the Main Menu and keep current values.



Warning: If you run into any problem after changing the BIOS configuration, please load the Fail-Safe Defaults for stable performance.

3-11 SET SUPERVISOR PASSWORD

Based on the setting you have made in the [Security Option] of the [BIOS FEATURES SETUP] section, the password prevents access to the system or the setup program by unauthorized users. Follow this procedure to set a new password or disable the password:

1. Choose [BIOS FEATURES SETUP] in the Main Menu and press [Enter]. Select the [Security Options] item and set the field to:
 - a. [System]: The password is required every time the system is booted. This means only a person who knows the password can use this computer.
 - b. [Setup]: The password is required only when you attempt to enter the BIOS Setup program.

2. Choose [SUPERVISOR PASSWORD] from the Main Menu and press [Enter]. The following prompt appear:

Enter Password:



Warning: If you forget or lose the password, the only way to access the system is to set jumper JP5 to clear the CMOS RAM. All setup information is lost and you must run the BIOS setup program again.



Note: If you do not wish to use the password function, press [Enter] directly and the following message appears:

Password Disabled!!

- 3. Enter your new password and press [Enter]. The following message appears, prompting to confirm the new password:

Confirm Password:

- 4. Re-enter your password and then press [Enter] to exit to the Main Menu.

This diagram outlines the password selection procedure:

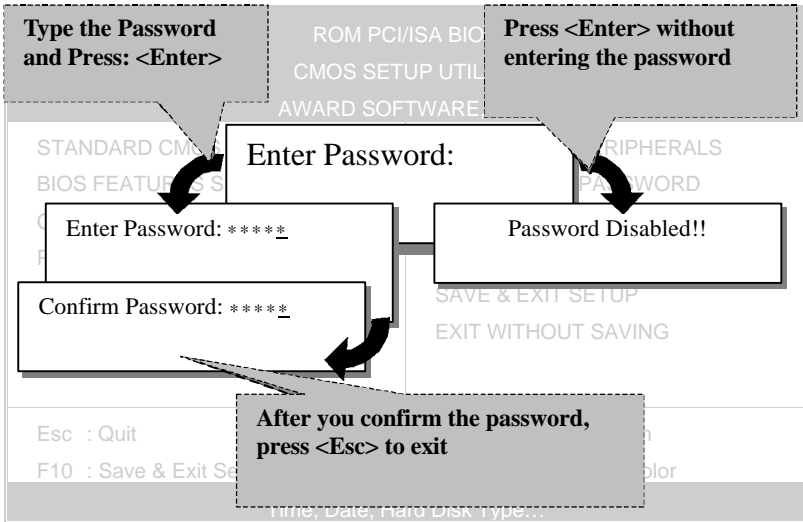

3-12 SET USER PASSWORD

When the user password option is on, you are not allowed to change any setting in the [CMOS SETUP UTILITY] except for changing the user's password.

The password setting procedure is similar to that for the [SUPERVISOR PASSWORD] (Refer to section 3-9).



3-13 IDE HDD AUTO DETECTION

This Main Menu function automatically detects the hard disk type and configures the [Standard CMOS Features] accordingly.

CMOS Setup Utility – Copyright (C) 1984-2001 Award Software
IDE Primary Master

IDE HDD Auto-Detection	Press Enter	Item Help
IDE Primary Master	Auto	Menu Level ▶
Capacity		0 MB
Access Mode	Auto	
		0
Cylinder		0
Head		0
Precomp		0
Landing Zone		0
Sector		0

↑↓:Move Enter:Select +/-/PU/PD:Value F10:Save ESC:Exit F1:General Help
F5:Previous Values F6:Fail-Safe Defaults F7: Optimized Defaults



Note: This function is only valid for IDE type of hard disk drives.

Boot Menu

Boot Menu enables user to boot-up on different boot device without going into the BIOS setup.

To enable boot Menu, press “ESC” after memory initialization, user will see a device menu, in which user can choose the device they wish to boot from.

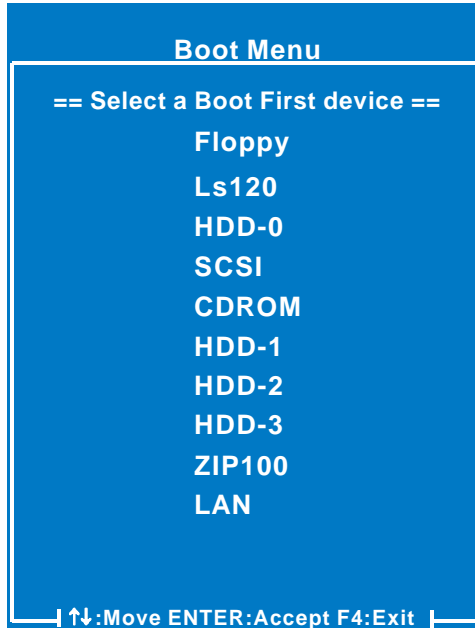

Chapter 4

DRIVERS INSTALLATION



The SOYO-CD will NOT autorun if you use it on an Operating System other than Windows 9x or NT.

Your SY-7VDA Motherboard comes with a CD-ROM labeled "SOYO CD." The SOYO CD contains (1) the user's manual file for your new Motherboard, (2) the drivers software available for installation, and (3) a database in HTML format with information on SOYO Motherboards and other products.

Step 1. Insert the SOYO CD into the CD-ROM drive
If you use Windows NT, the SOYO-CD will not detect your motherboard type. In that case the following dialog will pop up, please choose your motherboard and press OK. Now the SOYO-CD Start Up Menu will be shown.

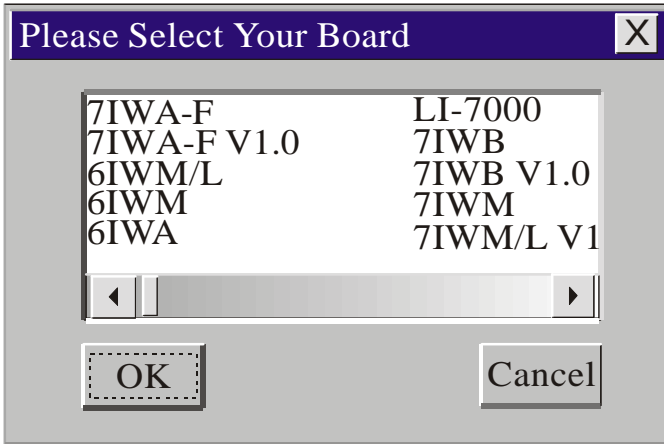

(SOYO CD Start Up Program Menu)

If you use Windows 95 or 98, the SOYO CD Start Up Program automatically detects which SOYO Motherboard you own and displays the corresponding model name.

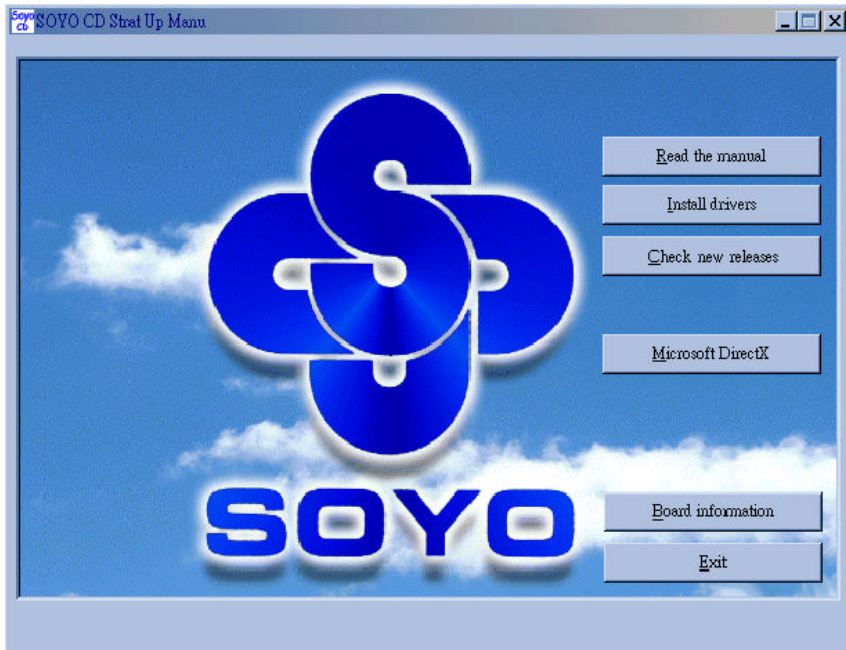

The user's manual files included on the SOYO CD are in PDF (Postscript Document) format. In order to read a PDF file, the appropriate Acrobat Reader software must be installed in your system.

Note: The Start Up program automatically detects if the Acrobat Reader utility is already present in your system, and otherwise prompts you on whether or not you want to install it. You must install the Acrobat Reader utility to be able to read the user's manual file. Follow the instructions on your screen during installation, then once the installation is completed, restart your system and re-run the SOYO CD.

Step 2. Install Drivers and Utilities

Click the **Install Drivers** button to display the list of drivers software that can be installed with your Motherboard. The Start Up program displays the drivers available for the particular model of Motherboard you own. We recommend that you only install those drivers.

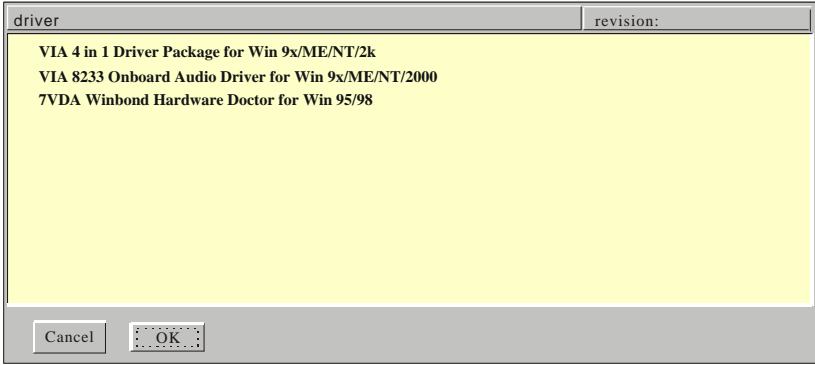

(Driver Installation Menu)

A short description of all available drivers follows:

➤ **VIA 4in1 Driver Package for Win 9x/ME/NT/2k**

VIA 4 In 1 driver includes four system drivers to improve the performance and maintain the stability of systems using VIA chipsets. These four drivers are:

VIA Registry (INF) Driver, VIA AGP VxD driver, VIA ATAPI Vendor Support Driver and VIA PCI IRQ Miniport Driver. For Windows NT users, the VIA IDE Bus Mastering driver is the only driver to be installed in your system.

A description of 4 drivers followa:

— **Bus Master PCI IDE Driver**

The ATAPI IDE driver enables the performance enhancing bus mastering functions on ATA-capable Hard Disk Drives and ensures IDE device compatibility.

—**AGP VxD Driver**

VIA AGP VxD Driver is to be installed if you are using an AGP VGA device. VIAGART.VXD will provide service routines to your VGA driver and interface directly to hardware, providing fast graphical access.

—**VIA Chipset Functions Registry**

VIA Registry (INF) Driver is to be installed under Windows. The driver will enable the VIA Power Management function.

—**IRQ remapping utility (This driver is installed automatically)**

VIA PCI IRQ Miniport Driver is to be installed under Windows 98 only, it sets the system's PCI IRQ routing sequence.

➤ **VIA 8233 Onboard Audio Driver for Win 9x/ME/NT/2000**

You have to install the drivers before installing any application for the Onboard Audio.

➤ **7VDA Winbond Hardware Doctor for Win 95/98**

Your motherboard comes with a hardware monitoring IC. By installing this utility Temperature, Fan speed and Voltages can be monitored. It is also possible to set alarms when current system values exceed or fall below pre-set values.

Step 3. Check the Latest Releases

Click the 'Check the latest Releases' button to go the SOYO Website to automatically find the latest BIOS, manual and driver releases for your motherboard. This button will only work if your computer is connected to the internet through a network or modem connection. Make sure to get your modem connection up before clicking this button.

(Internet Explorer is a Microsoft Trademark)*

