



SY-71ZB+

Motherboard

Socket 370 for Intel Celeron™ Processor
Intel 440 ZX AGP/PCI Motherboard
66 & 100MHz Front Side Bus supported
Baby AT Form Factor

User's Guide
&
Technical Reference

About This Guide

This User's Guide is for assisting system manufacturers and end users in setting up and installing the Motherboard. Information in this guide has been carefully checked for reliability; however, no guarantee is given as to the correctness of the contents. The information in this document is subject to change without notice.

Copyright Notice

Copyright 1998, Soyo Computer Inc. All rights reserved. This manual is copyrighted by Soyo Computer Inc. You may not reproduce, transmit, transcribe, store in a retrieval system, or translate into any language, in any form or by any means, electronic, mechanical, magnetic, optical, chemical, manual or otherwise, any part of this publication without express written permission of Soyo Computer Inc.

Trademarks

Soyo is a registered trademark of Soyo Computer Inc. All trademarks are the property of their owners.

Disclaimer

Soyo Computer Inc. makes no representations or warranties regarding the contents of this manual. We reserve the right to revise the manual or make changes in the specifications of the product described within it at any time without notice and without obligation to notify any person of such revision or change. The information contained in this manual is provided for general use by our customers. Our customers should be aware that the personal computer field is the subject of many patents. Our customers should ensure that their use of our products does not infringe upon any patents. It is the policy of Soyo Computer Inc. to respect the valid patent rights of third parties and not to infringe upon or assist others to infringe upon such rights.

Restricted Rights Legend

Use, duplication, or disclosure by the Government is subject to restrictions set forth in subparagraph (c)(1)(ii) of the Rights in Technical Data and Computer Software clause at 252.277-7013.

Product Rights

Products mentioned in this manual are mentioned for identification purpose only. Product names appearing in this manual may or may not be registered trademarks or copyrights of their respective companies.

If you need any further information, please come to our home page on the Internet. The address is "<http://www.soyo.com.tw>".

Edition: March 1999
Version 1.0
7IZB+ SERIAL

FC Tested To Comply
With FCC Standards
FOR HOME OR OFFICE USE

100% POST CONSUMER
RECYCLED PAPER

Table of Contents

SY-71ZB+ MOTHERBOARD LAYOUT.....1

CHAPTER 1 INTRODUCTION2

1-1 KEY FEATURES.....2

1-2 HANDLING THE MOTHERBOARD.....5

1-3 ELECTROSTATIC DISCHARGE PRECAUTIONS5

CHAPTER 2 HARDWARE SETUP6

2-1 PREPARATIONS6

2-2 UNPACKING THE MOTHERBOARD7

2-3 INSTALLATION GUIDE8

CHAPTER 3 BIOS SETUP UTILITY27

3-1 SOYO COMBO SETUP29

3-2 STANDARD CMOS SETUP34

3-3 BIOS FEATURES SETUP37

3-4 CHIPSET FEATURES SETUP41

3-5 POWER MANAGEMENT SETUP.....44

3-6 PNP/PCI CONFIGURATION SETUP48

3-7 LOAD SETUP DEFAULTS51

3-8 INTEGRATED PERIPHERALS.....52

3-9 SUPERVISOR PASSWORD56

3-10 USER PASSWORD58

3-11 IDE HDD AUTO DETECTION59

CHAPTER 4 DRIVERS INSTALLATION.....60

SY-71ZB+ MOTHERBOARD LAYOUT

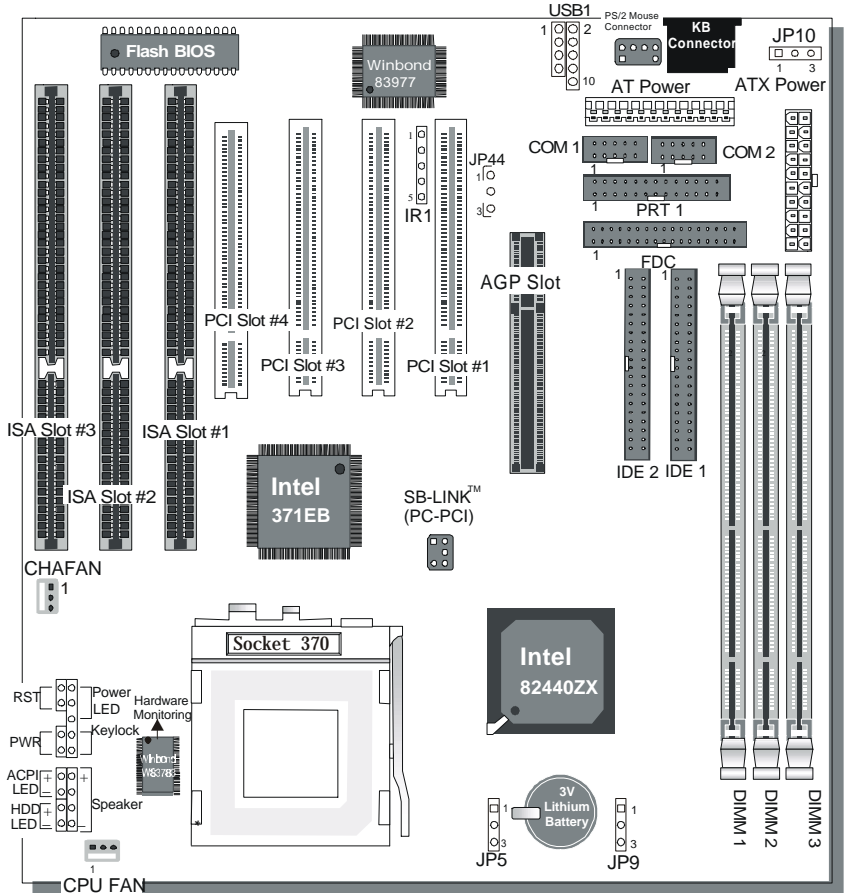

SY-71ZB+ Platform

Chapter 1

INTRODUCTION

The **SY-71ZB+** AGP/PCI Motherboard is a high-performance Celeron® processor supported Baby AT form-factor system board. **SY-71ZB+** uses the 440 ZX Chipset technology and supports Socket 370 Celeron™ processors. This Motherboard is fully compatible with industry standards and adds many technical enhancements.

1-1 KEY FEATURES

- Supports Intel Socket 370 Celeron™ processor (300A~500 MHz)
- Auto-detect CPU voltage
- PC98, ACPI, Ultra DMA/33
- SOYO COMBO Setup
- Supports system memory up to 256 MBytes
- Power-on by modem or alarm
- Supports power-on/off by keyboard
- Supports onboard hardware monitoring and includes Hardware Doctor™ utility
- Supports Creative SB-LINK™ (PC-PCI) for PCI audio
- 1 x 32-bit AGP slot
- 4 x 32-bit bus mastering PCI slots
- 3 x 16-bit ISA slot
- 2 x USB ports onboard
- 1 x IrDA port
- Supports multiple-boot function
- AT & ATX power connectors

SY-71ZB+ PLATFORM FEATURES

Board Size	4-layer PCB, 26 x 22cm("10.24x8.7"), Baby-AT Form Factor
Socket 370	66/100MHz FSB <ul style="list-style-type: none">➤ Celeron™ Processor 300A/333/366/400/433/466/500➤ Built-in full speed 128KB L2 cache.➤ Features Auto-detection of CPU voltage
Chipset	440 ZX AGP Set
ATX Power	20-pin Male Connector
AT Power	12-pin Male connector
CPUFAN	3-pin CPU Cooling Fan Connector
CHAFAN	3-pin Case Cooling Fan Connector
Memory	DIMM Bank (DIMM1~3) <ul style="list-style-type: none">➤ Three strips of 168-pin Unbuffered SDRAM DIMM➤ Supports 8/16/32/64/128MB DIMM modules in each bank➤ Supports up to 256 MBytes of main memory in all three DIMM sockets
BIOS	System BIOS built-in, Award BIOS <ul style="list-style-type: none">➤ APM, ACPI and "Plug-and-Play" function➤ Supports multiple-boot function➤ Onboard FLASH memory for easy upgrade➤ Y2000 Compliant
Bus Controller	Compliant with PCI specifications version 2.1
PCI Slots	4 x 32-bit Bus Mastering Slots
AGP Slot	1 x 32-bit AGP Slot
ISA Slots	3 x 16-bit ISA Slots
IDE1, IDE2	2 x 40-pin Bus Mastering E-IDE/ATAPI Ports <ul style="list-style-type: none">➤ IDE1: Primary IDE Device Connector➤ IDE2: Secondary IDE Device Connector➤ Supports Ultra DMA/33
FDC	1 Floppy Disk Drive (FDD) Port (Supports 1.2MB/1.44MB/2.88MB and LS120/3-mode FDD)
IR1	5-pin Serial Infrared Device Header

Keylock	5-pin KeyLock Header
Reset	2-pin Reset Switch Header
Speaker	4-pin PC Speaker Header
TB_LED	2-pin ACPI LED Header
HDD_LED	2-pin IDE Device LED Header
PWRBT	ATX Power On/Off Switch 2-pin Header
JP5	CMOS Clear Jumper
JP9	AGP operating speed Select Jumper
JP10	Power-On by Keyboard Jumper
JP44	WOL (Wake-On-LAN) 3-pin Header
PRT	25-pin Female external Parallel connector
	➤ ECP/EPP/SPP multi-mode parallel printer port
COM1, COM2	10-pin Serial Port connector
	➤ Feature 2 x high-speed UARTs (with 16550 FIFO)
AT Keyboard	5-pin female AT Keyboard connector
PS/2 Mouse	6-pin male PS/2 mouse connector
USB1,USB2	Dual-row 10-pin header

***These processors are not available yet for testing.**

HANDLING THE MOTHERBOARD

To avoid damage to your Motherboard, follow these simple rules while unpacking:

- Before handling the Motherboard, ground yourself by grasping an unpainted portion of the system's metal chassis.
- Remove the Motherboard from its anti-static packaging. Hold the Motherboard by the edges and avoid touching its components.
- Check the Motherboard for damage. If any chip appears loose, press carefully to seat it firmly in its socket.



Warning: Do not apply power if the Motherboard appears damaged. If there is damage to the board, contact your dealer immediately.

1-2 ELECTROSTATIC DISCHARGE PRECAUTIONS

Make sure to ground yourself before handling the Motherboard or other system components. Electrostatic discharge can easily damage the components. Note that you must take special precautions when handling the Motherboard in dry or air-conditioned environment.

To protect your equipment from electrostatic discharge, take the following precautions:

- Do not remove the anti-static packaging until you are ready to install.
- Ground yourself before removing any system component from its protective anti-static packaging. (To ground yourself, grasp the expansion slot covers or other unpainted portions of the computer chassis.)
- Frequently ground yourself while working or use a grounding strap.
- Handle the Motherboard by its edges and avoid touching its components.

Chapter 2

HARDWARE SETUP

Congratulations on your purchase of **SY-71ZB+** Motherboard. You are about to install and connect your new Motherboard.



Note: Do not unpack the Motherboard from its protective anti-static packaging until you have made the following preparations.

2-1 PREPARATIONS

Gather and prepare all the following hardware equipment to complete the installation successfully:

1. Celeron™ processor with built-in CPU cooling fan (boxed type).



Note: This Motherboard supports non-boxed type CPUs. The heavier CPU cooling fan requires the installation of a CPU support stand included in this Motherboard package.

2. DIMM memory module
3. Computer case and chassis with adequate power supply unit
4. Monitor
5. Keyboard
6. Pointing Device (Serial or PS/2 mouse)
7. Speaker(s) (optional)
8. Disk Drives: HDD, CD-ROM, Floppy drive ...
9. External Peripherals: Printer, Plotter, and Modem (optional)
10. Internal Peripherals: Modem and LAN cards (optional)

2-2 UNPACKING THE MOTHERBOARD

When unpacking the Motherboard, check for the following items:

- The SY-71ZB+ 440 ZX AGP/PCI Motherboard
- This Quick Start Guide *
- The Installation CD-ROM *
- One IDE Device Flat Cable
- One Floppy Disk Drive Flat Cable
- One bracket with one 9-pin serial connector, attached with 9-pin flat cable, and one 6-pin PS/2 mouse connector, attached with 6-pin cable.
- One bracket with one 25-pin connector parallel connector attached with 25-pin flat cable and one 9-pin serial connector attached with 9-pin flat cable.

* If your board comes with a driver disc and a paper manual, the Quick Start Guide and the CD-ROM are not included in the package.



Warning: Do not unpack the Motherboard from its anti-static packaging until you are ready to install it.

Like most electronic equipment, your Motherboard may be damaged by electrostatic discharge. To avoid permanent damage to components ground yourself while working by using a grounding strap. Otherwise, ground yourself frequently by touching the unpainted portion of the computer chassis to drain the static charges.

Handle the Motherboard carefully, holding it by the edges. You are now ready to start the installation.

2-3 INSTALLATION GUIDE

We will now begin the installation of the Motherboard. Please follow the step-by-step procedure designed to lead you to a complete and correct installation.



Warning: Turn off the power to the Motherboard, system chassis, and peripheral devices before performing any work on the Motherboard or system.

Step 1. CPU Installation

Follow these instructions to install your Celeron™ class processor correctly.

Locate the CPU socket labeled Socket 370 on your Motherboard and note the distinctive pinhole arrangement.

Note the corresponding pinhole arrangement on the processor.

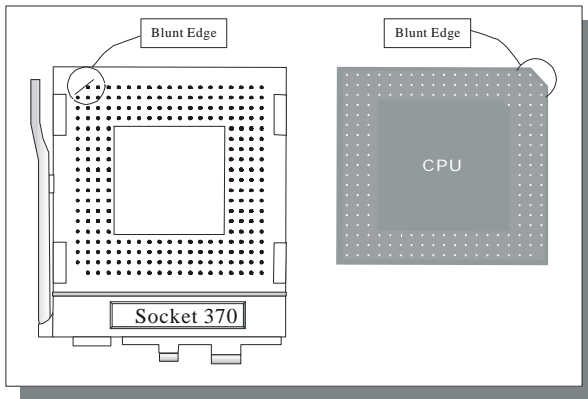

Follow these steps to install the CPU in the Socket 370:

1. Lift the socket handle up to a vertical position.
2. Align the blunt edge of the CPU with the matching pinhole distinctive edge on the socket.
3. Seat the processor in the socket completely and without forcing.
4. Then close the socket handle to secure the CPU in place.

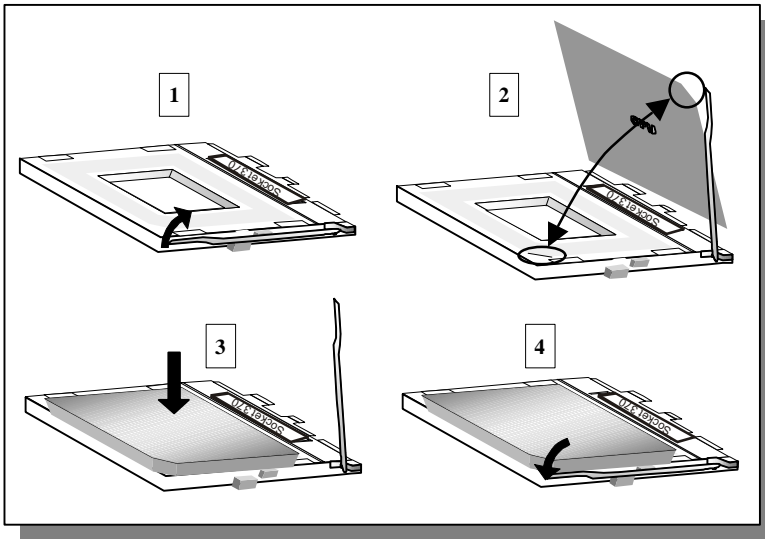

Step 2. CPU Fan Installation

Your Celeron™ processor kit comes with a cooling fan. Mount the fan on the processor according to the instructions provided by the manufacturer. The fan is a key component that will ensure system stability. The fan prevents overheating, therefore prolonging the life of your CPU.



Note: Remember to connect the fan to the appropriate power source.

Step 3. SDRAM Memory Module Installation

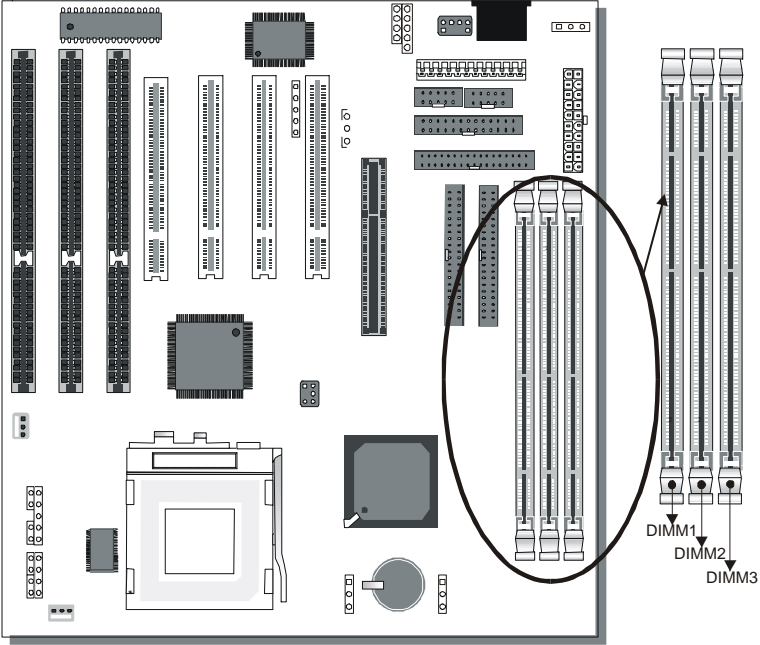

This Motherboard features 3 x DIMM for 168-pin 3.3V unbuffered DIMM modules, providing support for up to 256MB of main memory using DIMM modules from 8MB to 128MB.

Number of Memory Modules	DIMM 1	DIMM 2	DIMM 3
1	Double-sided /Single-sided	Double-sided	
2	Double-sided /Single-sided		Double-sided
3	Double-sided /Single-sided	Single-sided	Single-sided
RAM Type	SDRAM		
Memory Module Size (MB)	8/16/32/64/128 Mbytes		
Note: Because DIMM 2 and 3 are shared, double-sided DIMMs can be used in only one of the DIMMs. With single-sided DIMMs both 2 and 3 can be used.			

Step 4. IDE Device Installation (HDD, CD-ROM)

This Motherboard offers two primary and secondary IDE device connectors (IDE1, IDE2). It can support up to four high-speed HDD or CD-ROM.

Connect one side of the 40-pin flat cable to the IDE device (HDD or CD-ROM) and plug the other end to the primary (IDE1) or secondary (IDE2) directionally keyed IDE connector on the Motherboard.

This Motherboard can support up to four HDDs.

Step 5. Floppy Drive Installation

The system supports 5 possible floppy drive types: 720 KB, 1.2 MB, 1.44 MB, 2.88 MB, and LS-120. In addition, this Motherboard supports a 3-mode (720KB/1.25MB/1.44MB) floppy commonly used in Japan.

Connect one side of the 34-pin flat cable to the floppy drive and plug the other end to the floppy drive connector on the Motherboard.

This Motherboard can support up to 2 floppy drives.

Step 6. Front Panel Connections

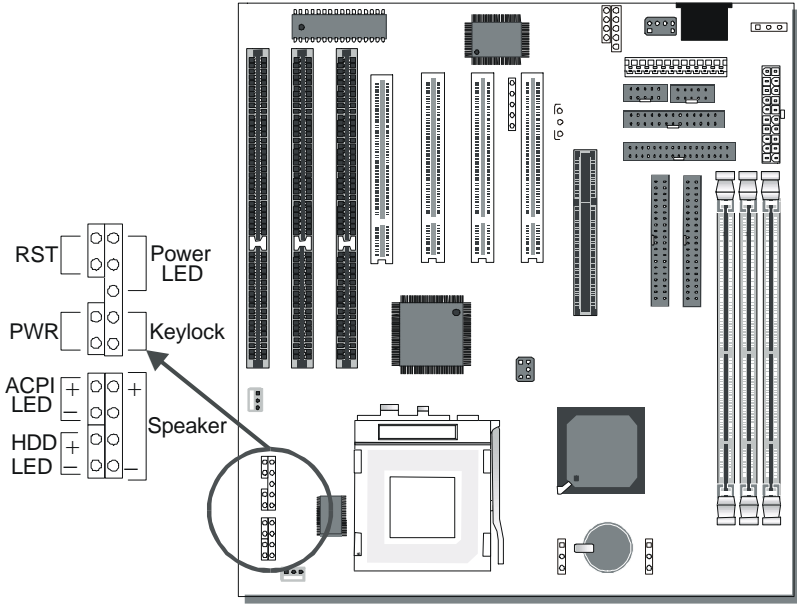

Plug the computer case's front panel devices to the corresponding headers on the Motherboard.

1. Power LED & KeyLock

Plug the Power LED cable into the 5-pin Keylock header.

Some systems may feature a KeyLock function with a front panel switch for enabling or disabling the keyboard. Connect the KeyLock switch to the 5-pin Keylock header on the Motherboard.

Please install according to the following pin assignment: pin 1,3 are for Power LED and pin 4,5 are for Keylock.

2. Reset

Plug the Reset push-button cable into the 2-pin Reset header on the Motherboard. Pushing the Reset button on the front panel will cause the system to restart the boot-up sequence.

3. Speaker

Attach the 4-pin PC speaker cable from the case to the Speaker header on the Motherboard.

4. ACPI LED

Connecting the 2-pin ACPI LED cable to the corresponding ACPI LED header will cause the LED to light whenever the system is in ACPI mode.

The manufacturer has permanently set this Motherboard in ACPI mode due to most hardware and software compliance to ACPI mode.

5. IDE LED

Attach the 2-pin IDE device LED cable to the corresponding IDE LED header on the Motherboard. This will cause the LED to lighten when an IDE (HDD, CD-ROM) device is active.

6. ATX Power On/Off Switch

Attach the 2-pin momentary type switch to the PWRBT header for turning On or Off your ATX power supply.

Step 7. External Peripherals Connections

External devices such as the keyboard, printer, PS/2 mouse, modem, USB can be connected to the Motherboard. Normally, you can not plug your devices directly onto the Motherboard, except for the keyboard that plugs directly into the back panel KB connector. For other parallel (PRT1) and serial devices (COM1, COM2), first install the external connectors that come with your Motherboard on the computer case, then plug the other end of the flat cable to their respective connectors.

Only after you have fixed and locked the Motherboard and external connectors to the computer case can you start connecting the external peripheral devices.

When connecting an external device, use the following figure to locate and identify which back panel connector to plug the device or flat cable to.

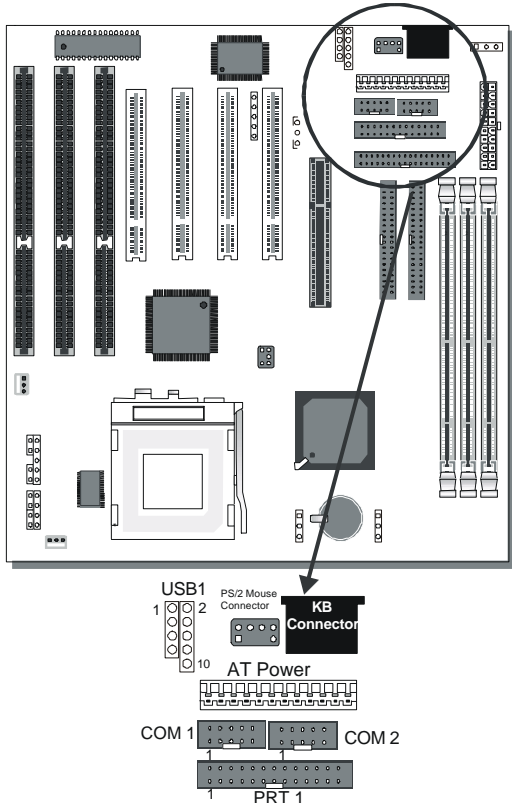

1. Serial Ports COM1/COM2

External Devices that use the COM ports include serial mice and modems. The COM port connectors are located on 2 separate brackets panels, as shown on the figure below. Please plug their respective 10 pin flat cable connectors into the COM1 and COM 2 serial port connectors on the Motherboard.

The bracket panels should be fixed to one of the slots at the back of the computer case using a screw, after having finished this you can plug any serial device into the back panel connectors.

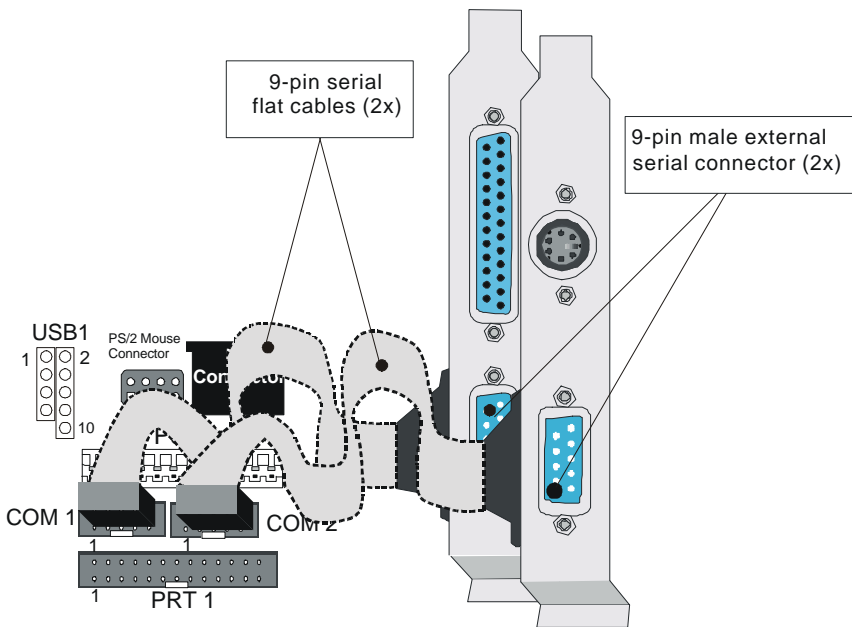

Parallel Port PRT1

This parallel port is used to connect the printer or other parallel devices.

Your Motherboard comes with one 25-pin female external parallel connector with 25-pin flat cable.

Plug the 25-pin end of the flat cable into the PRT1 parallel connector on the Motherboard, then fix the bracket to one of the slots at the back of the computer case using a screw. After having finished this you can plug any parallel device into the back panel connectors.

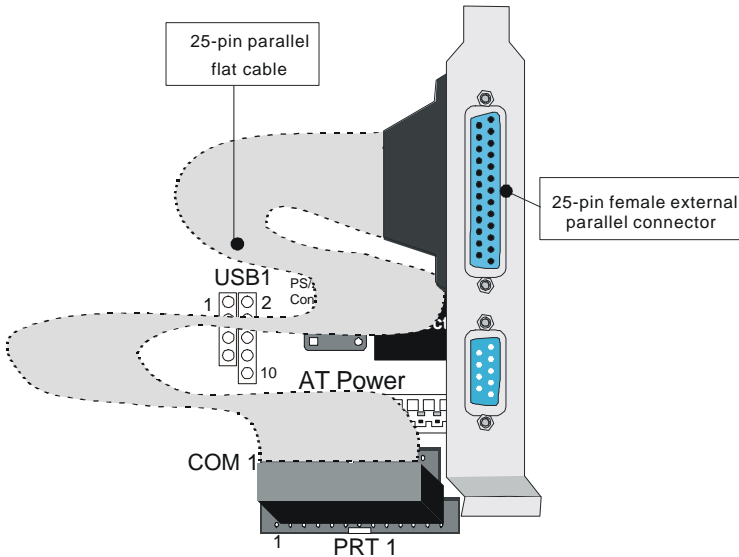

AT Keyboard

Plug the keyboard jack directly into the 5-pin female AT keyboard connector located at the rear panel of the Motherboard.



PS/2 Mouse

Attach the mouse cable to the 6-pin male PS/2 mouse connector on the Motherboard to enable PS/2 mouse function.

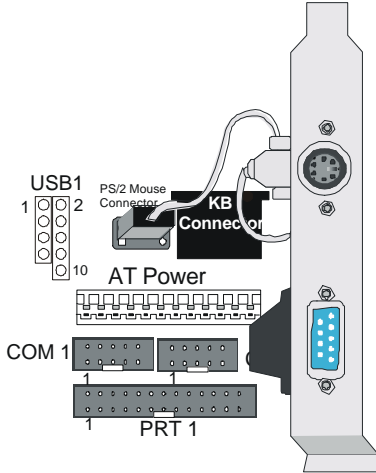

Universal Serial Bus (USB)

This Motherboard provides a dual-row 10-pin header (one pin is empty) to support two USB ports for your additional devices. Attach the USB cable (**Optional**) to this header as shown in the diagram below. The USB cable has two USB ports mounted on a bracket.

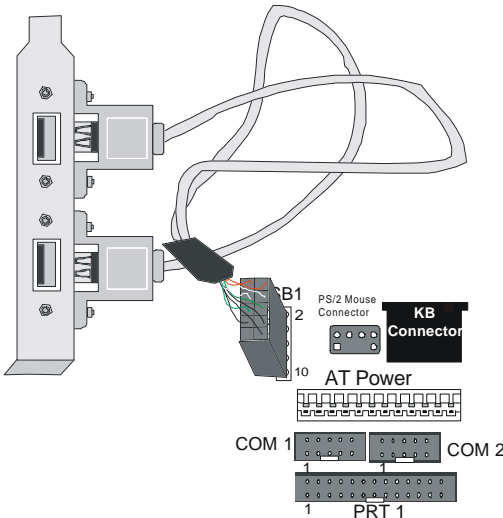

Step 8. Other Connections

1. Wake-On-LAN (WOL)

Attach the 3-pin connector from the LAN card which supports the Wake-On-LAN (WOL) function to the JP44 header on the Motherboard. This WOL function lets users wake up the connected computer through the LAN card.

Please install according to the following pin assignment:

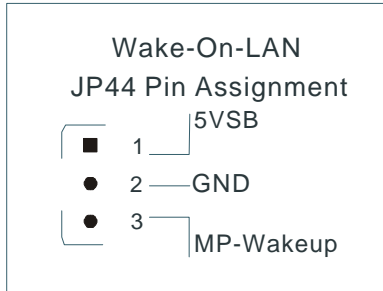

2. Infrared (IR)

Plug the 5-pin infrared device cable to the IR header. This will enable the infrared transfer function. This Motherboard meets both the ASKIR and HPSIR specifications.

Please install according to the following pin assignment:

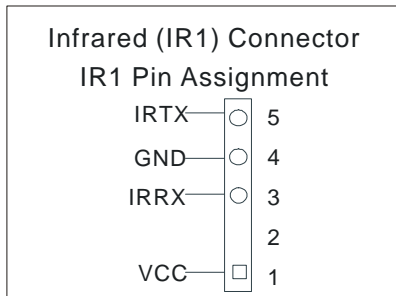

3. Other Display Cards

Insert other types of VGA cards into the PCI or ISA expansion slots according to card specifications.

Step 9. Cooling Fan Installation

1. CPU Cooling Fan

After you have seated the CPU properly on the processor, attach the 3-pin fan cable to the CPUFAN connector on the Motherboard. The fan will stop when the system enters into Suspend Mode. (Suspend mode can be enabled from the BIOS Setup Utility, [POWER MANAGEMENT] menu.)

To avoid damage to the system, install according to the following pin assignment:

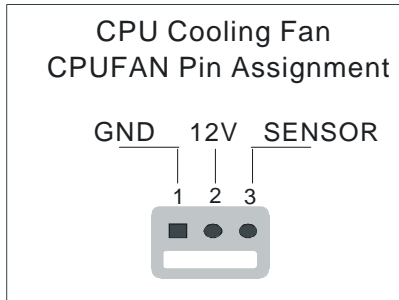

2. Chassis Cooling Fan

Some chassis also feature a cooling fan. This Motherboard features a CHAFAN connector to provide 12V power to the chassis fan. Connect the cable from the chassis fan to the CHAFAN 3-pin connector. Install according to the following pin assignment:

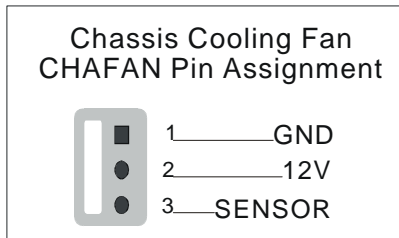

Note: CPUFAN must be installed for this Motherboard, CHAFAN is optional.

Step 10. AGP VGA Card

Insert the AGP VGA card into the AGP slot. Then connect the monitor information cable to the AGP card back plane external connector.

Follow the manufacturer's instructions to perform the AGP VGA drivers installation.

Other Display Cards: Insert other types of VGA cards into the PCI or ISA expansion slots according to card specifications.

Step 11. PCI Audio Card

Some PCI soundcards require a PC-PCI DMA channel. Attach the 5-pin cable from your PCI audio card to the SB-LINK™ header on the Motherboard. The SB-LINK™ will forward requests for legacy DMA channel to the PCI Bus.

Step 12. ATX Power Supply

Plug the connector from the power directly into the 20-pin male ATX PW connector on the Motherboard, as shown in the following figure.

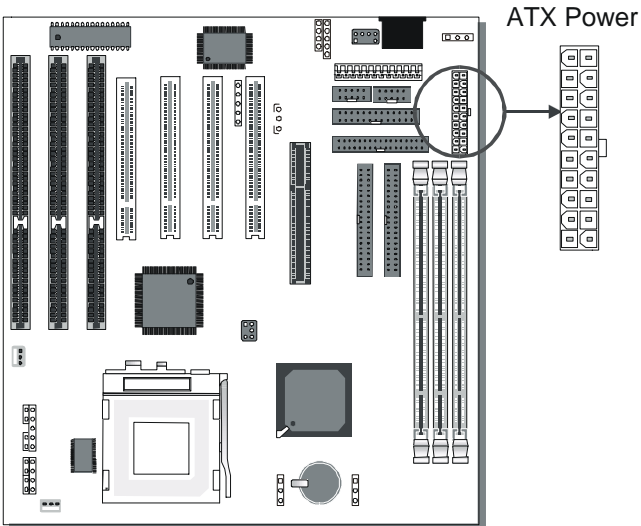



Warning: Follow these precautions to preserve your Motherboard from any remnant currents when connecting to ATX power supply:

Turn off the power supply and unplug the power cord of the ATX power supply before connecting to ATX PW connector.

The Motherboard requires a power supply with at least 200 Watts and a "power good" signal. Make sure the ATX power supply can take at least 720 mA * load on the 5V Standby lead (5VSB) to meet the standard ATX specification.

* **Note:** If you use the Wake-On-LAN (WOL) function, make sure the ATX power supply can support at least 720 mA on the 5V Standby lead (5VSB).

Please install the ATX power according to the following pin assignment:

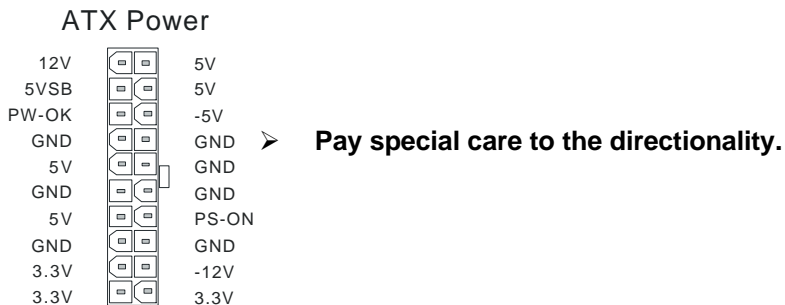



Step 13. AT Power Supply

If you are using AT power, plug the dual 6-pin headers from the power directly into the 12-pin male AT Power connector on the motherboard. Make sure black leads of the 6-pin AT power headers are in the center.

Step 14. CMOS Clearing (JP5)



After you have turned off your computer, clear the CMOS memory by momentarily shorting pins 2-3 on jumper JP5, for a few seconds. Then restore JP5 to the initial 1-2 jumper setting in order to recover and retain the default settings.

Jumper JP5 can be easily identified by its white colored cap.

CMOS Clearing	Clear CMOS Data	Retain CMOS Data
JP5 Setting	Short pin 2-3 for at least 5 seconds to clear the CMOS 	Short pin 1-2 to retain new settings 
Note: You must unplug the ATX power cable from the ATX power connector when performing the CMOS Clear operation.		

Step 15. Set JP9 for power up FSB clock and AGP bus clock.

JP9 is used to adjust AGP bus clock frequency depending on the value of the front side bus (FSB) clock, also the setting of the JP9 determines the power up FSB clock which will remain effective until the BIOS set the FSB clock to the CMOS setting.



JP9 Setting		
Power up FSB Clock	66MHz	100MHz
AGP Clock	AGP Clock = FSB Clock ÷ 1	AGP Clock = FSB Clock ÷ 1.5

Note: The specification of maximum AGP bus Clock frequency is 66.6MHz.

- * Set JP9 to pin 1-2 short when you use a FSB 100MHz CPU.
- * Set JP9 to pin 2-3 short when you use a FSB 66MHz CPU.
- * Set JP9 to pin 1-2 short when you use a FSB 66MHz CPU but want to over clock the FSB clock to 100MHz via the BIOS setting.

Step 16. Power-On by Keyboard Jumper (JP10)

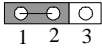
You can choose to enable the Power-On by Keyboard or Mouse function by shorting pin 1-2 on jumper JP1, otherwise, short pin 2-3 to disable this function.

Support Power-On by Keyboard	Enable	Disable
JP10 Setting	Enable Power-On by Keyboard function (short pin 1-2) 	Disable Power-On by Keyboard function (short pin 2-3) 



Note: When using the Power-On by Keyboard function, please make sure the ATX power supply can take at least 720mA load on the 5V Standby lead (5VSB) to meet the standard ATX specification.

Step 17. Power On

You have now completed the hardware installation of your Motherboard successfully.

1. Turn the power on
2. To enter the BIOS Setup Utility, press the key while the system is performing the diagnostic checks,



Note: If you have failed to enter the BIOS, wait until the boot up sequence is completed. Then push the RESET button and press key again at the beginning of boot-up, during diagnostic checks.

Repeat this operation until you get the following screen.

3. The BIOS Setup screen appears:

ROM PCI/ISA BIOS CMOS SETUP UTILITY AWARD SOFTWARE, INC.	
SOYO COMBO SETUP	INTEGRATED PERIPHERALS
STANDARD CMOS SETUP	SUPERVISOR PASSWORD
BIOS FEATURES SETUP	USER PASSWORD
CHIPSET FEATURES SETUP	IDE HDD AUTO DETECTION
POWER MANAGEMENT SETUP	SAVE & EXIT SETUP
PNP/PCI CONFIGURATION	EXIT WITHOUT SAVING
LOAD SETUP DEFAULTS	
Esc : Quit	↑ ↓ → ← : Select Item
F10 : Save & Exit Setup	(Shift) F2 : Change Color
Time, Date, Hard Disk Type...	

Step 18. Quick BIOS Setup

This Motherboard does not use any hardware jumpers to set the CPU frequency. Instead, CPU settings are software configurable with the BIOS [**SOYO COMBO SETUP**]. The [**SOYO COMBO SETUP**] menu combines the main parameters that you need to configure, all in one menu, for a quick setup in BIOS.

After the hardware installation is complete, turn the power switch on, then press the key during the system diagnostic checks to enter the Award BIOS Setup program. The CMOS SETUP UTILITY will display on screen. Follow these steps to configure the CPU settings.

1. Select [**LOAD SETUP DEFAULT**]

Select the “LOAD SETUP DEFAULT” menu and type “Y” at the prompt to load the BIOS optimal setup.

2. Select [STANDARD CMOS SETUP]

Set [Date/Time] and [Floppy drive type], then set [Hard Disk Type] to "Auto".

3. Select [SOYO COMBO SETUP]

Move the cursor to the [CPU Frequency] field to set the CPU frequency, as shown in the following display.

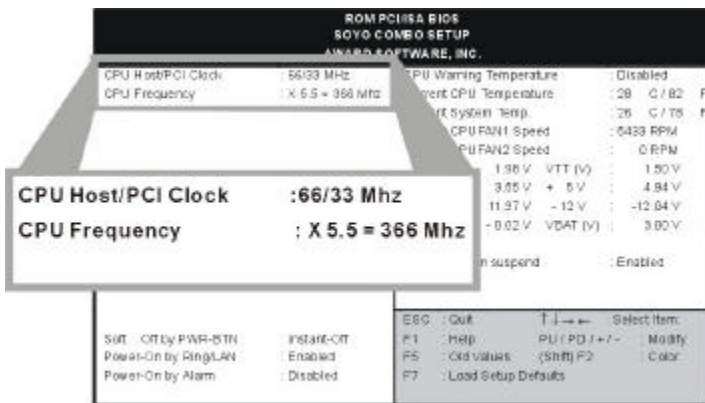

Available [CPU Frequency] settings on your SY-71ZB+ Motherboard are detailed in the following table. You are then required to fill in the next two consecutive fields: (1) the CPU Host/PCI Clock, and (2) the CPU Frequency.

CPU Frequency	
<input type="checkbox"/> 300MHz (66 x 4.5)	Select the working frequency of your Celeron™ processor among these preset values. Note: <input checked="" type="checkbox"/> Mark the checkbox that corresponds to the working frequency of your Celeron™ processor in case the CMOS configuration should be lost.
<input type="checkbox"/> 333MHz (66 x 5.0)	
<input type="checkbox"/> 366MHz (66 x 5.5)	
<input type="checkbox"/> 400MHz (66 x 6.0)	
<input type="checkbox"/> 433MHz (66 x 6.5)	
<input type="checkbox"/> 466MHz (66 x 7.0)	
<input type="checkbox"/> 500MHz (66 x 7.5)	
<input type="checkbox"/>	



Note: if you use Bus Frequencies of 75 MHz, make sure that your PCI cards can cope with the higher PCI clock.

4. Select [SAVE & EXIT SETUP]

Press <Enter> to save the new configuration to the CMOS memory, and continue the boot sequence.

Troubleshooting at First Start

- *What should I do if the Motherboard refuses to start?*

The 66MHz setting is used as default so whenever the BIOS settings are erased or reset, the board will be able to boot up. If the CPU frequency was set too high and the Motherboard refuses to start up, you can always load the default values by pressing the [Ins] key during boot up.

Step 19. Power Off

There are two possible ways to turn off the system:

1. Use the **Shutdown** command in the **Start Menu** of Windows 95/98 to turn off your computer.
2. Press the mechanical power-button and **hold down for over 4 seconds**, to shutdown the computer. If you press the power-button for less than 4 seconds, then your system will enter into **Suspend Mode**.

You are now ready to configure your system with the BIOS setup program. Go to **Chapter 3: BIOS SETUP**

Chapter 3

BIOS SETUP UTILITY

This Motherboard's BIOS setup program uses the ROM PCI/ISA BIOS program from Award Software Inc.

To enter the Award BIOS program's Main Menu:

1. Turn on or reboot the system.
2. After the diagnostic checks, press the [Del] key to enter the Award BIOS Setup Utility.

ROM PCI/ISA BIOS CMOS SETUP UTILITY AWARD SOFTWARE, INC.	
SOYO COMBO SETUP	INTEGRATED PERIPHERALS
STANDARD CMOS SETUP	SUPERVISOR PASSWORD
BIOS FEATURES SETUP	USER PASSWORD
CHIPSET FEATURES SETUP	IDE HDD AUTO DETECTION
POWER MANAGEMENT SETUP	SAVE & EXIT SETUP
PNP/PCI CONFIGURATION	EXIT WITHOUT SAVING
LOAD SETUP DEFAULTS	
Esc : Quit	↑ ↓ → ← : Select Item
F10 : Save & Exit Setup	(Shift) F2 : Change Color
Time, Date, Hard Disk Type . . .	

Selecting items

- Use the arrow keys to move between items and select fields.
- From the Main Menu press arrow keys to enter the selected submenu.

Modifying selected items

- Use the [Up]/[Down] keys to modify values within the selected fields. Some fields let you enter values directly.

Hot Keys: Function keys give you access to a group of commands throughout the BIOS utility.

Function	Command	Description
F1	Help	Gives the list of options available for each item.
Shift F2	Color	Change the color of the display window.
F5	Old values	Restore the old values. These are the values that the user started the current session with.
F7	Load Setup Defaults	Loads all options with the Power-On default values.
F10	Save & Exit Setup	Saves your changes and reboots the system.
[Esc]	Quit	Lets you return at anytime and from any location to the Main Menu.

SAVE AND EXIT SETUP

Select the [SAVE & EXIT SETUP] option from the Main Menu to save data to CMOS and exit the setup utility. This option saves all your changes and causes the system to reboot.

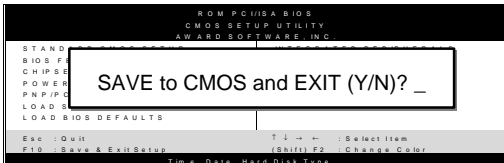

Type [Y] to save the changes and exit or [N] to return to the Main Menu and keep current values.

EXIT WITHOUT SAVING

Selecting the [EXIT WITHOUT SAVING] option allows you to abandon all data and exit setup, therefore ignoring all your changes.

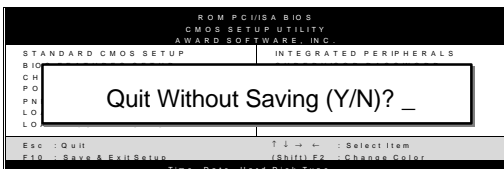

Type [Y] to abandon changes and exit or [N] to return to the Main Menu and keep current values.

3-1 SOYO COMBO SETUP

This Motherboard does not use any hardware jumpers to set the CPU frequency. Instead, CPU settings are software configurable with the BIOS **[SOYO COMBO SETUP]**.

After the hardware installation is complete, turn the power switch on, then press the key during the system diagnostic checks to enter the Award BIOS Setup program. The CMOS SETUP UTILITY will display on screen. Then, select the **[SOYO COMBO SETUP]** option from the main menu and press the <Enter> key.

ROM PCI/ISA BIOS SOYO COMBO SETUP AWARD SOFTWARE, INC.			
CPU Host/PCI Clock	: 100/33 MHz	CPU Warning Temperature	: Disabled
CPU Frequency	: X 5.5 = 550 Mhz	Current CPU Temp.	: 28 ½ C / 82 ½ F
SDRAM RAS-to CAS Delay	: 3	Current CPUFAN1 Speed	: 5433 RPM
SDRAM RAS Precharge Time	: 3	Current CPUFAN2 Speed	: 0 RPM
SDRAM CAS latency Time	: 3	Vcore (V) : 2.01 V 3.3 (V)	: 3.4 V
Boot Sequence	: A,C,SCSI	+ 5 (V) : 4.99 V + 12 V	: 12.16 V
Quick Power On Self Test	: Disabled	-12 (V) : -12.03 V - 5V	: -4.94 V
POWER ON Function	: BUTTON ONLY	CPUFAN off in suspend	: Enabled
Soft – Off by PWR-BTN	: Instant-Off	ESC : Quit	↑ ↓ → ← : Select Item:
Power-On by Ring/LAN	: Enabled	F1 : Help	PU / PD / + / - : Modify
Power-On by Alarm	: Disabled	F5 : Old Values	(Shift) F2 : Color
		F7 : Load Setup Defaults	

The **[SOYO COMBO SETUP]** menu combines the main parameters that you need to configure, all in one menu, for a quick setup in BIOS.

3-1.1 Quick CPU Frequency Setup

Quick CPU Frequency Setup	Setting		Description
CPU Host/PCI Clock	66/33 MHz	105/35 MHz	Select the host clock of your Celeron™ processor from these values. Note: For the ZX chipset, a 66 MHz host clock frequency is acceptable. However, system stability is not guaranteed for other frequencies due to the limitations of this chipset.
	75/37 MHz	110/36 MHz	
	83/41 MHz	115/38 MHz	
	100/33 MHz	120/40 MHz	
	103/34 MHz	124/31 MHz	
	112/37 MHz	133/33 MHz	
	124/41 MHz	140/35 MHz	
	133/44 MHz	150/37 MHz	
CPU Frequency	The BIOS will detect the fixed multiplier value of your Socket 370 CPU. It will display that value here. Combined with the CPU host clock settings above, the CPU work frequency is displayed as well.		

3-1.2 SDRAM Control Setting

SDRAM Control	Setting	Description	Note
SDRAM RAS-to-CAS Delay	2	Set to 2 for better system performance when the CPU FSB is 66MHz.	Default
	3		
SDRAM RAS Precharge Time	2	Set to 2 for better system performance when the CPU FSB is 66MHz.	Default
	3		
SDRAM Cache Latency Time	2	Set to 2 for better system performance when the CPU FSB is 66MHz.	Default
	3		

3-1.3 System Boot Control Settings

System Boot Control Settings	Setting	Description	Note
Boot Sequence	A, C, SCSI	Choose the boot sequence adapted to your needs, for example: <ul style="list-style-type: none"> • [A, C, SCSI] means the BIOS will look for an operating system first in drive A, then in drive C, and eventually in SCSI device. 	
	C, A, SCSI		
	C, CD-ROM, A		
	CD-ROM, C, A		
	D, A, SCSI		
	E, A, SCSI		
	F, A, SCSI		
	SCSI, A, C		
	SCSI, C, A		
C only			
LS/ZIP, C			
Quick Power On Self Test	Disabled		
	Enabled	Provides a fast POTS at boot-up.	Default

3-1.4 Power Management

PM Events	Setting	Description	Note
POWER ON Function	BUTTON-ONLY	Disables the Wake-Up by Keyboard function.	Default
	KB Power ON Password	Enables you to wake-up the system by entering a password at the keyboard.	
	Hot Key	You can wake-up the system by pressing the key combination of your choice (Ctrl-F1~F12).	
If [POWER ON Function] is set to [KB Power ON Password]			
KB Power ON Password	Enter (your password)	Set the password that will wake-up your system.	

Power Management (Continued)

PM Events	Setting	Description	Note
Power button	Disabled	Set to disable the system can only wake up through the password (In case the password has been forgotten, use JP8 to clear the password)	
	Enabled	Set to enable the system can wake up through the password and the power button.	Default
If [POWER ON Function] is set to [Hot Key]			
HotKey	Ctrl-F1~F12	Choose the key combination that will wake-up the system. [Ctrl-F1 to Ctrl-F12]	
Soft-Off by PWR-BTTN	Instant-off		Default
	Delay 4 Sec.	Turns off the system power 4 seconds after pushing the power button.	
Power-On by Ring/LAN	Disabled		Default
	Enabled	The system will self-power on me when the modem is ringing.	
Power-On by Alarm	Disabled	The system ignores the alarm.	Default
	Enabled	Set alarm to power on the system by the date (1-31) or time (hh:mm:ss). If the date is set to [0], the system will self-power on by alarm everyday at the set time.	

3-1.5 CPU Device Monitoring

CPU Device Monitoring	Setting	Description	Note
CPU Warning Temperature	Disabled		Default
	Enabled	Set CPU temperature from 50°C to 70°C. The CPU will slow down when CPU temperature goes beyond the preset value. The CPU will continue to run slow until the temperature returns back within the safe range.	
Current CPU Temperature	°C/°F	Show the current status of CPU temperature.	
Current CPUFAN1/ CPUFAN2 Speed	RPM	Show the current status of CPU Fan	
Vcore, VTT, 3.3V, +12V, -5V, +5V, -12V,VBAT	V	Show the current voltage status.	
CPUFAN Off In Suspend	Disabled	Disables the PM timer.	
	Enabled	Switches off the CPU Fan when the system enters Suspend Mode.	Default

3-2 STANDARD CMOS SETUP

Select the [STANDARD CMOS SETUP] option from the Main Menu and press [Enter] key.

ROM PCI/ISA BIOS STANDARD CMOS SETUP AWARD SOFTWARE, INC.									
Date (mm:dd:yy)		: Thu, Jan 1 1998							
Time (hh:mm:ss)		: 1 : 9 :25							
HARD DISKS	TYPE	SIZE	CYLS	HEAD	PRECOMP	LANDZ	SECTOR	MODE	
Primary Master	: Auto	0	0	0	0	0	0	AUTO	
Primary Slave	: Auto	0	0	0	0	0	0	AUTO	
Secondary Master	: Auto	0	0	0	0	0	0	AUTO	
Secondary Slave	: Auto	0	0	0	0	0	0	AUTO	
Drive A	: 1.44M, 3.5 in.								
Drive B	: None								
Floppy 3 Mode Support					: Disabled				
					Base Memory: 640K				
					Extended Memory: 31744K				
					Other Memory: 384K				

					Total Memory: 32768K				
ESC	: Quit	↑ ↓ → ←			: Select Item			PU / PD / + / - : Modify	
F1	: Help	(Shift)			F2 : Change Color				

This screen allows you to modify the basic CMOS settings. After you have completed the changes, press [Esc] key to return to the Main Menu.

3-2.1 Date & Time

	Display	Setting	Please Note
Date	mm/dd/yyyy	Type the current date	You can also the PUp/PDn keys to toggle
Time	hh:mm:ss	Type the current time	24-hour clock format 3:15 PM is displayed as 15:15:00

3-2.2 Hard Disks Type & Mode

Choose the type and mode for the hard disks that you have already installed.

Primary (Secondary) Master & Slave	Setting	Description	Note
Type	Auto	BIOS detects hard disk type automatically.	Default
	User	User defines the type of hard disk.	
	None		
Mode	Auto	BIOS detects hard disk mode automatically.	Default
	Normal	Normal IDE hard disk	<528MB
	LBA	Enhanced IDE hard disk	>528MB
	Large	Large IDE hard disk (for certain hard disk)	



Note: If you have any questions on your hard disk type or mode, ask your hard disk provider or previous user for details.

3-2.3 Floppy Drives

Floppy Drives	Setting	Description	Note
Drives A & B	360KB, 5.25 in.		
	1.2MB, 5.25 in.		
	720KB, 3.5 in.		
	1.44MB, 3.5 in.		Default
	2.88MB, 3.5 in.		
	None	Not installed	
Floppy 3-Mode Support	Disabled		Default
	Drive A Drive B Both	Supports 3-mode floppy diskette: 740KB/1.2MB/1.44MB on selected disk drive.	Special disk drive commonly used in Japan

3-2.4 Video

Select the video mode: EGA/VGA (Default), CGA 40, CGA 80, Mono (Monochrome).

3-2.5 Halt On

When the BIOS detects system errors, this function will stop the system. Select which type of error will cause the system halt: All Errors (Default), No Errors, All But Diskette, All But Keyboard, All But Disk/Key.

3-3 BIOS FEATURES SETUP

Select the [BIOS FEATURES SETUP] option from the Main Menu and press [Enter] key.

ROM PCI/ISA BIOS			
BIOS FEATURES SETUP			
AWARD SOFTWARE, INC.			
Anti-Virus Protection	: Enabled	Assign IRQ For VGA	: Enabled
CPU Internal Cache	: Enabled	HDD S.M.A.R.T. capability	: Disabled
External Cache	: Enabled	Video BIOS Shadow	: Enabled
Swap Floppy Drive	: Disabled	C8000-CBFFF Shadow	: Disabled
Report No FDD For WIN 95	: Yes	CC000-CFFF Shadow	: Disabled
Boot Up NumLock Status	: On	D0000-D3FFF Shadow	: Disabled
Security Option	: Setup	D4000-D7FFF Shadow	: Disabled
PCI/VGA Palette Snoop	: Disabled	D8000-DBFFF Shadow	: Disabled
OS Select For DRAM > 64 MB	: Non-OS2	DC000-DFFFF Shadow	: Disabled
Typematic Rate Setting	: Disabled	ESC : Quit	↑ ↓ → ← : Select Item
Typematic Rate (Chars/Sec)	: 6	F1 : Help	PU/PD/+/- : Modify
Typematic Delay (Msec)	: 250	F5 : Old Values	(Shift) F2 : Color
		F7 : Load Setup Defaults	

After you have completed the changes, press [Esc] key and follow the instructions on your screen to save your settings or exit without saving.

3-3.1 Virus Warning

	Setting	Description	Note
Anti - Virus Protection	Disabled		
	Enabled	If set to enabled, the Paragon Anti-Virus. Function will scan your boot drive for boot viruses. If a boot virus is detected, the BIOS will display a warning message.	Default

3-3.2 Cache Memory Options

	Setting	Description	Note
CPU Internal Cache	Disabled		
	Enabled	Enables the CPU's internal cache.	Default
External Cache	Disabled		
	Enabled	Enables the external memory.	Default

3-3.3 System Boot Control Settings

	Setting	Description	Note
System Boot Control Settings			
Swap Floppy Drive	Disabled		Default
	Enabled	Changes the sequence of A and B drives.	
Report No FDD For WIN 95	Yes	Windows will release IRQ line 6 (normally used by the Floppy Disk Drive) after you disable your on-board FDD and set this field to [Yes].	
	No	Windows will reserve INT 6 for your FDD, whether it is disabled or not.	
Boot Up NumLock Status	On	Puts numeric keypad in NumLock mode at boot-up.	Default
	Off	Puts numeric keypad in arrow key mode at boot-up.	

3-3.4 Security Option

Use this feature to prevent unauthorized system boot-up or use of BIOS Setup. The following table describes the security settings.

Security Option	Setting	Description
	System	Each time the system is booted, the password prompt appears.
	Setup	If a password is set, the password prompt only appears when you attempt to enter the BIOS Setup program.

3-3.5 Other Control Options

Other Control Options	Setting	Description	Note
PCI/VGA Palette Snoop	Disabled		Default
	Enabled	The color of the monitor may be altered when using an MPEG card. Enable this option to restore the monitor's normal color.	
OS Select for DRAM>64MB	OS2	When using an OS2 operating system.	
	Non-OS2	When using another, non-OS2 operating system.	Default

3-3.6 Typematic Settings

Typematic Settings	Setting	Description	Note
Typematic Rate Setting	Disabled		Default
	Enabled	Enables to adjust the keystroke repeat rate.	

Typematic Settings (Continued)

Typematic Settings	Setting	Description	Note
The following [Typematic Rate] and [Typematic Delay] fields are active only if [Typematic Rate Setting] is set to [Enabled]			
Typematic Rate	6 (Char/sec)	Choose the rate at which a character is repeated when holding down a key.	Default
	8 (Char/sec)		
	10 (Char/sec)		
	12 (Char/sec)		
	15 (Char/sec)		
	20 (Char/sec)		
	24 (Char/sec)		
30 (Char/sec)			
Typematic Delay	250 (msec)	Choose how long after you press a key down the character begins repeating.	Default
	500 (msec)		
	750 (msec)		
	1000 (msec)		

3-3.7 Other Control Options

Other Control Options	Setting	Description	Note
Assign IRQ For VGA	Disabled		
	Enabled	Use this default setting.	Default
HDD S.M.A.R.T. capability	Disabled		
	Enabled	Enable this field when your HDD supports the S.M.A.R.T. function. Consult your HDD provider for details.	
Video or Adapter BIOS Shadow	Disabled		
	Enabled	The BIOS is shadowed in a 16K segment if it is enabled and if it has BIOS present. These 16 segments can be shadowed from ROM to RAM. BIOS shadow copies BIOS code from slower ROM to faster RAM. BIOS can then execute from RAM.	Default

3-4 CHIPSET FEATURES SETUP



Caution: Change these settings only if you are already familiar with the Chipset.

ROM PCI/ISA BIOS CMOS SETUP UTILITY CHIPSET FEATURES SETUP			
Auto Configuration	: Enabled	Passive Release	: Enabled
SDRAM Precharge Control	: Disabled	Delayed Transaction	: Enabled
System BIOS Cacheable	: Disabled	AGP Aperture Size	: 64
Video BIOS Cacheable	: Disabled	Spread Spectrum	: Disabled
Video RAM Cacheable	: Disabled		
8 Bit I/O Recovery Time	: 1		
16 Bit I/O Recovery Time	: 1		
Memory Hole At 15M -16M	: Disabled		
		ESC	: Quit
		F1	: Help
		F5	: Old Values
		F7	: Load Setup Defaults
		↑ ↓ → ←	: Select Item
		PU/PD/+/-	: Modify
		(Shift) F2	: Color

The [CHIPSET FEATURES SETUP] option changes the values of the chipset registers. These registers control the system options in the computer.

After you have completed the changes, press [Esc] and follow the instructions on your screen to save your settings or exit without saving.

The following table describes each field in the CHIPSET FEATURES SETUP Menu and how to configure each parameter.

3-4.1 CHIPSET FEATURES SETUP

CHIPSET FEATURES	Setting	Description	Note
Auto Configuration	Disabled		
	Enabled	It is strongly recommended to enable this option so that the system automatically sets all chipset feature options on the left panel of the screen (except for cache update & BIOS cacheable).	Default
SDRAM Precharge Control	Disabled	Use the default setting	Default
	Enabled		
System BIOS Cacheable	Disabled		Default
	Enabled	The ROM area F0000H-FFFFFH is cacheable.	
Video BIOS Cacheable	Disabled		Default
	Enabled	The video BIOS C0000H-C7FFFH is cacheable.	
Video RAM Cacheable	Disabled		Default
	Enabled	The ROM area A0000-BFFFF is cacheable.	
8 BIT I/O Recovery Time	1	Use the default setting	Default

CHIPSET FEATURES SETUP (Continued)

CHIPSET FEATURES	Setting	Description	Note
16 BIT I/O Recovery Time	1	Use the default setting	Default
Memory Hole At 15M-16M	Disabled		Default
	Enabled	Some interface cards will map their ROM address to this area. If this occurs, select [Enabled] in this field.	
Passive Release	Enabled	Use the default setting	Default
Delayed Transaction	Enabled	Use the default setting	Default
AGP Aperture Size	64 4-256MB	AGP could use the DRAM as its video RAM. Choose the DRAM size that you wish to allocate as video RAM.	Default
Spread Spectrum Modulated	Disabled		Default
	Enabled	When using Spread Spectrum Modulated 1.5% or 6% for FCC or DOC testing.	

3-5 POWER MANAGEMENT SETUP

The [POWER MANAGEMENT SETUP] sets the system's power saving functions.

ROM PCI/ISA BIOS POWER MANAGEMENT SETUP AWARD SOFTWARE, INC.			
ACPI function	: Enabled	** Reload Global Timer Events	**
PM Control by APM	: Yes	IRQ [3-7, 9-15], NMI	: Disabled
Video Off Method	: V/H SYNC+Blank	Primary IDE 0	: Disabled
Video Off After	: Standby	Primary IDE1	: Disabled
MODEM Use IRQ	: 3	Secondary IDE 0	: Disabled
Power Management	: User Define	Secondary IDE1	: Disabled
Doze Mode	: Disable	Floppy Disk	: Disabled
Standby Mode	: Disable	Serial Port	: Enabled
Suspend Mode	: Disable	Parallel Port	: Disabled
HDD Power Down	: Disabled		
PCI/VGA Act-Monitor	: Disabled		
IRQ 8 Break Suspend	: Disabled		
		ESC	: Quit ↑ ↓ → ← : Select Item
		F1	: Help PU/PD/+/- : Modify
		F5	: Old Values (Shift) F2 : Color
		F7	: Load Setup Defaults

After you have completed the Power Management Setup, press [Esc] to return to the Main Menu.

3-5.1 Power Management Controls

Power Management Controls	Setting	Description	Note
ACPI function	Disabled		Default
	Enabled	ACPI (Advanced Configuration Power Management Interface)	
PM Control by APM	Yes	To use Advanced Power Management (APM) you must run [power.exe] under DOS V6.0 or later version.	Default
	No		
Video Off Method	V/H Sync+Blank	Selects the method by which the monitor is blanked.	Default
	Blank screen		
	DPMS Supported		
Video Off After	Standby	Choose the PM mode you want video to go off after the mode is being active.	
	Suspend		
	Doze		
MODEM Use IRQ	3	Assigns an IRQ# to the modem device.	Default
	3-11, NA		

3-5.2 PM Timers

PM Timers	Setting	Description	Note
Power Management	User Define	Lets you define the HDD and system power down times.	Default
	Disable	Disables the Green PC Features.	
		Doze timer Standby timer Suspend timer HDD power down	
	Min Saving	1 Hour 1 Hour 1 Hour 15 Min	
	Max Saving	1 Min 1 Min 1 Min 1 Min	
The following [Doze Mode] field may be configured only if [Power Management] is set to [User Define]			
Doze Mode	Disable		Default
	1Min-1Hour	When the set time has elapsed, BIOS sends a command to the system to enter Doze Mode.	System clock drops to 33MHz.
The following [Standby Mode] field may be configured only if [Power Management] is set to [User Define]			
Standby Mode	Disable		Default
	1Min-1Hour	When the set time has elapsed, BIOS sends a command to the system to enter Standby Mode.	
The following [Suspend Mode] field may be configured only if [Power Management] is set to [User Define]			
Suspend Mode	Disable		Default
	1Min-1Hour	In Suspend mode, the CPU stops completely (no instructions are executed.)	Only an SL-Enhanced (or SMI) CPU can enter this mode.
HDD Power Down	Disabled		Default
	1-15Min	When the set time has elapsed, BIOS sends a command to the HDD to power down. This turns off the HDD motor.	Some older model HDDs may not support this advanced function.

3-5.3 PM Events

PM Events	Setting	Description	Note
PCI/VGA Act-Monitor	Disabled		
	Enabled	Enables the power management timers when a [no activity] event is detected.	Default
IRQ 8 Break Suspend	Disabled		Default
	Enabled	Alarm function is active.	

3-5.4 Reload Global Timer Events

Power Down & Resume Events	Setting	Description	Note
IRQ [3-7,9-15], NMI	Disabled		
	Enabled	The system monitors these elements for activity. The system will resume if [IRQ activity] is detected.	Default
IDE0, IDE1 ➤ Primary ➤ Secondary	Disabled		Default
	Enabled	Enables the PM timers when [No Activity Event] is detected.	
Floppy Disk Serial Port Parallel Port	Disabled		Default
	Enabled	Enables the PM timers when [No Activity Event] is detected.	

3-6 PNP/PCI CONFIGURATION SETUP

This option sets the Motherboard's PCI Slots.

ROM PCI/ISA BIOS									
PNP/PCI CONFIGURATION									
AWARD SOFTWARE, INC.									
Resources Controlled By	:	Manual	Slot 1/AGP Use IRQ No.	:	Auto				
Reset Configuration Data	:	Disabled	Slot 2	Use IRQ No.	:	Auto			
IRQ - 3	Assigned to	:	Legacy ISA	Slot 3	Use IRQ No.	:	Auto		
IRQ - 4	Assigned to	:	Legacy ISA	Slot 4/USB	Use IRQ No.	:	Auto		
IRQ - 5	Assigned to	:	PCI/ISA PnP	Used MEM base addr	:	N/A			
IRQ - 7	Assigned to	:	PCI/ISA PnP	Assign IRQ For USB	:	Enabled			
IRQ - 9	Assigned to	:	PCI/ISA PnP	PNP OS Installed	:	No			
IRQ - 10	Assigned to	:	PCI/ISA PnP						
IRQ - 11	Assigned to	:	PCI/ISA PnP						
IRQ - 12	Assigned to	:	PCI/ISA PnP						
IRQ - 14	Assigned to	:	PCI/ISA PnP						
IRQ - 15	Assigned to	:	PCI/ISA PnP						
DMA - 0	Assigned to	:	PCI/ISA PnP	ESC	:	Quit	↑ ↓ → ←	:	Select Item
DMA - 1	Assigned to	:	PCI/ISA PnP	F1	:	Help	PU/PD/+/-	:	Modify
DMA - 3	Assigned to	:	PCI/ISA PnP	F5	:	Old Values	(Shift) F2	:	Color
DMA - 5	Assigned to	:	PCI/ISA PnP	F7	:	Load Setup Defaults			
DMA - 6	Assigned to	:	PCI/ISA PnP						
DMA - 7	Assigned to	:	PCI/ISA PnP						



Note: Starred (*) items will disappear when the [Resources Controlled By] option is set to [Auto].

After you have completed the PCI Slot Configuration, press [Esc] and follow the instructions on your screen to save your settings or exit without saving.

3-6.1 PNP/PCI Configuration Controls

PNP/PCI Controls	Setting	Description	Note
Resources Controlled By	Manual	BIOS does not manage PCI/ISA PnP card IRQ assignment. Requires to assign IRQ-# and DMA-# to PCI or ISA PnP manually. IRQ-3,4,5,7,9,10,11,12,14,15 assigned to: _ DMA-0,1,3,5,6,7 assigned to: _	
	Auto	The Plug-and-Play BIOS auto manages PCI/ISA PnP card IRQ assignment automatically.	Recommended
Reset Configuration Data	Disabled	Retain PnP configuration data in BIOS.	Default
	Enabled	Reset PnP configuration data in BIOS.	

3-6.2 PNP/PCI Configuration Setup

PNP/PCI Setup	Setting	Description	Note
If [Resources Controlled By] is set to [Manual]			
IRQ-# and DMA-# assigned to:	PCI/ISA PnP	Choose IRQ-# and DMA-# assigned to PCI/ISA PnP card.	IRQ-3,4,5,7,9,10,11,12,14,15 DMA-0,1,3,5,6,7
	Legacy ISA	Choose IRQ-# and DMA-# assigned to Legacy ISA card.	IRQ-3,4,5,7,9,10,11,12,14,15 DMA-0,1,3,5,6,7
Under this item the user can assign an IRQ to a PCI slot. However, there under some conditions the IRQ will not be assigned as selected under this item:			
<ol style="list-style-type: none"> 1. IRQs 0, 1, 2, 6, 8, 13 can NOT be assigned, because they are fixed. 2. IRQs 5, 9, 10, 11 are available 3. IRQs 3,4,7,12,14 and 15 will only be assigned if they are free. See the table below on how to free them: 			

PNP/PCI Configuration Setup (Continued)

PNP/PCI Setup	Setting	Description	Note
Interrupt Line	How to set the BIOS to release the IRQ to the PnP Interrupt pool:		
	PnP / PCI configuration	Integrated Peripherals	
IRQ 15	IRQ 15: PCI / ISA PnP	On-Chip Secondary PCI IDE: disabled	
IRQ 14	IRQ 14: PCI / ISA PnP	On-Chip Primary PCI IDE: disabled	
IRQ 12	IRQ 12: PCI / ISA PnP	<i>Interrupt 12 will be released by the PnP BIOS automatically if the PS/2 Mouse Port is not used.</i>	
IRQ 7	IRQ 7: PCI / ISA PnP	Onboard parallel port: disabled	
IRQ 4	IRQ 4: PCI / ISA PnP	Onboard Serial port 1: disabled	
IRQ 3	IRQ 3: PCI / ISA PnP	Onboard Serial port 2: disabled	
4. Your OS may reassign another interrupt to a PCI slot after BIOS passes control to the OS, especially if you use Windows 95, 98 or NT.			
Slot 1/2/3/4 Use IRQ NO.	Auto		Default
Used MEM base addr	Memory length	8K,16K,32K,64K. (Please ask your card provider for the exactly memory length of this add-on card.)	This item appears only when the [Based MEM base addr] set to I/O address.
Assign IRQ For USB	Enabled	BIOS will assign IRQ for USB port.	Default
	Disabled	BIOS won't assign IRQ for USB port.	
PnP OS Installed	Yes	Set this field to [Yes] if you are running Windows 95, which is PnP compatible.	
	No	If the OS you are running does not support PnP configuration.	Default (If there is any doubt, set this field to [No])

3-7 LOAD SETUP DEFAULTS

Select the [LOAD SETUP DEFAULTS] option from the Main Menu to load the system values you have previously saved. This option is recommended if you need to reset the system setup and to retrieve the old values.

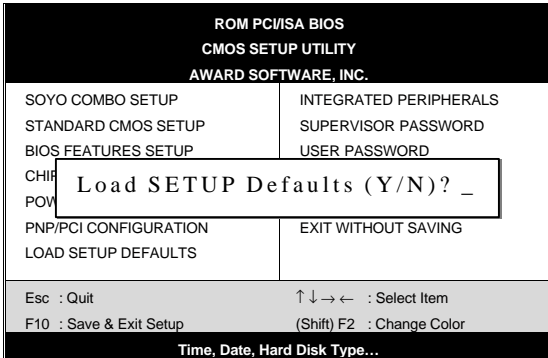

Type [Y] to use the Setup Defaults followed by [Enter] or otherwise [N] to return to the Main Menu and keep current values.



Warning: If you run into any problem after changing the BIOS configuration, please load the SETUP DEFAULTS for stable performance.

3-8 INTEGRATED PERIPHERALS



Caution: Change these settings only if you are already familiar with the Chipset.

The [INTEGRATED PERIPHERALS] option changes the values of the chipset registers. These registers control the system options in the computer.

The following screen shows setup default settings.

ROM PCI/ISA BIOS			
INTEGRATED PWEIPHERALS			
AWARD SOFTWARE, INC.			
IDE HDD Block Mode	: Enabled	Onboard Serial Port 1	: 3F8/IRQ4
IDE Primary Master PIO	: Auto	Onboard Serial Port 2	: 2F8/IRQ3
IDE Primary Slave PIO	: Auto	UART Mode Select	: Normal
IDE Secondary Master PIO	: Auto		
IDE Secondary Slave PIO	: Auto		
IDE Primary Master UDMA	: Auto	Onboard Parallel Port	: 378/IRQ7
IDE Primary Slave UDMA	: Auto	Parallel Port Mode	: SPP
IDE Secondary Master UNMA	: Auto		
IDE Secondary Slave UDMA	: Auto		
On-Chip Primary PCI IDE	: Enabled	PWRON After PWR-Fail	: Off
On-Chip Secondary PCI IDE	: Enabled		
USB Keyboard Support	: Disabled		
Init Display First	: PCI Slot		
Onboard FDC Controller	: Enabled		
		ESC	: Quit
			↑ ↓ → ← : Select Item
		F1	: Help
			PU/PD/+/- : Modify
		F5	: Old Values (Shift) F2 : Color
		F7	: Load Setup Defaults

The following tables describe each field in the INTEGRATED PERIPHERALS Menu and provide instructions on how to configure the IDE controls, FDC controls, and the onboard serial and parallel ports.

3-8.1 IDE Device Controls

IDE Controls	Setting	Description	Note
IDE HDD Block Mode	Disabled		
	Enabled	Invokes multi-sector transfer instead of one sector per transfer. Not all HDDs support this function.	Default
IDE ➤ Primary Master PIO ➤ Primary Slave PIO ➤ Secondary Master PIO ➤ Secondary Slave PIO	mode 0-4	0 is the slowest speed 4 is the fastest speed	
	Auto	For better performance and stability, we suggest you use the Auto setting to set the HDD control timing.	Default
IDE ➤ Primary Master UDMA ➤ Primary Slave UDMA ➤ Secondary Master UDMA ➤ Secondary Slave UDMA	Disabled		
	Auto	Select Auto to enable Ultra DMA Mode support.	Default
On-Chip PCI IDE ➤ Primary ➤ Secondary	Disabled	Turn off the on-board IDE	
	Enabled	Use the on-board IDE	Default

3-8.2 Keyboard Controls

Keyboard Controls	Setting	Description	Note
USB Keyboard Support	Disabled	Turn off the on-board IDE	Default
	Enabled	Use a USB keyboard	

3-8.3 Init Display Controls

Init Display Controls	Setting	Description	Note
Init Display First	PCI Slot	Choose which card – AGP Display card or PCI VGA card – to initialize first.	Default
	AGP		

3-8.4 FDC Controls

FDC Controls	Setting	Description	Note
Onboard FDC controller	Disabled	Turn off the on-board floppy controller	
	Enabled	Use the on-board floppy controller	Default

3-8.5 Onboard Serial Ports

Onboard Serial Ports	Setting	Description	Note
Onboard Serial Port 1 / Serial Port 2	Disabled		
	3F8/IRQ4	Choose serial port 1 & 2's I/O address.	Default (port 1)
	2F8/IRQ3	Do not set port 1 & 2 to the same address except for Disabled or Auto.	Default (port 2)
	3E8/IRQ4 2E8/IRQ3		
	Auto		
UART Mode Select	Normal	The second serial port offers these InfraRed interface modes.	Default
	IrDA		
	ASKIR		
If [UART Mode Select] is set to [IrDA]/[ASKIR]			
RxD, TxD Active	Hi, Hi, Lo, Lo, Lo, Hi, Hi, Lo	This item allows you to determine the active of RxD, TxD.	

3-8.6 Onboard Parallel Ports

Onboard Parallel Ports	Setting	Description	Note
Onboard Parallel Port	378H/IRQ7	Choose the printer I/O address.	Default
	3BCH/IRQ7		
	278H/IRQ5		

Onboard Parallel Ports (Continued)

Onboard Parallel Ports	Setting	Description	Note
Parallel Port Mode	ECP/EPP	The mode depends on your external device that connects to this port.	Default
	SPP		
	ECP		
	EPP/SPP		
If [Parallel Port Mode] is set to [ECP] mode			
ECP Mode use DMA	3	Choose DMA3	Default
	1	Choose DMA1	
If [Parallel Port Mode] is set to [EPP] mode			
EPP Mode Select	EPP 1.9	Select EPP port type 1.9	
	EPP 1.7	Select EPP port type 1.7	Default
PWRON After PWR-Fail	On	The system will switch on when power comes back after a power failure.	
	Off	The system will remain off when power comes back after a power failure.	Default
	Former-sts	The system will return to the state it was in before the power failure when power returns. (i.e: If the system was on, it will switch on again, if it was off, it will remain off)	

3-8.7 MULTI I/O ADDRESSES

Default settings for multi-I/O addresses are as follows:

Port	I/O Address	IRQ	Status
LPT1	378H	7	ECP/EPP
COM1	3F8H	4	
COM2	2F8H	3	



Warning: If a default I/O address conflicts with other I/O cards such as sound card, you must change one of the I/O addresses to remedy to this address conflict. (I/O addresses can be adjusted from the BIOS Setup Utility)

3-9 SUPERVISOR PASSWORD

Based on the setting you have made in the [Security Option] of the [BIOS FEATURES SETUP] section, the password prevents access to the system or the setup program by unauthorized users. Follow this procedure to set a new password or disable the password:

1. Choose [BIOS FEATURES SETUP] in the Main Menu and press [Enter]. Select the [Security Options] item and set the field to:
 - a. [System]: The password is required every time the system is booted. This means only a person who knows the password can use this computer.
 - b. [Setup]: The password is required only when you attempt to enter the BIOS Setup program.

2. Choose [SUPERVISOR PASSWORD] from the Main Menu and press [Enter]. The following prompt appear:

Enter Password:



Warning: If you forget or lose the password, the only way to access the system is to set jumper JP5 to clear the CMOS RAM. All setup information is lost and you must run the BIOS setup program again.



Note: If you do not wish to use the password function, press [Enter] directly and the following message appears:

Password Disabled!!

3. Enter your new password and press [Enter]. The following message appears, prompting to confirm the new password:

Confirm Password:

4. Re-enter your password and then press [Enter] to exit to the Main Menu.

This diagram outlines the password selection procedure:

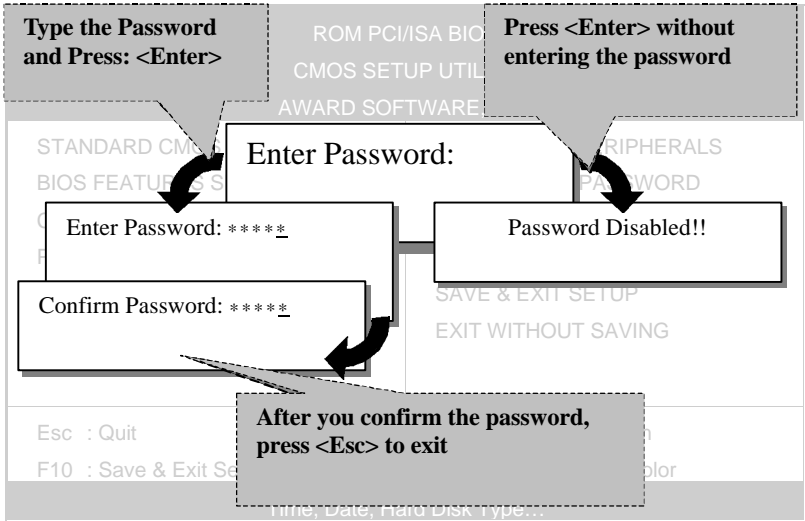

3-10 USER PASSWORD

When the user password option is on, you are not allowed to change any setting in the [CMOS SETUP UTILITY] except for changing the user's password.

The password setting procedure is similar to that for the [SUPERVISOR PASSWORD] (Refer to section 3-9).

3-11 IDE HDD AUTO DETECTION

This Main Menu function automatically detects the hard disk type and configures the STANDARD CMOS SETUP accordingly.

**ROM PCI/ISA BIOS
CMOS SETUP UTILITY
AWARD SOFTWARE, INC.**

HARD DISKS	TYPE	SIZE	CYLS	HEAD	PRECOMP	LANDZ	SECTOR	MODE
Primary Master :								
Select Primary Master Option (N=Skip) : N								
OPTIONS	SIZE	CYLS	HEAD	PRECOMP	LANDZ	SECTOR	MODE	
2(Y)	1707	827	64	0	3308	63	LBA	
1	1707	3309	16	65535	3308	63	NORMAL	
3	1707	827	64	65535	3308	63	LARGE	

Note: Some Oses(SCO-UNIX Before v5.0) must use "NORMAL" for installation

ESC : Skip



Note: This function is only valid for IDE type of hard disk drives.

Chapter 4

DRIVERS INSTALLATION

Your SY-71ZB+ Motherboard comes with a CD-ROM labeled "SOYO CD." The SOYO CD contains the user's manual file for your new Motherboard, the drivers software available for installation, and a database in HTML format with information on SOYO Motherboards and other products.

The SOYO CD Start Up Program automatically detects which SOYO Motherboard you own and displays the corresponding model name.

Step 1. Insert the SOYO CD into the CD-ROM drive

The SOYO CD will auto-run, and the SOYO CD Start Up Menu will display as shown below.



Step 2. Install Drivers and Utilities

Click the Install Drivers button to display the list of drivers software that can be installed with your Motherboard. The Start Up program displays the drivers available for the particular model of Motherboard you own. We recommend that you only install those drivers.

The following drivers are available for Windows 95

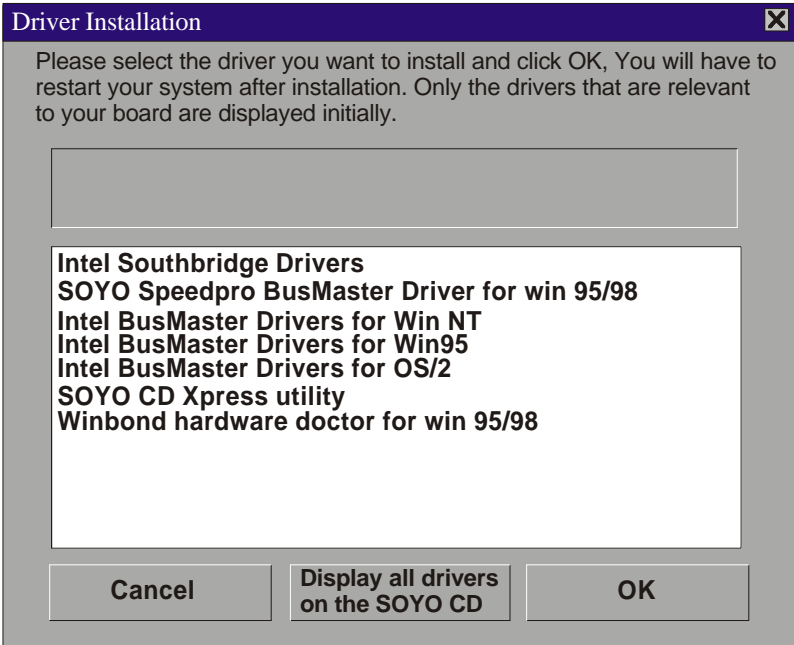

(Driver Installation Menu)

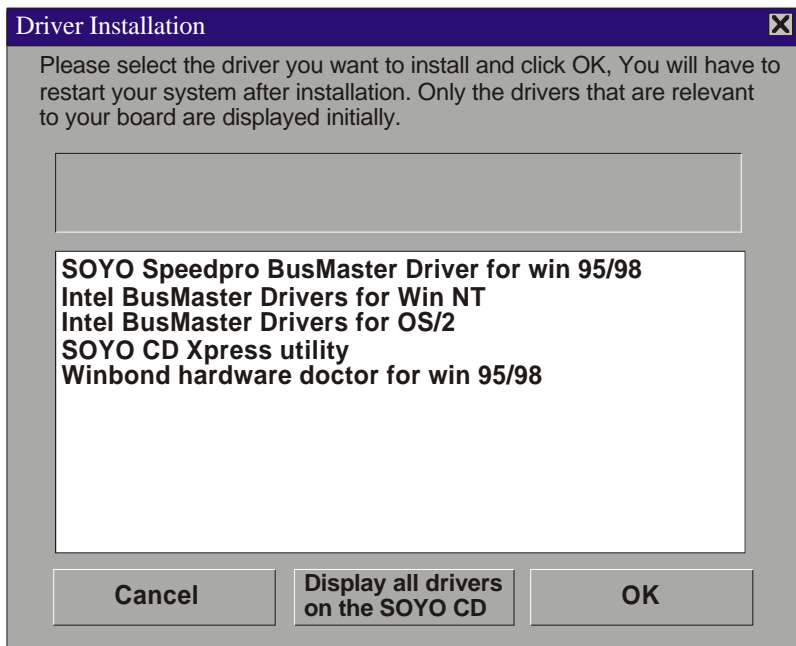
The following drivers are available for Windows 98**(Driver Installation Menu)**

However, to display the list of all drivers software available with SOYO Motherboards, click the ***Display all drivers on the SOYO CD*** button. Please make sure to install only the drivers adapted to your system, or otherwise this cause system malfunctions.

A short description of all available drivers follows:**➤ Intel Southbridge Drivers**

Because Windows 95 does not recognize the Southbridge of the newer Intel chipsets (TX, BX, ZX etc) this utility has to be run, it will update the necessary Windows files. (Only for Windows 95)

➤ SOYO SpeedPro Busmaster Driver for Win 95/98

Without the busmaster drivers the CPU will need to be involved every time data is read from or written to the Harddisk. The

busmaster drivers make use of DMA (Direct Memory Access) to relieve the CPU of this burden, thus speeding up the system.

The SOYO SpeedPro driver makes use of an advanced caching algorithm, which gives it an advantage over other busmaster drivers.

- **Intel Busmaster Drivers for Windows 95**
- **Intel Busmaster Drivers for Win NT**
- **Intel Busmaster Drivers for OS/2**

These are the official busmaster drivers as supplied by Intel.



Note: Do NEVER install two types of busmaster drivers on your system, this will lead to conflicts and system instability. Therefore, if you install the SOYO SpeedPro Busmaster driver you can NOT install the Intel Busmaster drivers. Before installing a new busmaster driver first UNINSTALL the old busmaster driver.

- **SOYO CD Xpress Utility**

This utility will enhance your CD-ROM Drive data-throughput by using space on the Harddisk as cache. This way application programs can access data faster. This utility is suitable for Windows 95/98.

- **Winbond hardware doctor for Windows xx**

Your motherboard comes with a hardware monitoring IC. By installing this utility Temperature, Fan speed and Voltages can be monitored. It is also possible to set alarms when current system values exceed or fall below pre-set values.

Because the Hardware monitor comes with default monitoring settings that may not be appropriate to the configuration of the actual system, it is possible that the user will have to change some of these settings.

- **Core voltage**

The core voltage differs between generations of Intel CPUs, if the Hardware monitor gives a warning, the settings for the safe range of the core voltage has to be adjusted. This can be done by simply clicking and dragging the upper and lower limit bars.

For example:

Newer Celeron™ CPUs have a core voltage of 2.0V. Therefore, set the CPU Vcore limits to 1.8V and 2.2V.

- **Fan speed**

The Hardware monitor can keep track of three fans. If the user does not use all fans, the fans that are not in use should be disabled in the Hardware monitor program, otherwise the Hardware monitor will give an alarm. If this happens, make sure to disable monitoring for that fan.

Step 3. Check the Latest Releases

Click the 'Check the latest Releases' button to go the SOYO Website to automatically find the latest BIOS, manual and driver releases for your motherboard. This button will only work if your computer is connected to the internet through a network or modem connection. Make sure to get your modem connection up before clicking this button.

Step 4. Enter the SOYO CD

Click the **Enter SOYO CD** button to enter the SOYO HTML database. The Start Up program will activate the default HTML browser installed on your system (for example, Internet Explorer or Netscape) to visualize the contents of the SOYO CD.

The SOYO CD contains useful information about your Motherboard and other SOYO products available in as many as eleven different languages. For your convenience, this information is available in HTML format, similar to the format widely used on the Internet.

Step 5. Select which driver you want to install and click *OK*

Notice 1: You may click ***Cancel*** to abort the driver installation and return to the main menu.

Notice 2: Once you have selected a driver, the system will automatically exit the SOYO CD to begin the driver installation program. When the installation is complete, most drivers require you to restart your system before they can become active.