



SY-6BA+ IV Motherboard

Pentium® III, Pentium® II & Celeron™

Processor supported

82440 BX AGP/PCI Motherboard

66 & 100 MHz Front Side Bus supported

ATX Form Factor

User's Manual

Copyright © 1999 by Soyo Computer Inc.

Trademarks:

Soyo is the registered trademark of Soyo Computer Inc. All trademarks are the properties of their owners.

Product Rights:

All names of the product and corporate mentioned in this publication are used for identification purposes only. The registered trademarks and copyrights belong to their respective companies.

Copyright Notice:

All rights reserved. This manual has been copyrighted by Soyo Computer Inc. No part of this manual may be reproduced, transmitted, transcribed, translated into any other language, or stored in a retrieval system, in any form or by any means, such as by electronic, mechanical, magnetic, optical, chemical, manual or otherwise, without permission in writing from Soyo Computer Inc.

Disclaimer:

Soyo Computer Inc. makes no representations or warranties regarding the contents of this manual. We reserve the right to amend the manual or revise the specifications of the product described in it from time to time without obligation to notify any person of such revision or amend. The information contained in this manual is provided to our customers for general use. Customers should be aware that the personal computer field is subject to many patents. All of our customers should ensure that their use of our products does not infringe upon any patents. It is the policy of Soyo Computer Inc. to respect the valid patent rights of third parties and not to infringe upon or to cause others to infringe upon such rights.

Restricted Rights Legend:

Use, duplication, or disclosure by the Government is subject to restrictions set forth in subparagraph (c)(1)(ii) of the Rights in Technical Data and Computer Software clause at 252.277-7013.

About This Guide:

This Quick Start Guide can help system manufacturers and end users in setting up and installing the Motherboard. Information in this guide has been carefully checked for reliability; however, to the correctness of the contents there is no guarantee given. The information in this document is subject to amend without notice.

For further information, please visit our **Web Site** on the Internet. The address is "<http://www.soyo.com.tw>".

Edition: August 1999
Version 1.0
6BA+ IV SERIAL

FC Tested To Comply
With FCC Standards
FOR HOME OR OFFICE USE
100% POST CONSUMER
RECYCLED PAPER

Table of Contents

CHAPTER 1	MOTHERBOARD DESCRIPTION	1
1- 1	INTRODUCTION.....	1
1- 2	KEY FEATURES.....	1
1- 3	HANDLING THE MOTHERBOARD.....	5
1- 4	ELECTROSTATIC DISCHARGE PRECAUTIONS.....	5
1- 5	SY 6BA+ IV MOTHERBOARD LAYOUT.....	6
1- 6	SY 6BA+ IV MOTHERBOARD COMPONENTS	7
1- 7	MICROPROCESSOR.....	9
1- 8	MEMORY.....	9
1- 9	CHIPSET.....	11
1- 10	I O INTERFACE CONTROLLER.....	16
1- 11	HARDWARE MONITOR.....	18
1- 12	WAKE ON LAN TECHNOLOGY.....	18
CHAPTER 2	HARDWARE INSTALLATION.....	19
2- 1	PREPARATIONS.....	19
2- 2	UNPACKING THE MOTHERBOARD.....	20
2- 3	INSTALLATION GUIDE.....	21
2-3.1	<i>CPU Fan Installation.....</i>	<i>22</i>
2-3.2	<i>SDRAM Memory Module Installation.....</i>	<i>26</i>
2-3.3	<i>Motherboard Connector.....</i>	<i>28</i>
2-3.4	<i>Jumper Setting.....</i>	<i>43</i>
2-3.5	<i>CMOS Clearing (JP5).....</i>	<i>45</i>
2-3.6	<i>Power On.....</i>	<i>46</i>
2-3.7	<i>Quick BIOS Setup.....</i>	<i>47</i>
2-3.8	<i>Troubleshooting at First Start</i>	<i>50</i>
2-3.9	<i>Power Off.....</i>	<i>51</i>
CHAPTER 3	BIOS SETUP UTILITY	52



3- 1	SOYO COMBO SETUP.....	54
3- 2	STANDARD CMOS SETUP.....	61
3- 3	BIOS FEATURES SETUP.....	64
3- 4	CHIPSET FEATURES SETUP.....	69
3- 5	POWER MANAGEMENT SETUP	72
3- 6	PNP/ PCI CONFIGURATION SETUP.....	76
3- 7	LOAD SETUP DEFAULTS	79
3- 8	INTEGRATED PERIPHERALS.....	80
3- 9	SUPERVISOR PASS WORD.....	85
3- 10	USER PASS WORD.....	86
3- 11	IDE HDD AUTO DETECTION.....	87
CHAPTER 4 DRIVERS INSTALLATION		88
CHAPTER 5 THE ATA 66 DRIVER INSTALLATION		94

Chapter 1

MOTHERBOARD DESCRIPTION

1-1 INTRODUCTION

The **SY-6BA+ IV** AGP/ PCI Motherboard is a high-performance Slot 1 supported ATX form-factor system board. **SY-6BA+ IV** uses the VIA Chipset technology and supports Slot 1 class processors. This Motherboard is fully compatible with industry standards and adds many technical enhancements.

1-2 KEY FEATURES

➤ CPU SUPPORT

The SY 6BA+ IV supports a wide range of INTEL CPUs:

- Intel Pentium III 450~600 MHz
- Intel Pentium II 233~450 MHz
- Intel Celeron 266~433 MHz

New released Intel Slot 1 CPUs will very likely be supported by the SY 6BA+ IV as well.

➤ CPU SETTINGS

The SY 6BA+ IV provides the user with a very complete and convenient CPU setting environment. The CPU settings are all adjusted through the special SOYO COMBO page in the BIOS, therefore rendering the use of jumpers obsolete.

■ CPU FSB Frequency

The SY 6BA+ IV supports an incredible wide range of CPU FSB frequency settings:

66, 75, 81, 83, 90, 95, 100, 105, 110, 112, 113, 115, 117, 118, 120, 122, 124, 126, 133, 135, 137, 138, 140, 142, 144, 150 and 155 MHz.

This ensures that the SY 6BA+ IV has an overwhelming overclocking potential.

■ **CPU Multiplier**

The SY 6BA+ IV supports a wide range of multipliers:

2.0x, 2.5x, 3.0x, 3.5x, 4.0x, 4.5x, 5.0x, 5.5x, 6.0x, 6.5x, 7.0x, 7.5x and 8.0x

■ **CPU Core Voltage**

The CPU Core voltage is set automatically according to CPU needs. The SY 6BA+ IV supports an advanced Core voltage feature; it can be adjusted through the BIOS directly without setting jumper. In normal mode the voltage will be standard, apart from that the user can specify increments of 2.5%, 5%, 7.5% and 10% on top of the standard voltage. This will provide the CPU with the power it needs for overclocking.

➤ **EXPANDABILITY**

The SY 6BA+ IV provides all the standard expansion slots, and many more additional expansion features:

◆ **Expansion slots**

- 1 x 32-bit bus mastering AGP slot
- 5 x 32-bit bus mastering PCI slots
- 2 x 16-bit ISA slots

◆ **Enhanced IO**

- Floppy disk controller
- 2x EIDE controllers with support for up to 4 Ultra DMA 33/66 devices
- Standard/ EPP/ ECP parallel port
- 2x 16550 compatible serial ports
- IrDA compatible infrared port
- 2x USB (Universal Serial Bus) connectors
- PS/2 mouse connector
- PS/2 keyboard connector

➤ **ADVANCED FUNCTIONS**

The SY 6BA+ IV supports advanced functions such as:

- ATA 66 IDE Ports

In addition to the original two ATA33 (Ultra DMA 33) IDE ports, the SY 6BA+ IV supports two ATA66 (Ultra DMA 66) IDE ports that is

capable of transferring data up to 66 Mbytes/sec (IDE DMA Mode 4).

■ **Wake-On-LAN**

Supports Wake-On-LAN (*Some advanced network cards can wake the system up over the network, the WOL connector is provided by the SY-6BA+ IV to support this function*).

■ **Multiple boot**

The SY-6BA+ IV supports booting from devices such as CD-ROM

■ **Power on by modem or alarm**

If the SY-6BA+ IV system is in suspend mode, it can be switched back on through the modem or RTC alarm through this function. This opens a lot of possibilities, such as remote access that switches the system on only after the modem receives a call.

➤ **FAIL SAFE**

The SY-6BA+ IV comes with added functionality to make managing the system easy and safe

◆ **Hardware Monitor**

The integrated Winbond Hardware Monitor IC and Hardware doctor software enables the user the monitor system voltages, temperatures and FAN speeds. This makes sure that the user is full control of the system

◆ **Power Failure Resume Function**

This function can be set in the BIOS, and determines whether the system will automatically turn on again after a power failure. This function is indispensable for server systems that need to always be on line.

◆ **5VSB Indicator**

This green LED gives an indication of the presence of the 5V Standby voltage. This voltage is always fed into the motherboard and is used for functions such as WOL.

➤ **NORTON SOFTWARE PACK**

- Antivirus
- Ghost
- Virtual Drive

➤ **COMPLIANCE**

The SY 6BA+ IV complies with all important industry standards. The following underlines the reliability of the SY 6BA+ IV a motherboard to trust.

- Year 2000 compliant
- PC98 compliant
- FCC CE compliant

➤ **USER FRIENDLY**

- SOYO Combo Setup
- Jumperless design
- You can set up the following options trough the BIOS setting
 - CPU FSB frequency
 - CPU multiplier
 - CPU Vcore voltage
 - PCI clock
 - AGP Clock
 - SDRAM Clock

1-3 HANDLING THE MOTHERBOARD

To avoid damage to your Motherboard, follow these simple rules while unpacking:

- Before handling the Motherboard, ground yourself by grasping an unpainted portion of the system's metal chassis.
- Remove the Motherboard from its anti-static packaging. Hold the Motherboard by the edges and avoid touching its components.
- Check the Motherboard for damage. If any chip appears loose, press carefully to seat it firmly in its socket.



Warning: Do not apply power if the Motherboard appears damaged. If there is damage to the board, contact your dealer immediately.

1-4 ELECTROSTATIC DISCHARGE PRECAUTIONS

Make sure to ground yourself before handling the Motherboard or other system components. Electrostatic discharge can easily damage the components. Note that you must take special precautions when handling the Motherboard in dry or air-conditioned environment.

To protect your equipment from electrostatic discharge, take the following precautions:

- Do not remove the anti-static packaging until you are ready to install.
- Ground yourself before removing any system component from its protective anti-static packaging. (To ground yourself, grasp the expansion slot covers or other unpainted portions of the computer chassis.)
- Frequently ground yourself while working or use a grounding strap.
- Handle the Motherboard by its edges and avoid touching its components.

1-5 SY-6BA+ IV MOTHERBOARD LAYOUT

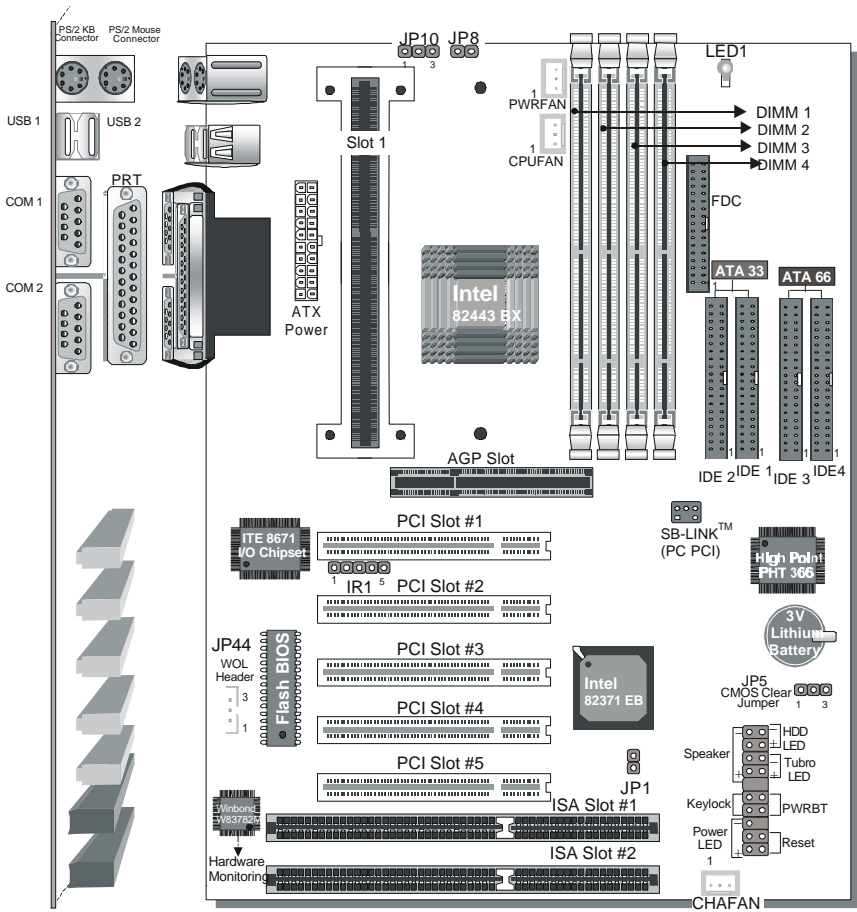

Back Panel

SY-6BA+ IV Platform

1-6 SY-6BA+ IV MOTHERBOARD COMPONENTS

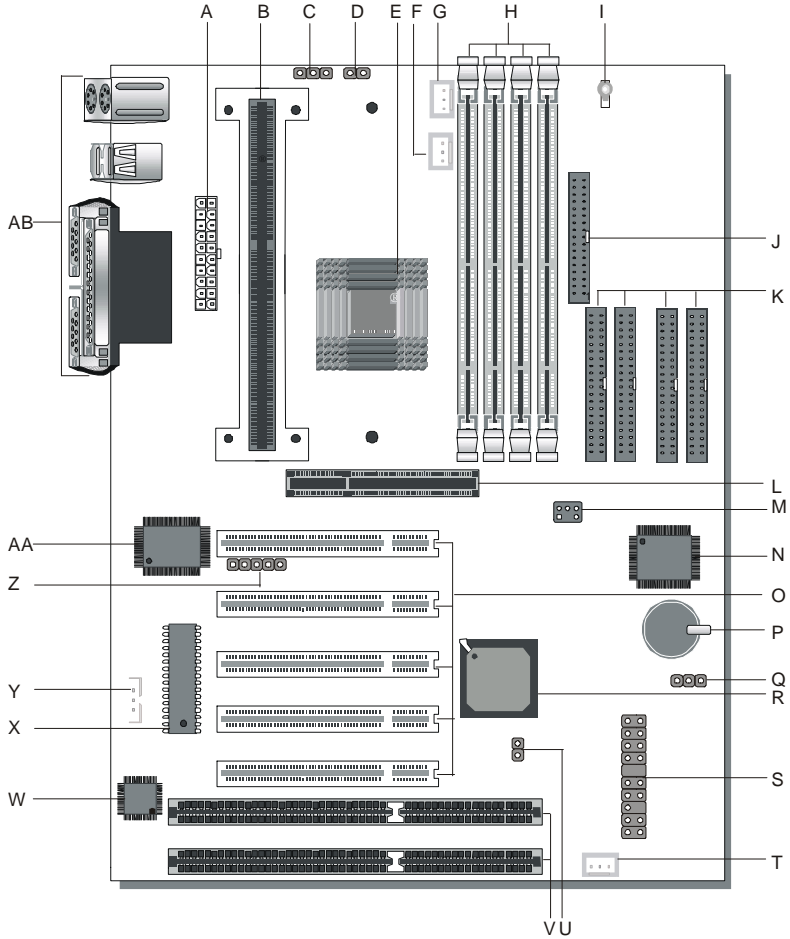

- A** ATX Power Supply Connector
- B** Slot 1 Connector
- C** Power On by Keyboard Jumper
- D** CPU multiplier release Jumper
- E** Intel 82440 BX PCI/ AGP Set
- F** CPU Cooling Fan Connector
- G** Power Cooling Fan Connector
- H** DIMM Bank
- I** 5 V Stand-by indicator LED
- J** Floppy Disk Drive (FDD) Port
- K** Bus Mastering E IDE/ ATAPI Ports
- L** 32-bit AGP Slot
- M** PCI Audio Card Header
- N** High Point PHT 366 ATA66 Controller
- O** 32-bit PCI Mastering Slots
- P** 3 V Lithium Battery
- Q** CMOS Clear Jumper
- R** Intel 82371 EB PIIX4 Chip
- S** Front panel connectors
- T** Chassis Cooling Fan Connector
- U** External Suspend Button Header
- V** 16-bit ISA Slots
- W** Winboard W83782M hardware monitoring
- X** Flash BIOS Chip
- Y** Wake-On-LAN (WOL) Header
- Z** Serial Infrared (IrDA) Device Header
- AA** ITE 8671 super I/O Controller
- AB** Back panel Connectors

1-7 MICROPROCESSOR

The motherboard supports a single Slot 1 processor. The processor's VID pins automatically program the voltage regulator on the motherboard to the required processor voltage. In addition, the front side bus speed (66 MHz and 100 MHz) is automatically selected. The motherboard supports all current Slot 1 processor speeds, voltages, and bus frequencies.

1-7.1 Microprocessor Packaging

The processor is packaged in a Single Edge Contact Cartridge (SECC or SECC2) or Single Edge Processor Package (S.E.P.P). The cartridge includes the processor core, second-level cache subsystem, thermal plate, and back cover.

The processor connects to the motherboard through the Slot1 connector, a 242-pin edge connector. When mounted in Slot1, the processor is secured by a retention mechanism attached to the motherboard. A passive heatsink is stabilized by the heatsink supports.

1-7.2 Second Level Cache

The second-level cache is located on the substrate of the CPU package. The cache includes 0KB/ 128KB (Celeron) or 512 KB (PII/PIII) of synchronous pipelined burst static RAM. All supported onboard memory can be cached.

1-7.3 Microprocessor Upgrades

The motherboard can be upgraded with Slot 1 processors that run at higher speeds. When upgrading the processor, use the BIOS configuration mode to change the processor speed.

1-8 MEMORY

1-8.1 Main Memory

The motherboard has four DIMM sockets. SDRAM can be installed in one,

two, three, or four sockets. Using the serial presence detect (SPD) data structure, programmed into an EPROM on the DIMM, the BIOS can determine the SDRAM's size and speed. Minimum DIMM memory size is 8 MB; maximum DIMM memory size is 256MB. Memory size and speed can vary between sockets.

The motherboard supports the following memory features:

- 168-pin DIMMs with gold-plated contacts
- 66/ 100/ 133 MHz SDRAM
- Non-ECC (64-bit) and ECC (72-bit) memory
- 3.3 V memory only
- Supports 8/ 16/ 32/ 64/ 128/ 256 MB DIMM Modules
- Support unbuffered or registered single- or double-sided DIMMs

Note

Slot 1 processors with 100 MHz front-side bus should be paired only with 100 MHz SDRAM. Processors with 66 MHz front side bus can be paired with either 66 MHz or 100 MHz SDRAM.

1-8.2 SDRAM

SDRAM improves memory performance through memory access that is synchronous with the front-side bus clock. Burst transfer rates at x-1-1-1 timing can be achieved using SDRAM, while asynchronous memory subsystem are typically limited at x-2-2-2 transfer rates.

Note

All memory components and DIMMs used with the SY-6BA+ IV motherboard must comply with the PC SDRAM specifications. These include: the PC SDRAM Specification (memory component specific), the PC Unbuffered DIMM Specification, and the PC Serial Presence Detect Specification.

1-8.3 ECC Memory

ECC memory detects multiple-bit errors and corrects single-bit errors.

When ECC memory is installed, the BIOS supports both ECC and non-ECC mode. ECC mode is enabled in the Setup program. The BIOS automatically detects if ECC memory is installed and provides the Setup option for selecting ECC mode. If any non-ECC memory is installed, the Setup option for ECC configuration does not appear and ECC operation is not available.

1-9 CHIPSET

The Intel 440BX PCIset includes a Host-PCI bridge integrated with both an optimized DRM controller and an A.G.P. interface. The I/O subsystem of the 440BX is based on the PIIX4E, which is a highly integrated PCI-ISA IDE Accelerator Bridge. This chipset consists of the Intel 82443BX PCI A.G.P. controller (PAC) and the Intel 82371EB PCI ISA IDE Xcelerator (PIIX4E) bridge chip.

1-9.1 Intel 82443Bx PCI/A.G.P. Controller (PAC)

The PAC provides bus-control signals, address paths, and data paths for transfers between the processor's host bus, PCI bus, the A.G.P., and main memory. The PAC features:

- Processor interface control
 - Support for processor host bus frequencies of 100 MHz or 66MHz
 - 32-bit addressing
 - Desktop Optimized GTL+ compliant host bus interface
- Integrated DRAM controller, with support for:
 - +3.3 V only DIMM DRAM configurations
 - Up to four double sided DIMMs
 - 100-MHz or 66MHz SDRAM
 - DIMM serial presence detect via SMBus interface
 - 16- and 64-Mbit devices with 2K, 4K, and 8K page sizes
 - SDRAM 64-bit data interface with ECC support
 - Symmetrical and asymmetrical DRAM addressing

- A.G.P. interface
 - Complies with the A.G.P. specification
 - Support for +3.3 V A.G.P.- 66/ devices
 - Synchronous coupling to the host- bus frequency
- PCI bus interface
 - Complies with the PCI specification
 - Asynchronous coupling to the host- bus frequency
 - PCI parity generation support
 - Data streaming supports from PCI to DRAM
 - Support for five PCI bus masters in addition to the host and PCI to ISA I/O bridge
 - Support for concurrent host, A.G.P., and PCI transactions to main memory
- Data buffering
 - DRAM write buffer with read-around- write capability
 - Dedicated host- DRAM, PCI to DRAM, and PCI A.G.P.- to DRAM read buffers
 - A.G.P. dedicated inbound/ outbound FIFOs (133/ 66 MHz), used for temporary data storage
- Power management functions
 - Support for system suspend/ resume (DRAM and power- on suspend)
 - Compliant with ACPI power management
- SMBus support for desktop management functions
- Support for system management mode (SMM)

1-9.2 Intel 82371EB PCI ISA IDE Xcelerator (PIIX4E)

The PIIX4E is a multifunction PCI device implementing the PCI to ISA bridge, PCI IDE functionality, USB host/ hub functionality, and enhanced power management. The PIIX4E features:

- Multifunction PCI to ISA bridge
 - Support for the PCI bus at 33 MHz

- Complies with the PCI specification
- Full ISA bus support
- USB controller
 - Two USB ports
 - Support for legacy keyboard and mouse
 - Support for UHCI interface
- Integrated dual channel enhanced IDE interface
 - Support for up to four IDE devices
 - PIO mode 4 transfers at up to 16 MB/ sec
 - Support for Ultra DMA/ 33 synchronous DMA mode transfers up to 33 MB/ sec
 - Bus master mode with an 8 x 32- bit buffer for bus master PCI IDE burst transfers
- Enhanced DMA controller
 - Two 8237- based JDMA controllers
 - Supports for PCI DMA with three PC PCI channels and distributed DMA protocols
- Interrupt controller based on 82C59
 - Support for 15 interrupts
 - Programmable for edge/ level sensitivity
- Power management logic
 - Sleep/ resume logic
 - Support for wake- on- modem, Wake on LAN technology, and wake on PME
 - Support for ACPI
- Real- Time Clock
 - 256- byte battery- backed CMOS SRAM
 - Includes date alarm
- 16- bit counters/ timers based on 82C54

1-9.3 Accelerated Graphics Port (A.G.P.)

A.G.P. is a high- performance bus for graphics- intensive applications, such as 3D applications. A.G.P., while based on the PCI Local Bus

Specifications, Rev 2.1, is independent of the PCI bus and is intended for exclusive use with graphical display devices. A.G.P. overcomes certain limitations of the PCI bus related to handling a large amount of graphics data with the following features:

- Pipelined memory read and write operations that hide memory access latency
- Demultiplexing of address and data on the bus for near 100 percent bus efficiency
- AC timing for 133 MHz data transfer rates, allowing real data throughput in excess of 500 MB/sec

1-9.4 Universal Serial Bus (USB)

The motherboard has two USB ports; one USB peripheral can be connected to each port. For more than two USB devices, an external hub can be connected to either port. The motherboard fully supports the universal host controller interface (UHCI) and used UHCI compatible software drivers.

Specification USB features include:

- Self-identifying peripherals that can be plugged in while the computer is running
- Automatic mapping of function to driver and configuration
- Support for isochronous and asynchronous transfer types over the same set of wires
- Support for up to 127 physical devices
- Guaranteed bandwidth and low latencies appropriate for telephony, audio, and other applications
- Error-handling and fault-recovery mechanisms built into the protocol

Note

Computer systems that have an unshielded cable attached to a USB port may not meet FCC Class B requirements, even if no device or a low-speed USB device is attached to the cable. Use shielded cable that meets the requirements for a full-speed USB device.

1-9.5 IDE Support

The motherboard has two independent ATA 33 and two independent ATA 66 bus-mastering PCI IDE interfaces. These interfaces support PIO Mode3, PIO Mode 4, ATAPI devices (e.g., CD-ROM), and Ultra DMA/33 (IDE1, IDE2) or Ultra DMA/66 (IDE3, IDE4) synchronous-DMA mode transfers. See “IDE Device installation” (on page 29) for more information. The BIOS supports logical block addressing (LBA) and extended cylinder head sector (ECHS) translation modes. The BIOS automatically detects the IDE device transfer rate and translation mode.

Programmed I/O operations usually require a substantial amount of processor bandwidth. However, in multitasking operating systems, the bandwidth freed by bus mastering IDE can be devoted to other tasks while disk transfers are occurring.

The motherboard also supports laser servo (LS-120) drives. LS-120 technology allows the user to perform read/write operations to LS-120 (120MB) and conventional 1.44MB and 720KB diskettes. An optical servo system is used to precisely position a dual-gap head to access the diskett’s 2,490 tracks per inch (tpi) containing up to 120 MB of data storage. A conventional diskette uses 135 tpi for 1.44 MB of data storage. LS-120 drivers are ATAPI-compatible and connect to the motherboard’s IDE interface. (LS-120 drives are also available with SCJSI and parallel port interfaces.) Some versions of Windows 95 and Windows NT operating systems recognize the LS-120 drive as a bootable device in both 120 MB and 1.44 MB mode.

Connection of an LS-120 drive and a standard 3.5-inch diskette drive is allowed. The LS-120 drive can be configured as a boot device if selected as Drive A in the BIOS setup program.

Note

If you connect at LS-120 drive to an IDE connector and configure it as the :boot: drive and configure a standard 3.5-inch diskette drive as a “B” drive, the standard diskette drive is not seen by the operating system.

When the LS-120 drive is configured as the “boot: device, the system will

recognize it as both the A and B drive

1-9.6 Real-Time Clock, CMOS SRAM, and Battery

The real time clock is compatible with DS1287 and MCI46818 components. The clock provides a time-of-day clock and a multicentury calendar with alarm features and century rollover. The real time clock supports 256 bytes of battery-backed CMOS SRAM in two banks that are reserved for BIOS use.

The time, date, and CMOS values can be specified in the Setup program. The CMOS values can be returned to their defaults by using the Setup program.

1-10 I/O INTERFACE CONTROLLER

The motherboard uses the ITE 8671 super I/O controller which features:

- Single diskette drive interface
- ISA Plug-and-Play compatible register set
- Two serial ports
- FIFO supports on both serial and diskette interfaces
- One parallel port with Extended Capabilities Port (ECP) and Enhanced Parallel Port (EPP) support
- PS/2 style mouse and keyboard interfaces
- PCI PME interface
- Vialigent auto power management, including:
 - Shadowed write-only registers for ACPI compliance
 - Programmable wake-up event interface

The Setup program provides configuration option for the I/O controller.

1-10.1 Serial Ports

The NS16C5450-compatible UARTs support data transfers at speeds up to 115.2 Kbits/sec with BIOS support.

1-10.2 Parallel Port

In the Setup program, there are four options for parallel port operation:

- Compatible (standard mode)

- Bi-directional (PS/2 compatible)
- Bi-directional EPP. A driver from the peripheral manufacturer is required for operation.
- Bi-directional high-speed ECP

1-10.3 Diskette Drive Controller

The I/O controller is software compatible with the 82077 diskette drive controller and supports both PC AT and PS/2 modes. In the Setup program, the diskette drive interface can be configured for the following diskette drive capacities and sizes.

- 360 KB, 5.25-inch
- 1.2 MB, 5.25-inch
- 720 KB, 3.5-inch
- 1.2 MB, 3.5-inch (driver required)
- 1.25-1.44 MB, 3.5-inch
- 2.88 MB, 3.5-inch

1-10.4 Keyboard and Mouse Interface

The +5 V lines to keyboard and mouse connectors are protected with a fuse that prevents motherboard components from being damaged when an over-current condition occurs.

The keyboard controller contains code, which provides the traditional keyboard and mouse control functions, and also supports Power On/Reset password protection. Power On/Reset password can be specified in the BIOS Setup program.

The keyboard controller also supports the hot-key sequence <Ctrl><Alt>, software reset. This key sequence resets the computer's software by jumping to the beginning of the BIOS code and running the Power On Self Test (POST).

1-10.5 Infrared Support

The IR connection can be used to transfer files to or from portable devices like laptops, PDAs, and printers.

1-11 HARDWARE MONITOR

The optional hardware monitor subsystem provides low cost instrumentation capabilities. The features of the hardware monitor subsystem include:

- An integrated ambient temperature sensor
- Fan speed sensors, which monitor the fan 1 and fan 2 connectors
- Power supply voltage monitoring to detect levels above or below acceptable values

When suggested ratings for temperature, fan speed, or voltage are exceeded, an interrupt is activated. The hardware monitor component connects to the SMBus.

1-12 WAKE ON LAN TECHNOLOGY

Wake on LAN technology enables remote wakeup of the computer through a network. Wake on LAN technology requires a PCI add-in network interface card (NIC) with remote wakeup capabilities. The remote wakeup connector on the NIC must be connected to the onboard Wake on LAN technology connector. The NIC monitors network traffic at the MII interface; upon detecting a Magic Packet, the NIC asserts a wakeup signal that powers up the computer. To access this feature uses the Wake on LAN technology connector.

⚠ CAUTION

For Wake on LAN, the 5-V standby line for the power supply must be capable of delivering +5V ±5 % at 720mA. Failure to provide adequate standby current when implementing Wake on LAN can damage the power supply.

Chapter 2

HARDWARE INSTALLATION

Congratulations on your purchase of **SY-6BA+ IV** Motherboard. You are about to install and connect your new Motherboard.



Note: Do not unpack the Motherboard from its protective anti-static packaging until you have made the following preparations.

2-1 PREPARATIONS

Gather and prepare all the following hardware equipment to complete the installation successfully:

1. Slot 1 processor with built-in CPU cooling fan (boxed type).



Note: This Motherboard supports non-boxed type CPUs. The heavier CPU cooling fan requires the installation of a CPU support stand.

2. DIMM memory module
3. Computer case and chassis with adequate power supply unit
4. Monitor
5. PS/2 Keyboard
6. Pointing Device (PS/2 mouse)
7. Speaker(s) (optional)
8. Disk Drives: HDD, CD ROM, Floppy drive ...
9. External Peripherals: Printer, Plotter, and Modem (optional)
10. Internal Peripherals: Modem and LAN cards (optional)

2-2 UNPACKING THE MOTHERBOARD

When unpacking the Motherboard, check for the following items:

◆ The SY 6BA+ IV 82440 BX AGP/ PCI Motherboard



◆ The Quick Start Guide



◆ The Installation CD ROM



◆ SOYO 3-in-1 Bonus Pack CD ROM (Norton AntiVirus, Ghost and Virtual Drive)



◆ The CPU Retention Set



◆ One IDE Device ATA 66 Flat Cable



◆ One IDE Device Flat Cable



◆ One Floppy Disk Drive Flat Cable

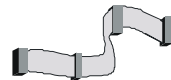

Warning: Do not unpack the Motherboard from its anti-static packaging until you are ready to install it.

Like most electronic equipment, your Motherboard may be damaged by electrostatic discharge. To avoid permanent damage to components ground yourself while working by using a grounding strap. Otherwise, ground yourself frequently by touching the unpainted portion of the computer chassis to drain the static charges.

Handle the Motherboard carefully, holding it by the edges.

You are now ready to start the installation.

2-3 INSTALLATION GUIDE

We will now begin the installation of the Motherboard. Please follow the step-by-step procedure designed to lead you to a complete and correct installation.



Warning: Turn off the power to the Motherboard, system chassis, and peripheral devices before performing any work on the Motherboard or system.

BEGIN THE INSTALLATION

2-3.1 CPU Installation

Your SY 6BA+ IV motherboard comes with a CPU retention set kit. The retention set is used to hold the processor attached to the Slot 1 CPU connector on the motherboard.

☑ *Mark your CPU Frequency:* Record the working frequency of your CPU that should be clearly marked on the CPU cover.

FSB 66MHz

<input type="checkbox"/> 266MHz (66 x 4.0)	<input type="checkbox"/> 333MHz (66 x 5.0)	<input type="checkbox"/> 400MHz (66 x 6.0)	<input type="checkbox"/>
<input type="checkbox"/> 300MHz (66 x 4.5)	<input type="checkbox"/> 366MHz (66 x 5.5)	<input type="checkbox"/> 433MHz (66 x 6.5)	

FSB 100MHz

<input type="checkbox"/> 350MHz (100 x 3.5)	<input type="checkbox"/> 450MHz (100 x 4.5)	<input type="checkbox"/> 550MHz (100 x 5.5)	<input type="checkbox"/>
<input type="checkbox"/> 400MHz (100 x 4.0)	<input type="checkbox"/> 500MHz (100 x 5.0)	<input type="checkbox"/> 600MHz (100 x 6.0)	

Follow these instructions to install your Slot 1 processor correctly.

➤ Retention Module



1. Open the two sides by folding them up.



2. Push the locks on top of the CPU inward.



3. Insert the CPU into the retention module. The CPU fits in the CPU slot in only ONE way, do not try to force it in.



4. After completely inserting the CPU, push the two locks on top of the CPU outward. Now your CPU is ready for use.



To remove the CPU, press the two notches on top of the CPU inward. Now press the two slides on the retention module down and remove the CPU.



Note: *Installing a heat sink and cooling fan on top of your CPU is necessary for proper heat dissipation. Failing to install these items may result in overheating and possible burn-out of your CPU.*

2-3.1.1 CPU Fan Installation

Your Slot 1 processor kit comes with a cooling fan. Mount the fan on the processor according to the instructions provided by the manufacturer. The fan is a key component that will ensure system stability. The fan prevents overheating, therefore prolonging the life of your CPU.



Note: Remember to connect the fan to the appropriate power source.

2-3.2 SDRAM Memory Module Installation

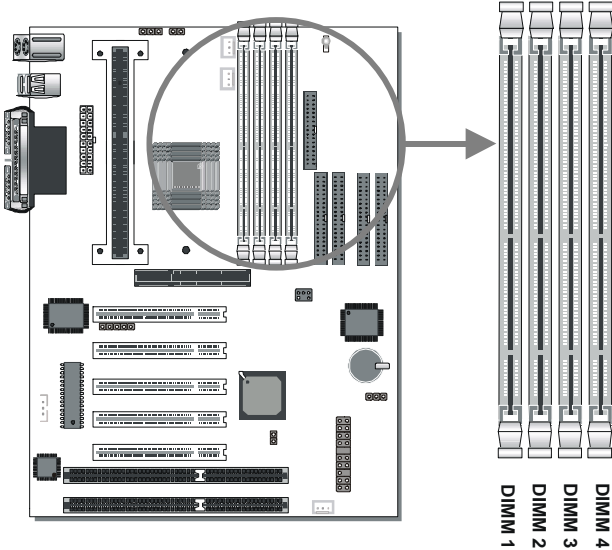

Your board comes with four DIMM sockets, providing support for up to 512 Mbytes or 1 GB (with registered DIMMs). For 66MHz front side bus CPUs use 12ns or faster memory; for 100MHz front side bus CPUs use 8ns (100MHz, PC100 compliant) memory.

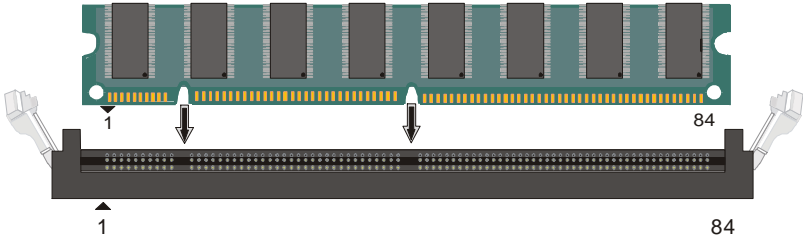

Number of Memory Modules	DIMM 1	DIMM 2	DIMM 3	DIMM 4
1	1 st			
2	1 st	2 nd		
3	1 st	2 nd	3 rd	
4	1 st	2 nd	3 rd	4 th
RAM Type	SDRAM			
Memory Module Size (MB)	8/ 16/ 32/ 64/ 128/ 256 Mbytes			
<i>Note:</i> (1) 256 MB memory modules available on PC registered DIMM only. (2) Always install memory modules in the order prescribed in this table. (3) Do not install unbuffered and registered memory modules together.				

Important: It is of prime importance that you install DIMM modules as outlined in the table above in order to preserve signal integrity on 100 MHz front side bus systems.

2-3.3 Motherboard Connector

2-3.3.1 IDE Device Installation (HDD, CD-ROM)



The 6BA+ IV comes with four IDE connectors, with support for up to 8 IDE Devices. For the supported interface modes, refer to the table below:

IDE Connector	PIO mode	DMA Mode	ULTRA DMA33 (ATA 33)	ULTRA DMA66 (ATA 66)
IDE 1 & 2	Yes	Yes	Yes	No
IDE 3 & 4	Yes	Yes	Yes	Yes

Note: It is required to connect the ATA66 HDDs with the ATA66 flat cable to the motherboard to maintain proper functionality and stability of the ATA66 high speed interface.

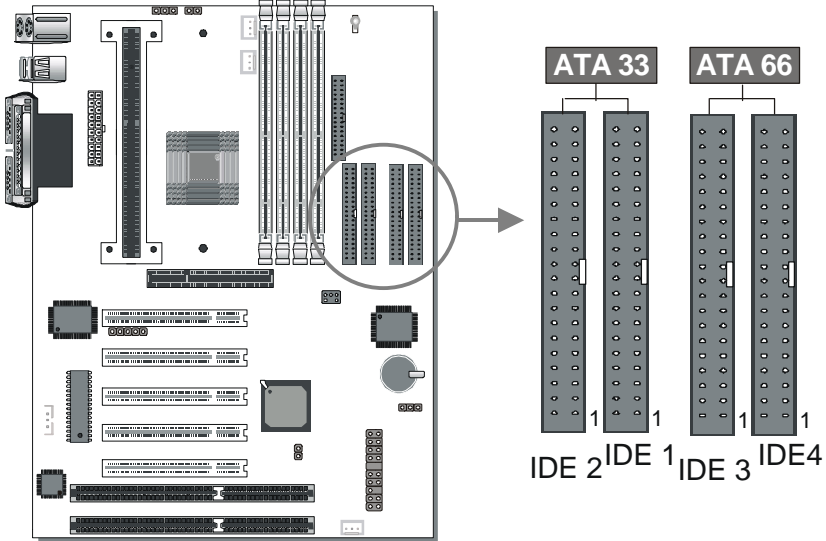

Connect one side of the ATA 33 or ATA 66 flat cable to the IDE device (HDD or CD ROM) and plug the other end to the IDE1~IDE4 directionally keyed IDE connector on the Motherboard. ATA66 cable can be used backward compatible with ATA33 HDD.

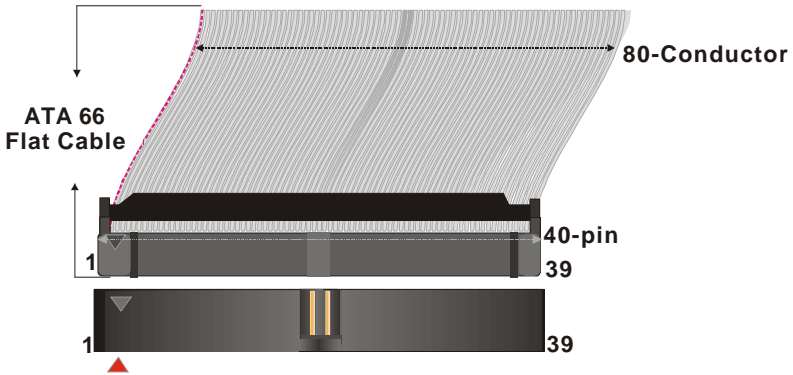
**Note:**

The System will recognize the devices on IDE3 and 4 as SCSI devices. Therefore Windows will list the two device (IDE3 and 4) as SCSI devices, this is normal. If you want to boot from a HDD connected to IDE3 or 4, set the Boot Sequence item on the SOYO COMBO Setup page in the BIOS to SCSI, C, A.

Note that if you have a SCSI card in your system, it will have a higher priority than the devices connected to IDE3 or 4. In that case the system will boot from the first boot-able device connected to your SCSI card if the boot sequence is set to SCSI, C, A in the BIOS.

2-3.3.2 Floppy Drive Installation

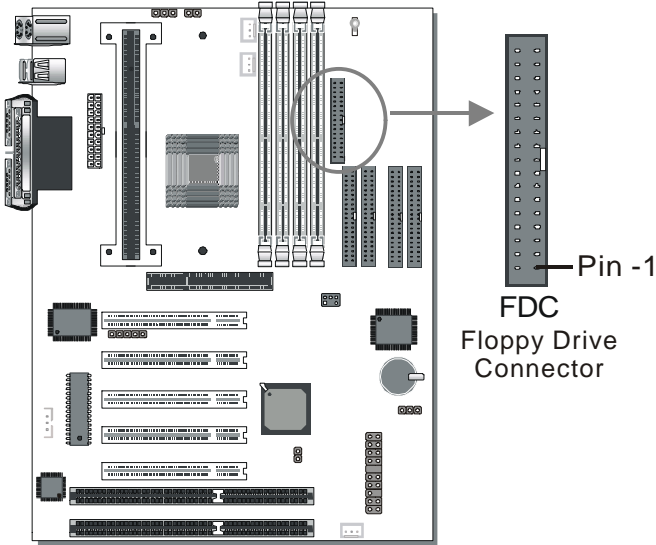

The system supports 5 possible floppy drive types: 720 KB, 1.2 MB, 1.44 MB, 2.88 MB, and LS-120. In addition, this Motherboard supports a 3-mode (720 KB/ 1.2 MB/ 1.44 MB) floppy commonly used in Japan. Connect one side of the 34-pin flat cable to the floppy drive and plug the other end to the floppy drive connector on the Motherboard. This Motherboard can support up to 2 floppy drives.

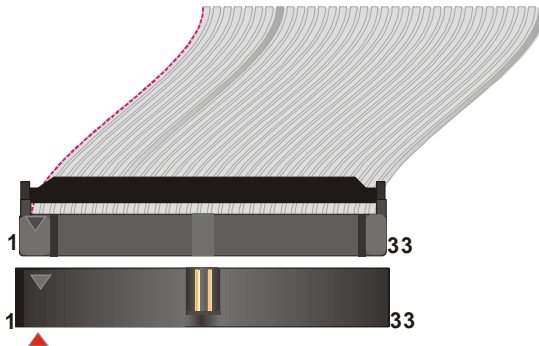

2-3.3.3 Front Panel Connections

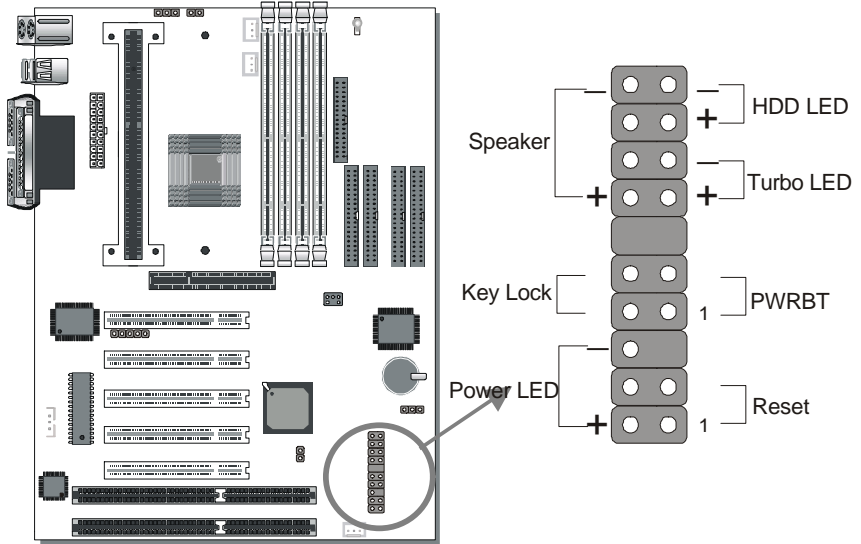

Plug the computer case's front panel devices to the corresponding headers on the Motherboard.

1. Power LED & KeyLock

Plug the Power LED cable into the 5-pin Keylock header.

Some systems may feature a KeyLock function with a front panel switch for enabling or disabling the keyboard. Connect the KeyLock switch to the 5-pin Keylock header on the Motherboard.

Please install according to the following pin assignment: pin 1,3 are for Power LED and pin 4,5 are for Keylock.

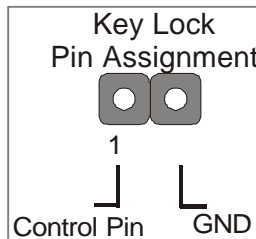
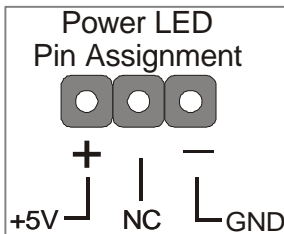

2. Reset

Plug the Reset push-button cable into the 2-pin Reset header on the Motherboard. Pushing the Reset button on the front panel will cause the system to restart the boot-up sequence.

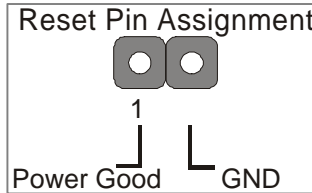

3. Speaker

Attach the 4-pin PC speaker cable from the case to the Speaker header on the Motherboard.

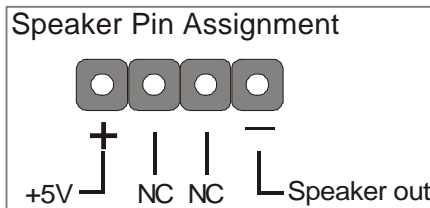

4. Turbo LED

Connecting the 2-pin Turbo LED cable to the corresponding Turbo LED header will cause the LED to light whenever the system is in Turbo mode. The manufacturer has permanently set this Motherboard in Turbo mode due to most hardware and software compliance to turbo mode.

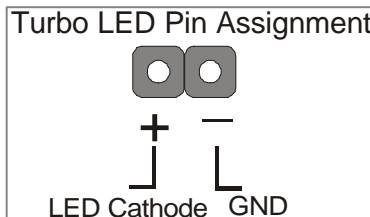

5. IDE LED

Attach the 2-pin IDE device LED cable to the corresponding IDE LED header on the Motherboard. This will cause the LED to lighten when an IDE (HDD, CD-ROM) device is active.

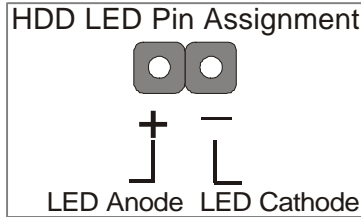

6. ATX Power On/Off Switch

Attach the 2-pin momentary type switch to the PWRBT header for turning On or Off your ATX power supply.

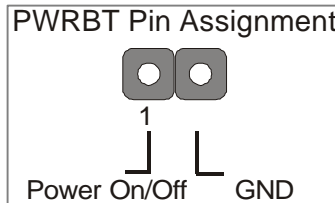

2-3.3.4 Back Panel Connections

All external devices such as the PS/2 keyboard, PS/2 mouse, printer, modem, USB can be plugged directly onto the Motherboard back panel.

Only after you have fixed and locked the Motherboard to the computer case can you start connecting the external peripheral devices.

When connecting an external device, use the following figure to locate and identify which back panel connector to plug the device to.

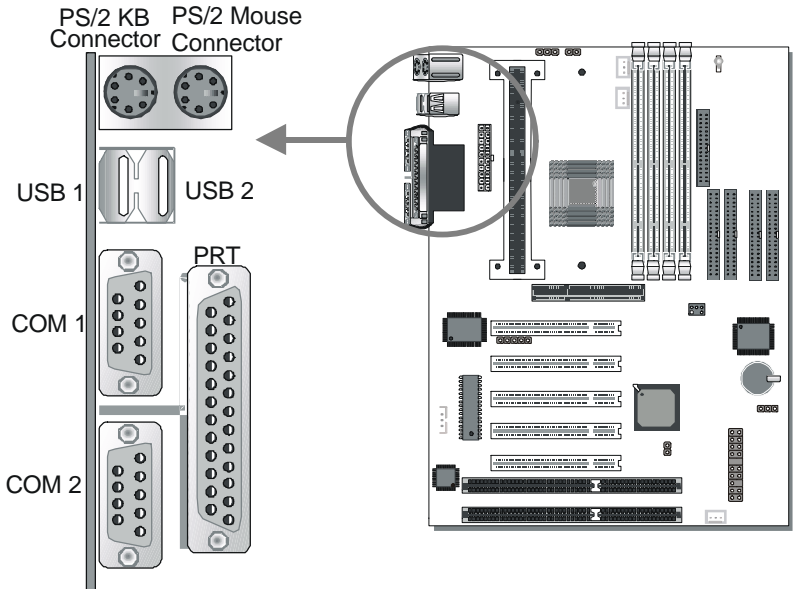

1. Onboard Serial Ports COM1/COM2

External peripherals that use serial transmission scheme include:

- serial mouse,
- and modem.

Plug the serial device cables directly into the COM1/COM2 9-pin male connectors located at the rear panel of the Motherboard.

2. Parallel Port PRT

This parallel port is used to connect the printer or other parallel devices.

Plug the parallel device cable into the 25-pin female connector located at the rear panel of the Motherboard.

3. PS/2 Keyboard

Plug the keyboard jack directly into the 6-pin female PS/2 keyboard connector located at the rear panel of the Motherboard.

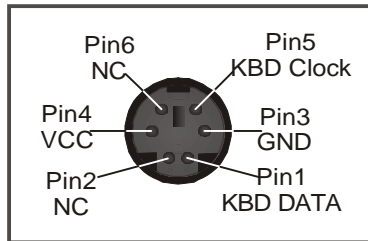

4. PS/2 Mouse

Similarly, plug the mouse jack directly into the 6-pin female PS/2 mouse connector.

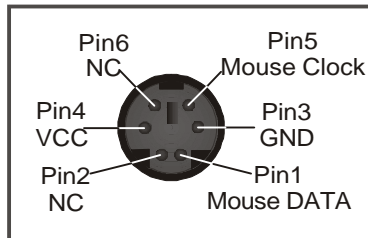

5. Universal Serial Bus USB1/USB2

This Motherboard provides two USB ports for your additional devices. Plug the USB device jack into the available USB connector USB1 or USB2.

- Standard device drivers come with the Win98 for commonly used USB devices.
- With Win95, use the flow UHCI specifications. To use USB devices under Win95, usually you have to install the device driver comes with the USB device you have purchased.

2-3.3.5 Other Connections

1. Wake-On-LAN (WOL)

Attach the 3-pin connector from the LAN card which supports the Wake-On-LAN (WOL) function to the JP44 header on the Motherboard. This WOL function lets users wake up the connected computer through the LAN card.

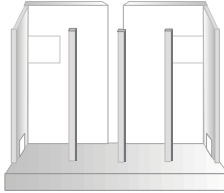

Please install according to the following pin assignment:

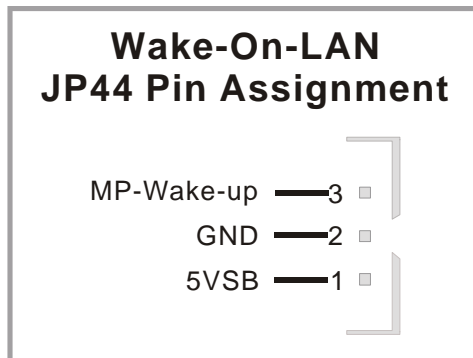

2. Infrared (IR1)

Plug the 5-pin infrared device cable to the IR1 header. This will enable the



infrared transfer function. This Motherboard meets both the ASKIR and HPSIR specifications.

Please install according to the following pin assignment:

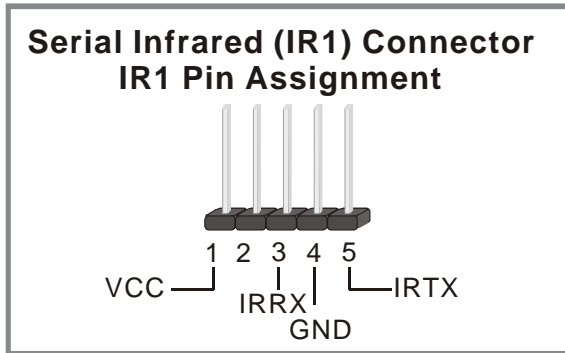

3. Other Display Cards

Insert other types of VGA cards into the PCI or ISA expansion slots according to card specifications.

4. Cooling Fan Installation

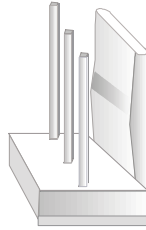

(1) CPU Cooling Fan

After you have seated the CPU properly on the processor, attach the 3-pin fan cable to the CPUFAN connector on the Motherboard. The fan will stop when the system enters into Suspend Mode. (Suspend mode can be enabled from the BIOS Setup Utility, [POWER MANAGEMENT] menu.) To avoid damage to the system, install according to the following pin assignment:

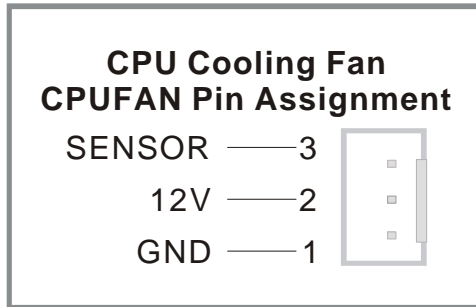

(2) Chassis Cooling Fan

Some chassis also feature a cooling fan. This Motherboard features a CHAFAN connector to provide 12V power to the chassis fan. Connect the cable from the chassis fan to the CHAFAN 3-pin connector. Install according to the following pin assignment:

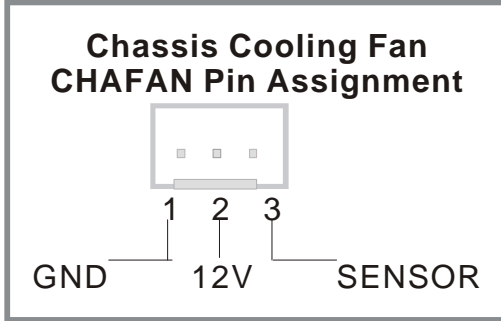

Note: CPUFAN must be installed for this Motherboard, CHAFAN is optional.

2-3.3.6 AGP VGA Card

Insert the AGP VGA card into the AGP slot. Then connect the monitor information cable to the AGP card back plane external connector. Follow the manufacturer's instructions to perform the AGP VGA drivers installation.

Other Display Cards: Insert other types of VGA cards into the PCI or ISA expansion slots according to card specifications.

2-3.3.7 PCI Audio Card

Some PCI soundcards require a PC-PCI DMA channel. Attach the 5-pin cable from your PCI audio card to the SB-LINK™ header on the Motherboard. The SB-LINK™ will forward requests for legacy DMA channel to the PCI Bus.

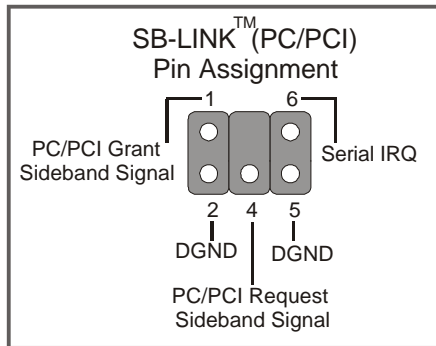

2-3.3.8 ATX Power Supply

Plug the connector from the power directly into the 20-pin male ATX PW connector on the Motherboard, as shown in the following figure.

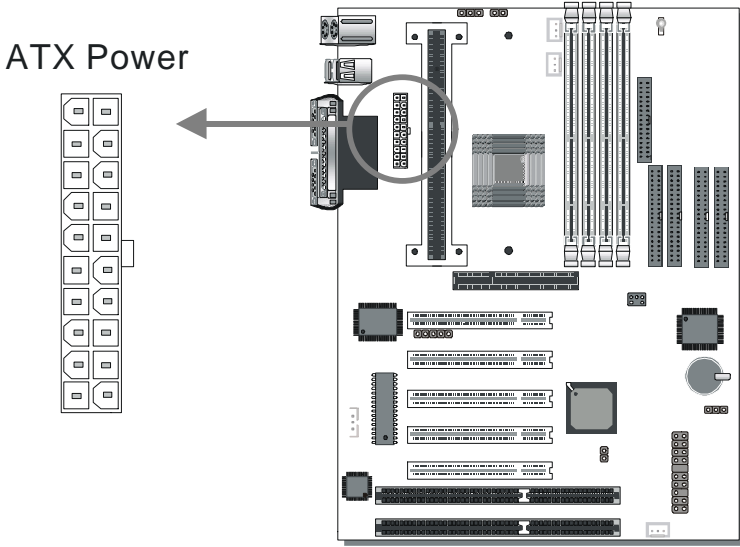

Warning: Follow these precautions to preserve your Motherboard from any remnant currents when connecting to power supply:

Turn off the power supply and unplug the power cord of the power supply before connecting to PW connector.

This motherboard requires a power supply, that meets the ATX 2.03 specifications. Make sure the power supply can support at least 720mA on the 5V Standby lead.

Please install the ATX power according to the following pin assignment:

ATX Power

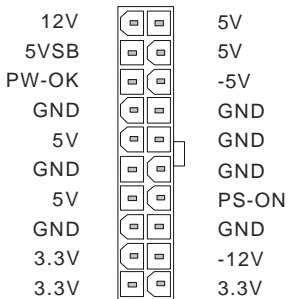

➤ **Pay special care to the directionality.**

2-3.4 Jumper Setting

Step 1. 5V Stand-by indicator LED (LED 1)

This LED is lit whenever the 5V Standby voltage coming from the ATX power supply is available. If you have connected your ATX power supply to the motherboard, LED 1 should be lit.

Step 2. External Suspend Button (JP1)

Some cases come with a suspend button, insert the plug into JP1. In addition to this button, the system can also enter the suspend mode through your OS.



Note: Suspend mode only functions if your Power Management mode is APM. Make sure that the BIOS setting for Power Management is APM. Windows 98 can be installed with ACPI Power Management (default is APM), in this case suspend mode will not function either.



Step 3. CPU multiplier release Jumper: (JP8)

Closing JP8 can make higher multiplier settings available on some INTEL CPUs. For technical details read the following:

Your Pentium CPU has an input pin B21 (100/66# signal) to tell it at what Front Side Bus (FSB) Frequency it is running; JP8 is connected to this input pin. The actual FSB Frequency is however set through the BIOS and it may therefore differ from the Frequency specified to the CPU through JP8.



Because some INTEL CPUs have their multipliers limited at a FSB Frequency of 100MHz and higher, telling the CPU that it is running at 66MHz though JP8 while setting a different (higher) FSB Frequency in the BIOS may allow the user to set a higher multiplier value. Doing so will however force your CPU to operate out of its specifications, and therefore SOYO can not guarantee the proper functioning of your system.

Refer to the following table:

Mode	JP8
66MHz FSB clock CPUs Setting	
66MHz FSB clock CPUs must use this setting	 short
100MHz FSB clock CPUs Setting	
Normal	 open
Possible higher multiplier limit	 short
<p>Note: Shorting the jumper will tell the CPU that it is running on 66MHz, this will release more multiplier settings on some INTEL CPUs, but will make the system operate out of its specifications if the actual frequency is 100 MHz or higher.</p>	

Step 4. Power-On by Keyboard Jumper (JP10)

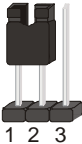
You can choose to enable the Power-On by Keyboard function by shorting pin 1-2 on jumper JP10, otherwise, short pin 2-3 to disable this function.

Power-On by Keyboard	Enable	Disable
JP10 Setting	Short pin 1-2 to enable the Power-On by Keyboard function. 	Short pin 2-3 and the Power-On by Keyboard function is disabled. 



Note: When using the Power-On by Keyboard function, please make sure the ATX power supply can take at least 720mA load on the 5V Standby lead (5VSB) to meet the standard ATX specification.

2-3.5 CMOS Clearing (JP5)

After you have turned off your computer, clear the CMOS memory by momentarily shorting pins 2-3 on jumper JP5, for a few seconds. Then restore JP5 to the initial 1-2 jumper setting in order to recover and retain the default settings.

Jumper JP5 can be easily identified by its white colored cap.

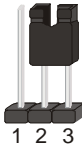
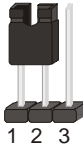
CMOS Clearing	Clear CMOS Data	Retain CMOS Data
JP5 Setting	Short pin 2-3 for <i>at least 5 seconds</i> to clear the CMOS 	Short pin 1-2 to retain new settings 
Note: You must unplug the ATX power cable from the ATX power connector when performing the CMOS Clear operation.		

2-3.6 Power On

You have now completed the hardware installation of your Motherboard successfully.

1. Turn the power on
2. To enter the BIOS Setup Utility, press the key while the system is performing the diagnostic checks,



Note: If you have failed to enter the BIOS, wait until the boot up sequence is completed. Then push the RESET button and press key again at the beginning of boot-up, during diagnostic checks.

Repeat this operation until you get the following screen.

3. The BIOS Setup screen appears:

ROM PCI/ISA BIOS CMOS SETUP UTILITY AWARD SOFTWARE, INC.	
SOYO COMBO SETUP	INTEGRATED PERIPHERALS
STANDARD CMOS SETUP	SUPERVISOR PASSWORD
BIOS FEATURES SETUP	USER PASSWORD
CHIPSET FEATURES SETUP	IDE HDD AUTO DETECTION
POWER MANAGEMENT SETUP	SAVE & EXIT SETUP
PNP/PCI CONFIGURATION	EXIT WITHOUT SAVING
LOAD SETUP DEFAULTS	
Esc : Quit	↑ ↓ → ← : Select Item
F10 : Save & Exit Setup	(Shift) F2 : Change Color
Time, Date, Hard Disk Type...	

2-3.7 Quick BIOS Setup

This Motherboard does not use any hardware jumpers to set the CPU frequency. Instead, CPU settings are software configurable with the BIOS [SOYO COMBO SETUP]. The [SOYO COMBO SETUP] menu combines the main parameters that you need to configure, all in one menu, for a quick setup in BIOS.

After the hardware installation is complete, turn the power switch on, then press the key during the system diagnostic checks to enter the Award BIOS Setup program. The CMOS SETUP UTILITY will display on screen. Follow these steps to configure the CPU settings.

SETUP UTILITY will display on screen. Then, follow these steps to configure the CPU settings.

Step 1. Select [STANDARD CMOS SETUP]

Set [Date/Time] and [Floppy drive type], then set [Hard Disk Type] to “Auto”.

Step 2. Select [LOAD SETUP DEFAULT]

Select the “LOAD SETUP DEFAULT” menu and type “Y” at the prompt to load the BIOS optimal setup.

Step 3. Select [SOYO COMBO SETUP]

Move the cursor to the [CPU Frequency] field to set the CPU frequency.

(1) CPU Name & CPU ID

The BIOS will read the CPU name string and CPU ID code From the CPU and it will display it here. This item provides information only and can not be change.

(2) CPU Frequency

Available [CPU Frequency] settings on your SY-6BA+ IV Motherboard are detailed in the following table.

CPU Frequency (MHz)		Select the working frequency of your Pentium® III, Pentium® II, Celeron™ processor among these preset values. Note: <input checked="" type="checkbox"/> Mark the checkbox that corresponds to the working frequency of your Pentium® III, Pentium® II, Celeron™ processor in case the CMOS configuration should be lost.
<input type="checkbox"/> Manual	<input type="checkbox"/> 350MHz (100 x 3.5)	
<input type="checkbox"/> 266MHz (66 x 4)	<input type="checkbox"/> 400MHz (100 x 4)	
<input type="checkbox"/> 300MHz (66 x 4.5)	<input type="checkbox"/> 450MHz (100 x 4.5)	
<input type="checkbox"/> 333MHz (66 x 5)	<input type="checkbox"/> 500MHz (100 x 5)	
<input type="checkbox"/> 366MHz (66 x 5.5)	<input type="checkbox"/> 550MHz (100 x 5.5)	
<input type="checkbox"/> 400MHz (66 x 6)	<input type="checkbox"/> 600MHz (100 x 6)	
<input type="checkbox"/> 433MHz (66 x 6.5)	<input type="checkbox"/> 650MHz (100 x 6.5)	
<input type="checkbox"/> 466MHz (66 x 7)	<input type="checkbox"/> 700MHz (100 x 7)	
<input type="checkbox"/> 500MHz (66 x 7.5)	<input type="checkbox"/>	

If you set this field to [Manual], you are then required to fill in the next two consecutive fields: (a) the CPU Host/PCI Clock, and (b) the CPU Ratio.

(a) CPU Host/PCI Clock

CPU Host / PCI Clock					Under this item you find the frequencies your PCI and AGP slots run at. These frequencies are derived from the CPU host clock in the following way: CPU host clock > 100MHz PCI = CPU host clock /3, CPU host clock < 100MHz PCI = CPU host clock /2,
<input type="checkbox"/> 66/33	<input type="checkbox"/> 95/31	<input type="checkbox"/> 115/38	<input type="checkbox"/> 124/41	<input type="checkbox"/> 140/35	
<input type="checkbox"/> 75/37	<input type="checkbox"/> 100/33	<input type="checkbox"/> 117/39	<input type="checkbox"/> 126/31	<input type="checkbox"/> 142/35	
<input type="checkbox"/> 78/39	<input type="checkbox"/> 105/35	<input type="checkbox"/> 118/39	<input type="checkbox"/> 133/33	<input type="checkbox"/> 144/36	
<input type="checkbox"/> 81/40	<input type="checkbox"/> 110/36	<input type="checkbox"/> 120/40	<input type="checkbox"/> 135/33	<input type="checkbox"/> 150/37	
<input type="checkbox"/> 83/40	<input type="checkbox"/> 112/37	<input type="checkbox"/> 122/37	<input type="checkbox"/> 137/34	<input type="checkbox"/> 155/38	
<input type="checkbox"/> 90/30	<input type="checkbox"/> 113/37	<input type="checkbox"/> 124/31	<input type="checkbox"/> 138/34		

(b) CPU Ratio

After you have selected the CPU Host/ PCI Clock, choose the right multiplier for the CPU. CPU Ratio options are:

<input type="checkbox"/> x 2	<input type="checkbox"/> x 2.5	<input type="checkbox"/> x 3	<input type="checkbox"/> x 3.5	<input type="checkbox"/> x 4
<input type="checkbox"/> x 4.5	<input type="checkbox"/> x 5	<input type="checkbox"/> x 5.5	<input type="checkbox"/> x 6	<input type="checkbox"/> x 6.5
<input type="checkbox"/> x 7	<input type="checkbox"/> x 7.5	<input type="checkbox"/> x 8		

The CPU frequency is then defined as [host clock freq.] x [multiplier], and should be the working frequency of your CPUs processor.

(c) AGP Clock

This option allows you to manually adjust the AGP host bus clock frequency to a value determined as a fraction of the CPU host clock.

For example:

With a CPU front side bus of 100MHz,

[Auto] sets → When [auto] is selected and the (FSB Frequency) is less than 100MHz, it will be divided by [/ 1]. Otherwise it will be divided by [/ 1.5].

[/ 1] sets → AGP Clock = 100MHz

[/ 1.5] sets → AGP Clock = 66.6MHz

AGP Clock options are:

<input type="checkbox"/> Auto	<input type="checkbox"/> ÷1.0	<input type="checkbox"/> ÷1.5
-------------------------------	-------------------------------	-------------------------------

(d) Vcore Voltage Adjust

The CPU notifies the board of what core voltage it requires by its VID outputs. The on-board voltage regulator uses the VID code to set the core voltage. If the **Vcore Voltage Adjust** is set to normal, the Vcore will be exactly what the VID code specifies. If an adjustment percentage is selected the Vcore will be that percentage higher than the VID code specifies. For instance the CPU VID code specifies 2.0V and the Vcore Voltage adjust is set to +10.0% the actual CPU Voltage will be 2.2V. This function should only be used if the CPU is running on FSB Frequencies beyond the CPU specifications, note that SOYO does not guarantee system stability if this item is not set to normal.

Don't forget to raise the upper limit of the CPU Vcore monitoring voltage in the Hardware Doctor™ utility if Vcore is set to higher voltage than VID specifies.

<input type="checkbox"/> Normal	<input type="checkbox"/> + 2.5 %	<input type="checkbox"/> + 5.0 %	<input type="checkbox"/> + 7.5%	<input type="checkbox"/> +10.0 %
---------------------------------	----------------------------------	----------------------------------	---------------------------------	----------------------------------

Step 4. Select [SAVE & EXIT SETUP]

Press <Enter> to save the new configuration to the CMOS memory, and continue the boot sequence.

2-3.8 Troubleshooting at First Start

- **What should I do if the Motherboard refuses to start?**
 1. Check that all DIMM memory modules are inserted completely. Sometimes a DIMM that is not inserted properly can cause boot problems.
 2. Check whether all Add-on cards have been inserted properly. Re-insert the Add-on cards to make sure that they make proper contact with the slots. Try removing all Add-on cards one by one to see whether or not one of them is causing problems. (Switch the system off before removing any of the cards.)
 3. Verify that speed settings are not exceeding specifications. This applies to the PCI bus, that is specified to run at 33 MHz. Also check the speed setting for the memory, make sure conservative setting is used. If the CPU is overclocked the system may not start up, read the section below.
 4. Make sure that the Harddisk IDE cables are attached properly, if not the system will not boot. In case of doubt try reversing the IDE connector on one end of the cable.
 5. Verify that the 110/220V switch on the back of the power supply is set correctly.
 6. Go through the jumper setting section again to make sure that all jumpers are set correctly.



Note on Over-clocking Capability

The SY-6BA+ IV provides over-clocking capability. Due to the over-clocking setting your system may fail to boot up or hang during run time. Please perform the following steps to recover your system from the abnormal situation :

1. Turn off system power (If you use an ATX power supply, and depending on your system, you may have to press the power button for more than 4 seconds to shut down the system.)
-

2. Set the JP8 and JP9 to short if you use a FSB 66MHz CPU
3. Press and hold down the <Insert> key while turning on the system power. Keep holding down the <Insert> key until you see the message of the CPU type and frequency shown on the screen.
4. Press the key during the system diagnostic checks to enter the Award BIOS Setup program.
5. Select [SOYO COMBO SETUP] and move the cursor to the [CPU Frequency] field to set the proper working frequency.
6. Select [Save & Exit SETUP] and press <Enter> to save the new configuration to the CMOS memory, and continue the boot sequence.

Note: SOYO does not guarantee system stability if the user over clocks the system. Any malfunctions due to over-clocking are not covered by the warranty.

2-3.9 Power Off

There are two possible ways to turn off the system:

1. Use the **Shutdown** command in the **Start Menu** of Windows 95/98 to turn off your computer.
2. Press the mechanical power-button and **hold down for over 4 seconds**, to shutdown the computer. If you press the power-button for less than 4 seconds, then your system will enter into **Suspend Mode**.

You are now ready to configure your system with the BIOS setup program. Go to *Chapter 3: BIOS SETUP*

Chapter 3

BIOS SETUP UTILITY

This Motherboard's BIOS setup program uses the ROM PCI/ISA BIOS program from Award Software Inc.

To enter the Award BIOS program's Main Menu:

1. Turn on or reboot the system.
2. After the diagnostic checks, press the [Del] key to enter the Award BIOS Setup Utility.

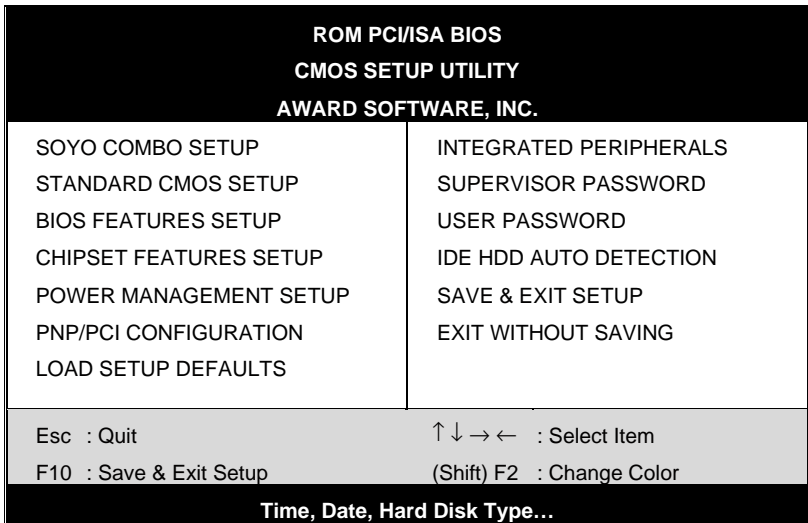

Selecting items

- Use the arrow keys to move between items and select fields.
- From the Main Menu press arrow keys to enter the selected submenu.

Modifying selected items

- Use the [Up]/[Down] keys to modify values within the selected fields. Some fields let you enter values directly.

Hot Keys: Function keys give you access to a group of commands throughout the BIOS utility.

Function	Command	Description
F1	Help	Gives the list of options available for each item.
Shift F2	Color	Change the color of the display window.
F5	Old values	Restore the old values. These are the values that the user started the current session with.
F6	Load BIOS Defaults	Loads all options with the BIOS Setup default values.
F7	Load Setup Defaults	Loads all options with the Power-On default values.
F10	Save & Exit Setup	Saves your changes and reboots the system.
[Esc]	Quit	Lets you return at anytime and from any location to the Main Menu.

SAVE AND EXIT SETUP

Select the [SAVE & EXIT SETUP] option from the Main Menu to save data to CMOS and exit the setup utility. This option saves all your changes and causes the system to reboot.

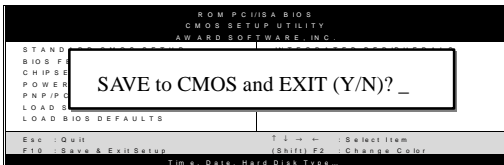

Type [Y] to save the changes and exit or [N] to return to the Main Menu and keep current values.

EXIT WITHOUT SAVING

Selecting the [EXIT WITHOUT SAVING] option allows you to abandon all data and exit setup, therefore ignoring all your changes.

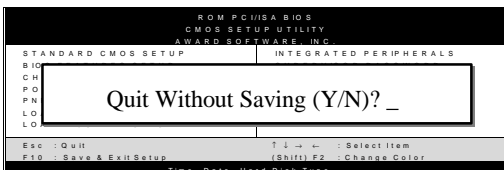

Type [Y] to abandon changes and exit or [N] to return to the Main Menu and keep current values.

3-1 SOYO COMBO SETUP

This Motherboard does not use any hardware jumpers to set the CPU frequency. Instead, CPU settings are software configurable with the BIOS [SOYO COMBO SETUP].

After the hardware installation is complete, turn the power switch on, then press the key during the system diagnostic checks to enter the Award BIOS Setup program. The CMOS SETUP UTILITY will display on screen. Then, select the [SOYO COMBO SETUP] option from the main menu and press the <Enter> key.

ROM PCI/ISA BIOS			
SOYO COMBO SETUP			
AWARD SOFTWARE, INC.			
CPU Name	: Pentium II,	CPU ID	: 0665
CPU Frequency (MHz)	: Manual		
CPU Host/PCI Clock	: 100/33 MHz		
CPU Ratio	: X 3.5 = 350MHz		
AGP Clock	: = 66MHz		
Vcore Voltage Adjust	: Normal		
Boot Sequence	: A,C,SCSI		
Processor Number Feature	: Enabled		
CPU L2 Cache ECC Checking	: Enabled		
CPU L2 Latency Adjust	: Def 02		
C.I.H. 4-WAY Protection	: Enabled		
Quick Power On Self Test	: Enabled		
POWER ON Function	: BUTTYON ONLY		
Soft - Off by PWR-BTTN	: Instant-Off		
Power-On by Ring/LAN	: Enabled		
Resume by Alarm	: Disabled		
CPU Warning Temperature	: Disabled		
Current System Temp.	: 26 ½ C / 78 ½ F		
Current CPU Dio Temp.	: 28 ½ C / 82 ½ F		
Current CPUFAN Speed	: 5433 RPM		
Current PWRFAN Speed	: 0 RPM		
Current CHAFAN Speed	: 0 RPM		
Vcore	: 1.98 V	VTT (V)	: 1.50 V
3.3 (V)	: 3.55 V	+ 5 (V)	: 4.94 V
+12 (V)	: 11.97 V	-12 (V)	: -12.04 V
- 5 (V)	: -0.02 V	VBAT(V)	: 3.07 V
5VSB(V)	: 5.02 V		
CPUFAN Off In Suspend	: Enabled		
RTC Y2K H/W Roll over	: Disabled		
ESC	: Quit	↑ ↓ → ←	: Select Item:
F1	: Help	PU / PD / + / -	: Modify
F5	: Old Values	(Shift) F2	: Color
F7	: Load Setup Defaults		

The [SOYO COMBO SETUP] menu combines the main parameters that you need to configure, all in one menu, for a quick setup in BIOS.

3-1.1 Quick CPU Frequency Setup

Quick CPU Frequency Setup	Setting	Description	Note
CPU Name & CPU ID	The BIOS will read the CPU name string and CPU ID code from the CPU and it will display it here. This item provides information only and can not be change.		
CPU Frequency	Manual	Select the working frequency of your Slot 1 processor among these preset values.	
	266MHz (66 x 4)	Note: Setting this field to [Manual] requires you to fill in the next two consecutive fields: (1) the CPU Host/PCI Clock, and (2) the CPU Ratio.	
	300MHz (66 x 4.5)		
	333MHz (66 x 5)		
	366MHz (66 x 5.5)		
	400MHz (66 x 6)		
	433MHz (66 x 6.5)		
	466MHz (66 x 7)		
	500MHz (66 x 7.5)		
	350MHz (100 x 3.5)		
	400MHz (100 x 4)		
	450MHz (100 x 4.5)		
	500MHz (100 x 5)		
	550MHz (100 x 5.5)		
	600MHz (100 x 6)		
650MHz (100 x 6.5)			
700MHz (100 x 7)			
If [CPU Frequency] field is set to [Manual]			
CPU Host/PCI Clock	66/33 MHz	120/40 MHz	Select the host clock of your Slot 1 processor among these values. Note: For the ZX chipset, 66 and 100 MHz host clock frequencies are acceptable. However, the system stability is not guaranteed for other frequencies due to the limitations of this chipset.
	75/37 MHz	122/37 MHz	
	78/39 MHz	124/31 MHz	
	81/40 MHz	124/41 MHz	
	83/40 MHz	126/31 MHz	
	90/30 MHz	133/33 MHz	
	95/31 MHz	135/33 MHz	
	100/33 MHz	137/34 MHz	
	105/35 MHz	138/34 MHz	
	110/36 MHz	140/35 MHz	
	112/37 MHz	142/35 MHz	
	113/37 MHz	144/36 MHz	
	115/38 MHz	150/37 MHz	
117/39 MHz	155/38 MHz		
118/39 MHz			

Quick CPU Frequency Setup (Continued)

Quick CPU Frequency Setup	Setting	Description	Note
If [CPU Frequency] field is set to [Manual]			
CPU Ratio		After you have selected the host clock, choose the right multiplier for the CPU. Options are: [2, 2.5, 3., 3.5, 4, 4.5, 5, 5.5,6,6.5,7,0,7.5,8,0]. The CPU frequency is then defined as [host clock freq.]x[multiplier], and should the working frequency of your Pentium®III, Pentium®II & Celeron™ processor.	
	AGP Clock	Auto	Default
	/ 1	This option allows you to manually adjust the AGP host bus clock frequency to a value determined as a fraction of the CPU host clock. For example: With a CPU front side bus of 66MHz, [/ 1] sets → AGP Clock = 66MHz [/ 1.5] sets → AGP Clock = 44MHz	
	/ 1.5		
Vcore voltage Adjust	Normal		Default
	+2.5 %	The CPU notifies the board of what core voltage it requires by its VID outputs. The on-board voltage regulator uses the VID code to set the core voltage. If the Vcore Voltage adjust is set to normal, the Vcore will be exactly what the VID code specifies. If an adjustment percentage is selected the Vcore will be that percentage higher than the VID code specifies. If for instance the VID code specifies 2.0V and the Vcore Voltage Adjust is set to +10.0% the actual CPU voltage will be 2.2V. This function should only be used if the CPU is running on FSB Frequencies beyond the Cpu specifications.	
	+5.0%		
	+7.5 %		
	+10.0%		

3-1.2 System Boot Control Settings

System Boot Control Settings	Setting	Description	Note
Boot Sequence	A, C, SCSI	Choose the boot sequence adapted to your needs, for example: <ul style="list-style-type: none"> ● [A, C, SCSI] means the BIOS will look for an operating system first in drive A, then in drive C, and eventually in SCSI device. 	
	C, A, SCSI		
	C, CD-ROM, A		
	CD-ROM, C, A		
	D, A, SCSI		
	E, A, SCSI		
	F, A, SCSI		
	SCSI, A, C		
	SCSI, C, A		
	C only		
LS/ZIP, C			

3-1.3 Processor Number Feature Setting

Processor Number Feature	Setting	Description	Note
Processor Number Feature	Disabled	Setting this item to enabled will allow application programs to read the ID-code in your Pentium III CPU, disabling this item will not allow any program to read the CPU ID code.	Default
	Enabled		

3-1.4 L2 Cache Memory

	Setting	Description	Note
CPU L2 Cache ECC Checking	Disabled	This option activates the CPU L2 cache ECC checking function.	Default
	Enabled		
CPU L2 Cache Latency Adjust	Def 02	This item allows the user to adjust the CPU L2 cache latency. This item should only be used by experienced users. Setting it to an inappropriate value can crash the system.	Default
	Set 01~15		

3-1.5 C.I.H. 4-WAY Protection Setting

	Setting	Description	Note
C.I.H. 4-WAY Protection	Disabled	When set to enabled, the BIOS can only be programmed through AWDFLASH, making sure that any virus is unable to program the system BIOS. Set to disable the BIOS can be programmed the traditional way.	
	Enabled		Default

3-1.6 Quick Power On Self Test Setting

	Setting	Description	Note
Quick Power On Self Test	Disabled		
	Enabled	Provides a fast POTS at boot-up.	Default

3-1.7 Power Management

PM Events	Setting	Description	Note
POWER ON Function	BUTTON-ONLY	Disables the Wake-Up by Keyboard function.	Default
	KB Power ON Password	Enables you to wake-up the system by entering a password at the keyboard.	
	Hot Key	You can wake-up the system by pressing the key combination of your choice (Ctrl-F1~F12).	
If [POWER ON Function] is set to [KB Power ON Password]			
KB Power ON Password	Enter (your password)	Set the password that will wake-up your system.	
If [POWER ON Function] is set to [Hot Key]			
KB Power ON Password	Ctrl-F1~F12	Choose the key combination that will wake-up the system. [Ctrl-F1 to Ctrl-F12]	
Soft-Off by PWR-BTTN	Instant-off		Default
	Delay 4 Sec.	Turns off the system power 4 seconds after pushing the power button.	

Power Management (Continued)

PM Events	Setting	Description	Note
Power-On by Ring/LAN	Disabled		Default
	Enabled	The system will self-power on me when the modem is ringing.	
Resume by Alarm	Disabled	The system ignores the alarm.	Default
	Enabled	Set alarm to power on the system by the date (1-31) or time (hh:mm:ss). If the date is set to [0], the system will self-power on by alarm everyday at the set time.	

3-1.8 CPU Device Monitoring

CPU Device Monitoring	Setting	Description	Note
CPU Warning Temperature	Disabled		Default
	Enabled	Set CPU temperature from 50°C to 70°C. The CPU will slow down when CPU temperature goes beyond the preset value. The CPU will continue to run slow until the temperature returns back within the safe range.	

CPU Device Monitoring (Continued)

CPU Device Monitoring	Setting	Description	Note
Current System Temp.	°C/°F	Show the current status of the system temperature.	
Current CPU Temperature	°C/°F	Show the current status of CPU temperature.	
Current CPUFAN Speed	°C/°F	Show the current status of CPU Fan	
Current PWRFAN Speed	°C/°F	Show the current status of the Power Fan	
Current CHAFAN Speed	°C/°F	Show the current status of the chassis Fan	
Vcore, VTT, 3.3V, +12V, -5V, +5V, -12V, VBAT, 5VSB	V	Show the current voltage status.	
CPUFAN Off In Suspend	Disabled	Disables the PM timer.	
	Enabled	Switches off the CPU Fan when the system enters Suspend Mode.	Default
RTC Y2K H/W Roll over	Disabled		Default
	Enabled	Setting this item to enabled will help the system pass some Y2K test programs. The system performance is influenced by enabling this item, set it to disabled if not necessary.	

3-2 STANDARD CMOS SETUP

Select the [STANDARD CMOS SETUP] option from the Main Menu and press [Enter] key.

ROM PCI/ISA BIOS							
STANDARD CMOS SETUP							
AWARD SOFTWARE, INC.							
Date (mm:dd:yy)		: Fri, July 31 1998					
Time (hh:mm:ss)		: 11 : 30 : 33					
HARD DISKS	TYPE	SIZE	CYLS	HEAD	PRECOMP	LANDZ	SECTOR MODE
Primary Master	: AUTO	0	0	0	0	0	0 AUTO
Primary Slave	: None	0	0	0	0	0	0 ----
Secondary Master	: None	0	0	0	0	0	0 ----
Secondary Slave	: None	0	0	0	0	0	0 ----
Drive A : 1.44M, 3.5 in.				Base Memory: 640K			
Drive B : None				Extended Memory: 3328K			
Floppy 3 Mode Support : Disabled				Other Memory: 128K			
Video : EGA/VGA				Total Memory: 4096K			
Halt On : All Errors							
Esc	: Quit	↑ ↓ → ←			: Select Item	PU/PD/+/-	: Modify
F1	: Help	(Shift) F2	: Change Color			F3	: Toggle Calendar

This screen allows you to modify the basic CMOS settings.

After you have completed the changes, press [Esc] key to return to the Main Menu.

3-2.1 Date & Time

	Display	Setting	Please Note
Date	mm/dd/yyyy	Type the current date	You can also the PUp/PDn keys to toggle
Time	hh:mm:ss	Type the current time	24-hour clock format 3:15 PM is displayed as 15:15:00

3-2.2 Hard Disks Type & Mode

Choose the type and mode for the hard disks that you have already installed.

Primary (Secondary) Master & Slave	Setting	Description	Note
Type	Auto	BIOS detects hard disk type automatically.	Default
	User	User defines the type of hard disk.	
	None		
Mode	Auto	BIOS detects hard disk mode automatically.	Default
	Normal	Normal IDE hard disk	<528MB
	LBA	Enhanced IDE hard disk	>528MB
	Large	Large IDE hard disk (for certain hard disk)	



Note: If you have any questions on your hard disk type or mode, ask your hard disk provider or previous user for details.

3-2.3 Floppy Drives

Floppy Drives	Setting	Description	Note
Drives A & B	360KB, 5.25 in.		
	1.2MB, 5.25 in.		
	720KB, 3.5 in.		
	1.44MB, 3.5 in.		Default
	2.88MB, 3.5 in.		
	None	Not installed	
Floppy 3-Mode Support	Disabled		Default
	Drive A Drive B Both	Supports 3-mode floppy diskette: 740KB/1.2MB/ 1.44MB on selected disk drive.	Special disk drive commonly used in Japan

3-2.4 Video

Select the video mode: EGA/VGA (Default), CGA 40, CGA 80, Mono (Monochrome).

3-2.5 Halt On

When the BIOS detects system errors, this function will stop the system.

Select which type of error will cause the system halt: All Errors (Default), No Errors, All But Diskette, All But Keyboard, All But Disk/Key.

3-3 BIOS FEATURES SETUP

Select the [BIOS FEATURES SETUP] option from the Main Menu and press [Enter] key.

ROM PCI/ISA BIOS			
BIOS FEATURES SETUP			
AWARD SOFTWARE, INC.			
Anti - Virus Protection	: Disabled	Assign IRQ For VGA	: Enabled
CPU Internal Cache	: Enabled	HDD S.M.A.R.T. capability	: Disabled
External Cache	: Enabled	Video BIOS Shadow	: Enabled
Swap Floppy Drive	: Disabled	C8000-CBFFF Shadow	: Disabled
Report No FDD For WIN 95	: Yes	CC000-CFFF Shadow	: Disabled
Boot Up NumLock Status	: On	D000-D3FFF Shadow	: Disabled
Security Option	: Setup	D4000-D7FFF Shadow	: Disabled
PCI/VGA Palette Snoop	: Disabled	D8000-DBFFF Shadow	: Disabled
OS Select For DRAM > 64 MB	: Non-OS2	DC000-DFFFF Shadow	: Disabled
Typematic Rate Setting	: Disabled		
Typematic Rate (Chars/Sec)	: 6		
Typematic Delay (Msec)	: 250		
		ESC	: Quit
		-	: Select Item
		F1	: Help
		PU/PD/+/-	: Modify
		F5	: Old Values
		(Shift) F2	: Color
		F7	: Load Setup Defaults

After you have completed the changes, press [Esc] key and follow the instructions on your screen to save your settings or exit without saving.

3-3.1 Virus Warning

	Setting	Description	Note
Anti - Virus Protection	Disabled		Default
	Enabled	If set to enabled, the Paragon Anti-Virus. Function will scan your boot drive for boot viruses. If a boot virus is detected, the BIOS will display a warning message.	

3-3.2 Cache Memory Options

	Setting	Description	Note
CPU Internal Cache	Disabled		
	Enabled	Enables the CPU's internal cache.	Default
External Cache	Disabled		
	Enabled	Enables the external memory.	Default

3-3.3 Floppy Driver Settings

Floppy Driver Settings	Setting	Description	Note
Swap Floppy Drive	Disabled		Default
	Enabled	Changes the sequence of A and B drives.	
Report No FDD For WIN 95	Yes	Windows will release IRQ line 6 (normally used by the Floppy Disk Drive) after you disable your on-board FDD and set this field to [Yes].	
	No	Windows will reserve INT 6 for your FDD, whether it is disabled or not.	

3-3.4 Other Control Options

Other Control Options	Setting	Description	Note
Boot Up NumLock Status	On	Puts numeric keypad in NumLock mode at boot-up.	Default
	Off	Puts numeric keypad in arrow key mode at boot-up.	

3-3.5 Security Option

Use this feature to prevent unauthorized system boot-up or use of BIOS Setup. The following table describes the security settings.

Security Option	Setting	Description
	System	Each time the system is booted, the password prompt appears.
	Setup	If a password is set, the password prompt only appears when you attempt to enter the BIOS Setup program.

3-3.6 Other Control Options

Other Control Options	Setting	Description	Note
PCI/VGA Palette Snoop	Disabled		Default
	Enabled	The color of the monitor may be altered when using an MPEG card. Enable this option to restore the monitor's normal color.	
OS Select for DRAM>64MB	OS2	When using an OS2 operating system.	
	Non-OS2	When using another, non-OS2 operating system.	Default

3-3.7 Typematic Settings

Typematic Settings	Setting	Description	Note
Typematic Rate Setting	Disabled		Default
	Enabled	Enables to adjust the keystroke repeat rate.	
The following [Typematic Rate] and [Typematic Delay] fields are active only if [Typematic Rate Setting] is set to [Enabled]			
Typematic Rate	6 (Char/sec)	Choose the rate at which a character is repeated when holding down a key.	Default
	8 (Char/sec)		
	10 (Char/sec)		
	12 (Char/sec)		
	15 (Char/sec)		
	20 (Char/sec)		
	24 (Char/sec)		
30 (Char/sec)			
Typematic Delay	250 (msec)	Choose how long after you press a key down the character begins repeating.	Default
	500 (msec)		
	750 (msec)		
	1000 (msec)		

3-3.8 Other Control Options

Other Control Options	Setting	Description	Note
Assign IRQ For VGA	Disabled		
	Enabled	Use this default setting.	Default
HDD S.M.A.R.T. capability	Disabled		
	Enabled	Enable this field when your HDD supports the S.M.A.R.T. function. Consult your HDD provider for details.	

Other Control Options

Other Control Options	Setting	Description	Note
Video or Adapter BIOS Shadow	Disabled		
	Enabled	The BIOS is shadowed in a 16K segment if it is enabled and if it has BIOS present. These 16 segments can be shadowed from ROM to RAM. BIOS shadow copies BIOS code from slower ROM to faster RAM. BIOS can then execute from RAM.	Default

3-4 CHIPSET FEATURES SETUP



Caution: Change these settings only if you are already familiar with the Chipset.

The [CHIPSET FEATURES SETUP] option changes the values of the chipset registers. These registers control the system options in the computer.

ROM PCI/ISA BIOS CMOS SETUP UTILITY CHIPSET FEATURES SETUP			
Auto Configuration	: Enabled	Passive Release	: Enabled
SDRAM RAS-to CAS Delay	: 3	Delayed Transaction	: Disabled
SDRAM RAS Precharge Time	: 3		
SDRAM CAS latency Time	: 3	AGP Aperture Size	: 64
SDRAM Precharge Control	: Disabled		
DRAM Data Integrity Mode	: Non-ECC		
System BIOS Cacheable	: Disabled		
Video BIOS Cacheable	: Disabled		
Video RAM Cacheable	: Disabled		
8 Bit I/O Recovery Time	: 1		
16 Bit I/O Recovery Time	: 1		
Memory Hole At 15M -16M	: Disabled		
		ESC : Quit	- ~ @ ~ : Select Item
		F1 : Help	PU/PD/+/- : Modify
		F5 : Old Values	(Shift) F2 : Color
		F7 : Load Setup Defaults	

After you have completed the changes, press [Esc] and follow the instructions on your screen to save your settings or exit without saving. The following table describes each field in the CHIPSET FEATURES SETUP Menu and how to configure each parameter.

CHIPSET FEATURES SETUP

CHIPSET FEATURES	Setting	Description	Note
Auto Configuration	Disabled		
	Enabled	It is strongly recommended to enable this option so that the system automatically sets all chipset feature options on the left panel of the screen (except for cache update & BIOS cacheable).	Default
SDRAM RAS-to-CAS Delay	3	Use the default setting	Default
	2		
SDRAM RAS Precharge Time	3	Use the default setting	Default
	2		
SDRAM Cache Latency Time	3	Use the default setting	Default
SDRAM Precharge Control	Disabled	Use the default setting	Default
	Enabled		
DRAM Data Integrity Mode	Non-ECC	Choose according to the DRAM type you have.	Default
	ECC		
System BIOS Cacheable	Disabled	The ROM area F0000H-FFFFFH is cacheable.	Default
	Enabled		
Video BIOS Cacheable	Disabled	The video BIOS C0000H-C7FFFH is cacheable.	Default
	Enabled		
Video RAM Cacheable	Disabled	The ROM area A0000-BFFFF is cacheable.	Default
	Enabled		
8 BIT I/O Recovery Time	1	Use the default setting	Default

CHIPSET FEATURES SETUP (Continued)

CHIPSET FEATURES	Setting	Description	Note
16 BIT I/O Recovery Time	1	Use the default setting	Default
Memory Hole At 15M-16M	Disabled		Default
	Enabled	Some interface cards will map their ROM address to this area. If this occurs, select [Enabled] in this field.	
Passive Release	Enabled	Use the default setting	Default
Delayed Transaction	Enabled	Use the default setting	Default
AGP Aperture Size	64	AGP could use the DRAM as its video RAM. Choose the DRAM size that you wish to allocate as video RAM.	Default
	4-256MB		
Spread Spectrum Modulated	Disabled		Default
	Enabled	When using Spread Spectrum Modulated 1.5% or 6% for FCC or DOC testing.	

3-5 POWER MANAGEMENT SETUP

The [POWER MANAGEMENT SETUP] sets the system's power saving functions.

ROM PCI/ISA BIOS POWER MANAGEMENT SETUP AWARD SOFTWARE, INC.			
ACPI function	: Enabled	** Reload Global Timer Events	**
PM Control by APM	: Yes		
Video Off Method	: V/H SYNC+Blank	IRQ [3-7, 9-15], NMI	: Disabled
Video Off After	: Standby	Primary IDE 0	: Disabled
MODEM Use IRQ	: 3	Primary IDE1	: Disabled
		Secondary IDE 0	: Disabled
Power Management	: User Define	Secondary IDE1	: Disabled
Doze Mode	: Disable	Floppy Disk	: Disabled
Standby Mode	: Disable	Serial Port	: Enabled
Suspend Mode	: Disable	Parallel Port	: Disabled
HDD Power Down	: Disabled		
PCI/VGA Act-Monitor	: Disabled		
IRQ 8 Break Suspend	: Disabled		
		ESC	: Quit ↑ ↓ → ← : Select Item
		F1	: Help PU/PD/+/- : Modify
		F5	: Old Values (Shift) F2 : Color
		F7	: Load Setup Defaults

After you have completed the Power Management Setup, press [Esc] to return to the Main Menu.

3-5.1 Power Management Controls

Power Management Controls	Setting	Description	Note
ACPI function	Disabled		Default
	Enabled	ACPI (Advanced Configuration Power Management Interface)	
PM Control by APM	Yes	To use Advanced Power Management (APM) you must run [power.exe] under DOS V6.0 or later version.	Default
	No		
Video Off Method	V/H Sync+Blank	Selects the method by which the monitor is blanked.	Default
	Blank screen		
	DPMS Supported		
Video Off After	Standby	Choose the PM mode you want video to go off after the mode is being active.	
	Suspend		
	Doze		
MODEM Use IRQ	3	Assigns an IRQ# to the modem device.	Default
	3-11, NA		

3-5.2 PM Timers

PM Timers	Setting	Description			Note
Power Management	User Define	Lets you define the HDD and system power down times.			Default
	Disable	Disables the Green PC Features.			
		Doze timer	Standby timer	Suspend timer	HDD power down
	Min Saving	1 Hour	1 Hour	1 Hour	15 Min
	Max Saving	1 Min	1 Min	1 Min	1 Min
The following [Doze Mode] field may be configured only if [Power Management] is set to [User Define]					
Doze Mode	Disable				Default
	1Min-1Hour	When the set time has elapsed, BIOS sends a command to the system to enter Doze Mode.			System clock drops to 33MHz.
The following [Standby Mode] field may be configured only if [Power Management] is set to [User Define]					
Standby Mode	Disable				Default
	1Min-1Hour	When the set time has elapsed, BIOS sends a command to the system to enter Standby Mode.			
The following [Suspend Mode] field may be configured only if [Power Management] is set to [User Define]					
Suspend Mode	Disable				Default
	1Min-1Hour	In Suspend mode, the CPU stops completely (no instructions are executed.)			Only an SL-Enhanced (or SMI) CPU can enter this mode.
HDD Power Down	Disabled				Default
	1-15Min	When the set time has elapsed, BIOS sends a command to the HDD to power down. This turns off the HDD motor.			Some older model HDDs may not support this advanced function.

3-5.3 PM Events

PM Events	Setting	Description	Note
VGA Active Monitor	Disabled		
	Enabled	Enables the power management timers when a [no activity] event is detected.	Default
IRQ 8 Break Suspend	Disabled		Default
	Enabled	Alarm function is active.	

3-5.4 Reload Global Timer Events

Power Down & Resume Events	Setting	Description	Note
IRQ [3-7,9-15], NMI	Disabled		
	Enabled	The system monitors these elements for activity. The system will resume if [IRQ activity] is detected.	Default
IDE0, IDE1 ➤ Primary ➤ Secondary	Disabled		Default
	Enabled	Enables the PM timers when [No Activity Event] is detected.	
Floppy Disk Serial Port Parallel Port	Disabled		Default
	Enabled	Enables the PM timers when [No Activity Event] is detected.	

3-6 PNP/PCI CONFIGURATION SETUP

This option sets the Motherboard's PCI Slots.

ROM PCI/ISA BIOS			
PNP/PCI CONFIGURATION			
AWARD SOFTWARE, INC.			
Resources Controlled By	:	Manual	Slot 1,5 /AGP Use IRQ : Auto
Reset Configuration Data	:	Disabled	Slot 2 Use IRQ : Auto
			Slot 3 Use IRQ : Auto
			Slot 4/USB Use IRQ : Auto
IRQ - 3 assigned to	:	Legacy ISA	Used MEM base addr : N/A
IRQ - 4 assigned to	:	Legacy ISA	
IRQ - 5 assigned to	:	PCI/ISA PnP	
IRQ - 7 assigned to	:	PCI/ISA PnP	
IRQ - 9 assigned to	:	PCI/ISA PnP	
IRQ - 10 assigned to	:	PCI/ISA PnP	Assign IRQ For USB : Enabled
IRQ - 11 assigned to	:	PCI/ISA PnP	
IRQ - 12 assigned to	:	PCI/ISA PnP	PNP OS Installed : No
IRQ - 14 assigned to	:	PCI/ISA PnP	
IRQ - 15 assigned to	:	PCI/ISA PnP	
DMA - 0 assigned to	:	PCI/ISA PnP	
DMA - 1 assigned to	:	PCI/ISA PnP	
DMA - 3 assigned to	:	PCI/ISA PnP	
DMA - 5 assigned to	:	PCI/ISA PnP	
DMA - 6 assigned to	:	PCI/ISA PnP	
DMA - 7 assigned to	:	PCI/ISA PnP	
			ESC : Quit ↑ ↓ → ← : Select Item
			F1 : Help PU/PD/+/- : Modify
			F5 : Old Values (Shift) F2 : Color
			F7 : Load Setup Defaults



Note: Starred (*) items will disappear when the [Resources Controlled By] option is set to [Auto].

After you have completed the PCI Slot Configuration, press [Esc] and follow the instructions on your screen to save your settings or exit without saving.

3-6.1 PNP/PCI Configuration Controls

PNP/PCI Controls	Setting	Description	Note
Resources Controlled By	Manual	BIOS does not manage PCI/ISA PnP card IRQ assignment. Requires to assign IRQ-# and DMA-# to PCI or ISA PnP manually. IRQ-3,4,5,7,9,10,11,12,14,15 assigned to: _ DMA-0,1,3,5,6,7 assigned to: _	
	Auto	The Plug-and-Play BIOS auto manages PCI/ISA PnP card IRQ assignment automatically.	Recommended
Reset Configuration Data	Disabled	Retain PnP configuration data in BIOS.	Default
	Enabled	Reset PnP configuration data in BIOS.	

3-6.2 PNP/PCI Configuration Setup

PNP/PCI Setup	Setting	Description	Note
If [Resources Controlled By] is set to [Manual]			
IRQ-# and DMA-# assigned to:	PCI/ISA PnP	Choose IRQ-# and DMA-# assigned to PCI/ISA PnP card.	IRQ-3,4,5,7,9,10,11,12,14,15 DMA-0,1,3,5,6,7
	Legacy ISA	Choose IRQ-# and DMA-# assigned to Legacy ISA card.	IRQ-3,4,5,7,9,10,11,12,14,15 DMA-0,1,3,5,6,7
Under this item the user can assign an IRQ to a PCI slot. However, there under some conditions the IRQ will not be assigned as selected under this item:			
<ol style="list-style-type: none"> 1. IRQs 0, 1, 2, 6, 8, 13 can NOT be assigned, because they are fixed. 2. IRQs 5, 9, 10, 11 are available 3. IRQs 3,4,7,12,14 and 15 will only be assigned if they are free. See the table below on how to free them: 			

PNP/PCI Configuration Setup (Continued)

PNP/PCI Setup	Setting	Description	Note
Interrupt Line	How to set the BIOS to release the IRQ to the PnP Interrupt pool:		
	PnP / PCI configuration	Integrated Peripherals	
IRQ 15	IRQ 15: PCI / ISA PnP	On-Chip Secondary PCI IDE: disabled	
IRQ 14	IRQ 14: PCI / ISA PnP	On-Chip Primary PCI IDE: disabled	
IRQ 12	IRQ 12: PCI / ISA PnP	<i>Interrupt 12 will be released by the PnP BIOS automatically if the PS/2 Mouse Port is not used.</i>	
IRQ 7	IRQ 7: PCI / ISA PnP	Onboard parallel port: disabled	
IRQ 4	IRQ 4: PCI / ISA PnP	Onboard Serial port 1: disabled	
IRQ 3	IRQ 3: PCI / ISA PnP	Onboard Serial port 2: disabled	
4. Your OS may reassign another interrupt to a PCI slot after BIOS passes control to the OS, especially if you use Windows 95, 98 or NT.			
Slot 1/2/3/4 Use IRQ NO.	Auto		Default
		Select one of the interrupts. Note: The selected IRQ will only be assigned if it is available. (Windows may reassign IRQs).	
Used MEM base addr	Memory length	8K,16K,32K,64K. (Please ask your card provider for the exactly memory length of this add-on card.)	This item appears only when the [Based MEM base addr] set to I/O address.
Assign IRQ For USB	Enabled	BIOS will assign IRQ for USB port.	Default
	Disabled	BIOS won't assign IRQ for USB port.	
PnP OS Installed	Yes	Set this field to [Yes] if you are running Windows 95, which is PnP compatible.	
	No	If the OS you are running does not support PnP configuration.	Default (If there is any doubt, set this field to [No])

3-7 LOAD SETUP DEFAULTS

Select the [LOAD SETUP DEFAULTS] option from the Main Menu to load the system values you have previously saved. This option is recommended if you need to reset the system setup and to retrieve the old values.

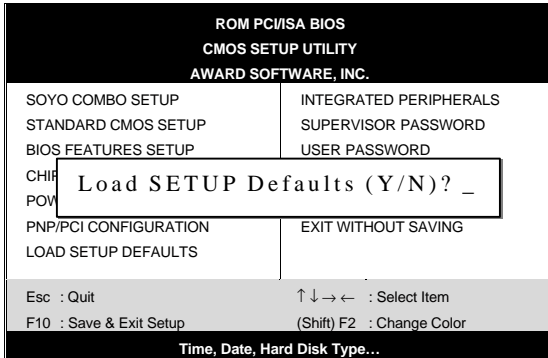

Type [Y] to use the Setup Defaults followed by [Enter] or otherwise [N] to return to the Main Menu and keep current values.



Warning: If you run into any problem after changing the BIOS configuration, please load the SETUP DEFAULTS for stable performance.

3-8 INTEGRATED PERIPHERALS



Caution: Change these settings only if you are already familiar with the Chipset.

The [INTEGRATED PERIPHERALS] option changes the values of the chipset registers. These registers control the system options in the computer.

The following screen shows setup default settings.

ROM PCI/ISA BIOS			
INTEGRATED PWEIPHERALS			
AWARD SOFTWARE, INC.			
IDE HDD Block Mode	: Enabled	Onboard FDC Controller	: Enabled
IDE Primary Master PIO	: Auto	Onboard Serial Port 1	: 3F8/IRQ4
IDE Primary Slave PIO	: Auto	Onboard Serial Port 2	: 2F8/IRQ3
IDE Secondary Master PIO	: Auto		
IDE Secondary Slave PIO	: Auto	UR2 Mode	: Standard
IDE Primary Master UDMA	: Auto		
IDE Primary Slave UDMA	: Auto	Onboard Parallel Port	: 378/IRQ7
IDE Secondary Master UNMA	: Auto	Parallel Port Mode	: SPP
IDE Secondary Slave UDMA	: Auto		
On-Chip Primary PCI IDE	: Enabled	PWRON After PWR-Fail	: Off
On-Chip Secondary PCI IDE	: Enabled		
USB Keyboard Support	: Disabled		
Init Display First	: PCI Slot		
		ESC	: Quit
		F1	: Help
		F5	: Old Values
		F7	: Load Setup Defaults
		↑ ↓ → ←	: Select Item
		PU/PD/+/-	: Modify
		(Shift) F2	: Color

The following tables describe each field in the INTEGRATED PERIPHERALS Menu and provide instructions on how to configure the IDE controls, FDC controls, and the onboard serial and parallel ports.

3-8.1 IDE Device Controls

IDE Controls	Setting	Description	Note
IDE HDD Block Mode	Disabled		
	Enabled	Invokes multi-sector transfer instead of one sector per transfer. Not all HDDs support this function.	Default
IDE ➤ Primary Master PIO ➤ Primary Slave PIO ➤ Secondary Master PIO ➤ Secondary Slave PIO	mode 0-4	0 is the slowest speed 4 is the fastest speed	
	Auto	For better performance and stability, we suggest you use the Auto setting to set the HDD control timing.	Default
IDE ➤Primary Master UDMA ➤Primary Slave UDMA ➤Secondary Master UDMA ➤Secondary Slave UDMA	Disabled		
	Auto	Select Auto to enable Ultra DMA Mode support.	Default
On-Chip PCI IDE ➤ Primary ➤ Secondary	Disabled	Turn off the on-board IDE	
	Enabled	Use the on-board IDE	Default

3-8.2 Keyboard Controls

Keyboard Controls	Setting	Description	Note
USB Keyboard Support	Disabled	Turn off the on-board IDE	Default
	Enabled	Use a USB keyboard	
Init Display First	PCI Slot	Choose which card –	Default
	AGP	AGP Display card or PCI VGA card – to initialize first.	

3-8.3 FDC Controls

FDC Controls	Setting	Description	Note
Onboard FDC controller	Disabled	Turn off the on-board floppy controller	
	Enabled	Use the on-board floppy controller	Default

3-8.4 Onboard Serial Ports

Onboard Serial Ports	Setting	Description	Note
Onboard UART 1 Onboard UART 2	Disabled		
	3F8/IRQ4	Choose serial port 1 & 2's I/O address.	Default (port 1)
	2F8/IRQ3	Do not set port 1 & 2 to the same address except for Disabled or Auto.	Default (port 2)
	3E8/IRQ4		
	2E8/IRQ3		
	Auto		
UR2 Mode	Standard	Supports a Standard serial infrared IrDA.	Default
	IrDA 1.0		
	ASKIR	Supports a Sharp serial interface format.	
If [UR2 Mode] is set to [IrDA 1.0]/[ASKIR]			
UR2 Duplex Mode	Half		Default
	Duplex	Choose [Half] or [Duplex] to set UR2 in half duplex mode or full duplex mode respectively. Refer to your IR device specifications to select the suitable mode.	

3-8.5 Onboard Parallel Ports

Onboard Parallel Ports	Setting	Description	Note
Onboard Parallel Port	378H/IRQ7	Choose the printer I/O address.	Default
	3BCH/IRQ7		
	278H/IRQ5		
Parallel Port Mode	ECP/EPP	The mode depends on your external device that connects to this port.	Default
	SPP		
	ECP		
	EPP/SPP		
If [Parallel Port Mode] is set to [ECP] mode			
ECP Mode use DMA	3	Choose DMA3	Default
	1	Choose DMA1	
If [Parallel Port Mode] is set to [EPP] mode			
EPP Mode Select	EPP 1.9	Select EPP port type 1.9	Default
	EPP 1.7	Select EPP port type 1.7	
PWRON After PWR-Fail	On	The system will switch on when power comes back after a power failure.	Default
	Off	The system will remain off when power comes back after a power failure.	
	Former-sts	The system will return to the state it was in before the power failure when power returns. (i.e: If the system was on, it will switch on again, if it was off, it will remain off)	

3-8.6 MULTI I/O ADDRESSES

Default settings for multi-I/O addresses are as follows:

Port	I/O Address	IRQ	Status
LPT1	378H	7	ECP/EPP
COM1	3F8H	4	
COM2	2F8H	3	



Warning: If a default I/O address conflicts with other I/O cards such as sound card, you must change one of the I/O addresses to remedy to this address conflict. (I/O addresses can be adjusted from the BIOS Setup Utility)

3-9 SUPERVISOR PASSWORD

Based on the setting you have made in the [Security Option] of the [BIOS FEATURES SETUP] section, the password prevents access to the system or the setup program by unauthorized users. Follow this procedure to set a new password or disable the password:

1. Choose [BIOS FEATURES SETUP] in the Main Menu and press [Enter]. Select the [Security Options] item and set the field to:
 - a. [System]: The password is required every time the system is booted. This means only a person who knows the password can use this computer.
 - b. [Setup]: The password is required only when you attempt to enter the BIOS Setup program.
2. Choose [SUPERVISOR PASSWORD] from the Main Menu and press [Enter]. The following prompt appear:

Enter Password:



Warning: If you forget or lose the password, the only way to access the system is to set jumper JP5 to clear the CMOS RAM. All setup information is lost and you must run the BIOS setup program again.



Note: If you do not wish to use the password function, press [Enter] directly and the following message appears:

Password Disabled!!

- 3. Enter your new password and press [Enter]. The following message appears, prompting to confirm the new password:

Confirm Password:

- 4. Re-enter your password and then press [Enter] to exit to the Main Menu.

This diagram outlines the password selection procedure:

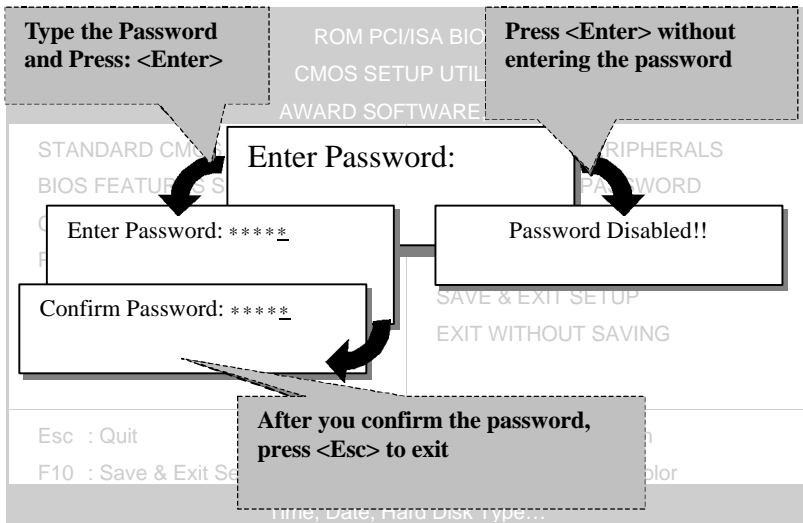

3-10 USER PASSWORD

When the user password option is on, you are not allowed to change any setting in the [CMOS SETUP UTILITY] except for changing the user's password.

The password setting procedure is similar to that for the [SUPERVISOR PASSWORD] (Refer to section 3-9).

3-11 IDE HDD AUTO DETECTION

This Main Menu function automatically detects the hard disk type and configures the STANDARD CMOS SETUP accordingly.

**ROM PCI/ISA BIOS
CMOS SETUP UTILITY
AWARD SOFTWARE, INC.**

HARD DISKS	TYPE	SIZE	CYLS	HEAD	PRECOMP	LANDZ	SECTOR	MODE
Primary Master :								
Select Primary Master Option (N=Skip) : N								
OPTIONS	SIZE	CYLS	HEAD	PRECOMP	LANDZ	SECTOR	MODE	
2(Y)	1707	827	64	0	3308	63	LBA	
1	1707	3309	16	65535	3308	63	NORMAL	
3	1707	827	64	65535	3308	63	LARGE	

Note: Some Oses(SCO-UNIX Before v5.0) must use "NORMAL" for installation

ESC : Skip



Note: This function is only valid for IDE type of hard disk drives.

Chapter 4

DRIVERS INSTALLATION

Your SY-6BA+ IV Motherboard comes with a CD-ROM labeled "SOYO CD." The SOYO CD contains the user's manual file for your new Motherboard, the drivers software available for installation, and a database in HTML format with information on SOYO Motherboards and other products.

The SOYO CD Start Up Program automatically detects which SOYO Motherboard you own and displays the corresponding model name.

Step 1. Insert the SOYO CD into the CD-ROM drive

The SOYO CD will auto-run, and the SOYO CD Start Up Menu will display as shown below.



Step 2. Read SOYO [6BA+ IV] Manual

Click the **Read Manual** button to open the user's manual file of your Motherboard.

Please note that if the Start Up program was unable to determine which SOYO Motherboard you own, the manual selection menu will pop up, as shown below. Then select the user's manual file that corresponds to your Motherboard model name and click **OK**.

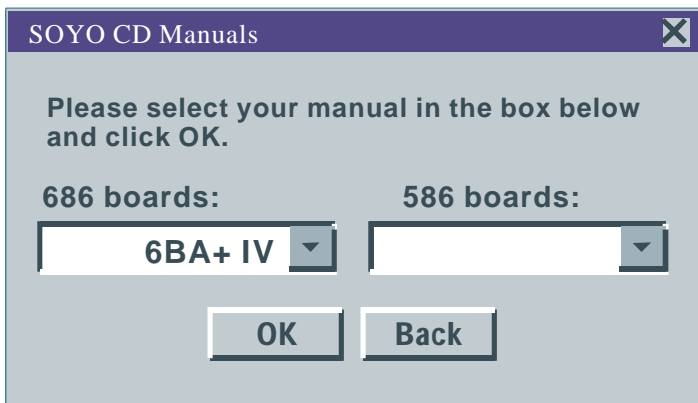
**(Manual Selection Menu)**

The user's manual files included on the SOYO CD can be read in PDF (Postscript Document) format. In order to read a PDF file, the appropriate Acrobat Reader software must be installed in your system.

Note: The Start Up program automatically detects if the Acrobat Reader utility is already present in your system, and otherwise prompts you on whether or not you want to install it. You must install the Acrobat Reader utility to be able to read the user's manual file. Follow the instructions on your screen during installation, then once the installation is completed, restart your system and re-run the SOYO CD.

Step 3. Install Drivers

Click the Install Drivers button to display the list of drivers software that can be installed with your Motherboard. The Start Up program displays the drivers available for the particular model of Motherboard you own. We recommend that you only install those drivers.

However, to display the list of all drivers software available with SOYO Motherboards, click the *Display all drivers on the SOYO CD* button.

Please make sure to install only the drivers adapted to your system, or otherwise this cause system malfunctions.

The following drivers are available for Windows 95

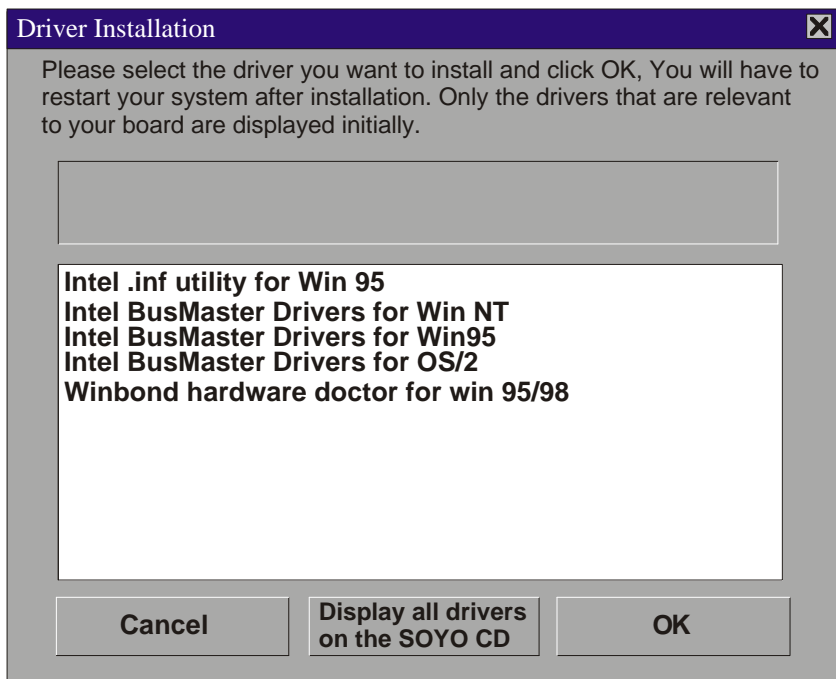

(Driver Installation Menu)

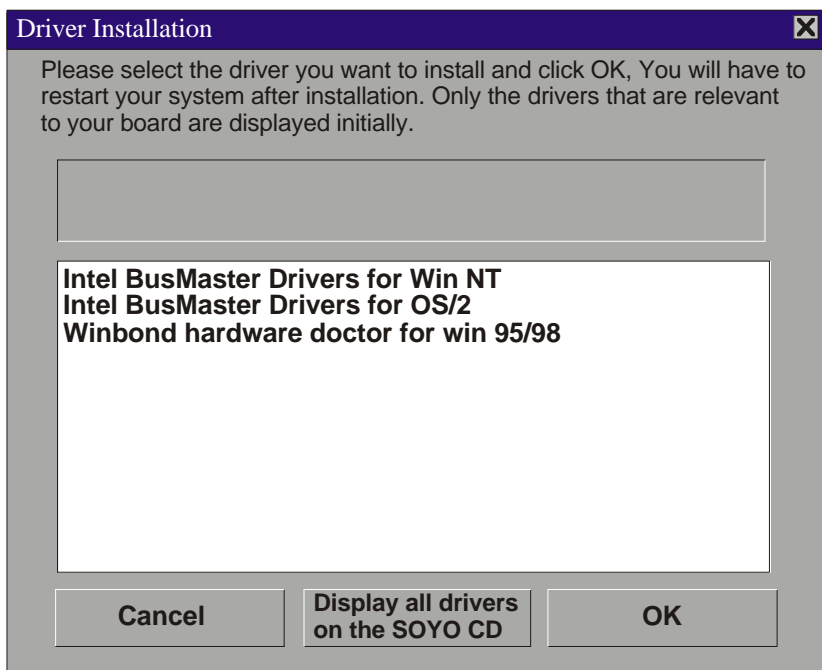
The following drivers are available for Windows 98**(Driver Installation Menu)**

A short description of all available drivers follows:

➤ **Intel .inf utility for Win 95**

Because Windows 95 does not recognize the Southbridge of the newer Intel chipsets (TX, BX, ZX etc) this utility has to be run, it will update the necessary Windows .inf files. (Only for Windows 95)

➤ **Intel Busmaster Drivers for Windows 95**

➤ **Intel Busmaster Drivers for Win NT**

➤ **Intel Busmaster Drivers for OS/2**

These are the official busmaster drivers as supplied by Intel.



Note: Do NEVER install two types of busmaster drivers on your system, this will lead to conflicts and system instability.

➤ **Winbond hardware doctor for Windows 9x**

Your motherboard comes with a hardware monitoring IC. By installing this utility Temperature, Fan speed and Voltages can be monitored. It is also possible to set alarms when current system values exceed or fall below pre-set values.

This utility comes with a preset monitoring range for the CPU voltage. However, the core voltage of the processor you purchased may fall out of this preset range, so you may need to adjust the pre-set value. Please refer to the SY-6BA+ IV Motherboard's CD manual for the details.

Select which driver you want to install and click **OK**, or click **Cancel** to abort the driver installation and return to the main menu.

Note: Once you have selected a driver, the system will automatically exit the SOYO CD to begin the driver installation program. When the installation is complete, most drivers require to restart your system before they can become active.

- **Core voltage**

The core voltage differs between generations of Intel CPUs, if the Hardware monitor gives a warning, the settings for the safe range of the core voltage has to be adjusted. This can be done by simply clicking and dragging the upper and lower limit bars.

For example:

Newer Slot 1 CPUs have a core voltage of 2.0V. Therefore, set the CPU Vcore limits to 1.8V and 2.2V. For 2.8V core voltage CPUs the limits would be 2.6V and 3.0V.

- **Fan speed**

The Hardware monitor can keep track of three fans. If the user does not use all fans, the fans that are not in use should be disabled in the Hardware monitor program, otherwise the Hardware monitor will give an alarm. If this happens, make sure to disable monitoring for that fan.

Note: However, to display the list of all drivers software available with SOYO Motherboards, click the **Display all drivers on the SOYO CD**

button. Please make sure to install only the drivers adapted to your system, or otherwise this cause system malfunctions.

Step 4. Check the Latest Releases

Click the 'Check the latest Releases' button to go the SOYO Website to automatically find the latest BIOS, manual and driver releases for your motherboard. This button will only work if your computer is connected to the internet through a network or modem connection. Make sure to get your modem connection up before clicking this button.

Step 5. Select which driver you want to install and click OK

Notice 1: Once you have selected a driver, the system will automatically exit the SOYO CD to begin the driver installation program. When the installation is complete, most drivers require to restart your system before they can become active.

Notice 2: You may click *Cancel* to abort the driver installation and return to the main menu.

Notice 3: Once you have selected a driver, the system will automatically exit the SOYO CD to begin the driver installation program. When the installation is complete, most drivers require to restart your system before they can become active.

Chapter 5

THE ATA 66 DRIVER INSTALLATION

➤ Installing the Windows 95/98 Drivers

Usually, when you boot up the Windows 95/98 system for the first time, the system will be able to detect the HPT366 Ultra DMA host Adapter automatically and ask you to install the driver for HPT366. You can just follow the instructions prompted by the system to install the driver. The driver is located in the following directory:

D:\drivers\hp-ata66\Win9X (Where *D* is your CD-ROM driver letter)

Otherwise, you can install the driver by the following steps:

1. Windows 95/98 must be installed on the system prior to installing the driver.
2. Close any running applications.
3. Open "My Computer".
4. Double click on the "Control Panel" icon.
5. Double click on the "Add New Hardware" applet.
6. Click on the "Next" button.
7. When asked "Do you want Windows to search for your new hardware?", choose "No" then click on the "Next" button.
8. When asked to select the hardware type, select the "SCSI controllers" and click on the "Next" button.
9. Make sure that the SOYO-CD is in your CD-ROM drive and click on the "Have Disk..." button.
10. Select the *D:\drivers\hp-ata66\Win9X* directory (Where *D* is your CD-ROM driver letter) and click on the "OK" button.
11. Click on the "Next" button.
12. If there is a window showing the settings (resources) to be used by the driver, then click on the "Next" again. At this point, the system will install the driver.

13. Click on the "Finish" button.
14. Then the system will ask you to restart the system. If the settings reported in step 12 are not what set on the host adapter, you must adjust the settings by using the device manager in the System control panel before restarting your computer.
15. The driver for ACPI function is useful only if hardware supports ACPI function.

Uninstalling the Driver

You can use the device manager in the System control panel to remove the driver.

➤ Installing the Windows NT 4.0 Drivers

When Windows NT is up, install the HPT366 device driver as follows:

1. Installing Device Driver
 - (1.) Open My Computer
 - (2.) Open Control Panel
 - (3.) Double click icon SCSI Adapters
 - (4.) Click Drivers
 - (5.) Click Add...
 - (6.) Click Have Disk...
 - (7.) Insert the SOYO-CD with the HPT366 Windows NT 4.0 device driver into your CD-ROM drive, and type "D:\drivers\hp-ta66\NT40[Enter]", then click OK. (for D type your CD-ROM driver letter)
 - (8.) Select HPT366 Ultra DMA Controller, you will be asked to enter the full path to the HPT366 Ultra DMA Controller files, type in D:\drivers\hp-ata66\NT40 and then click Continue
 - (9.) When asked to restart your computer, click Yes

Your hard disk drive attached to the HPT366 host adapter must be partitioned and formatted before you can access it. Please see Partitioning

Your Hard Disk to know how to partition and format a hard disk drive.

2. Checking the Installation

If you want to check if the HPT366 host adapter and its device driver are correctly installed, you can:

- (1.) Open My Computer
- (2.) Open Control Panel
- (3.) Double click icon SCSI Adapters
- (4.) You should see the item HPT366 Ultra DMA Controller (started) listed

3. Partitioning Your Hard Disk

If the hard disk drive attached to the HPT366 host adapter has not been partitioned and formatted yet, you need to partition it first. To partition the hard disk drive attached to the HPT366 host adapter, follow the following steps:

- (1.) Click the Startup button
- (2.) Go to Administrative Tools (Common)
- (3.) Run Disk Administrator
- (4.) Select disk number you would like to partition
- (5.) Select the menu Partition
- (6.) Decide the partition size create partition of the size
- (7.) Exit Disk Administrator
- (8.) Select the new created partition (logical disk drive) and format it

4. Troubleshooting

The boot manager for Windows NT contains recovery logic to allow you to return to the last known good configuration. If you have changed your host adapter configuration and Windows NT no longer boots, follow these steps to recover:

1. Undo any hardware changes you have made to the computer since it was last operational.
2. Reboot the computer. Watch the display carefully during booting up. If the following message appears, press the Spacebar and follow the

instructions on the display screen to continue booting with the last known good configuration: Press spacebar NOW to invoke the Last Known Good menu

3. Once your computer is operational again, check all of the hardware and software configuration changes you want to make. Look specially for conflicts with parts of the existing system configuration that are not being changed.

If Windows NT can boot but the driver has not been started (see Checking the Installation), please check the following:

1. Make sure the host adapter is properly installed, and the device is correctly connected to the adapter. Double check that the cable between the adapter and the devices is correctly attached. Also check if the jumper setting on the drive is correct.
2. Make sure that a power cable is properly attached to each drive attached to the HPT366 host adapter.

If the driver has started and you still cannot access the hard disk drive attached to the HPT366 host adapter, the hard disk drive might have not been partitioned and formatted yet. You may need to partition and format it.

New Driver releases and Support

If you have questions about installing or using this HighPoint product, check this user's guide or the readme file first, you will find answers to most of your questions here. If you need further assistance, we offer the following support and information services:

3. The Web Site provides information on software upgrades, answers to common questions, and other topics. The Web Site is available from Internet 24 hours a day, 7 days a week, at <http://www.highpoint-tech.com>.
4. For technical support, send an e-mail to support@highpoint-tech.com.

NOTE: Before you send an e-mail, please visit our Web Site (<http://www.highpoint-tech.com>) to check if there is a new or updated HPT366 device driver for your operating system.

