

80486

486 PCI/VESA Green Mainboard
User's Guide &
Technical Reference
4S A2/A5

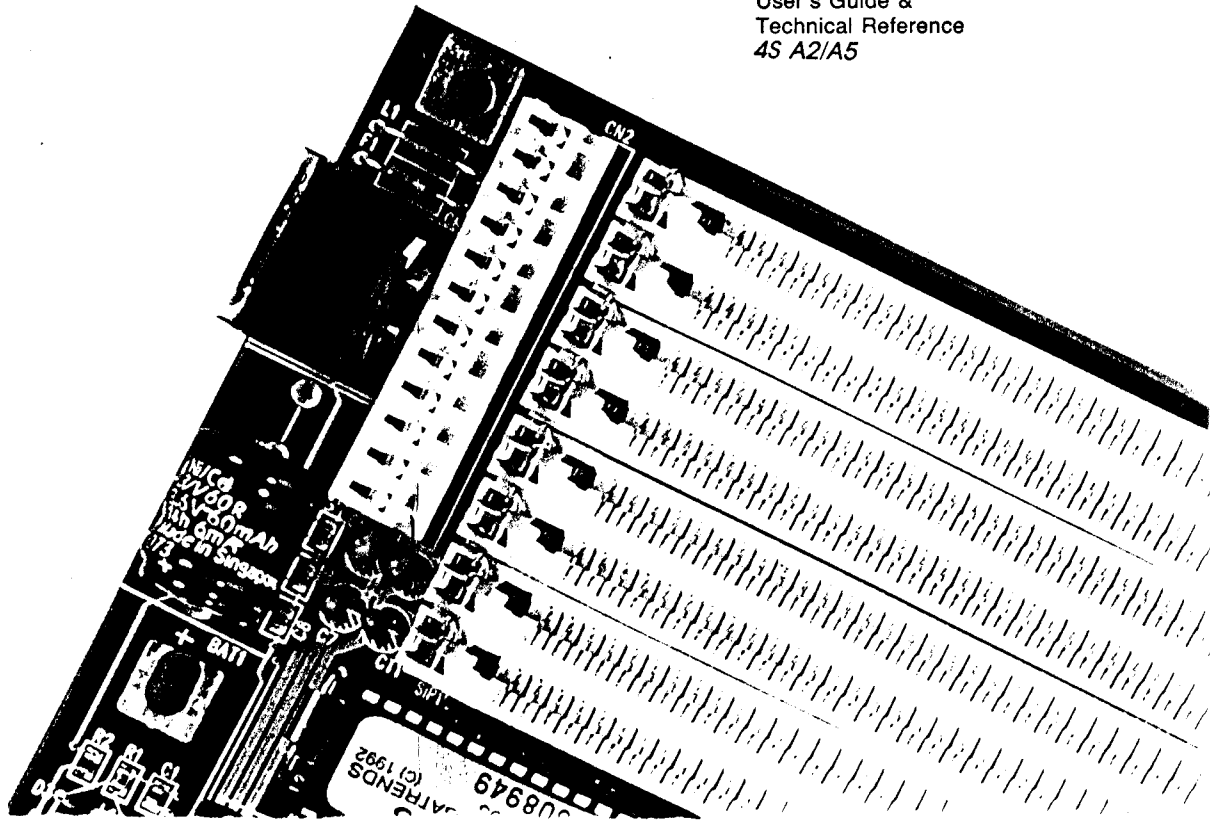

Printed in Taiwan R.O.C.



About This Guide

This User's Guide is for assisting system manufacturers and end users in setting up and installing the mainboard. Information in this guide has been carefully checked for reliability; however, no guarantee is given as to the correctness of the contents.

The information in this document is subject to change without notice.

Copyright Notice

Copyright 1995, Soyo Technology Co., Ltd. All rights reserved. This manual is copyrighted by Soyo Technology Co., Ltd. You may not reproduce, transmit, transcribe, store in a retrieval system, or translate into any language, in any form or by any means, electronic, mechanical, magnetic, optical, chemical, manual, or otherwise, any part of this publication without express written permission of Soyo Technology Co., Ltd.

Trademarks

Soyo is a registered trademark of Soyo Technology Co., Ltd. All trademarks are the property of their owners.

Disclaimer

Soyo Technology Co., Ltd. makes no representations or warranties regarding the contents of this manual. We reserve the right to revise the manual or make changes in the specifications of the product described within it at any time without notice and without obligation to notify any person of such revision or change. The information contained in this manual is provided for general use by our customers. Our customers should be aware that the personal computer field is the subject of many patents. Our customers should ensure that they take appropriate action so that their use of our products does not infringe upon any patents. It is the policy of Soyo Technology Co., Ltd. to respect the valid patent rights of third parties and not to infringe upon or assist others to infringe upon such rights.

Restricted rights legend

Use, duplication, or disclosure by the Government is subject to restrictions set forth in subparagraph (c)(1)(ii) of the Rights in Technical Data and Computer Software clause at 252.277-7013.

Edition: April, 1995

Version 1.0

Table of Contents

Chapter 1: Introduction	1
Key Features	1
Unpacking the Mainboard	2
Electrostatic Discharge Precautions	2
Mainboard Layout w/ Default Settings	3
Chapter 2: Hardware Setup	4
Jumpers	4
JP27, JP28: Factory fixed at pins 2-3	4
J7: Sleep Switch Connector	4
JP5: CMOS Reset Jumper	4
JP15: Stopped Clock Generator Select (Fixed at 1-2)	5
JP3: Display Type	5
JP8, JP9, JP10, JP11: ECP DMA Select	6
Multi I/O Port Address	6
CPU Type Configuration	7
Intel CPU Jumper Settings	7
Cyrix CPU Jumper Settings	12
UMC CPU Jumper Settings	13
AMD CPU Jumper Settings	14
Cache Configuration	16
Cache Jumper Settings	16
Cache Size and RAM Locations	16
Memory Configuration	19
Connectors	20
J17 - Keylock & Power LED Connector	20
J18 - Speaker Connector	20
J19 - Hardware Reset Control	20
J20 - External Battery Connector	20
J21 - Turbo Switch Connector	20

JP18 - On-board Primary Hard Disk LED Connector	21
JP17 - On-board Secondary Hard Disk LED Connector	21
J6 - On-board Primary Hard Disk Connector	21
J5 - On-board Secondary Hard Disk Connector	21
Chapter 3: BIOS Setup	22
Standard CMOS Setup	23
BIOS Features Setup	24
Chipset Features Setup	26
Power Management Setup	29
PCI Configuration Setup	31
Load Setup Defaults	32
Password Setting	33
IDE HDD Auto Detetion	33

1 Introduction

The 486 PCI mainboard is a high-performance system board that supports Intel 486DX2/DX/SX/SL enhanced 486, P24T, P24D, DX4, Cyrix, AMD, and UMC CPU's. The mainboard is fully compatible with industry standards, while incorporating many technical enhancements.

The 486 PCI mainboard offers superior system performance, compatibility, and reliability, and is the ideal choice for a wide variety of system applications.

Key Features

- Fully AT compatible. Supports Intel 486DX2/DX/SX/SL enhanced 486, P24T, P24D, 486DX4 (P24C), Cyrix, UMC and AMD CPUs.
- Supports Power Management Mode
 - Supports the SMM and the SMI
 - CPU Stop Clock Function
 - Four Power Saving States (normal / doze / standby / suspend)
 - Supports the APM control
 - Supports Sleep Switch control
 - Power Saving also on non-SMI CPU
 - More System Event Monitoring and Power Saving Control
- Direct map cache controller that supports 256K, 512K, and 1M cache size
- Fast page burst mode DRAM controller
- Memory configurations from 1MB to 255MB using combinations of 80ns, 256K, 512K, 1M, 2M, 4M, and 16M SIMM modules. Uses four 72-pin DRAM modules in unrestricted configurations.
- Video ROM Cacheable
- Shadow RAM in increments of 32KB
- Hardware turbo speed switch
- Four 16-bit ISA slots, three master PCI slots 1 slave PCI slot
- Support for 5V and 3.45V / 3.6V / 4.0V microprocessors
- On-board local bus IDE Controller and floppy controller
- Built-in NCR 810 PCI SCSI driver
- On-board support for two high speed UARTS (W/16550 FIFO) and multimode parallel port for standard, Enhanced (EPP) and high speed (ECP) modes

Unpacking the Mainboard

The mainboard package contains:

- The 486 PCI Mainboard
- This User's Guide

Note: Do not unpack the mainboard until you are ready to install it.

Follow the precautions below while unpacking the mainboard.

1. Before handling the mainboard, ground yourself by grasping an unpainted portion of the system's metal chassis.
2. Remove the mainboard from its anti-static packaging and place it on a grounded surface, component side up.
3. Check the mainboard for damage. If any chip appears loose, press carefully to set it firmly in its socket.

Do not apply power if the mainboard appears damaged. If there is damage to the board contact your dealer immediately.

Electrostatic Discharge Precautions

Make sure you ground yourself before handling the mainboard or other system components. Electrostatic discharge can easily damage the components. Note that you must take special precaution when handling the mainboard in dry or air-conditioned environments.

Abide by the precautions below to protect your equipment from electrostatic discharge:

- Do not remove the anti-static packaging until you are ready to install the mainboard and other system components.
- Ground yourself before removing any system component from its protective anti-static packaging. To ground yourself, grasp the expansion slot covers or other unpainted portions of the computer chassis.
- Frequently ground yourself while working, or use a grounding strap.
- Handle the mainboard by the edges and avoid touching its components.

Mainboard Layout w/ Default Settings*

*Default setting are for an Intel DX2-66 SL Enhanced CPU, 256K cache, IDE on board, and power saving controlled by SMOUT (JP15).

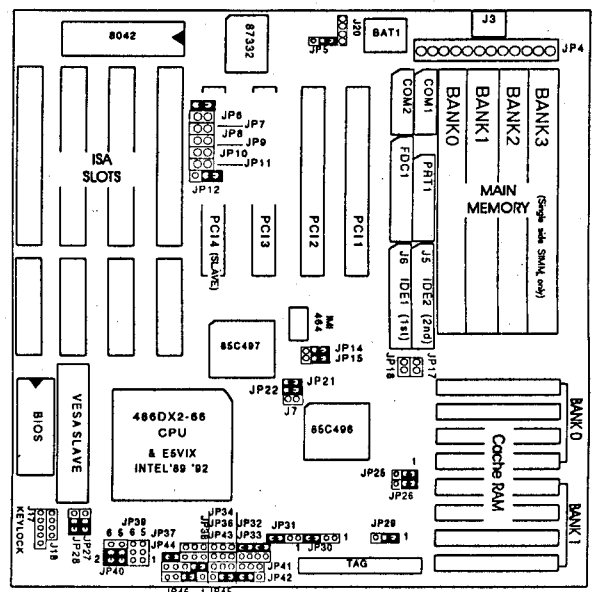

Figure 1-1. Mainboard Layout

2 Hardware Setup

This chapter explains how to set jumpers, install a processor and memory on the mainboard and make case connections. Refer to this chapter whenever you upgrade or reconfigure the system.

CAUTION: Turn off power to the mainboard, system chassis, and peripheral devices before performing any work on the mainboard or system.

Jumpers

JP27, JP28: Factory fixed at pins 2-3



JP1, JP2, JP4, JP13, JP19	Reserved
JP6	Factory setting at short
JP7	Factory setting at open
JP12	Factory setting at 1-2

J7: Sleep Switch Connector

Toggle this jumper to force the system to enter suspend mode. Any interrupt or move the input device to wake up the system to full speed mode.



JP5: CMOS Reset Jumper

JP5 lets you discharge CMOS memory in the event you forget your password or encounter a BIOS Setup problem. Before you install the mainboard make sure that JP5 is set to retain CMOS memory.

CMOS Setting	JP5
Retain CMOS Data (Default)	
Discharge CMOS	



JP15: Stopped Clock Generator Select (Fixed at 1-2)

Jumper JP15 sets the STPCLK or SMOUT signal for stopping the clock generator.

Setting	JP15
Stopped by SMOUT for all CPUs. (Default)	
Stopped by STPCLK for all CPUs except AMD DXL CPUs.	













JP3: Display Type

Set JP3 to configure the mainboard for use with either a color or monochrome monitor.

Display Type	JP3
Monochrome	
Color/EGA/VGA (Default)	

JP8, JP9, JP10, JP11: ECP DMA Select

These jumpers set the ECP DMA for DRQ3/DACK3 or for DRQ7/DACK7.

ECP DMA Select	JP8	JP11	JP9	JP10
DRQ3/DACK3				
DRQ7/DACK7				
None (Default)				

Multi I/O Port Address

Default settings for multi-I/O port addresses are shown in the following table.

Port	I/O Address	IRQ	Status
LPT1*	3BCH	7	Standard Parallel Port
COM1	3F8H	4	
COM2	2F8h	3	

*LPT1 is default for standard mode. If you want ECP/EPP functions, you must use the BIOS or drivers settings. You must also set JP6-JP8 and JP10 to configure DRQ/DACK. If the default I/O port addresses conflict with other I/O cards (e.g. sound cards or I/O cards), you must adjust one of the I/O addresses to avoid address conflict. (You can adjust these I/O port addresses from the BIOS. See page 24.)

Note: Some sound cards have a default IRQ setting for IRQ7, which may conflict with printing functions. If this occurs do not use the sound card functions the same time as you print.

CPU Type Configuration

Configure the 486 PCI mainboard's CPU by inserting the specified CPU and setting jumpers as described in the diagrams that follow. Note that the CPU Type jumpers on the mainboard have yellow caps and the Clock Setting jumpers have red caps.

Intel 486SX/SX SL-Enhanced CPU

486SX-25/33 Setting

486SX2-50*/66* Setting

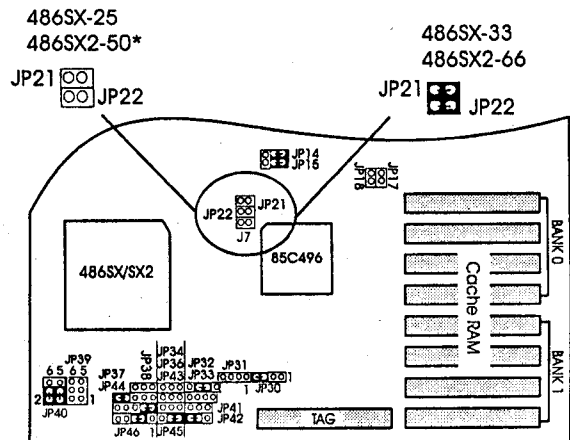

Figure 2-1: 486SX/SX SL-Enhanced CPU Jumper Settings

Note: If you are using a CPU not listed in this manual, please contact your dealer to determine the correct CPU settings.

* For these CPUs a cooling fan is necessary for system stability.

Intel 486DX/DX SL Enhanced, DX4 ODP (5V) CPU
DX-25/33/40/50*, DX2-50*/66*/80* Setting

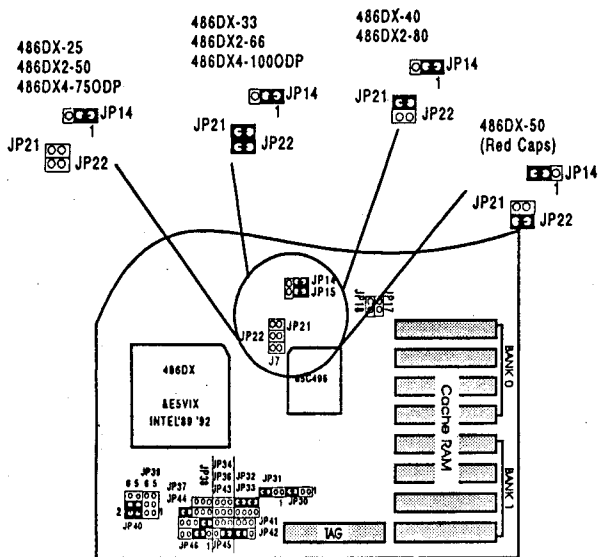

Figure 2-2: 486DX/DX SL-Enhanced, DX4 ODP (5V) CPU

* For these CPUs, a cooling fan is necessary for system stability.

Note: Do not change the JP40 setting, the Intel DX4 ODP is a 5V CPU.

Intel P24D CPU (Internal Write-back Cache)
P24D-50*/66* Setting

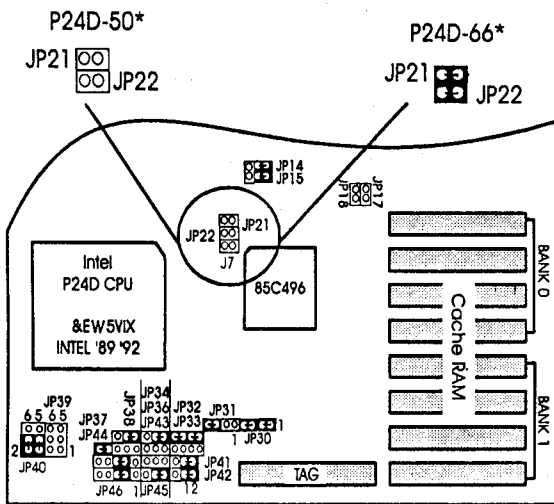

Figure 2-4: Intel P24D CPU Settings

* For these CPUs a cooling fan is necessary for system stability.

Intel DX4 (3.45V) CPU
DX4-75*/100* Settings

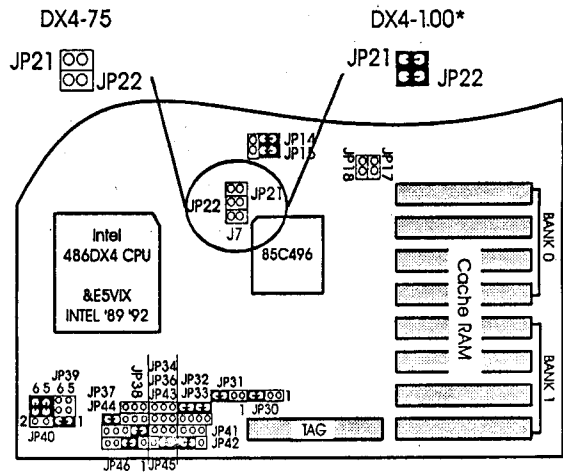

Figure 2-3: Intel DX4 (3.45V) CPU Jumper Setting

Note: The DX4-75/100 is a 3.45V CPU. We recommend that you set the JP39/JP40 as shown above.

Intel P24T CPU (Pentium Overdrive 238-pin,
Internal 2.5x clock, internal write-back cache)
P24T-63*/83* Settings

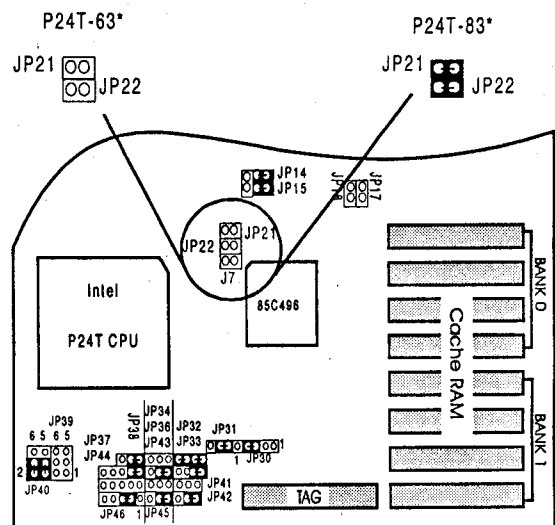

Figure 2-5: Intel P24T CPU Jumper Settings

* For these CPUs a cooling fan is necessary for system stability.

Cyrix DX/DX2 CPU Setting
 DX-33/40/50, DX2-50*/66* (5V)
 DX2-V50*/V66* (3.6V)
 DX2-V80* (4V) Settings

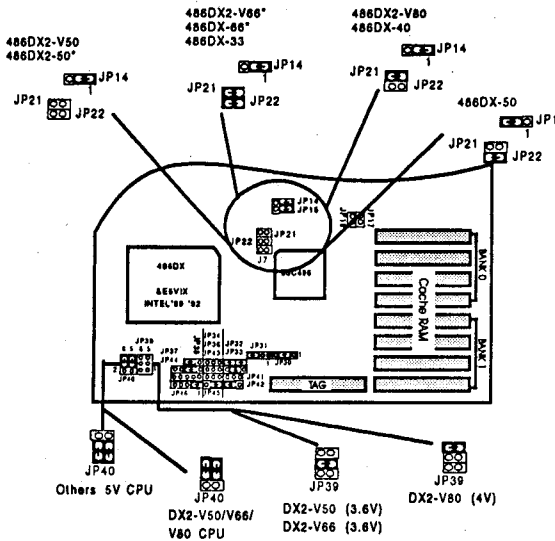

Figure 2-6: Cyrix DX/DX2 CPU Setting

* For these CPUs, a cooling fan is necessary for system stability.

AMD 486DX2-66*/80* (5V)
 DX4-75*/100* (N) V8T (3.45V)
 DX2-66*/80* (N) V8T (3.45V)

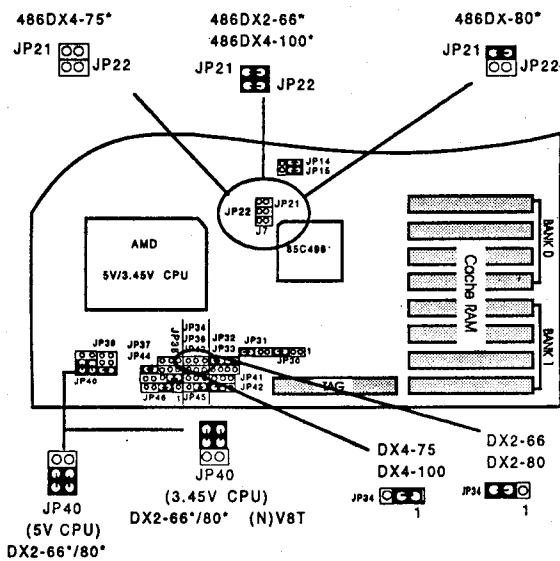

Figure 2-8: AMD DX2-66/80, DX4-100 (3.45V) CPU Jumper Settings

* For these CPUs, a cooling fan is necessary for system stability.

Note: If the AMD CPU has (N)V8T marked on the surface, it indicates a 3.45V CPU. You must set JP39/JP40 as shown above.

UMC CPU Jumper Settings
 UMC U5S CPU
 U5S-25/33/40 Setting

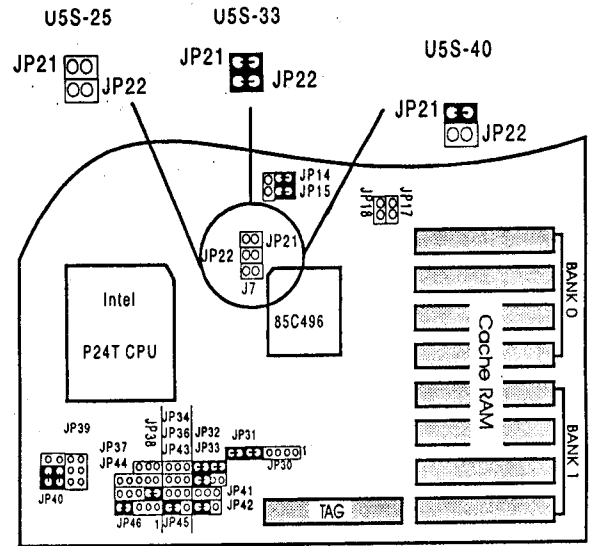

Figure 2-8: UMC USS CPU (Green) Jumper Settings

* For these CPUs, a cooling fan is necessary for system stability.

AMD Enhanced 486 Plus CPU
 486DX2-66/80 CPU
 486DX4-75/100 CPU

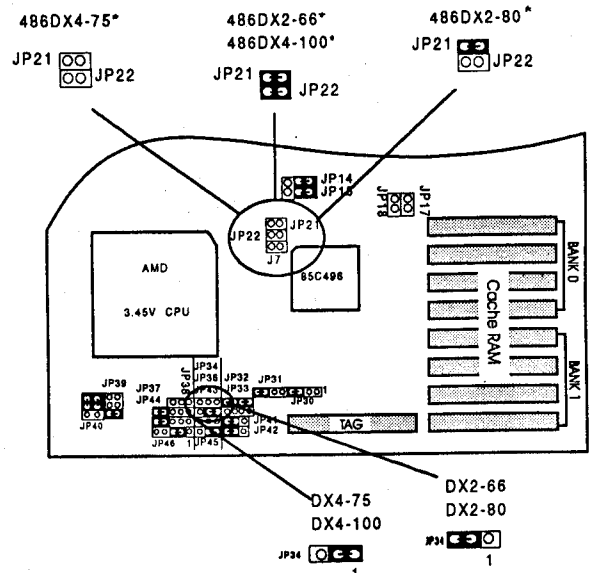

Figure 2-9: AMD DX2-66/80, DX4-75/100 CPU Jumper Settings

* For these CPUs, a cooling fan is necessary for system stability.

Note: If the AMD CPU has (N)V8B marked on the surface, it indicates a 3.45V CPU. You must set JP39/JP40 as shown above.

Cache Configuration

The 486 PCI mainboard has a write-back caching scheme. You can configure the mainboard's external cache for 256KB, 512KB, or 1MB by setting jumper switches and installing cache chips. Refer to the following pages for jumper switch settings and cache socket locations.

Cache Jumper Settings

You must set jumpers JP25, JP26, JP29 to configure cache size. See the illustrations below. Note that cache jumpers on the mainboard have white jumper caps.

Cache Size and RAM Locations

You can configure cache size using 32Kx8, 64Kx8, or 128Kx8 cache chips. The table below describes chip type and socket locations for each configuration.

Cache Size	Cache RAM	Tag RAM	WB Cacheable Range
256KB	32K x 8 / U18, U20, U22, U23, U25, U26, U28, U30	32K x 8 / U32 or 16K x 8 / U32	64MB
256KB	64K x 8 / U18, U20, U22, U23	32K x 8 / U32 or 16K x 8 / U32	64MB
512KB	64K x 8 / U18, U20, U22, U23, U25, U26, U28, U30	32K x 8 / U32	128MB
512KB	128K x 8 / U18, U20, U22, U23	32K x 8 / U32	128MB
1MB	128K x 8 / U18, U20, U22, U23, U25, U26, U28, U30	64K x 8 / U32	256MB

Note: Tag and Data RAM use 20ns for all conditions.

256K Cache (32K*8 8pcs, 2 Bank) Configuration

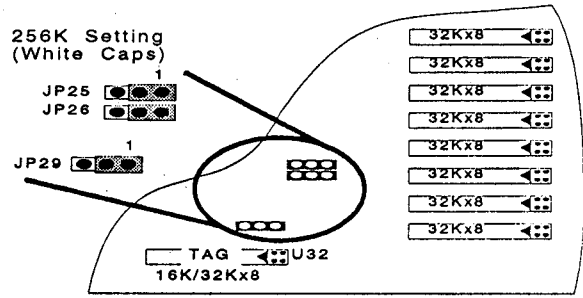

Cache Size	JP25	JP26	JP29
256K (32K*8 8pcs)	1-2	1-2	1-2

256K Cache (64K*8 4pcs, 1 Bank) Configuration

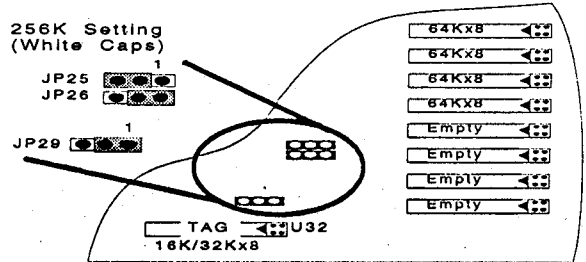

Cache Size	JP25	JP26	JP29
256K (64K*8 4pcs)	2-3	1-2	1-2

512K Cache (64Kx8, 8pcs, 2 Bank) Configuration

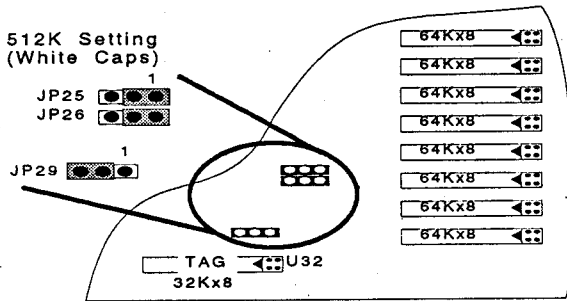

Cache Size	JP25	JP26	JP29
512K (64K*8 8pcs)	1-2	1-2	2-3

512K Cache (128Kx8 4pcs, 1 Bank) Configuration

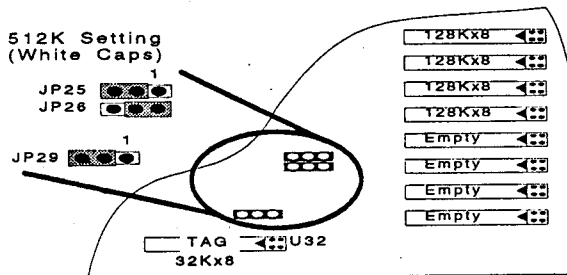

Cache Size	JP25	JP26	JP29
512K (128K*8 4pcs)	2-3	1-2	2-3

1M Cache (128K*8 8pcs, 2 Bank)

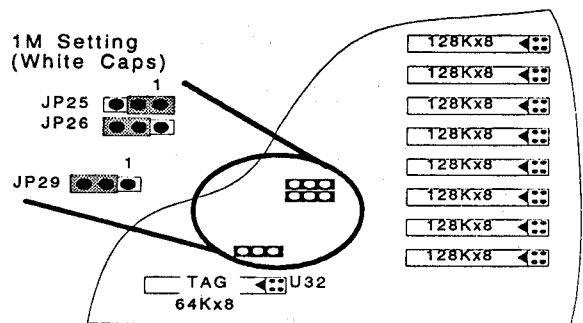

Note: The board maker does not provide 1M cache components.

Memory Configuration

The mainboard supports four banks of 72-pin SIMM (Single In-line Memory Modules). The mainboard requires SIMM of at least 80ns access time. Also support with parity (x36) or without parity (x32). There are no restrictions on memory configuration. You can install DRAM in any combination without having to rely on a memory configuration table. Memory configuration is thus "Table-Free".

Single-Sided SIMM	Double-Sided SIMM
1MB = 256K x 36 (32)	2MB = 512K x 36 (32)
4MB = 1MB x 36 (32)	8MB = 2MB x 36 (32)
16MB = 4MB x 36 (32)	32MB = 8MB x 36 (32)
64MB = 16MB x 36 (32)	

Connectors

Attach the 486 PCI mainboard to case devices, or an external battery, via connectors on the mainboard. Refer to Figure 1-1 for connector locations and connector pin positions.

J17 - Keylock & Power LED Connector

J17 is a connector for a lock that may be installed on the system case for enabling or disabling the keyboard. J17 also attaches to the case's Power LED.

J18 - Speaker Connector

Attach the system speaker to connector J18.

J19 - Hardware Reset Control

Attach the Reset switch to J19. Closing the Reset switch restarts the system.

J20 - External Battery Connector

J20 is a 4-pin connector to which you can attach an external battery: Pin 1 of J20 is positive (+) and pin 4 is negative (-).

J21-Turbo Switch Connector

J21 is connected to a Turbo switch on the front of the system case. The connector's pins are opened for normal operation and shorted for turbo operation.

J22 - Turbo LED Connector

J22 connects to a Turbo LED on the case control panel and works with the Turbo Switch. If the mainboard is in Turbo mode, the Turbo LED lights. When the LED flashes, it means the system has entered power saving mode.

KB1 - Keyboard Connector

A five-pin female DIN keyboard connector is located at the rear of the board. Plug the keyboard jack into this connector.

J4 - Power Supply Connectors

The mainboard requires a power supply with at least 200 watts and a "power good" signal. J4 has two six-pin male header connectors.

Plug the dual connectors from the power directly onto the board connector while making sure the black leads are in the center.

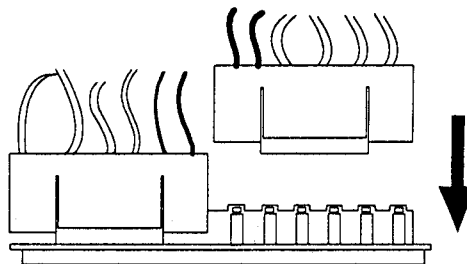

JP18 - On-board Primary Hard Disk LED Connector

JP17 - On-board Secondary Hard Disk LED Connector

J6 - On-board Primary Hard Disk Connector

J5 - On-board Secondary Hard Disk Connector

You can enable/disable on board IDE via BIOS control (see page 26).

3 BIOS Setup

The mainboard's BIOS setup program is the ROM ISA BIOS from Award Software Inc. Enter the Award BIOS program's Main Menu as follows:

1. Turn on or reboot the system. After a series of diagnostic checks, you are asked to press DEL to enter Setup.
2. Press the key to enter the Award BIOS program and the main screen appears:

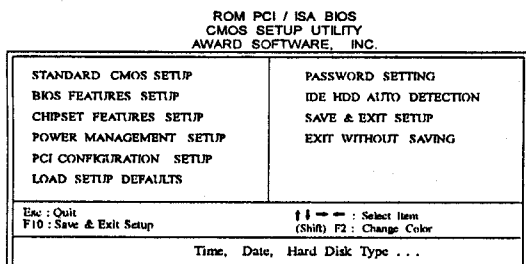

3. Choose an option and press <Enter>. Modify the system parameters to reflect the options installed in the system. (See the following sections.)
4. Press <ESC> at anytime to return to the Main Menu.
5. In the Main Menu, choose "SAVE AND EXIT SETUP" to save your changes and reboot the system. Choosing "EXIT WITHOUT SAVING" ignores your changes and exits the program.

The Main Menu options of the Award BIOS are described in the sections that follow.

Standard CMOS Setup

Run the Standard CMOS Setup as follows.

1. Choose "STANDARD CMOS SETUP" from the Main Menu. A screen appears.

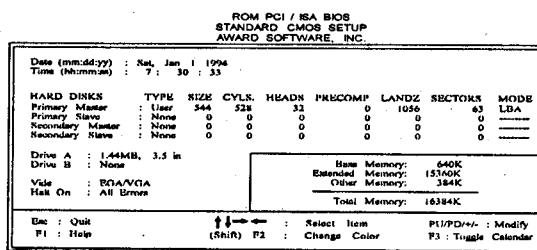

2. Use arrow keys to move between items and select values. Modify selected fields using PgUp/PgDn/+/- keys. Some fields let you key in values directly.

- Date (mm/dd/yy)** Type the current date.
- Time (hh:mm:ss)** Type the current time.
- Primary (Secondary) Master & Slave** Choose from the standard hard disk types 47 is user definable. If a hard disk is not installed choose "Not installed". (default)
- Drive A & B** Choose 360KB, 5 1/4", 1.2MB, 5 1/4", 720KB, 3 1/2", 1.4M, 3 1/2" or Not installed
- Video** Choose Monochrome, Color 40x25, VGA/EGA (default), Color 80x25 .

3. When you finish, press the <ESC> key to return to the Main Menu.

BIOS Features Setup

Run the BIOS Features Setup as follows.

ROM PCI / ISA BIOS BIOS FEATURES SETUP AWARD SOFTWARE, INC.			
CPU Internal Cache	: Enabled	Video BIOS Shadow	: Enabled
External Cache	: Enabled	C8000-CFFFF Shadow	: Disabled
Quick Power On Self Test	: Enabled	D8000-D7FFF Shadow	: Disabled
Boot Sequence	: A, C	D8000-DFFFF Shadow	: Disabled
Swap Floppy Drive	: Disabled		
Boot Up NumLock Status	: On		
IDE HDD Block Mode	: Enabled		
Gate A20 Option	: Fast		
Memory Parity Check	: Disabled		
Typeomatic Rate Setting	: Disabled		
Typeomatic Rate (Chars/Sec)	: 6		
Typeomatic Delay (Msec)	: 250		
Security Option	: Setup		
IDE Second Channel Control	: Enabled		
		ESC : Quit	↑ ↓ → ← : Select Item
		F1 : Help	PU/PD/+/- : Modify
		F5 : Old Values	(Shift) F2 : Color
		F6 : Load BIOS Defaults	
		F7 : Load Setup Defaults	

1. Choose "BIOS FEATURES SETUP" from the Main Menu and a screen with a list of items appears. (The screen below shows BIOS default settings.)
2. Use the arrow keys to move between items and select values. Modify selected fields using PgUp/PgDn/+/- keys. <F> keys are explained below:
 - <F1>: "Help" gives options available for each item.
 - Shift <F2>: Change color.
 - <F5>: Get the old values. These values are the values with which the user started the current session.
 - <F6>: Load all options with the BIOS Setup default values.
 - <F7>: Load all options with the Setup default values.

A short description of screen items follows:

- CPU Internal** This option enables/disables the CPU's internal Cache cache memory. (The default setting is Enabled.)
- External Cache** This option enables/disables the external cache memory. (The default setting is Enabled.)
- Quick Power On Self Test** Enabled provides a fast POST at boot-up.

3. After you have finished the BIOS Features Setup program, press the <ESC> key and follow the screen instructions to save or disregard your settings.

Chipset Features Setup

The Chipset Features Setup option changes the values of the chipset registers. These registers control system options in the computer.

Note: Change these settings only if you are familiar with the Chipset.

Run the Chipset Features Setup as follows.

1. Choose "CHIPSET FEATURES SETUP" from the Main Menu and the following screen appears. (The screen below shows default settings.)

ROM PCI / ISA BIOS CHIPSET FEATURES SETUP AWARD SOFTWARE, INC.			
Auto Configuration	: Enabled	Onboard 496B IDE Port	: Enabled
ISA Bus Clock Option	: 1/4 PCLK	IDE0 Master Mode	: Auto
LBD# Sample Point	: End of T2	IDE0 Slave Mode	: Auto
		IDE1 Master Mode	: Auto
		IDE1 Slave Mode	: Auto
		IDE Prefetch Read Buffer	: Disabled
DRAM Write Cycle	: 1 WS	Onboard FDC Control	: Enabled
DRAM Write CAS Pulse	: 2 CCLK	Onboard Serial Port 1	: COM1/3F8H
DRAM Speed	: Faster	Onboard Serial Port 2	: COM2/2F8H
		Onboard Parallel Port	: 3BC1/1RQ7
CPU Burst Write	: Disabled	Onboard Printer Mode	: Compatible
L1 Cache Policy	: Write Back		
Cache Write Cycle	: 2 CCLK		
Cache Burst Read Cycle	: 1 CCLK		
L2 Cache/DRAM Cycle WS	: 2 CCLK		
		ESC : Quit	↑ ↓ → ← : Select Item
		F1 : Help	PU/PD/+/- : Modify
		F5 : Old Values	(Shift) F2 : Color
		F6 : Load BIOS Defaults	
		F7 : Load Setup Defaults	

2. Use the arrow keys to move between items and select values. Modify selected fields using the PgUp/PgDn/+/- keys.

- Boot Sequence** The default setting attempts to first boot from drive A: and then from hard disk C:. You can reverse this sequence with "C: A:", but then drive A: cannot boot directly.
- Swap Floppy Drive** Enabled changes the sequence of the A: and B: drives. (The Default setting is Disabled.)
- Boot Up Num Lock Status** Choose On or Off. On puts numeric keypad in Num Lock mode at boot-up. Off puts this keypad in arrow key mode at boot-up.
- IDE HDD Block Mode** This option enables/disables the IDE HDD Block Mode function. Not all HDDs support this function.
- Gate A20 Option** Choose Fast or Normal. Fast allows RAM accesses above 1MB using the fast gate A20 line.
- Memory Parity Check** This option enables / disables the memory parity check function. (The Default setting is Disabled.)
- Typeomatic Rate Setting** Enable this option to adjust the keystroke repeat rate.
- Typeomatic Rate (Chars/Sec)** Choose the rate a character keeps repeating.
- Typeomatic Delay (Msec)** Choose how long after you press a key that a character begins repeating.
- Security Option** Choose Setup or System. Use this feature to prevent unauthorized system boot-up or use of BIOS Setup.
 - "System" - Each time the system is booted the password prompt appears.
 - "Setup" - If a password is set, the password prompt only appears if you attempt to enter the Setup program.
- IDE Second Channel Control** Choose Enabled or Disabled. When Enabled is set, IRQ15 is dedicated for secondary IDE use. When Disabled is set, IRQ15 is dedicated for secondary IDE use.
- Video or Adaptor BIOS Shadow** BIOS shadow copies BIOS code from slower to faster RAM. BIOS can then execute from RAM. These 32K segments can be shadowed from ROM to RAM. BIOS is shadowed in a 32K segment if it is enabled and it has BIOS present.

A short description of screen items follows:

- Auto Configuration** Enable this option (strongly recommended) and the system automatically sets all options on the left side of the screen (except cache update mode & BIOS cacheable). If this option is Enabled you must boot from Turbo mode.
- ISA Bus Clock** The default setting is 1/4 PCLK (assuming PCLK is 33 MHz.) It is recommended that you do not change this setting. This value should be close to 8MHz.
- LBD# Sample Point** Use the default setting.
- DRAM Speed** Automatically set by BIOS.
- DRAM Write Cycle** Automatically set by BIOS.
- DRAM Write CAS Pulse** Automatically set by BIOS.
- CPU Burst Write** Choose Enabled or Disabled. The default is Disabled.
- L2 Cache Policy** Choose Write-through or Write-Back. The default is Write-back.
- Cache Write Cycle** Use the default setting.
- Cache Burst Read Cycle** Use the default setting.
- L2 Cache / DRAM Cycle WS** Use the default setting.
- Onboard 496B IDE Port** Choose Enabled (default) or Disabled. The Enabled setting enables both primary and secondary IDEs. The Disabled setting turns off the primary IDE and the Secondary IDE.
- IDE 0/1 Master/Slave Mode** Choose Auto (default) or 0,1,2,3,4. The 0-4 settings are for IDE mode speed. (Mode 0 is the slowest speed, Mode 4 is the fastest). Unless you know the HDD speed, Mode 4 is the fastest). Unless you know the HDD speed, you should use the Auto setting for more reliable and better performance.

- Onboard FDC Control** Enabled: Use the on-board floppy controller (default).
Disabled: Turn off the on-board floppy controller.
- Onboard Serial Port 1** Choose serial port 1 & 2's I/O address Do not set port 1 & 2 to the same value except for Disabled.
- Onboard Serial Port 2** COM 1/3F8H | COM3/3E8H
COM 2/2F8H | COM4/2E8H (default)
- Onboard Parallel Port** Choose the printer I/O address:
3BCH/IRQ7 (default), 278H/IRQ7, 278H/IRQ5
- Onboard Printer Mode** Choose Compatible (default), Extend or EPP, ECP mode. The mode depends on your external device that connects to this port.
3. After you have finished with the Chipset Features Setup, press the <ESC> key and follow the screen instructions to save or disregard your settings.

Power Management Setup

The Power Management Setup option sets the system's power saving functions.

Run the Power Management Setup as follows.

1. Choose "POWER MANAGEMENT SETUP" from the Main Menu

ROM PCI / ISA BIOS POWER MANAGEMENT SETUP AWARD SOFTWARE, INC.		
Power Management : Disabled	IRQ3 (COM 2) : Enabled	
PM Control By APM : No	IRQ4 (COM 1) : Enabled	
Video Off Method : V/H SYNC+Blank	IRQ5 (LPT 2) : Enabled	
Suspend Switch : Enabled	IRQ6 (Floppy Disk) : Enabled	
	IRQ7 (LPT 1) : Enabled	
	IRQ8 (RTC Alarm) : Disabled	
	IRQ9 (IRQ Redir) : Enabled	
	IRQ10 (Reserved) : Enabled	
	IRQ11 (Reserved) : Enabled	
	IRQ12 (PS/2 Mouse) : Enabled	
	IRQ13 (Coprocessor) : Enabled	
	IRQ14 (Hard Disk) : Enabled	
	IRQ15 (Reserved) : Enabled	
** PM Timers **		
HDD Off After : Disabled		
Doze Mode : Disabled		
Standby Mode : Disabled		
Suspend Mode : Disabled		
** PM Events **		
PCI Master Activity : Enabled		
COM Ports Activity : Enabled		
LPT Ports Activity : Enabled		
HDD Ports Activity : Enabled		
DMA Ports Activity : Enabled		
VGA Ports Activity : Disabled		
	ESC : Quit	= -- : Select Item
	F1 : Help	PU/PD +/- : Modify
	F5 : Old Values	(Shift) F2 : Color
	F6 : Load BIOS Defaults	
	F7 : Load Setup Defaults	

2. Use the arrow keys to move between items and to select values. Modify the selected fields using the PgUp/PgDn/+/- keys.

A short description of selected screen items follows:

Power Management Options are as follows:

User Define	Let's you define the HDD and system power down times.
Disabled	Disables the Green PC Features.
Min Saving	Doze Mode = 40 Min., Standby Mode = 40 Min., Suspend Mode = 40 Min.

- PM Control by APM** Choose Yes or No (default). APM stands for Advanced Power Management. To use APM you must run "power.exe" under DOS v6.0 or later version.
- Video Off Method** When Suspend mode occurs, the monitor screen shuts off. If any IRQ event occurs, the screen comes back on.
- PM Interrupt Use** This item is only valid for Non-SMI CPUs. It is recommended that you use the default setting (IRQ12). (Assign the Non-SMI routine to a dedicated IRQ.)
- HDD Off After** When the set time has elapsed, the BIOS sends a command to the HDD to enter standby (sleep) mode, which turns off the motor. Time is adjustable from 1 to 15 minutes. The default setting is Disabled. Some older model HDDs may not support this advanced function.
- Doze Mode** When the set time has elapsed, the BIOS sends a command to the system to enter doze mode (system clock drops to 8MHz). Time is adjustable from 10 Sec to 40 min.
- Standby Mode** When the set time has elapsed, the BIOS sends a command to the system to enter Standby mode (system clock drops to 8MHz). Time is adjustable from 10 Sec to 40 min.
- Suspend Mode** When the set time has elapsed, the BIOS sends a command to the system to enter Suspend mode (system clock drops to 8MHz). Time is adjustable from 10 Sec to 40 min.
- PCI Master Activity** The hardware monitors the master signals for activity. If activity occurs from the Enabled item, the system will not enter Green mode (power saving).
- xxx Ports Activity** The hardware monitors these ports for activity. If activity occurs from the Enabled item the system will not enter Green mode (power saving).
- IRQx** The BIOS monitors these items for activity. If activity occurs from the Enabled item the system will wake up from Green mode (power saving).
3. After you have finished with the Power Management Setup, press the <ESC> key to return to the Main Menu.

PCI Configuration Setup

This option sets the mainboard's PCI Slots. Run this option as follows:

1. Choose "PCI CONFIGURATION SETUP" from the Main Menu and the following screen appears. (The screen below shows default settings.)

ROM PCI / ISA BIOS PCI CONFIGURATION SETUP AWARD SOFTWARE, INC.		
SLOT 1 Using INT #	: AUTO	
SLOT 2 Using INT #	: AUTO	
SLOT 3 Using INT #	: AUTO	
SLOT 4 Using INT #	: AUTO	
1st Available IRQ	: 9	
2nd Available IRQ	: 10	
3rd Available IRQ	: 11	
4th Available IRQ	: 12	
PCI IRQ Activated By	: Edge	
PCI IDE IRQ Map To	: PCI-AUTO	
Primary IDE INT#	: A	
Secondary IDE INT#	: B	
Master Arbitration Protocol	: Weak	
CPU -> PCI Mem Port Write Buf	: Enabled	
CPU -> PCI Memory Burst Write	: Enabled	
PCI Master Burst Read/Write	: Enabled	
	ESC : Quit	= -- : Select Item
	F1 : Help	PU/PD +/- : Modify
	F5 : Old Values	(Shift) F2 : Color
	F6 : Load BIOS Defaults	
	F7 : Load Setup Defaults	

2. Use the arrow keys to move between items and select values. Modify selected fields using the PgUp/PgDn/+/- keys.

A short description of screen items follows:

SLOT 1 (2) (3) (4)	Choose AUTO or assign PCI INT# number A, B, C or D. The default setting is AUTO. If slot 1~4 is set to AUTO in the item then the BIOS automatically routes the INT# to the specified IRQ following the 1st (2nd) (3rd) (4th) IRQ order you assign.
1st (2nd) (3rd) (4th) Available IRQ	
PCI IRQ Activated	Choose Edge or Level. Most PCI trigger By signals are Level. This setting must match the PCI card.

PCI IDE IRQ Map To	Select PCI-AUTO, ISA, or assign a PCI number (depending on which slot the PCI IDE is inserted). The default setting is PCI-AUTO. If PCI-AUTO does not work, then assign an individual PCI SLOT number.
Primary IDE INT#	Choose INTA#, INTB#, INTC#, or INTD#. The default setting is INTA#.
Secondary IDE	Choose INTA#, INTB#, INTC#, or INTD#. The default setting is INTB#.
Master Arbitration	Choose Weak (default) or Strong. Protocol Choose Weak and the CPU has 1st priority, 2nd is PCI and 3rd is Master Device. Choose Strong and the CPU, PCI, and Master Device all have the same priority.
CPU -> PCI Mem Post Write Buf	Choose Enabled or Disabled.
CPU -> PCI Mem Burst/Write	Choose Enabled or Disabled.
PCI Master Burst Read/Write	Choose Enabled or Disabled.

3. After you have finished with the PCI Slot Configuration, press the <ESC> key and follow the screen instructions to save or disregard your settings.

Load Setup Defaults

This item loads the system values you have previously saved. Choose this item and the following message appears:

"Load SETUP Defaults (Y/N)? N"

To use the SETUP defaults, change the prompt to "Y" and press <<Enter>>.

Password Setting

This Main Menu item lets you configure the system so that a password is required every time the system boots or an attempt is made to enter the Setup program. Change the password as follows:

1. Choose "PASSWORD SETTING" in the Main Menu and press <Enter>. The following message appears:<R>
"Enter Password:"
2. Enter a password and press <<Enter>>. (If you do not wish to use the password function, you can just press <Enter> and a "Password disabled" message appears.)
3. After you enter your password, the following message appears prompting you to confirm the new password:<R>
"Confirm Password:"
4. Re-enter your password and then press <<ESC>> to exit to the Main Menu.

Important: If you forget or lose the password, the only way to access the system is to set jumper JP5 to clear the CMOS RAM. All setup information is lost and you must run the BIOS setup program again.

IDE HDD Auto Detection

This Main Menu item automatically detects the hard disk type and configures the STANDARD CMOS SETUP accordingly.

Note: This function is only valid for IDE hard disks.

ROM PCI / ISA BIOS
CMOS SETUP UTILITY
AWARD SOFTWARE, INC.

HARD DISKS	TYPE	SIZE	CYL.S	HEADS	PRECOMP	LANDZ	SECTORS	MODE
Primary Master	: User	544	528	32	0	1056	63	LBA
Primary Slave	: None	0	0	0	0	0	0	---
Secondary Master	: None	0	0	0	0	0	0	---
Secondary Slave	: None	0	0	0	0	0	0	---

Do you accept this drive C (Y/N) ? N

ESC : Skip