

Notice to End Users

This User's Guide & Technical Reference is for assisting system manufacturers and end users in setting up and installing the mainboard.

Every effort has been made to ensure that the information in this manual is accurate. Soltek Computer Inc. is not responsible for printing or clerical errors. Information in this document is subject to change without notice and does not represent a commitment on the part of Soltek Computer Inc.

No part of this manual may be reproduced, transmitted, translated into any language in any form or by any means, electronic or mechanical, including photocopying and recording, for any purpose without the express written permission of Soltek Computer Inc.

Companies and products mentioned in this manual are for identification purposes only. Product names appearing in this manual may or may not be registered trademarks or copyrights of their respective companies.

SOLTEK COMPUTER INC. PROVIDES THIS MANUAL "AS IS" WITHOUT WARRANTY OF ANY KIND, EITHER EXPRESS OR IMPLIED, INCLUDING BUT NOT LIMITED TO THE IMPLIED WARRANTIES OR CONDITIONS OF MERCHANTABILITY OR FITNESS FOR A PARTICULAR PURPOSE. IN NO EVENT SHALL SOLTEK COMPUTER INC. BE LIABLE FOR ANY LOSS OR PROFITS, LOSS OF BUSINESS, LOSS OF USE OR DATA, INTERRUPTION OF BUSINESS, OR FOR INDIRECT, SPECIAL, INCIDENTAL, OR CONSEQUENTIAL DAMAGES OF ANY KIND, EVEN IF SOLTEK COMPUTER INC. HAS BEEN ADVISED OF THE POSSIBILITY OF SUCH DAMAGES ARISING FROM ANY DEFECT OR ERROR IN THIS MANUAL OR PRODUCT.

© Copyright 1996 Soltek Computer Inc. All right reserved

Edition: JULY 1996
Version: 2.0
SL-52D2/D5 SERIAL
SL-52E2/E5 SERIAL

Contents

Chapter 1: Introduction	1
Features	2
Mainboard Layout with Default Settings	3
Chapter 2: Hardware Setup	4
CPU Type Configuration	5
CPU 1.5X Clock Setting (Red Caps)	5
Pentium – 75/90/100 MHz	5
CPU 2.0X Clock Setting (Red Caps)	6
Pentium – 120/133 MHz	6
CPU 2.5X Clock Setting (Red Caps)	7
Pentium – 150/166 MHz	7
CPU 3.0X Clock Setting (Red Caps)	7
Pentium – 180/200 MHz	7
JP14: Cache Memory Select	8
CPU Voltage Setting	9
Single Voltage Setting: Intel P54C, Cyrix 6x86, AMD K5/SSA5	9
Dual Voltage Setting: Intel P55C, Cyrix 6x86(L), M2, AMD K5/SSA5 (Green Caps)	9
System Memory Configuration	10
Jumper Settings	11
Factory Fixed Jumpers	11
JP12: Monitor Selection	11
JP17, JP18: Bus Ratio Select	12

JP3: Clear CMOS Data -----	13
JP8: ISA Clock Select -----	13
JP21, JP23: External Bus Frequency Select -----	14
JP5, JP6, JP7, JP9: CPU Vcc Voltage Select -----	15
Intel P54C/CTB, AMD K5 (PR75 ~ PR133), and Cyrix 6x86 -----	15
Intel P55C, Cyrix 6x86(L), M2, AMD K5 (Over PR166), Vcore 2.8V-----	15
Intel P55C, Cyrix 6x86(L), M2, AMD K5 (Over PR166), Vcore 2.5V-----	16
Connectors -----	16
KB1: Keyboard Connector -----	16
PS/2 Mouse Connector-----	16
LPT1: Parallel Port -----	17
COM1 /COM2: Serial Port Connectors -----	17
FDC1: Floppy Drive Connector -----	18
IDE1/IDE2: Primary/Secondary IDE Connectors-----	18
Power Connector -----	19
J3: Reset Switch -----	20
J2: Keylock Switch -----	20
J1: Speaker Connector-----	20
J4: IDE LED Activity Light-----	20
IR1: Infrared Port Module Connector-----	21
USB1: USB Connector -----	21

Chapter 3: BIOS Setup ----- 22

Standard CMOS Setup -----	23
BIOS Features Setup -----	25
Chipset Features Setup -----	28
Power Management Setup -----	31
PnP/PCI Configuration Setup -----	33
Load Setup Defaults -----	34
Integrated Peripherals -----	35
Supervisor/User Password -----	38

IDE HDD Auto Detection -----	39
Save & Exit Setup -----	39
Exit Without Saving -----	39

Chapter 1

Introduction

The 82430VX motherboard is a high performance system hardware based on the Intel Pentium® processor and is equipped with four PCI slots, four standard ISA slots, Super Multi I/O controller, and dual ports PCI IDE connectors for future expansion. The hardware dimension is 220mm x 280mm with four layer design technology.

Features

- Supports Intel Pentium®/P55C, AMD K5 CPU at 75 ~ 166 MHz, and Cyrix 6x86(L)/M2 CPU at P120+ ~ P166+ MHz on a ZIF Socket 7
- Intel 82430 VX chipset, PCI 2.1 compliant
- Supports dual USB ports
- Supports SDRAM 3.3V/Unbuffered Type (Optional)
- Supports 256K/512K write back cache with Pipeline Burst SRAMs
- Supports up to 128 MB DRAM (Min. 4MB) onboard and BIOS AUTO SPM/EDO/SDRAM DRAM table free configuration
- Supports two independent high performance PCI Bus Master IDE interface
- Supports four 32 bits master PCI slots, four 16 bits ISA slots, and an jumperless PCI INT# Control Scheme
- 1 floppy port, 1 parallel port (EPP, ECP port), and 2 serial ports (16550 Fast UART compatible)
- Supports PS/2 mouse connector
- Supports Award Plug & Play BIOS with Flash Memory
- Supports CPU Hardware Green function.
- Supports Infrared interface (optional)
- Supports 120MHz IDE Floppy and SCSI Boot function.

Note: Make sure that the SDRAM module not only has to be 168 pin DIMM but designed for 3.3V SDRAM as well. Double check with the SDRAM supplier before install any SDRAMs. The mainboard manufacturer has no obligation to any damage of the board by using the incorrect specification of SDRAM.

Mainboard Layout with Default Settings

The following figure is the default settings for single voltage of the Intel 100/66 with the 256K cache. For the best cooling effect, make sure the airflow from the CPU fan is facing to the heatsink.

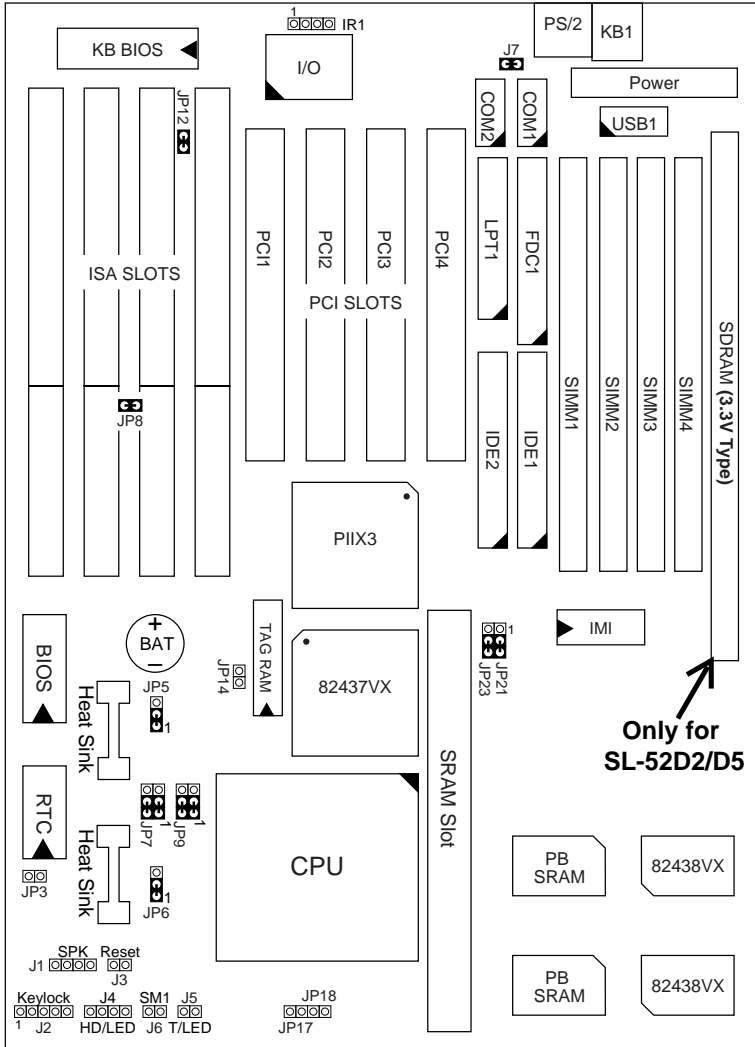

Figure 1-1. SL-52D2/D5/E2/E5 Motherboard Layout

Chapter 2

Hardware Setup

This chapter includes sections of setting up jumpers on the motherboard, the system memory configuration, the cache memory configuration, and attaching the connectors. Refer back to this chapter when you need to upgrade or reconfigure your system and remember to turn off the power of the system as well as all peripheral devices before performing any work on the system.

Symbols used in this chapter are described below:

For 2-pin jumper:



– Close the jumper by inserting the jumper cap over the two pins of the jumper.



– Open the jumper by removing the jumper cap.

For 3-pin jumper:

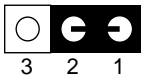

– Close pins 1 and 2 with an jumper cap.

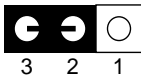

– Close pins 2 and 3 with an jumper cap.

CPU Type Configuration

Set the motherboard jumpers JP5, JP6, JP7, JP8, JP9, JP17, JP18, JP21, and JP23 according to the CPU type as shown in the following figures.

CPU 1.5X Clock Setting (Red Caps)

Pentium – 75/90/100 MHz

AMD K5 – PR75/PR90/PR100/PR120/PR133 MHz

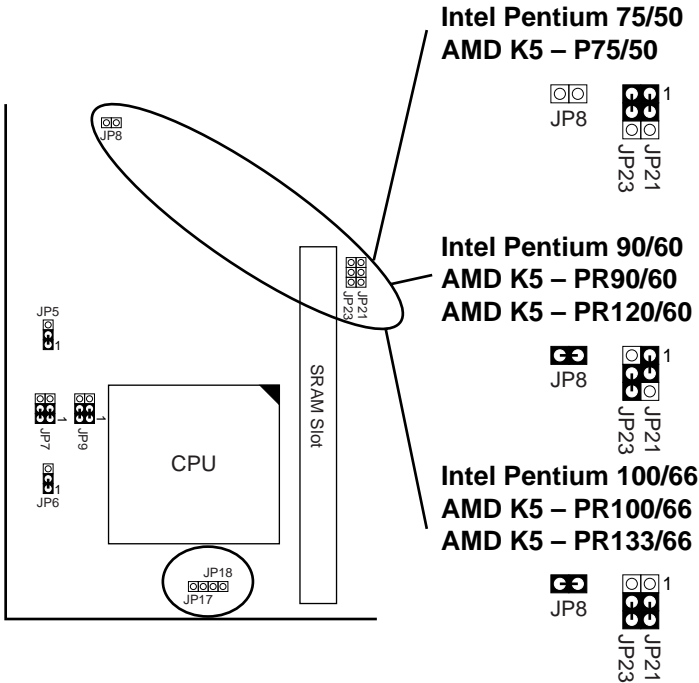

Figure 2–1. CPU Type Configuration

CPU 2.0X Clock Setting (Red Caps)

Pentium – 120/133 MHz

Cyrix 6x86(L) – P120+/P133+/P150+/P166+

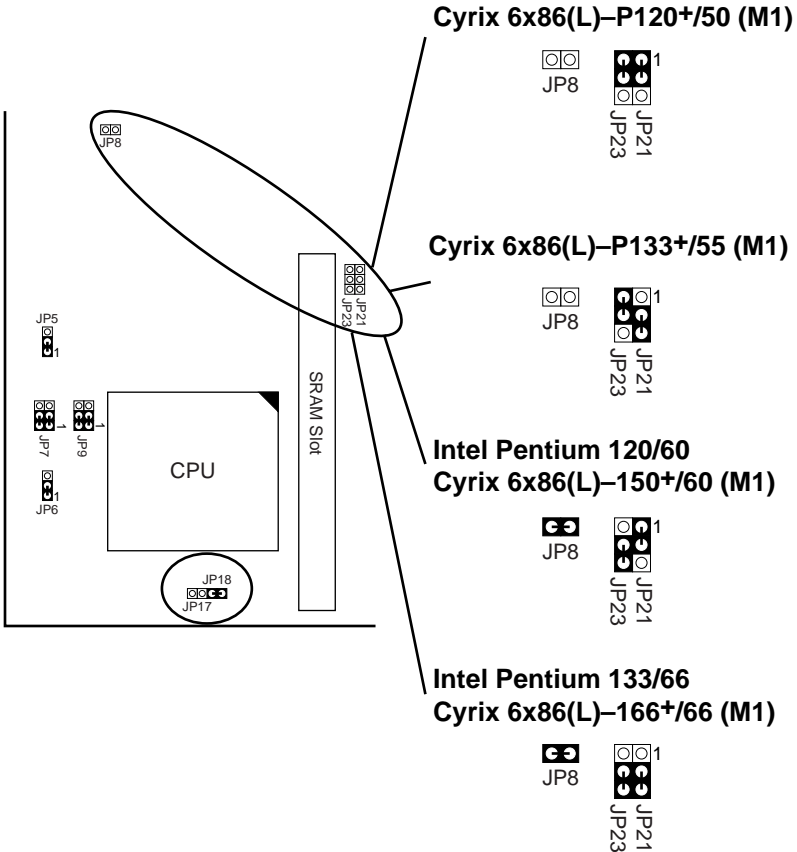

Figure 2–2. CPU Type Configuration

Note: The settings of JP5, JP6, JP7, and JP9 are for the single voltage CPUs. You must change these jumpers to the correct setting (dual voltage) for P55C(MMX)/6x86L, refer to page 15.

CPU 2.5X Clock Setting (Red Caps)

Pentium – 150/166 MHz

AMD K5 – PR150/RP166 MHz

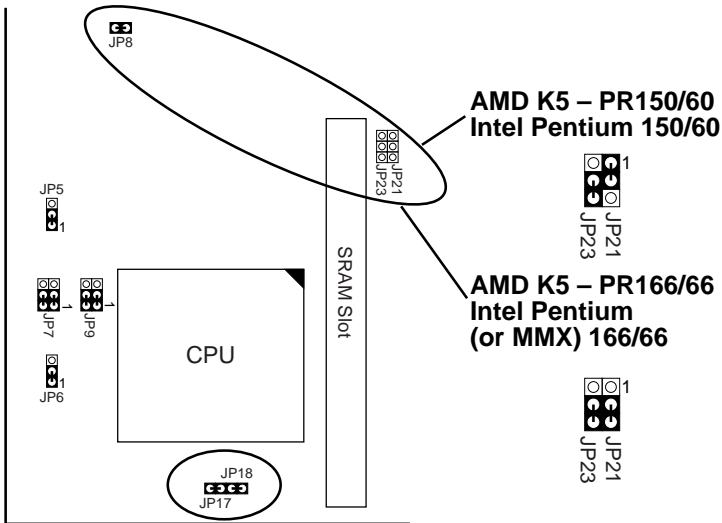

Figure 2–3. CPU Type Configuration

CPU 3.0X Clock Setting (Red Caps)

Pentium – 180/200 MHz

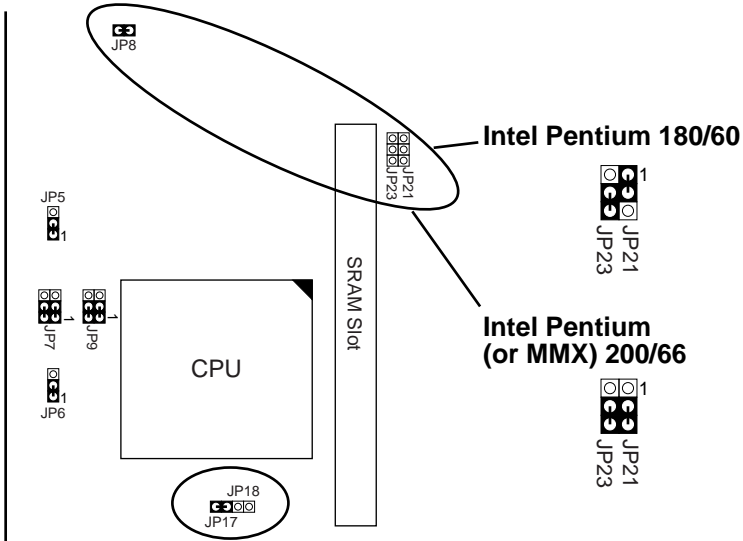
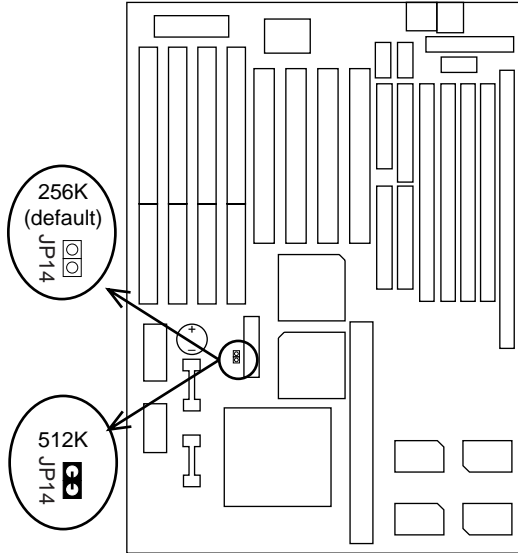

Figure 2–4. CPU Type Configuration

JP14: Cache Memory Select

The board has 256K installed and this jumper is set open. If you want to upgrade to 512K, you need to short this jumper and add another 256K module.

Notice that the color of the cap is WHITE.



Note: Contact your board manufacturer for the Pipelined burst module information in order to get the best compatibility and stability of the board.

CPU Voltage Setting

Single Voltage Setting: Intel P54C, Cyrix 6x86, AMD K5/SSA5 (Green Caps)

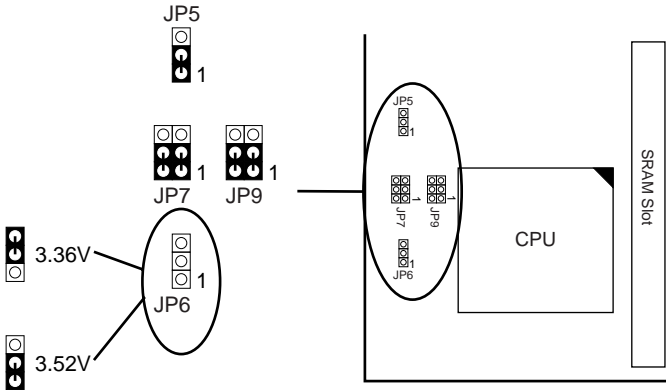

Figure 2-5-1. CPU Type Configuration

Dual Voltage Setting: Intel P55C, Cyrix 6x86(L), M2, AMD K5/SSA5 (Green Caps)

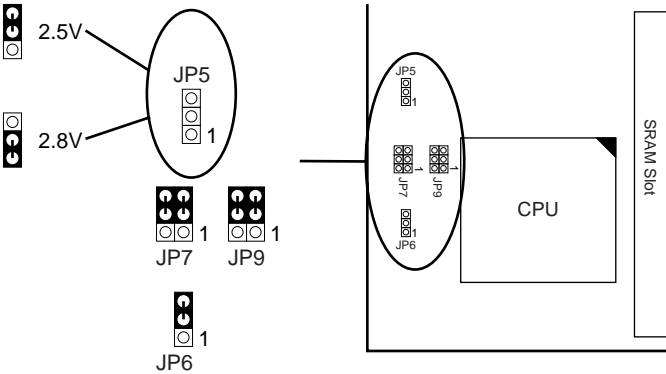

Figure 2-5-2. CPU Type Configuration

System Memory Configuration

This 82430VX motherboard supports 72-pin SIMMs of 4MB, 8MB, 16MB, or 32MB to form a memory size between 8MB to 128MB. Follow the chart below to install the memory modules.

Bank 0 SIMM 3 & 4	Bank 1 SIMM 1 & 2	Total Memory
4MB x 2	None	8MB
8MB x 2	None	16MB
16MB x 2	None	32MB
32MB x 2	None	64MB
None	4MB x 2	8MB
None	8MB x 2	16MB
None	16MB x 2	32MB
None	32MB x 2	64MB
4MB x 2	4MB x 2	16MB
4MB x 2	8MB x 2	24MB
4MB x 2	16MB x 2	40MB
4MB x 2	32MB x 2	72MB
8MB x 2	4MB x 2	24MB
8MB x 2	8MB x 2	32MB
8MB x 2	16MB x 2	48MB
8MB x 2	32MB x 2	80MB
16MB x 2	4MB x 2	40MB
16MB x 2	8MB x 2	48MB
16MB x 2	16MB x 2	64MB
16MB x 2	32MB x 2	96MB
32MB x 2	4MB x 2	72MB
32MB x 2	8MB x 2	80MB
32MB x 2	16MB x 2	96MB
32MB x 2	32MB x 2	128MB

- Note:*
1. You can't install any RAM module in SIMM 3 & 4 when you use SDRAM.
 2. The 82430VX chipset supports "table free" function and the above table is just a reference.

Jumper Settings

Factory Fixed Jumpers

The following jumpers are set by the factory. Notice that the color of these two caps are BLACK.

Jumpers	Factory settings
JP6, JP5	Factory fixed at 2-3
J7	Factory fixed at Short

JP12: Monitor Selection

Set JP12 to select the either a color or monochrome monitor.





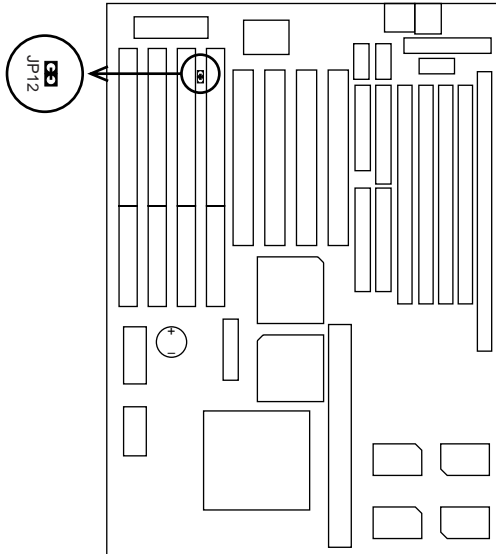



Monitor Type	JP12
Monochrome	Open
Color (default)	Close

Notice that the color of the cap is BLACK.



JP17, JP18: Bus Ratio Select

Set these jumpers according to your CPU clock.

Ratio	JP17	JP18
1.5X (default)		
2X		
2.5X		
3X		

Notice that the color of the cap is RED.

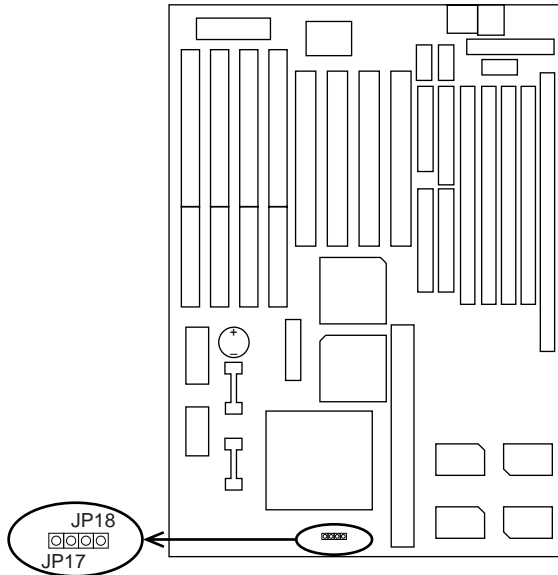

JP3: Clear CMOS Data

Clear the CMOS memory by shorting this jumper momentarily; then remove the cap to retain new settings.

COMS Data	JP3
Clear Data	Close
Retain Data (default)	Open

JP8: ISA Clock Select

This jumper sets the ISA clock of different CPUs.





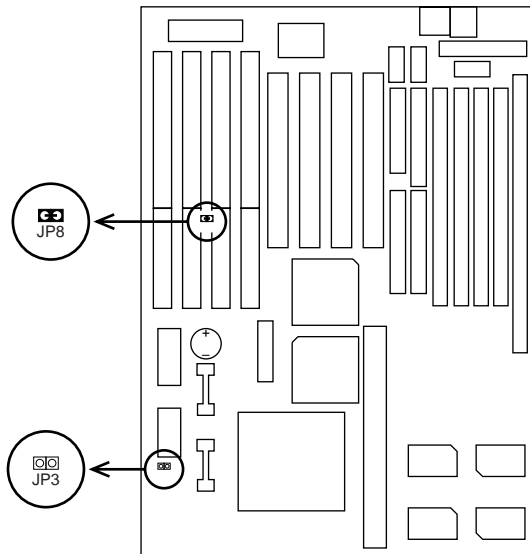



Clock	JP8
PCI Clock /3	Open
PCI Clock /4	Close

Notice that the cap color of JP8 is RED.



JP21, JP23: External Bus Frequency Select

These 2 jumpers tells the clock generator what frequency to send to the CPU. Set these jumpers as shown, according to the CPU's internal clock speed. (For IMI Clock Generator.)

Settings	JP23	JP21
50MHz		
55MHz		
60MHz		
66MHz (default)		

Notice that the color of the cap is RED.

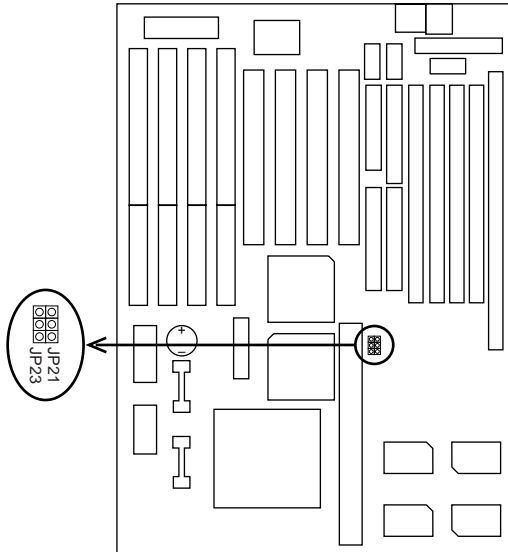

JP5, JP6, JP7, JP9: CPU Vcc Voltage Select

Intel P54C/CTB, AMD K5 (PR75 ~ PR133), and Cyrix 6x86 Single Voltage

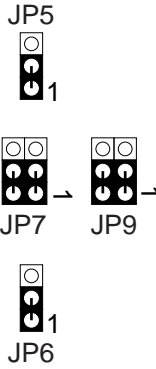

Intel P55C, Cyrix 6x86(L), M2, AMD K5 (Over PR166), V_{CORE} 2.8V Dual Voltage

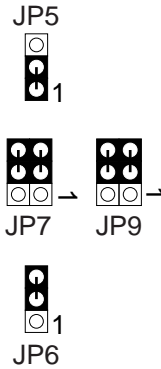

Note: Cyrix 6x86L Vcore is 2.8V at moment.

Intel P55C, Cyrix 6x86(L), M2, AMD K5 (Over PR166), V_{CORE} 2.5V

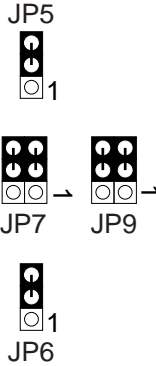

Connectors

KB1: Keyboard Connector

A 5-pin female DIN keyboard connector is located at the upper right corner of the motherboard. Plug the keyboard jack direct to this connector.

PS/2 Mouse Connector

Attach PS/2 mouse cable to this 6-pin connector.

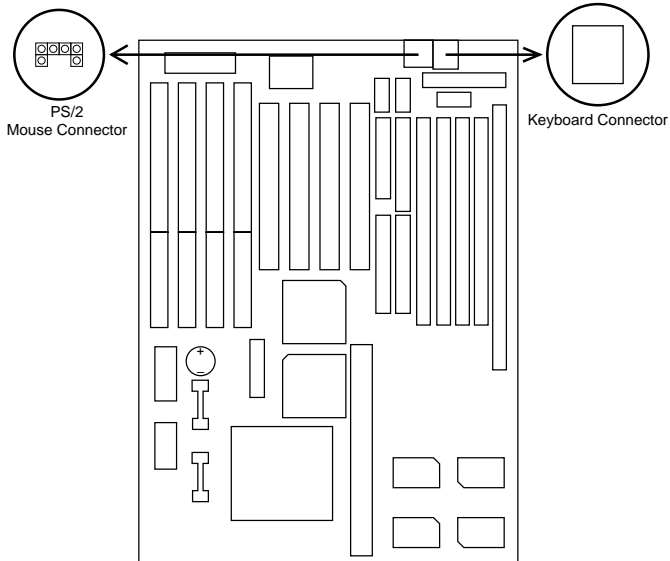

LPT1: Parallel Port

The system board provides a 2x13-pin parallel port connector, LPT1. Attach parallel port cable to this connector.

COM1 /COM2: Serial Port Connectors

The system board has two 2x5-pin serial port connectors, COM1 and COM2. Attach COM1/COM2 cables to these connectors.

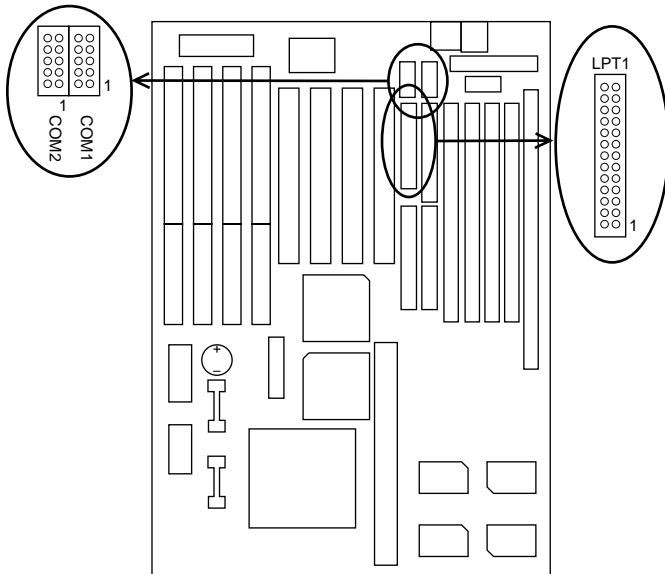

FDC1: Floppy Drive Connector

The system board has a 2x17-pin floppy drive connector, FDC1. Connect one end of a floppy drive cable to this connector and the other end to a floppy drive.

IDE1/IDE2: Primary/Secondary IDE Connectors

The system board has a 32-bit Enhanced PCI IDE Controller that provides for two HDD connectors, IDE1 (primary) and IDE2 (secondary).

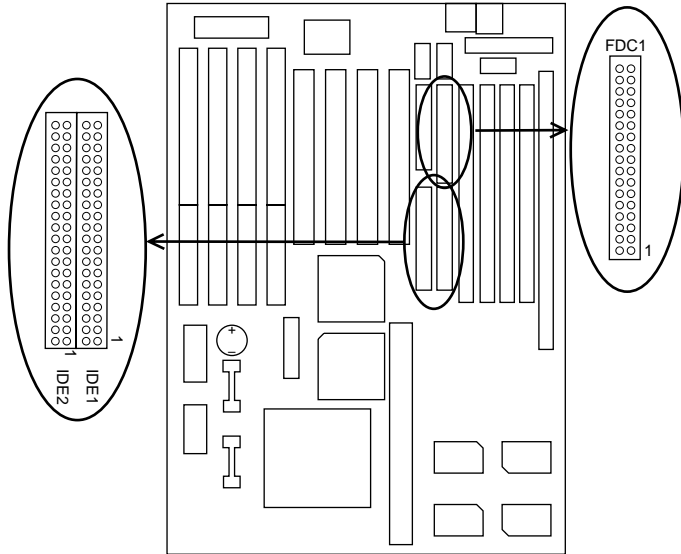

Power Connector

The power connector has two 6-pin male header connectors. Plug the dual connectors from the power directly onto the board connector while making sure the black leads are in the center.

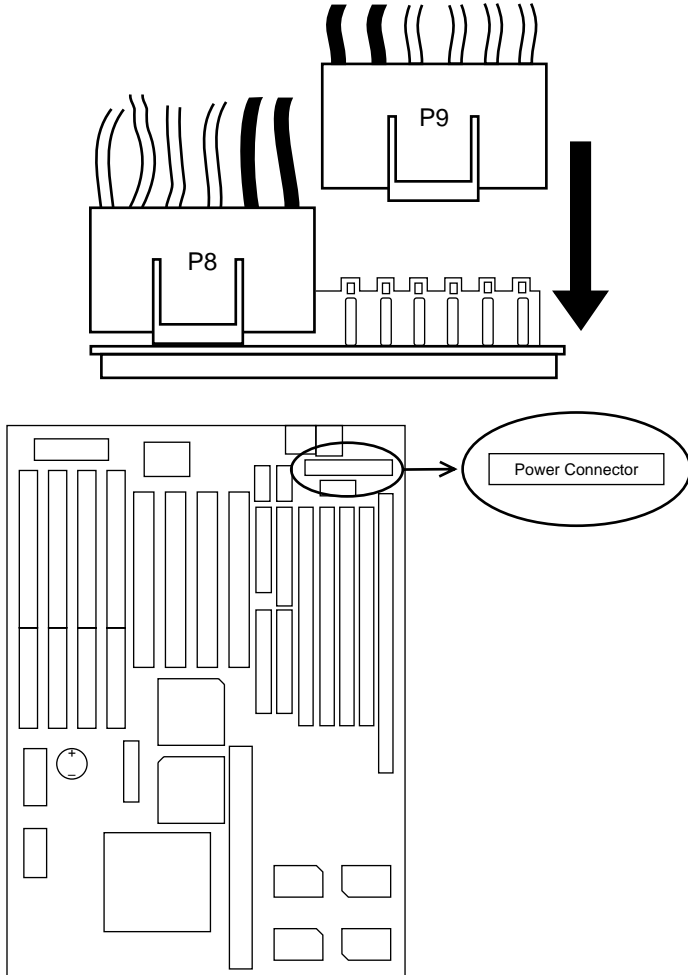

J3: Reset Switch

The system board has a 2-pin connector for rebooting your computer without having to turn off your power switch. This prolongs the life of the system's power supply.

J2: Keylock Switch

The keylock switch is a 5-pin connector for locking the keyboard for security purposes. (See the following drawing for jumper position, and pin1~3 is connected to power LED and pin 4~5 is connected to keylock switch.)

J1: Speaker Connector

The speaker connector is a 4-pin connector for connecting the system and the speaker. (See the following drawing for jumper position.)

J4: IDE LED Activity Light

This connector connects to the hard disk activity indicator light on the case.

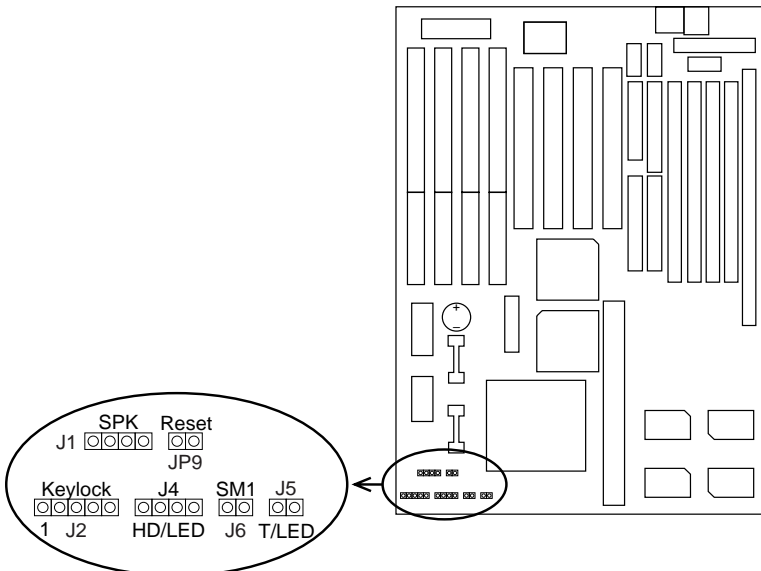

IR1: Infrared Port Module Connector

The system board provides a 4-pin infrared connector—IR1 as an optional module for wireless transmitting and receiving. Pin 1 through 4 are Receive, GND, Transmit, and Vcc, respectively.

USB1: USB Connector

This jumper connects to the USB cable to provide USB device.

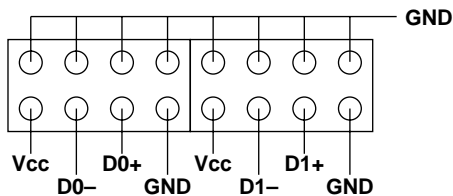
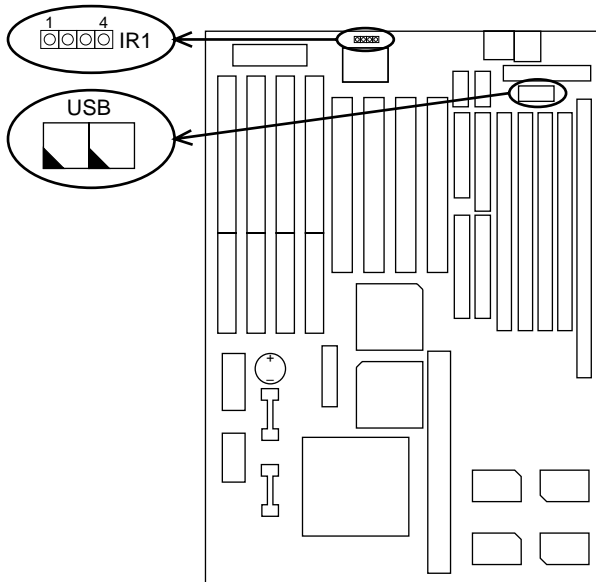

Chapter 3

Award BIOS Setup

This 82430VX motherboard comes with the AWARD BIOS from AWARD Software Inc. Enter the Award BIOS program's Main Menu as follows:

1. Turn on or reboot the system.

After a series of diagnostic checks, the following message will appear:

PRESS TO ENTER SETUP

2. Press the key and the main program screen appears as in the following page.

ROM PCI/ISA BIOS CMOS SETUP UTILITY AWARD SOFTWARE, INC.	
STANDARD CMOS SETUP	INTEGRATED PERIPHERALS
BIOS FEATURES SETUP	SUPERVISOR PASSWORD
CHIPSET FEATURES SETUP	USER PASSWORD
POWER MANAGEMENT SETUP	IDE HDD AUTO DETECTION
PNP/PCI CONFIGURATION	SAVE & EXIT SETUP
LOAD SETUP DEFAULTS	EXIT WITHOUT SAVING
Esc : Quit	↑ ↓ → ← : Select Item
F10 : Save & Exit Setup	(Shift) F2 : Change Color
Time, Date, Hard Disk Type...	

- Using one of the arrows on your keyboard to select an option and press <Enter>. Modify the system parameters to reflect the options installed in the system.
- You may return to the Main Menu anytime by press <ESC>.
- In the Main Menu, "SAVE AND EXIT SETUP" saves your changes and reboots the system, and "EXIT WITHOUT SAVING" ignores your changes and exits the program.

Standard CMOS Setup

Standard CMOS Setup allows you to record some basic system hardware configuration and set the system clock and error handling. You only need to modify the configuration values of this option when you change your system hardware configuration or the configuration stored in the CMOS memory got lost or damaged.

Run the Standard CMOS Setup as follows:

- Choose "STANDARD CMOS SETUP" from the Main Menu and a screen with a list of options appears.

ROM PCI/ISA BIOS
STANDARD CMOS SETUP
AWARD SOFTWARE, INC.

Date (mm:dd:yy) : Thu, May 9 1996																		
Time (hh:mm:ss) : 15 : 45 : 10																		
<u>HARD DISKS</u>	<u>TYPE</u>	<u>SIZE</u>	<u>CYLS</u>	<u>HEAD</u>	<u>PRECOMP</u>	<u>LANDZ</u>	<u>SECTOR</u>	<u>MODE</u>										
Primary Master	: Auto	0	0	0	0	0	0	Auto										
Primary Slave	: Auto	0	0	0	0	0	0	Auto										
Secondary Master	: Auto	0	0	0	0	0	0	Auto										
Secondary Slave	: Auto	0	0	0	0	0	0	Auto										
Drive A : 1.44M, 3.5 in.			<table border="1"> <tr> <td>Base Memory:</td> <td>640K</td> </tr> <tr> <td>Extended Memory:</td> <td>15360K</td> </tr> <tr> <td>Other Memory:</td> <td>384K</td> </tr> <tr> <td colspan="2">Total Memory: 16384K</td> </tr> </table>						Base Memory:	640K	Extended Memory:	15360K	Other Memory:	384K	Total Memory: 16384K			
Base Memory:	640K																	
Extended Memory:	15360K																	
Other Memory:	384K																	
Total Memory: 16384K																		
Drive B : None																		
Floppy 3 Mode Support : Disabled																		
Video : EGA/VGA																		
Halt On : All Errors																		
<table border="0"> <tr> <td>Esc : Quit</td> <td>↑ ↓ → ←</td> <td>: Select Item</td> <td>PU/PD/+/-</td> <td>: Modify</td> </tr> <tr> <td>F1 : Help</td> <td>(Shift) F2</td> <td>: Change Color</td> <td></td> <td></td> </tr> </table>									Esc : Quit	↑ ↓ → ←	: Select Item	PU/PD/+/-	: Modify	F1 : Help	(Shift) F2	: Change Color		
Esc : Quit	↑ ↓ → ←	: Select Item	PU/PD/+/-	: Modify														
F1 : Help	(Shift) F2	: Change Color																

- Use one of the arrow keys to move between options and modify the selected options by using PgUp/PgDn/+/- keys.

A short description of screen options follows:

Date (mm:dd:yy)	Set the current date and time.
Time (hh:mm:ss)	
Primary (Secondary) Master/Slave	This field records the specifications for all non-SCSI hard disk drives installed in your system. Refer to the respective documentation on how to install the drivers.
Drive A/B	Set this field to the types of floppy disk drives installed in your system. The choices are: 360KB, 5.25 in., 1.2MB, 5.25 in., 720KB, 3.5 in., 1.44M, 3.5 in. (default), 2.88MB, 3.5 in., or None 120MB, 3.5in. (Auto detect).
Floppy 3 Mode Support	Drive A/B, Both: Enabled 3.5-inch, 1.2MB function. Disabled (default): Disabled 3.5-inch, 1.2MB function.
Video	Set this field to the type of video display card installed in the system. The choices are: Monochrome; Color 40x25; VGA/EGA (default); or Color 80x25
Halt On	Set this field to the type of errors that will cause the system to halt. The choices are: All Errors (default); No Errors; All, But Keyboard; All, But Diskette; or All, But Disk/Key

3. Press <ESC> to return to the Main Menu when you finish setting up in the "Standard CMOS Setup".

BIOS Features Setup

BIOS Features Setup allows you to improve your system performance or set up some system features according to your preference.

Run the BIOS Features Setup as follows:

1. Choose "BIOS FEATURES SETUP" from the Main Menu and a screen with a list of options appears.

```
ROM PCI/ISA BIOS
BIOS FEATURES SETUP
AWARD SOFTWARE, INC.
```

CPU Internal Cache	: Enabled	Video BIOS Shadow	: Enabled
External Cache	: Enabled	C8000-CBFFF Shadow	: Disabled
Quick Power on Self Test	: Enalbed	CC000-CFFFF Shadow	: Disabled
Boot Sequence	: A,C, SCSI	D0000-D3FFF Shadow	: Disabled
Swap Floppy Drive	: Disabled	D4000-D7FFF Shadow	: Disabled
Boot Up Floppy Seek	: Disabled	D8000-DBFFF Shadow	: Disabled
Boot Up NumLock Status	: On	DC000-DFFFF Shadow	: Disabled
Gate A20 Option	: Fast		
Typematic Rate Setting	: Disabled		
Typematic Rate (Chars/Sec)	: 6	ESC : Quit	↑ ↓ → ← : Select Item
Typematic Delay (Msec)	: 250	F1 : Help	PU/PD/+/- : Modify
Security Option	: Setup	F5 : Old Values (Shift)	F2 : Color
PCI/VGA Palette Snoop	: Disabled	F6 : Load BIOS Defaults	
OS/2 Select for DRAMs>64MB	: Non-OS/2	F7 : Load Setup Defaults	

2. Use one of the arrow keys to move between options and modify the selected options by using PgUp/PgDn/+/- keys. An explanation of the <F> keys follows:

<F1>: "Help" gives options available for each item.

Shift <F2>: Change color.

<F5> : Get the previous values. These values are the values with which the user started the current session.

<F6>: Load all options with the BIOS default values.

<F7>: Load all options with the Setup default values.

A short description of screen options follows:

CPU Internal Cache	Choose Enabled (default) or Disabled. This option allows you to enable or disable the CPU's internal cache.
External Cache	Choose Enabled (default) or Disabled. This option allows you to enable or disable the external cache memory.
Quick Power On Self Test	Choose Enabled (default) or Disabled. This option allows you to speed up the Power On Self Test routine.
Boot Sequence	Default is "A, C, SCSI". This option determines which drive to look for first for an operating system.
Swap Floppy Drive	Choose Enabled or Disabled (default). This option swaps floppy drive assignments when it is enabled.
Boot Up Floppy Seek	Enabled: During POST, BIOS checks the track number of the floppy disk drive to see whether it is 40 or 80 tracks. Disabled (default): During POST, BIOS will not check the track number of the floppy disk drive.
Boot Up NumLock Status	Choose On (default) or Off. This option lets user to activate the NumLock function at boot-up.

Gate A20 Option	Choose Normal or Fast (default). This option allows the RAM to access the memory above 1MB by using the fast gate A20 line.
Typematic Rate Setting	Choose Enabled or Disabled (default). Enable this option to adjust the keystroke repeat rate.
Typematic Rate (Chars/Sec)	Range between 6 (default) and 30 characters per second. This option controls the speed of repeating keystrokes.
Typematic Delay (Msec)	Choose 250 (default), 500, 750, and 1000. This option sets the time interval for displaying the first and the second characters.
Security Option	Choose System or Setup (default). This option is to prevent unauthorized system boot-up or use of BIOS Setup.
PCI/VGA palette Snoop	Choose Enabled or Disabled (default).
Video BIOS Shadow	Enabled (default): Map the VGA BIOS to system RAM. Disabled: Don't map the VGA BIOS to system RAM.
C8000-CBFFF to DC000-DFFF Shadow	These options are used to shadow other expansion card ROMs.

3. Press <ESC> and follow the screen instructions to save or disregard your settings.

Chipset Features Setup

Chipset Features Setup changes the values of the chipset registers. These registers control the system options.

Run the Chipset Features Setup as follows:

1. Choose "CHIPSET FEATURES SETUP" from the Main Menu and a screen with a list of options appears.

```
ROM PCI/ISA BIOS
CHIPSET FEATURES SETUP
AWARD SOFTWARE, INC.

Auto Configuration      : Enabled
DRAM Timing             : 70 ns

DRAM RAS# Precharge Time : 4
DRAM R/W Leadoff Timing  : 6
Fast RAS# To CAS# Delay  : 3
DRAM Read Burst Timing   : x333/x444
DRAM Write Burts Timing  : x333
Fast MA to RAS# Delay CLK: 1
Fast EDO Path Select     : Disabled
Refresh RAS# Assertio   : 5 Clks
ISA Bus Clock            : PCICLK/4

System BIOS Cacheable   : Disabled
Video BIOS Cacheable    : Disabled
8 Bit I/O Recovery Time : 3
16 Bit I/O Recovery Time: 2
Memory Hole At 15M-16M  : Disabled
Peer Concurrency        : Enabled
Chipset NA# Asserted    : Enabled

ESC : Quit      ↑ ↓ → ← : Select Item
F1  : Help      PU/PD/+/- : Modify
F5  : Old Values (Shift)F2 : Color
F6  : Load BIOS Defaults
F7  : Load Setup Defaults
```

2. Use one of the arrow keys to move between options and modify the selected options by using PgUp/PgDn/+/- keys.

A short description of screen options follows:

Auto Configuration Choose Enabled (default) or Disabled. The system sets all options on the left side of the screen automatically when choose Enabled.

DRAM Timing Choose 60ns or 70ns (default). Do not change this setting unless you know the DRAM access time spec.

DRAM RAS# Precharge Time	Use the default setting. This option allows you to determine the number of the CPU clocks allocated for the RAS to accumulate / charge it before the DRAM is refreshed.
DRAM R/W Leadoff Timing	Default is 6.
Fast RAS To CAS Delay	Use the default setting. This setup option allows you to determine the delay time in completing the transition from RAS to CAS.
DRAM Read Burst DRAM Write Burst Timing (EDO/FPM)	Use the default setting. Burst read / write requests are generated by the CPU in four separate parts. The 1st part provides the location within the DRAM where the read or write is to take place while the remaining three parts provide the actual data. The lower the timing number is, the faster the system memory will be addressed.
Fast MA to RAS# Delay CLK	Default is 1.
Fast EDO Path Select	Choose Enabled or Disabled (default).
Refresh RAS# Assertion	Default is 5 Clks.
ISA Bus Clock	Default is PCICLK / 4.
System BIOS Cacheable	Choose Enabled or Disabled (default).
Video BIOS Cacheable	Choose Enabled or Disabled (default).

8 Bit I/O Recovery Time Select Item	This delay happens when the CPU is running so much faster than the I/O bus that the CPU must be delayed to allow for the completion of the I/O.
16 Bit I/O Recovery Time Select Item	The choices for 8 bit I/O are NA, 1 to 8 CPU clock. Default is 3. The choices for 16 bit I/O are NA, 1 to 4 CPU clock. Default is 2.
Memory Hole At 15M-16M	Choose Enabled or Disabled (default). In order to improve performance, certain space in memory can be reserved for ISA cards. This memory must be mapped into the memory's space below 16MB.
Peer Concurrency	Choose Enabled (default) or Disabled.
Chipset NA# Asserted	Enabled (default) : Enable CPU pipeline function. Disabled: Disable CPU pipeline function.

3. Press <ESC> and follow the screen instructions to save or disregard your settings.

Power Management Setup

Power Management Setup sets the system's power saving functions.

1. Choose "POWER MANAGEMENT SETUP" from the Main Menu and a screen with a list of options appears.

ROM PCI/ISA BIOS POWER MANAGEMENT SETUP AWARD SOFTWARE, INC.	
Power Management	: Disabled
PM Control by APM	: No
Video Off Method	: V/H SYNC+Blank
Modem Use IRQ	: 3
Doze Mode	: Disabled
Standby Mode	: Disabled
Suspend Mode	: Disabled
HDD Power Down	: Disabled
** Wake Up Events In Doze & Standby **	
IRQ3 (Wake-Up Event)	: ON
IRQ4 (Wake-Up Event)	: ON
IRQ8 (Wake-Up Event)	: ON
IRQ12 (Wake-Up Event)	: ON
** Power Down & Resume Events **	
IRQ 3 (COM 2)	: ON
IRQ 4 (COM 1)	: ON
IRQ 5 (LPT 2)	: ON
IRQ 6 (Floppy Disk)	: ON
IRQ 7 (LPT 1)	: ON
IRQ 8 (RTC Alarm)	: OFF
IRQ 9 (IRQ2 Redir)	: ON
IRQ 10 (Reserved)	: ON
IRQ 11 (Reserved)	: ON
IRQ 12 (PS/2 mouse)	: ON
IRQ 13 (Coprocessor)	: ON
IRQ 14 (Hard Disk)	: ON
IRQ 15 (Reserved)	: ON
ESC : Quit ↑ ↓ → ← : Select Item	
F1 : Help PU/PD/+/- : Modify	
F5 : Old Values (Shift)F2 : Color	
F6 : Load BIOS Defaults	
F7 : Load Setup Defaults	

2. Use one of the arrow keys to move between options and modify the selected options by using PgUp/PgDn/+/- keys.

A short description of screen options follows:

Power Management Choose Max. Saving, User Define, Disabled (default), or Min Saving.

PM Control by APM Choose Yes or No (default). You need to choose Yes when the operating system has the APM functions, choose No otherwise.

Video Off Method Choose Blank , DPMS, or V/H Sync+Blank (default). You can chose either DPMS or V/H Sync+Blank when the monitor has the Green function. You need to choose Blank when the monitor has neither the Green function.

MODEM Use IRQ Assign the IRQ number to the modem which is being used so that the ring signal can wakeup the system. The default setting is 3 (COM2).

Doze Mode This option sets the CPU speed down to 33MHz during this mode.

**Standby Mode
Suspend Mode** These two options allow you to choose the mode for the different timers. The Standby Mode turns off the VGA monitor, and the Suspend Mode turns off the CPU and saves the energy of the system.

HDD power Down Time is adjustable from 1 to 15 minutes. When the set time has elapsed, the BIOS sends a command to the HDD to power down, which turns off the motor.

**IRQx (Wake-Up
Event)** Set these IRQs individually. Activity detected from any enabled IRQ channel (ON) will wake up the system.

3. Press <ESC> and follow the screen instructions to save or disregard your settings.

PnP/PCI Configuration Setup

PnP/PCI Configuration Setup configures the PCI bus slots.

Run the Chipset Features Setup as follows:

1. Choose "PnP/PCI CONFIGURATION SETUP" from the Main Menu and a screen with a list of options appears.

```
ROM PCI/ISA BIOS
PNP/PCI CONFIGURATION
AWARD SOFTWARE, INC.

Resources Controlled By : Manual
Reset Configuration Data : Disabled

IRQ-3 assigned to : Legacy ISA
IRQ-4 assigned to : Legacy ISA
IRQ-5 assigned to : PCI/ISA PnP
IRQ-7 assigned to : PCI/ISA PnP
IRQ-9 assigned to : PCI/ISA PnP
IRQ-10 assigned to : PCI/ISA PnP
IRQ-11 assigned to : PCI/ISA PnP
IRQ-12 assigned to : PCI/ISA PnP
IRQ-14 assigned to : PCI/ISA PnP
IRQ-15 assigned to : PCI/ISA PnP
DMA-0 assigned to : PCI/ISA PnP
DMA-1 assigned to : PCI/ISA PnP
DMA-3 assigned to : PCI/ISA PnP
DMA-5 assigned to : PCI/ISA PnP
DMA-6 assigned to : PCI/ISA PnP
DMA-7 assigned to : PCI/ISA PnP

PCI IRQ Activated By : Level
PCI IDE IRQ Map To : PCI-AUTO
Primary IDE INT# : A
Secondary IDE INT# : B

ESC : Quit          ↑ ↓ → ← : Select Item
F1  : Help          PU/PD/+/- : Modify
F5  : Old Values (Shift)F2 : Color
F6  : Load BIOS Defaults
F7  : Load Setup Defaults
```

2. Use one of the arrow keys to move between options and modify the selected options by using PgUp/PgDn/+/- keys.

A short description of screen options follows:

Resources Controlled By Choose Manual (default) or Auto. The BIOS checks the IRQ/DMA channel number on the ISA and PCI card manually if chose Manual and the IRQ/DMA channel number will be checked automatically if choose Auto.

Reset Configuration Data	Choose Enabled or Disabled (default). Disabled means to retain PnP configuration data in BIOS and Enabled means to reset PnP configuration data in BIOS.
IRQ-x assigned to DMA-x assigned to	Legacy ISA: Manually assigns IRQ/DMA to device. PCI/ISA PnP: BIOS assigns IRQ/DMA to device automatically.
PCI IRQ Activated By	Choose Edge or Level (default). Most PCI trigger signals are Level.
PCI IDE IRQ Map To	Select PCI-AUTO (default), ISA, or assign a PCI SLOT number (depending on which slot the PCI IDE is inserted). If PCI-AUTO does not work, then assign an individual PCI SLOT number.
Primary/ IDE INT#	Choose A (default), B, C, or D.
Secondary IDE INT#	Choose A, B (default), C, or D.

3. Press <ESC> and follow the screen instructions to save or disregard your settings.

Load Setup Defaults

Load Setup Defaults option loads the default system values to the system configuration fields. If the CMOS is corrupted the defaults are loaded automatically. Choose this option and the following message appears:

```
"Load Setup Defaults (Y/N)? N"
```

To use the Setup defaults, change the prompt to "Y" and press <Enter>.

Integrated Peripherals

Integrated Peripherals option changes the values of the chipset registers. These registers control system options in the computer.

1. Choose "INTEGRATED PERIPHERALS" from the Main Menu and a screen with a list of options appears.

```
ROM PCI/ISA BIOS
INTEGRATED PERIPHERALS
AWARD SOFTWARE, INC.
```

IDE HDD Block Mode	: Enabled	
IDE Primary Master PIO	: Auto	
IDE Primary Slave PIO	: Auto	
IDE Secondary Master PIO	: Auto	
IDE Secondary Slave PIO	: Auto	
On-Chip Primary PCI IDE	: Enabled	
On-Chip Secondary PCI IDE	: Enabled	
PCI Slot IDE 2nd Channel	: Enabled	
USB Controller	: Disabled	
Onboard FDD Controller	: Enabled	
Onboard Serial Port 1	: Auto	
Onboard Serial Port 2	: Auto	
UART 2 Mode	: Standard	
IR Function Duplex+	: Half	
RxD, TxD Active+	: Lo, Lo	
Onboard Parallel Port	: 378H/IRQ7	
Onboard Parallel MODE	: SPP	
ECP Mode Use DMA*	: 3	
Parallel Port EPP Type*	: EPP1.7	
		ESC : Quit ↑ ↓ → ← : Select Item
		F1 : Help PU/PD/+/- : Modify
		F5 : Old Values (Shift)F2 : Color
		F6 : Load BIOS Defaults
		F7 : Load Setup Defaults

2. Use one of the arrow keys to move between options and modify the selected options by using PgUp/PgDn/+/- keys.

A short description of screen options follows:

IDE HDD Block Mode Choose Enabled (default) or Disabled. If your hard disk size is larger than 540MB, choose Enabled, and, if you are using the IDE HDD Auto Detection option, the BIOS will choose this option automatically. (Note: Some HDDs of old models don't provide this feature.)

IDE Primary Master/Slave PIO	Choose Auto (default) or Mode 0~4.
IDE Secondary Master/Slave PIO	The BIOS will detect the HDD Mode type automatically when you choose Auto. You need to set to a lower mode than Auto when your hard disk becomes unstable.
On-Chip Primary/Secondary PCI IDE	Enabled (default): Turn on the onboard IDE function. Disabled: Turn off the onboard IDE function.
PCI Slot IDE 2nd Channel	Enabled (default) : Reserved IRQ15 for secondary IDE device. Disabled: Release IRQ15 for other devices.
USB Controller	Enabled: Enable USB function and will occupy one IRQ. Disabled (default): Disable USB function and will not occupy IRQ. Choose Disabled when it is not connect to an USB device.
Onboard FDD Controller	Choose Enabled (default) or Disabled. Choose Disabled when you use an ISA card with FDD function, or , choose Enabled to use the onboard FDD connector.
Onboard Serial Port 1	Choose Auto (default), 3F8/IRQ4, 2F8/IRQ3, 3E8/IRQ4, 2E8/IRQ3, or Disabled. Do not set port 1 & 2 to the same value except for Disabled.

Onboard Serial Port 2 Choose Auto (default), 3F8/IRQ4, 2F8/IRQ3, 3E8/IRQ4, 2E8/IRQ3, or Disabled.

UART 2 Mode Choose Standard (default), ASKIR, or HPSIR.

IR Function Duplex* Choose Half (default), or Full.
Half: Doesn't transmit and receive activities at the same time.
Full: Transmit and receive activities at the same time.

RxD, TxD Active* Choose Hi/Hi, Hi/Lo, Lo/Hi, or Lo/Lo (default).

**: The above 2 options won't work unless UART 2 Mode ASKIR/HPSIR is selected.*

Onboard Parallel Port Choose the printer I/O address: 378H/IRQ7 (default), 3BCH/IRQ7, 278H/IRQ5

Onboard Parallel Mode Choose ECP + EPP, SPP (default), EPP, or ECP mode. The mode depends on your external device that connects to this port.

ECP Mode Use DMA* Choose DMA3 (default) or DMA1. Most sound cards use DMA1. Check with your sound card configuration to make sure that there is no conflict with this function.

Parallel Port EPP Type* Choose EPP1.7 (default) or EPP1.9. EPP1.9 supports hardware handshake. This setting is dependent on your EPP device.

Note: The above 2 options will not be displayed unless the EPP/ECP function is selected.

3. Press <ESC> and follow the screen instructions to save or disregard your settings.

Supervisor/User Password

These two options allows you to set your system passwords. Normally, supervisor has a higher right to change the CMOS setup option than the user. The way to set up the passwords for both Supervisor and User are as follow:

1. Choose “Change Password” in the Main Menu and press <Enter>. The following message appears:
“Enter Password:”
2. The first time you run this option, enter your password up to only 8 characters and press <Enter>. The screen does not display the entered characters.
3. After you enter the password, the following message appears prompting you to confirm the password:
“Confirm Password:”
4. Enter exact the same password you just typed again to confirm the password and press <Enter>.
5. Move the cursor to Save & Exit Setup to save the password.
6. If you need to delete the password you entered before, choose the Supervisor Password and press <Enter>. It will delete the password that you had before.
7. Move the cursor to Save & Exit Setup to save the option you did, otherwise the old password will still be there when you turn on your machine next time.
8. Press <ESC> to exit to the Main Menu.

Note: If you forget or lose the password, the only way to access the system is to clear the CMOS RAM by setting JP3. All setup information will be lost and you need to run the BIOS setup program again.

IDE HDD Auto Detection

IDE HDD Auto Detection detects the parameters of an IDE hard disk drive and automatically enters them to the Standard CMOS Setup screen.

The screen will ask you to select a specific hard disk for Primary Master after you select this option. If you accept a hard disk detected by the BIOS, you can enter "Y" to confirm and then press <Enter> to check next hard disk. This function allows you to check four hard disks and you may press the <ESC> after the <Enter> to skip this function and go back to the Main Menu.

Save & Exit Setup

Save & Exit Setup allows you to save all modifications you have specified into the CMOS memory. Highlight this option on the Main Menu and the following message appears:

SAVE to CMOS and EXIT (Y/N)? Y

Press <Enter> key to save the configuration changes.

Exit Without Saving

Exit Without Saving allows you to exit the Setup utility without saving the modifications that you have specified. Highlight this option on the Main Menu and the following message appears:

Quit Without Saving (Y/N)? N

You may change the prompt to "Y" and press <Enter> key to leave this option.