

Notice to End Users

This User's Guide & Technical Reference is for assisting system manufacturers and end users in setting up and installing the mainboard.

Every effort has been made to ensure that the information in this manual is accurate. Soltek Computer Inc. is not responsible for printing or clerical errors. **Information in this document is subject to change without notice and does not represent a commitment on the part of Soltek Computer Inc.**

No part of this manual may be reproduced, transmitted, translated into any language in any form or by any means, electronic or mechanical, including photocopying and recording, for any purpose without the express written permission of Soltek Computer Inc.

Companies and products mentioned in this manual are for identification purposes only. Product names appearing in this manual may or may not be registered trademarks or copyrights of their respective companies.

SOLTEK COMPUTER INC. PROVIDES THIS MANUAL "AS IS" WITHOUT WARRANTY OF ANY KIND, EITHER EXPRESS OR IMPLIED, INCLUDING BUT NOT LIMITED TO THE IMPLIED WARRANTIES OR CONDITIONS OF MERCHANTABILITY OR FITNESS FOR A PARTICULAR PURPOSE. IN NO EVENT SHALL SOLTEK COMPUTER INC. BE LIABLE FOR ANY LOSS OR PROFITS, LOSS OF BUSINESS, LOSS OF USE OR DATA, INTERRUPTION OF BUSINESS, OR FOR INDIRECT, SPECIAL, INCIDENTAL, OR CONSEQUENTIAL DAMAGES OF ANY KIND, EVEN IF SOLTEK COMPUTER INC. HAS BEEN ADVISED OF THE POSSIBILITY OF SUCH DAMAGES ARISING FROM ANY DEFECT OR ERROR IN THIS MANUAL OR PRODUCT.

© Copyright 1997 Soltek Computer Inc. All right reserved

Web site: <http://www.soltek.com.tw>

email: soltek@ms10.hint.net, support@mail.soltek.com.tw

Edition: November 1997

Version: 1.0

SL-53D5-S SERIAL

Contents

Chapter 1: Intorduction	1
Features	1
CPU	1
Chipset	1
L2 Cache	1
Main Memory	1
BIOS	2
I/O Function	2
Other Functions	2
Mainboard Setting for Pentium MMX-166	3
Chapter 2: Hardware Setup	4
CPU VCORE Voltage Setting	4
J3: CPU VCore Voltage Setting	4
Intel Pentium MMX-166/200/233	5
AMD K6 CPU Settings	6
AMD K6 – 166/200/233	6
Cyrrix 6x86MX (M2) – PR150/166/200/233/266	7
Cyrrix 6x86L – PR133+/PR150+/PR166+/PR200+ CPUs	8
Intel Pentium/ AMD K5 CPU Settings	9
CPU 1.5X Clock Setting	9
CPU 2.0X Clock Setting	10
CPU 2.5X Clock Setting	10
CPU 3.0X Clock Setting	11
System Memory Configuration	11
Jumper Settings	12
JBAT1: Clear CMOS Data	12
JBF & JCK: Bus Ratio and External Bus Clock Select	12
Power Connector	13
IDE LED Activity Light: (J2 pin1-4)	14

Infrared Port Module Connector (J2 pin6–10) ----- 14
 J2 pin12, 13: Reserved ----- 14
 SMI Switch (J2 pin14, 15)----- 14
 Speaker Connector (J1 pin1–4) ----- 14
 Reset Switch (J1 pin5, 6)----- 14
 Power LED and Keylock Switch (J1 pin8–12)----- 14
 Turbo LED (J1 pin14, 15)----- 15
 USB: USB Connector ----- 16
 J2 Switch Signal Summary ----- 17
 J1 Switch Signal Summary ----- 18

Chapter 3: BIOS Setup ----- 19

Standard CMOS Setup ----- 20
 BIOS Features Setup ----- 22
 Chipset Features Setup ----- 25
 Power Management Setup ----- 28
 PnP/PCI Configuration Setup ----- 31
 Load Setup Defaults ----- 33
 Integrated Peripherals ----- 33
 Supervisor/User Password ----- 37
 IDE HDD Auto Detection ----- 38
 Save & Exit Setup ----- 38
 HDD Low Level Format ----- 39
 Exit Without Saving ----- 39

Chapter 1

Introduction

Features

CPU

1. Supports Intel Pentium P54C/MMX (P55C) CPUs at 90 ~ 233 MHz;
2. Supports Cyrix 6x86(L) CPUs at PR133⁺ ~ PR200⁺ MHz and 6x86MX (M2) CPUs at PR166⁺ ~ PR266⁺;
3. Supports AMD K5: PR90 ~ PR200 and AMD K6: 166 ~ 233;
4. Provides SOCKET 7 ZIF Socket;
5. Supports 75MHz CPU clock;
6. Supports CPU voltage auto detect and switching circuit.

Chipset

1. VIA Apollo VPX chipset;
2. PCI Rev 2.1 and APM1.1 compliant.

L2 Cache

1. Onboard supports 512k write back cache with Pipelined Burst SRAMs.

Main Memory

1. Memory range from 4MB (minimum) to 512MB (maximum) with DRAM Table Free configurations;
2. Supports Fast Page Mode/EDO/Synchronous DRAM with 60ns/70ns DRAM speed;
3. Supports 4 pcs 72pin SIMM sockets and 1 piece of 168pin DIMM sockets (3.3V unbuffered type).

BIOS

1. AWARD Plug and Play BIOS;
2. Supports Advanced Power Management Function;
3. Flash Memory for easy upgrade.

I/O Function

1. Integrated USB (Universal Serial Bus) controller with two USB ports;
2. Supports 2 IDE channels with 4IDE devices (including 120MB IDE floppy);
3. Provides PCI IDE Bus Master function;
4. One floppy port (including 3.5", 1.2MB Mode 3 function);
5. Two high speed 16550 FIFO UART ports;
6. One parallel port with EPP/ECP/SPP capabilities;
7. PS/2 mouse connector;
8. Infrared module connector.

Other Functions

1. AT Form Factor with 22cm x 23cm;
2. 4 PCI Master slots and 3 ISA slots;
3. Supports SCSI/CD-ROM Boot function;

Note: Make sure that the SDRAM module not only has to be 168 pin DIMM but designed for 3.3V unbuffered SDRAM as well. Double check with the SDRAM supplier before install any SDRAMs. The mainboard manufacturer has no obligation to any damage of the board by using the incorrect specification of SDRAM.

Mainboard Setting for Pentium MMX-166

The default settings of the following figure is for the INTEL Pentium **MMX-166** with the 512K (or 256K) cache. To get the best cooling effect, make sure that the airflow from the CPU fan is facing the heatsink.

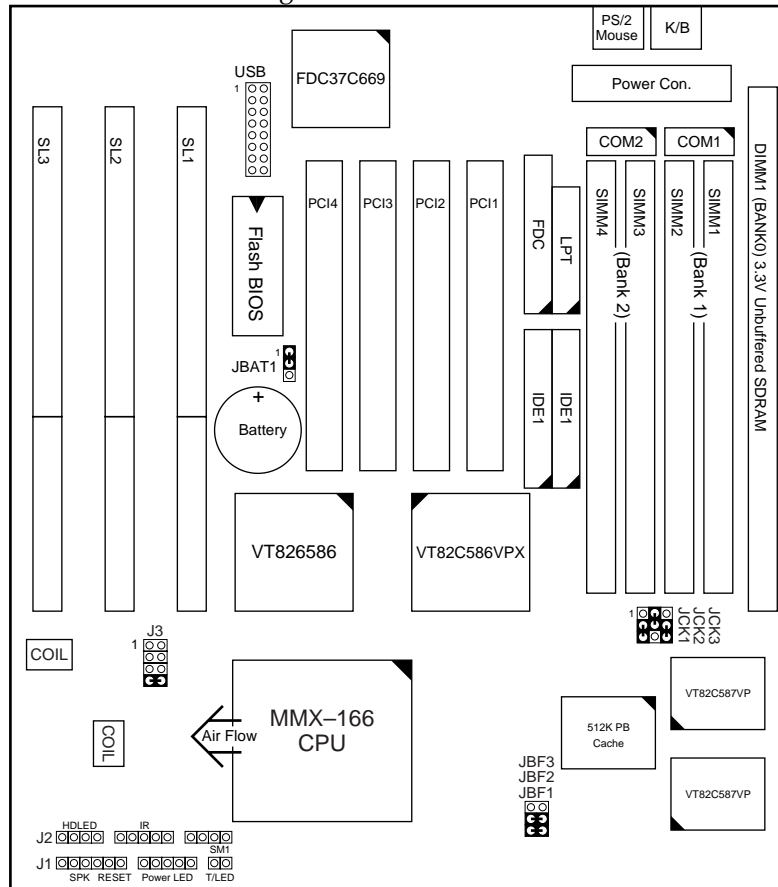

Figure 1-1. SL-53D5-S Motherboard Layout

Chapter 2 Hardware Setup

CPU V_{CORE} Voltage Setting

J3: CPU V_{Core} Voltage Setting

V _{Core} Voltage	J3	V _{Core} Voltage	J3	V _{Core} Voltage	J3	V _{Core} Voltage	J3
2.0V		2.4V		2.8V MMX, 6x86L		3.2V* K6-233 (or higher)	
2.1V* K6-233 (or higher)		2.5V		2.9V K6-166/200 6x86MX (M2)		3.3V	
2.2V		2.6V		3.0V*		3.4V	
2.3V		2.7V		3.1V*		3.5V Pentium (P54C) 6x86 K5	

CPU Type	V _{Core}
Pentium (P54C), 6x86, K5	3.52V
MMX (P55C)	2.8V
6x86L	2.8V
K6-166/200, 6x86MX (M2)	2.9V
K6-233 (or higher)	3.2V

- Note:
1. Refer to the table above to choose the correct voltage for the CPU everytime that you install a CPU.
 2. Make sure that your J3 is matched with the CPU voltage, otherwise will damage the CPU or make the system unstable.
 3. When the new CPU is announced and is not listed on this manual, please refer to the above table, select the correct voltage setting for it.

Intel Pentium MMX-166/200/233

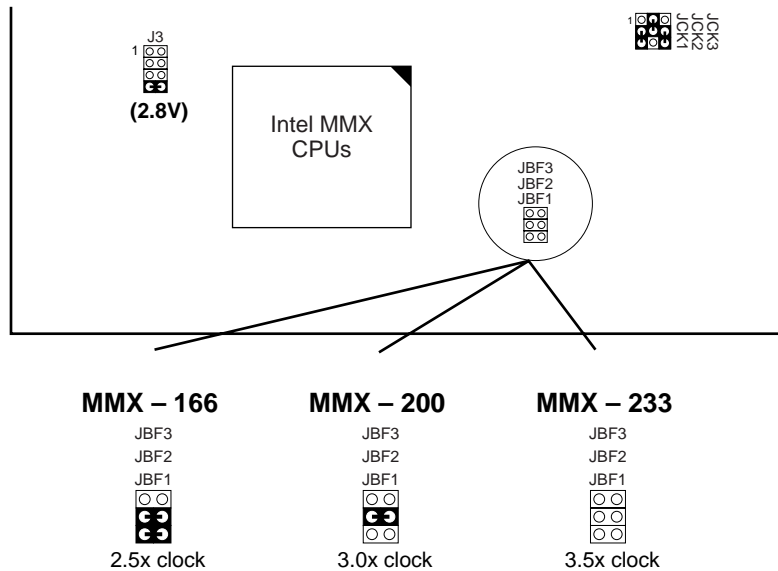
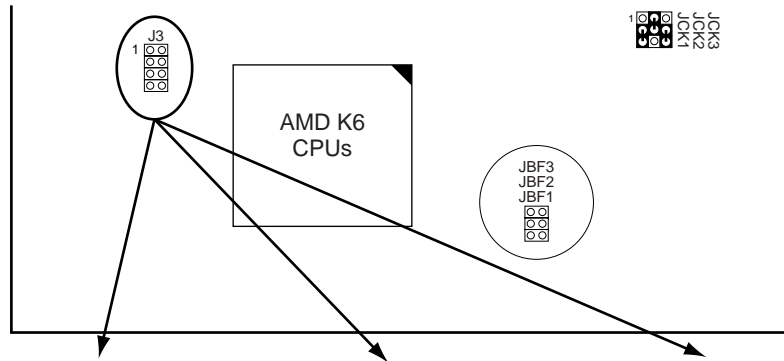

Figure 2-1. CPU Type Configuration

AMD K6 CPU Settings

AMD K6 – 166/200/233



AMD K6 – 166

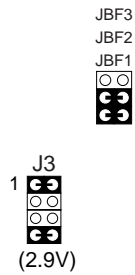

AMD K6 – 200

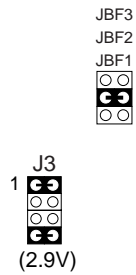

AMD K6 – 233

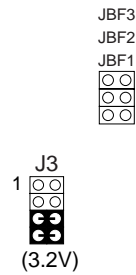

Figure 2-2. CPU Type Configuration

Note: K6-233 CPU is 3.2V or 2.1V depending on its process. Please check its spec before using it.

Cyrix 6x86MX (M2) – PR150/166/200/233/266

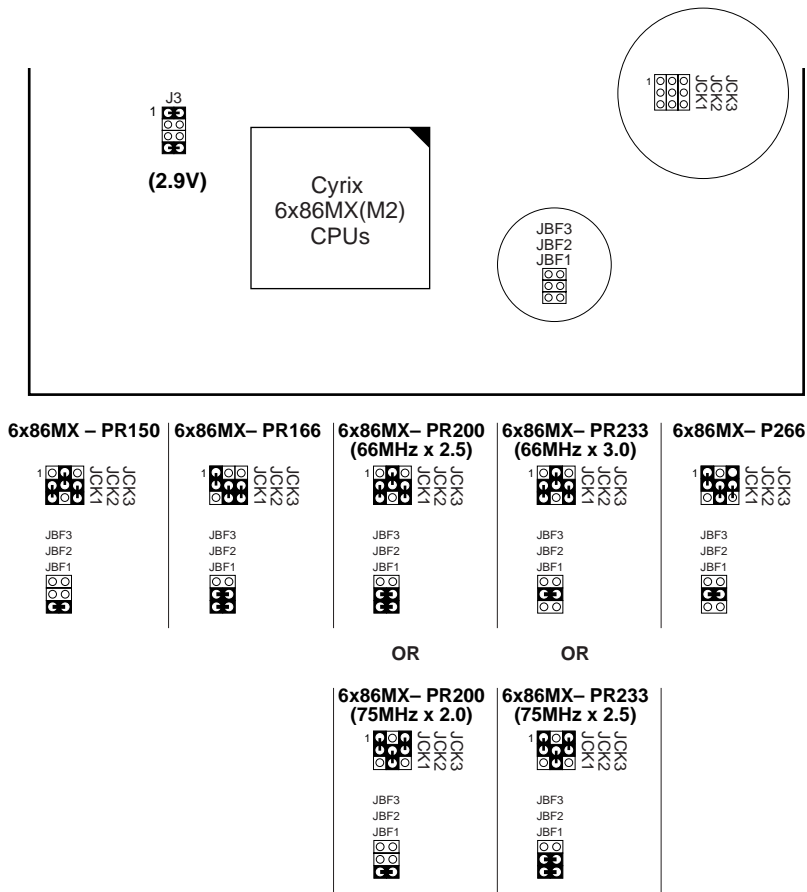

Figure 2–3. CPU Type Configuration

Note: For the correct settings, you must refer to the CPU's surface instruction.

Intel Pentium/AMD K5 CPU Settings

CPU 1.5X Clock Setting

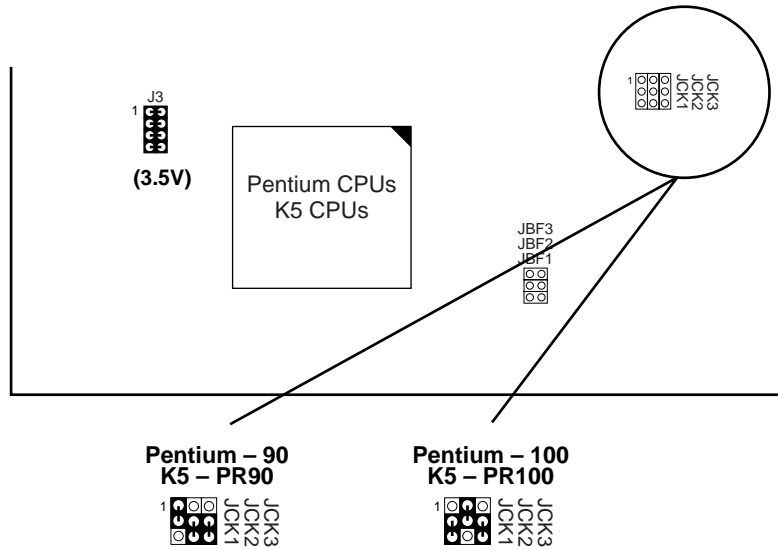

Figure 2-5. CPU Type Configuration

CPU 2.0X Clock Setting

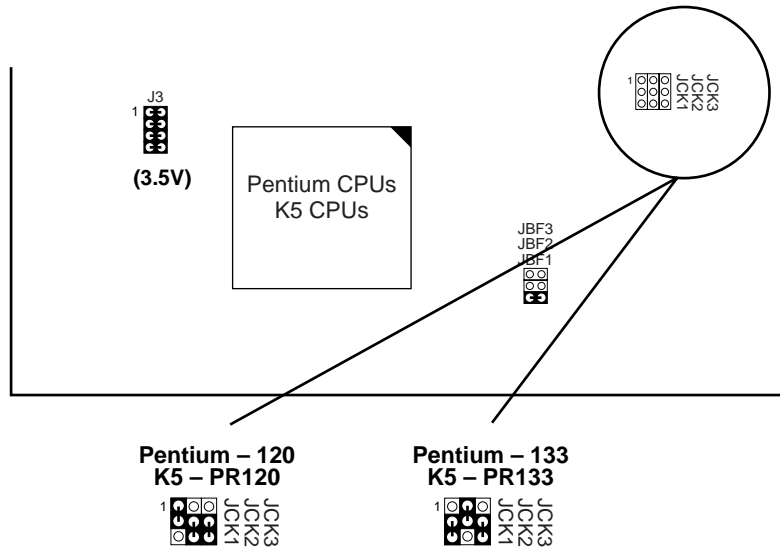

Figure 2-6. CPU Type Configuration

CPU 2.5X Clock Setting

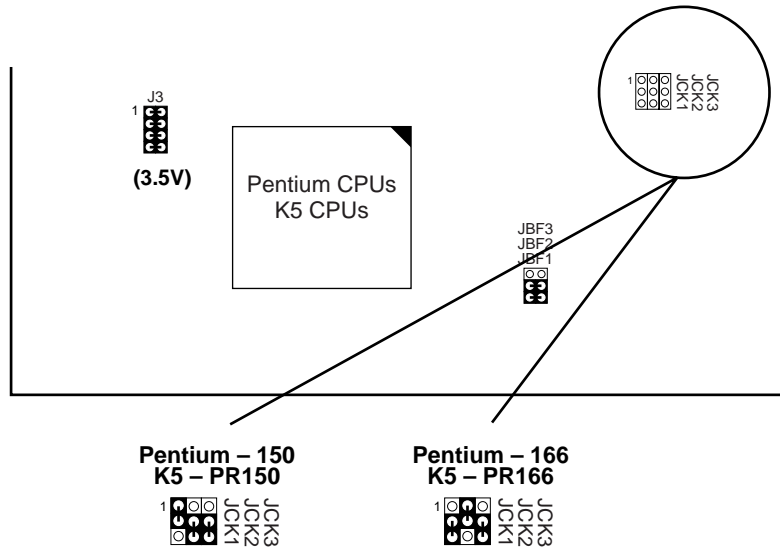

Figure 2-7. CPU Type Configuration

CPU 3.0X Clock Setting

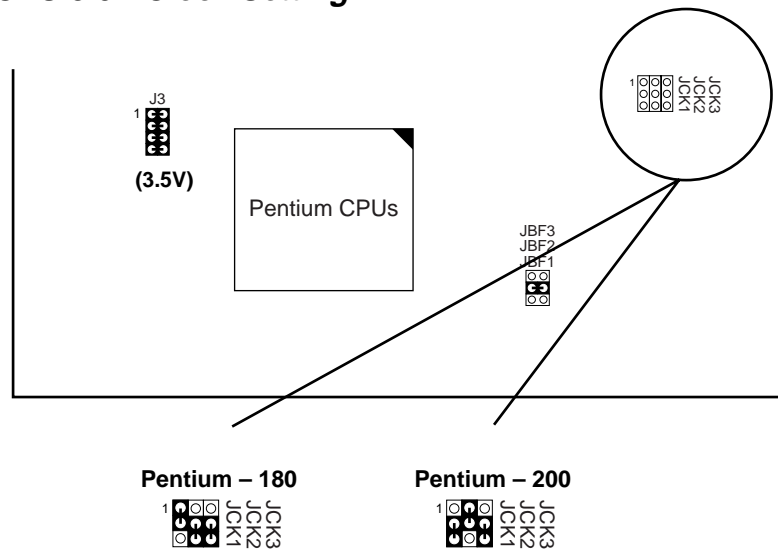

Figure 2-8. CPU Type Configuration

System Memory Configuration



This Apollo VPX motherboard supports 72-pin SIMMs and 168pin DIMMs (3.3V unbuffered type) of 4MB, 8MB, 16MB, or 32MB to form a memory size between 4MB to 512MB (total of 6 rows are supported).

The Apollo VPX chipset supports "Table Free" configuration so that DRAM module can be installed at any capacity.

Jumper Settings



JBAT1: Clear CMOS Data

Clear the CMOS memory by shorting this jumper momentarily; then remove the cap to retain new settings.

COMS Data	JBAT1
Clear Data	 1
Retain Data (default)	 1

JBF & JCK: Bus Ratio and External Bus Clock Select

Set the jumper according to your CPU clock.

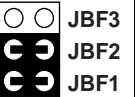
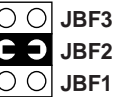
JBF1~3	1.5x 3.5x	2.0x	2.5x	3.0x
CPU Bus Ratio Setting				

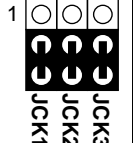
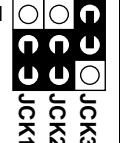
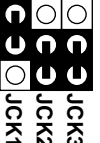
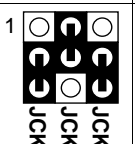
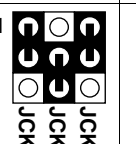
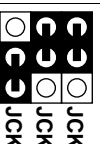
JCK1~3	50MHz	55MHz	60MHz
CPU Clock Setting			
			

Power Connector

The power connector has two 10-pin male header connectors. Plug the dual connectors from the power directly onto the board connector while making sure the black leads are in the center.

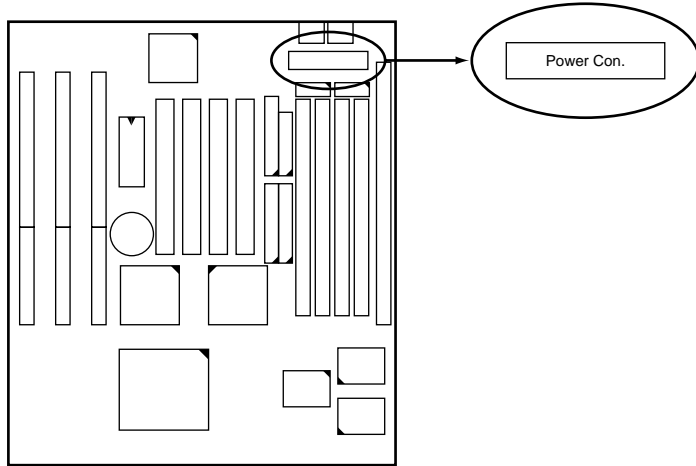

IDE LED Activity Light: (J2 pin1–4)

This connector connects to the hard disk activity indicator light on the case.

Infrared Port Module Connector (J2 pin6–10)

The system board provides a 5-pin infrared connector—IR1 as an optional module for wireless transmitting and receiving. **Pin 6 through 10 are Transmit, GND, Receive (low speed), Receive (high speed), and Vcc, respectively.**

J2 pin12, 13: Reserved

SMI Switch (J2 pin14, 15)

Toggle this jumper forces the system to sleep and the system won't wake up until the hardware event is coming. (The BIOS Power Management setting must be Enabled.)

Speaker Connector (J1 pin1–4)

The speaker connector is a 4-pin connector for connecting the system and the speaker. (See the following drawing for jumper position.)

Reset Switch (J1 pin5, 6)

The system board has a 2-pin connector for rebooting your computer without having to turn off your power switch. This prolongs the life of the system's power supply.

Power LED and Keylock Switch (J1 pin8–12)

The keylock switch is a 5-pin connector for locking the keyboard for security purposes. (See the following drawing for jumper position, and pin1~3 is connected to power LED and pin 4~5 is connected to keylock switch.)

Turbo LED (J1 pin14, 15)

Connect the case's turbo LED to this connector.

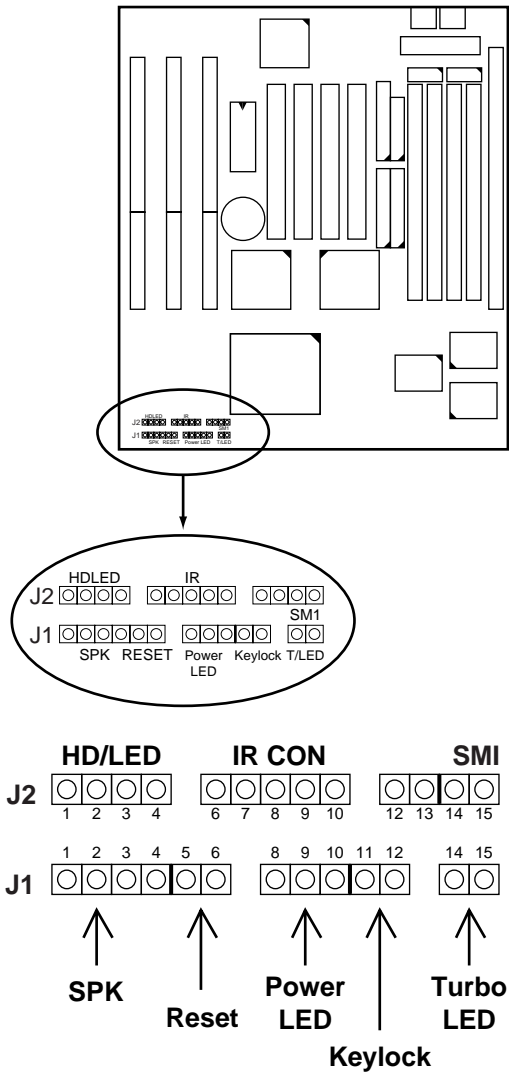

USB: USB Connector

This jumper connects to the USB cable to provide USB device.

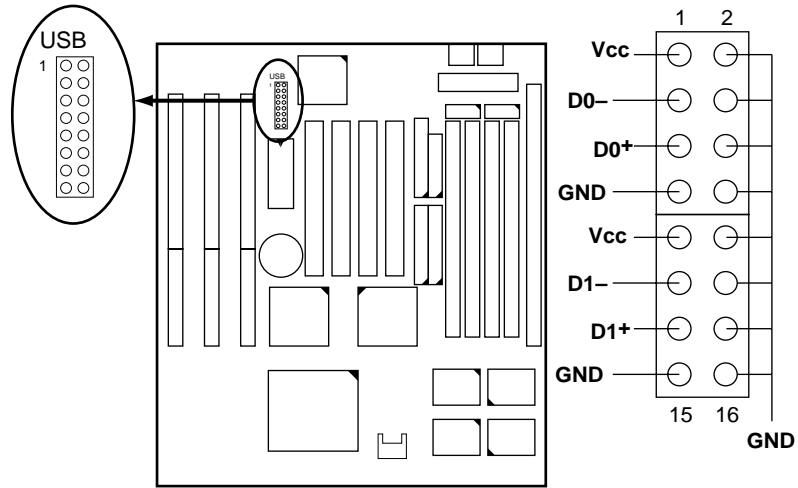

MS1 Top View

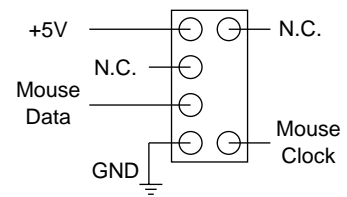

COM1/2 (Top View)

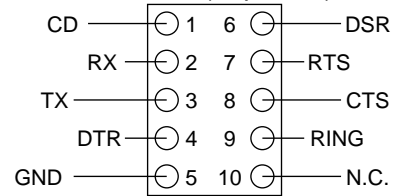

J2 Switch Signal Summary

J2	Pin	Signal Description
HDD LED Connector	1	+5V
	2	HDD LED Signal
	3	HDD LED Signal
	4	+5V
N.C.	5	No Connection
Infrared Connector	6	Infrared Transmit Signal
	7	GND
	8	Infrared Receive Signal (low speed)
	9	Infrared Receive Signal (high speed)
N.C.	10	+5V
	11	No Connection
	12	
13		
SMI	14	GND
	15	SMI Signal

J1 Switch Signal Summary

J1	Pin	Signal Description
Speaker Connector	1	Speaker Signal
	2	No Connection
	3	Ground
	4	+5V
Reset Switch	5	Reset Signal
	6	Ground
N.C.	7	No Connection
Power LED Connector	8	+5V
	9	No Connection
	10	Ground
Keylock Connector	11	Keylock Signal
	12	GND
N.C.	13	No Connection
Turbo LED Connector	14	Turbo LED Connector
	15	Ground

Chapter 3

Award BIOS Setup

This VIA VPX motherboard comes with the AWARD BIOS from AWARD Software Inc. Enter the Award BIOS program's Main Menu as follows:

1. Turn on or reboot the system.

After a series of diagnostic checks, the following message will appear:

PRESS TO ENTER SETUP

2. Press the key and the main program screen appears as in the following page.

ROM PCI/ISA BIOS
CMOS SETUP UTILITY
AWARD SOFTWARE, INC.

STANDARD CMOS SETUP	INTEGRATED PERIPHERALS
BIOS FEATURES SETUP	SUPERVISOR PASSWORD
CHIPSET FEATURES SETUP	USER PASSWORD
POWER MANAGEMENT SETUP	IDE HDD AUTO DETECTION
PNP/PCI CONFIGURATION	HDD LOW LEVEL FORMAT
LOAD SETUP DEFAULTS	SAVE & EXIT SETUP
	EXIT WITHOUT SAVING
Esc : Quit	↑ ↓ → ← : Select Item
F10 : Save & Exit Setup	(Shift) F2 : Change Color
Time, Date, Hard Disk Type...	

- Using one of the arrows on your keyboard to select an option and press <Enter>. Modify the system parameters to reflect the options installed in the system.
- You may return to the Main Menu anytime by press <ESC>.
- In the Main Menu, "SAVE AND EXIT SETUP" saves your changes and reboots the system, and "EXIT WITHOUT SAVING" ignores your changes and exits the program.

Standard CMOS Setup

Standard CMOS Setup allows you to record some basic system hardware configuration and set the system clock and error handling. You only need to modify the configuration values of this option when you change your system hardware configuration or the configuration stored in the CMOS memory got lost or damaged.

Run the Standard CMOS Setup as follows:

- Choose "STANDARD CMOS SETUP" from the Main Menu and a screen with a list of options appears.

```

ROM PCI/ISA BIOS
STANDARD CMOS SETUP
AWARD SOFTWARE, INC.

Date (mm:dd:yy) : Thu, May 9 1996
Time (hh:mm:ss) : 15 : 45 : 10

HARD DISKS      TYPE  SIZE  CYLS HEAD  PRECOMP  LANDZ  SECTOR  MODE
-----
Primary Master  : Auto   0      0  0      0      0      0  Auto
Primary Slave   : Auto   0      0  0      0      0      0  Auto
Secondary Master : Auto   0      0  0      0      0      0  Auto
Secondary Slave : Auto   0      0  0      0      0      0  Auto

Drive A : 1.44M, 3.5 in.
Drive B : None
Floppy 3 Mode Support : Disabled

Video : EGA/VGA
Halt On : All Errors

Base Memory: 640K
Extended Memory: 15360K
Other Memory: 384K
-----
Total Memory: 16384K

Esc : Quit      ↑ ↓ → ← : Select Item  PU/PD/+/- : Modify
Fl  : Help      (Shift) F2 : Change Color

```

- Use one of the arrow keys to move between options and modify the selected options by using PgUp/PgDn/+/- keys.

A short description of screen options follows:

- Date (mm:dd:yy)** Set the current date and time.
- Time (hh:mm:ss)**

- Primary (Secondary) Master/Slave** This field records the specifications for all non-SCSI hard disk drives installed in your system. Refer to the respective documentation on how to install the drivers.

- Drive A/B** Set this field to the types of floppy disk drives installed in your system. The choices are:
 360KB, 5.25 in.,
 1.2MB, 5.25 in.,
 720KB, 3.5 in.,
 1.44M, 3.5 in. (default),
 2.88MB, 3.5 in., or None
 120MB, 3.5in., IDE Floppy Drive (Auto detect).

- Floppy 3 Mode Support** Drive A/B, Both: Enabled 3.5-inch, 1.2MB function.
 Disabled (default): Disabled 3.5-inch, 1.2MB function.

- Video** Set this field to the type of video display card installed in the system. The choices are: Monochrome; Color 40x25; VGA / EGA (default); or Color 80x25

- Halt On** Set this field to the type of errors that will cause the system to halt. The choices are: All Errors (default); No Errors; All, But Keyboard; All, But Diskette; or All, But Disk / Key

3. Press <ESC> to return to the Main Menu when you finish setting up in the "Standard CMOS Setup".

BIOS Features Setup

BIOS Features Setup allows you to improve your system performance or set up some system features according to your preference.

Run the BIOS Features Setup as follows:

1. Choose "BIOS FEATURES SETUP" from the Main Menu and a screen with a list of options appears.

```
ROM PCI/ISA BIOS
BIOS FEATURES SETUP
AWARD SOFTWARE, INC.
```

Virus Warning	: Disabled	Video BIOS Shadow	: Enabled
CPU Internal Cache	: Enabled	C8000-CBFFF Shadow	: Disabled
External Cache	: Enabled	CC000-CFFFF Shadow	: Disabled
Quick Power on Self Test	: Enabled	D0000-D3FFF Shadow	: Disabled
Boot Sequence	: A,C, SCSI	D4000-D7FFF Shadow	: Disabled
Swap Floppy Drive	: Disabled	D8000-DBFFF Shadow	: Disabled
Boot Up Floppy Seek	: Disabled	DC000-DFFFF Shadow	: Disabled
Boot Up NumLock Status	: On		
Gate A20 Option	: Fast		
TypeMatic Rate Setting	: Disabled		
TypeMatic Rate (Chars/Sec)	: 6	ESC : Quit	↑ ↓ → ← : Select Item
TypeMatic Delay (Msec)	: 250	F1 : Help	PU/PD/+/- : Modify
Security Option	: Setup	F5 : Old Values (Shift)	F2 : Color
IDE second Channel Control	: Enabled	F6 : Load BIOS Defaults	
PCI/VGA Palette Snoop	: Disabled	F7 : Load Setup Defaults	
OS Select for DRAMs>64MB	: Non-OS/2		

2. Use one of the arrow keys to move between options and modify the selected options by using PgUp/PgDn/+/- keys. An explanation of the <F> keys follows:

<F1>: "Help" gives options available for each item.

Shift <F2>: Change color.

<F5> : Get the previous values. These values are the values with which the user started the current session.

<F6>: Load all options with the BIOS default values.

<F7>: Load all options with the Setup default values.

A short description of screen options follows:

- Virus Warning** Enabled: Activates automatically when the system boots up causing a warning message to appear if there is anything attempts to access the boot sector or hard disk partition table.
Disabled: No warning message will appear when there is something attempts to access the boot sector or hard disk partition table
Note: Many diagnostic (or boot manager) programs which attempt to access the boot sector table can cause the above warning message. If you will be running such a program, we recommend that you disable the virus protection first.
- CPU Internal Cache** Choose Enabled (default) or Disabled. This option allows you to enable or disable the CPU's internal cache.
- External Cache** Choose Enabled (default) or Disabled. This option allows you to enable or disable the external cache memory.
- Quick Power On Self Test** Choose Enabled (default) or Disabled. This option allows you to speed up the Power On Self Test routine.

Boot Sequence	Default is "A, C, SCSI". This option determines which drive to look for first for an operating system.
Swap Floppy Drive	Choose Enabled or Disabled (default). This option swaps floppy drive assignments when it is enabled.
Boot Up Floppy Seek	<p>Enabled: During POST, BIOS checks the track number of the floppy disk drive to see whether it is 40 or 80 tracks.</p> <p>Disabled (default): During POST, BIOS will not check the track number of the floppy disk drive.</p>
Boot Up NumLock Status	Choose On (default) or Off. This option lets user to activate the NumLock function at boot-up.
Gate A20 Option	Choose Normal or Fast (default). This option allows the RAM to access the memory above 1MB by using the fast gate A20 line.
Typematic Rate Setting	Choose Enabled or Disabled (default). Enable this option to adjust the keystroke repeat rate.
Typematic Rate (Chars/Sec)	Range between 6 (default) and 30 characters per second. This option controls the speed of repeating keystrokes.
Typematic Delay (Msec)	Choose 250 (default), 500, 750, and 1000. This option sets the time interval for displaying the first and the second characters.

Security Option	Choose System or Setup (default). This option is to prevent unauthorized system boot-up or use of BIOS Setup.
IDE Second Channel Control	Enabled: (default) Reserved IRQ15 for secondary IDE device. Disabled: Release IRQ15 for other devices.
PCI/VGA palette Snoop	Choose Enabled or Disabled (default). It determines whether the MPEG ISA cards can work with PCI/VGA or not.
Video BIOS Shadow	Enabled (default): Map the VGA BIOS to system RAM. Disabled: Don't map the VGA BIOS to system RAM.
C8000-CBFFF to DC000-DFFF Shadow	These options are used to shadow other expansion card ROMs.

3. Press <ESC> and follow the screen instructions to save or disregard your settings.

Chipset Features Setup

Chipset Features Setup changes the values of the chipset registers. These registers control the system options.

Run the Chipset Features Setup as follows:

1. Choose "CHIPSET FEATURES SETUP" from the Main Menu and a screen with a list of options appears.
2. Use one of the arrow keys to move between options and modify the selected options by using PgUp/PgDn/+/- keys.

ROM PCI/ISA BIOS
 CHIPSET FEATURES SETUP
 AWARD SOFTWARE, INC.

DRAM Auto Configuration	: Enabled	OnChip USB	: Disabled
DRAM Timing Control	: Normal	USB Keyboard Support*	: Disabled
SDRAM Cycle Length	: 3		
Sustained 3T Write	: Disabled		
Read Pipeline	: Enabled		
Write Pipeline	: Enabled		
Cache Timing	: Fast		
Linear Burst	: Disabled	ESC : Quit	↑ ↓ → ← : Select Item
Video BIOS Cacheable	: Disabled	F1 : Help	PU/PD/+/- : Modify
System BIOS Cacheable	: Disabled	F5 : Old Values (Shift)	F2 : Color
Memory Hole At 15Mb. Addr.:	: Disabled	F6 : Load BIOS Defaults	
		F7 : Load Setup Defaults	

A short description of screen options follows:

- DRAM Auto Configuration** Choose Enabled (default) or Disabled. The system sets all options on the left side of the screen automatically when choose Enabled.
- DRAM Timing Control** Choose 60ns or 70ns (default). Do not change this setting unless you know the DRAM access time spec.
- SDRAM Cycle Length** Use the default setting.
- Sustained 3T Write** Use the default setting.
- Read/Write Pipeline** Use the default setting.
- Cache Timing** Use the default setting.
- Linear Burst** Choose Disabled (default) or Enabled. Only when the CPU is either Cyrix or AMD then you may choose Enabled.

Video BIOS Cacheable	Choose Enabled or Disabled (default). When Enabled, the access to the VGA BIOS ROM addressed at C0000H-C7FFFH is cached.
System BIOS Cacheable	Choose Enabled or Disabled (default). When Enabled, the access to the system BIOS ROM addressed at F0000H-FFFFFH is cached.
Memory Hole At 15M-16M	Choose Enabled or Disabled (default). In order to improve performance, certain space in memory can be reserved for ISA cards. This memory must be mapped into the memory's space below 16MB.
SDRAM Speculative Read	Use the default setting. This function allows a DRAM read request to be generated slightly before the address has been fully decoded.
OnChip USB	<p>Enabled: Enable USB function and will occupy one IRQ.</p> <p>Disabled (default): Disable USB function and will not occupy IRQ. Choose Disabled when it is not connect to an USB device.</p>
USB Keyboard Support	<p>Choose Disabled (default) or Enabled.</p> <p>Disabled: No USB keyboard is installed.</p> <p>Enabled: USB keyboard is connected.</p>

3. Press <ESC> and follow the screen instructions to save or disregard your settings.

Power Management Setup

Power Management Setup sets the system's power saving functions.

1. Choose "POWER MANAGEMENT SETUP" from the Main Menu and a screen with a list of options appears.

ROM PCI/ISA BIOS POWER MANAGEMENT SETUP AWARD SOFTWARE, INC.		
Power Management	: Disabled	IRQ 5 (LPT 2) : Primary
PM Control by APM	: No	IRQ 6 (Floppy Disk) : Primary
Video Off option	: Suspend -> Off	IRQ 7 (LPT 1) : Primary
Video Off Method	: V/H SYNC+Blank	IRQ 8 (RTC Alarm) : Disabled
Conserve Mode	: Disabled	IRQ 9 (IRQ2 Redir) : Secondary
Modem Use IRQ	: 3	IRQ 10 (Reserved) : Secondary
		IRQ 11 (Reserved) : Secondary
** PM Timers **		IRQ 12 (PS/2 mouse) : Primary
HDD Power Down	: Disabled	IRQ 13 (Coprocessor) : Primary
Doze Mode	: Disabled	IRQ 14 (Hard Disk) : Primary
Suspend Mode	: Disabled	IRQ 15 (Reserved) : Disabled
** PM Events **		
VGA	: OFF	
LPT & COM	: LPT/COM	
HDD & FDD	: ON	ESC : Quit ↑ ↓ → ← : Select Item
DMA/Master	: OFF	F1 : Help PU/PD/+/- : Modify
Primary INTR	: ON	F5 : Old Values (Shift)F2 : Color
IRQ3 (COM 2)	: Primary	F6 : Load BIOS Defaults
IRQ4 (COM 1)	: Primary	F7 : Load Setup Defaults

2. Use one of the arrow keys to move between options and modify the selected options by using PgUp/PgDn/+/- keys.

A short description of screen options follows:

Power Management	Choose Max. Saving, User Define, Disabled (default), or Min Saving.
PM Control by APM	Choose Yes or No (default). You need to choose Yes when the operating system has the APM functions, choose No otherwise.
Video Off Option	Choose N/A (default), Doze, Standby, or Suspend. This function determines the timing of the monitor closed down functions.

- Video Off Method** Choose Blank , DPMS, or V/H Sync+Blank (default). You can chose either DPMS or V/H Sync+Blank when the monitor has the Green function. You need to choose Blank when the monitor does not have the Green function.
Note: Some VGA cards don't allow V/H Sync to be turned off directly.
- Conserve Mode** Use the default setting.
- MODEM Use IRQ** Assign the IRQ number to the modem which is being used so that the ring signal can wakeup the system. The default setting is 3 (COM2).
- HDD power Down** Time is adjustable from 1 to 15 minutes. When the set time has elapsed, the BIOS sends a command to the HDD to power down, which turns off the motor.
- Doze Mode** This option sets the CPU speed down to 33MHz during this mode.
- Suspend Mode** This option allows you to choose the mode for the different timers. The Standby Mode turns off the VGA monitor, and the Suspend Mode turns off the CPU and saves the energy of the system.
- VGA**
 Enabled: the system can not enter the power saving mode when monitor is on.
 Disabled: the system can enter the power saving mode when monitor is on.

LPT & COM	Use the default setting.
HDD & FDD	Use the default setting.
DMA/Master	Use the default setting.
Primary INTR	Use the default setting.
IRQ x	Set these IRQs individually. Activity detected from any enabled IRQ channel (ON) will wake up the system.

3. Press <ESC> and follow the screen instructions to save or disregard your settings.

PnP/PCI Configuration Setup

PnP/PCI Configuration Setup configures the PCI bus slots.

Run the PnP/PCI Configuration Setup as follows:

1. Choose “PnP/PCI CONFIGURATION SETUP” from the Main Menu and a screen with a list of options appears.

```
ROM PCI/ISA BIOS
PNP/PCI CONFIGURATION
AWARD SOFTWARE, INC.
```

PNP OS Installed : No	CPU to PCI Write Buffer : Enabled
Resources Controlled By : Manual	PCI Dynamic Bursting : Enabled
Reset Configuration Data : Disabled	PCI Master 0 WS Write : Enabled
IRQ-3 assigned to : Legacy ISA	PCI IRQ Activated By : Edge
IRQ-4 assigned to : Legacy ISA	PCI IDE IRQ Map to : PCI-AUTO
IRQ-5 assigned to : PCI/ISA PnP	Primary IDE INT# : A
IRQ-7 assigned to : PCI/ISA PnP	Secondary IDE INT# : B
IRQ-9 assigned to : PCI/ISA PnP	
IRQ-10 assigned to : PCI/ISA PnP	
IRQ-11 assigned to : PCI/ISA PnP	
IRQ-12 assigned to : PCI/ISA PnP	
IRQ-14 assigned to : PCI/ISA PnP	
IRQ-15 assigned to : PCI/ISA PnP	
DMA-0 assigned to : PCI/ISA PnP	
DMA-1 assigned to : PCI/ISA PnP	ESC : Quit ↑↓→←: Select Item
DMA-3 assigned to : PCI/ISA PnP	F1 : Help PU/PD/+/- : Modify
DMA-5 assigned to : PCI/ISA PnP	F5 : Old Values (Shift)F2 : Color
DMA-6 assigned to : PCI/ISA PnP	F6 : Load BIOS Defaults
DMA-7 assigned to : PCI/ISA PnP	F7 : Load Setup Defaults

2. Use one of the arrow keys to move between options and modify the selected options by using PgUp/PgDn/+/- keys.

A short description of screen options follows:

PNP OS Installed Yes: OS supports Plug and Play function.
No (default): OS doesn't support Plug and Play function.

Note: BIOS will automatically disable all PnP resources except the boot device card when select Yes on Non-PnP OS.

Resources Controlled By Choose Manual (default) or Auto. The BIOS checks the IRQ/DMA channel number on the ISA and PCI card manually if chose Manual and the IRQ/DMA channel number will be checked automatically if choose Auto.

Reset Configuration Data Choose Enabled or Disabled (default). Disabled means to retain PnP configuration data in BIOS and Enabled means to reset PnP configuration data in BIOS.

IRQ-x assigned to DMA-x assigned to Legacy ISA: Manually assigns IRQ/DMA to device.
PCI/ISA PnP: BIOS assigns IRQ/DMA to device automatically.

CPU To PCI Write Buffer Use the default setting.

PCI Dynamic Bursting Use the default setting.

PCI Master 0 WS Write Use the default setting.

3. Press <ESC> and follow the screen instructions to save or disregard your settings.

Load Setup Defaults

Load Setup Defaults option loads the default system values to the system configuration fields. If the CMOS is corrupted the defaults are loaded automatically. Choose this option and the following message appears:

```
"Load Setup Defaults (Y/N)? N"
```

To use the Setup defaults, change the prompt to "Y" and press <Enter>.

Integrated Peripherals

Integrated Peripherals option changes the values of the chipset registers. These registers control system options in the computer.

1. Choose "INTEGRATED PERIPHERALS" from the Main Menu and a screen with a list of options appears.

```
ROM PCI/ISA BIOS
INTEGRATED PERIPHERALS
AWARD SOFTWARE, INC.
```

On-Chip IDE First Channel	: Enabled	Onboard Parallel Port	: 378/IRQ7
On-Chip IDE Second Channel	: Enabled	Parallel Port Mode ⁺	: Normal
IDE Prefetch Mode	: Enabled	ECP Mode Use DMA ⁺	: 3
IDE HDD Block Mode	: Enabled	Parallel Port EPP Type ⁺	: EPP1.7
IDE Primary Master PIO	: Auto		
IDE Primary Slave PIO	: Auto		
IDE Secondary Master PIO	: Auto		
IDE Secondary Slave PIO	: Auto		
IDE Primary Master UDMA	: Auto		
IDE Primary Slave UDMA	: Auto		
IDE Secondary Master UDMA	: Auto		
IDE Secondary Slave UDMA	: Auto		
Onboard FDD Controller	: Enabled		
Onboard UART 1	: Auto		
Onboard UART 2	: Auto	ESC : Quit	↑ ↓ → ← : Select Item
Onboard UART2 Mode	: Standard	F1 : Help	PU/PD/+/- : Modify
IR Duplex Mode*	: Half	F5 : Old Values (Shift)F2	: Color
Use IR Pins*	: IR-RX2TX2	F6 : Load BIOS Defaults	
Fast_IR MODE Pins*	: IRR3	F7 : Load Setup Defaults	

*: These Settings are only effective under "Onboard UART 2 Mode" option is set HPSIR.

+: These options only valid at Parallel Port Mode at ECP+EPP.

2. Use one of the arrow keys to move between options and modify the selected options by using PgUp/PgDn/+/- keys.

A short description of screen options follows:

- | | |
|--|---|
| OnChip IDE First/Second Channel | Enabled (default): Turn on the onboard IDE function.

Disabled: Turn off the onboard IDE function. |
| IDE Prefetch Mode | Use the default setting. |
| IDE HDD Block Mode | Choose Enabled (default) or Disabled. If your hard disk size is larger than 540MB, choose Enabled, and, if you are using the IDE HDD Auto Detection option, the BIOS will choose this option automatically. (Note: Some old HDD models don't provide this feature.) |
| IDE Primary Master/Slave PIO IDE Secondary Master/Slave PIO | Choose Auto (default) or Mode 0~4. The BIOS will detect the HDD Mode type automatically when you choose Auto. You need to set to a lower mode than Auto when your hard disk becomes unstable. |
| IDE Primary Master/Slave UDMA IDE Secondary Master/Slave UDMA | Choose Disabled or Auto (default).
Auto: Automatically detects the HDD Ultra DMA function.
Disabled: Disabled the HDD Ultra DMA function. |
| Onboard FDD Controller | Choose Enabled (default) or Disabled. Choose Disabled when you use an ISA card with FDD function, or , choose Enabled to use the onboard FDD connector. |

- Onboard UART1** Choose Auto (default), 3F8/IRQ4, 2F8/IRQ3, 3E8/IRQ4, 2E8/IRQ3, or Disabled.
- Do not set port 1 & 2 to the same value except for Disabled.
- Onboard Serial UART2** Choose Auto (default), 3F8/IRQ4, 2F8/IRQ3, 3E8/IRQ4, 2E8/IRQ3, or Disabled.
- Onboard UART2 Mode** Choose Standard, HPSIR, or ASKIR.
- IR Duplex Mode** Choose Half (default), or Full.
 Half: Doesn't transmit and receive activities at the same time.
 Full: Transmit and receive activities at the same time.
- Use IR Pins; FAST_IR MODE Pins** Use default setting.
- Onboard Parallel Port** Choose the printer I/O address: 378H/IRQ7 (default), 3BCH/IRQ7, 278H/IRQ5
- Parallel Port Mode** Choose SPP (default), ECP + EPP, EPP, or ECP mode. The mode depends on your external device that connects to this port.

ECP Mode Use DMA Choose DMA3 (default) or DMA1. Most sound cards use DMA1. Check with your sound card configuration to make sure that there is no conflict with this function.

**: This option will not be displayed unless the EPP/ECP function is selected..*

Parallel Port EPP Type Choose EPP1.7 (default) or EPP1.9. EPP1.9 supports hardware handshake. This setting is dependent on your EPP device.

Note: The above 2 options will not be displayed unless the EPP/ECP function is selected.

3. Press <ESC> and follow the screen instructions to save or disregard your settings.

Supervisor/User Password

These two options allow you to set your system passwords. Normally, supervisor has a higher right to change the CMOS setup option than the user. The way to set up the passwords for both Supervisor and User are as follows:

1. Choose "Change Password" in the Main Menu and press <Enter>. The following message appears:

"Enter Password:"

2. The first time you run this option, enter your password up to only 8 characters and press <Enter>. The screen does not display the entered characters.
3. After you enter the password, the following message appears prompting you to confirm the password:

"Confirm Password:"

4. Enter exactly the same password you just typed again to confirm the password and press <Enter>.
5. Move the cursor to Save & Exit Setup to save the password.
6. If you need to delete the password you entered before, choose the Supervisor Password and press <Enter>. It will delete the password that you had before.
7. Move the cursor to Save & Exit Setup to save the option you did, otherwise the old password will still be there when you turn on your machine next time.
8. Press <ESC> to exit to the Main Menu.

Note: *If you forget or lose the password, the only way to access the system is to clear the CMOS RAM by setting JBAT1. All setup information will be lost and you need to run the BIOS setup program again.*

IDE HDD Auto Detection

IDE HDD Auto Detection detects the parameters of an IDE hard disk drive and automatically enters them to the Standard CMOS Setup screen.

The screen will ask you to select a specific hard disk for Primary Master after you select this option. If you accept a hard disk detected by the BIOS, you can enter "Y" to confirm and then press <Enter> to check next hard disk. This function allows you to check four hard disks and you may press the <ESC> after the <Enter> to skip this function and go back to the Main Menu.

Save & Exit Setup

Save & Exit Setup allows you to save all modifications you have specified into the CMOS memory. Highlight this option on the Main Menu and the following message appears:

```
SAVE to CMOS and EXIT (Y/N)? Y
```

Press <Enter> key to save the configuration changes.

HDD Low Level Format

Do not use this utility unless you have help from engineers or some technical background.

Exit Without Saving

Exit Without Saving allows you to exit the Setup utility without saving the modifications that you have specified. Highlight this option on the Main Menu and the following message appears:

```
Quit Without Saving (Y/N)? N
```

You may change the prompt to “Y” and press <Enter> key to leave this option.