



The Soul Of Computer Technology

# Mainboard

**Series SL-85SD**

**User Manual v1.0**

<b>SL-85SD</b>	<b>SL-85SD<sup>+</sup></b>
<b>SL-85SD-X</b>	<b>SL-85SD<sup>+</sup>-X</b>
<b>SL-85SDB</b>	<b>SL-85SDB-X</b>

# NOTICE

Product Model	: Series SL-85SD
Manual Revision	: V1.0
Release Date	: August 2001



This Users Guide & Technical Reference is to help system manufacturers and end-users set up and install the mainboard.

Every effort has been made to ensure that the information in this manual is accurate. Soltek Computer Inc. is not responsible for printing or clerical errors. Information in this document is subject to change without notice and does not represent a commitment on Soltek Computer Inc.

No part of this manual may be reproduced, transmitted, translated into any language in any form or by any means, electronic or mechanical, including photocopying and recording, for any purpose without the express written permission of Soltek Computer Inc.

Companies and products mentioned in this manual are for identification purpose only. Product names appearing in this manual may or may not be registered trademarks or copyrights of their respective companies.

Soltek Computer Inc. provides this manual “As is “ without warranty of any kind, either express or implied, including but not limited to the implied warranties or conditions of merchantability or fitness for a particular purpose. In no event shall Soltek Computer Inc. be liable for any loss or profits, loss of business, loss of use or data, interruption of business, or for indirect, special, incidental, or consequential damages of any kind, even if Soltek Computer Inc. has been advised of the possibility of such damages arising from any defect or error in this manual or product.

**Copyright © 2001 Soltek Computer Inc. All Rights Reserved.**

- Intel Pentium 4 and Northwood are trademarks of Intel Corporation.
- Intel 845 is trademark of Intel Corporation.

# **SOLTEK AROUND THE WORLD**

## **SOLTEK COMPUTER INC.**

---

Address : 7F, No. 306-3, Ta-Tung Rd, Sec.1, Hsi-Chih, Taipei-Hsien, Taiwan, R.O.C.  
Telephone : 886-2-2642-9060  
Fax : 886-2-2642-9065  
E-mail : [sales@soltek.com.tw](mailto:sales@soltek.com.tw)  
Web site : <http://www.soltek.com.tw>

## **SOUL TECHNOLOGY EUROPE B.V.**

---

Address : Hongkongstraat 55, 3047 BP Rotterdam. The Netherlands  
Telephone : 31-10-2457492  
Fax : 31-10-2457493  
E-mail : [sales@soultech-europe.com](mailto:sales@soultech-europe.com)  
Web site : <http://www.soultech-europe.com>

# CONTENT

<b>Chapter 1 Specification .....</b>	<b>9</b>
1-1 Mainboard Specifications .....	10
1-1.1 CPU Socket .....	10
1-1.2 System Chipset Architecture .....	10
1-1.3 Memory .....	10
1-1.4 AWARD BIOS V6.0 .....	10
1-1.5 Hardware Monitoring .....	10
1-1.6 Sound Controller Creative / AC'97 optional .....	11
1-1.7 Multi-I/O Function .....	11
1-1.8 Expansion Slots .....	11
1-1.9 Accelerated Graphics port (AGP) Interface .....	11
1-1.10 Power Management .....	12
1-1.11 FORM FACTOR .....	12
1-1.12 Disk Array Design .....	12
1-1.13 Voice Diagnostic Technology .....	12
1-2 Board Layout with Optional Features -- Series SL-85SD ...	13
1-3 Mainboard Specification Table .....	14
1-4 Chipset System Block Diagram .....	15
<b>Chapter 2 Hardware Setup .....</b>	<b>17</b>
2-1 CPU Pentium 4 Installation with Socket 478 .....	18
2-2 Pentium 4 CPU Fan Installation: .....	19
2-3 Memory Installation .....	20
2-3.1 To Install DIMM Module : .....	20
2-3.2 To Remove a DIMM: .....	21
2-3.3 LED2 DIMM Socket On Indicator .....	21
2-4 AGP 4X (Accelerated Graphics Port) Installation : .....	22
2-5 HDD/FDD Installation .....	23
2-6 ATX version 2.03 Power Supply Installation .....	25
2-7 Jumper and Switch Settings .....	26

2-7.1 Switch 1 CPU Clock Select .....	27
2-7.2 JBAT1 Clear CMOS .....	28
2-7.3 JP4 RAID Controller Select: .....	28
2-7.4 JP5 Creative Sound Select .....	28
2-7.5 JP9 Voice Diagnostic Language Select .....	29
2-8 Other Connectors Configuration .....	30
2-8.1 On Board FAN Connectors (FAN1,FAN2, FAN3) .....	30
2-8.2 WOL1 Wake On LAN .....	31
2-8.3 CD-ROM Audio Connector (CD_IN1/CD_IN2) .....	32
2-8.4 TAD1/TV1 Connector .....	32
2-8.5 Thermal Sensor Connector (RT2) .....	33
2-8.6 Complex Header NJ1 .....	34
2-8.7 ATX Power Supply Connectors version 2.03 for Pentium 4 .....	36
2-8.8 Communication And Networking Riser Slot (CNR) .....	37
2-8.9 USB Header (Header USB1) .....	38
2-8.10 PS/2 Mouse And PS/2 Keyboard .....	38
2-8.11 Chassis Panel Connector .....	39
2-9 IRQ Description .....	40
<b>Chapter 3 Software Setup .....</b>	<b>42</b>
3-1 Install "Intel Chipset Software Installation Utility" .....	43
3-2 Install "Intel Application Accelerator": .....	44
3-3 AC'97 Driver Installation .....	45
3-4 Creative Sound Driver Installation .....	46
3-4.1 To Install Creative Sound Driver .....	46
3-4.2 To Enable The Rear Line Out (For 4 Speakers) .....	47
3-5 Install Windbond Hardware Monitor Utility .....	49
3-6 Install Promise RAID Controller .....	51
<b>Chapter 4 BIOS Setup .....</b>	<b>52</b>
4-1 About BIOS Setup .....	53
4-2 To run BIOS Setup .....	53
4-3 About CMOS .....	53

4-4 The POST ( Power On Self Test ) .....	53
4-5 To upgrade BIOS .....	54
4-5.1 Before Upgrading BIOS .....	54
4-5.2 Upgrade Process .....	54
4-6 BIOS Setup --- CMOS Setup Utility .....	57
4-6.1 CMOS Setup Utility .....	57
4-6.2 Standard CMOS Setup .....	58
4-6.3 Advanced BIOS Features .....	61
4-6.4 Advanced Chipset Features .....	65
4-6.5 Integrated Peripherals .....	68
4-6.6 Power Management Setup .....	73
4-6.7 PNP / PCI Configuration .....	78
4-6.8 SmartDoc Anti-Burn Shield .....	81
4-6.9 Frequency/Voltage Control .....	83
4-6.10 Load Optimized Default .....	86
4-6.11 Set Supervisor / User Password .....	87
4-6.12 Save & Exit Setup .....	88
4-6.13 Exit Without Saving .....	88
<b>Chapter 5 RAID Controller .....</b>	<b>90</b>
5-0 Before Creating Disk Array: .....	91
5-1 Creating Your Disk Array .....	92
5-1.1 Creating An Array For Performance .....	92
5-1.2 Creating A Security (Mirror) Array With New Drives .....	94
5-1.3 Creating Security Array With Existing Data Drive .....	96
5-2 Using FASTBUILDTM Configuration Utility .....	99
5-2.1 Viewing FastTrak100-Lite BIOS Screen .....	99
5-2.2 Navigating the FastBuildTM Setup Menu .....	100
5-2.3 Using the Main Menu .....	100
5-2.4 Creating Arrays Automatically .....	101
5-2.5 Viewing Drive Assignments .....	103
5-2.6 View an Array .....	103
5-2.7 Adding Fault Tolerance to an Existing Drive .....	104
5-2.8 Making a FastTrak100-Lite Disk Array Bootable .....	105

---

5-2.9 Creating a “Hot” Spare Drive for Mirroring Arrays .....	106
5-2.10 How FastTrak100-Lite Orders Arrays .....	107
5-2.11 How FastTrak100-Lite Saves Array Information .....	107
5-2.12 Deleting An Array .....	107
5-2.13 Rebuilding A Mirroring Array .....	109
5-2.14 Viewing Controller Settings .....	111
5-2.15 Halting FastTrak BIOS On Bootup Errors .....	111
5-3 Installing Drivers .....	112
5-3.1 For Windows 2000 .....	112
5-3.2 Windows 95/98 .....	114
5-3.3 DOS/Windows 3.1x .....	117
5-3.4 Windows NT4.0 .....	118
<b>APPENDICES .....</b>	<b>121</b>
Appendix-1 Identify BIOS Version & BIOS Part Number .....	122
Appendix-2 Identify Mainboard Model Number .....	124
Appendix-3 Technical Terms .....	125

**ITEM LIST CHECKUP**

---

- Mainboard
- Support CD
- Floppy disk for SL-85SD<sup>+</sup> and SL-85SD<sup>+</sup>-X  
RAID Drivers
- Bundled Bonus Pack CD
- Bundled Bonus Pack Manual
- Temperature Sensor Cable
- ATA66/100 IDE Cable
- RS232 Cable
- FDD Cable
- User's Manual



# **Chapter 1 Specification**

## **Introduction**

- This chapter introduces the characteristics of this series of mainboards. It includes the information on the chipset, CPU types, built-in functions and layout. Users will have more ideas about this powerful series after reading this chapter.

**The topics contained in this chapter are:**

**1-1 Mainboard Specifications**

**1-2 Mainboard Layout**

**1-3 Mainboard Specification Table**

**1-4 Chipset Diagram**

## **1-1 Mainboard Specifications**

### **1-1.1 CPU Socket**

- CPU Socket 478B on board, supporting Intel® Pentium 4 and Northwood processors in the 478-pin package for 400MHz System Bus.

### **1-1.2 System Chipset Architecture**

- INTEL 845 Chipset Memory Control Hub (MCH):  
To work with Intel Pentium 4 Processor for managing and arbitrating between 4 interfaces:
  - the System Bus (Host Interface);
  - the memory Interface;
  - the AGP Port and
  - the Hub Interface;
- MCH Clockings:
  - Asynchronous;
  - System Bus target speed at 400MHz;
  - AGP and Hub Interface constantly at 66MHz base;
- Intel ICH2 Chipset (Second generation I/O Controller Hub):  
Communicating with Intel 845 by the Hub interface at 66MHz/266MB/s;
  - Transmitting Interrupt related messages;
  - Transmitting Power management events;
  - Transmitting SMI, SCI, SERR indication messages;

### **1-1.3 Memory**

- 3pcs of DIMM on board for single / double sided DIMMs, supported by 3.3V default voltage (DIMM voltage selectable in BIOS setup):
- Intel 845 MCH directly supporting one channel of SDRAM up to 3GB capacity.
  - ECC SDRAM also supported.

### **1-1.4 AWARD BIOS V6.0**

- Supporting Plug & Play V1.0.
- FLASH MEMORY for easy upgrade.
- Supporting BIOS writing protection.
- Year 2000 compliant.

### **1-1.5 Hardware Monitoring**

- Programmable control, status, to provide monitoring and alarm for flexible desktop management of hardware temperatures. Utility Software is enclosed in Support CD to help display monitoring statuses of:
  - 9 positive voltages, 2 types of hardware temperatures, 3 Fan speeds;

### **1-1.6 Sound Controller Creative / AC'97 optional**

- Creative CT5880 Audio Controller (4 channels).  
(for SL-85SD+, SL-85SD+-X, SL-85SDB, SL-85SDB-X)
- AC'97 Audio (for SL-85SD, SL-85SD-X)

### **1-1.7 Multi-I/O Function**

- Integrated IDE Controller, supporting:
  - 2x Ultra ATA100 / 66 / 33 Connectors
  - Two UARTs for Complete Serial Ports (2x COM ).
- Promise IDE RAID Controller:
  - Supporting other two Ultra ATA-100 / 66/ 33 Connectors for up to 4 RAID disks  
(For SL-85SD+ and SL-85SD+-X only)
- Dedicated IR Connector:
  - Third serial port dedicated to IR function either through the two complete serial ports or the third dedicated port Infrared-IrDA (HPSIR) and ASK (Amplitude Shift Keyed) IR.
- Multi-mode parallel connector:
  - Standard mode, ECP and EPP support.
- Floppy Disk connector:
  - One FDD connector with drive swap support.
- Universal Serial Bus connector:
  - USB V1.1 compliant.
  - 2 built-in USB connectors and one USB Header (USB1) which requires an optional USB cable to provide 2 more optional USB ports.
- PS/2 Keyboard connector.
- PS/2 Mouse connector.

### **1-1.8 Expansion Slots**

- Six PCI bus Master slots.
- One AGP 4x mode slot.
- One CNR slot.
- Three DIMM slots.

### **1-1.9 Accelerated Graphics port (AGP) Interface**

One AGP slot on board is supported by the Intel 845 Chipset MCH AGP Interface in 1.5V mode (with AGP voltage selectable in BIOS Setup):

- Providing 1x/ 2x/ 4x AGP signalling, 2x / 4x fast writes;
- AGP v2.0 compliant.

### **1-1.10 Power Management**

- ACPI 1.0B compliant (Advanced Configuration and Power Interface).
- APM V1.2 compliant (Legacy power management).
- Supporting ACPI suspend STR mode (Suspend To DRAM) and POS mode (Power On Suspend).
- System event monitoring with two event classes.
- Supporting PS/2 Keyboard & Mouse power on.
- Supporting Wake On LAN (WOL) & Wake On Modem.
- Supporting real time clock (RTC) with date alarm, month alarm, and century field.
- USB wake-up Function.

### **1-1.11 FORM FACTOR**

- ATX form factor, ATX spec. version 2.03 compliant, with a Main Power Connector, a +12V Power Connector and an Aux Power Connector.
- Mainboard size: 30.5cm x 24.5cm.

### **1-1.12 Disk Array Design**

On board SL-85SD<sup>+</sup> and SL-85SD<sup>+</sup>-X

- Promise FastTrak100-Lite RAID controller on board.
- Supporting striping (RAID 0) and mirroring (RAID 1) Disk Arrays.
- Supporting Ultra ATA/100 / 66 /33 specification up to 100MB/sec per drive.
- Providing two RAID Connectors IDE3 and IDE4, Compatible with Ultra ATA/100/66/33 and EIDE.

### **1-1.13 Voice Diagnostic Technology**

On board SL-85SD-X, SL-85SD<sup>+</sup>-X and SL-85SDB-X:

- A Voice Diagnostic Function is incorporated in “Advanced BIOS Features” of the “Award BIOS Setup” as “VD-Tech II Function”. With this function enabled in “Advanced BIOS Features”, it will voice out the problems or conflicts whenever user configures the components or boots up the PC system.
- The voice can be in Chinese or English, depending on the setting of Jumper JP10. Change the setting of JP10 will change the language of the voice.

## 1-2 Board Layout with Optional Features -- Series SL-85SD

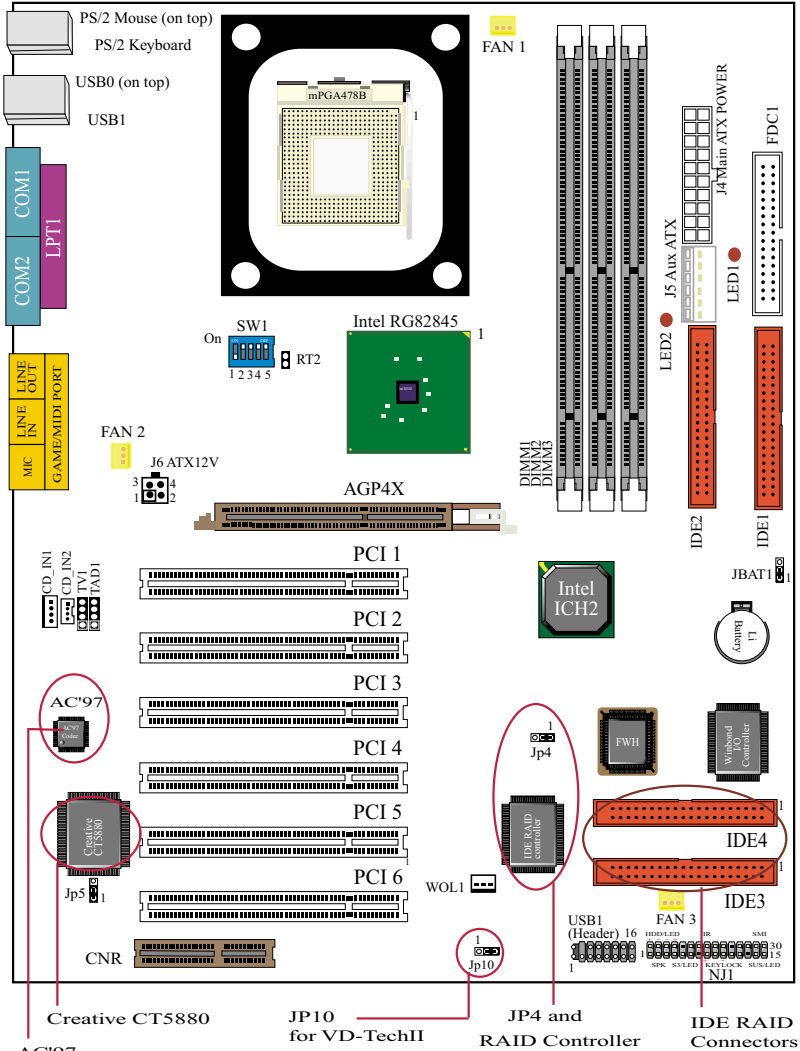

### Optional features of Series SL-85SD:

Feature	85SD	85SD-X	85SD <sup>+</sup>	85SD <sup>+</sup> -X	85SDB	85SDB-X
IDE RAID	No		Yes		No	
Audio	AC'97 Audio		Creative CT5880		Creative CT5880	
VD-Tech II	No	Yes	No	Yes	No	Yes

### 1-3 Mainboard Specification Table

Series SL-85SD	85SD	85SD-X	85SD+	85SD+-X	85SDB	85SDB-X
Memory Controller Hub	Intel 845 MCH					
I/O Controller Hub	Intel 82801BA (ICH2)					
I/O Chip	Winbond W83627					
Memory	Supporting SDRAM up to 3GB 3 DIMM Slots					
AGP Interface	AGP 4X Mode					
Audio	AC'97		Creative CT5880		Creative CT5880	
Onboard IDE	2 x ATA 33/66/100 IDE ports					
Onboard IDE RAID Controller, 2xATA 33/66/100 RAID ports for 4 devices	No		Yes		No	
I/O Connectors	4 x USB ports, 1 x FDD port, 2 x COM ports, 1 x LPT port, 1 IrDA, 1 PS/2 Mouse, 1 PS/2 K/B					
PCI slot	6 PCI Master Slots					
CNR slot	1 x CNR slot					
Bilingual VD-Tech II (Voice diagnostic Tech.)	No	Yes	No	Yes	No	Yes
Hardware Monitoring	Yes to all members					
BIOS writing Protection	Yes to all members					
Keyboard power on function & USB wake up Function	Yes to all members					
Remark						

## 1-4 Chipset System Block Diagram

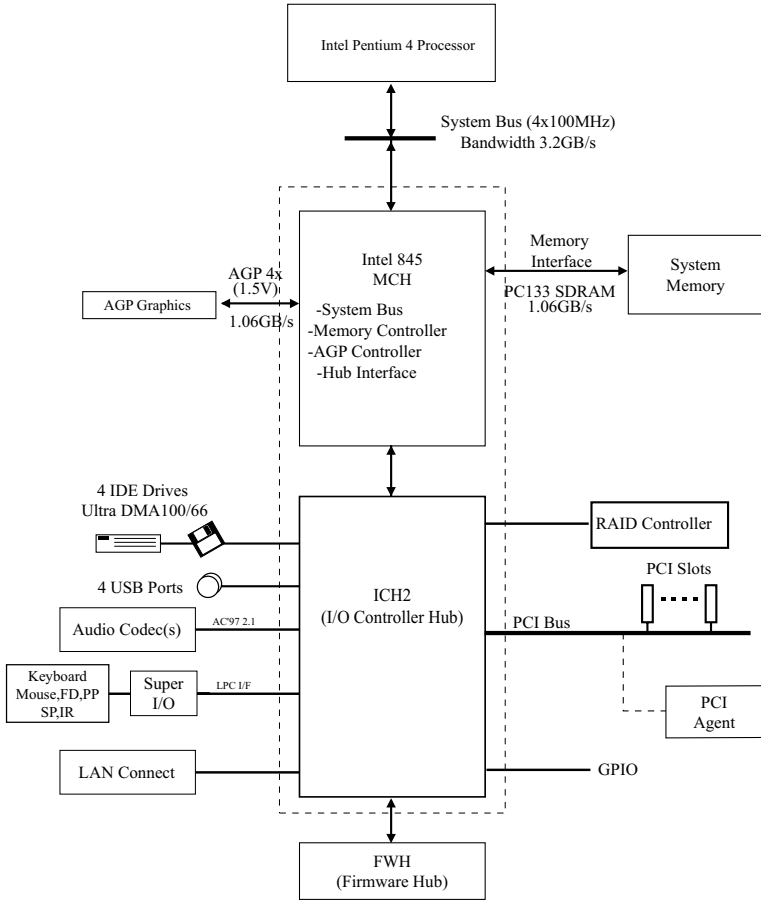

Intel 845MCH + ICH2 Chipset Diagram

***MEMO***



# **Chapter 2 Hardware Setup**

**To Get things ready for Hardware setup !!!**

- 1. We recommend to install your CPU before any other componentes. For detailed installalation instructions of processor, you can also refer to the pamphlet enclosed in your CPU package.**
- 2. Installing a cooling fan with a good heatsink is a must for proper heat dissipation for your CPU. Get ready an appropriate fan with heatsink for proper installation. Inproper fan and installation will damage your CPU.**
- 3. In case CPU Vcore, CPU clock or Frequency Ratio is adjustable on board, please follow the instructions described in the User manual for proper setup. In-correct setting will cause damage to your CPU.**

**The following topics are included in this chapter:**

**2-1 Pentium 4 CPU Installation**

**2-2 Pentium 4 CPU Fan Installation**

**2-3 Memory Installation**

**2-4 HDD/FDD Installation**

**2-5 AGP 4X (Accelerated Graphic Port) Installation**

**2-6 ATX 2.03 Power Supply Installation**

**2-7 Jumper Settings for Devices on board**

**2-8 Other Connectors Configuration**

## 2-1 CPU Pentium 4 Installation with Socket 478

*This series of mainboards are built with CPU Socket 478 (with 478 pins) supporting the Intel Pentium 4 CPU:*

- *Follow the steps described in this section to install the 478-pin Pentium 4 CPU into the on board Socket 478.*
- *After installation of Pentium 4 CPU, you must also install the specific Pentium 4 CPU fan designed in tandem with this CPU. This CPU Fan installation is described in next section.*

- 1** First pull sideways the lever of Socket 478, and then turn it up 90-degree so as to raise the upper layer of the socket from the lower platform.

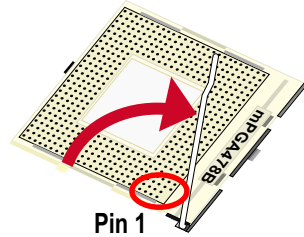

- 2** Configure Pin 1 of CPU to Pin 1 of the Socket, just as the way shown in the diagram on the left. Adjust the position of CPU until you can feel all CPU pins can get into the socket with ease.

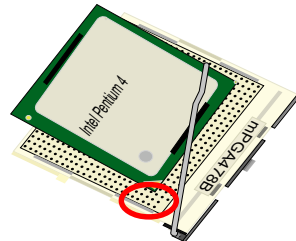

- 3** Make sure that all CPU pins have completely entered the socket and then lower down the lever to lock up CPU to socket.

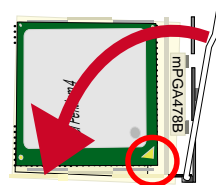

2-2 Pentium 4 CPU Fan Installation:

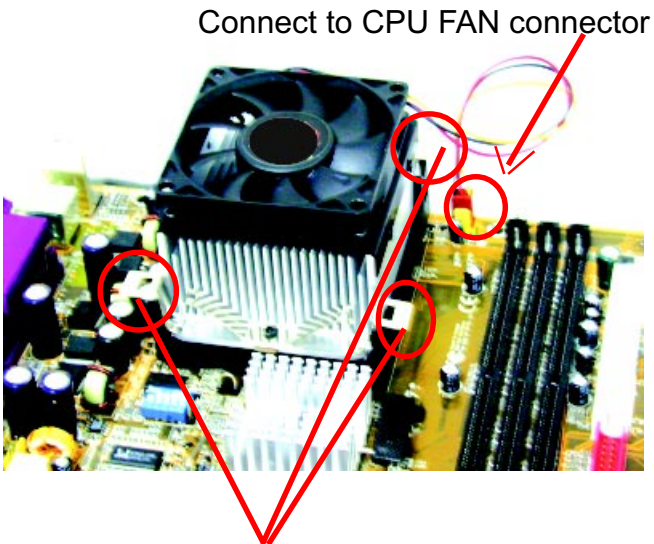
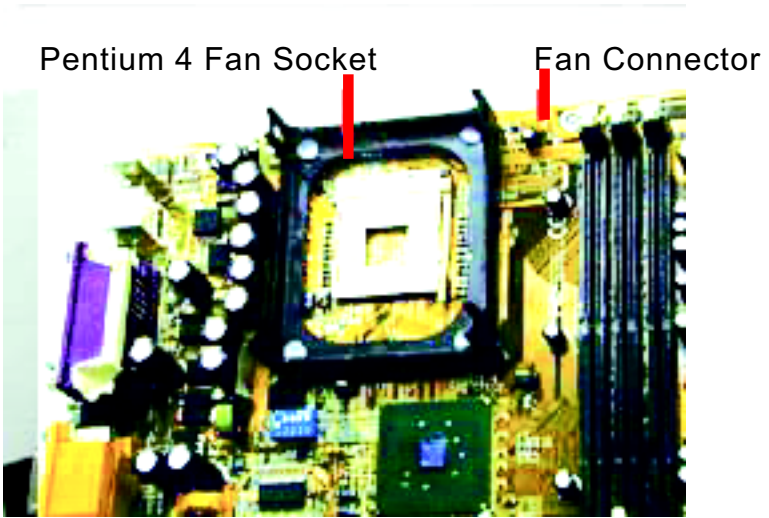

Press down 4 latches to lock fan to fan socket

## 2-3 Memory Installation

### *How to tackle with the memory Modules:*

- Make sure to unplug your power supply before adding or removing memory module. Failure to do so may cause severe damage to both your mainboard and the memory module.
- Pay attention to the orientation of the DIMM slots. Forcing a DIMM in a socket improperly will damage the memory module and socket.
- Make sure you have the right type of memory module for your mainboard.

#### 2-3.1 To Install DIMM Module :

- This series of mainboards only supports SDRAM up to 3GB capacity with 3 DIMM sockets on board. Do not insert other type of modules into these sockets. EDO or FTP DRAM is not supported by this mainboard either.
- DIMM has 168-pins and two notches. Insert a DIMM vertically into the DIMM socket with each notch matching the one in the socket. Press the DIMM down in a gradual way until it surely reaches the bottom and clicks straight up the two latches on the left and right of the socket.

**Key Point:** Press the module down gradually until it has totally reached the socket bottom and clicked up both two socket latches completely. If any one of the latches has not turned up completely, you should unplug the module and press it down the socket a bit more firmly.

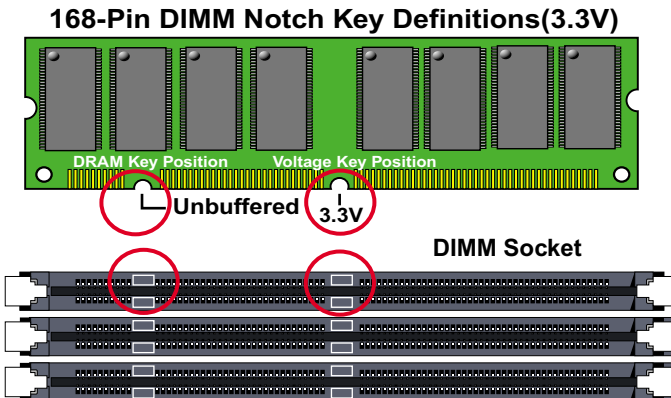

### 2-3.2 To Remove a DIMM:

- Press down the holding latches on both sides of socket and the module will be released from the DIMM socket.

### 2-3.3 LED2 DIMM Socket On Indicator

- An indicator LED2 is on board this series of mainboard. Whenever system is started, all the DIMM sockets on board will also be powered on with the set voltage, resulting in LED2 lighting up. This LED2 is to warn users that, whenever DIMM socket is powered, no memory module should be removed from or added into it.

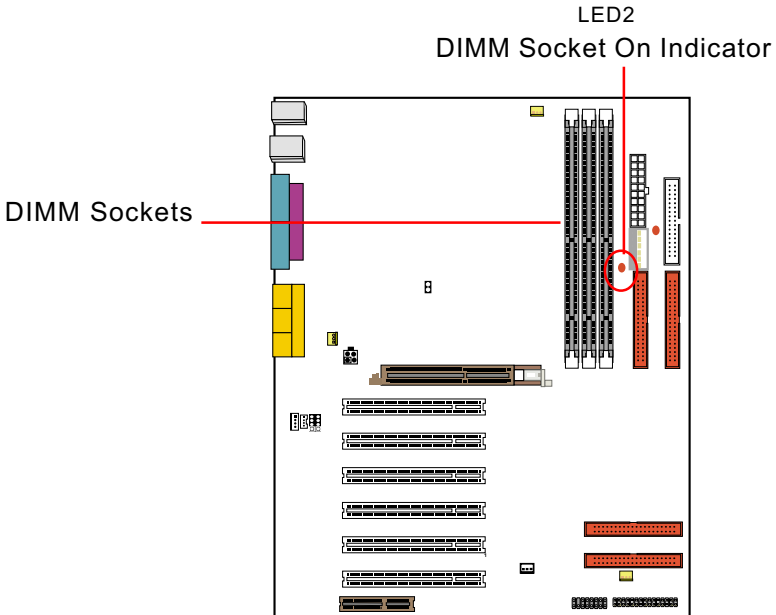

### 2-4 AGP 4X (Accelerated Graphics Port) Installation :

- The AGP 4X slot on board supports solely 4X AGP card configuration. User should not insert 1X / 2X AGP card to this mainboard.
- LED1 AGP Protection Indicator is on board this series. In case inappropriate AGP card (such as AGP 2X) is inserted into this AGP 4X Slot, LED1 will light up to warn that AGP installation is improper. The wrong AGP card should be replaced; otherwise system cannot be booted.

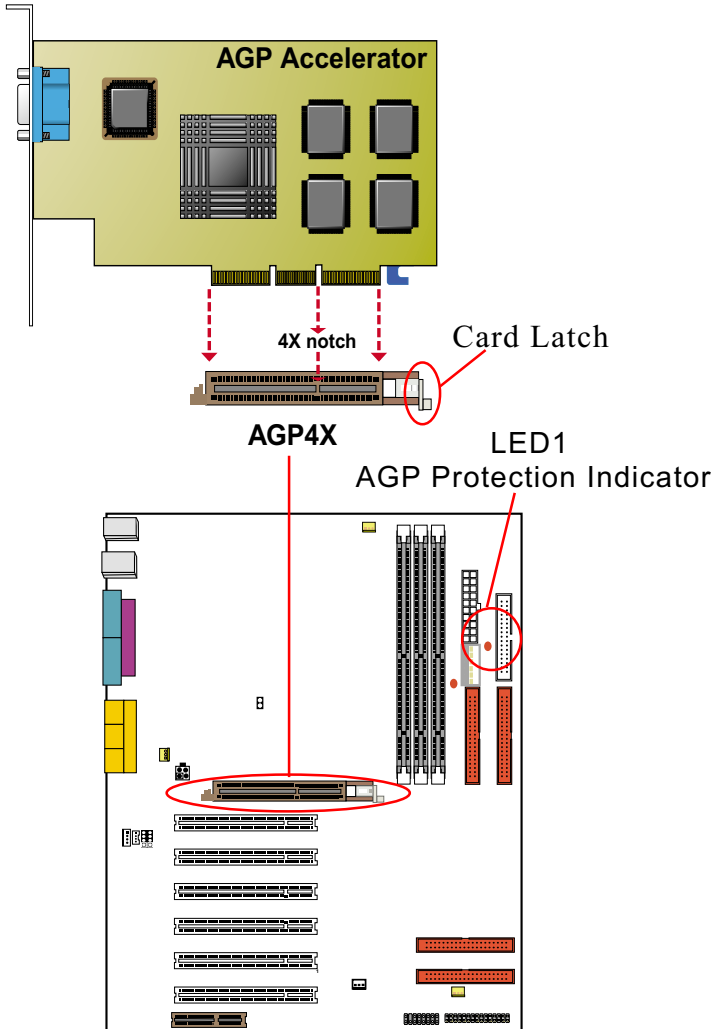

## 2-5 HDD/FDD Installation

- To install HDD (Hard Disk Drive), you may connect the connector of IDE cable to the primary (IDE1) or secondary (IDE2) connector on board, and then connect the gray connector to your slave device and the black connector to your master device. If you install two hard disks, you must configure the second drive to Slave mode by setting its jumpers correctly. Please refer to your hard disk documentation for the jumper settings.

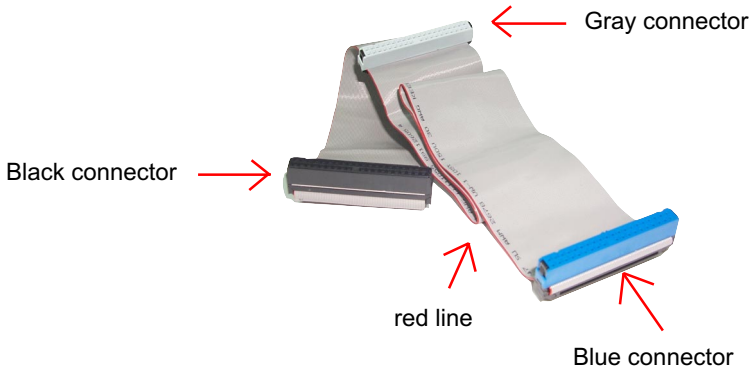
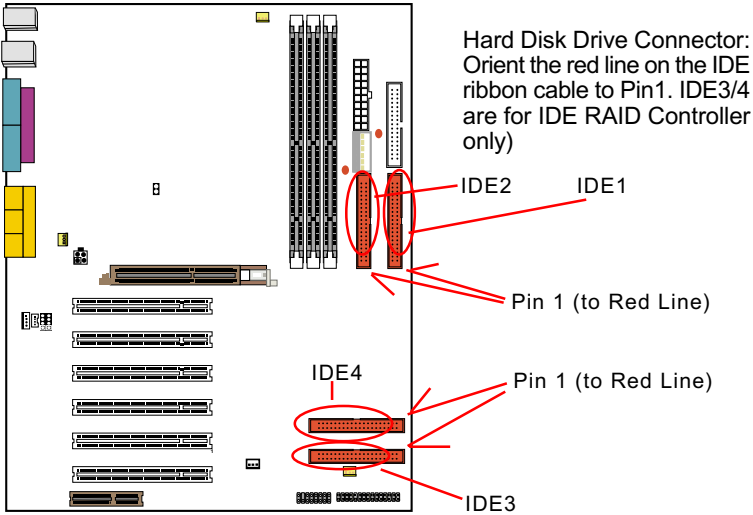

IDE Cable

- To install FDD (Floppy Disk Drive), you should connect the end of cable with single connector to the board , and connect the other end with two plugs to the floppy drives.

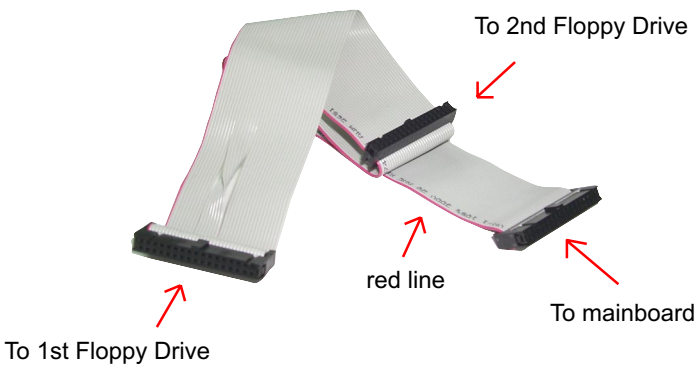
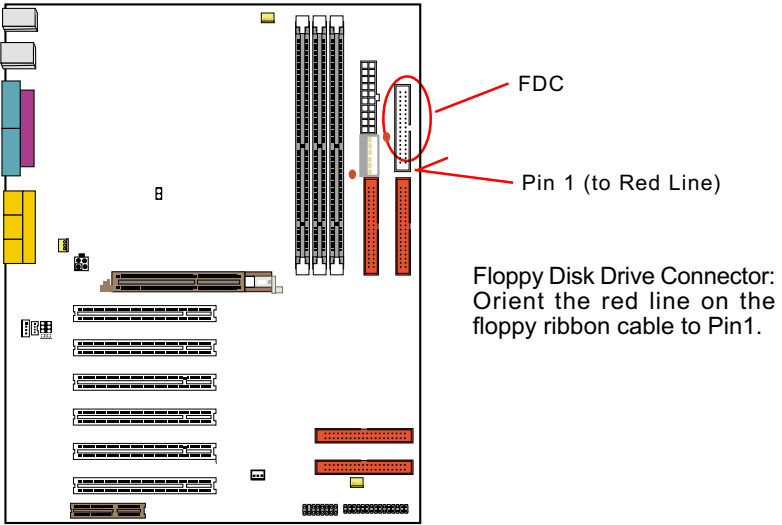

**FDD Cable**



## 2-6 ATX version 2.03 Power Supply Installation

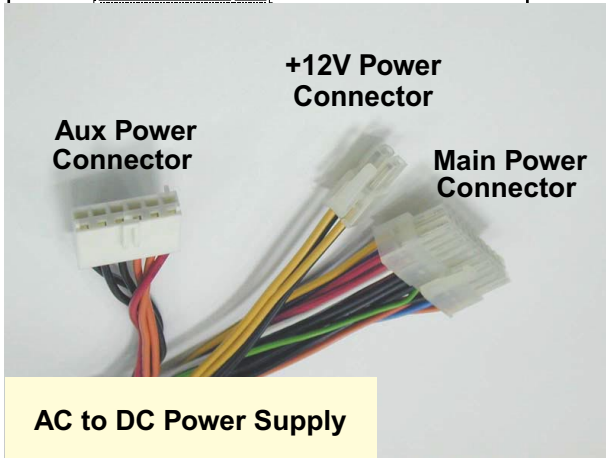
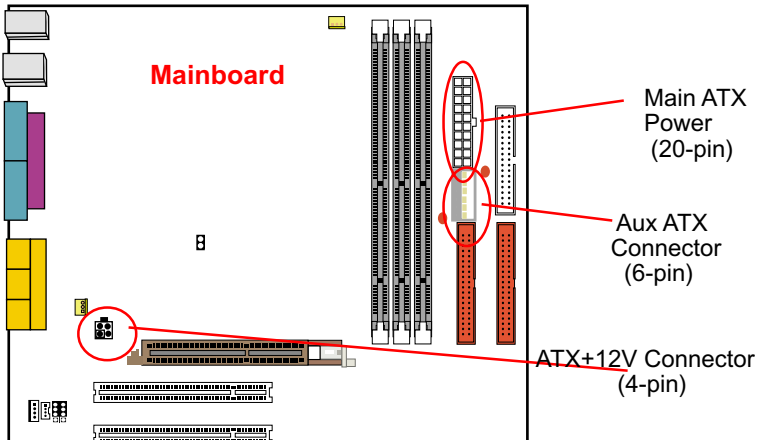

Intel Pentium 4 should be supported by ATX ver.2.03 power supply. To set up ATX2.03 power supply on this series, 3 ATX power connectors are needed:

1. Main ATX Power Connector to Main Power DC output of Power Supply;
2. Aux ATX Connector to Aux Power DC output of Power Supply;
3. ATX +12V Connector to +12V DC output of Power Supply;

## 2-7 Jumper and Switch Settings

- The following diagrams show the locations and settings of jumper blocks on the mainboard.

SW1 On  
Off CPU Clock Select



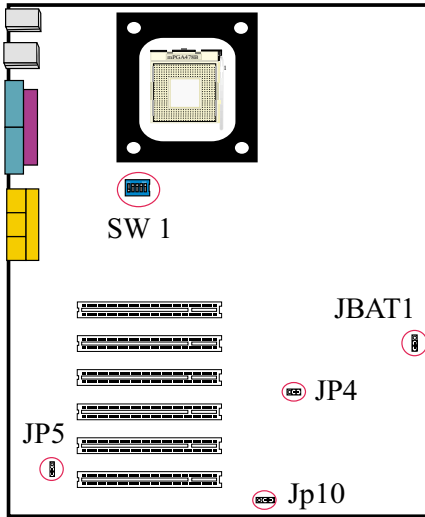

12345  
Off On On On On (Default)

CPU clock (MHz)	S1	S2	S3	S4	S5
100 (Default)	off	on	on	on	on
103	on	off	on	on	on
105	off	off	on	on	on
111	on	off	off	on	on
130	off	off	on	off	on
133	on	on	on	on	off





**JBAT1**  
Clear CMOS

 2-3 closed  
1 



To clear CMOS

-----

 1-2 closed  
1  (default)



To return to normal status

**Jp5**  
Creative Sound Select

 2-3 closed  
1 



Creative disabled

-----

 1-2 closed  
1  (default)



Creative enabled

**Jp4**  
RAID Controller

 1-2 closed  
1 

Enabled (default)

-----

 1-2 closed  
1 

Disabled

**Jp10** VD-Tech  
Language Select

1  2-3 closed

English (default)

-----

1  1-2 closed

Chinese

**How to tackle with Jumpers:**

- Do not remove the jumper when power is on. Always make sure the power is off before changing any jumper settings. Otherwise, mainboard could be damaged.
- In the Jumper setting diagram, all jumper pins covered with black marks stand for closed pins by jumper caps.

**2-7.1 Switch 1 CPU Clock Select**

- This Series of mainboards are shipped to users with a 5-DIP Switch 1, by which user can select a CPU clock to match with the Pentium 4 processor selected on board. So users are not recommended to take Switch 1 as a tool for overclocking. It is safer and more advisable for users to select the CPU clock as close as possible to the one marked on the selected CPU.

CPU clock (MHz)	S1	S2	S3	S4	S5	
100 (Default)	off	on	on	on	on	
103	on	off	on	on	on	
105	off	off	on	on	on	
111	on	off	off	on	on	
130	off	off	on	off	on	
133	on	on	on	on	off	

**• Advice from our Engineering Team:**

If you insert a Pentium 4 processor of 100MHz to the CPU socket and select 103MHz or any higher Switch setting, you are taking the risk of breaking the stability of your CPU as well as the mainboard. Overclocking should always take all other components on board into account.

### 2-7.2 JBAT1 Clear CMOS

• When you have problem with rebooting your system, you can clear CMOS data and restore it to default value. To clear CMOS with Jumper JBAT1, please follow the steps below:

- (1) Power off system;
- (2) Set JBAT1 to Pin 2-3 closed.
- (3) After 2 or 3 seconds, return the JBAT1 setting to Pin1-2 closed.
- (4) CMOS data are restored to default.  
Remember never clear CMOS when system power is on.

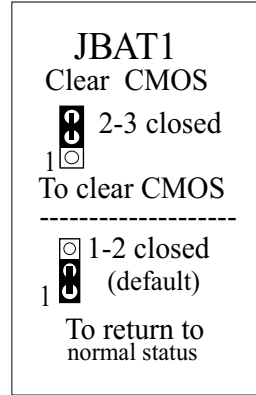

### 2-7.3 JP4 RAID Controller Select:

On board SL-85SD<sup>+</sup> and SL-85SD<sup>+</sup>-X

• For the mainboards carrying Promise RAID controller, JP4 at Pin1-2 closed is to enable the RAID functions so that users can start to install the RAID arrays and RAID drivers. If JP4 is set at Pin2-3 closed, the RAID controller is disabled.

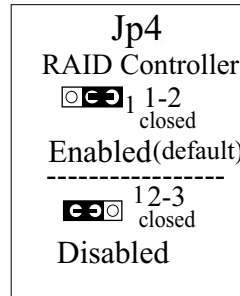

### 2-7.4 JP5 Creative Sound Select

On board SL-85SD<sup>+</sup>, 85SD<sup>+</sup>-X, 85SDB and 85SDB-X

• For mainboards carrying Creative CT5880 chip, JP5 is to enable / disable the Creative sound function. JP5 is default at Pin1-2 closed to enable the Creative sound. If user wants to use other sound card, set JP5 to Pin2-3 closed so as to disable Creative sound.

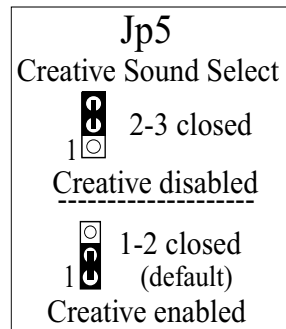

### 2-7.5 JP10 Voice Diagnostic Language Select

On board SL-85SD-X, 85SD<sup>+</sup>-X and 85SDB-X

- A Voice Diagnostic Function is incorporated in “Advanced BIOS Features” of the “Award BIOS Setup” as “VD-Tech II Function”. With this function enabled in “Advanced BIOS Features”, it will voice out the problems or conflicts whenever user configures the components or boots up the PC system.
- The voice can be in Chinese or English, depending on the setting of Jumper JP10. Change the setting of JP10 will change the language of the voice.

English Voice Content
<p>1.The Processor might be damaged or not installed properly.                  2.The memory module might be damaged or not installed properly.                  3.The VGA card might be damaged or not installed properly.                  4.The IDE cable might be damaged or not installed properly.                  5.Please clear CMOS setting.                  6.System available.</p>
國語語音內容
<p>1.中央處理器可能損壞或未插好                  2.記憶體模組可能損壞或未插好                  3.顯示卡可能損壞或未插好                  4.IDE排線可能損壞或未插好                  5.請清除CMOS設定                  6.系統開機成功</p>

Jp10 VD-Tech  
Language Select

1   2-3 closed

English (default)

-----

1   1-2 closed

Chinese

## 2-8 Other Connectors Configuration

- This section lists out all connectors configurations for users' reference.

### 2-8.1 On Board FAN Connectors (FAN1,FAN2, FAN3)

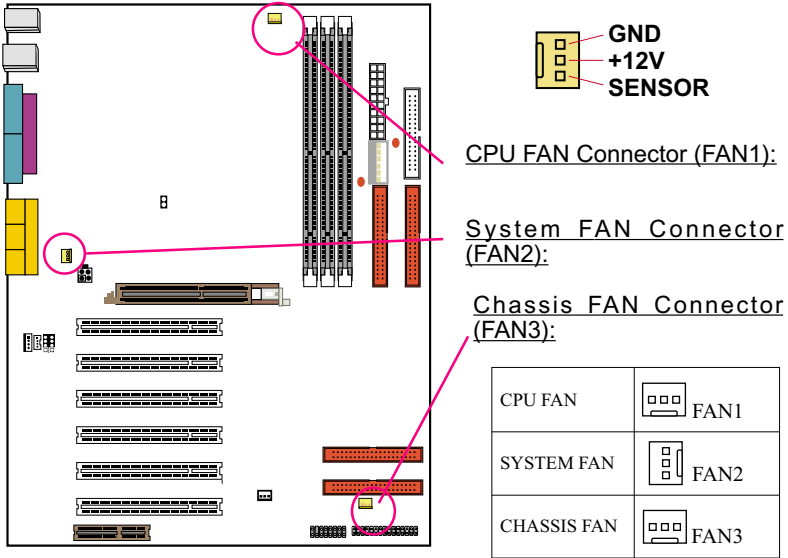

These fan connectors support CPU/System/chassis cooling fan with +12V. When connecting wire to FAN connectors, users should pay attention that the red wire is for the positive current and should be connected to pin +12V, and the black wire is Ground and should be connected to pin GND. If your mainboard has Hardware Monitor chipset on-board, you must use a specially designed fan with speed sensor to take advantage of this function.

For fans with speed sensors, each rotation of the fan blades will send out 2 electric pulses, by which System Hardware Monitor will work out the fan rotation speed by counting the pulses.

**NOTE :** We use 3 “Yellow” fan connectors to mark that they support fan speed sensor function.

### 2-8.2 WOL1 Wake On LAN

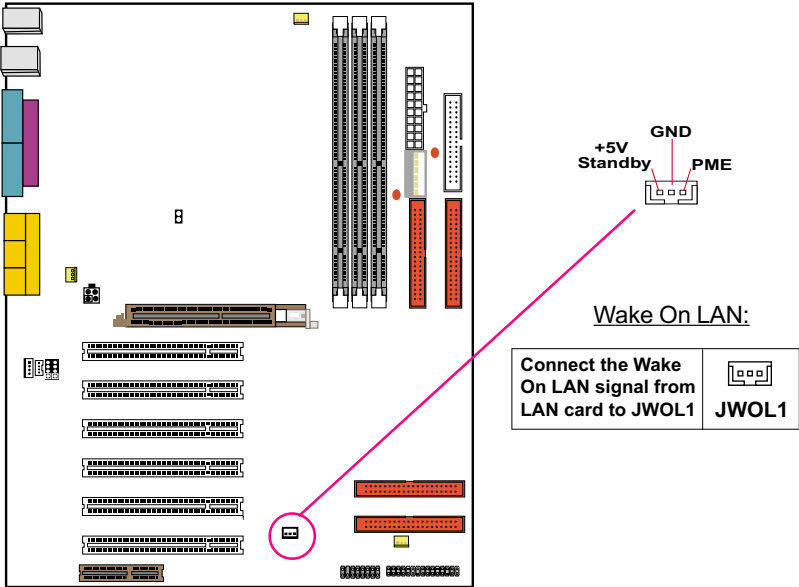

This connector connects to a LAN card with a Wake On LAN output. The connector powers up the system when it receives a wake-up packet or signal through the LAN card.

This feature requires that Wake On LAN feature is enabled in the BIOS setting called **“Power Management Setup”** and that your system must be on ATX power supply with at least **720mA / +5V** standby power.

### 2-8.3 CD-ROM Audio Connector (CD\_IN1/CD\_IN2)

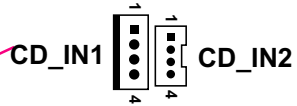
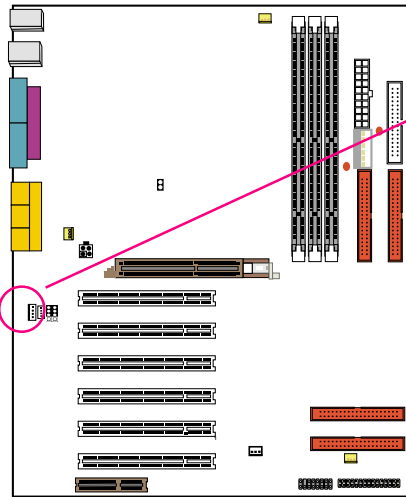

CD-ROM Audio Connector:

PIN NO.	CD_IN1	CD_IN2
PIN 1	GND	Left Channel
PIN 2	Left Channel	GND
PIN 3	GND	GND
PIN 4	Right Channel	Right Channel

### 2-8.4 TAD1/TV1 Connector

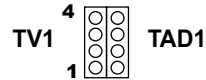
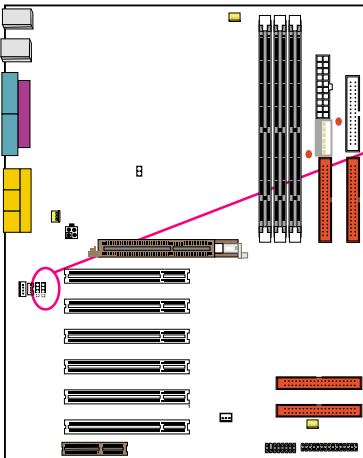

TAD1/TV1 Connector:

PIN NO.	TAD1	TV1
PIN 1	PHONE	TV_L CHANNEL
PIN 2	GND	GND
PIN 3	GND	GND
PIN 4	TADOUT	TV_R CHANNEL

**TAD1** : Telephone Answering Device / Modem connector.  
Connects a voice modem to transmit and receive audio signals.

**TV1** : TV Tuner connector.  
Connects a TV card or second CD-ROM drive.



## 2-8.5 Thermal Sensor Connector (RT2)

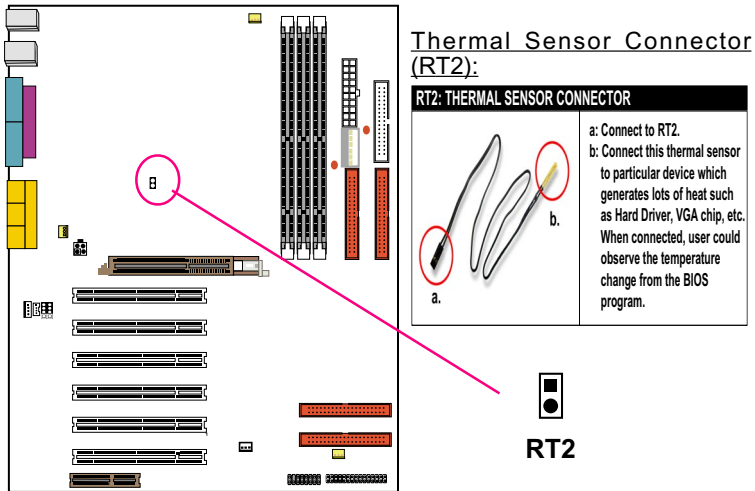

We provide a thermal cable in the mainboard package. This thermal cable is to monitor device generating a lot of heat, such as HDD, Graphics card etc. Please connect the end (a) of the thermal cable to mainboard RT2 header, and tape another end (b) of thermal cable on to the device which you want to monitor. After you have finished the thermal cable installation, you will **see the detected temperature in BIOS setup or Hardware monitor utility.**

## 2-8.6 Complex Header NJ1

- This complex Header consists of 10 connectors providing various supports:

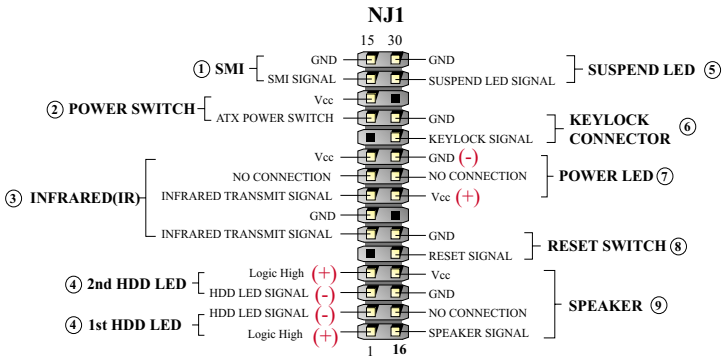
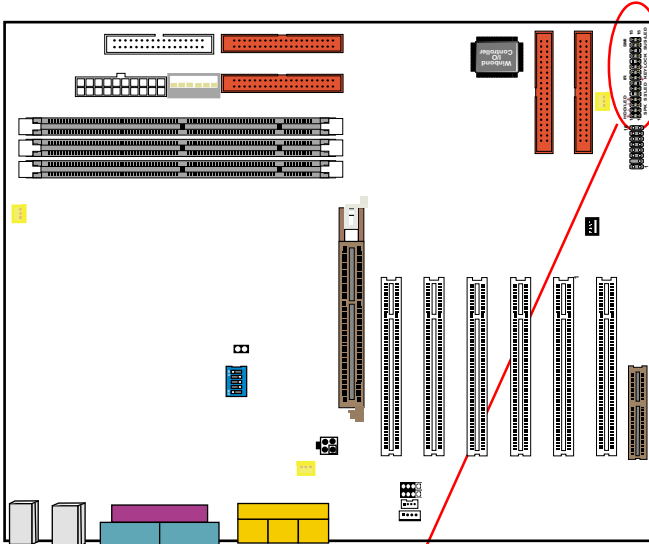

**1. SMI Connector (System Management Interrupt):**

**CONNECTION:** This 2-pin connector is connected to the case-mounted Suspend Switch.

**FUNCTION:** Manually placing the system into a Suspend mode or “Green” mode.

**2. Power Switch Connector:**

**CONNECTION:** Connected to a momentary button or switch.

**FUNCTION:** Manually switching the system between “On” and “Soft Off”. Pressing the momentary button for more than 4 seconds will also turn the system off.

**3. IR Connector (Infrared Connector):**

**CONNECTION:** Connected to Connector IR on board.

**FUNCTION:** Supporting wireless transmitting and receiving module on board.

**4. 1st HDD LED Connector / 2nd HDD LED Connector:**

**CONNECTION:** Connected to HDD LED.

**FUNCTION:** To supply power to HDD LED.

**5. Suspend LED Connector:**

**CONNECTION:** Connected to Suspend indicator.

**FUNCTION:** To supply power to “Suspend indicator”.

**6. Keylock Connector:**

**CONNECTION:** Connected to keylock switch.

**FUNCTION:** To lock keyboard for security purpose.

**7. Power LED Connector:**

**CONNECTION:** Connected to System Power LED.

**FUNCTION:** To supply power to “System Power LED”.

**8. Reset Switch Connector:**

**CONNECTION:** Connected to the case-mounted “Reset Switch”.

**FUNCTION:** To supply power to “Reset Switch” and support system reboot function.

**9. Speaker Connector:**

**CONNECTION:** Connected to the case-mounted Speaker.

**FUNCTION:** To supply power to the case-mounted Speaker.

### 2-8.7 ATX Power Supply Connectors version 2.03 for Pentium 4

- ATX 2.03 Power supply connectors consists of 3 main connectors:
  - (1) J4 Main ATX Power Connector;
  - (2) Aux Power Connector: a 6-pin connector supporting +3.3V and +5V;
  - (3) +12V Power Connector: a 4-pin connector supporting +12V;
- All these three connectors should be connected to an AC to DC Power Supply which supports ATX2.03 version power.

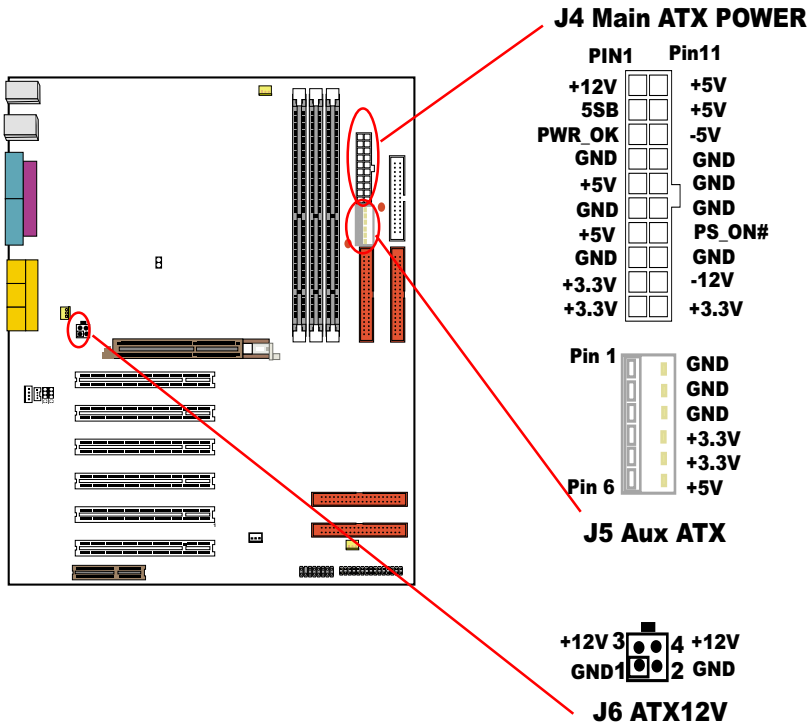

## 2-8.8 Communication And Networking Riser Slot (CNR)

- This connector allows you to use network, modem or audio riser cards.

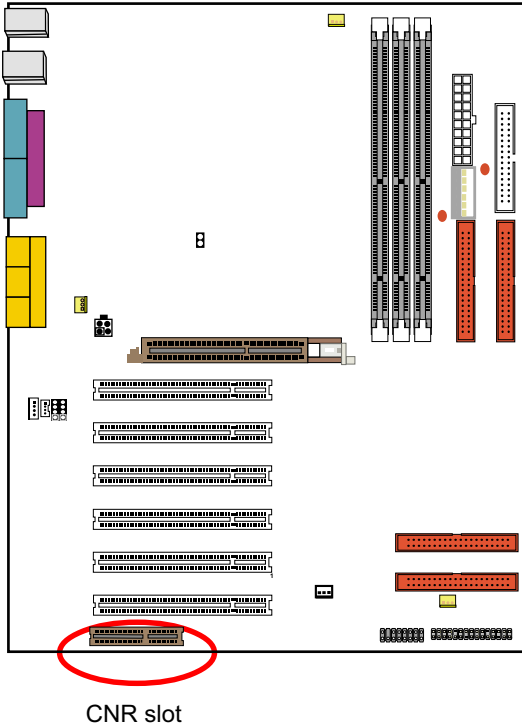

*Note:*

1. If modem CNR is installed, the modem CNR must be set as primary.
2. Only one LAN CNR can be supported.
3. The audio CNR must be set as secondary, if on-chip AC 97 is enabled.
4. CNR devices are not provided with this mainboard.

### 2-8.9 USB Header (Header USB1)

- This header is for providing you two additional USB ports by using an additional USB Cable. User can order the additional USB cable from your mainboard dealers and venders.

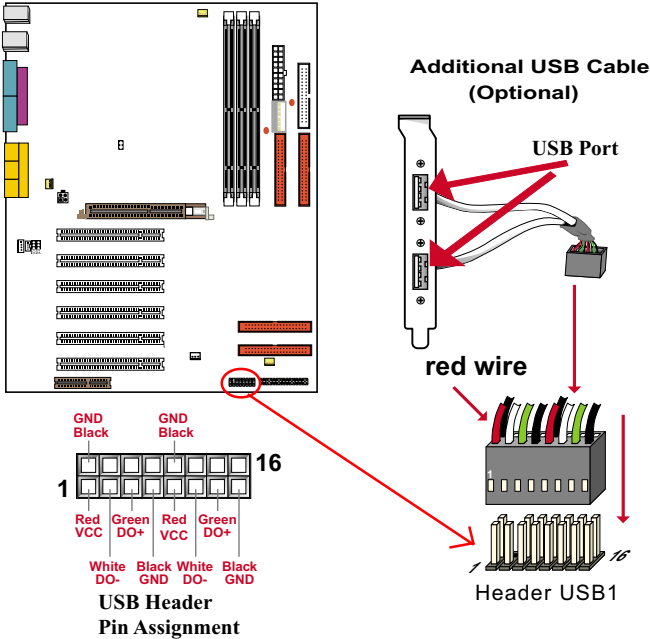

- When plugging the USB cable into Header USB1, users must make sure the red wire is connected to the first pin.

### 2-8.10 PS/2 Mouse And PS/2 Keyboard

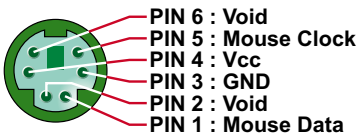

**PS/2 MOUSE**

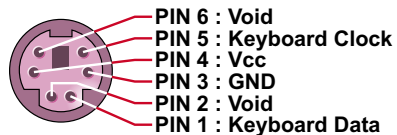

**PS/2 KEYBOARD**

2-8.11 Chassis Panel Connector

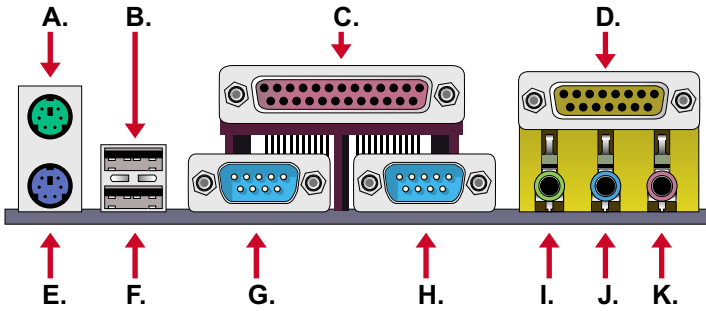

- A : PS/2 MOUSE PORT
- B : USB 0 PORT
- C : LPT1 PORT
- D : GAME/MIDI PORT
- E : PS/2 KEYBOARD PORT
- F : USB 1 PORT
- G : COM1 PORT
- H : COM2 PORT
- I : LINE/SPEAKER OUT
- J : LINE IN (or second speaker  
out for Creative sound)
- K : MICROPHONE INPUT

## 2-9 IRQ Description

IRQ	Function Description	Priority
IRQ 0	System Timer	1
IRQ 1	Keyboard Controller	2
IRQ 2	Programmable Interrupt	N/A
IRQ 3	Serial Port (COM 2)	11
IRQ 4	Serial Port (COM 1)	12
IRQ 5	Free	13
IRQ 6	Floppy Disk Controller	14
IRQ 7	Parallel Port (LPT1)	15
IRQ 8	Real Time Clock (RTC)	3
IRQ 9	Free	4
IRQ 10	Free	5
IRQ 11	Free	6
IRQ 12	PS/2 Mouse Port	7
IRQ 13	Coprocessor	8
IRQ 14	Primary IDE Channel	9
IRQ 15	Secondary IDE Channel	10

- Both ISA and PCI expansion cards may require IRQs. System IRQs are available to cards installed in the ISA expansion bus first, then any remaining IRQs are available to PCI cards. Currently, there are two types of ISA cards.
- The original ISA expansion card design, now referred to as “Legacy” ISA card, requires you to configure the card’s jumpers manually and then install it in any available slot on the ISA bus. To see a map of your used and free IRQs in Windows 98, the **Control Panel** in **My Computer**, contains a **System** icon, which gives you a **Device Manager** tab. Double-Clicking on a specific hardware device gives you a **Resources** tab which shows the Interrupt number and address. Double-Clicking **Computers** to see all the interrupts and addresses for your system. Make sure that each ISA device should be assigned to one IRQ respectively. If ISA device share IRQ with any other device, your computer will easily get into trouble.



***MEMO***

# Chapter 3 Software Setup

## Drivers, Utilities and Software Installation

- This mainboard should always be shipped with a Support CD which contains those necessary driver files, Application Softwares and some helpful utilities.
- For Series SL-85SD, user should be able to find in the Supported CD the following drivers and utilities supported by Intel 845 Chipset:
  1. INF Utility ( Intel Chipset Software Installation Utility;
  2. Intel Application Accelerator ( IAA );
  3. Creative Audio drivers;
  4. AC'97 Drivers;
  5. Hardware Monitor Utility;
- For SL-85SD<sup>+</sup> and SL-85SD<sup>+</sup>-X, a floppy diskette containing Promise RAID Drivers will also be added to the package for the IDE RAID setup.

This chapter is devoted to describing the installations of all these essential drivers and utilities, and users are recommended to take the following installation orders :

### **3-1 Intel Chipset Software Installation Utility ( INF Utility )**

### **3-2 Intel Application Accelerator ( IAA )**

### **3-3 AC'97 Audio CODEC Drivers Installation**

**(For SL-85SD and SL-85SD-X ONLY)**

### **3-4 Creative Sound Drivers Installation**

**(For SL-85SD<sup>+</sup>, SL-85SD<sup>+</sup>-X, SL-85SDB AND  
SL-85SDB-X ONLY)**

### **3-5 Windbond Hardware Monitor Utility**

### **3-6 Promise RAID Drivers Installation**

**(for SL-85SD and SL-85SD-X only)**

### 3-1 Install “Intel Chipset Software Installation Utility”

- 1 • Please put the Support CD provided for SL-85SD series into your CD-ROM drive.
- 2 • When a “Welcome” window appears on the screen, choose “Install Chipset Drivers”.
- 3 • Click on the “Intel Chipsets Drivers”.
- 4 • Click on “Intel 845 Chipset” and then “Intel chipset software Installation Utility” to start installation.
- 5 • On the “InstallShield Wizard” screen, press “Next” button to continue.
- 6 • On the “Licence Agreement” screen, press “Yes” to accept Software License Agreement.

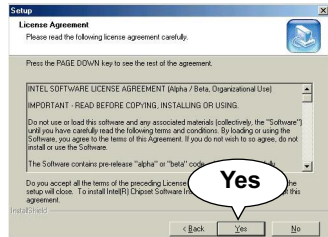
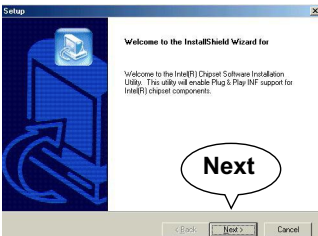

- 7 • After all the setup process is finished, please restart your computer by clicking on “Finish” so as to take the Utility into effect.

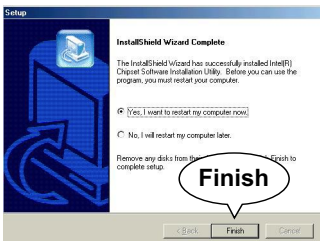

### 3-2 Install “Intel Application Accelerator”:

IAA supports all Windows 98/98se/Mellennium/NT4/2000 with Pentium III / 4 processor. Installation of this software for these operating systems are similarly fully automated by itself, and it is typically designed to improve performance of the storage sub-system and overall system performance.

Below is a model installation on Windows Me. Users of Windows 98/98se/NT4/2000 can also follow this example for their IAA installation.

- 1 • Please put the Support CD provided for SL-85SD series into your CD-ROM drive.
- 2 • When a “Welcome” window appears on the screen, choose “Install Drivers”.
- 3 • Click on the “Intel Chipset Drivers”.
- 4 • Click on the “Intel 845 Chipset”, and then “Intel Application Accelerator” to start installation.
- 5 • On the “InstallShield Wizard” screen, Click on “Next” to continue.
- 6 • On the “Licence Agreement” screen, click on “Yes” to continue.

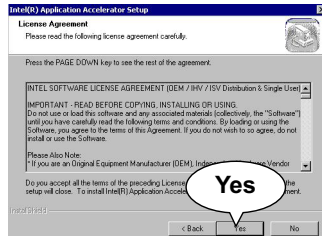
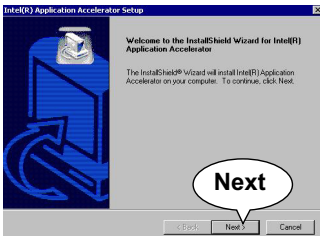

- 7 • On “Choose Destination Location” screen, press “Yes” to continue.
- 8 • On “InstallShield Wizard Complete” screen, choose “Yes, I want to restart my computer now” and press “finish” to restart. Remember you must restart computer to put setup in effect.

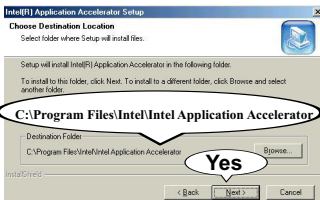

### 3-3 AC'97 DRIVER INSTALLATION

AC'97 Sound Controller is installed on SL-85SD and SL-85SD-X only)

- |   |   |
|---|---|
| <p><b>1</b> • Please put the Support CD provided in your mainboard package into the CD-ROM drive.</p> | <p><b>2</b> • When a welcome window appears on the screen, users should choose <b>"Install Driver"</b>.</p> |
|---|---|

- |   |   |
|---|---|
| <p><b>3</b> • Click on the <b>"INTEL Driver"</b>.</p> | <p><b>4</b> • Click on the <b>"INTEL 845 Chipsets"</b>.</p> |
|---|---|

- |   |  |
|---|--|
| <p><b>5</b> • Click on the <b>"AC'97 Driver"</b>.</p> | <p><b>6</b> • The next screen will appear for user to select which AC'97 driver you need to install depending on what operation system you are using. Supposing that your system is Windows 98SE/ME/Win2000, then click on the <b>"Install AC'97 Driver for Win98SE/ME/Win2000"</b>.</p> |
|---|--|

- |  |   |
|--|---|
| <p><b>7</b> • Press <b>"Next"</b> to continue.</p> | <p><b>8</b> • After all the setup process is finished, please restart your computer by clicking on <b>"Finish"</b>.</p> |
|--|---|

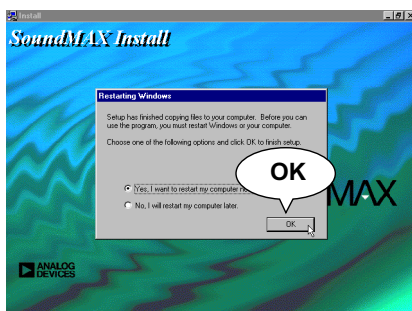
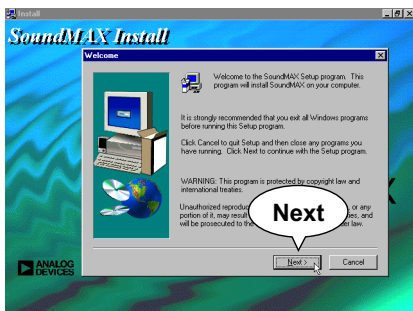

## 3-4 Creative Sound Driver Installation

Creative Sound is built on SL-85SD<sup>+</sup>, SL-85SD<sup>+</sup>-X, SL-85SDB, and SL-85SDB-X only.

### 3-4.1 To Install Creative Sound Driver

- 1** • Please put the Support CD provided in your mainboard package into the CD-ROM drive.
- 2** • When a welcome window appears on the screen, users should choose "Install Driver".
- 3** • Click on the "INTEL Driver".
- 4** • Click on the "INTEL 845 Chipsets".
- 5** • Click on the "Creative Sound Driver" to start.
- 6** • When the Licence Agreement screen appears, you must click to "Yes" to continue installation.

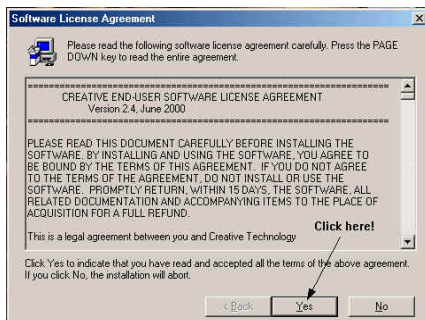

- 7** • Follow the instructions on screens to complete the installation, after which please restart your PC to put the driver into effect.

### 3-4.2 To Enable The Rear Line Out (For 4 Speakers)

After Installation Of Creative Sound Drivers, you should enable the Rear Line Out connector for speakers of 4 channels.

- 1 • Click to “My computer” icon, and then “Control Panel”, and then “System”, and you will see the “System Properties” screen.
- 2 • Click the “Device Manager” button.
- 3 • Click the “Creative sound Blaster PCI128” selection, then Click on the “Properties” button.
- 4 • When “Creative Sound Blaster PCI128 Properties” Window appears, please Click the 3D Audio button, and then select “Quad Speakers”.  
• Click the “OK” button.

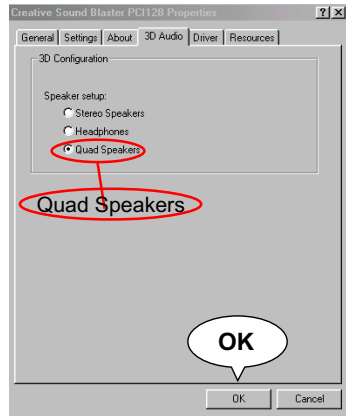
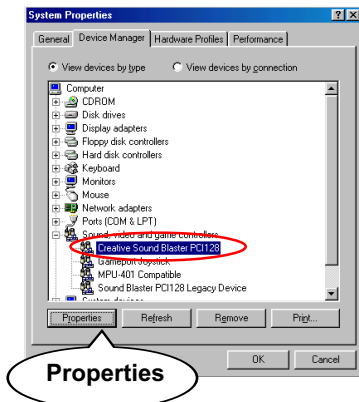

- 5 • Your Audio System can now support 4 speakers out. Insert second pair of speakers to the Rear Line out jack to verify this function. (See the following Section 3-4.3 for identifying the Rear Line out jack.)





## 3-5 Install Windbond Hardware Monitor Utility

### 3-5.1 Installation

Windbond Hardware Monitor is built on every member of Series SL-85SD. Its installation is similarly fully automated on Windows 9X/Me/NT4/2000. User can follow the model installation below for its installation on various Windows System.

- 1 • Please put the Support CD provided in your mainboard package into the CD-ROM drive.
- 2 • When a welcome window appears on the screen, users should choose “**Install Driver**”.
- 3 • Click on the “**INTEL Driver**”.
- 4 • Click on the “**INTEL 845 Chipsets**” and then “**Hardware Monitor Utility**” to start installation.
- 5 • With the help of InstallShield Wizard, installation program automatically opens the “**Choose Destination Location**” screen. Click “**Next**” to continue.
- 6 • Select the Program folder and click “**Next**” to continue.

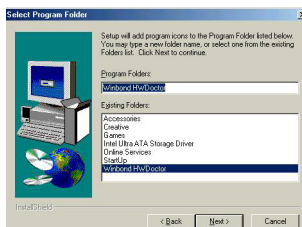
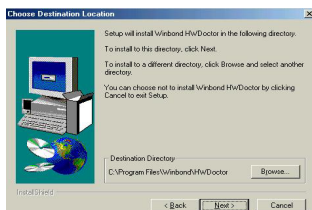

- 7 • On the “**Setup complete**” screen, click “**Finish**” to restart your computer so that the Utility can be put in effect.



### 3-5.2 Verification

1 • After restarting your computer, click “Start” and choose the path Programs\Winbond\Hwdoctor to open the main window of the Hardware Doctor.

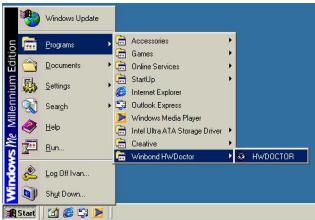

2 • The “Voltage/CaseOpen” window is for CPU voltage and temperature information.

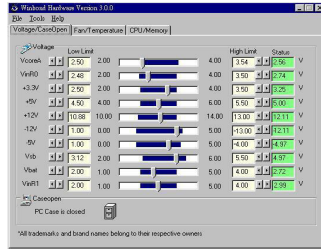

3 • The “Fan/Temperature” window is for Fan speed and temperature information.

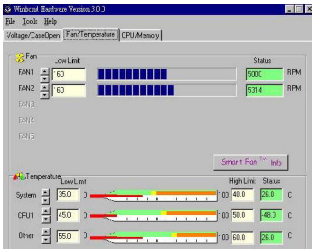

4 • The “CPU/Memory” window is for Processor and memory information.

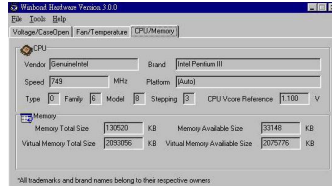

### **3-6 Install Promise RAID Controller**

Promise RAID Controller is built on all members of Series SL-85SD. Before installing the driver for Promise RAID Controller, please check the following points:

- (1) Set up Jumper 4 on board to enable Promise RAID Controller.
- (2) Get ready the floppy diskette containing the FastTrak100-Lite Drivers for various Windows systems.
- (3) The RAID Controller Drivers installation procedures will differ among different operating systems and situations. Please refer to Chapter 5 of this manual to install your RAID drivers and disk arrays.

# CHAPTER 4 BIOS SETUP

## THE BIOS

- BIOS stands for Basic Input and Output System. It was once called ROM BIOS when it was stored in a Read-Only Memory(ROM) chip. Now manufacturers would like to store BIOS in EEPROM which means Electrically Erasable Programmable Memory. BIOS used in this series of mainboard is stored in EEPROM, and is the first program to run when you turn on your computer.
- BIOS performs the following functions:
  1. Initializing and testing hardware in your computer (a process called "POST", for Power On Self Test).
  2. Loading and running your operating system.
  3. Helping your operating system and application programs manage your PC hardware by means of a set of routines called BIOS Run-Time Service.

**The following topics are included in this chapter:**

**4-1 About BIOS Setup**

**4-2 To run BIOS Setup**

**4-3 About CMOS**

**4-4 The POST (Power On Self Test)**

**4-5 To upgrade BIOS**

**4-6 BIOS Setup**

### 4-1 About BIOS Setup

- BIOS setup is an interactive BIOS program that you need to run when:
  1. Changing the hardware of your system. (For example: installing a new Hard Disk etc.)
  2. Modifying the behavior of your computer. (For example: changing the system time or date, or turning special features on or off etc.)
  3. Enhancing your computer's behavior. (For example: speeding up performance by turning on shadowing or cache)

### 4-2 To run BIOS Setup

- First access BIOS setup menu by pressing < DEL > key after "POST" is complete ( before OS is loaded ). BIOS will then display the following message:

Press "DEL" to enter "SETUP"

### 4-3 About CMOS

- CMOS is the memory maintained by a battery. CMOS is used to store the BIOS settings you have selected in BIOS Setup. CMOS also maintains the internal clock. Every time you turn on your computer, the BIOS Looks into CMOS for the settings you have selected and configures your computer accordingly. If the battery runs out of power, the CMOS data will be lost and POST will issue a "CMOS invalid" or "CMOS checksum invalid" message. If this happens, you have to replace the battery and do some proper settings in BIOS Setup.

### 4-4 The POST ( Power On Self Test )

- POST is an acronym for Power On Self Test. This program will test all things the BIOS does before the operating system is started. Each of POST routines is assigned a POST code, a unique number which is sent to I/O port 080h before the routine is executed.

## 4-5 To upgrade BIOS

- System BIOS is incorporated into a Flash memory component. Flash BIOS allows user to upgrade BIOS without the need to replace an EPROM component.
- The Upgrade Utility can be loaded on a floppy diskette to execute saving, verifying, and updating the system BIOS. The Upgrade Utility can also be run from a hard disk drive or a network drive.

### 4-5.1 Before Upgrading BIOS

- It is highly recommended that you save a copy of the original mainboard BIOS along with a Flash EPROM Programming utility (AWDFLASH.EXE) to a bootable floppy disk so that you can reinstall the BIOS when needed.

### 4-5.2 Upgrade Process

- Normally, to upgrade BIOS is unnecessary if the system is working fine. Users should only upgrade the BIOS when you experience incompatible problems or need to create new features.
- “AWDFLASH.EXE” is a Flash EPROM Programming utility that updates the BIOS by uploading a new BIOS file to the programmable flash ROM on the mainboard. This program only works in **DOS environment, the utility can not be executed in win95/98, ME, NT or WINDOWS 2000 environment.**
- Please follow the steps below for upgrading the system BIOS:

Step 1. Please visit the board maker's website, download latest BIOS file and award flash utility “AWDFLASH.EXE”. The BIOS file format will be \*.bin, of which “\*” stands for the specific BIOS file name.

Step 2. Create a bootable diskette. Then copy the BIOS file and award flash utility “AWDFLASH.EXE” into the diskette.

Step 3. Insert the diskette into drive A, reboot your system and boot from the diskette.

Step 4. Type **awdflash \*.bin /sn/py/cc** and then press <Enter> to run BIOS upgrade program. (\*.bin depends on your mainboard model and version code. Instead of typing “\*”, you should type specific file name for your specific mainboard).

Step 5. Please press <F1> or <F10> to exit or reset your system.

**Warning !** If the message “ **Write Fail** ” appears while Award “FLASH MEMORY WRITER” is verifying Flash memory, just repeat the process. Please DO NOT reset or turn off the system. If the award memory flash utility is not able to update the BIOS successfully, your system may not be able to boot up.

Step 6. You will need a message “CMOS checksum error-Default loaded” during booting the system. Press <Del> to run CMOS setup utility, then reload “LOAD SETUP DEFAULTS” or “**Load Optimized Defaults**” and save this change.

The parameters of AWDFLASH.EXE

/sn: No original BIOS backup

/py: Program flash memory

/cc: Clear CMOS data (and update data automatically) after programming

Users can type AWDFLASH /? to get further details about the parameters. Incorrect usage of the parameter will damage the BIOS information, so we strongly recommend user to leave parameters alone unless you fully understand their function.

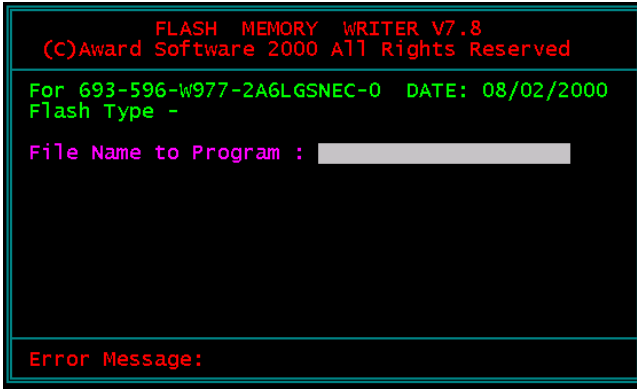

Figure 1 : Award Flash Memory Writer Start Screen

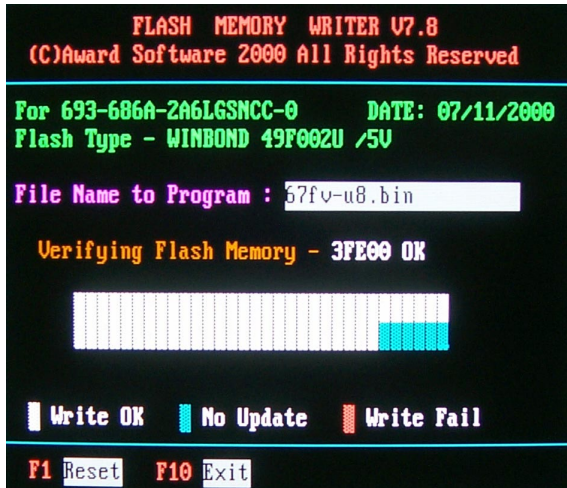

Figure 2 : Award Flash Memory Writer Start Screen



## 4-6 BIOS Setup --- CMOS Setup Utility

### 4-6.1 CMOS Setup Utility

- This mainboard comes with the AWARD BIOS from AWARD Software Inc. Enter the CMOS Setup Utility Main Menu by:
  1. Turn on or reboot your system. After a series of diagnostic checks, the following message will appear:

**PRESS <DEL> TO ENTER SETUP**

2. Press the <DEL> key and the main program screen will appear as follows.

CMOS Setup Utility - Copyright (C) 1984 - 2001 Award Software

<ul style="list-style-type: none"> <li>▶ Standard CMOS Features</li> <li>▶ Advanced BIOS Features</li> <li>▶ Advanced Chipset Features</li> <li>▶ Integrated Peripherals</li> <li>▶ Power Management Setup</li> <li>▶ PnP/PCI Configurations</li> <li>▶ SmartDoc Anti-Burn Shield</li> </ul>	<ul style="list-style-type: none"> <li>▶ Frequency/Voltage Control</li> <li>Load Optimized Defaults</li> <li>Set Supervisor Password</li> <li>Set User Password</li> <li>SAVE &amp; EXIT SETUP</li> <li>EXIT WITHOUT SAVING</li> </ul>
Esc : Quit F10 : Save & Exit Setup	↑↓→← : Select Item
Time, Date, Hard Disk Type...	

3. Use the arrow keys on your keyboard to select an option, and press <Enter>. Modify the system parameters to reflect the options installed in your system.
4. You may return to the Main Menu anytime by pressing <ESC>.
5. In the Main Menu, "SAVE AND EXIT SETUP" saves your changes and reboots the system, and "EXIT WITHOUT SAVING" ignores your changes and exits the program.

### 4-6.2 Standard CMOS Setup

- Standard CMOS Setup records some basic system hardware configuration and sets the system clock and error handling. You only need to modify the configuration values of this option if you want to change your system hardware configuration or when the data stored in the CMOS memory gets lost or damaged.

Run the STANDARD CMOS SETUP as follows:

1. Choose "STANDARD CMOS SETUP" from the Main Menu and a screen with a list of options will appear:

CMOS Setup Utility - Copyright (C) 1984 - 2001 Award Software  
Standard CMOS Features

Date (mm:dd:yy)	Thu, Dec 30 2000	Item Help
Time (hh:mm:ss)	9 : 52 : 15	Menu Level ▶
▶ IDE Primary Master	Press Enter 13022 MB	Change the date month, year and century
▶ IDE Primary Slave	Press Enter None	
▶ IDE Secondary Master	Press Enter None	
▶ IDE Secondary Slave	Press Enter None	
Drive A	1.44M, 3.5 in.	
Drive B	None	
Video	EGA/VGA	
Halt On	All, but Keyboard	
Base Memory	640K	
Extended Memory	65472K	
Total Memory	66112K	

↑ ↓ → ← : Move Enter: Select +/- /PU/PD: Value F10: Save ESC: Exit F1: General Help  
F5: Previous Values F6: Fail-Safe Defaults F7: Optimized Defaults

2. Use one of the arrow keys to move between options and modify the selected options by using PgUp / PgDn / + / - keys.
3. Press <ESC> to return to the Main Menu when you finish setting up all items. Now please read the following explanatory information for your Standard CMOS Features Setup.

**Date (mm:dd:yy)** The BIOS determines the day of the week from the other date information. This field is for information only.

Press the left or right arrow key to move to the desired field (date, month, year). Press the PgUp or PgDn key to increment the setting, or type the desired value into the field.

**Time (hh:mm:ss)** The time format is based on the 24-hour military-time clock. For example, 1 p.m. is 13:00:00. Press the left or right arrow key to move to desired field. Press the PgUp or PgDn key to increment the setting, or type the desired value into the field.

**Primary / Secondary Master / Slave** This field records the specifications for all non-SCSI hard disk drives installed in your system. Refer to the respective documentation on how to install the drives.

CMOS Setup Utility - Copyright (C) 1984 - 2001 Award Software  
IDE Primary Master

IDE HDD Auto-Detection	Press Enter	Item Help
IDE Primary Master	Auto	Menu Level ▶▶
Access Mode	Auto	
Capacity	13022 MB	
Cylinder	25232	
Head	16	
Precomp	0	
Landing Zone	25231	
Sector	63	

↑↓→←:Move Enter:Select +/-/PU/PD:Value F10:Save ESC:Exit F1:General Help  
F5:Previous Values F6:Fail-Safe Defaults F7:Optimized Defaults

**Drive A / Drive B** Select this field to the type(s) of floppy disk drive(s) installed in your system. The choices are:  
360KB, 5.25in;  
1.2MB, 5.25in;  
720KB, 3.5in;  
1.44MB, 3.5in;  
2.88MB, 3.5in;  
None.

**Video** Select the type of primary video subsystem in your computer. The BIOS usually detects the correct video type automatically. The BIOS supports a secondary video subsystem, but you do not select it in setup.

**Halt On** During the power-on self-test (POST), the computer stops if the BIOS detects a hardware error. You can tell the BIOS to ignore certain errors during POST and continue the boot-up process.

**Base Memory** Typically 640KB. Also called conventional memory. The DOS operating system and conventional applications use this area.

**Extended Memory** Above the 1MB boundary. Early IBM personal computers could not use memory above 1MB, but current PCs and their software can use extended memory.

**Total Memory** This option shows system memory capacity.

### 4-6.3 Advanced BIOS Features

- ADVANCED BIOS FEATURES improves your system performance or sets up system features according to your preference.

Run the ADVANCED BIOS FEATURES as follows:

1. Choose “ADVANCED BIOS FEATURES” from the Main Menu and a screen with a list of options will appear:

CMOS Setup Utility - Copyright (C) 1984 - 2001 Award Software  
Advanced BIOS Features

VD-Tech II	Enabled	Item Help
Virus Warning	Disabled	Menu Level ▶
CPU L1 & L2 Cache	Enabled	
Quick Power On Self Test	Enabled	
First Boot Device	Floppy	
Second Boot Device	HDD-0	
Third Boot Device	CDROM	
Boot Other Device	Enabled	
Swap Floppy Drive	Disabled	
Boot Up Floppy Seek	Disabled	
Boot Up NumLock Status	On	
Gate A20 Option	Fast	
Typematic Rate Setting	Disabled	
× Typematic Rate (Chars/Sec)	6	
× Typematic Delay (Msec)	250	
Security Option	Setup	
OS Select For DRAM > 64MB	Non-OS2	
Report No FDD For WIN95	No	

↑↓→←:Move Enter:Select +/-/PU/PD:Value F10:Save ESC:Exit F1:General Help  
F5:Previous Values F6:Fail-Safe Defaults F7:Optimized Defaults

2. Use one of the arrow keys to move between options and modify the selected options by using PgUp / PgDn / + / - keys. An explanation of the <F> keys follows:

<F1>: "Help" gives options available for each item.

<F5>: Get the previous values. These values are the values with which the user starts the current session.

<F6>: Load all options with the BIOS default values.

<F7>: Load all options with the Setup default values.

3. Press <ESC> to return to the Main Menu when you finish setting up all items. Now please read the following information for the "Advance BIOS Features " setup:



**Virus Warning** When enabled, you receive a warning message if a program (specifically, a virus) attempts to write to the boot sector or the partition table of the hard disk drive. You should then run an antivirus program. Keep in mind that this feature protects only the boot sector, not the entire hard drive.

**NOTE:** Many disk diagnostic programs that access the boot sector table can trigger the virus warning message. If you plan to run such a program, we recommend that you disable the virus warning.

**CPU L1 & L2 Cache** Cache memory is additional memory that is much faster than conventional DRAM (system memory). CPUs from 486-type up contain internal cache memory (L1), and most, but not all, modern PCs have external cache memory (L2). When the CPU requests data, the system transfers the requested data from the main DRAM into cache memory, for faster access by the CPU.

**Quick Power On Self Test** Select Enabled to reduce the amount of time required to run the power-on self-test (POST). A quick POST skips certain steps. We recommend that you normally enable quick POST.

- First/Second/Third/Other Boot Device** The BIOS attempts to load the operating system from the devices according to your selected priority. The choices: Floppy; LS120; HDD-0;SCSI; CDROM;HDD-1;HDD-2;HDD-3; ZIP100;LAN;RAID;Disabled.
- Boot Other Device** When enabled, this item allows you to select other boot device. The choices: Enabled; Disabled
- Swap Floppy Drive** When enabled, floppy drives A and B will be exchanging without any physical connection and modification on the cables.
- Boot Up Floppy Seek** When enabled, the BIOS tests (seeks) floppy drives to determine whether they have 40 or 80 tracks. Only 360-KB floppy drives have 40 tracks; drives with 270KB, 1.2MB, and 1.44MB capacity all have 80 tracks. Because very few modern PCs have 40-track floppy drives, we recommend that you set this field to disabled to save time.
- Boot Up NumLock Status** Toggle between On or Off to control the state of the NumLock key when the system boots. If On, the numeric keypad is in numeric mode. If off, the numeric keypad is in cursor control mode.
- Gate A20 Option** Gate A20 refers to the way the system addresses memory above 1 MB (extended memory). When set to *Fast*, the system chipset controls Gate A20. When set to *Normal*, a pin in the keyboard controller controls Gate A20. Setting Gate A20 to Fast improves system speed, particularly with OS/2 and Windows.

**Typematic Rate Setting** When *Disabled*, the following two items (Typematic Rate and Typematic Delay) are irrelevant. Keystroke repeats at a rate determined by the keyboard controller in your system.

When *Enabled*, you can select a typematic rate and typematic delay.

**Typematic Rate (Chars / Sec)** When the typematic rate setting is enabled, you can select a typematic rate (the rate at which character repeats when you hold down a key) of 6, 8, 10, 12, 15, 20, 24, or 30 characters per second. Default is "disabled".

**Typematic Delay (Msec)** Choices: 250; 500; 750; 1000. This option sets the time interval for displaying the first and the second characters. If enabled, the time interval is optional.

**Security Option** If you have set a password, select whether the password is required every time the System boots, or only when you enter setup.  
The choices: system; setup (default).

**OS Select For DRAM > 64MB** Select OS2 only if you are running OS/2 operating system with greater than 64MB of RAM on your system. Default is "Non-OS2".

**Report No FDD For Win95** Yes: BIOS reports "NO FDD" to Win95.  
No (default): BIOS will not report "NO FDD" to Win95.



### 4-6.4 Advanced Chipset Features

- ADVANCED CHIPSET FEATURES is used to modify the values of chipset buffers. These buffers control the system options.

Run the ADVANCED CHIPSET FEATURES as follows:

1. Choose “ADVANCED CHIPSET FEATURES” from the Main Menu and a list of option will appear:

CMOS Setup Utility - Copyright (C) 1984 - 2001 Award Software  
Advanced Chipset Features

DRAM Timing Selectable	3	Item Help
DRAM CAS Latency Time	1.5	Menu Level ▶
Active to Precharge Delay	7	
DRAM RAS-To-CAS Delay	3	
DRAM RAS Precharge Time	3	
DRAM Data Intergrity Mode	Non-ECC	
Memory Frequency for		
DRAM Read Thermal Mgmt	Disabled	
System BIOS Cacheable	Disabled	
Video BIOS Cacheable	Disabled	
Video RAM Cacheable	Disabled	
Memory Hole At 15M-16M	Disabled	
AGP Graphics Aperture Size(MB)	64	
Delay Prior to Thermal	16 Min	

↑↓→←:Move Enter:Select +/-/PU/PD:Value F10:Save ESC:Exit F1:General Help  
F5:Previous Values F6:Fail-Safe Defaults F7:Optimized Defaults

2. Use one of the arrow keys to move between options and modify the selected options by using PgUp / PgDn / + / - keys. An explanation of the <F> keys follows:

<F1>: “Help” gives options available for each item.

<F5>: Get the previous values. These values are the values with which the user starts the current session.

<F6>: Load all options with the BIOS default values.

<F7>: Load all options with the Setup default values.

3. Press <ESC> to return to the Main Menu when you finish setting up all items. Now please read the following information for the “Advanced Chipset Features” setup:

-----

**DRAM Timing Selectable** Select the

**CAS Latency Time** When synchronous DRAM is installed, the number of clock cycles of CAS latency depends on the DRAM timing. Do not reset this field from the default value specified by the system designer.

**Active to Precharge Delay** This field allows you to select a CAS Precharge delay timing.  
Choices are: 7; 6; 5;

**DRAM RAS# to CAS# Delay** This field lets you insert a timing delay between the CAS and RAS strobe signals, used when DRAM is written to, read from, or refreshed. Fast gives faster performance and Slow gives more stable performance. This field applies only when synchronous DRAM is installed in the system.  
The Choices: 2; 3

**DRAM RAS Precharge** If an insufficient number of cycles is allowed for the RAS to accumulate its charge before DRAM refresh, the refresh may be incomplete and the DRAM may fail to retain data. Fast gives faster performance; and Slow gives more stable performance. This field applies only when synchronous DRAM is installed in the system.  
The Choices: 2; 3

**DRAM Data integrity mode** This item is to choose or not the Error Check and Correction mode.  
Choices are: ECC; Non-ECC (default).

**DRAM Read Thermal Mgmt** Selecting Enabled is to activate the DRAM Read Thermal management function. default: Ddisabled.

- System BIOS Cacheable** Selecting Enabled allows caching of the system BIOS ROM at F0000h to FFFFFh, resulting in better system performance.  
Default: Disabled
- Video BIOS Cacheable** Selecting Enabled allows caching of the system BIOS ROM at C0000h to C7FFFh, resulting in video performance. However, if any program writes to this memory area, a system error may result.
- Memory Hole At 15M-16M** You can reserve this area of system memory for ISA adapter ROM. When this area is reserved, it cannot be cached.
- AGP Graphics Aperture Size** Choices: 32; 64 MB. Memory mapped and graphics data structures can reside in a Graphics Aperture. This area is like a linear buffer. BIOS will automatically report the starting address of this buffer to the O.S.
- Delay Prior to Thermal** The chipset has an embedded 32-bit posted write buffer to support delay transactions cycles. This item allows you to choose a delay timing before a new Thermal reading is taken.

## 4-6.5 Integrated Peripherals

- INTEGRATED PERIPHERALS option allows you to get some information inside your system when it is working.

Run the INTEGRATED PERIPHERALS as follows:

1. Choose "INTEGRATED PERIPHERALS" from the Main Menu and a list of options will appear:
2. Use one of the arrow keys to move between options and modify the selected options by using PgUp / PgDn / + / - keys. An explanation of the <F> keys follows:

<F1>: "Help" gives options available for each item.

<F5>: Get the previous values. These values are the values with which the user starts the current session.

<F6>: Load all options with the BIOS default values.

<F7>: Load all options with the Setup default values.

3. Press <ESC> to return to the Main Menu when you finish setting up all items. please read the following "Integrated Peripherals" menu and the explanatory information for your "Integrated peripherals" setup:

CMOS Setup Utility - Copyright (C) 1984 - 2001 Award Software  
 Intergrated Peripherals

On-Chip Primary PCI IDE	Enabled	Item Help
IDE Primary Master PIO	Auto	Menu Level ▶
IDE Primary Slave PIO	Auto	
IDE Primary Master UDMA	Auto	
IDE Primary Slave UDMA	Auto	
On-Chip Secondary PCI IDE	Enabled	
IDE Secondary Master PIO	Auto	
IDE Secondary Slave PIO	Auto	
IDE Secondary Master UDMA	Auto	
IDE Secondary Slave UDMA	Auto	
USB Controller	Enabled	
USB Keyboard Support	Disabled	
AC97 Modem	Disabled	
Init Display First	AGP	
IDE HDD Block Mode	Enabled	
Power ON Function	BUTTON ONLY	
KB Power ON Password	Enter	
Hot Key Power On	Ctrl - F1	
Onboard FDC Controller	Enabled	
Onboard Serial Port 1	Auto	
Onboard Serial Port 2	Auto	
UART Mode Select	Normal	
RxD, TxD Active	Hi, Lo	
IR Transmission Delay	Enabled	
UR2 Duplex Mode	Half	
Use IR Pins	IR-Rx2Tx2	
Onboard Parallel Port	378/IRQ7	
Parallel Port Mode	SPP	
EPP Mode Select	EPP1.7	
ECP Mode Use DMA	3	
PWRON After PWR-Fail	Off	
Game Port Address	201	
Midi Port Address	330	
Midi Port IRQ	10	

↑ ↓ → ← : Move Enter: Select +/-/PU/PD: Value F10: Save ESC: Exit F1: General Help  
 F5: Previous Values F6: Fail-Safe Defaults F7: Optimized Defaults

- On-Chip Primary/ Secondary PCI IDE** The chipset contains a PCI IDE interface with support from two IDE channels. Select Enabled to activate the first and/or the second IDE interface. Select Disabled to inactivate an interface if you install a primary and/or second add-on IDE interface. The choices: Enabled; Disabled.
- Primary Master / Slave PIO Secondary Master / Slave PIO** Choose Auto or Mode 0~4. The BIOS will detect the HDD mode type automatically when you choose Auto. You need to set to a lower mode than Auto when your hard disk becomes unstable. The choices: Auto; Mode 0; Mode 1; Mode 2; Mode 3; Mode 4.
- Primary Master / Slave UDMA Secondary Master / Slave UDMA** Ultra DMA33/66/100 implementation is possible only if your IDE hard drive supports it, if the operating environment includes a DMA drive, and if your system software supports Ultra DMA33/66/100. Select "Auto" to enable BIOS support. The choices: Auto; Disabled.
- USB Controller** Select Enabled if your system contains a Universal Serial Bus (USB) controller and you have USB peripherals.
- USB Keyboard Support** Select Enabled if your system contains a Universal Serial Bus (USB) controller and you have a USB keyboard.
- AC'97 Modem** This option allows you to decide to enable/disable the 845 chipset to support AC'97 Modem. The choices: Auto; Disabled (default)
- Init Display First** Initialize the AGP or PCI slot before initializing any other display device on the system. The Coices are: AGP; PCI Slot

- IDE HDD Block Mode** Block mode is also called block transfer, multiple commands, or multiple sector read/write. If your IDE hard drive supports block mode (most new drives do), select Enabled for automatic detection of the optimal number of block read/write per sector the drive can support.  
The choices: Enabled; Disabled.
- Power ON Function** This option allows you to select <KB Power ON Password> , <Hot-Key Power ON> or others.  
The choices: Any Key, Button only, Keyboard 98, Password, Hot-Key, Mouse Move, Mouse Click.
- KB Power ON Password** When user sets a password for keyboard, the password user set that return the system to Full On state.
- Hot-Key Power ON** Boot up the system via predetermined keyboard hot key.  
The choices: <Ctrl>+<F1>...<F12>
- Onboard FDC Controller** Select Enabled if your system has a floppy drive controller (FDC) installing in the system board and you want to use it. If you install add-in FDC or your system has no floppy drive, select Disabled.  
The choices: Enabled (default); Disabled.
- Onboard Serial Port 1 / Port 2** Select a logical COM port name and matching address for the first and second serial ports. Select an address and corresponding interrupt for the first and second serial ports. Choices: Auto(default); Disabled; 3F8/IRQ4; 2F8/IRQ3; 2E8/IRQ3.
- UART Mode Select** The serial ports on your system offer a variety of infrared port modes of the Universal Asynchronous Receiver/Transmitter.  
The choices: Normal; IrDA; ASKIR
- RxD, TxD Active** This item allows you to select the correct setting of the Receive Data and Transmit Data signals for your IR peripherals.  
The choices: Hi,Lo (default); Lo, Hi; Lo, Lo; Hi, Hi;.

- Ir Transmission delay** This item allows you to Enable/Disable the Ir Transmission Delay.  
The choices: Enabled (default); Disabled.
- UR2 Duplex Mode** This item allows you to select the IR half / full duplex function.  
The choices: Half; Full.
- Use IR Pins** To select the correct setting of RxD, TxD signals of your IR peripherals. You may also refer to your IR peripherals document for the correct setting.  
The choices: IR-Rx2Tx2 (default); RxD2, TxD2;
- Onboard Parallel Port** This item allows you to determine onboard parallel port controller I/O address setting.  
The choices: 378H/IRQ7; 278H/IRQ5; 3BC/IRQ7; Disabled.
- Parallel Port Mode** Select an operating mode for the on-board parallel (printer) port. Select Normal, Compatible, or SPP unless you are certain your hardware and software both support one of the other available modes.
- EPP Mode Select** Select a mode of data transfer of the Enhanced Parallel port for your parallel devices.  
Choices: EPP1.7(default; EPP1.9;
- ECP Mode Use DMA** Select a DMA channel for the Enhanced Communication port. Choices:3 (default); 1;
- PWRON After PWR-Fail** Off: Disable Power Lost Resume function.  
On: Enable Power Lost Resume function.  
Former Sts: Use Former status.  
The choices: Off(default); On; Former Sts.
- Game Port Address** This item allows you to select the Game Port Address.  
The choices: Disabled; 201(default); 209
- MIDI Port Address** Select a DMA channel for the parallel port for use during ECP mode.  
The choices: Disabled; 330(default); 300
- MIDI Port IRQ** This item allows you to select the MIDI Port IRQ.  
Choices: 10(default); 5;



### 4-6.6 Power Management Setup

- POWER MANAGEMENT SETUP allows you to set the system's power saving functions.

Run the POWER MANAGEMENT SETUP as follows:

1. Choose "POWER MANAGEMENT SETUP" from the Main Menu and a list of options will appear:

CMOS Setup Utility - Copyright (C) 1984 - 2001 Award Software  
Power Management Setup

ACPI Function	Enabled	Item Help
ACPI Suspend Type	S1(POS)	Menu Level ▶
Power Management	User Define	
Video Off Method	V/H SYNC+Blank	
Video Off In Suspend	Yes	
Suspend Type	Stop Grant	
MODEM Use IRQ	3	
Suspend Mode	Disabled	
HDD Power Down	Disabled	
Soft-Off by PWR-BTTN	Instant-Off	
CPU Thrm-Throttling	50.0%	
Wake-up by PCI card	Enabled	
Power On by Ring	Disabled	
× USB KB Wake-Up From S3	Disabled	
Resume by Alarm	Disabled	
× Date (of Month) Alarm	0	
× Time (hh:mm:ss)	0 0 0	
** Reload Global Timer Events **		
Primary IDE 0	Disabled	
Primary IDE 1	Disabled	
Secondary IDE 0	Disabled	
Secondary IDE 1	Disabled	
FDD, COM, LPT Port	Disabled	
PCI PIRQ[A-D] #	Disabled	

↑↓→←:Move Enter:Select +/-/PU/PD:Value F10:Save ESC:Exit F1:General Help  
F5:Previous Values F6:Fail-Safe Defaults F7:Optimized Defaults

2. Use one of the arrow keys to move between options and modify the selected options by using PgUp / PgDn / + / - keys. An explanation of the <F> keys follows:

<F1>: "Help" gives options available for each item.

<F5>: Get the previous values. These values are the values with which the user starts the current session.

<F6>: Load all options with the BIOS default values.

<F7>: Load all options with the Setup default values.

3. Press <ESC> to return to the Main Menu when you finish setting up all items. Please read the following explanatory information for your Power management Setup.

-----

**ACPI Function** Select Enabled only if your computer's operating system supports the Advanced Configuration and Power Interface (ACPI) specification.

**ACPI Suspend Type** This item allows you to select the ACPI suspend type. You can select S3(STR) for suspending to DRAM or S1(POS) for power on suspend under Windows 98 ACPI mode.  
The choices: S1(POS), S3(STR).

**Power Management** This option allows you to select the type (or degree) of power saving for Doze, Standby, and Suspend modes.  
This table describes each power management mode. Default: User Define.

Max Saving	Maximum power savings. Only Available for SL CPUs. Inactivity period is 1 minute in each mode.
User Define	Set each mode individually. Select time-out period in the section for each mode stated below.
Min Saving	Minimum power savings. Inactivity period is 1 hour in each mode (except the hard drive).

**Video Off Method** This determines the manner by which the monitor is blanked. Default: V/H Sync+Blank

V/H SYNC + Blank	This selection will cause the system to turn off the vertical and horizontal synchronization ports and write blanks to the video buffer.
Blank Screen	This option only writes blanks to the video buffer.
DPMS Supports	Select this option if you monitor supports the Display Power Management Signaling (DPMS) standard of the Video Electronics Standards to select video power management values.

**Video Off in Suspend** This determines the manner in which the monitor is blanked.

The choices: Yes(default); No.

**Suspend Type** Select the Suspend Type.

The choices: PWRON Suspend; StopGrant (default).

**MODEM Use IRQ** Name the interrupt request (IRQ) line assigned to the modem (if any) on your system. Activity of the selected IRQ always awakens the system.

The choices: 3 (default); 4; 5; 7; 9; 10; 11; NA.

**Suspend Mode** After the selected period of system inactivity, the chipset enters a hardware suspend mode, stopping the CPU clock and possibly causing other system devices to enter power management modes.

Choices: Enabled; Disabled (default)

**HDD Power Down** When enabled and after the set time of system inactivity, the hard disk drive will be powered down while all other devices remain active.

Choices: Enabled; Disabled (default)

**Soft-Off by PWRBTN** When Enabled, turning the system off by pressing the on/off button places the system in a very low-power-usage state.

Choices: Instant-off (default); Delay 4 sec.;

- CPU Thrm-Throttling** This field sets the percent of CPU temperature change to display.  
The choices: 87.5%; 75.0%; 62.5%; 50.0%(default); 37.5%; 25.0%;12.5%.
- Wake-up by PCI card** This function allows you to enabled the system by wake-up by PCI card.  
The choices: Enabled(default); Disabled.
- Power On by Ring** An input signal on the serial Ring Indicator (RI) line (in other words, an incoming call on the modem) awakens the system from a soft off state.  
The choice: Enabled; Disabled (default).
- USB KB Wake-Up From S3** This item will enable you to Wake-up the system by USB keyboard when you shut down the computer in S3 Mode.  
The choices: Enabled; Disabled (default).
- Resume by Alarm** When Enabled, you can set the data and time at the which the RTC (Real Time Clock) alarm awakens the system from suspend mode. default: Disabled
- Date (of Month) Alarm** Set a certain date when RTC Alarm Resume option is Enabled to awaken the system. This option is concurrent with Resume Time option.
- Time (hh:mm:ss)** Set a certain time when RTC Alarm Resume option is Enabled to awaken the system. This option is concurrent with Date option.

**Reload Global Timer Events** Reload Global Timer Events are I/O events whose occurrence can prevent the system from entering a power saving mode or can awaken the system from such a mode. In effect, the system remains alert for anything which occurs to a device which is configured as Enabled, even when the system is in a power down mode.

Primary IDE 0

Primary IDE 1

Secondary IDE 0

Secondary IDE 1

FDD, COM, LPT Port

PCI PIPQ[A-D]

Default: All disabled

### 4-6.7 PNP / PCI Configuration

- PNP/PCI CONFIGURATION allows you to modify the system's power saving functions.

Run the PNP/PCI CONFIGURATION as follows:

1. Choose "PNP/PCI CONFIGURATION" from the Main Menu and a screen with a list of options will appear:

CMOS Setup Utility - Copyright (C) 1984 - 2001 Award Software  
PnP/PCI Configurations

Reset Configuration Data	Disabled	<b>Item Help</b>
Resources Controlled By × IRQ Resources	Auto(ESCD) Press Enter	Menu Level ▶
PCI/VGA Palette Snoop	Disabled	
PCI Slot1    IRQ Assigned	Auto	
PCI Slot2    IRQ Assigned	Auto	
PCI Slot3    IRQ Assigned	Auto	
PCI Slot4    IRQ Assigned	Auto	
PCI Slot5    IRQ Assigned	Auto	
PCI Slot6    IRQ Assigned	Auto	

↑↓→← :Move Enter:Select +/-/PU/PD:Value F10:Save ESC:Exit F1:General Help  
F5:Previous Values F6:Fail-Safe Defaults F7:Optimized Defaults

2. Use one of the arrow keys to move between options and modify the selected options by using PgUp / PgDn / + / - keys. An explanation of the <F> keys follows:

<F1>: "Help" gives options available for each item.

<F5>: Get the previous values. These values are the values with which the user starts the current session.

<F6>: Load all options with the BIOS default values.

<F7>: Load all options with the Setup default values.

3. Press <ESC> to return to the Main Menu when you finish setting up all items. please read the following explanatory information for your PnP/PCI configuration.

**Reset Configuration Data** Normally, you leave this Disabled. Select Enabled to reset Extended System Configuration Data (ESCD), when you exit Setup if you have installed a new add-on and the system reconfiguration has caused such a serious conflict that the operating system cannot boot.

**Resource Controlled By** The Plug and Play AwardBIOS can automatically configure all the boot and Plug and Play-compatible devices. If you select *Auto*, all the interrupt request (IRQ) and DMA assignment fields disappear, as the BIOS automatically assigns them.  
 Choices: Auto(ESCD) (default); Manual)

**IRQ RESOURCES** If "Resource Controlled By" is set at "Manual", this IRQ Resources option will appear for your configuration. Press Enter. Please refer to the list below:

CMOS Setup Utility - Copyright (C) 1984 - 2001 Award Software  
 IRQ Resources

IRQ-3 assigned to	PCI Device	Item Help
IRQ-4 assigned to	PCI Device	Menu Level ▶
IRQ-5 assigned to	PCI Device	
IRQ-7 assigned to	PCI Device	
IRQ-9 assigned to	PCI Device	
IRQ-10 assigned to	PCI Device	
IRQ-11 assigned to	PCI Device	
IRQ-12 assigned to	PCI Device	
IRQ-14 assigned to	PCI Device	
IRQ-15 assigned to	PCI Device	

↑↓→←:Move Enter:Select +/-/PU/PD:Value F10:Save ESC:Exit F1:General Help  
 F5:Previous Values F6:Fail-Safe Defaults F7:Optimized Defaults

**PCI/VGA Palette Snoop** This option allows the BIOS to preview VGA status, and to modify the information delivered from the feature Connector of the VGA card to MPEG card. This option can solve the display inversion to black after you have used MPEG card.  
Choices: Disabled (default); Enabled

**PCI Slot1~6 IRQ Assigned to** Set to Auto, this option allows the BIOS to assign IRQ to PCI slot.  
Choices: Auto (default); 3; 4; 5; 6; 7; 8; 9; 10; 11; 12; 14; 15.



### 4-6.8 SmartDoc Anti-Burn Shield

- This section helps you to get more information about your system including CPU temperature, FAN speed and voltage. It is recommended that you contact your mainboard supplier to get proper values about the setting of the CPU temperature.

To enter SmartDoc Anti-Burn Shield:

1. Choose “SmartDoc Anti-Burn Shield” from the Main Menu and a screen with a list of options will appear:

CMOS Setup Utility - Copyright (C) 1984 - 2001 Award Software  
SmartDoc Anti-Burn Shield

CPU Warning Temperature	Disabled	Item Help
Current System Temp.		Menu Level ▶
Current CPU1 Temperature		
Current CPU2 Temperature		
Current CPUFAN1 Speed		
Current CPUFAN2 Speed		
Current CPUFAN3 Speed		
IN0(V)		
IN1(V)		
IN2(V)		
+5 V		
+12 V		
-12 V		
-5 V		
VBAT (V)		
5VSB (V)		

↑↓→←:Move Enter:Select +/-/PU/PD:Value F10:Save ESC:Exit F1:General Help  
F5:Previous Values F6:Fail-Safe Defaults F7:Optimized Defaults

2. Use one of the arrow keys to move between options and modify the selected options by using PgUp / PgDn / + / - keys.

<F1>: "Help" gives options available for each item.

<F5>: Get the previous values. These values are the values with which the user starts the current session.

<F6>: Load all options with the BIOS default values.

<F7>: Load all options with the Setup default values.

3. Press <ESC> to return to the Main Menu when you finish setting up all items. please read the following explanatory information for your SmartDoc Anti-Burn Shield Configuration:

-----

**CPU Warning Temperature** This field allows you to select a CPU Warning temperature against the CPU over heat. If the CPU temperature reaches "CPU warning temperature" that you select in this field, the BIOS will send out a warning message.

**Current System Temp.** Showing the working System temperature.

**Current CPU1/2 Temp.** Showing the working CPU temperature.

**CPUFAN1/2 Speed** Showing the working CPU Fan speed.

**IN0/1/2, +5V/+12V/-12V/-5V** Showing the working voltage on board.

**VBAT** Showing the working battery voltage on board.

**5VSB** Showing the working standby voltage on board.

### 4-6.9 Frequency/Voltage Control

Run the "FREQUENCY/VOLTAGE CONTROL" as following:

1. Choose "FREQUENCY/VOLTAGE CONTROL" from the Main Menu and a screen with a list of options will appear:

CMOS Setup Utility - Copyright (C) 1984 - 2001 Award Software  
Frequency/Voltage Control

		Item Help
CPU Vcore Select	Default	Menu Level ▶
AGP Voltage Select	1.5V	
DIMM Voltage Select	3.3V	
×CPU Clock Ratio	x8	
Use CPU Linear Freq	Default	
CPU Clock	100MHz	
AGP Div Freq	Default	
Auto Detect PCI clk	Enabled	
Spread Spectrum	Disabled	
CPU0 Skew Adjust	Disabled	
CPU1 Skew Adjust	Disabled	
CPU2 Skew Adjust	Disabled	
3V66 skew Adjust	Disabled	
PCI Skew Adjust	Disabled	
PCI_F Skew Adjust	Disabled	
PCI_3V66 Skew Adjust	2.0ns	

↑ ↓ → ← : Move Enter: Select +/- / PU / PD: Value F10: Save ESC: Exit F1: General Help  
F5: Previous Values F6: Fail-Safe Defaults F7: Optimized Defaults

2. Use one of the arrow keys to move between options and modify the selected options by using PgUp / PgDn / + / - keys.

<F1>: "Help" gives options available for each item.

<F5>: Get the previous values. These values are the values with which the user starts the current session.

<F6>: Load all options with the BIOS default values.

<F7>: Load all options with the Setup default values.

3. Press <ESC> to return to the Main Menu when you finish setting up all items. please read the following explanatory information for your Frequency/Voltage Control configuration:

- CPU Vcore Select** This item allows you to adjust CPU Vcore. Yet, since the CPU Vcore can be auto-detected by CPU, you should leave this item at default value unless you can afford the risk of damaging your CPU. The choices: Default (Vcore auto-detected by CPU); 1.100V~1.850V by 0.025 stepping).
- AGP Voltage Select** This item allows user to adjust AGP voltage by 0.1V stepping. Choices: 1.5V (Default); 1.6V; 1.7V.
- DIMM Voltage Select** This item allows user to adjust DIMM voltage by 0.1V stepping. Choices: 3.3V (Default); 3.4V; 3.5V; 3.6V.
- CPU Clock Ratio** This item allows you to select the CPU clock ratio so as to change or overclock the CPU frequency. However, if CPU clock Ratio is locked, this function is invalid.
- Use CPU Linear Frequency** This item allows you to adjust the CPU clock by 1MHz stepping. Default CPU clock is 100MHz. Any overclocking is taking the risk of unstabilizing the CPU and system performance. Choices: Default; Use linear (1MHz stepping).
- CPU Clock** If "Use CPU Linear Frequency" is set at "Use linear", you can adjust the CPU clock by 1MHz stepping up or down. Choices: 1MHz stepping.
- AGP Div Freq.** This item allows you to adjust the AGP Frequency by fraction of your CPU Host clock. Default AGP frequency is 66MHz. The choices (fraction of CPU clock): Default; 2/2; 2/3; 2/4; 2/5; 2/6; 2/7; 2/8.
- Auto Detect PCI CLK** To reduce the occurrence of electromagnetic interference (EMI), the BIOS detects the presence or absence of components in PCI slots and turns off system clock generator pulses against empty slots. Choices: Enabled (default); Disabled.

- Spread Spectrum** When the system clock generator pulses, the extreme values of the pulse generate excess EMI. Enabling pulse spectrum spread modulation changes the extreme values from spikes to flat curves, thus reducing EMI. This benefit may in some cases be outweighed by problems with timing-critical devices, such as a clock-sensitive SCSI device. Choices: Disabled (default); enabled.
- CPU0/1/2 Skew Adjust** This item allows you to reduce CPU transfer rate. Users should leave this item at default value. The choices: Disabled (default); 500ps; 1000ps; 1500ps.
- 3V66 Skew Adjust** This item allows you to reduce the 3V66 transfer rate. Choices: Disabled (default); 500ps; 1000ps; 1500ps.
- PCI Skew Adjust** This item allows you to reduce PCI transfer rate. Users should leave this item at default value. Choices: Disabled (default); 500ps; 1000ps; 1500ps.
- PCI\_F Skew Adjust** This item allows you to reduce PCI transfer rate. Users should leave this item at default value. Choices: Disabled (default); 500ps; 1000ps; 1500ps.
- PCI\_3V66 Skew Adjust** This item allows you to reduce PCI transfer rate. Choices: 2.0ns (default); 3.0ns.

### 4-6.10 Load Optimized Default

- When you press <Enter> on this item, you will get a confirmation dialog box with a message similar to:

“ Load Optimized Defaults (Y/N) ? N ”

“Y” is for “Yes”, and “N” is for “No”.

Pressing “Y” loads the BIOS default values that are factor settings for optimal performance of system operations.

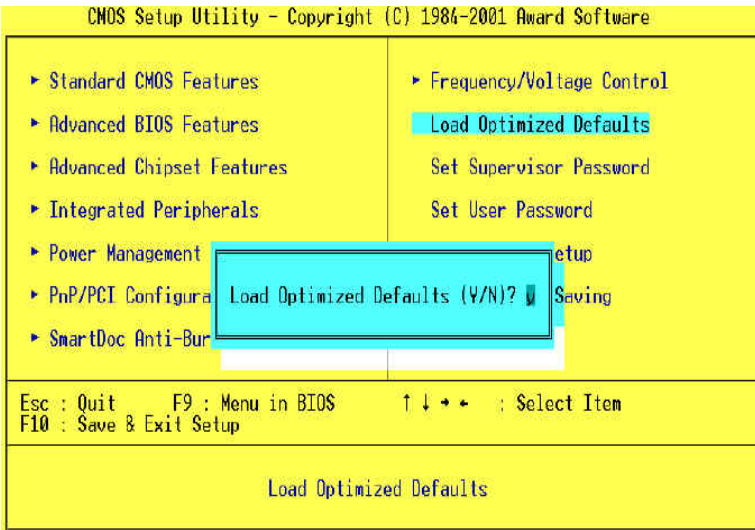

### 4-6.11 Set Supervisor / User Password

- These two options allow you to set your system passwords. Normally, the supervisor has a higher priority to change the CMOS setup option than the users. The way to set up the passwords for both Supervisor and Users are as follows:

1. Choose “Change Password” in the Main Menu and press <Enter>. Then following message appears:

**“Enter Password : ”**

2. The first time you run this option, enter your password up to 8 characters and press <Enter>. (The screen does not display the entered characters.)
3. After you enter the password, the following message appears prompting you to confirm the password:

**“Confirm Password : ”**

4. Enter the same password “exactly” the same as you have just typed to confirm the password and press <Enter>.
5. Move the cursor to Save & Exit Setup to save the password.
6. If you need to delete the password entered before, choose the Supervisor Password and press <Enter>. It will delete the password that you have entered before.
7. Move the cursor to Save & Exit Setup to save the option you have just configured; otherwise the old password will still be there the next time you turn your system on.
8. Press <Enter> to exit to the Main Menu.

**NOTE:** If you forget or lose the password, the only way to access the system is to clear the CMOS RAM. All setup informations will be lost and you need to run the BIOS setup program again.

#### **4-6.12 Save & Exit Setup**

- SAVE & EXIT SETUP allows you to save all modifications you have specified into the CMOS memory. Highlight this option on the Main Menu and the following message appears:

```
`` SAVE to CMOS and EXIT (Y/N) ? Y ``
```

“Y” is for “Yes”, and “N” is for “No”.

Press <Enter> key to save the configuration changes.

#### **4-6.13 Exit Without Saving**

- EXIT WITHOUT SAVING option allows you to exit the Setup Utility without saving the modifications that you have specified. Highlight this option on the Main Menu and the following message appears:

```
`` Quit Without Saving (Y/N) ? N ``
```

“Y” is for “Yes”, and “N” is for “No”.

You may change the prompt to “Y” and press <Enter> key to leave this option .



***MEMO***

## ***Chapter 5 RAID Controller***

***The following topics and Appendices are included in this chapter:***

**5-0 Before Creating Disk Array**

**5-1 Creating your Disk Array**

**5-2 Using FASTBUILD™ Configuration Utility**

**5-3 Installing FAST TRAK100-LITE Driver**

### 5-0 Before Creating Dsik Array:

- (1) Please locate the Promise RAID Controller on your mainboard to make sure that you are using the right board.
- (2) Locate the RAID Controller Select Jumper JP4 on board, and make sure this Jumper is set at Pin 1-2 closed for enabling IDE RAID controller. Please refer to the following Setup illustration of JP4 on board:

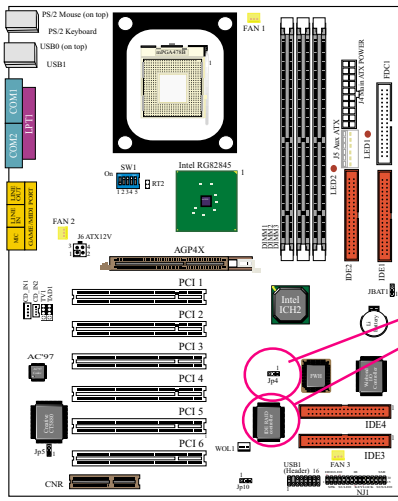

On-Board RAID Controller  
Select by JP4 setting:

**Jp4**  
RAID Controller

1-2 closed  
Enabled(default)

---

12-3 closed  
Disabled

## 5-1 Creating Your Disk Array

To create your disk array, you have to open the FastBuild Utility, which should have already been built in your system BIOS through the Promise Controller. You can create two types of array with the help of FastBuild Utility.

- (1) An array for Performance in Striping type with 1 or 2 drives (or called RAID 0).
- (2) An array for Data Security in Mirroring type with 2 drives treated as one disk array (or called RAID 1).

**WARNING :** *To create a Security array using an existing hard drive, backup any necessary data. Failure to follow this could result in data loss.*

### 5-1.1 Creating An Array For Performance

*FastTrak100-Lite allows users to create striped arrays with 1 or 2 drives.*

1. **Boot your system with FastTrak100-Lite Controller enabled by JP4 and your hard drive(s) connected to IDE3/IDE4.** Suppose this is the first time to create a Disk Array. The Promise BIOS on board with FastBuild Utility built in will scan the IDE devices and display the result as below:

FastTrak100-Lite (tm) BIOS Version 1.xx (Build xxxx)  
(c) 1995-2000 Promise Technology, Inc. All Rights Reserved.

No array is defined...

Press <Ctrl-F> to enter FastBuild (tm) Utility  
Or press <ESC> key to continue booting the system.

2. Press <Ctrl-F> keys to display the FastBuild (tm) Utility Main Menu.

3. Press “1” to display the Auto Setup Menu below. This is the fastest and easiest method to create your first array.

```

FastBuild (tm) Utility 1.xx (c) 1995-2000 Promise Technology, Inc.
[Auto Setup Options Menu]

Optimize Array for:           Performance
Typical Application usage:    Desktop

                                [Array Setup Configuration]

Mode ..... Stripe
Spare Drive .....0
Drives used in Array .....1
Array Disk Capacity .....38166

                                [Keys Available]

[↑] Up [↓] Down [←,→, Space] Change Option
[ESC] Exit [Ctrl-Y] Save

```

4. Using the Spacebar, choose “Performance” under the **Optimize Array for** section.
5. Select how you will use your PC under the **Typical Application usage** section. The choices are A/V Editing, Server, and Desktop (the default).
6. Press <Ctrl-Y> keys to save and create the array.
7. Reboot your system.
8. Once the array has been created on new drive(s), you would need to use FDISK and format the array as if it were a new single hard drive.
9. Also proceed to “Installing Drivers” section of this Chapter (see Section 5-3) for system and FastTrak100 Driver setup.

## 5-1.2 Creating A Security (Mirror) Array With New Drives

*FastTrak100-Lite on board permits only two drives to be used for a single Mirroring array with FastBuild Utility.*

1. **Boot your system with FastTrak100-Lite Controller enabled by JP4 and your hard drive(s) connected to IDE3/IDE4.** Suppose this is the first time to create a Disk Array. The Promise BIOS on board with FastBuild Utility built in will scan the IDE devices and display the result as below:

```
FastTrak100-Lite (tm) BIOS Version 1.xx (Build xxxx)
(c) 1995-2000 Promise Technology, Inc. All Rights Reserved.

      No array is defined...

Press <Ctrl-F> to enter FastBuild (tm) Utility
Or press <ESC> key to continue booting the system.
```

2. Press <Ctrl-F> keys to display the FastBuild (tm) Utility Main Menu.
3. Press "1" to display the Auto Setup Menu below. This is the fastest and easiest method to create your first array.

```
FastBuild (tm) Utility 1.xx (c) 1995-2000 Promise Technology, Inc.
      [Auto Setup Options Menu]

Optimize Array for:                Performance
Typical Application usage:        Desktop

      [Array Setup Configuration]

Mode ..... Stripe
Spare Drive .....0
Drives used in Array .....1
Array Disk Capacity .....38166

      [Keys Available]

[↑] Up [↓] Down [←,→, Space] Change Option
[ESC] Exit [Ctrl-Y] Save
```

4. Using the Spacebar, choose “Security” under the “**Optimize Array for**” section.

5. Press <Ctrl-Y> keys to save and create the array.

6. The window below will appear:

Do you want the disk image to be duplicated to another? (Yes/No)  
Y - Create and Duplicate  
N - Create Only

7. Press “N” for the Create Only option.

8. A window will appear almost immediately confirming that your Security array has been created. Press any key to reboot the system.

Array has been created.  
<Press Any key to Reboot>

9. Proceed with normal FDISK and format procedures as if you had just installed a new hard drive.

10. Once the arrayed drives have been formatted, proceed to Section 5-3 “**Installing Driver**” to install your operating system and FastTrak100-Lite driver.

### 5-1.3 Creating Security Array With Existing Data Drive

*FastTrak100-Lite on board permits only two drives to be used for a single Mirroring (Security) array with FastBuild Utility.*

***Checkpoints before creating a Security Array:***

- (1) You may use a drive that is containing data or a bootable O/S. Then you will need another new drive of identical or larger storage capacity.*
- (2) Backup any necessary data before proceeding. Failure to follow this accepted PC practice could result in data loss.*
- (3) If you wish to include your current bootable drive holding Window NT 4.x or Windows 2000 O/S as part of a bootable Mirroring (RAID 1) array on your FastTrak100-Lite controller , you SHOULD first install the Windows NT4 or 2000 driver software to this drive while it is still attached to your system hard drive controller (e.g. IDE1/IDE2). For all other Operating Systems except Win NT4.0 and 2000, you can proceed with your hard driver(s) connected to IDE3/DIE4.*

- 1. Boot your system with FastTrak100-Lite Controller enabled by JP4 and your hard drive(s) connected to IDE3/IDE4.** Suppose this is the first time to create a Disk Array. The Promise BIOS on board with FastBuild Utility built in will scan the IDE devices and display the result as below:

FastTrak100-Lite (tm) BIOS Version 1.xx (Build xxxx)  
(c) 1995-2000 Promise Technology, Inc. All Rights Reserved.

No array is defined...

Press <Ctrl-F> to enter FastBuild (tm) Utility  
Or press <ESC> key to continue booting the system.

- 2. Press <Ctrl-F> keys to display the FastBuild (tm) Utility Main Menu.**



3. Press "1" to display the Auto Setup Menu below. This is the fastest and easiest method to create your first array.

```
FastBuild (tm) Utility 1.xx (c) 1995-2000 Promise Technology, Inc.
[Auto Setup Options Menu]

Optimize Array for:           Performance
Typical Application usage:    Desktop

[Array Setup Configuration]

Mode ..... Stripe
Spare Drive .....0
Drives used in Array .....1
Array Disk Capacity .....38166

[Keys Available]

[↑] Up [↓] Down [←,→, Space] Change Option
[ESC] Exit [Ctrl-Y] Save
```

4. Using the Spacebar, choose "Security" under the **Optimize Array for** section.
5. Press <Ctrl-Y> keys to Save your selection. The window below will appear:

```
Do you want the disk image to be duplicated to another? (Yes/No)
Y - Create and Duplicate
N - Create Only
```

6. Press “Y” for the “Create and Duplicate” option. The window below will appear asking you to select the Source drive to use.

Channel: ID	Source Disk Drive Model	Capacity (MB)
Channel: ID	Target Disk Drive Model	Capacity(MB)
Channel: ID	[Please Select A Source Disk] Drive Model	Capacity (MB)
1 : Master	QUANTUMCR8.4A	8063
2 : Master	QUANTUMCR8.4A	8063
[ ↑ ] Up [ ↓ ] [ESC] Exit [Ctrl-Y] Save		

7. Use the arrow keys to choose which drive contains the existing data to be copied. FastBuild will copy all data from the Source drive to the Target drive.
8. Press [Ctrl-Y] keys to save selection and start duplication. The following progress screen will appear:

Start to duplicate the image .....
Do you want to continue? (Yes/No)
Y - Continue N - Create Only

9. Select “Y” to continue. If you choose “N”, you will return to step 4.
10. Once complete, the following screen will appear confirming that your Security array has been created. Press any key to reboot the system.

Array has been created. <Press Any key to Reboot>
--

11. Proceed to Section **5-3 Installing Driver** to install the FastTrak100-Lite driver and/or operating system.

## 5-2 Using FASTBUILD™ Configuration Utility

The FastBuild™ Configuration Utility offers several menu choices to create and configure the drive array on the Promise FastTrak100-Lite. In this Section, it is assumed you have already created an array in the previous Section and now wish to make a change to the array or view other status .

### 5-2.1 Viewing FastTrak100-Lite BIOS Screen

When you boot your system with the FastTrak100-Lite Controller enabled and drives connected to RAID IDE3 / IDE4, the Promise BIOS on board will detect the drives attached and show the following screen.

```
FastTrak100-Lite (tm) BIOS Version1.xx (Build xx)
(c) 1995-2000 Promise Technology, Inc. All Rights Reserved.

Scanning IDE drives .....
```

If an array exists already, the BIOS will display the following screen showing the Promise BIOS version and status of the array.

```
FastTrak100-Lite (tm) BIOS Version1.xx (Build xxxx)
(c) 1995-2000 Promise Technology, Inc. All Rights Reserved.

ID      MODE SIZE      TRACK-MAPPING      STATUS
1*     2+0 Stripe  16126M   611/128/32   Functional

Press <Ctrl-F> to enter FastBuild (tm) Utility .....
```

The array status consists of three possible conditions: Functional, Critical, Off-line.

**Functional** - The array is operational.

**Critical** - A mirroring array contains a drive that has failed or disconnected. The remaining drive member in the array is functional. However, the array has temporarily lost its ability to provide fault tolerance. The user should identify the failed drive through the FastBuild™ Setup utility, and then replace the problem drive.

**Off-line** - A striped array having only 1 drive has failed or been disconnected. When the array condition is "Off-line", the user must replace the failed drive (s) , then restore data from a backup source.

## 5-2.2 Navigating the FastBuild™ Setup Menu

When using the menus, there are some of the basic navigation tips: Arrow keys highlights through choices; [ESC] key is used to abort or exit the current menu.

## 5-2.3 Using the Main Menu

This is the first option screen when entering the FastBuild™ Setup.

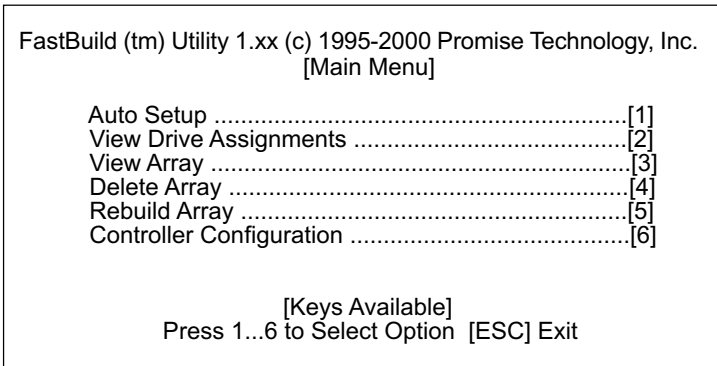

To create a new array automatically, follow the setups under “Creating Arrays Automatically” in Section 5-1. Promise recommends this option for most users.

To view drives assigned to arrays, see “Viewing Drive Assignments” in Section 5-2.5.

To delete an array (but not delete the data contained on the array), select “Deleting An Array” in Section 5-2.12.

To rebuild a mirroring array, see “Rebuilding an Array” in Section 5-2.13.

To view controller settings, see “Viewing Controller Configuration” in Section 5-2.14.

**NOTE:** After configuring an array of new blank drive(s) using FastBuild, you should FDISK and format the arrayed drive(s) , in a way depending on the type of system you are using.

### 5-2.4 Creating Arrays Automatically

The Auto Setup <1> selection from the Main Menu can intuitively help create your disk array. It will assign all available drives appropriate for the disk array you are creating. After making all selections, use Ctrl-Y to save selections. FastBuild will automatically build the array.

```
FastBuild (tm) Utility 1.xx (c) 1995-2000 Promise Technology, Inc.
[Auto Setup Option Menu]

Optimize Array for:                Performance
Typical Application usage:         A/V Editing

[Auto Setup Option Menu]

Mode ..... Stripe
Spare Drive Count ..... 1
Drives used in Array ..... 2
Array Disk Capacity ..... 16126

[Keys Available]

Press 1...6 to Select Option [ESC] Exit
```

### 5-2.4-1 Optimize Array For

Select whether you want Performance (RAID 0), or Security (RAID 1) under the “Optimize Array for” setting.

#### (1) Performance (RAID 0 Striping)

Supports the maximum performance. The storage capacity equals the number of drives times the capacity of the smallest drive in the disk array.

**NOTE:** *FastTrak100-Lite permits striped arrays of 1 or 2 drives attached in Auto Setup mode.*

#### (2) Security (RAID 1 Mirroring)

Creates a mirrored (or fault tolerant) array for data security.

**NOTE:** *Under the Security setting, FastTrak100-Lite permits two drives to be used for a single Mirrored array.*

### 5-2.4-2 Defining Typical Application Usage

Allows the user to choose the type of PC usage that will be performed in order to optimize how FastTrak100-Lite handles data blocks to enhance performance. Your choice will determine the block size used. You may choose from: A/V Editing (for audio/video applications, or any similar application that requires large file transfers), Server (for numbers of small file transfers), or Desktop (a combination of large and small file sizes).

## 5-2.5 Viewing Drive Assignments

The View Drive Assignments <2> option in the Main Menu displays whether drives are assigned to a disk array or are unassigned.

Under the “Assignment” column, drives are labeled with their assigned disk array or shown as “Free” if unassigned. Such “Free” drives can be used for a future array or used as a spare drive when a drive fails in a mirrored array. Unassigned drives are not accessible by the OS. The menu also displays the data transfer mode that relates to speed used by each drive (U5 refers to 100MB/sec transfers, U4 refers to 66MB/sec transfers, etc ...)

FastBuild (tm) Utility 1.xx (c) 1995-2000 Promise Technology, Inc.  
[View Drive Assignments]

Channel:	ID	Drive Model	Capacity (MB)	Assignment	Mode
1:	Master	QUANTUMCR8.4A	8063	Array 1	U5
1:	Slave	QUANTUMCR8.4A	8063	Free	U5
2:	Master	QUANTUMCR8.4A	8063	Array 1	U5

[Keys Available]

[↑] Up [↓] Down [ESC] Exit Mode (U=UDMA, P=PIO, D=DMA)

## 5-2.6 View an Array

The View Array <3> option from the Main Menu allows users to view the defined elements and RAID status that have already been defined by FastBuild Utility.

FastBuild (tm) Utility 1.xx (c) 1995-2000 Promise Technology, Inc.  
[View Array Menu]

Array No	RAID Mode	Total drv	Capacity(MB)	Status
*Array 1	Stripe	2	16126	Functional
Array 2	---	---	---	---
Array 3	---	---	---	---
Array 4	---	---	---	---

[Keys Available]

Note:\* ---Bootable Array

[↑] Up [↓] Down [ESC] Exit [Enter] Select  
[Space] Change Boot Drive

## 5-2.7 Adding Fault Tolerance to an Existing Drive

FastTrak100-Lite will create a mirroring array using an existing system drive with data. You must assign the existing drive and another drive of same or larger capacity to the Mirroring array. The BIOS will send the existing data to the new blank drive.

**WARNING :**

- Backup any necessary data before proceeding. Failure to follow this practice will result in data loss.
- If you wish to include your current bootable drive using the Windows NT 4.x or Window 2000 operating system as part of a bootable Mirrored (RAID 1) array on your FastTrak100-Lite, do NOT connect the hard drive to the Fast Trak100-Lite Controller yet. You MUST install the drive of Fast Trak100-Lite Controller first (see Section 5-3) to this drive while it is still attached to your existing hard drive controller. For all other Operating System proceed like here.

1. After assigning the drives to a Mirroring array, press <Ctrl-Y> key to save your selection. The window below will appear.

Do you want the disk image to be duplicated to another? (Yes/No) Y - Create and Duplicate N - Create Only
---

2. Press “Y” for the Create and Duplicate option. The window below will appear asking you to select the Source drive to use. FastBuild will copy all data from the Source drive to the Target drive.

	Source Disk	
Channel: ID	Drive Model	Capacity (MB)
	Target Disk	
Channel: ID	Drive Model	Capacity (MB)
[Please Select A Source Disk]		
Channel: ID	Drive Model	Capacity (MB)
1: Master	QUANTUMCR8.4A	8063
2: Master	QUANTUMCR8.4A	8063
[ ↑ ] Up [ ↓ ] [ESC] Exit [Ctrl-Y] Save		





1. Once you have returned to the Define Array Menu window (below), you will see the array(s) you have created. You now may use the menu to select which previously-defined array will be used as the bootable array.

```
FastBuild (tm) Utility 1.xx (c) 1995-2000 Promise Technology, Inc.
[Define Array Menu]

Array No  RAID Mode  Total Drv  Capacity(MB)  Status
* Array 1   Stripe      2          13044          Functional

Note: * --- Bootable Array

      [↑] Up [↓] Down [ESC] Exit [Enter] Select
      [Space] Change Boot Drive
```

2. Use the [↑] Up [↓] Down keys to highlight the array which you want to from boot.
3. Press the [Space] bar.
4. An\* asterisk will appear next to the array number indicating it as bootable. The system will now recognize this array as the first array seen.
5. The system will then use this bootable array as the (fixed) boot C: drive.

**NOTE:** *The bootable array must contain your configured operating system.*

### 5-2.9 Creating a “Hot” Spare Drive for Mirroring Arrays

For automatic rebuilds of a mirroring array, attach an extra “spare” drive to the FaskTrak100-Lite. Drives that are not assigned to an array and are the same size or larger than the original will be used for the automatic rebuild. This is performed in the background under all supported operating systems, except DOS. At a later time, the system can be turned off and the failed drive can be physically removed.

### 5-2.10 How FastTrak100-Lite Orders Arrays

During startup, the disk arrays on the FastTrak100-Lite are recognized in this order: 1) The array set to bootable in the FastBuild™ Setup, and 2) the Array number (i.e. Array 0, Array 1 ...). This would involve determining which drive letters will be assigned to each disk array.

### 5-2.11 How FastTrak100-Lite Saves Array Information

All disk array data are saved into the reserved sector on each array member. Promise suggests that users record their disk array information for future reference.

Another feature of the FastTrak100-Lite disk array system is to recognize drive members even if drives are moved between different FastTrak100-Lite card connectors. Since each drive's array data identifies itself to the array, it is possible to move or swap drives without modifying the array setup. This is valuable when adding drives, or during a rebuild.

### 5-2.12 Deleting An Array

The Delete Array <4> Menu option allows for deletion of disk array assignments. This is not the same as deleting data from the drives themselves. If you delete an array by accident (and before it be used again), the array can normally be recovered by defining the array identically as deleted array (by Using Auto Setup).

**WARNING:** *Deleting an existing disk array could result in its data loss. Make sure to record all array information including the array type, the disk members, and stripe block size in case you wish to undo a deletion.*

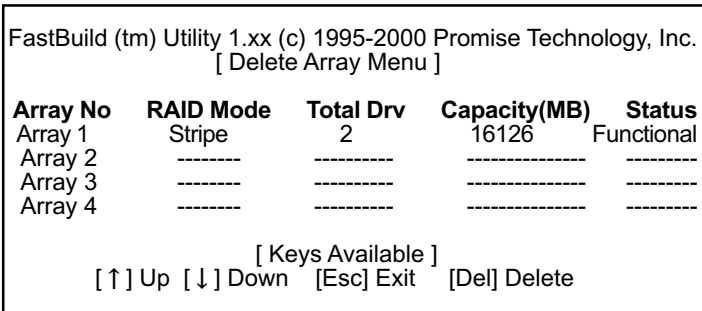

1. To delete an array, highlight the Array you wish to delete and press the [Del] key.
2. The View Array Definition menu will appear (see below) showing which drives are assigned to this array.

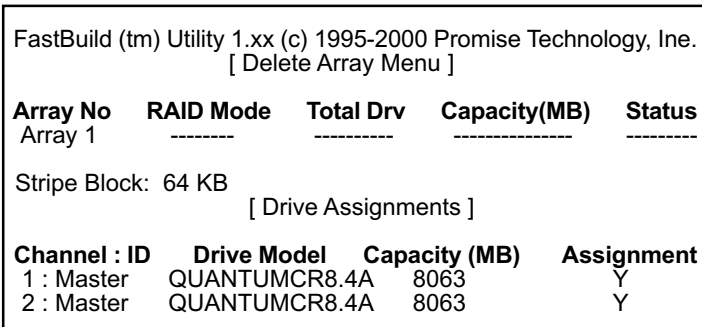

3. Confirm yes to the follow warning message with the <Ctrl-Y> key to continue array deletion:

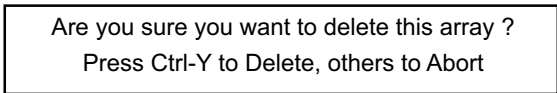

4. After deleting the array, you should create a new array using Auto Setup.

### 5-2.13 Rebuilding A Mirroring Array

The Rebuild Array <5> Menu option is necessary for recovering from an error in a mirrored disk array. You will receive an error message when booting your system from the FastTrak BIOS.

**NOTE:** Drives *MUST* be replaced if they contain any physical errors.

Follow these steps BEFORE using the Rebuild Array menu option:

1. On bootup, the FastTrak100-Lite Startup BIOS will display an error message identifying which drive has failed.
2. Press <Ctrl-F> keys to enter FastBuild Main Menu.
3. Select submenu Define Array <3>.
4. Select the failed array and identify the Channel and ID of the failed drive.
5. Power off and physically remove the failed drive.
6. Replace the drive with an identical model.
7. Reboot the system and enter the FastBuild Main Menu.
8. Select the <5> Rebuild Array option. The following screen will appear.

```

FastBuild (tm) Utility 1.xx (c) 1995-2000 Promise Technology, Inc.
      [ Delete Array Menu ]
Array No  RAID Mode  Total Drv  Capacity(MB)  Status
Array 1      Mirror      2          16126          Critical
Array 1      -----      --          -----          -----
Array 1      -----      --          -----          -----
Array 1      -----      --          -----          -----

      [ Keys Available ]
[↑] Up [↓] Down [Esc] Exit [Del] Delete
  
```

9. Highlight the array whose Status is "Critical".
10. Press [Enter]. The following screen will then appear (see next page).



### 5-2.14 Viewing Controller Settings

The Controller Configuration <6> menu selection allows you to enable or disable the halting function of FastTrak100-Lite BIOS (the default) if it detects an error on boot up. You may also view the system resources (Interrupt and I/O port address) of FastTrak's data channels.

```

FastBuild (tm) Utility 1.xx (c) 1995-2000 Promise Technology, Inc.
      [ Adapter Configuration - Options ]

      Halt On Error:          Enable

      [ System Resources Configuration ]

Channel 1 (IDE1)      Interrupt : A      I/O Port : FFF0
Channel 2 (IDE2)      Interrupt : A      I/O Port : FFA8

      [ Keys Available ]
[←, →, Space] Change Option  [Esc] Exit

```

### 5-2.15 Halting FastTrak BIOS On Bootup Errors

The [Adapter Configuration ---- Options] section allows you to enable or disable FastTrak100-Lite to Halt operation at the BIOS startup screen should an error be detected. This is the only option that can be changed on this screen.

## 5-3 Installing Drivers

This section details the FastTrak100-Lite driver installation for various operating systems. The driver should have been included either into the Support CD or into a Support Floppy Diskette.

### ***Checkpoints for the driver installation:***

- (1) *To install FastTrak100-Lite Driver for an operating system, you must use the driver in Floppy Diskette instead of the one in CD. If you are not provided with a Driver Diskette, you should create one by copying the driver files through the support CD with the path "E:\Driver\Promise\FastTrak100-Lite. (Suppose that CD-ROM title is E).*
- (2) *Set JP9 on board enabled (Pin 1-2 closed) for RAID Controller Select.*

The following sections describe the detailed procedures of installing FastTrak 100-Lite Driver for windows 2000, Windows 95/98, Windows NT4.0, and Windows 3.1 / DOS.

### 5-3.1 For Windows 2000

#### 5-3.1-1 Installing Driver During New Windows 2000 Installation

1. Connect your hard driver(s) for RAID Array to IDE3/IDE4, and enable FastTrak100-Lite Controller with JP4.
  - 1a. Bootable floppy: Boot from bootable floppy and type "WINNT".  
After files have been copied, the system will reboot. On the reboot, press <F6> after the message "Setup is inspecting your computer's hardware configuration..." appears.
  - 1b. CD-ROM Install: Boot from the windows 2000 CD. Press <F6> after the message " Press F6 if you need to install third party SCSI or RAID driver" appears.
2. When the "Windows 2000 Setup" window is generated, Press "S" to Specify an Additional Device(s).
3. Press "O" to select "Other" and press the "Enter" key.
4. Insert into drive A the Promise Technology ® driver diskette that you have made from your support CD: and press "Enter" key.
5. Choose "Win2000 Promise FastTrak100-Lite Controller" from the list that appears on screen, then press the "Enter" key.



6. The Windows 2000 Setup screen will appear again saying "Setup will load support for the following mass storage devices:" The list will include "Win2000 Promise FastTrak100-Lite controller".

**Note:** *If you need to specify any additional devices to be installed, do so at this time. Once all devices are specified, continue to step 7.*

7. From the Windows 2000 Setup screen, press the Enter key. Setup will now load all device files and then continue the Windows 2000 installation.

### 5-3.1-2 Installing Driver To Existing Windows 2000 System

**WARNING:** *You must first complete installing the driver before moving the boot drive containing the existing Windows 2000 operating system on to the FastTrak100-Lite controller (e.g. IDE3/IDE4). On mainboard 65EP+, IDE1/0 are for system IDE controller, while IDE3 & IDE4 are for RAID IDE controller.*

At booting with Windows 2000 system and your hard drive(s) connected to IDE1/2, Windows 2000 setup will show a "New Hardware Found" dialog box. Under Windows 2000, the "PCI RAID Controller" will be displayed.

1. In the dialog box, choose "Driver from disk provided by hardware manufacturer" button.
2. In the A: drive, insert the FastTrak100-Lite driver diskette.
3. Type "A:\WIN2000" in the text box. Press "Enter".
4. Choose "Win2000 Promise FastTrak100-Lite Controller" from the list that appears on screen, then press the "Enter" key.
5. The Windows 2000 setup screen will appear again saying "Setup will load support for the following mass storage device - Win2000 Promise FastTrak100-Lite controller. The FastTrak100-Lite driver will now be copied on to the system and entered into the Windows 2000 driver database.
6. When the "System Setting Change" dialog box appears, remove the floppy diskette and click on "Yes" to restart the system. Windows 2000 will then restart for the driver installation to take effect.

7. Power off your system, then attach your hard drive to the FastTrak100-Lite controller card, e.g. IDE3/IDE4.

### **5-3.1-3 Confirming Windows 2000 Installation**

1. From Windows 2000, open the Control Panel from “ My Computer” followed by the System icon.
2. Choose the “Hardware” tab, then click the “Device Manager” tab.
3. Click the “+” in front of “SCSI & RAID Controllers hardware type.” The driver “Win2000 Promise FastTrak/FastTrak100-Lite Controller” should appear, informing user that the controller driver is already installed.

## **5-3.2 Windows 95/98**

### **5-3.2-1 Installing Drivers During Windows 95/98 Installation**

The following three sections detail the installation of the FastTrak100-Lite drivers while installing Windows 95/98 (with the FastTrak100-Lite controller card already in place). If you're installing the FastTrak100-Lite drivers on a system with Windows 95/98 already installed, see “Installing Drivers with Existing Windows 95/98”.

### **5-3.2-2 Windows 98**

1. Connect your hard drive(s) for RAID Array to IDE3/IDE4, and enable FastTrak100-Lite Controller with JP4. Configure the hard drive(s), partition and format your hard driver(s).
2. Install Windows 98 normally.
3. After installation, go to “Start” menu and choose “Settings.”
4. Form the “Settings” menu, choose “Control Panel.”
5. In the “Controller Panel” window, double-click on the “System” icon.
6. In the “System” window, choose the “Device Manager” tab.
7. In the hierarchical display under “Other Devices” is a listing for “PCI RAID Controller.” Choose it and then press the “Properties” button.
8. Choose the “Driver” tab in the “Properties” window, choose “Update Driver,” and then press “Next.”
9. Choose “Search for a better driver than the one your device is using now (recommended),” then press “Next”.

10. Choose "Specify Location," and then type "A:\WIN95-98" in the text box.
11. Insert the "FastTrak100-Lite Driver" diskette into the A: drive.
12. Press the "Next" button. A message informing you that Windows 98 has found "Win95-98 Promise FastTrak100-Lite (tm) Controller" should appear.
13. Press "Next," then "Finish," then "Yes" when asked if you want to restart your computer. Be sure to remove the diskette from drive A:.

### **5-3.2-3 Windows 95**

1. Connect your hard drive(s) for RAID Array to IDE3/IDE4, and enable FastTrak100-Lite Controller with JP4. Configure the hard drive(s) for RAID Array, partition and format your hard driver(s).
2. Install Windows 95 normally.
3. After installation, go to "Start" menu and choose "Settings."
4. From the "Settings" menu, choose "Control Panel."
5. In the "Control Panel" window, double-click on the "System" icon,
6. In the "System" window, choose the "Device Manager" tab.
7. In the hierarchical display under "Other Devices" is a listing for "PCI RAID Controller." Choose it and then press the "Properties" button.
8. Choose the "Driver" tab in the "Properties" window, and then press the "Update Driver" button.
9. When asked if you want Windows to research for the driver, choose "Yes (recommended)."
10. Insert the "FastTrak100-Lite Driver" diskette into the A: drive, then press "Next."
11. When Windows informs you that it was unable to find the drivers, press "Other Locations..."
12. In the "Select Other Location" dialog box, type "A:\WIN9x-ME".
13. Press "Next" button. A message informing you that Windows 95 has found "Win95-98 Promise FastTrak100-Lite (tm) Controller" should appear.
14. Press "Finish." (If Windows can't find the "FastTrak100-Lite.MPD" file, type "A:\WIN9x-ME" in the copy files from:" text box).
15. Choose "Yes" when asked if you wish to restart the system, and remove the diskette from Drive A.

### **5-3.2-4 Installing Drivers With Existing Windows 95/98**

The following three sections detail the installation of the FastTrak100-Lite drivers on a system that has Windows 95/98 already installed. If you're installing the FastTrak100-Lite drivers on a system during a Windows 95/98 installation, see "Installing Drivers During Windows 95/98 Installation".

### **5-3.2-5 Windows 98**

1. Connect your hard drive(s) for RAID Array to IDE3/IDE4, and enable FastTrak100-Lite Controller with JP4. Configure the hard drive(s) for RAID Array, power up the system and boot Windows.
2. The "Add New Hardware Wizard" will appear, informing you that it has found a "PCI RAID Controller."
3. Check the "Search for the best driver for your device" box and click the Next button.
4. Check the "Specify a Location" box and click the Next button.
5. Type "A:\WIN9x-ME" in the text box that appears.
6. Insert the "FastTrak100-Lite Driver" diskette in drive A:.
7. Click on "Next." The Add New Hardware wizard will say it has found "Win95-98 Promise FastTrak100-Lite Controller".
8. Click on "Next," and then on "Finish."
9. Choose "Yes" when asked if you want to restart your computer. Be sure to remove the diskette from drive A:.

### **5-3.2-6 Windows 95**

1. Connect your hard drive(s) for RAID Array to IDE3/IDE4, and enable FastTrak100-Lite Controller with JP9. Configure the hard drive(s) for RAID Array, power up the system and boot Windows.
2. The "Update Device Drive Wizard" will appear, informing you that it has found a "PCI Mass Storage Controller."
3. Insert the "FastTrak100-Lite Driver" diskette in drive A:.
4. Type "A:\WIN9x-ME" in the text box, then click on "Next." Windows will inform you that it has found the "Win95/98 Promise FastTrak100-Lite controller".
5. Click on "Finish," and when prompted to insert the "FastTrak100-Lite Driver" diskette, click on "OK."

6. If a message informing you that the file "Win95/98 Promise FastTrak100-Lite.MPD" cannot be found, go to the "Copy files from:" text box and type: "A:\WIN9x-ME".
7. Choose "Yes" when asked whether you want to start your computer. Be sure to remove the diskette from drive A.

### 5-3.2-7 Confirming Driver Installation in Windows 98/95

To confirm that the driver has been properly loaded in Win 95/98, perform the following steps:

1. Choose "Settings" from the "Start" menu.
2. Choose "Controller Panel", and then double-click on the "System" icon.
3. Choose the "Device Manager" tab, and click the "+" in front of "SCSI & RAID controllers." "Win95-98 Promise FastTrak100-Lite controller" should appear.

### 5-3.3 DOS/Windows 3.1x

For first-time installation, follow the standard procedure of installing DOS on to your hard disk (partition all hard drive with FDISK and format before performing the following procedure):

1. Insert "Disk 1" of your DOS installation diskettes into drive A:.
2. Type "A:\SETUP" at the "A:\>" prompt.
3. Continue with normal DOS installation procedure, and refer to your DOS manual for additional details.

**Note:** *The FastTrak100-Lite BIOS supports both DOS and Windows 3.1x without software drivers installed.*

## 5-3.4 Windows NT4.0

### 5-3.4-1 Installing Drivers During Windows NT 4.0 Installation

1. Connect your hard drive(s) for RAID Array to IDE3/IDE4, and enable FastTrak100-Lite Controller with JP4. Start the system installation by booting from the Windows NT disk:
  - a) Floppy install: boot the system with the Windows NT installation diskettes.
  - b) Other bootable Floppy: boot from the bootable floppy and type "WINNT /B". After files have been copied, the system will reboot. On the reboot, press the "F6" key when the message "Setup is inspecting your computer's hardware configuration..." appears.
  - c) CD-ROM disk install: boot from the CD-ROM disk and press the "F6" key when the message "Setup is inspecting your computer's hardware configuration..." appears.
2. When the "Windows NT Setup" windows is generated, press "S" to Specify an Additional Device(s).
3. Press "O" to select "Other" and press the "Enter" key.
4. Insert into drive A the Promise Technology ® FastTrak100-Lite driver diskette that you have made from the support CD: and press "Enter" key.
5. Choose "Win NT Promise FastTrak100-Lite (tm) Controller" from the list that appears on screen, then press the "Enter" key.
6. The Windows NT Setup screen will appear again saying "Setup will load support for the following mass storage devices:" The list will include "Win NT Promise FastTrak100-Lite (tm) controller".

**Note:** *If you need to specify any additional devices to be installed, do so at this time. Once all devices are specified, continue to step 7.*

7. From the Windows NT Setup screen, press the Enter key. Setup will now load all device files and then continue the Windows NT installation.
8. After a successful installation, the "SCSI Adapter Setup" box will show that the "Win NT Promise FastTrak100-Lite (tm) Controller" driver has been installed.

### 5-3.4-2 Installing Drivers With Existing Windows NT4.0

**WARNING:** *You must first complete installing the driver before moving the boot drive containing the existing Windows 2000 operating system on to the FastTrak100-Lite controller (e.g. IDE3/IDE4). On mainboard 65EP+, IDE1/0 are for system IDE controller, while IDE3 & IDE4 are for RAID IDE controller.*

With your bootable hard drive connected to IDE1/IDE2 and FastTrak100-Lite enabled by JP4, boot Win NT4.0.

1. Choose "Settings" from the "Start" menu.
2. Choose "Controller Panel" from the "Settings" menu.
3. Double-click on the "SCSI Adapters" icon, which generates the "SCSI Adapters" dialog box.
4. Choose "Drivers," and then press "Add."
5. In the "Install Drivers" dialog box, press "Have Disk..."
6. When the "Install From Disk" appears, insert into Drive A the "FastTrak100-Lite Driver" diskette that you have made from support CD:.
7. Type "A:\NT4" in the text box window, then choose "OK."
8. When the "Install Driver" dialog box appears, select "Win NT Promise FastTrak100-Lite controller" and then press "OK."
9. When the "Select SCSI Adapter Option" dialog box appears, press "Install".
10. After a successful installation, the "SCSI Adapter Setup" box will show that the "Win NT Promise FastTrak100-Lite (tm) Controller" driver has been installed.
11. Power off your system.
12. Now you can move the boot drive to the FastTrak100-LiteController.

**MEMO**



# APPENDICES

*Appendix-1 Identifying BIOS Version and  
BIOS Part Number*

*Appendix-2 Identifying Mainboard Model  
Number*

*Appendix-3 Technical Terms*

---

## Appendix-1 Identify BIOS Version & BIOS Part Number

- When you boot up your computer, you may see a screen which shows your computer is phoenixnet™ enabled. Please see Picture-1 below for an illustration.
- When the screen shows up press “Tab” key for BIOS information.

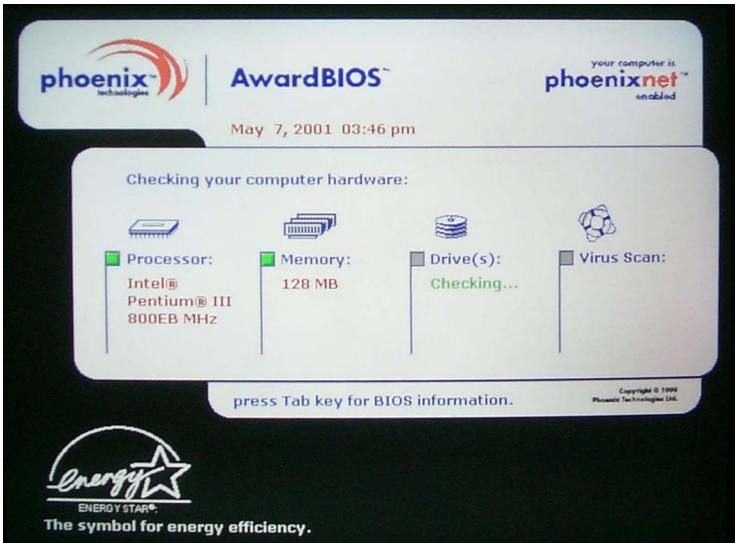

Picture-1

- See Picture-2 below for BIOS version and BIOS part number identification.

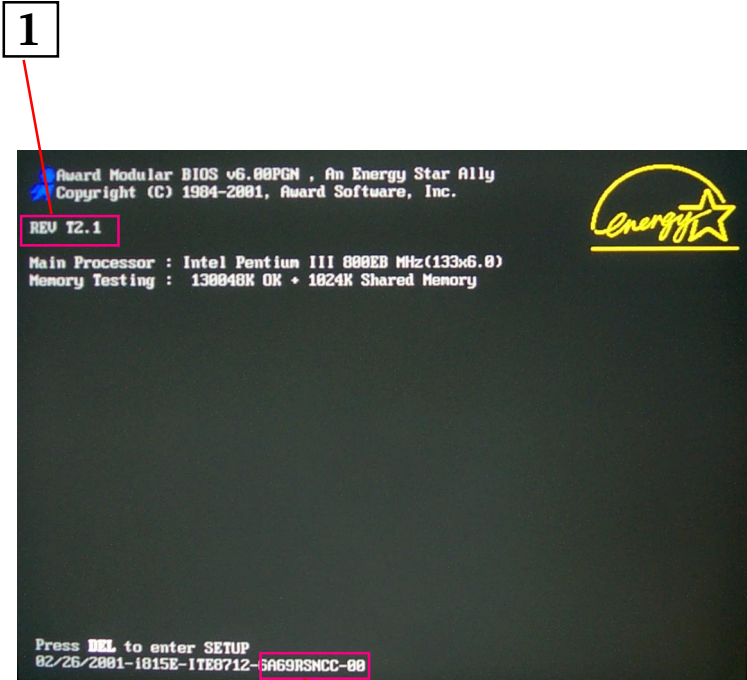

Picture-2

1. BIOS Version  
example: REV T2.1
2. BIOS ID String  
example: 6A69RSNCC

## Appendix-2 Identify Mainboard Model Number

- Usually the mainboard model number is labeled on the side of ISA side of slot or PCI slot. Please see the picture below as an illustration:

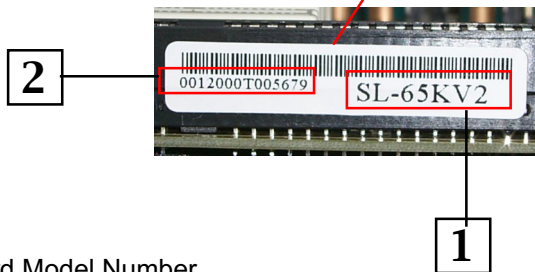
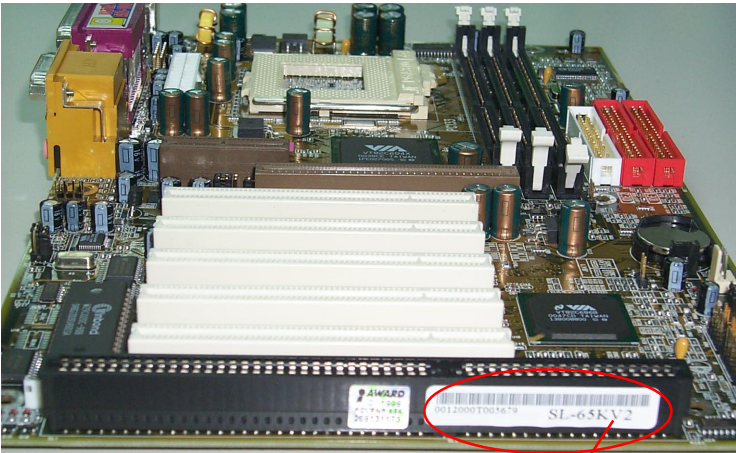

1. Mainboard Model Number  
example: SL-65KV2
2. Mainboard Serial Number  
example: 0012000T005679

## Appendix-3 Technical Terms

### AC'97

AC'97 is a device designed to include a digital processor for modem and an audio CODEC for analog I/O. These two parts are linked together by AC'97 link bus. Putting the digital processor into the main system chipset will reduce the cost of sound/modem onboard solution.

### ACPI (Advanced Configuration & Power Interface)

ACPI is developed together by Intel, Microsoft and Toshiba. This interface provides a channel of management of the PC system and its hardware such as CPU and BIOS, pushing the PC power management to a more advanced and user-friendly level.

### AGP (Accelerated Graphic Port)

AGP is a bus interface targeted for high-performance 3D graphics. AGP takes advantage of both rising and falling edge of the 66MHz clock. For 2X AGP, the data transfer rate is  $66\text{MHz} \times 4\text{byte} \times 2 = 528\text{MB/s}$ . AGP 4X mode is  $66\text{MHz} \times 4\text{byte} \times 4 = 1056\text{MB/s}$ .

### AMR (Audio/Modem Riser)

AMR is an interface to connect the CODEC circuit of AC'97 sound/modem solution to the mainboard through an AMR card and an AMR connector.

### APM (Advanced Power Management)

APM is developed by Intel and Microsoft, intending for PC power management through the system BIOS. Through APM, the PC power consumption can be reduced to 5W or lower.

### ATA (AT Attachment), ATA/66, ATA/100

ATA is the specification of disk drive interface, that integrates the controller on the disk drive itself with the IDE technology.

ATA/66 uses both rising edge and falling edge to provide a data transfer rate  $16.6\text{MB/s} \times 4 = 66\text{MB/s}$ . To use ATA/66, you need special ATA/66 IDE cable.

ATA/100 also uses both rising edge and falling edge as ATA/66, but clock cycle time is reduced to 40ns. The data transfer rate is  $(1/40\text{ns}) \times 2 \text{ bytes} \times 2 = 100\text{MB/s}$ . To use ATA/100, you need special 80-wire IDE cable, the same as ATA/66.

**BIOS (Basic Input/Output System)**

BIOS is a set of assembly routine/program that resides in EPROM or Flash ROM. BIOS controls Input/output devices and other hardware devices of the mainboard. Generally, operation system and drivers will access BIOS before accessing hardware devices so as to enhance the portability of the hardware devices.

**Bus Master IDE (DMA mode)**

An IDE interface is an interface for mass storage devices, in which the controller is integrated into the disk or CD-ROM itself. To reduce the workload of the CPU, the bus master IDE device transfers data from/to memory without interrupting CPU, and releases CPU to operate concurrently while data is transferring between memory and IDE device. You need the bus master IDE driver and the bus master IDE HDD to support bus master IDE mode.

**CAS (Column Address Strobe)**

CAS is a technology of DRAM writes and reads. The number of clock cycles of the CAS signals is depending on the DRAM timing.

**CNR (Communication and Networking Riser)**

CNR interface provides a cost reducing method of implementing LAN, home networking, DSL, USB, wireless, audio and modem subsystems through a CNR card and a CNR connector.

**CODEC (Coder and Decoder)**

Normally, CODEC means a circuit that can do digital to analog conversion and vice versa. It is part of AC'97 sound/modem solution.

**DDR (Double Data Rated) SDRAM**

DDR SDRAM essentially doubles the memory speed of SDRAMs without increasing the clock frequency.

**DIMM (Dual In Line Memory Module)**

DIMM socket is built with a 168-pin assignment and supports 64-bit data. DIMM can be single or double sided. The golden finger signals on each side of the module are different, and that is why it is called Dual In Line. Almost all DIMMs are made with SDRAM now, which operate at 3.3V. Some old DIMMs are made by FPM/EDO and only operate at 5V.

DMA (Direct Memory Access)

Channel for communications between memory and surrounding devices.

ECC (Error Checking and Correction)

The ECC algorithm has the ability to detect double-bit error and automatically correct single-bit error while parity mode can only detect single-bit error.

ECP (Enhanced Communication Port)

ECP is a technology designed to improved I/O for parallel ports.

EPP (Enhanced Parallel Port)

EPP is a standard that supports data transfer rates of up to 500 kps for parallel printers

EDO (Extended Data Output) Memory

Unlike traditional FPM (Fast Page Mode) memory that tri-states the memory output data to start the pre-charge activity, EDO DRAM holds the memory data valid until the next memory access cycle, which is similar to pipeline effect in reducing one clock state.

EEPROM (Electronic Erasable Programmable ROM)

Both EEPROM and Flash ROM can be re-programmed by electronic signals, but the interface technology is different. Size of EEPROM is much smaller than flash ROM. BIOS is now generally stored in EEPROM or Flash ROM.

EPROM (Erasable Programmable ROM)

Traditional mainboard stores BIOS codes in EPROM which can only be erased by ultra-violet (UV) light. If BIOS has to be updated, you need to remove EPROM from mainboard, clear data by UV light, re-program, and then insert it back to socket.

FC-PGA (Flip Chip-Pin Grid Array)

FC means Flip Chip, while FC-PGA is a new package of Intel for Pentium III CPU. It is compatible with SKT370 socket, but requires mainboard to add some signals on socket 370.

Flash ROM

Flash ROM can be re-programmed by electronic signals. It is easier for BIOS to upgrade by a flash utility, but it is also easier to be infected by virus. Because of increase of new functions, BIOS size is increased from 64KB to 256KB (2M bit) or more.

### FSB (Front Side Bus)

FSB is the data channel connecting the Processor to chipset, RAM, mainboard buses, AGP socket etc. Its speed is in terms of MHz and is talked to as FSB clock:

FSB Clock means CPU external bus clock.

CPU internal clock = CPU FSB Clock x CPU Clock Ratio

### IEEE 1394

IEEE 1394 is a low-cost digital transfer interface with transfer rate at 100, 200 or 400 Mbps. It provides solutions of connecting digital television devices and Serial Bus Management. There are two type of IEEE 1394 data transfer: asynchronous and isochronous. Isochronous data channels provide guaranteed data transport at a pre-determined rate. This is especially important for time-critical multimedia data where just-in-time delivery eliminates the need for costly buffering.

### Parity Bit

The parity bit mode of error detection uses 1 parity bit for each byte. Normally it is even parity mode, that is, each time the memory data is updated, parity bit will be adjusted to have even count "1" for each byte. Next time when memory is read with odd number of "1", the parity error is occurred and this is called single bit error detection.

### PC-100 DIMM

SDRAM DIMM that supports 100MHz CPU FSB bus clock.

### PC-133 DIMM

SDRAM DIMM that supports 133MHz CPU FSB bus clock.

### PC-1600 or PC-2100 DDR SDRAM

PC-1600 DDR SDRAM with a 64-bit data bus doubles the data transfer rate of PC100 SDRAM and hence provides data transfer bandwidth up to  $100 \times 64 / 8 \times 2 = 1600 \text{MB/s}$ . PC2100 DDR SDRAM doubles the data transfer rate of PC-133 and hence provides data transfer bandwidth up to  $133 \times 64 / 8 \times 2 = 2100 \text{MB/s}$ .

### PCI (Peripheral Component Interface) Bus

A high speed data channel for the internal connection of peripheral devices and the computer system through a PCI expansion card.

### PnP (Plug and Play)

The PnP specification suggests a standard register interface for both BIOS and operating system (such as Windows 95). These registers are used by BIOS and operating system to configure system resource and prevent any



conflicts. PnP BIOS or operating system will automatically allocate the IRQ/DMA/Memory. Currently, almost all the PCI cards and most ISA cards are already PnP compliant.

**POST (Power-On Self Test)**

The BIOS self-test procedure after power-on. It is generally the first or the second program shown on your monitor screen during system boot.

**RAS (Row Address Strobe)**

RAS is a technology that DRAM writes and reads to the Row addresses, while a CAS (Column Address Strobe) signal is used to validate the column address. The signals are generally sent CAS before RAS. (in Network field, RAS stands for Remote Access Services).

**RDRAM (Rambus DRAM)**

Rambus DRAM is a memory technology that uses large burst mode data transfer of up to 1.6GHz. It is import to know that RDRAM technology helps set up a system level improvement, not just a component upgrade.

**RIMM (Rambus Inline Memory Module)**

RIMM is built with a 184-pin architecture module that supports RDRAM memory technology. A RIMM memory module may contain up to maximum of 16 RDRAM devices.

**SDRAM (Synchronous DRAM)**

SDRAM is one of the Dynamic Random Access Memory (DRAM) technologies that allow DRAM to use the same clock as the CPU host clock (EDO and FPM are asynchronous and do not have clock signal). SDRAM comes in 64-bit 168-pin DIMM and operates at 3.3V.

**SIMM (Single In Line Memory Module)**

SIMM socket is only 72-pin, and is only single side. The golden finger signals on each side of PCB are identical. That is why it is called Single In Line. SIMM is made of FPM or EDO DRAM and supports 32-bit data. SIMM is phased out in current mainboard design.

**SPD (Serial Presence Detect)**

SPD is a small ROM or EEPROM device resided on the DIMM or RIMM. Memory module information such as DRAM timing and chip parameters can be stored into SPD so that BIOS can access it and use it to decide best timing for this DIMM or RIMM.

UART (Universal Asynchronous Receiver/transmitter)

UART is built in a chip that controls the data sent to and received from a serial port. A 16550 UART is now standard in most PCs, and supports modem speed up to 57,600 bps and beyond and direct connect speed of 115,200 bps. Many UARTs have built-in errors in the internal code and just do not work correctly with many external modems. UART is also found as the serial interface on internal modem.

Ultra DMA

Ultra DMA (or, more accurately, Ultra DMA/33) is a protocol for transferring data at 33.3MB/s between a hard disk drive through the computer's data path (or bus) to the computer's random access memory (RAM). The transfer data is twice as fast as the previous Direct Access Memory (DMA) interface. The latest Ultra DMA has advanced to Ultra DMA/66 and Ultra DMA/100.

16.6MB/s x2 = 33MB/s

16.6MB/s x4 = 66MB/s

16.6MB/s x6 = 100MB/s

USB (Universal Serial Bus)

USB is a 4-pin serial peripheral bus that is capable of cascading low/medium speed peripherals (less than 10Mbit/s) such as keyboard, mouse, joystick, scanner, printer and modem.

VCM (Virtual Channel Memory)

NEC's Virtual Channel Memory (VCM) is a new DRAM core architecture that dramatically improves the memory system's ability to service multimedia requirements. VCM increases memory bus efficiency and performance of any DRAM technology by providing a set of fast static registers between the memory core and I/O pins. Using VCM technology results in reduced data access latency and reduced power consumption.

ZIP file

Zip file is a compressed file with a reduced file size.

***MEMO***