

Notice to End Users

This User's Guide & Technical Reference is for assisting system manufacturers and end users in setting up and installing the mainboard.

Every effort has been made to ensure that the information in this manual is accurate. Soltek Computer Inc. is not responsible for printing or clerical errors. **Information in this document is subject to change without notice and does not represent a commitment on the part of Soltek Computer Inc.**

No part of this manual may be reproduced, transmitted, translated into any language in any form or by any means, electronic or mechanical, including photocopying and recording, for any purpose without the express written permission of Soltek Computer Inc.

Companies and products mentioned in this manual are for identification purposes only. Product names appearing in this manual may or may not be registered trademarks or copyrights of their respective companies.

SOLTEK COMPUTER INC. PROVIDES THIS MANUAL "AS IS" WITHOUT WARRANTY OF ANY KIND, EITHER EXPRESS OR IMPLIED, INCLUDING BUT NOT LIMITED TO THE IMPLIED WARRANTIES OR CONDITIONS OF MERCHANTABILITY OR FITNESS FOR A PARTICULAR PURPOSE. IN NO EVENT SHALL SOLTEK COMPUTER INC. BE LIABLE FOR ANY LOSS OR PROFITS, LOSS OF BUSINESS, LOSS OF USE OR DATA, INTERRUPTION OF BUSINESS, OR FOR INDIRECT, SPECIAL, INCIDENTAL, OR CONSEQUENTIAL DAMAGES OF ANY KIND, EVEN IF SOLTEK COMPUTER INC. HAS BEEN ADVISED OF THE POSSIBILITY OF SUCH DAMAGES ARISING FROM ANY DEFECT OR ERROR IN THIS MANUAL OR PRODUCT.

© Copyright 1999 Soltek Computer Inc. All right reserved
Web site: <http://www.soltek.com.tw>
email: support@soltek.com.tw

Edition: March 1999
Version: 1.0
SL-65D SERIALS



Contents

Chapter 1: Introduction	1
Features	1
CPU	1
Chipset	1
L2 Cache	1
Main Memory	1
BIOS	2
Super I/O Function	2
Other Functions	2
Mainboard Layout with Default Settings	3
Chapter 2: Hardware Setup	4
CPU Type Configuration	4
CPU 4.5X Clock Setting	4
Celeron370-300/66MHz	4
CPU 5.0X Clock Setting	4
Celeron370-333/66MHz	4
CPU 5.5X Clock Setting	5
Celeron370-366/66MHz	5
CPU 6.0X Clock Setting	5
Celeron370-400/66MHz	5
System Memory Configuration	5
Jumper Settings	6
JP2/JPA1: Onboard Sound Chip(AC97 Codec)Enabled/Disable.....	6
JFAN:Onboard FAN (12V)Connector	6
JBAT1:Clear CMOS Data.....	6
JP10:Cpower Lost Resume.....	7
SW1:5-6 Bus Clock Select.....	7
SW1: 1-4: Bus Ratio Select	8
Sound Connector.....	8
J7/CD-IN1: CD-ROM Audio Connector.....	8
Game/MIDI port.....	8
Mic:Microphone Jack.....	8
Line in:Audio in Jack.....	8

Line Out:Audio Out Jack-----	8
RT1:Thermal Sensor Cable Connector-----	8
IDE LED Activity Light: (J2 pin1-4)-----	8
Infrared Port Module Connector (J2 pin6-10) -----	9
J2 pin12, 13: PWR Switch-----	9
SLEEP Switch (J2 pin14, 15) -----	9
Speaker Connector (J1 pin1-4) -----	9
Reset Switch (J1 pin5, 6)-----	9
Power LED and Keylock Switch (J1 pin8-12)-----	9
JWOL1: Wake On Lan (WOL) Connector -----	10
Green LED (J1 pin14, 15)-----	10
J2 Switch Signal Summary -----	11
J1 Switch Signal Summary -----	11

Chapter 3: Award BIOS Setup ----- 12

Standard CMOS Setup -----	13
Date (mm:dd:yy) -----	14
Time (hh:mm:ss) -----	14
Primary(Secondary)Master/Slave-----	14
Video -----	14
Halton-----	14
BIOS Features Setup -----	15
Virus Warning-----	16
CPU Internal -----	16
Cache -----	16
External Cache -----	16
Quick Power on self Test -----	16
Boot Sequence -----	17
Swap Floppy Drive -----	17
Boot Up Floppy Seek -----	17
Boot UP Numlock Status-----	17
IDE HDD Block Mode-----	17
Gate A20 Option -----	17
Memory Parity/ECC Check-----	17
Typematic Rate Setting-----	18
Typematic Rate (Chars/Sec) -----	18
Typematic Delay (Msec) -----	18
Security Option-----	18
PCI/VGA palette Snoop-----	18

OS Select for DRAM > 64MB-----	18
Report No FDD-----	18
For WIN95-----	18
Video BIOS Shadow-----	18
C8000-CBFFF to-----	19
DC000-DFFF Shadow-----	19
Chipset Features Setup-----	20
Bank 0/1 2/3 4/5 Dram timing-----	20
<i>SDRAM Cycle</i> -----	21
Memory Hole -----	21
Read Around Write-----	21
Concurrent PCI/HOST-----	21
System BIOS Cacheable-----	21
Video RAM Cacheable-----	22
AGP Aperture Size (MB) -----	22
AGP-2X Mode-----	22
OnChip USB-----	22
USB Keyboard Support-----	22
OnChip Sound -----	22
OnChip Modem-----	23
CPU Host Clock(CPU/PCI)-----	23
<i>Power Management Setup</i> -----	24
ACPI Function-----	24
Power Management -----	24
PM Control by APM-----	24
Video Off Method -----	25
Video Off After-----	25
MODEM Use IRQ -----	25
Soft-Off by PWR-BTTN-----	25
Doze Mode -----	25
Standby Mode-----	26
Suspend Mode-----	26
HDD Power Down -----	26
Modem Ring Resume-----	26
RTC Alarm Resume Wake On LAN -----	26
IRQ (#), NMI; -----	26
Primary IDE 0-----	26
Primary IDE 1; -----	26
Secondary IDE 0-----	26

Secondary IDE 1; -----	26
Floppy Disk; -----	26
Serial Port; -----	27
Parallel Port-----	27
PNP/PCI configuration Setup-----	28
Resources Controlled By-----	29
Reset Configuration Data-----	29
IRQ-x assigned to-----	29
DMA-x assigned to-----	29
Assign IRQ for USB-----	29
Assign IRQ for VGA-----	29
Load Setup Defaults-----	30
CPU SPEED SETTING-----	30
USB Keyboard Support-----	31
Integrated Peripherals-----	31
IDE Primary-----	32
Master/Slave PIO-----	32
IR Function Duplex -----	32
Onboard Parallel Port -----	32
Onboard Parallel Mode-----	33
ECP Mode Use DMA -----	33
Parallel Port EPP Type -----	33
Supervisor/User Password-----	34
IDE HDD Auto Detection -----	35
Save & Exit Setup -----	35
Exit Without Saving -----	35

Chapter 1

Introduction

Features

CPU

1. Supports Celeron 370 CPUs using Socket 370 at 300 ~ 800MHz
2. Supports CPU voltage autodetect circuit
3. Supports 66/100MHz Bus Clock with autodetect (BIOS provides 75/83/103/112 MHz Bus Clock without auto detect)

Chipset

1. VIA 693Apollo Pro-Plus chipset
2. PCI Rev 2.1, 5V, 33MHz interface compliant
3. Supports 66/133 MHz, 3.3V AGP(Accelerated Graphics Port) slot

L2 Cache

1. Celeron 370 supports 128K write back cache with Pipelined Burst SRAMs

Main Memory

1. Memory range from 8MB (minimum) to 768MB(SDRAM) (maximum) with DRAM Table Free configurations
2. Supports SDRAM with 12/10/8ns speed
3. Supports 3 pcs 168pin DIMM sockets (3.3V Unbuffered and 4 clock type)
4. DRAM supports ECC or Parity function

BIOS

1. AWARD Plug and Play BIOS
2. Supports ACPI and legacy APM
3. Flash Memory for easy upgrade

Super I/O Function

1. Integrated USB (Universal Serial Bus) controller with two USB ports.(USB V1-1 and Universal HCI V1.1 Compliant)
2. Supports 2 IDE channels with 4IDE devices (including ZIP/LS-120 devices)
3. **Provides PCI IDE Bus Master function and supports Ultra DMA33 and Ultra DMA66 function**
4. One floppy port
5. Two high speed 16550 FIFO UART ports
6. One parallel port with EPP/ECP/SPP capabilities
7. PS/2 mouse connector
8. Built-in RTC, CMOS, keyboard controller on single I/O chip
9. Peripherals boot function (with ATX power)

Other Functions

1. ATX size 17cm x 30.5cm
2. 4 PCI Master slots, 2 ISA slots, 1 AGP slot and **1 AMR(Audio Modem Riser) Slot**
3. Onboard built-in hardware monitor controller that monitor temperature, fan speed and power supply voltage
4. Provides DIP switch setting
5. Supports 66/100MHz Bus Clock
6. Integrated PCI-master dual full-duplex direct-sound AC97-link-compatible sound system
7. Supports Wake On LAN function
8. Supports Power Lost Resume function
9. BIOS supports 103/112MHz Bus clock.
10. **Onboard bundle with thermal sensor cable**

Mainboard Layout with Default Settings

The default settings of the following figure is for the Celeron370-300/66MHz

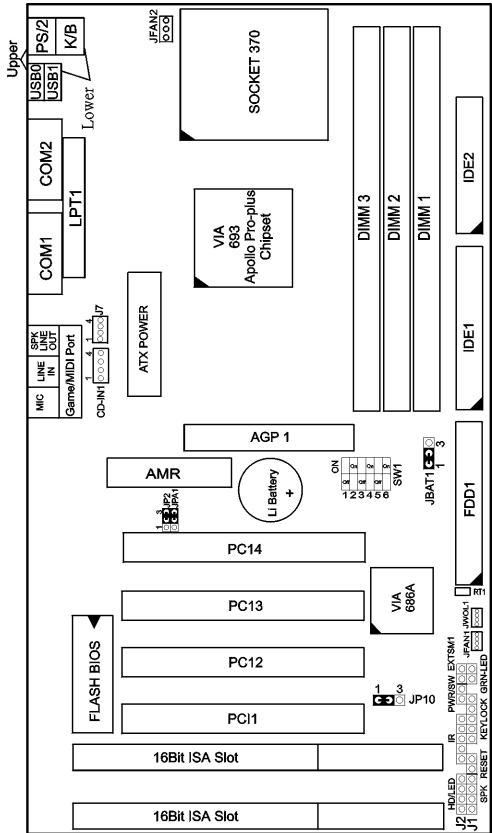

Figure 1-1. Motherboard Layout

Note: For 100MHz CPU environment the SDRAM must comply with PC-100 spec.

Chapter 2

Hardware Setup

CPU Type Configuration

CPU 4.5X Clock Setting Celeron 370-300/66MHz

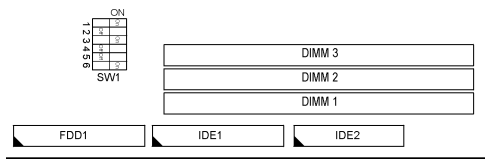

Figure 2-1. CPU Type Configuration

CPU 5.0X Clock Setting Celeron 370-333/66MHz

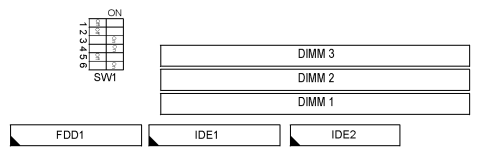

Figure 2-2. CPU Type Configuration

CPU 5.5X Clock Setting

Celeron 370-366/66MHz

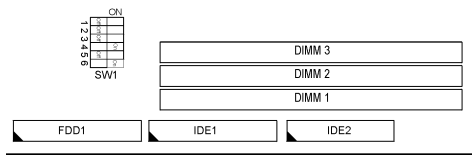

Figure 2-3. CPU Type Configuration

CPU 6.0X Clock Setting

Celeron 370-400/66MHz

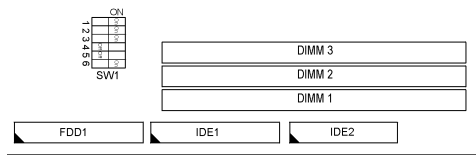

Figure 2-4 CPU Type Configuration

System Memory Configuration



This VIA 693Apollo Pro-Plus motherboard supports 168 pin DIMM of 4MB, 8MB, 16MB, 32MB or 64MB or 128MB to form a memory size between 8MB to 768MB (SDRAM). VIA 693 Apollo Pro-Plus chipsets provide “Table Free” function. It means that users can install DRAM with any configuration and in any bank, and that is why the DRAM table is not needed but do remember that the DRAM must be 3.3V type. **For 100MHz CPU environment, the SDRAM specification must comply with PC-100 spec.**

Jumper Settings

JP2/JPA1: Onboard Sound Chip (AC97 Codec)

Enabled/Disabled

This jumper allows user to control onboard sound chip Function



AC97 Codec	JP2/JPA1
Disabled	
Enabled (default)	

JFAN: Onboard FAN (12V) Connector

FAN#	Function
JFAN1	System FAN
JFAN2	CPU FAN



JBAT1: Clear CMOS Data

Clear the CMOS memory by shorting this jumper Momentarily; then remove the cap to retain new settings.

CMOS Data	JBAT1
Clear Data	
Retain Data (default)	



JP10: Power Lost Resume

This jumper allows you to use the switch of ATX power supply to control on/off switch directly instead of using the power switch on the mainboard.











Power Lost Resume	JP10
Enabled	
Normal(default)	

This feature must work with BIOS. Please refer to the “Power On After PWR-Fail “section on page 29 for description.

SW1: 5-6 Bus Clock Select

Bus Clock	SW:5-6
66MHz	 On
100MHz	 On
Auto Detect (default)	 On

SW1: 1-4: Bus Ratio Select

Bus Ratio	SW: 1~4	Bus Ratio	SW: 1~4	Bus Ratio	SW: 1~4
3.0x		5.0x		7.0x	
3.5x		5.5x		7.5x	
4.0x		6.0x		8.0x	
4.5x		6.5x			

Sound Connector:

J7/CD-IN1: CD-ROM Audio Connector

Connect J7/CD-IN1 to the CD-ROM Audio Connector.

Game/MIDI port

Connect the joystick or MIDI to this connector.

Mic:Microphone Jack

Line in: Audio in Jack

Line Out: Audio out Jack

RT1: Thermal sensor cable connector

IDE LED Activity Light: (J2 pin1-4)

This connector connects to the hard disk activity indicator light on the case.

Infrared Port Module Connector (J2 pin6-10)

The system board provides a 5-pin infrared connector-R1 for an optional wireless transmitting and receiving module. Pin 6 through 10 are Transmit, GND, Receive (low speed), Receive (high speed), and Vcc, respectively.

J2 pin12, 13: PWR Switch

Power Switch: Toggle this pin for turning on/off of the Power supply (for ATX power only).

SLEEP Switch (J2 pin14, 15)

Toggle this jumper forces the system to sleep and the system won't wake up until the hardware event is coming. (The BIOS Power Management setting must be Enabled.)

Speaker Connector (J1 pin1-4)

The speaker connector is a 4-pin connector for connecting the system and the speaker. (See the following drawing for jumper position.)

Reset Switch (J1 pin5, 6)

The system board has a 2-pin connector for rebooting your computer without having to turn off your power switch. This prolongs the life of the system's power supply.

Power LED and Keylock Switch (J1 pin8-12)

The keylock switch is a 5-pin connector for locking the keyboard for security purposes. (See the following drawing for jumper position, and pin1~3 is connected to power LED and pin 4~5 is connected to keylock switch.)

JWOL1:Wake On Lan(WOL)Connector

This connector is designed to use Lan to bootup the system.
Connect the wake on signal from Lan card to this connector.

Green LED (J1 pin14, 15)

Reserved.

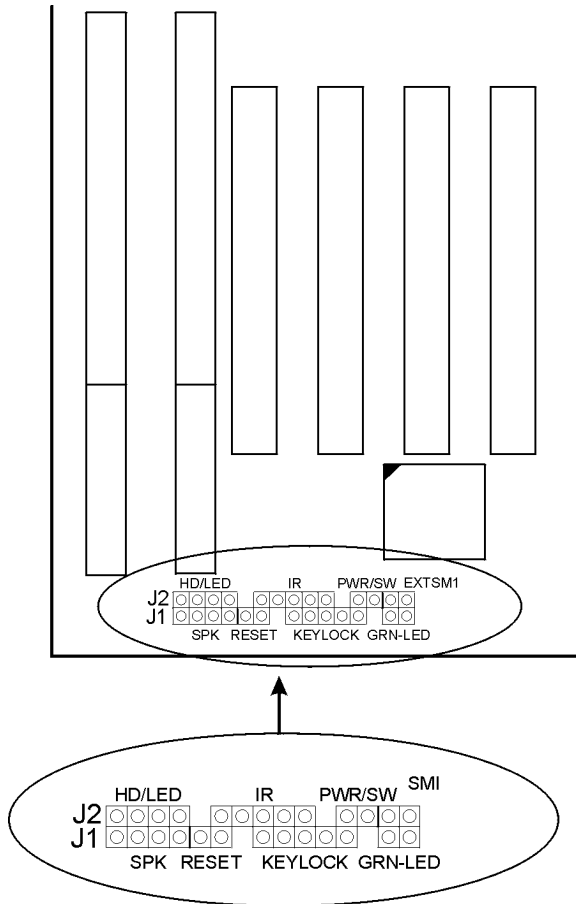

J2 Switch Signal Summary

J2	Pin	Signal Description
HDD LED Connector	1	+5V
	2	HDD LED Signal
	3	HDD LED Signal
	4	+5V
N.C.	5	No Connection
Infrared Connector	6	Infrared Transmit Signal
	7	GND
	8	Infrared Receive Signal (low speed)
	9	Infrared Receive Signal (high speed)
	10	+5V
N.C.	11	No Connection
PWR	12	CND
	13	Power Switch(for ATX Power)
SLEEP	14	GND
	15	Sleep Signal

J1 Switch Signal Summary

J1	Pin	Signal Description
Speaker Connector	1	Speaker Signal
	2	No Connection
	3	Ground
	4	+5V
Reset Switch	5	Reset Signal
	6	Ground
N.C.	7	No Connection
Power LED Connector	8	+5V
	9	No Connection
	10	Ground
Keylock Connector	11	Keylock Signal
	12	GND
N.C.	13	No Connection
Power Saving Connector	14	No Connection
	15	No Connection

Chapter 3

Award BIOS Setup

This 693 Apollo Pro-Plus motherboard comes with the AWARD BIOS from AWARD Software Inc. Enter the Award BIOS program Main Menu by:

1. Turn on or reboot the system.
After a series of diagnostic checks, the following message will appear:

PRESS TO ENTER SETUP

2. Press the key and the main program screen will appear as follows.

```
ROM PCI/ISA BIOS(2A6LGSNC)
CMOS SETUP UTILITY
AWARD SOFTWARE, INC.
```

STANDARD CMOS SETUP	CPU SPEED SETTING
BIOS FEATURES SETUP	INTEGRATED PERIPHERALS
CHIPSET FEATURES SETUP	SUPERVISOR PASSWORD
POWER MANAGEMENT SETUP	USER PASSWORD
PNP/PCI CONFIGURATION	IDE HDD AUTO DETECTION
LOAD SETUP DEFAULTS	SAVE & EXIT SETUP
	EXIT WITHOUT SAVING

Esc : Quit	i :Select Item
F10 : Save & Exit Setup	(Shift) F2 : Change Color

Time, Date, Hard Disk Type...

- Using the arrows on your keyboard, select an option, and press <Enter>. Modify the system parameters to reflect the options installed in your system.
- You may return to the Main Menu anytime by pressing <ESC>.
- In the Main Menu, “SAVE AND EXIT SETUP” saves your changes and reboots the system, and “EXIT WITHOUT SAVING” ignores your changes and exits the program.

Standard CMOS Setup

Standard CMOS Setup allows you to record some basic system hardware configuration and set the system clock and error handling. You only need to modify the configuration values of this option when you change your system hardware configuration or the configuration stored in the CMOS memory gets lost or damaged.

Run the Standard CMOS Setup as follows:

- Choose “STANDARD CMOS SETUP” from the Main Menu and a screen with a list of options will appear.

ROM PCI/ISA BIOS STANDARD CMOS SETUP AWARD SOFTWARE, INC.								
Date (mm:dd:yy) : Thu, May 9 1996								
Time (hh:mm:ss) : 15 : 45 : 10								
HARD DISKS	TYPE	SIZE	CYLS	HEAD	PRECOMP	LANDZ	SECTOR	MODE
Primary Master	: Auto	0	0	0	0	0	0	Auto
Primary Slave	: Auto	0	0	0	0	0	0	Auto
Secondary Master	: Auto	0	0	0	0	0	0	Auto
Secondary Slave	: Auto	0	0	0	0	0	0	Auto
Drive A: 1.44M, 3.5 in.								
Drive B: None								
Video : EGA/VGA								
Halt On : All Errors								
					Base Memory: 640K			
					Extended Memory: 15360K			
					Other Memory: 384K			
					Total Memory: 16384K			
Esc : Quit ↑ ↓ → ← ⌂ Ⓜ Select Item PU/PD/+/- : Modify								
F1 : Help (Shift) F2 : Change Color								

- Use one of the arrow keys to move between options and modify the selected options by using PgUp/PgDn/+/↓ keys.

A short description of the screen options is as follows:

Date (mm:dd:yy) Set the current date and time.
Time (hh:mm:ss)

**Primary
(Secondary)
Master/Slave** This field records the specifications for all non-SCSI hard disk drives installed in your system. Refer to the respective documentation on how to install the drives.

Drive A/B Set this field to the type(s) of floppy disk drive(s) installed in your system. The choices are:
360KB, 5.25 in.,
1.2MB, 5.25 in.,
720KB, 3.5 in.,
1.44M, 3.5 in. (default),
2.88MB, 3.5 in., or None

Video Set this field to the type of video display card installed in the system. The choices are: Monochrome; Color 40x25; VGA/EGA (default); or Color 80x25

Halt On Set this warning feature for the type of errors that will cause the system to halt. The choices are: All Errors (default); No Errors; All, But Keyboard; All, But Diskette; or All, But Disk/Key

3. Press <ESC> to return to the Main Menu when you finish setting up the “Standard CMOS Setup”

BIOS Features Setup

BIOS Features Setup allows you to improve your system performance or set up system features according to your preference.

Run the BIOS Features Setup as follows:

1. Choose “BIOS FEATURES SETUP” from the Main Menu and a screen with a list of options will appear.

ROM PCI/ISA BIOS BIOS FEATURES SETUP AWARD SOFTWARE, INC.			
Virus Warning	: Disabled	Video BIOS Shadow	: Enabled
CPU Internal Cache	: Enabled	C8000-CBFFF Shadow	: Disabled
External Cache	: Enabled	CC000-CFFFF Shadow	: Disabled
CPU L2 Cache ECC Checking	: Enabled	D0000-D3FFF Shadow	: Disabled
Quick Power on Self Test	: Enabled	D4000-D7FFF Shadow	: Disabled
Boot Sequence	: A,C,SCSI	D8000-DBFFF Shadow	: Disabled
Swap Floppy Drive	: Disabled	DC000-DFFFF Shadow	: Disabled
Boot Up Floppy Seek	: Disabled		
Boot Up NumLock Status	: On		
IDE HDD Block MODE	: Enabled		
Gate A20 Option	: Fast		
Memory Parity/ECC Check	: Disabled	ESC :Quit	↑ ↓ ← → Select Item
Typematic Rate Setting	: Disabled	F1 :Help	PU/PD/+/-: Modify
Typematic Rate (Chars/Sec)	: 6	F5 :Old Values(Shift)	F2 : Color
Typematic Delay (Msec)	: 250	F6 :Load BIOS Defaults	
Security Option	: Setup	F7 :Load Setup Defaults	
PCI/VGA Palette Snoop	: Disabled		
OS Select for DRAMs>64MB	: Non-OS/2		
Report No FDD For WIN 95	: No		

2. Use one of the arrow keys to move between options and modify the selected options by using PgUp/PgDn/+/- keys. An explanation of the <F> keys follows:

<F1>: “Help” gives options available for each item.

Shift <F2>: Change color.

<F5>: Get the previous values. These values are the values with which the user started in the current session.

<F6>: Load all options with the BIOS default values.

<F7>: Load all options with the Setup default values.

A short description of screen options follows:

- Virus Warning** Enabled: Activates automatically when the system boots up causing a warning message to appear if there is anything attempting to access the boot sector or hard disk partition table.
Disabled: No warning message will appear when there is something attempting to access the boot sector or hard disk partition table
- Note: Many diagnostic (or boot manager) programs which attempt to access the boot sector table can cause the above warning message. If you will be running such a program, we recommend that you disable the virus protection first.*
- CPU Internal Cache** Choose Enabled (default) or Disabled. This option allows you to enable or disable the CPU's internal cache.
- External Cache** Choose Enabled (default) or Disabled. This option allows you to enable or disable the external cache memory.
- Quick Power On Self Test** Choose Enabled (default) or Disabled. This option allows you to speed up the Power-On Self-Test routine.

- Boot Sequence** Default is “A, C, SCSI” This option determines which drive to look at first for an operating system.
- Swap Floppy Drive** Choose Enabled or Disabled (default). This option swaps floppy drive assignments when it is enabled.
- Boot Up Floppy Seek** Enabled (default): During POST, BIOS checks the track number of the floppy disk drive to see whether it is 40 or 80 tracks.
Disabled: During POST, BIOS will not check the track number of the floppy disk drive.
- Boot Up NumLock Status** Choose On (default) or Off. This option lets user activate the NumLock function at boot-up.
- IDE HDD Block Mode** Choose Enabled (default) or Disabled. If your hard disk size is larger than 540MB, choose Enabled, and, if you are using the IDE HDD Auto Detection option, the BIOS will choose this option automatically.
Note: Some older model HDDs don't provide this feature.
- Gate A20 Option** Choose Normal or Fast (default). This option allows the RAM to access the memory above 1MB by using the fast gate A20 line.
- Memory Parity /ECC Check** Choose Enabled or Disabled

Typematic Rate Setting	Choose Enabled or Disabled (default). Enable this option to adjust the keystroke repeat rate.
Typematic Rate (Chars/Sec)	Range between 6 (default) and 30 characters per second. This option controls the speed of repeating keystrokes.
Typematic Delay (Msec)	Choose 250 (default), 500, 750, and 1000. This option sets the time interval for displaying the first and the second characters.
Security Option	Choose System or Setup (default). This option prevents unauthorized system boot-up or use of BIOS Setup.
PCI/VGA palette Snoop	Choose Enabled or Disabled (default). It determines whether or not the MPEG ISA cards can work with PCI/VGA.
OS Select for DRAM > 64MB	Non-OS2 (default): For Non-OS/2 system. OS: For OS/2 system.
Report No FDD For WIN95	Yes: BIOS reports "NO FDD" to Win95. No (default): BIOS will not report "NO FDD" to Win95.
Video BIOS Shadow	Enabled (default): Map the VGA BIOS to system RAM. Disabled: Will not map the VGA BIOS to system RAM.

C8000-CBFFF to These options are used to shadow

DC000-DFFF other expansion card ROMs.

Shadow

3. Press <ESC> and follow the screen instructions to save or disregard your settings.

Chipset Features Setup

Chipset Features Setup changes the values of the chipset registers. These registers control the system options. Run the Chipset Features Setup as follows:

1. Choose “CHIPSET FEATURES SETUP” from the Main Menu and a screen with a list of options will appear.

ROM PCI/ISA BIOS(2A6LGSNC)
 CHIPSET FEATURES SETUP
 AWARD SOFTWARE, INC.

Bank 0/1 DRAM Timing	: SDRAM 10ns	CPU Host Clock(CPU/PCI):Default
Bank 2/3 DRAM Timing	: SDRAM 10ns	
Bank 4/5 DRAM Timing	: SDRAM 10ns	
SDRAM Cycle Length	: 3	
DRAM Clock	: Host CLK	
Memory Hole	: Disabled	
Read Around write	: Disabled	
Concurrent PCI/Host	: Disabled	
System BIOS Cacheable	: Disabled	
Video RAM Cacheable	: Disabled	
AGP Aperture Size	: 64M	
AGP-2X Mode	: Enabled	
OnChip USB	: Enabled	
USB Keyboard Support	: Disabled	
OnChip Sound	: Enabled	
OnChip Modem	: Disabled	
		ESC: Quit ↑ ↓ → ←: Select Item
		F1 : Help PU/PD/+/-: Modify
		F5 : Old Values (Shift)F2 : Color
		F6 : Load BIOS Defaults
		F7 : Load Setup Defaults

2. Use one of the arrow keys to move between options and modify the selected options by using PgUp/PgDn/+/- keys.

A short description of screen options follows:

Bank 0/1 2/3 4/5

DRAM Timing

This item allows you to select the value in this field, depending on whether the board has paged DRAMs or EDO (extended data output) DRAMs. The Choice: EDO 50ns, EDO 60ns, Slow, Medium, Fast, Turbo.

SDRAM Cycle Length Time

You can select CAS latency time in HCLKs of 2/2 or 3/3. The system board designer should have set the values in this field, depending on the DRAM installed. Do not change the values in this field unless you change specifications of the installed DRAM or the installed CPU.

Memory Hole

Choose Enabled or Disabled (default). In order to improve performance, certain space in memory can be reserved for ISA cards. This memory must be mapped into the memory's space below 16MB.

Read Around Write

DRAM optimization feature: If a memory read is addressed to a location whose latest write is being held in a buffer before being written to memory, the read is satisfied through the buffer contents, and the read is not sent to the DRAM
The Choice: Enabled, Disabled.

Concurrent PCI/HOST

When disabled, CPU bus will be occupied during the entire PCI operation period.
The Choice: Enabled, Disabled

System BIOS Cacheable

Choose Enabled or Disabled (default). When Enabled, the access to the system BIOS ROM addressed at F0000H-FFFFFH is cached.

**Video RAM
Cacheable**

Choose Enabled or Disabled (default). When Enabled, the access to the VGA RAM addressed is cached.

**AGP Aperture Size
(MB)**

Choose 4 , 8, 16, 32, 64 (default), 128, or 256 MB. Memory mapped and graphics data structures can reside in a Graphics Aperture. This area is like a linear buffer. BIOS will automatically report the starting address of this buffer to the O.S.

AGP-2X Mode

this item allows you to enable / disable the AGP-2X (Clock 133MHz) Mode.

OnChip USB

This should be enabled if your system has a USB installed on the system board and you wish to use it. Even when so equipped, if you add a higher performance controller, you will need to disable this feature. The choice: Enabled, Disabled.

**USB Keyboard
Support**

Enabled: Enables function when the USB keyboard is being used.
Disabled: (default) When the AT keyboard is being used.

OnChip Sound

Enabled (default): Turn on AC97 chip Controller
Disabled: Turn off AC97 chip controller or User can external add-on sound card

OnChip Modem Enabled :Turn on MC99 feature
Disabled(default):Disabled
AC97 chip controller or User can external
add-on modem

**CPU Host Clock
(CPU/PCI)** Choose 66/33,75/37,83/41MHz,
100/33,103/34,105/35,110/36,115/38,
124/31,133/33,140/35,112/37,
140/35MHz,124/41,or 133/44MHz

3. Press <ESC> and follow the screen instructions to save or disregard your settings.

Power Management Setup

Power Management Setup sets the system's power saving functions.

1. Choose "POWER MANAGEMENT SETUP" from the Main Menu and a screen with a list of options will appear.

ROM PCI/ISA BIOS (2A6LGSNC)
POWER MANAGEMENT SETUP
AWARD SOFTWARE, INC.

ACPI Function	:Disabled	Primary INTR	: ON
Power Management	:User Define	IRQ3 (COM2)	: Primary
PM Control by APM	:yes	IRQ4 (COM1)	: Primary
Video Off After	:Suspend	IRQ5 (LPT2)	: Primary
Video Off Method	:V/H SYNC+Blank	IRQ6 (Floppy Disk)	: Primary
Modem Use IRQ	:3	IRQ7 (LPT 1)	: Primary
Soft-Off by PWRBTN	:Instant-Off	IRQ8 (RTC Alarm)	: Disabled
HDD Power Down	:Disabled	IRQ9 (IRQ2 Redir)	: Secondary
Doze Mode	:Disabled	IRQ10 (Reserved)	: Secondary
Suspend Mode	:Disabled	IRQ11 (Reserved)	: Secondary
PM Events		IRQ12 (RS/2 Mouse)	: Primary
VGA	:OFF	IRQ13 (Coprocessor)	: Primary
LPT&COM	:LPT/COM	IRQ14 (Hard Disk)	: Primary
HDD&FDD	:ON	IRQ15 (Reserved)	: Disabled
DMA/master	:OFF	ESC : Quit @ ↓ → ← : Select Item	
Modem Ring Resume	:Disabled	F1 : Help PU/PD/+/- : Modify	
RTC Alarm Resume	:Enabled	F5 : Old Values (Shift)F2 : Color	
Date(of Month)	: 0	F6 : Load BIOS Defaults	
Timer(hh:mm:ss)	: 0: 0: 0	F7 : Load Setup Defaults	

2. Use one of the arrow keys to move between options and modify the selected options by using PgUp/PgDn/+/- keys.

A short description of screen options follows:

ACPI Function Enabled: Turn on ACPI Function
Disabled(default):Turn off ACPI Function

Power Management Choose Max. Saving, User Define (default), Disabled, or Min. Saving.

PM Control by APM Choose Yes (default) or No. You need to choose Yes when the operating system has the APM functions, otherwise choose No.

Video Off Method Choose Blank , DPMS, or V/H Sync+Blank (default). You can choose either DPMS or V/H Sync+Blank when the monitor has the Green function. You need to choose Blank when the monitor has neither the Green function.

Video Off After Choose NA, Suspend, Standby (default), or Doze.

MODEM Use IRQ Assign the IRQ number to the modem which is being used so that the ring signal can wakeup the system. The default setting is 3 (COM2).

Soft-Off by PWR-BTTN Instant-off: (default) turns off the system power at once after pushing the power button.
Delay 4 Sec: turns off the system power 4 seconds after pushing the power button (to meet PC97/98 spec.)

Doze Mode This mode sets the CPU speed down to 33MHz.

Standby Mode Suspend Mode	These two options allow you to choose the mode for the different timers. The Standby Mode turns off the VGA monitor, and the Suspend Mode turns off the CPU and saves the energy of the system.
HDD Power Down	Time is adjustable from 1 to 15 minutes. When the set time has elapsed, the BIOS sends a command to the HDD to power down, which turns off the motor.
Modem Ring Resume	An input signal on the serial Ring Indicator (RI) Line (in other words, An incoming call on the modem) Awakens the system from a soft off state
RTC Alarm Resume Wake On LAN	Enabled: Wake up the system from the LAN card (LAN Card must support Wake Up On LAN function And the power supply must provide at least 5V/750ma standby current)
IRQ (#), NMI; Primary IDE 0 Primary IDE 1; Secondary IDE 0 Secondary IDE 1;	Enabled: (default) The system can not enter the power saving mode when I/O ports or IRQ # is activated Disabled: The system still can enter the power saving mode when I/O ports or IRQ# is activated.
Floppy Disk;	

Serial Port;

Parallel Port

Note: These functions can only be activated when the power management option is Enabled

3. Press <ESC> and follow the screen instructions to save or disregard your settings.

PnP/PCI Configuration Setup

PnP/PCI Configuration Setup configures the PCI bus slots.

Run the Chipset Features Setup as follows:

1. Choose “PnP/PCI CONFIGURATION SETUP” from the Main Menu and a screen with a list of options will appear.

ROM PCI/ISA BIOS (2A6LGSNC)
 PNP/PCI CONFIGURATION
 AWARD SOFTWARE, INC.

PNP OS Installed	: No	CPU to PCI Write Buffer	: Enabled
Resources Controlled By	: Auto	PCI Dynamic Bursting	: Enabled
Reset Configuration Data	: Disabled	PCI Master 0 WS Write	: Enabled
IRQ-3 assigned to	: PCI/ISA PnP	PCI Delay Transaction	: Enabled
IRQ-4 assigned to	: PCI/ISA PnP	PCI#2 Access #1 Retry	: Disabled
IRQ-5 assigned to	: PCI/ISA PnP	AGP Master 1 WS Write	: Enabled
IRQ-7 assigned to	: PCI/ISA PnP	AGP Master 1 WS Read	: Disabled
IRQ-9 assigned to	: PCI/ISA PnP	PCI IRQ Activated By	: Level
IRQ-10 assigned to	: PCI/ISA PnP	Assign IRQ For USB	: Enabled
IRQ-11 assigned to	: PCI/ISA PnP	Assign IRQ For VGA	: Enabled
IRQ-12 assigned to	: PCI/ISA PnP		
IRQ-14 assigned to	: PCI/ISA PnP		
IRQ-15 assigned to	: PCI/ISA PnP		
DMA-0 assigned to	: PCI/ISA PnP	ESC : Quit	i ⬆ ⬇ ⬆ ⬆ Select Item
DMA-1 assigned to	: PCI/ISA PnP	F1 : Help	PU/PD/+/- : Modify
DMA-3 assigned to	: PCI/ISA PnP	F5 : Old Values (Shift)	F2 : Color
DMA-5 assigned to	: PCI/ISA PnP	F6 : Load BIOS Defaults	
DMA-6 assigned to	: PCI/ISA PnP	F7 : Load Setup Defaults	
DMA-7 assigned to	: PCI/ISA PnP		

2. Use one of the arrow keys to move between options and modify the selected options by using PgUp/PgDn/+/- keys.

A short description of screen options follows:

PNP OS Installed Yes: OS supports Plug and Play function.
 No (default): OS doesn't support Plug and Play function.

Note: BIOS will automatically disable all PnP resources except the boot device card when you select Yes on Non-PnP OS..

Resources Controlled By Choose Manual (default) or Auto. The BIOS checks the IRQ/DMA channel number on the ISA and PCI card manually if you choose Manual and the IRQ/DMA channel number will be checked automatically if you choose Auto.

Reset Configuration Data Choose Enabled or Disabled (default). Disabled retains PnP configuration data in BIOS and Enabled resets the PnP configuration data in the BIOS.

IRQ-x assigned to DMA-x assigned to Legacy ISA: Manually assigns IRQ/DMA to device.

PCI/ISA PnP: BIOS assigns IRQ/DMA to device automatically.

Assign IRQ for USB Choose Enabled (default) or Disabled.
Enabled: Add one IRQ to USB controller.
Disabled: Remove IRQ from USB controller. The system will have extra IRQ for other devices but the USB controller will still not be disabled (only IRQ was removed.)

Assign IRQ for VGA Choose Enabled (default) or Disabled.
Enabled: Add one IRQ to VGA controller.
Disabled: Remove IRQ from VGA controller. The system will have extra IRQ for other devices but the

VGA controller will still not be disabled (only IRQ will be removed.)

3. Press <ESC> and follow the screen instructions to save or disregard your settings.

Load Setup Defaults

Load Setup Defaults option loads the default system values to the system configuration fields. If the CMOS is corrupted the defaults are loaded automatically. Choose this option and the following message will appear:

"Load Setup Defaults (Y/N)? N"

To use the Setup defaults, change the prompt to "Y" and press <Enter>.

CPU SPEED SETTING

ROM PCI/ISA BIOS(2A6LGSNC)
PNP/PCI CONFIGURATION
AWARD SOFTWARE, INC.

Current cpu Temp.	:33 C / 91 F	
Current System Temp.	:26 C / 78 F	
Current CPUFAN1 Speed	: 3810 RPM	
Current CPUFAN2 Speed	: 0 RPM	
Vcore: 1.96V	2.5V	: 2.46 V
3.3V: 3.36V	5V	: 5.02 V
12V: 12.00V		
		ESC : Quit i F5 F6 Select Item
		F1 : Help PU/PD/+/- : Modify
		F5 : Old Values (Shift)F2 : Color
		F6 : Load BIOS Defaults
		F7 : Load Setup Defaults

- Press <ESC> and follow the screen instructions to save or disregard your settings.

USB Keyboard Support Enabled: Enables function when the USB keyboard is being used.
 Disabled: (default) When the AT keyboard is being used.

Integrated Peripherals

Integrated Peripherals option changes the values of the chipset registers. These registers control system options in the computer.

- Choose “INTEGRATED PERIPHERALS” from the Main Menu and a screen with a list of options will appear.

ROM PCI/ISA BIOS(2A6LGSNC)
 INTEGRATED PERIPHERALS
 AWARD SOFTWARE, INC.

OnChip IDE Channel0	: Enabled	Onboard Parallel Mode	: Normal
OnChip IDE Channel1	: Enabled	Onboard Legacy Audio	: Enabled
IDE Primary Mode PIO	: Enabled	Sound Blaster	: Enabled
Primary Master PIO	: Auto	SB I/O Base Address	: 220H
Secondary Master PIO	: Auto	SB IRQ Select	: IRQ 5
Secondary Slave PIO	: Auto	SB DMA Select	: DMA 1
Primary Master UDMA	: Auto	MPU-401	: Disabled
Primary Slave UDMA	: Auto	MPU-401 I/O Address	: 330-333H
Secondary Master UDMA	: Auto	FM Port (388-38BH)	: Disabled
Secondary Slave UDMA	: Auto	Game Port (200-207H)	: Enabled
Init Display First	: PCI Slot		
Onboard FDC Controller	: Enabled		
Onboard Serial Port 1	: 3F8/IRQ4		
Onboard Serial Port 2	: 2F8/IRQ3		
UART 2 Mode	: HPSIR		
IR Function Duplex	: Half	ESC : Quit	i ⏪ ⏩ ⏴ ⏵ Select Item
TX,RX, inverting enable	: NO,NO	F1	: Help PU/PD/+/- : Modify
Onboard Parallel Port	: 378/IRQ7	F5	: Old Values (Shift)F2: Color
		F6	: Load BIOS Defaults
		F7	: Load Setup Defaults

- Use one of the arrow keys to move between options and modify the selected options by using PgUp/PgDn/+/-; V keys.

A short description of screen options is as follows:

IDE Primary Master/Slave PIO IDE Secondary Master/Slave PIO	Choose Auto (default) or Mode 0~4. The BIOS will detect the HDD Mode type automatically when you choose Auto. You need to set to a lower mode than Auto when your hard disk becomes unstable.
On-Chip Primary/ Secondary PCI IDE	Enabled: (default) Turn on the onboard IDE function. Disabled: Turn off the onboard IDE function.
Onboard FDC Controller	Choose Enabled (default) or Disabled. Choose Disabled when you use an ISA card with FDD function, or , choose Enabled to use the onboard FDD connector.
Onboard Serial Port 1	Choose Auto (default), 3F8/IRQ4, 2F8/IRQ3, 3E8/IRQ4, 2E8/IRQ3, or Disabled. Do not set port 1 & 2 to the same value, except when setting at Disabled.
Onboard Serial Port 2	Choose Auto (default), 3F8/IRQ4 , 2F8/IRQ3, 3E8/IRQ4, 2E8/IRQ3, or Disabled.
UART 2 Mode	Choose Standard (default), HPSIR, or ASKIR.
IR Function Duplex	Choose Half or Full
Onboard Parallel Port	Choose the printer I/O address: 378H/IRQ7 (default), 3BCH/IRQ7, 278H/IRQ5, Disabled

- Onboard Parallel Mode** Choose Normal (default), ECP/EPP EPP, or ECP mode. The mode depends on the external device connected to this port.
- ECP Mode Use DMA** Choose DMA3 (default) or DMA1. Most sound cards use DMA1. Check with your sound card configuration to make sure that there is no conflict with this function.
**: This option will not be displayed unless the EPP/ECP function is selected..*
- Parallel Port EPP Type** Choose EPP1.7 (default) or EPP1.9. EPP1.9 supports hardware handshake. This setting is dependent upon your EPP device.
Note: The above 2 options will not be displayed unless the EPP/ECP function is selected.

3. Press <ESC> and follow the screen instructions to save or disregard your settings.

Supervisor/User Password

These two options allow you to set your system passwords. Normally, the supervisor has a higher ability to change the CMOS setup option than the user. The way to set up the passwords for both Supervisor and User are as follows:

1. Choose “Change Password” in the Main Menu and press <Enter>. The following message appears:

“Enter Password:”

2. The first time you run this option, enter your password up to 8 characters and press <Enter>. The screen does not display the entered characters.

3. After you enter the password, the following message appears prompting you to confirm the password:

“Confirm Password:”

4. Enter the same password “exactly” as you just typed again to confirm the password and press <Enter>.

5. Move the cursor to Save & Exit Setup to save the password.

6. If you need to delete the password you entered before, choose the Supervisor Password and press <Enter>. It will delete the password that you had before.

7. Move the cursor to Save & Exit Setup to save the option you did, otherwise the old password will still be there the next time you turn your machine on.

8. Press <ESC> to exit to the Main Menu.

Note: If you forget or lose the password, the only way to access the system is to clear the CMOS RAM by setting JBAT1. All setup information will be lost and you need to run the BIOS setup program again.

IDE HDD Auto Detection

IDE HDD Auto Detection detects the parameters of an IDE hard disk drive and automatically enters them to the Standard CMOS Setup screen.

The screen will ask you to select a specific hard disk for Primary Master after you select this option. If you accept a hard disk detected by the BIOS, you can enter “Y” to confirm and then press <Enter> to check next hard disk. This function allows you to check four hard disks and you may press the <ESC> after the <Enter> to skip this function and go back to the Main Menu.

Save & Exit Setup

Save & Exit Setup allows you to save all modifications you have specified into the CMOS memory. Highlight this option on the Main Menu and the following message appears:

SAVE to CMOS and EXIT (Y/N)? Y

Press <Enter> key to save the configuration changes.

Exit Without Saving

Exit Without Saving allows you to exit the Setup utility without saving the modifications that you have specified. Highlight this option on the Main Menu and the following message appears:

Quit Without Saving (Y/N)? N

You may change the prompt to “Y” and press the <Enter> key to leave this option.