



This User's Guide & Technical Reference is for assisting system manufacturers and end-users in setting up and installing the mainboard.

Every effort has been made to ensure that the information in this manual is accurate. Soltek Computer Inc. is not responsible for printing or clerical errors. Information in this document is subject to change without notice and does not represent a commitment on the part of Soltek Computer Inc.

No part of this manual may be reproduced, transmitted, translated into any language in any form or by any means, electronic or mechanical, including photocopying and recording, for any purpose without the express written permission of Soltek Computer Inc.

Companies and products mentioned in this manual are for identification purpose only. Product names appearing in this manual may or may not be registered trademarks or copyrights of their respective companies.

Soltek computer inc. Provides this manual "As is " without warranty of any kind, either express or implied, including but not limited to the implied warranties or conditions of merchantability or fitness for a particular purpose. In no event shall Soltek computer inc. Be liable for any loss or profits, loss of business, loss of use or data, interruption of business, or for indirect, special, incidental, or consequential damages of any kind, even if Soltek computer inc. Has been advised of the possibility of such damages arising from any defect or error in this manual or product.

© Copyright 2000 Soltek Computer Inc.  
All rights reserved.

**EDITION : April 2000**  
**VERSION : V3.0**

<http://www.soltek.com.tw>  
e-mail: [support@soltek.com.tw](mailto:support@soltek.com.tw)

# CONTENT

- Chapter 1: Introduction ..... 4**
- 1-1 CPU ..... 4
- 1-2 CHIPSET ..... 4
- 1-3 L2 CACHE ..... 4
- 1-4 MAIN MEMORY ..... 4
- 1-5 BIOS ..... 5
- 1-6 MULTI-I/O FUNCTION ..... 5
- 1-7 AC'97 CODEC FUNCTION ..... 5
- 1-8 MISCELLANOUS ..... 5
- 1-9 MAINBOARD LAYOUT ..... 7
- 1-10 MAINBOARD CHIPSETS DIAGRAM ..... 8
- 1-11 SYSTEM MEMORY CONFIGURATION ..... 8
- ..... 8
- Chapter 2: Hardware Setup ..... 9**
- 2-1 CPU TYPE CONFIGURATION ..... 9
- 2-2 JUMP SETTINGS ..... 12
- 2-3 CONNECTORS ..... 17
- 2-4 DRIVER INSTALLATION ..... 21
- Chapter 3: BIOS Setup ..... 23**
- 3-1: INTRODUCE THE BIOS. .... 23
- 3-2: WHAT IS SETUP ..... 23
- 3-3: HOW TO RUN SETUP ..... 24
- 3-4: WHAT IS THE CMOS ..... 24
- 3-5: WHAT IS POST ..... 24

<b>3-6 CMOS SETUP UTILITY .....</b>	<b>25</b>
<b>3-7 STANDARD CMOS SETUP .....</b>	<b>26</b>
<b>3-8 BIOS FEATURES SETUP .....</b>	<b>28</b>
<b>3-9 CHIPSET FEATURES SETUP .....</b>	<b>32</b>
<b>3-10 POWER MANAGEMENT SETUP .....</b>	<b>36</b>
<b>3-11 PnP / PCI CONFIGURATION SETUP .....</b>	<b>39</b>
<b>3-12 LOAD SETUP DEFAULTS .....</b>	<b>41</b>
<b>3-13 CPU SPEED SETTING .....</b>	<b>42</b>
<b>3-14 INTEGRATED PERIPHERALS .....</b>	<b>43</b>
<b>3-15 SUPERVISOR / USER PASSWORD .....</b>	<b>46</b>
<b>3-16 IDE HDD AUTO DETECTION .....</b>	<b>47</b>
<b>3-17 SAVE &amp; EXIT SETUP .....</b>	<b>47</b>
<b>3-18 EXIT WITHOUT SAVING .....</b>	<b>47</b>

## **Appendix A**

<b>Flash Memory Update Installation .....</b>	<b>48</b>
---	-----------

## **Appendix B**

<b>Driver installation .....</b>	<b>49</b>
----------------------------------	-----------

## **Appendix C**

<b>Thermal sensor .....</b>	<b>51</b>
-----------------------------	-----------

# Chapter 1: Introduction

## 1-1 CPU

- Supports Intel® PPGA Celeron™ 370 CPUs at 233MHz ~ 750MHz.
- Supports Intel® Pentium II®/ Pentium III® Coppermine CPUs using at 400 ~ 1GHz or higher.
- Supports CPU voltage Auto-Detect circuit.

## 1-2 CHIPSET

- VIA 694X chipset (North Bridge) and VIA 686A chipset (South Bridge).
- Supports two 32-bit 3.3V/5V system bus. (one is AGP and the other is PCI)
- Supports 66/100/133MHz CPU external bus speed.
- AGP 3.3V 1x/2x mode, AGP 1.5V 4x mode and PCI 2.1 compliant.
- Concurrent CPU and AGP access.
- Pipelined transfers up to 533MB/sec.
- Windows 95 OSR2 VxD and integrated Windows 98 / Windows 2000 miniport driver support.
- Ultra ATA33/66 Master Mode PCI EIDE controller.
- USB (Universal Serial Bus) connector.
- Sophisticated PC98-compatible Mobile Power Management.

## 1-3 L2 CACHE

- Intel® Celeron™ CPU supports 128K write back cache with Pipelined Burst SDRAMs.
- Intel® Pentium II®/ Pentium III® Coppermine supports 256K/ 512K write back cache with Pipelined Burst SDRAMs.

## 1-4 MAIN MEMORY

- Supports total memory from 8MB to 768MB (SDRAM).
- Supports 3pcs 168pin DIMM sockets. ( 3.3V Unbuffered and 4 Clock type)
- Supports SDRAM with 12ns/10ns/8ns speed.

## 1-5 BIOS

- Award BIOS.
- Supports Plug & Play (PnP).
- FLASH MEMORY for easy upgrade.
- Supports Advanced Power Management (APM) Rev 1.2 function.
- Supports Advanced Configuration Power Management Interface (ACPI) Rev 1.0 function.
- Year 2000 compliant.

## 1-6 MULTI-I/O FUNCTION

- One floppy port supports up to 2.88MB.
- 2x Built-in USB connectors.
- Ultra ATA33/66 bus master IDE supports up to 4 IDE devices. (Including ZIP / LS-120 floppy devices)
- 2x 16550A Built-in fast UART compatible serial port connectors.
- Built-in SPP / EPP / ECP parallel port connectors.
- Built-in standard IrDA TX / RX header.
- Peripherals boot function with ATX power.

## 1-7 AC'97 CODEC FUNCTION

- SoundBlast Pro Hardware and Direct Sound Ready AC'97 Digital Audio Controller.

## 1-8 MISCELLANEOUS

- ATX form factor.
- Mainboard size: 18mm X 30.5mm.
- Provides 5x PCI slots, 1x ISA slot, 1x AMR slot, 1x AGP slot and 3x DIMM sockets.
- AGP 2.0 interface with 1x 2x / 4x data transfer and 2x / 4x fast write capability.
- AGP Universal Connector supports via dual mode buffers.
- Supports SCSI, CD-ROM, ZIP, LS-120 boot up function.
- Supports Wake On LAN (WOL) boot up function.
- Supports BIOS Writing Protection.
- Supports BIOS Core Voltage Setting. (Optional)
- Provides DIP switch for easy setting.

67KV

**NOTE: To use Wake On LAN (WOL) function, the ATX power supply must provide at least 5V/720mA standby current capacity.**

# 1-9 MAINBOARD LAYOUT

- Mainboard default setting: Celeron 300A/66MHz and Pentium II 450/100MHz.

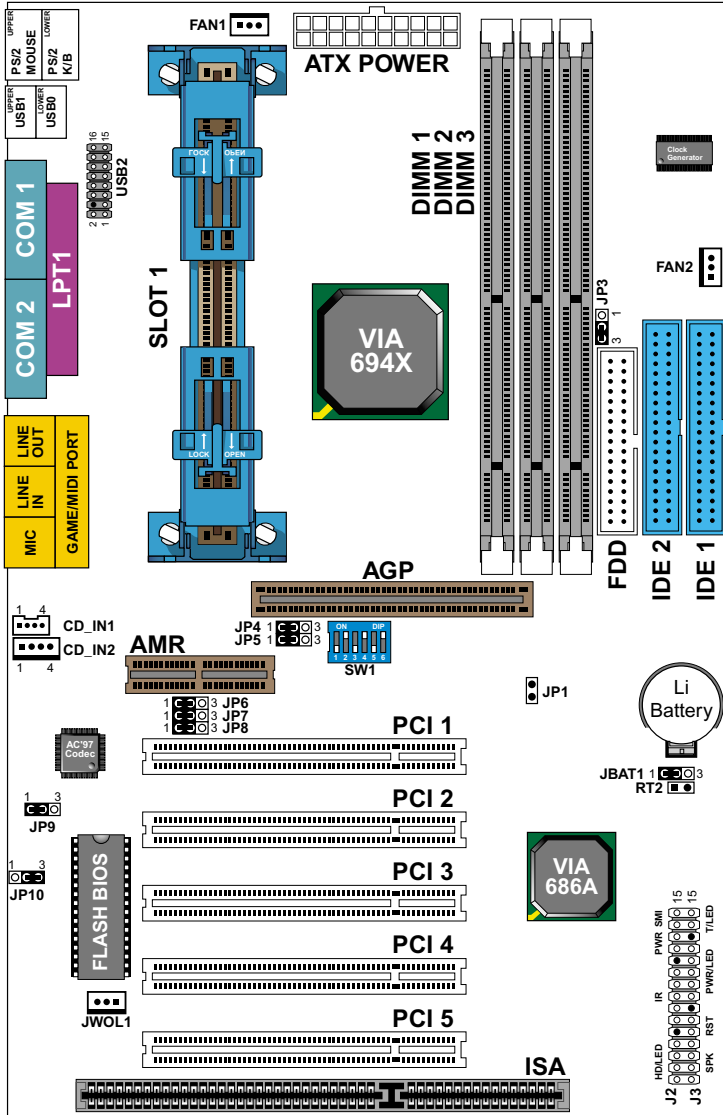

**NOTE:** Under 100MHz / 133MHz FSB, the SDRAM spec must comply with PC-100 / PC-133 spec.

## 1-10 MAINBOARD CHIPSETS DIAGRAM

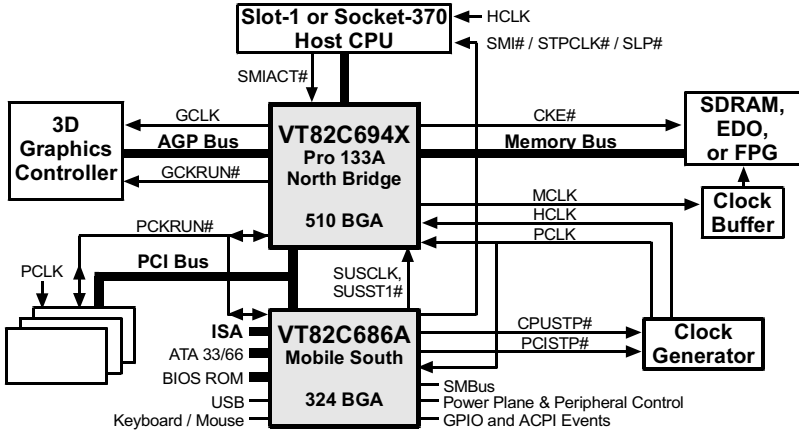

*Apollo Pro 133A system with VT82C686A Mobile South-Bridge.*











## 1-11 SYSTEM MEMORY CONFIGURATION

This VIA VT82C694X motherboard supports 168 pin DIMM of 4MB, 8MB, 16MB, 32MB or 64MB or 128MB to form a memory size between 8MB to 768MB (SDRAM). VIA VT82C694X chipset provide “Table Free” function. It means that users can install DRAM with any configuration and in any bank, and that is why the DRAM table is not needed but do remember that the DRAM must be 3.3V type.



# Chapter 2: Hardware Setup

## 2-1 CPU TYPE CONFIGURATION

Manual DIP switches for diverse CPUs	
ON 	<b>Celeron 233/66 (66MHz * 3.5x)</b> <b>Pentium II 350/100 (100MHz * 3.5x)</b>
ON 	<b>Celeron 266/66 (66MHz * 4.0x)</b> <b>Pentium II 400/100 (100MHz * 4.0x)</b> <b>Pentium III 533B/133 (133MHz * 4.0x)</b> <b>Pentium III 533EB/133 (133MHz * 4.0x)</b>
ON 	<b>Celeron 300/66 (66MHz * 4.5x)</b> <b>Pentium II/III 450/100 (100MHz * 4.5x)</b> <b>Pentium III 600B/133 (133MHz * 4.5x)</b> <b>Pentium III 600EB/133 (133MHz * 4.5x)</b>
ON 	<b>Celeron 333/66 (66MHz * 5.0x)</b> <b>Pentium II/III 500/100 (100MHz * 5.0x)</b> <b>Pentium III 500E/100 (100MHz * 5.0x)</b> <b>Pentium III 667/133 (133MHz * 5.0x)</b> <b>Pentium III 667B/133 (133MHz * 5.0x)</b>
ON 	<b>Celeron 366/66 (66MHz * 5.5x)</b> <b>Pentium II/III 550/100 (100MHz * 5.5x)</b> <b>Pentium III 550E/100 (100MHz * 5.5x)</b> <b>Pentium III 733/133 (133MHz * 5.5x)</b> <b>Pentium III 733B/133 (133MHz * 5.5x)</b>
ON 	<b>Celeron 400/66 (66MHz * 6.0x)</b> <b>Pentium II/III 600/100 (100MHz * 6.0x)</b> <b>Pentium III 600E/100 (100MHz * 6.0x)</b> <b>Pentium III 800EB/133 (133MHz * 6.0x)</b>
ON 	<b>Celeron 433/66 (66MHz * 6.5x)</b> <b>Pentium II 650/100 (100MHz * 6.5x)</b> <b>Pentium III 650/100 (100MHz * 6.5x)</b>
ON 	<b>Celeron 466/66 (66MHz * 7.0x)</b> <b>Pentium III 700/100 (100MHz * 7.0x)</b>
ON 	<b>Celeron 500/66 (66MHz * 7.5x)</b> <b>Pentium III 750/100 (100MHz * 7.5x)</b> <b>Pentium III 1000B/133 (133MHz * 7.5x)</b>
ON 	<b>Celeron 533/66 (66MHz * 8.0x)</b> <b>Pentium III 800/100 (100MHz * 8.0x)</b>

■ SW1 DIP1 ~ DIP4: BUS RATIO SELECT

SW1 DIP1 ~ DIP4 SETTING					
3.0x	ON		3.5x	ON	
	ON			ON	
5.0x	ON		5.5x	ON	
6.0x	ON		6.5x	ON	
7.0x	ON		7.5x	ON	
8.0x	ON				

■ SW1 DIP5 ~ DIP6: BUS CLOCK SELECT

SW1 DIP5 ~ DIP6	JP3: FSB Select
66/100/133MHz Auto Select (default)	
100MHz	
133MHz	

**WATCH OUT !!!**

1. Please refer to your processor installation or other documentation attached with your CPU for detailed installing instruction.
2. Installing a heat sink and cooling fan is necessary for proper heat dissipation from your CPU. Uncorrected installation may result in overheating and damage of your CPU.
3. Before changing the setting of CPU Vcore from BIOS program, user **SHOULD** make sure of correct specification both of CPU CLOCK and RATIO. Uncorrected setting may cause damage to your CPU.

## 2-2 JUMP SETTINGS





### ■ FAN#: Onboard FAN (12V) Connector

FAN#	FUNCTION
FAN1	CPU FAN
FAN2	SYSTEM FAN





### JP1: Factory Test

This jumper is only for factory test.





### ■ JP4 / JP5: USB Port Select (1)

USB Port	JP4 / JP5
Redirect USB port2 to USB2 connector (default)	JP4  JP5 
Redirect USB port2 to AGP	JP4  JP5 

### ■ JP6 / JP9: Onboard Sound Chip (AC'97 Codec) Select



AC'97 Codec Status	JP6 / JP9
Disabled	JP6  JP9 
Enabled (default)	JP6  JP9 

### ■ JP7 / JP8: USB Port Select (2)

USB Port	JP7 / JP8
Redirect USB port3 to USB2 connector (default)	JP7  JP8 
Redirect USB port3 to AMR port	JP7  JP8 

### ■ JP10: Power Lost Resume



This jumper allows user to use the switch of ATX power supply to control ON/OFF switch directly instead of using the power switch on the motherboard.

Power Lost Resume	JP10
Enabled	
Normal (default)	

**NOTE:** This feature must work with BIOS. Please refer to the BIOS “Power On After PWR-Fail” sector.

### ■ JBAT1: Clear CMOS data

Clear the CMOS memory by shorting this jumper 2 & 3 momentarily, and then remove the cap back to 1 & 2 to retain original CMOS setting.

JBAT1	JBAT1
Clear CMOS Data	
Retain Data (default)	

### ■ RT2: Thermal Sensor Connector

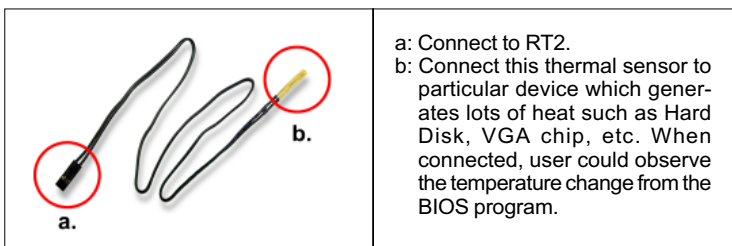

■ **CD1/CD2: CD-ROM Audio Connector**

PIN #	CD_IN1	CD_IN2
PIN 1	GND	Left Channel
PIN 2	Left Channel	GND
PIN 3	GND	GND
PIN 4	Right Channel	Right Channel

■ **GAME/MIDI Port:**

Connect joystick or MIDI to this connector.

■ **MIC :Microphone Jack**

Connect to microphone device.

■ **LINE IN: Audio In Jack**

Connect audio line in.

■ **LINE OUT/SPEAKER OUT: Audio Out Jack**

Connect audio line out or speaker out.

■ **JWOL1: Wake On LAN (WOL) Connector**

This connector is designed to boot up system via LAN. Connect the wake on signal form the LAN card to this connector.

**\*\*\*For support WOL, the ATX power supply has to have at least 5V/720mA standby current.\*\*\***

<b>J2</b>	<b>PIN</b>	<b>SIGNAL DESCRIPTION</b>
<b>HDD LED CONNECTOR</b>	<b>1</b>	<b>+5V</b>
	<b>2</b>	<b>HDD LED SIGNAL</b>
	<b>3</b>	<b>HDD LED SIGNAL</b>
	<b>4</b>	<b>+5V</b>
<b>N.C.</b>	<b>5</b>	<b>NONE</b>
<b>INFRARED CONNECTOR</b>	<b>6</b>	<b>INFRARED TRANSMIT SIGNAL</b>
	<b>7</b>	<b>GND</b>
	<b>8</b>	<b>INFRARED TRANSMIT SIGNAL (LOW SPEED)</b>
	<b>9</b>	<b>NONE</b>
	<b>10</b>	<b>+5V</b>
<b>N.C.</b>	<b>11</b>	<b>NONE</b>
<b>ATX POWER SWITCH</b>	<b>12</b>	<b>ATX POWER SWITCH</b>
	<b>13</b>	<b>GND</b>
<b>N.C.</b>	<b>14</b>	<b>N.C.</b>
	<b>15</b>	<b>N.C.</b>

**PIN1~PIN4: HDD DISK LED CONNECTOR**

Connect cable from the chassis's "H.D.D" to this connector.

**PIN6~PIN10: IR (INFRARED) CONNECTOR**

Connect cable from the chassis's "IR" to this connector.

**PIN12~PIN13: ATX POWER SWITCH CONNECTOR**

Connect cable from the chassis's "POWER" to this connector.

<b>J3</b>	<b>PIN</b>	<b>SIGNAL DESCRIPTION</b>
<b>SPEAKER CONNECTOR</b>	<b>1</b>	<b>SPEAKER SIGNAL</b>
	<b>2</b>	<b>NO CONNECTION</b>
	<b>3</b>	<b>GND</b>
	<b>4</b>	<b>+5V</b>
<b>RESET SWITCH</b>	<b>5</b>	<b>RESET SIGNAL</b>
	<b>6</b>	<b>GND</b>
<b>N.C.</b>	<b>7</b>	<b>NONE</b>
<b>POWER LED CONNECTOR</b>	<b>8</b>	<b>+5V</b>
	<b>9</b>	<b>NO CONNECTION</b>
	<b>10</b>	<b>GND</b>
<b>N.C.</b>	<b>11</b>	<b>NONE</b>
	<b>12</b>	<b>NONE</b>
	<b>13</b>	<b>NONE</b>
<b>SUSPEND LED</b>	<b>14</b>	<b>SUSPEND LED</b>
	<b>15</b>	<b>GND</b>

**PIN1~PIN4: SPEAKER CONNECTOR**

Connect cable from the chassis's "SPEAKER" to this connector.

**PIN5~PIN6: RESET SWITCH**

Connect cable from the chassis's "RESET" to this connector. User can use this function to make a hardware re-boot. Press and hold this switch at least one second to re-boot.

**PIN8~PIN10: POWER LED CONNECTOR**

Connect to Power LED.

**PIN14~PIN15: SUSPEND LED CONNECTOR**

Connect to Suspend LED.



## 2-3 CONNECTORS

J2, J3:

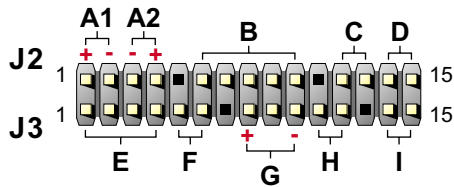

- |                    |                   |
|--------------------|-------------------|
| A1 : 1st HDD LED   | A2 : 2nd HDD LED  |
| B. : INFRARED (IR) | C. : POWER SWITCH |
| D. : NONE          | E. : SPEAKER      |
| F. : RESET SWITCH  | G. : POWER LED    |
| H. : NONE          | I. : SUSPEND LED  |

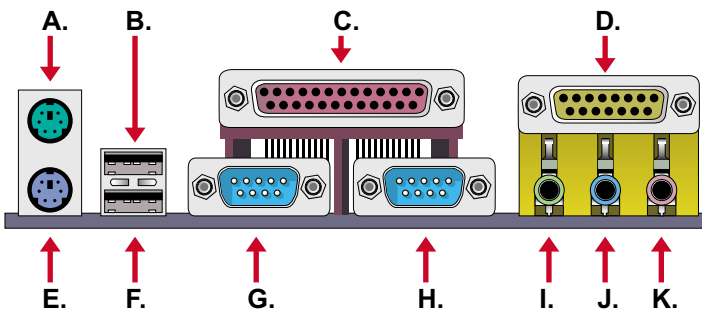

- |                    |                     |
|--------------------|---------------------|
| A. : PS/2 MOUSE    | B. : USB 0          |
| C. : LPT1 PORT     | D. : GAME/MIDI PORT |
| E. : PS/2 KEYBOARD | F. : USB 1          |
| G. : COM1          | H. : COM2           |
| I. : LINE/SPK OUT  | J. : LINE IN        |
| K. : MIC           |                     |

## ATX POWER SUPPLY CONNECTOR

---

- This connector connects to an ATX power supply. The plug from the power supply only inserts in an orientation because of the different hole sizes. Find the proper orientation and push down firmly making sure that all pins are aligned.
- Reminding that your power supply should support at least 10mA on the 5V standby voltage. It may cause an difficulty to power on the system if the power supply can't support the load.
- **For Wake On LAN function, the power supply should support at least 720mA current.**

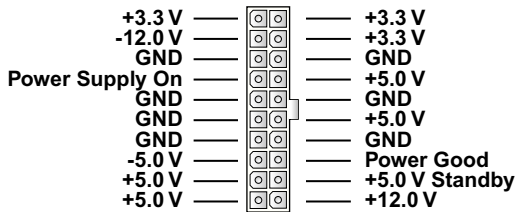

## PS/2 Mouse and PS/2 Keyboard

---

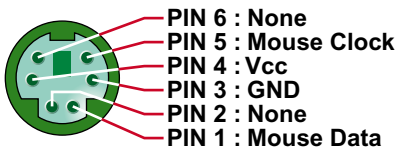

**PS/2 MOUSE**

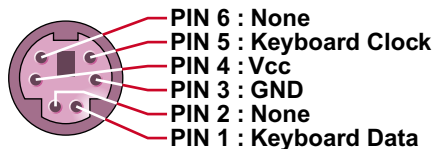

**PS/2 KEYBOARD**

## IRQ DESCRIPTION

---

- The following table lists the default assignments for standard PC devices. Use this table when configuring your system and resolving IRQ conflicts.

IRQ	Function Description	Priority
IRQ 0	System Timer	1
IRQ 1	Keyboard Controller	2
IRQ 2	Programmable Interrupt	N/A
IRQ 3	Serial Port (COM 2)	11
IRQ 4	Serial Port (COM 1)	12
IRQ 5		13
IRQ 6	Floppy Disk Controller	14
IRQ 7	Parallel Port (LPT1)	15
IRQ 8	Real Time Clock (RTC)	3
IRQ 9		4
IRQ 10		5
IRQ 11		6
IRQ 12	PS/2 Mouse Port	7
IRQ 13	Coprocessor	8
IRQ 14	Primary IDE Channel	9
IRQ 15	Secondary IDE Channel	10

- Both ISA and PCI expansion cards may require IRQs. System IRQs are available to cards installed in the ISA expansion bus first, then any remaining IRQs are available to PCI cards. Currently, there are two types of ISA cards.
- The original ISA expansion card design, now referred to as “Legacy” ISA cards, requires that you configurate the card’s jumpers manually and then install it in any available slot on the ISA bus. To see a map of your used and free IRQs in Windows98, the **Control Panel** icon in **My Computer**, contains a **System** icon, which gives you a **Device Manager**

## 2nd USB CONNECTOR

---

- This motherboard provides 4 sets of USB connector. Besides 2 sets of them can be connected directly by USB device, the others are built onboard for user to extend the use.

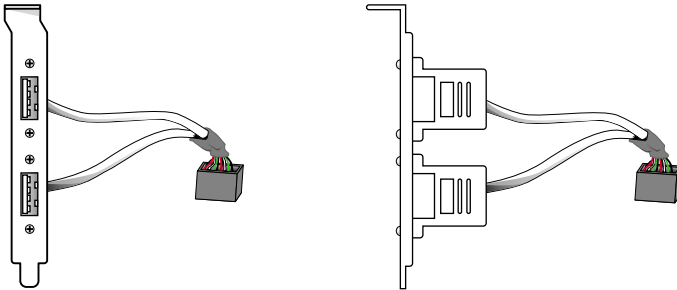

2nd USB Connector (Optional)

---

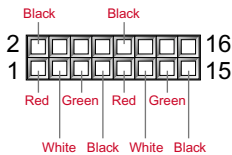

**USB 2**

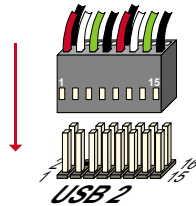

- When plugs the 2nd USB connector to USB2 port, user can see every color of wires to determine which is the first pin.

PIN	SIGNAL	PIN	SIGNAL
PIN 1	Vcc (Red)	PIN 2	GND (Black)
PIN 3	DO- (White)	PIN 4	N/A
PIN 5	DO+ (Green)	PIN 6	N/A
PIN 7	GND (Black)	PIN 8	N/A
PIN 9	Vcc (Red)	PIN 10	GND (Black)
PIN 11	D1- (White)	PIN 12	N/A
PIN 13	D1+ (Green)	PIN 14	N/A
PIN 15	GND (Black)	PIN 16	N/A

## 2-4 DRIVER INSTALLATION

Onboard AC'97 Audio Codec Controller Driver Installation for Windows95 / Windows98:

---

1. Go to CD-ROM driver, we suggest the CD-ROM title is D:\.
2. Find and run **D:\DRIVER\AUDIO\VIA AC97\SETUP.EXE**
3. Then the setup program will detect your O.S. to install relative files into your system.
4. Reboot your computer.

**NOTE 1: IF USER WANTS TO USE EXTERNAL SOUND CARD, USER MUST RUN BIOS PROGRAM TO DISABLE "Onchip Sound" option in the "Chipset Feature Setup" and "Onboard Legacy Audio" option in the "Integrated Peripherals".**

**NOTE 2: UNDER WINDOWS95, USER MUST INSTALL Direct X FOR AGP ENVIRONMENT.**

**NOTE 3: User can also install 4in1 Driver from CD instead of the following drivers. (For avoid CD-ROM compalibility issue, user can ignore the IDE driver)**

### **PART 1:**

1. Put the CD into your CD-ROM.
2. There appears a welcome window.  
(If doesn't, it means that your CD-ROM auto-run function does not enable, but you still can browser the CD via Windows Explorer and change the directory to where your CD-ROM directory is. Then run the **autorun.exe**)
3. Select "**Install Driver**".
4. Select "**Install VIA Chipsets Driver**".
5. Select "**Install 4in1 Driver**".
6. Then the program will automatically setup all drivers your system needs.
7. Finally, the system will re-boot.

**NOTE: AFTER INSTALLED "4in1 Driver", USER DOESN'T NEED TO INSTALL ANY OTHER PROGRAM IN PART 2.**

## **PART 2:**

### VIA Patch Code Installation

---

Windows95 / Windows98:

1. Go to CD-ROM driver, we suggest the CD-ROM title is **D:\**.
2. Find and run **D:\Patch\Via\patch9x\Setup\Setup.exe**
3. Select "Install VIA Chipset Functions' Registry", then it will automatically install this program.

**NOTE: This program should be installed before any other VIA's drivers.**

### VIA AGP VxD Driver for Windows9x Installation

---

Windows95 / Windows98:

1. Go to CD-ROM driver, we suggest the CD-ROM title is **D:\**.
2. Find and run **D:\Driver\Via\Agp\Setup\Setup.exe**
3. Select "Install VIA AGP VxD in turbo mode" or "Install VIA AGP VxD normal mode", then it will automatically install this program.

### VIA PCI IRQ Routing Miniport for Windows9x Installation

---

Windows95 / Windows98:

1. Go to CD-ROM driver, we suggest the CD-ROM title is **D:\**.
2. Find and run **D:\Patch\Via\Virq9x\Setup.exe**

**NOTE: Before install Windows98, user must enable two functions for this miniport driver in the BIOS menu, one is "OnChip USB" in the "Chipset Features Setup" and another is "Assign IRQ for USB" in the "PnP/PCI Configuration Setup".**

## Chapter 3: BIOS Setup

### 3-1: INTRODUCE THE BIOS.

**B**IOS stands for Basic Input Output System. It is sometimes called the ROM BIOS because it is stored in a Read-Only Memory (ROM) chip on the motherboard. BIOS is the first program to run when you turn on your computer. It performs the following functions:

- initializing and testing hardware in your computer (a process called “POST”, for Power On Self Test)
- loading and running your operating system.
- managing SETUP for making changes in your computer.
- helping your operating system and application programs to manage your PC hardware by means of a set of routines called BIOS Run-Time Services.

### 3-2: WHAT IS SETUP

**S**ETUP is an interactive BIOS program that you need to run when:

- Changing the hardware on your system. (for example: installing a new Hard Disk, etc.)
- Modifying the behavior of your computer. (for example: changing the system time or date, or turning special features on or off, etc.)
- Enhancing your computer’s behavior. (for example: speeding up performance by turning on shadowing or caching.)

### 3-3: HOW TO RUN SETUP

One way of running SETUP is to press a special function key or key combination during POST, before the operating system is loaded. During POST, the BIOS usually displays a prompt such as:

Press DEL to enter SETUP

### 3-4: WHAT IS THE CMOS

CMOS is a special kind of memory maintained by a battery after you turn your computer off. The BIOS uses CMOS to store the settings you selected in SETUP. The CMOS also maintains the internal clock. Every time you turn on your computer, the BIOS looks in CMOS for the settings you selected and configures your computer accordingly. If the battery charge runs too low, the CMOS content will be lost and POST will issue a "CMOS invalid" or "CMOS checksum invalid" message. If this happens, you may have to replace the battery. After the battery is replaced, the proper settings will need to be stored in SETUP.

### 3-5: WHAT IS POST

POST is an acronym for Power On Self Test. It is a traditional name for the routines that the BIOS uses to test and initializes the devices on your system when the PC is powered on. Its meanings has grown to include anything the BIOS does before the operating system is started.

Each of POST routines is assigned a POST code, an unique number which is sent to I/O port 080h before the routine is executed.



### 3-6 CMOS SETUP UTILITY

This VIA 694x chipset mainboard comes with the AWARD BIOS from AWARD Software Inc. Enter the BIOS program main menu by:

Turn on the computer, after a series of diagnostic checks, the following message will appear:

PRESS <Del> TO ENTER SETUP

Press <Del> and the main program screen will appear as follows:

ROM PCI/ISA BIOS (2A6LJSN9)  
CMOS SETUP UTILITY  
AWARD SOFTWARE, INC.

STANDARD CMOS SETUP	CPU SPEED SETTING
BIOS FEATURES SETUP	INTEGRATED PERIPHERALS
CHIPSET FEATURES SETUP	SUPERVISOR PASSWORD
POWER MANAGEMENT SETUP	USER PASSWORD
PNP/PCI CONFIGURATION	IDE HDD AUTO DETECTION
LOAD SETUP DEFAULTS	SAVE & EXIT SETUP
	EXIT WITHOUT SAVING
Esc : Quit	↑↓→← : Select Item
F10 : Save & Exit Setup	(Shift)F2 : Change Color
Time, Date, Hard Disk Type...	

### 3-7 STANDARD CMOS SETUP

Standard CMOS Setup allows you to record some basic system hardware configuration and set the system clock and error handling. You only need to modify the configuration values of this option when you change your system hardware configuration or the configuration stored in the CMOS memory gets lost or damaged.

Run the Standard CMOS Setup as follows:

1. Choose "STANDARD CMOS SETUP" from the Main Menu and a screen with a list of options will appear.
2. Use one of the arrow keys to move between options and modify the selected options by using PgUp/PgDn/+/- keys.

ROM PCI/ISA BIOS (2A6LJSN9)  
STANDARD CMOS SETUP  
AWARD SOFTWARE, INC.

Date (mm:dd:yy) : Tue, Oct 19 1999							
Time (hh:mm:ss) : 15 : 4 : 24							
HARD DISKS	TYPE	SIZE	CYLS	HEAD	PRECOMP	LANDZ	SECTOR MODE
Primary Master	: Auto	OM	0	0	0	0	0 AUTO
Primary Slave	: Auto	OM	0	0	0	0	0 AUTO
Secondary Master	: Auto	OM	0	0	0	0	0 AUTO
Secondary Slave	: Auto	OM	0	0	0	0	0 AUTO
Drive A : 1.44, 3.5 in.							
Drive B : None							
Video : EGA/VGA							
Halt On : All Errors							
Base Memory: 640K Extended Memory: 64512K Other Memory: 384K <hr style="width: 20%; margin: 0 auto;"/> Total Memory: 65536K							
Esc : Quit		↑ ↓ → ← : Select Item			PU/PD/+/- : Modify		
F1 : Help		(Shift)F2 : Change Color					

---

<b>Date (mm:dd:yy)</b>	Set the current date and time.
<b>Primary (Secondary)</b>	This field records the specification for all non-SCSI Hard Disk Drives installed in your system. Refer to the respective documentation on how to install the drives.
<b>Drive A / B</b>	Set the field to the type(s) of Floppy Disk drive(s) installed in your system. The choice: 360KB, 5.25in. 1.2MB, 5.25in. 720KB, 3.5in. 1.44MB, 3.5in. 2.88MB, 3.5in.
<b>Video</b>	Set the field to the type of video display card installed in your system. The choice: Monochrome, Color 40x25, EGA / VGA, (default) Color 80x25
<b>Halt On</b>	Set this warning feature for the type of errors that will cause the system to halt. The choice: All Errors, (defaults) No Errors, All But Keyboard, All But Diskette, All But Disk / Key

---

3. Press <ESC> and follow the screen instructions to save or disregard your setting.

### 3-8 BIOS FEATURES SETUP

**B**IOS Features Setup allows you to improve your system performance or set up system features according to your preference.

Run the BIOS Features Setup as follows:

1. Choose "BIOS FEATURES SETUP" from the Main Menu and a screen with a list of options will appear.
2. Use one of the arrow keys to move between options and modify the selected options by using PgUp/PgDn/+/- keys.

ROM PCI/ISA BIOS (2A6LJSN9)  
 BIOS FEATURES SETUP  
 AWARD SOFTWARE, INC.

Virus Warning : Disabled CPU Internal Cache : Enabled External Cache : Enabled CPU L2 Cache ECC Checking : Enabled  Quick Power On Self Test : Enabled Boot Sequence : A, C, SCSI Swap Floppy Drive : Disabled Boot Up Floppy Seek : Disabled Boot Up NumLock Status : On IDE HDD Block Mode : Enabled Gate A20 Option : Fast Memory Parity/ECC Check : Disabled Typematic Rate Setting : Disabled Typematic Rate (Chars/Sec) : 6 Typematic Delay (Msec) : 250 Security Option : Setup PCI/VGA Palette Snoop : Disabled OS Select For DRAM > 64MB : Non-OS2	Video BIOS Shadow : Enabled C8000-CBFFF Shadow : Disabled CC000-CFFFF Shadow : Disabled D0000-D3FFF Shadow : Disabled D4000-D7FFF Shadow : Disabled D8000-DBFFF Shadow : Disabled DC000-DFFFF Shadow : Disabled  ESC : Quit      ↑↓→← : Select Item F1 : Help      PU/PD/+/- : Modify F5 : Old Value    (Shift)F2 : Color F7 : Load Setup Defaults
---	---

---

<b>Virus Warning</b>	<p>Enabled: Activates automatically when the system boots up causing a warning message to appear if there is anything attempting to access the boot sector or Hard Disk partition table.</p> <p>Disabled: No warning message will appear when there is something attempting to access the boot sector or Hard Disk partition table.</p>
	<div style="border: 1px solid black; padding: 5px;"><p><b><i>Note: Many diagnostic (or boot manager) programs which attempt to access the boot sector table can cause the above warning message. If you will be running such a program, we recommend that you disable the</i></b></p></div>
<b>CPU Internal Cache</b>	<p>Choose Enabled (default) or Disabled. This option allows user to enable or disable the CPU internal cache.</p>
<b>External Cache</b>	<p>Choose Enabled (default) or Disabled. This option allows user to enable or disable the external cache memory.</p>
<b>Quick Power On Self</b>	<p>Choose Enabled (default) or Disabled. This option allows user to speed up the Power-On-Self-Test routine.</p>
<b>Boot Sequence</b>	<p>Default is "A , C, SCSI". This option determines which drive to boot at first for an operating system.</p>
<b>Swap Floppy Drive</b>	<p>Default is "A, C, SCSI". This option determines which drive to boot at first for an operating system.</p>
<b>Boot Up Floppy Seek</b>	<p>Enabled (default): During POST, BIOS checks the track number for Floppy Disk drive to see whether it's 40 or 80 tracks.</p> <p>Disabled: During POST, BIOS will not check the track number for Floppy Disk drive.</p>
<b>Boot Up NumLock</b>	<p>On (default): Activate the NumLock function at boot up.</p> <p>Off: Close the NumLock function at boot up.</p>

<b>IDE HDD Block Mode</b>	Choose Enabled (default) or Disabled. If your Hard Disk size is larger than 540MB, choose Enabled, and if you are using the IDE HDD Auto Detection option, the BIOS will choose this option automatically.
	<b>Note: Some older model Hard Disk drives do not provide</b>
<b>Gate A20 Option</b>	Choose Normal or Fast (default): This option allows the RAM to access the memory above 1MB by using the fast gate A20 line.
<b>Memory Parity / ECC</b>	Choose Enabled or Disabled.
<b>Typematic Rate Setting</b>	Choose Enabled or Disabled (default): Enable this option to adjust the deystroke repeat rate.
<b>Typematic Rate</b>	Range between 6 (default) and 30 characters per second. This option controls the speed of repeating keystrokes.
<b>Typematic Delay (Msec)</b>	Choose 250 (default), 500, 750 and 1000. This option sets the time interval for displaying the first and the second characters.
<b>Security Option</b>	Choose System or Setup (default). This option prevents unauthorized system boot up or use of BIOS Setup.
<b>PCI / VGA Palette</b>	Choose Enabled or Disabled (default). It determines whether or not the MPEG ISA cards can work with PCI / AGP.
<b>OS Select for DRAM &gt;</b>	Non-OS2 (default): For Non-OS/2 operating system. OS: For OS/2 operating system.
<b>Report No FDD For</b>	Yes: BIOS reports "NO FDD" to Win95. No (default): BIOS will not report "NO FDD" to Win95.

---

**C8000-CBFFF to DC000-** These options are used to shadow other expansion card ROMs.

3. Press <ESC> and follow the screen instructions to save or disregard your setting.

### 3-9 CHIPSET FEATURES SETUP

**C**hipset Features Setup changes the values of the chipset registers. These registers control the system options.

Run the Chipset Features Setup as follows:

1. Choose "CHIPSET FEATURES SETUP" from the Main Menu and a screen with a list of options will appear.
2. Use one of the arrow keys to move between options and modify the selected options by using PgUp/PgDn/+/- keys.

ROM PCI/ISA BIOS (2A6LJSN9)  
 CHIPSET FEATURES SETUP  
 AWARD SOFTWARE, INC.

Bank 0/1 DRAM Timing : SDRAM 10ns Bank 2/3 DRAM Timing : SDRAM 10ns Bank 4/5 DRAM Timing : SDRAM 10ns SDRAM Cycle Length : 3 DRAM Clock : Host CLK Memory Hole : Disabled P2C/C2P Concurrency : Enabled Fast R-W Turn Around : Disabled System BIOS Cacheable : Disabled Video RAM Cacheable : Disabled AGP Aperture Size : 64M AGP-4X Mode : Disabled OnChip USB 1 : Enabled OnChip USB 2 : Enabled USB Keyboard Support : Disabled OnChip Sound : Enabled OnChip Modem : Disabled	CPU Host Clock (CPU/PCI) : Default CPU Vcore Select : Default       ESC : Quit      ↑↓→← : Select Item F1 : Help      PU/PD/+/- : Modify F5 : Old Value (Shift)F2 : Color F7 : Load Setup Defaults
---	---



---

<b>Bank 0/1 2/3 4/5 DRAM</b>	<p>This item allows you to select the value in this field, depending on whether the board has paged DRAMs or EDO (extended data output) DRAMs.</p> <p>The choice: EDO 50ns, EDO 60ns, Slow, Medium, Fast, Turbo</p>
<b>SDRAM Cycle Length</b>	<p>You can select CAS latency time in HCLKs of 2/2 or 3/3. The system board designer should have set the values in this field, depending on the DRAM installed. Do not change the values in this field unless you change specifications of the installed DRAM or the installed CPU.</p>
<b>Memory Hole</b>	<p>Choose Enabled or Disabled (default). In order to improve performance, certain space in memory can be reserved for ISA cards. This memory must be mapped into the memory's space below 16MB.</p>
<b>Read Around Write</b>	<p>DRAM optimization feature: If a memory read is addressed to a location whose latest write is being held in a buffer before being written to memory, the read is satisfied through the buffer contents, and the read is not sent to the DRAM.</p> <p>The choice: Enabled, Disabled</p>
<b>Fast R / W Turn Around</b>	<p>When disabled, CPU bus will be occupied during the entire PCI operation period.</p> <p>The choice: Enabled, Disabled</p>
<b>System BIOS</b>	<p>Choose Enabled or Disabled (default). When Enabled, the access to the system BIOS ROM addressed at F0000H-FFFFFH is cached.</p>
<b>Video RAM Cacheable</b>	<p>Choose Enabled or Disabled (default). When enabled, the access to the VGA RAM addressed is cached.</p>

---

<b>AGP Aperture Size (MB)</b>	Choose 4, 8, 16, 32, 64 (default), 128 or 256MB. Memory map and graphics data structures can reside in a Graphics Aperture. This area is like a linear buffer. BIOS will automatically report the starting address of this buffer to the O.S.
<b>AGP-4X Mode</b>	Enabled: Use AGP 4X mode. Disabled (default): Use AGP 1X / 2X mode.
	<b>Note: Don't enable this option unless your AGP card does support AGP-4X mode. For the stability of system,</b>
<b>OnChip USB1</b>	This should be enabled if your system has a USB installed on the system board and you wish to use it. Even when so equipped, if you add a higher performance controller, you will need to disable this feature. The choice: Enabled, Disabled
<b>USB Keyboard Support</b>	Enabled: Enables function when the USB keyboard is being used. Disabled (default): When the AT keyboard is being used.
<b>OnChip Sound</b>	Enabled (default): Turn on AC'97 chip controller. Disabled: Turn off AC'97 chip controller or user can external add-on sound card.
<b>OnChip Modem</b>	Enabled: Turn on MC99 feature. Disabled (default): Disable this feature or user can external add-on modem.
<b>CPU Host Clock</b>	Choose 66/33, 75/37, 83/41, 100/33, 103/34, 105/35, 110/36, 115/38, 124/31, 133/33, 140/35, 112/37, 140/35, 124/41 or 133/44MHz.
<b>CPU Vcore Select</b>	The choice: default, -0.05V, -0.1V, +0.05V, +0.1V, +0.2V, +0.3V, +0.4V
	<b>Note: Wrong setting of CPU Vcore may cause damage to CPU. In consequence of such a potential risk, we strongly recommend user to leave DEFAULT setting unless user does comprehend how to set accurate</b>

3. Press <ESC> and follow the screen instructions to save or disregard your setting.

### 3-10 POWER MANAGEMENT SETUP

**P**ower Management Setup changes the system power savings function.

Run the Power Management Setup as follows:

1. Choose "Power Management SETUP" from the Main Menu and a screen with a list of options will appear.
2. Use one of the arrow keys to move between options and modify the selected options by using PgUp/PgDn/+/- keys.

ROM PCI/ISA BIOS (2A6LJSN9)  
POWER MANAGEMENT SETUP  
AWARD SOFTWARE, INC.

<p>ACPI function : Disabled                      Power Management : User Define                      PM Control by APM : Yes                      Video Off After : Suspend                      Video Off Method : V/H SYNC+Blank                      MODEM Use IRQ : 3                      Soft-Off by PWRBTN : Instant-Off                      PWRON After PW-Fail : Former-Sts                      HDD Power Down : Disabled                      Doze Mode : Disabled                      Suspend Mode : Disabled                      ** PM Events **                      VGA : OFF                      LPT &amp; COM : LPT/COM                      HDD &amp; FDD : ON                      PCI Master : OFF                      Modem Ring Resume : Disabled                      RTC Alarm Resume : Disabled</p>	<p>Primary INTR : ON                      IRQ3 (COM 2) : Primary                      IRQ4 (COM 1) : Primary                      IRQ5 (LPT 2) : Primary                      IRQ6 (Floppy Disk) : Primary                      IRQ7 (LTP 1) : Primary                      IRQ8 (RTC Alarm) : Disabled                      IRQ9 (IRQ2 Redir) : Secondary                      IRQ10 (Reserved) : Secondary                      IRQ11 (Reserved) : Secondary                      IRQ12 (PS/2 Mouse) : Primary                      IRQ13 (Coprprocessor) : Primary                      IRQ14 (Hard Disk) : Primary                      IRQ15 (Reserved) : Disabled</p>
	<p>ESC : Quit      ↑↓→← : Select Item                      F1 : Help      PU/PD/+/- : Modify                      F5 : Old Value (Shift)F2 : Color                      F7 : Load Setup Defaults</p>

---

<b>ACPI Function</b>	Enabled: Turn on ACPI function. Disabled (default): Turn off ACPI function.
<b>Power Management</b>	Choose Max. Saving, User Define (default), Disabled, or Min. Saving.
<b>PM Control By APM</b>	Choose Yes (default) or No. You need to choose Yes when the operating system has the APM functions, otherwise choose No.
<b>Video Off Method</b>	Choose Blank, DPMS or V/H Sync+Blank (default). You can choose either DPMS or V/H Sync+Blank when the monitor has the Green function. You need to choose Blank when the monitor has neither the Green function.
<b>Video Off After</b>	Choose NA, Suspend, Standby (default) or Doze.
<b>Modem Use IRQ</b>	Assign the IRQ number to the modem which is being used so that the ring signal can wake up the system. The default setting is 3 (COM2).
<b>Soft-Off By PWR-BTTN</b>	Instant-Off (default): Turn off the system power at once after pushing the power button. Delay 4 Sec: Turn off the system power 4 seconds after pushing the power button (to meet PC97/98 spec)
<b>Doze Mode</b>	This mode sets the CPU speed down to 33MHz.
<b>Standby Mode</b>	These two options allow you to choose the mode for the different timer. The Standby mode turns off the VGA monitor, and the Suspend mode turns off the CPU and saves the energy of the system.
<b>HDD Power Down</b>	Time is adjustable from 1 to 15 minutes. When the set time has elapsed, the BIOS sends a command to the HDD to power down which turns off the motor.

---

---

**Modem Ring Resume**

An input signal on the serial Ring Indicator (RI) Line (in other words, an incoming call on the modem) awakens the system from a soft off state.

---

**RTC Alarm Resume**

Enabled: Wake on the system from the LAN card (LAN card must support wake on LAN function and the power supply must provide at least 5V/7750mA standby current)

---

**IRQ (#), NMI;  
Primary IDE 0  
Primary IDE 1;  
Secondary IDE 0  
Secondary IDE 1;  
Floppy Disk;**

Enabled (default): The system can not enter the power saving mode when I/O ports or IRQ# is activated.

Disabled: The system still can enter the power saving mode when I/O ports or IRQ# is activated.

***Note: These functions can only be activated when the***

3. Press <ESC> and follow the screen instructions to save or disregard your setting.

### 3-11 PnP / PCI CONFIGURATION SETUP

**P**nP/PCI Configuration Setup defines PCI bus slots.

Run the PnP/PCI Configuration Setup as follows:

1. Choose "PnP/PCI CONFIGURATION SETUP" from the Main Menu and a screen with a list of options will appear.
2. Use one of the arrow keys to move between options and modify the selected options by using PgUp/PgDn/+/- keys.

ROM PCI/ISA BIOS (2A6LJSN9)  
 PNP/PCI CONFIGURATION  
 AWARD SOFTWARE, INC.

PNP OS Installed : No	CPU to PCI Write Buffer: Enabled
Resources Controlled By : Auto	PCI Dynamic Bursting : Enabled
Reset Configuration Data : Disabled	PCI Master 0 WS Write : Enabled
	PCI Delay Transaction : Enabled
	PCI#2 Access #1 Retry : Disabled
	AGP Master 1 WS Write : Disabled
	AGP Master 1 WS Read : Disabled
	Assign IRQ For USB : Enabled
	Assign IRQ For VGA : Enabled
	ESC : Quit      ↑↓→← : Select Item
	F1 : Help      PU/PD/+/- : Modify
	F5 : Old Value    (Shift)F2 : Color
	F7 : Load Setup Defaults

<b>PNP OS Installed</b>	Yes: OS supportsss Plug and Play function. No (default): OS doesn't support Plug and Play function.
<b><i>Note: BIOS will automatically diable all PnP resources except the boot device card when you select Yes on</i></b>	
<b>Resources Controlled</b>	Choose Manual (default) or Auto. The BIOS checks the IRQ/DMA channel number on the ISA and PCI card manually if you choose Manual. And the IRQ/DMA channel number will be checked automatically if you choose Auto.
<b>Reset Configuration</b>	Choose Enabled or Disabled (default). Disable retains Enabled PnP configuration data in BIOS and resets the PnP configuration data in the BIOS.
<b>IRQ-x assigned to</b>	Legacy ISA: Manually assigns IRQ/DMA to device. PCI/ISA PnP: BIOS assigns IRQ/DMA to device automatically.
<b>Assign IRQ for USB</b>	Enabled (default): Add one IRQ to USB controller. Disabled: Remove IRQ from USB controller. The system will have extra IRQ for other devices but the USB controller will still not be diabled (only IRQ was removed)
<b>Assign IRQ for VGA</b>	Enabled (default): Add one IRQ to VGA controller. Disabled: Remove IRQ from VGA controller. The system will have extra IRQ for other devices but the VGA controller will still not be disabled (only IRQ will be removed)

3. Press <ESC> and follow the screen instructions to save or disregard your setting.



### 3-12 LOAD SETUP DEFAULTS

**L**oad Setup Defaults option loads the default system values to the system configuration fields. If the CMOS is corrupted the defaults are loaded automatically.

Choose this option and the following message will appear:

```
"Load Setup Defaults (Y/N)?  N"
```

To use the Setup Defaults, change the prompt to "Y" and press <Enter>.

### 3-13 CPU SPEED SETTING

**C**PU Speed Setting shows the change of temperature for some particular devices such as CPU, FAN, etc.

ROM PCI/ISA BIOS (2A6LJSN9)  
CPU FEATURES SETUP  
AWARD SOFTWARE, INC.

Current CPU Temp. : 31°C/ 87°F Current System Temp. : 0°C/ 32°F Current CPUFAN1 Speed : 5799 RPM Current CPUFAN2 Speed : 0 RPM Vcore : 1.95 V    2.5V : 2.47 V 3.3V : 3.31 V    5V : 4.95 V DV12V : 11.88 V	ESC : Quit      ↑↓→← : Select Item F1 : Help        PU/PD/+/- : Modify F5 : Old Value   (Shift)F2 : Color F7 : Load Setup Defaults
---	---

### 3-14 INTEGRATED PERIPHERALS

Integrated Peripherals option changes the values of the chipset registers. These registers control system options in the computer.

Run the Integrated Peripherals as follows:

1. Choose "INTEGRATED PERIPHERALS" from the Main Menu and a screen with a list of options will appear.
2. Use one of the arrow keys to move between options and modify the selected options by using PgUp/PgDn/+/- keys.

ROM PCI/ISA BIOS (2A6LJSN9)  
INTEGRATED PERIPHERALS  
AWARD SOFTWARE, INC.

OnChip IDE Channel0 : Enabled	Onboard Parallel Port : 378/IRQ7
OnChip IDE Channel1 : Enabled	Onboard Parallel Mode : Normal
IDE Prefetch Mode : Enabled	
Primary Master PIO : Auto	Onboard Legacy Audio : Enabled
Primary Slave PIO : Auto	Sound Blaster : Disabled
Secondary Master PIO : Auto	SB I/O Base Address : 220H
Secondary Slave PIO : Auto	SB IRQ Select : IRQ 5
Primary Master UDMA : Auto	SB DMA Select : DMA 1
Primary Slave UDMA : Auto	MPU-401 : Disabled
Secondary MasterUDMA : Auto	MPU-401 I/O Address : 330-333H
Secondary Slave UDMA : Auto	Game Port (200-207H) : Enabled
Init Display First : PCI Slot	
Onboard FDD Controller: Enabled	
Onboard Serial Port 1 : 3F8/IRQ4	
Onboard Serial Port 2 : 2F8/IRQ3	
UART 2 Mode : Standard	
	ESC : Quit      ↑↓→← : Select Item
	F1 : Help      PU/PD/+/- : Modify
	F5 : Old Value    (Shift)F2 : Color
	F7 : Load Setup Defaults

<b>IDE Primary Master/Slave PIO IDE Secondary</b>	Choose Auto (default) or Mode 0~4. The BIOS will detect the HDD mode type automatically when you choose Auto. You need to set to a lower mode than Auto when your hard disk becomes unstable.
<b>On-Chip Primary/</b>	Enabled (default): Turn on the onboard IDE function. Disabled: Turn off the onboard IDE function.
<b>Onboard FDC</b>	Choose Enabled (default) or Disabled. Choose Disabled when you use an ISA card with FDD function, or choose Enabled to use the onboard FDD connector.
<b>Onboard Serial Port1</b>	Choose Auto (default), 3F8/IRQ4, 2F8/IRQ3, 3E8/IRQ4, 2E8/IRQ3 or Disabled. Don't set port 1 & 2 to the same value, except when setting at Disabled.
<b>Onboard Serial Port2</b>	Choose Auto (default), 3F8/IRQ4, 2F8/IRQ3, 3E8/IRQ4, 2E8/IRQ3 or Disabled.
<b>UART 2 Mode</b>	Choose Standard (default), HPSIR or ASKIR.
<b>IR Function Duplex</b>	Choose Half or Full.
<b>Onboard Paralle Port</b>	Choose the printer I/O address: 378H/IRQ7 (default), 3BCH/IRQ7, 278H/IRQ5 or Disabled.
<b>Onboard Parallel Mode</b>	Choose Normal (default), ECP/EPP, SPP mode. The mode depends on the external device connected to this port.
<b>ECP Mode Use DMA</b>	Choose DMA3 (default) or DMA1. Most sound cards use DMA1. Check with your sound card configuration to make sure that there is no conflict with this function.

**Note: This option will not be displayed unless the EPP/ECP**

<b>Parallel Port EPP Type</b>	Choose EPP1.7 (default) or EPP1.9. EPP1.9 supports hardware handshake. This setting is dependent upon your EPP device.
	<i>Note: The above 2 options will not be displayed unless the</i>
<b>Onboard Legacy Audio</b>	Use default setting.
<b>Sound Blaster</b>	Use default setting.
<b>SB I/O Base Address</b>	Use default setting.
<b>SB IRQ Select</b>	Use default setting.
<b>SB DMA Select</b>	Use default setting.
<b>MPU-401</b>	Use default setting.
<b>MPU-401 I/O Address</b>	Use default setting.
<b>FM Port (388H-38BH)</b>	Use default setting.
<b>GAME Port (200H-207H)</b>	Use default setting.

3. Press <ESC> and follow the screen instructions to save or disregard your setting.

### 3-15 SUPERVISOR / USER PASSWORD

These two options allow you to set your system passwords. Normally, the supervisor has a higher ability to change the CMOS setup option than the user. The way to set up the passwords for both supervisor and user are as follows:

1. Choose "CHANGE PASSWORD" from the Main Menu and press <Enter>. The following message appears:

"Enter Password:"

2. The first time you run this option, enter your own password up to 8 characters and press <Enter>. The screen doesn't display the entered characters.
3. After you entered the password, the following message appears prompting you to confirm the password:

"Confirm Password:"

4. Enter the same password "exactly" as you just typed again to confirm the password and press <Enter>.
5. Move the cursor to Save & Exit Setup to save the password.
6. If you need to delete the password you entered before, choose the Supervisor Password and press <Enter>. It will delete the password that you had before.
7. Move the cursor to Save & Exit Setup to save the option you did, otherwise the old password will still be there the next time you turn your machine on.
8. Press <ESC> to exit to the Main Menu.

**Note:** *If you forget or lose the password, the only way to access the system is to clear the CMOS RAM by setting JBAT1. All setup information will be lost and back to default setting. You need to run the BIOS setup program and re-define all settings again.*

### 3-16 IDE HDD AUTO DETECTION

**I**DE HDD Auto Detection detects the parameters of an IDE Hard Disk drive and automatically enters them to the Standard CMOS Setup screen.

The screen will ask you to select a specific Hard Disk for Primary Master after you selected this option. If you accept a Hard Disk detected by the BIOS, you can enter "Y" to confirm and then press <Enter> to check next Hard Disk. This function allows you to check four Hard Disks and you may press the <ESC> after the <Enter> to skip this function and go back to the Main Menu.

### 3-17 SAVE & EXIT SETUP

**S**ave & Exit Setup allows you to save all modifications you have specified into the CMOS memory. Highlight this option on the Main Menu and the following message appears:

```
SAVE to CMOS and EXIT (Y/N)?   Y
Press <Enter> key to save the configuration changes.
```

### 3-18 EXIT WITHOUT SAVING

**E**xit Without Saving allows you to exit the Setup utility without saving the modifications that you have specified. Highlight this option on the Main Menu and following message appears:

```
Quit Without Saving (Y/N)?   N
```

You may change the prompt to "Y" and press the <Enter> key to leave this option.

## APPENDIX A

### FLASH MEMORY UPDATE INSTALLATION

1. Download BIOS files and flash utility from your board vendor. They are: awdfash.exe and .bin file.
2. Copy them to bootable diskette and boot from diskette.
3. The diskette cannot include memory manager e.g. emm386.exe, qemm and himem.sys, otherwise there will appear an error message "insufficient memory".
4. Type "awdfash filename(XXXX.bin)".
5. Next screen will ask you save current bios to file or not? Depend on your diskette capacity, choose Y or N for this option.
6. Then screen ask you programming the flash memory now? type Y for this option.
7. Programming finish, utility will ask you reboot system.
8. Reset system and press DEL key enter bios setup screen.
9. Select LOAD SETUP DEFAULTS, press ENTER, press Y, press F10, press Y
10. Finish update procedure.



## APPENDIX B DRIVER INSTALLATION

If you are using **Windows 98 SE**, you do not need to install the **4-in-1 driver** as the IRQ Routing Driver and the ACPI Registry are already incorporated into the operating system. Users with Windows 98 SE may update the IDE Busmaster and AGP drivers by installing them individually.

### PART 1:

1. Put the CD into your CD-ROM.
2. There appears a welcome window.  
(If doesn't, it means that your CD-ROM auto-run function does not enable, but you still can browser the CD via Windows Explorer and change the directory to where your CD-ROM directory is. Then run the **autorun.exe**)
3. Select "**Install Driver**".
4. Select "**Install VIA Chipsets Driver**".
5. Select "**Install 4in1 Driver**".
6. Then the program will automatically setup all drivers your system needs.
7. Finally, the system will re-boot.

**NOTE: AFTER INSTALLED "4in1 Driver", USER DOESN'T NEED TO INSTALL ANY OTHER PROGRAM IN PART 2.**

### PART 2:

**CAUTION!! ALL THE VIA MAINBOARD MUST INSTALL FOLLOWING 3 DRIVERS!!!**

#### VIA Patch Code Installation

##### *Windows95/Windows98:*

1. Go to the CD-ROM disk, we suggest the CD-ROM title is D:\.
2. Find and run D:\Patch\Via\patch9x\Setup\Setup.exe
3. Select "Install VIA Chipset Functions' Registry", then it will automatically install this program.

**Note!** This program should be installed before any other VIA's drivers.

#### VIA AGP VxD Driver for Windows 9x Installation

##### *Windows95/Windows98:*

1. Go to the CD-ROM disk, we suggest the CD-ROM title is D:\.
2. Find and run D:\Driver\Via\Agp\Setup\Setup.exe
3. Select "Install VIA AGP VxD in turbo mode" or "Install VIA AGP VxD normal mode", then it will automatically install this program.

## VIA PCI IRQ Routing Miniport for Windows 9x Installation

### **Windows95/Windows98:**

1. Go to the CD-ROM disk, we suggest the CD-ROM title is D:\.
2. Find and run D:\Patch\Via\Virq9x\Setup.exe

**Note:** Before install Windows98, user must enable two functions for this miniport driver in the BIOS menu, one is "OnChip USB" in the "Chipset Features Setup" and another is "Assign IRQ for USB" in the "PNP/PCI Configuration Setup".

## APPENDIX C THERMAL SENSOR

### ■ Thermal Sensor Connector

