

Notice to End Users

This User's Guide & Technical Reference is for assisting system manufacturers and end users in setting up and installing the mainboard.

Every effort has been made to ensure that the information in this manual is accurate. Soltek Computer Inc. is not responsible for printing or clerical errors. Information in this document is subject to change without notice and does not represent a commitment on the part of Soltek Computer Inc.

No part of this manual may be reproduced, transmitted, translated into any language in any form or by any means, electronic or mechanical, including photocopying and recording, for any purpose without the express written permission of Soltek Computer Inc.

Companies and products mentioned in this manual are for identification purposes only. Product names appearing in this manual may or may not be registered trademarks or copyrights of their respective companies.

SOLTEK COMPUTER INC. PROVIDES THIS MANUAL "AS IS" WITHOUT WARRANTY OF ANY KIND, EITHER EXPRESS OR IMPLIED, INCLUDING BUT NOT LIMITED TO THE IMPLIED WARRANTIES OR CONDITIONS OF MERCHANTABILITY OR FITNESS FOR A PARTICULAR PURPOSE. IN NO EVENT SHALL SOLTEK COMPUTER INC. BE LIABLE FOR ANY LOSS OR PROFITS, LOSS OF BUSINESS, LOSS OF USE OR DATA, INTERRUPTION OF BUSINESS, OR FOR INDIRECT, SPECIAL, INCIDENTAL, OR CONSEQUENTIAL DAMAGES OF ANY KIND, EVEN IF SOLTEK COMPUTER INC. HAS BEEN ADVISED OF THE POSSIBILITY OF SUCH DAMAGES ARISING FROM ANY DEFECT OR ERROR IN THIS MANUAL OR PRODUCT.

© Copyright 1998 Soltek Computer Inc. All right reserved

Web site: <http://www.soltek.com.tw>
email: support@mail.soltek.com.tw

Edition: April 1998
Version: 1.0
SL-66D SERIALS



Contents

Chapter 1: Introduction	1
Features	1
CPU	1
Chipset	1
L2 Cache	1
Main Memory	1
BIOS	2
Super I/O Function	2
Other Functions	2
Mainboard Layout with Default Settings	3
Chapter 2: Hardware Setup	4
CPU Type Jumper Configuration	4
CPU 3.5X Clock Setting	4
Pentium II/Celeron – 233/66MHz	4
CPU 4.0X Clock Setting	5
Pentium II/Celeron – 266/66 MHz	5
CPU 4.5X Clock Setting	5
Pentium II/Celeron – 300/66 MHz	5
CPU 5.0X Clock Setting	6
Pentium II/Celeron – 333/66 MHz	6
System Memory Configuration	6
CPU Installation	7
Jumper Settings	11
FAN 1~3: Onboard FAN (12V) Connector	11
JP2, JP4: Bus Clock Select	11
JP5 ~ JP8: Bus Ratio Select	11
JP10, JP11: USB Port Select	12
JVGA1: VGA Card	12

JBAT1: Clear CMOS Data -----	12
JP16: Power Lost Recovery -----	13
IDE LED Activity Light: (J1 pin1-4)-----	13
Infrared Port Module Connector (J1 pin6-10) -----	13
J1 pin12, 13: PWR Switch-----	13
SLEEP Switch (J1 pin14, 15) -----	13
Speaker Connector (J2 pin1-4) -----	13
Reset Switch (J2 pin5, 6)-----	14
J5: Wake On Lan (WOL) Connector -----	14
J6: SB Link-----	14
Power LED and Keylock Switch (J2 pin8-12)-----	14
Turbo LED (J2 pin14, 15)-----	15
J1 Switch Signal Summary -----	16
J2 Switch Signal Summary -----	17

Chapter 3: BIOS Setup ----- 18

Standard CMOS Setup -----	19
BIOS Features Setup -----	21
Chipset Features Setup -----	25
Power Management Setup -----	29
PnP/PCI Configuration Setup -----	33
Load Setup Defaults -----	35
Integrated Peripherals -----	36
Supervisor/User Password -----	39
IDE HDD Auto Detection -----	40
Save & Exit Setup -----	40
Exit Without Saving -----	40

Chapter 1

Introduction

Features

CPU

1. Supports Intel Pentium II and Celeron CPUs using SLOT1 at 166 ~ 533 MHz
2. Supports CPU voltage autodetect circuit

Chipset

1. Intel 82440EX chipset
2. PCI Rev 2.1 compliant
3. Supports 66/133MHz, 3.3V AGP (Accelerated Graphics Port) slot

L2 Cache

1. Pentium II CPU supports 256K/512k write back cache with Pipelined Burst SRAMs

Main Memory

1. Memory range from 8MB (minimum) to 256MB (EDO) or 256MB (SDRAM) (maximum) with DRAM Table Free configurations
2. Supports EDO with 50ns/60ns/70ns speed and SDRAM with 12/10/8ns speed
3. **Supports 2 pcs 168pin DIMM sockets (3.3V Unbuffered and 4 clock type)**

BIOS

1. AWARD Plug and Play BIOS
2. Supports Advanced Power Management Function
3. Flash Memory for easy upgrade

Super I/O Function

1. Integrated USB (Universal Serial Bus) controller with two USB ports.
2. Supports 2 IDE channels with 4IDE devices (including LS-120/ZIP IDE devices)
3. Provides PCI IDE Bus Master function and supports Ultra DMA33 function
4. One floppy port
5. Two high speed 16550 FIFO UART ports
6. One parallel port with EPP/ECP/SPP capabilities
7. PS/2 mouse connector
8. Built-in RTC, CMOS, keyboard controller on single I/O chip
9. Peripherals boot function

Other Functions

1. ATX size 17cm x 30.5cm
2. 3 PCI Master slots, 1 PCI Slave slot, 3 ISA slots, and 1 AGP slot
3. Supports SCSI/CD-ROM Boot function
4. **Supports jumperless setting**
5. **Supports 75Mhz Bus Clock**
6. **Supports Wake On Lan (WOL) function (option)**
7. **Supports Power Lost Recovery function.**

Mainboard Layout with Default Settings

The default settings of the following figure is for the Pentium II/Celeron 233MHz and the Jumperless function is Enabled.

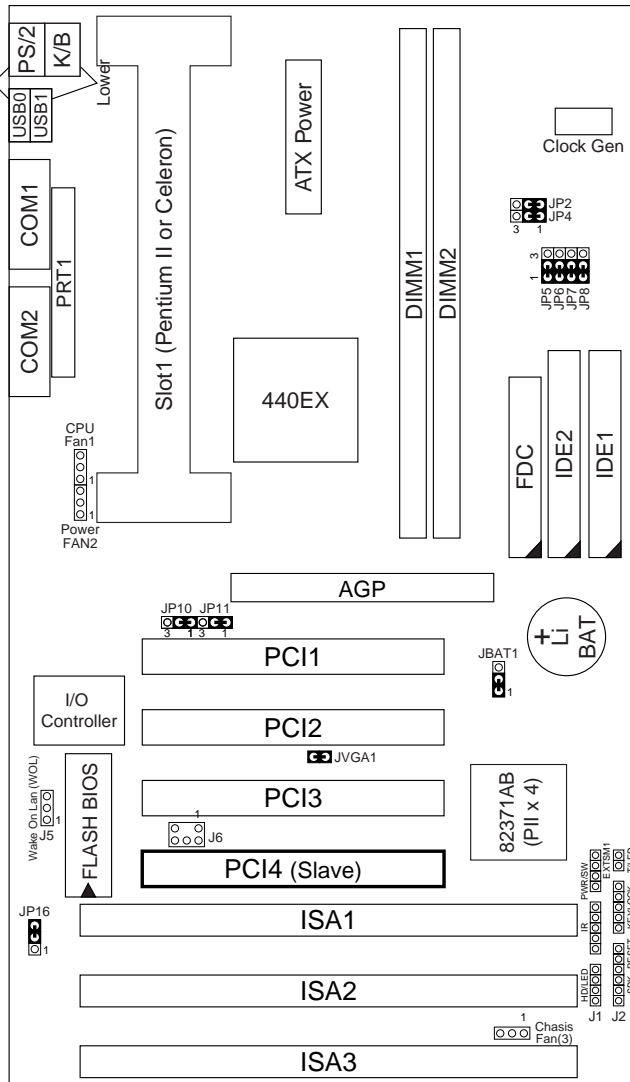

Figure 1-1. Motherboard Layout

Chapter 2

Hardware Setup

There are two ways to set the CPU type and both ways are controlled by JP5, JP6, JP7, and JP8:

1. Use jumpers (hardware): JP5 ~ JP8 must be set. Refer to the following pages (page 4~6).
2. Use BIOS (jumperless): JP5 ~ JP8 must be all closed at pin 1-2 (default). Refer to page 25 for detail description.

CPU Type Jumper Configuration

CPU 3.5X Clock Setting

Pentium II/Celeron – 233/66MHz

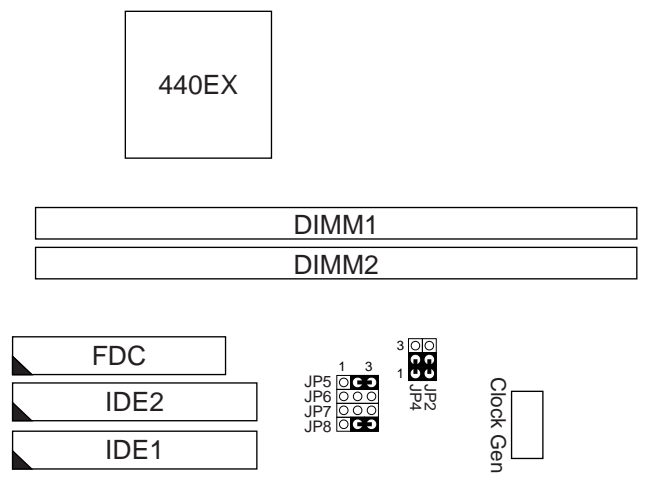

Figure 2-1. CPU Type Configuration

CPU 4.0X Clock Setting

Pentium II/Celeron – 266/66 MHz

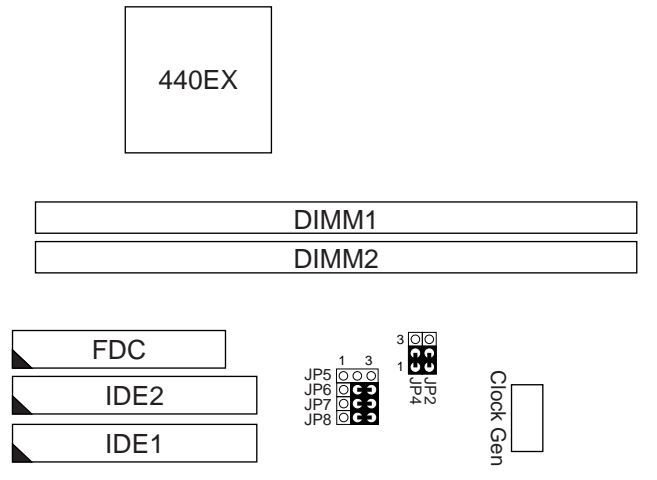

Figure 2-2. CPU Type Configuration

CPU 4.5X Clock Setting

Pentium II/Celeron – 300/66 MHz

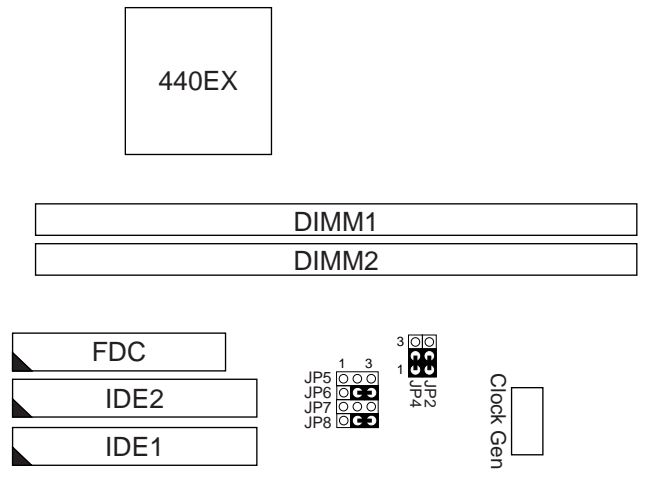

Figure 2-3. CPU Type Configuration

CPU 5.0X Clock Setting

Pentium II/Celeron – 333/66 MHz

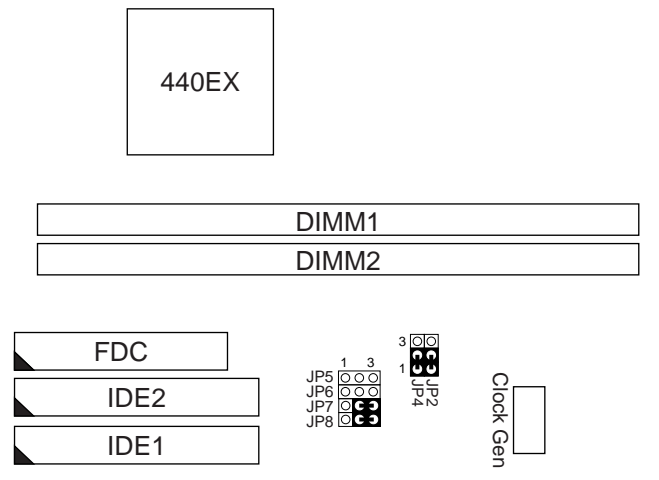

Figure 2-4. CPU Type Configuration

System Memory Configuration

This 82440EX motherboard supports 168 pin DIMM of 4MB, 8MB, 16MB, 32MB, or 64MB to form a memory size between 8MB to 256MB (EDO) or 256MB (SDRAM). 82440EX chipsets provide "Table-Free" function. It means that users can install DRAM with any configuration and in any bank, and that is why the DRAM table is not needed but do remember that **the DRAM must be 3.3V Unbuffered and 4 clock type**.

CPU Installation

Follow the following steps in order to install your Intel Pentium II/Celeron properly.

Step 1:

Be sure you are in contact with heat sink vendors for attaching the heat sink on to the CPU.

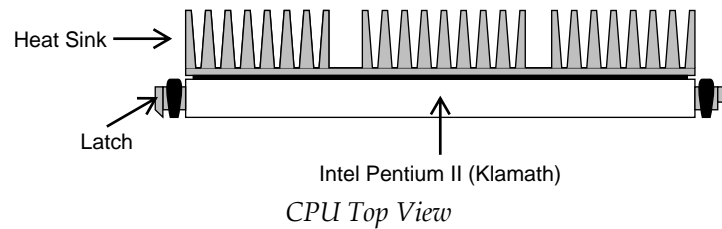
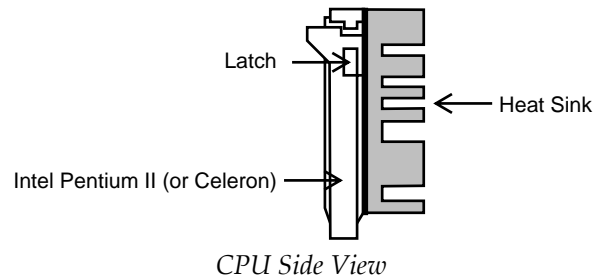

Notice that the heat sink may be different from the drawings shown here.

Step 2:

Install the 2 pairs of screws, which are shown in the following drawing, onto the mainboard under Slot1.

Two of the screws are right around Slot1 and the other pair of screws should be inserted opposite the first pair.

The screws should be inserted from the bottom of the motherboard upward.

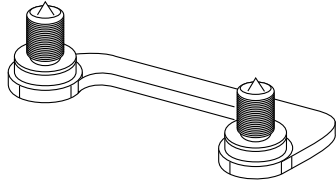

Step 3:
Retention clip is shown in the following figure:

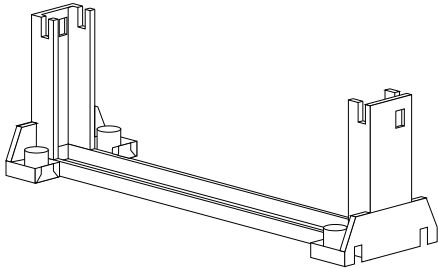

Set the board according to the following diagram before installing the retention clip.

If installed incorrectly, you will not be able to insert the CPU into the retention clip and in this situation you might need to rotate the retention clip by 180°.

Tighten the 4 screws on the retention clip till the neck of the screws can not be seen from the bottom of the board

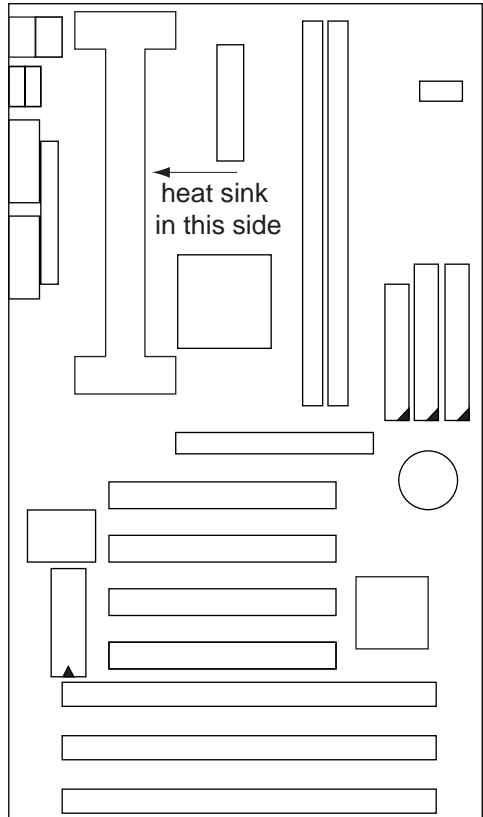

Step 4:

Pull the latches up on the base of the CPU supporter and insert it into the two holes directly to the left of the retention clip so that the larger hole is on the bottom.

Press the base of the CPU supporter down in to the holes and lock the latches.

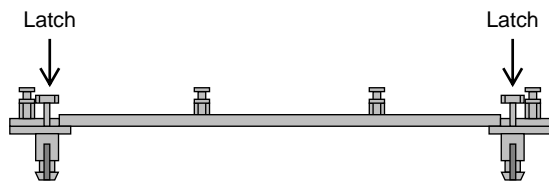

Side View of CPU Supporter Base

Step 5:

Flatten the two latches on the side of CPU. Insert the CPU into the retention clip. Lock the two latches to secure the CPU.

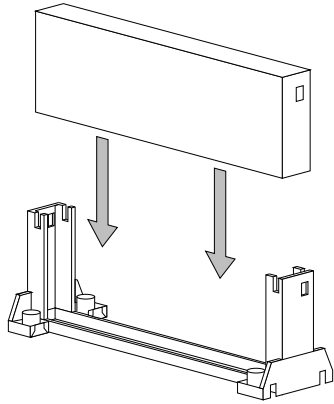

Step 6:

Insert the clip portion of the CPU supporter so that the heat sink can sit on the top of the whole CPU supporter.



Top View of CPU Support Clip

Notice that the base and the clip of CPU Supporter may be different from the figures shown here.

Jumper Settings

FAN 1~3: Onboard FAN (12V) Connector

FAN#	Function
FAN1	CPU FAN
FAN2	Power FAN
FAN3	Chasis FAN

JP2, JP4: Bus Clock Select

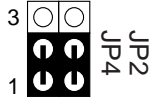
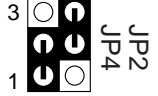
Bus Clock	JP2, JP4
66MHz (default)	
75MHz	

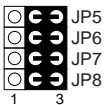
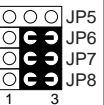
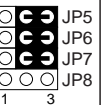
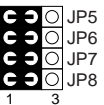
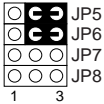
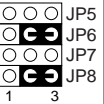
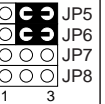
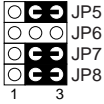
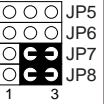
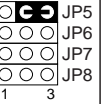
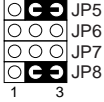
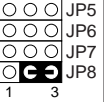
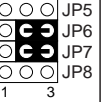

JP5 ~ JP8: Bus Ratio Select

Bus Ratio	JP5 ~ JP8	Bus Ratio	JP5 ~ JP8	Bus Ratio	JP5 ~ JP8	Bus Ratio	JP5 ~ JP8
2.0X		4.0X		6.0X		by BIOS (default)	
2.5X		4.5X		6.5X			
3.0X		5.0X		7.0X			
3.5X		5.5X		7.5X			

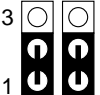
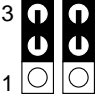
JP10, JP11: USB Port Select

USB Port	JP10/JP11
Redirect USB1 to AGP port (default)	 JP10 JP11
Redirect all USB ports to USB connector	 JP10 JP11



JVGA1: VGA Card

	JVGA1
For Special VGA Card*	
Normal (default)	

Note: This jumper is set for the special VGA card. Open this jumper when the system isn't able to boot



JBAT1: Clear CMOS Data

Clear the CMOS memory by shorting this jumper momentarily; then remove the cap to retain new settings.

COMS Data	JBAT1
Clear Data	 1 3
Retain Data (default)	 1 3

JP16: Power Lost Recovery

This jumper allows you to use the switch of ATX power supply to control on/off switch directly instead of using the power switch on the mainboard.

Power Lost Recovery	JP16
Normal (default)	 1 3
Enabled	 1 3

IDE LED Activity Light: (J1 pin1–4)

This connector connects to the hard disk activity indicator light on the case.

Infrared Port Module Connector (J1 pin6–10)

The system board provides a 5-pin infrared connector—IR1 as an optional module for wireless transmitting and receiving. **Pin 6 through 10 are Transmit, GND, Receive (low speed), Receive (high speed), and Vcc, respectively.**

J1 pin12, 13: PWR Switch

Power Switch: Toggle this pin for turning on/off of the power supply (for ATX power only).

SLEEP Switch (J1 pin14, 15)

Toggle this jumper forces the system to sleep and the system won't wake up until the hardware event is coming. (The BIOS Power Management setting must be Enabled.)

Speaker Connector (J2 pin1–4)

The speaker connector is a 4-pin connector for connecting the system and the speaker. (See the following drawing for jumper position.)

Reset Switch (J2 pin5, 6)

The system board has a 2-pin connector for rebooting your computer without having to turn off your power switch. This prolongs the life of the system's power supply.

J5: Wake On Lan (WOL) Connector

This connector is designed to use Lan to bootup the system. Connect the wake on signal from Lan card to this connector.

J6: SB Link

This socket is designed for using the SoundBlast PCI Sound card.

Power LED and Keylock Switch (J2 pin8-12)

The keylock switch is a 5-pin connector for locking the keyboard for security purposes. (See the following drawing for jumper position, and pin1~3 is connected to power LED and pin 4~5 is connected to keylock switch.)

Turbo LED (J2 pin14, 15)

Connect the case's turbo LED to this connector.

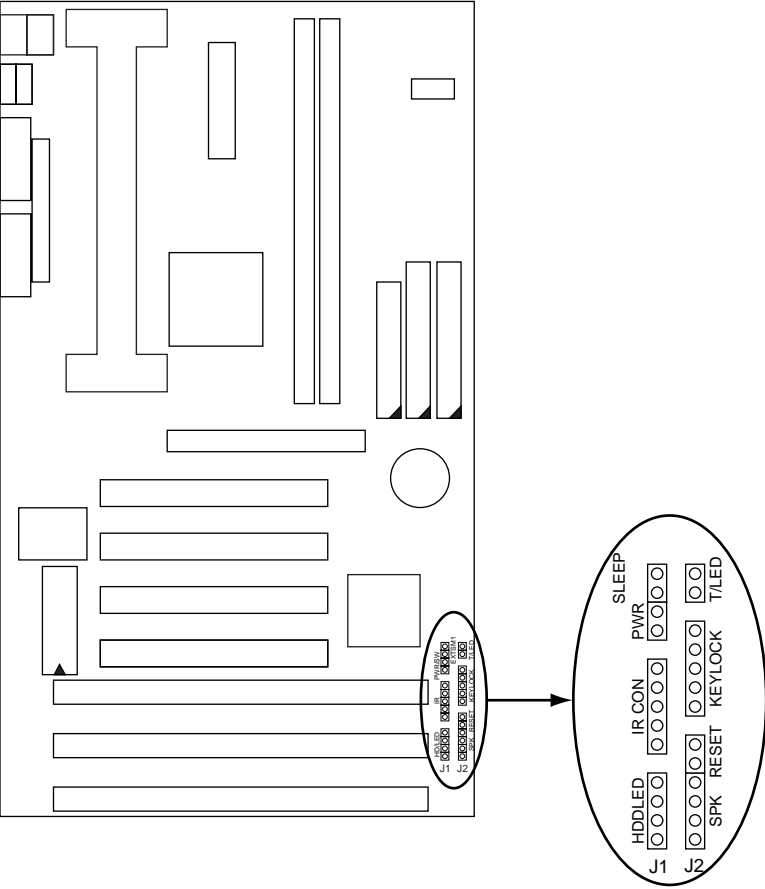

J1 Switch Signal Summary

J1	Pin	Signal Description
HDD LED Connector	1	+5V
	2	HDD LED Signal
	3	HDD LED Signal
	4	+5V
N.C.	5	No Connection
Infrared Connector	6	Infrared Transmit Signal
	7	GND
	8	Infrared Receive Signal (low speed)
	9	Infrared Receive Signal (high speed)
	10	+5V
N.C.	11	No Connection
PWR	12	GND
	13	Power Switch (for ATX Power)
SLEEP	14	GND
	15	Sleep Signal

J2 Switch Signal Summary

J2	Pin	Signal Description
Speaker Connector	1	Speaker Signal
	2	No Connection
	3	Ground
	4	+5V
Reset Switch	5	Reset Signal
	6	Ground
N.C.	7	No Connection
Power LED Connector	8	+5V
	9	No Connection
	10	Ground
Keylock Connector	11	Keylock Signal
	12	GND
N.C.	13	No Connection
Turbo LED Connector	14	Turbo LED Connector
	15	Ground

Chapter 3

Award BIOS Setup

This 82440EX motherboard comes with the AWARD BIOS from AWARD Software Inc. Enter the Award BIOS program's Main Menu as follows:

1. Turn on or reboot the system.

After a series of diagnostic checks, the following message will appear:

PRESS TO ENTER SETUP

2. Press the key and the main program screen appears as in the following page.

ROM PCI/ISA BIOS
CMOS SETUP UTILITY
AWARD SOFTWARE, INC.

STANDARD CMOS SETUP	INTEGRATED PERIPHERALS
BIOS FEATURES SETUP	SUPERVISOR PASSWORD
CHIPSET FEATURES SETUP	USER PASSWORD
POWER MANAGEMENT SETUP	IDE HDD AUTO DETECTION
PNP/PCI CONFIGURATION	SAVE & EXIT SETUP
LOAD SETUP DEFAULTS	EXIT WITHOUT SAVING
Esc : Quit	↑ ↓ → ← : Select Item
F10 : Save & Exit Setup	(Shift) F2 : Change Color
Time, Date, Hard Disk Type...	

3. Using one of the arrows on your keyboard to select an option and press <Enter>. Modify the system parameters to reflect the options installed in the system.
4. You may return to the Main Menu anytime by press <ESC>.
5. In the Main Menu, "SAVE AND EXIT SETUP" saves your changes and reboots the system, and "EXIT WITHOUT SAVING" ignores your changes and exits the program.

Standard CMOS Setup

Standard CMOS Setup allows you to record some basic system hardware configuration and set the system clock and error handling. You only need to modify the configuration values of this option when you change your system hardware configuration or the configuration stored in the CMOS memory got lost or damaged.

Run the Standard CMOS Setup as follows:

1. Choose "STANDARD CMOS SETUP" from the Main Menu and a screen with a list of options appears.

```
ROM PCI/ISA BIOS
STANDARD CMOS SETUP
AWARD SOFTWARE, INC.
```

Date (mm:dd:yy) : Thu, May 9 1996		Time (hh:mm:ss) : 15 : 45 : 10	
HARD DISKS	TYPE	SIZE	CYLS HEAD PRECOMP LANDZ SECTOR MODE
Primary Master	: Auto	0	0 0 0 0 0 Auto
Primary Slave	: Auto	0	0 0 0 0 0 Auto
Secondary Master	: Auto	0	0 0 0 0 0 Auto
Secondary Slave	: Auto	0	0 0 0 0 0 Auto
Drive A : 1.44M, 3.5 in.		Base Memory: 640K Extended Memory: 15360K Other Memory: 384K <hr style="width: 50%; margin: 0 auto;"/> Total Memory: 16384K	
Drive B : None			
Floppy 3 Mode Support : Disabled			
Video : EGA/VGA			
Halt On : All Errors			
Esc : Quit		↑ ↓ → ← : Select Item PU/PD/+/- : Modify	
F1 : Help		(Shift) F2 : Change Color	

2. Use one of the arrow keys to move between options and modify the selected options by using PgUp/PgDn/+/- keys.

A short description of screen options follows:

- Date (mm:dd:yy)** Set the current date and time.
- Time (hh:mm:ss)**

- Primary (Secondary) Master/Slave** This field records the specifications for all non-SCSI hard disk drives installed in your system. Refer to the respective documentation on how to install the drivers.

- Drive A/B** Set this field to the types of floppy disk drives installed in your system. The choices are:
360KB, 5.25 in.,
1.2MB, 5.25 in.,
720KB, 3.5 in.,
1.44M, 3.5 in. (default),
2.88MB, 3.5 in., or None

- Floppy 3 Mode Support** Drive A/B, Both: Enabled 3.5-inch, 1.2MB function.
Disabled (default): Disabled 3.5-inch, 1.2MB function.

- Video** Set this field to the type of video display card installed in the system. The choices are: Monochrome; Color 40x25; VGA/ EGA (default); or Color 80x25

- Halt On** Set this field to the type of errors that will cause the system to halt. The choices are: All Errors (default); No Errors; All, But Keyboard; All, But Diskette; or All, But Disk/Key

3. Press <ESC> to return to the Main Menu when you finish setting up in the "Standard CMOS Setup".

BIOS Features Setup

BIOS Features Setup allows you to improve your system performance or set up some system features according to your preference.

Run the BIOS Features Setup as follows:

1. Choose "BIOS FEATURES SETUP" from the Main Menu and a screen with a list of options appears.

```
ROM PCI/ISA BIOS
BIOS FEATURES SETUP
AWARD SOFTWARE, INC.
```

Virus Warning	: Disabeld	Video BIOS Shadow	: Enabled
CPU Internal Cache	: Enabled	C8000-CBFFF Shadow	: Disabled
External Cache	: Enabled	CC000-CFFFF Shadow	: Disabled
Quick Power on Self Test	: Enalbed	D0000-D3FFF Shadow	: Disabled
Boot Sequence	: A,C, SCSI	D4000-D7FFF Shadow	: Disabled
Swap Floppy Drive	: Disabled	D8000-DBFFF Shadow	: Disabled
Boot Up Floppy Seek	: Disabled	DC000-DFFFF Shadow	: Disabled
Boot Up NumLock Status	: On		
Gate A20 Option	: Fast		
Typeomatic Rate Setting	: Disabled		
Typeomatic Rate (Chars/Sec)	: 6		
Typeomatic Delay (Msec)	: 250	ESC : Quit	↑ ↓ → ← : Select Item
Security Option	: Setup	F1 : Help	PU/PD/+/- : Modify
Assign IRQ For VGA	: Enabled	F5 : Old Values (Shift)	F2 : Color
PCI/VGA Palette Snoop	: Disabled	F6 : Load BIOS Defaults	
OS Select for DRAMs>64MB	: Non-OS/2	F7 : Load Setup Defaults	

2. Use one of the arrow keys to move between options and modify the selected options by using PgUp/PgDn/+/- keys. An explanation of the <F> keys follows:

<F1>: "Help" gives options available for each item.

Shift <F2>: Change color.

<F5> : Get the previous values. These values are the values with which the user started the current session.

<F6>: Load all options with the BIOS default values.

<F7>: Load all options with the Setup default values.

A short description of screen options follows:

- Virus Warning** Enabled: Activates automatically when the system boots up causing a warning message to appear if there is anything attempts to access the boot sector or hard disk partition table.
Disabled: No warning message will appear when there is something attempts to access the boot sector or hard disk partition table
Note: Many diagnostic (or boot manager) programs which attempt to access the boot sector table can cause the above warning message. If you will be running such a program, we recommend that you disable the virus protection first.
- CPU Internal Cache** Choose Enabled (default) or Disabled. This option allows you to enable or disable the CPU's internal cache.
- External Cache** Choose Enabled (default) or Disabled. This option allows you to enable or disable the external cache memory.
- Quick Power On Self Test** Choose Enabled (default) or Disabled. This option allows you to speed up the Power On Self Test routine.

Boot Sequence	Default is "A, C, SCSI". This option determines which drive to look for first for an operating system.
Swap Floppy Drive	Choose Enabled or Disabled (default). This option swaps floppy drive assignments when it is enabled.
Boot Up Floppy Seek	<p>Enabled: During POST, BIOS checks the track number of the floppy disk drive to see whether it is 40 or 80 tracks.</p> <p>Disabled (default): During POST, BIOS will not check the track number of the floppy disk drive.</p>
Boot Up NumLock Status	Choose On (default) or Off. This option lets user to activate the NumLock function at boot-up.
Gate A20 Option	Choose Normal or Fast (default). This option allows the RAM to access the memory above 1MB by using the fast gate A20 line.
Typematic Rate Setting	Choose Enabled or Disabled (default). Enable this option to adjust the keystroke repeat rate.
Typematic Rate (Chars/Sec)	Range between 6 (default) and 30 characters per second. This option controls the speed of repeating keystrokes.
Typematic Delay (Msec)	Choose 250 (default), 500, 750, and 1000. This option sets the time interval for displaying the first and the second characters.

Security Option Choose System or Setup (default). This option is to prevent unauthorized system boot-up or use of BIOS Setup.

Assign IRQ for VGA Choose Enabled (default) or Disabled.
Enabled: Add one IRQ to VGA controller.
Deisabled: Remove IRQ from VGA controller. The system will have extra IRQ for other devices but the VGA controller will still not disabled (only IRQ was removed.)

PCI/VGA palette Snoop Choose Enabled or Disabled (default). It determines whether the MPEG ISA cards can work with PCI/VGA or not.

Video BIOS Shadow Enabled (default): Map the VGA BIOS to system RAM.
Disabled: Don't map the VGA BIOS to system RAM.

C8000-CBFFF to DC000-DFFF Shadow These options are used to shadow other expansion card ROMs.

3. Press <ESC> and follow the screen instructions to save or disregard your settings.

Chipset Features Setup

Chipset Features Setup changes the values of the chipset registers. These registers control the system options.

Run the Chipset Features Setup as follows:

1. Choose "CHIPSET FEATURES SETUP" from the Main Menu and a screen with a list of options appears.

```
ROM PCI/ISA BIOS
CHIPSET FEATURES SETUP
AWARD SOFTWARE, INC.
```

Auto Configuration	: Enabled	SDRAM CAS Latency Time	: 3
MA Wait State	: Slow	CPU Clock Ratio	: 3.5-233MHz
EDO RAS# To CAS# Delay	: 3	Spread Spectrum	: Disabled
EDO RAS# Precharge Time	: 3	CPU Clock Frequency	: 66MHz
EDO DRAM Read Burst	: x333	CPU Warning Temperature	: Disabled
EDO DRAM Write Burst	: x222	Current CPU Temperature	:
DRAM Data Integrity Mode	: Non-ECC		
CPU To-PCI IDE Posting	: Disabled		
System BIOS Cacheable	: Disabled		
Video BIOS Cacheable	: Disabled		
Video RAM Cacheable	: Disabled		
8 Bit I/O Recovery Time	: 3		
16 Bit I/O Recovery Time	: 2		
Memory Hole At 15M-16M	: Disabled		
AGP Aperture Size (MB)	: 64	ESC : Quit	↑ ↓ → ←: Select Item
SDRAM RAS-to-CAS Delay	: Slow	F1 : Help	PU/PD/+/- : Modify
SDRAM RAS Precharge Time	: Slow	F5 : Old Values (Shift)F2 : Color	
		F6 : Load BIOS Defaults	
		F7 : Load Setup Defaults	

2. Use one of the arrow keys to move between options and modify the selected options by using PgUp/PgDn/+/- keys.

A short description of screen options follows:

Auto Configuration	Choose Enabled (default) or Disabled. The system sets all options on the left side of the screen automatically when choose Enabled.
DRAM Speed Selection	Choose 60ns or 70ns (default). Do not change this setting unless you know the DRAM access time spec.

MA Wait State	Use the default setting.
EDO RAS# to CAS# Delay	Use the default setting. This setup option allows you to determine the delay time in completing the transition from RAS to CAS.
EDO RAS# Precharge Time	Use the default setting. This option allows you to determine the number of the CPU clocks allocated for the RAS to accumulate/charge it before the DRAM is refreshed.
EDO DRAM Read Burst	Use the default setting. Burst read/write requests are generated by the CPU in four separate parts. The 1st part provides the location within the DRAM where the read or write is to take place while the remaining three parts provide the actual data. The lower the timing number is, the faster the system memory will be addressed.
EDO DRAM Write Burst	
DRAM Data Integrity Mode	Choose Non-ECC (default) or ECC depending on the DRAM type. ECC stands for Error Check and Correct. Non-ECC: Disabled ECC check function. ECC: Enabled ECC check function.
CPU-To-PCI IDE Posting	Choose Enabled (default) or Disabled.
System BIOS Cacheable	Choose Enabled or Disabled (default). When Enabled, the access to the system BIOS ROM addressed at F0000H-FFFFFH is cached.

Video BIOS Cacheable Choose Enabled or Disabled (default). When Enabled, the access to the VGA BIOS ROM addressed at C0000H-C7FFFH is cached.

Video RAM Cacheable Choose Enabled or Disabled (default). When Enabled, the access to the VGA RAM addressed is cached.

8 Bit I/O Recovery Time;
16 Bit I/O Recovery Time This delay happens when the CPU is running so much faster than the I/O bus that the CPU must be delayed to allow for the completion of the I/O.
The choices for 8 bit I/O are NA, 1 to 8 CPU clock. Default is 3.
The choices for 16 bit I/O are NA, 1 to 4 CPU clock. Default is 2.

Memory Hole At 15M-16M Choose Enabled or Disabled (default). In order to improve performance, certain space in memory can be reserved for ISA cards. This memory must be mapped into the memory's space below 16MB.

AGP Aperture Size (MB) Choose 4 , 8, 16, 32, 64 (default), 128, or 256 MB. Memory mapped and graphics data structures can reside in a Graphics Aperture. This area is like a linear buffer. BIOS will auto report the starting address of this buffer to the O.S.

SDRAM RAS-To CAS Delay Use the default setting.

SDRAM RAS Precharge Time	Use the default setting.
SDRAM CAS Latency Time	Use the default setting.
CPU Clock Ratio	Choose 2.0-133MHz, 2.5-166MHz, 3.0-200MHz, 3.5-233MHz (default), 4.0-266MHz, 4.5-300MHz, or 5.0-333MHz. This value is based on the CPU clock at 66.6MHz and should be the same as the user's CPU spec.
Spread Spectrum Modulated	Choose Disabled (default), 1.8% (CNTR), 0.6% (CNTR), 1.8% (DOWN), 0.6% (DOWN, or Enabled. This function is designed only for EMI test.
CPU Clock Frequency	Choose Disabled (same as 66MHz), 50, 60, 66 (default), 68, 75, 83MHz.
CPU Warning Temperature*	Choose Disabled (default), 60°C/140°F, 65°C/149°F, 70°C/158°F, 75°C/167°F, 80°C/176°F, 85°C/185°F, 90°C/194°F. When CPU temperature is over the setting value, the speaker will sound an alarm and the clock will drop until the temperature is within optimum the temperature range.
Current CPU Temperature*	BIOS will auto displays CPU temperature.

*: Theses options won't work unless the chip is installed.

3. Press <ESC> and follow the screen instructions to save or disregard your settings.

Power Management Setup

Power Management Setup sets the system's power saving functions.

1. Choose "POWER MANAGEMENT SETUP" from the Main Menu and a screen with a list of options appears.

```

ROM PCI/ISA BIOS
POWER MANAGEMENT SETUP
AWARD SOFTWARE, INC.

Power Management      : Disabled
PM Control by APM     : No
Video Off Method      : V/H SYNC+Blank
Video Off After       : NA
Modem Use IRQ         : 3

Doze Mode             : Disabled
Standby Mode          : Disabled
Suspend Mode          : Disabled
HDD Power Down        : Disabled
Throttle Duty Cycle   : 62.5%
ZZ Active in Suspend  : Disabled
VGA Active Monitor    : Enabled
Soft-Off by PWR-BTNN : Instant-Off
Resume by Ring        : Disabled
IRQ 8 Break Suspend   : Disabled

** Reload Global Timer Events **
IRQ[3-7,9-15], NMI   : Enabled
Primary IDE 0         : Enabled
Primary IDE 1         : Enabled
Secondary IDE 0       : Enabled
Secondary IDE 1       : Enabled
Floppy Disk           : Enabled
Serial Port           : Enabled
Parallel Port         : Enabled

ESC : Quit           ↑ ↓ → ← : Select Item
F1  : Help           PU/PD/+/- : Modify
F5  : Old Values (Shift)F2 : Color
F6  : Load BIOS Defaults
F7  : Load Setup Defaults

```

2. Use one of the arrow keys to move between options and modify the selected options by using PgUp/PgDn/+/- keys.

A short description of screen options follows:

- Power Management** Choose Max. Saving, User Define, Disabled (default), or Min Saving.
- PM Control by APM** Choose Yes or No (default). You need to choose Yes when the operating system has the APM functions, choose No otherwise.

- Video Off Method** Choose Blank , DPMS, or V/H Sync+Blank (default). You can chose either DPMS or V/H Sync+Blank when the monitor has the Green function. You need to choose Blank when the monitor has neither the Green function.
- Video Off After** Use the default setting.
- MODEM Use IRQ** Assign the IRQ number to the modem which is being used so that the ring signal can wakeup the system. The default setting is 3 (COM2).
- Doze Mode** This option sets the CPU speed down to 33MHz during this mode.
- Standby Mode
Suspend Mode** These two options allow you to choose the mode for the different timers. The Standby Mode turns off the VGA monitor, and the Suspend Mode turns off the CPU and saves the energy of the system.
- HDD Power Down** Time is adjustable from 1 to 15 minutes. When the set time has elapsed, the BIOS sends a command to the HDD to power down, which turns off the motor.
- Throttle Duty Cycle** Choose the duty cycle time: 12.5%, 25%, 37.5%, 50%, 62.5% (default), 75%, or 87.5%. The bigger of the percentage, the more saving power it gets.

ZZ Active in Suspend

Enabled: PB SRAM (cache) still consumes power when entering the power management mode.
Disabled: (default) PB SRAM (cache) will not consume power when entering the power management mode.

VGA Active Monitor

Enabled: the system can not enter the power saving mode when monitor is on.
Disabled: the system can enter the power saving mode when monitor is on.

Soft-Off by PWR-BTTN

Instant-off: (default) turns off the system power at once after pushing the power button.
Delay 4 Sec: turns off the system power 4 seconds after pushing the power button (to meet PC97 spec.)

Resume by Ring

Enabled: Wake up the system from ring signal.
Disabled: (default) Ring signal can not wake up the system.

|

IRQ (#), NMI;	Enabled:	(default) The system can not enter the power saving mode when I/O ports or IRQ# is activated.
Primary IDE 0		
Primary IDE 1;		
Secondary IDE 0		
Secondary IDE 1;	Disabled:	The system still can enter the power saving mode when I/O ports or IRQ# is activated.
Floppy Disk;		
Serial Port;		
Parallel Port		<i>Note: These functions can only be activated when the power management option is Enabled.</i>

3. Press <ESC> and follow the screen instructions to save or disregard your settings.

PnP/PCI Configuration Setup

PnP/PCI Configuration Setup configures the PCI bus slots.

Run the Chipset Features Setup as follows:

1. Choose “PnP/PCI CONFIGURATION SETUP” from the Main Menu and a screen with a list of options appears.

```
ROM PCI/ISA BIOS
PNP/PCI CONFIGURATION
AWARD SOFTWARE, INC.
```

PNP OS Installed	: No	PCI IDE IRQ Map to	: PCI-AUTO
Resources Controlled By	: Manual	Primary IDE INT#	: A
Reset Configuration Data	: Disabled	Secondary IDE INT#	: B
IRQ-3 assigned to	: Legacy ISA	Used MEM base adr	: N/A
IRQ-4 assigned to	: Legacy ISA	Used MEM Length*	: 8K
IRQ-5 assigned to	: PCI/ISA PnP	Assign IRQ For USB	: Enabled
IRQ-7 assigned to	: PCI/ISA PnP		
IRQ-9 assigned to	: PCI/ISA PnP		
IRQ-10 assigned to	: PCI/ISA PnP		
IRQ-11 assigned to	: PCI/ISA PnP		
IRQ-12 assigned to	: PCI/ISA PnP		
IRQ-14 assigned to	: PCI/ISA PnP		
IRQ-15 assigned to	: PCI/ISA PnP		
DMA-0 assigned to	: PCI/ISA PnP		
DMA-1 assigned to	: PCI/ISA PnP	ESC : Quit	↑ ↓ → ← : Select Item
DMA-3 assigned to	: PCI/ISA PnP	F1 : Help	PU/PD/+/- : Modify
DMA-5 assigned to	: PCI/ISA PnP	F5 : Old Values (Shift)	F2 : Color
DMA-6 assigned to	: PCI/ISA PnP	F6 : Load BIOS Defaults	
DMA-7 assigned to	: PCI/ISA PnP	F7 : Load Setup Defaults	

2. Use one of the arrow keys to move between options and modify the selected options by using PgUp/PgDn/+/- keys.

A short description of screen options follows:

PNP OS Installed Yes: OS supports Plug and Play function.
No (default): OS doesn't support Plug and Play function.

Note: BIOS will automatically disable all PnP resources except the boot device card when select Yes on Non-PnP OS.

Resources Controlled By	Choose Manual (default) or Auto. The BIOS checks the IRQ/DMA channel number on the ISA and PCI card manually if chose Manual and the IRQ/DMA channel number will be checked automatically if choose Auto.
Reset Configuration Data	Choose Enabled or Disabled (default). Disabled means to retain PnP configuration data in BIOS and Enabled means to reset PnP configuration data in BIOS.
IRQ-x assigned to DMA-x assigned to	Legacy ISA: Manually assigns IRQ/DMA to device. PCI/ISA PnP: BIOS assigns IRQ/DMA to device automatically.
PCI IDE IRQ Map To	Select PCI-AUTO (default), ISA, or assign a PCI SLOT number (depending on which slot the PCI IDE is inserted). If PCI-AUTO does not work, then assign an individual PCI SLOT number.
Primary/ IDE INT#	Choose A (default), B, C, or D.
Secondary IDE INT#	Choose A, B (default), C, or D.
Used MEM Base Addr	Choose N/A (default) or ISA legacy card requests to have memory start address.

Used MEM Length*

Choose 8K, 16K, 32K, or 64K.

With the above two functions, users can define where the used memory address is located and its corresponding length of the legacy area. BIOS will skip the UMB area which is used by the legacy device to avoid memory space conflict.

* This function activates only when the "Used MEM Base Addr" is chosen.

Assign IRQ for USB

Choose Enabled (default) or Disabled.

Enabled: Add one IRQ to USB controller.

Deisabled: Remove IRQ from USB controller. The system will have extra IRQ for other devices but the USB controller will still not disabled (only IRQ was removed.)

3. Press <ESC> and follow the screen instructions to save or disregard your settings.

Load Setup Defaults

Load Setup Defaults option loads the default system values to the system configuration fields. If the CMOS is corrupted the defaults are loaded automatically. Choose this option and the following message appears:

"Load Setup Defaults (Y/N)? N"

To use the Setup defaults, change the prompt to "Y" and press <Enter>.

Integrated Peripherals

Integrated Peripherals option changes the values of the chipset registers. These registers control system options in the computer.

1. Choose "INTEGRATED PERIPHERALS" from the Main Menu and a screen with a list of options appears.

```

ROM PCI/ISA BIOS
INTEGRATED PERIPHERALS
AWARD SOFTWARE, INC.

```

IDE HDD Block Mode	: Enabled	Onboard Parallel Port	: 378/IRQ7
IDE Primary Master PIO	: Auto	Parallel Port Mode	: ECP+EPP
IDE Primary Slave PIO	: Auto	ECP Mode Use DMA ⁺	: 3
IDE Secondary Master PIO	: Auto	EPP Mode Select ⁺	: EPP1.7
IDE Secondary Slave PIO	: Auto		
IDE Primary Master UDMA	: Auto		
IDE Primary Slave UDMA	: Auto		
IDE Secondary Master UDMA	: Auto		
IDE Secondary Slave UDMA	: Auto		
On-Chip Primary PCI IDE	: Enalbed		
On-Chip Secondary PCI IDE	: Enalbed		
USB Keyboard Support	: Disabled		
KBC Input Clock	: 8 MHz		
Onboard FDC Controller	: Enabled		
Onboard Serial Port 1	: Auto	ESC : Quit	↑ ↓ → ← : Select Item
Onboard Serial Port 2	: Auto	F1 : Help	PU/PD/+/- : Modify
UART Mode Select	: IrDA	F5 : Old Values (Shift)F2	: Color
RxD, TxD Active*	: Lo, Lo	F6 : Load BIOS Defaults	
IR Transmission Delay*	: Disabled	F7 : Load Setup Defaults	

*: These options will not be displayed unless ASKIR or IrDA is selected in UART Mode option.

+: These two options will not be displayed unless EPP/ECP function is selected.

2. Use one of the arrow keys to move between options and modify the selected options by using PgUp/PgDn/+/- keys.

A short description of screen options follows:

IDE HDD Block Mode Choose Enabled (default) or Disabled. If your hard disk size is larger than 540MB, choose Enabled, and, if you are using the IDE HDD Auto Detection option, the BIOS will choose this option automatically. (Note: Some HDDs of old models don't provide this feature.)

IDE Primary Master/Slave PIO	Choose Auto (default) or Mode 0~4. The BIOS will detect the HDD Mode type automatically when you choose Auto. You need to set to a lower mode than Auto when your hard disk becomes unstable.
IDE Secondary Master/Slave PIO	
On-Chip Primary/Secondary PCI IDE	Enabled: (default) Turn on the onboard IDE function. Disabled: Turn off the onboard IDE function.
USB Keyboard Support	Enabled: Enables function when the USB keyboard is being used. Disabled: (default) When the AT keyboard be used.
KBC Input Clock	Choose 6MHz, 8MHz (default), 12MHz, or 16MHz. There might be a compatible problem when is above 8MHz.
Onboard FDC Controller	Choose Enabled (default) or Disabled. Choose Disabled when you use an ISA card with FDD function, or , choose Enabled to use the onboard FDD connector.
Onboard Serial Port 1	Choose Auto (default), 3F8/IRQ4 , 2F8/IRQ3, 3E8/IRQ4, 2E8/IRQ3, or Disabled. Do no set port 1 & 2 to the same value except for Disabled.
Onboard Serial Port 2	Choose Auto (default), 3F8/IRQ4 , 2F8/IRQ3, 3E8/IRQ4, 2E8/IRQ3, or Disabled.
UART Mode Select	Choose Normal (default), IrDA, or ASKIR.

- RxD, TxD Active*** Choose Hi/Hi, Hi/Lo, Lo/Hi, or Lo/Lo (default).
- IR Transmission Delay*** Enabled: Enabled delay when transfers data.
 Disabled: (default) Disabled delay when transfers data.
**: The above 2 options won't work unless UART Mode ASKIR/IrDA is selected.*
- Onboard Parallel Port** Choose the printer I/O address: 378H/IRQ7 (default), 3BCH/IRQ7, 278H/IRQ5
- Parallel Port Mode** Choose SPP (default), ECP + EPP EPP, or ECP mode. The mode depends on your external device that connects to this port.
- ECP Mode Use DMA*** Choose DMA3 (default) or DMA1. Most sound cards use DMA1. Check with your sound card configuration to make sure that there is no conflict with this function.
**: This option will not be displayed unless the EPP/ECP function is selected..*
- EPP Mode Select** Choose EPP1.7 (default) or EPP1.9. EPP1.9 supports hardware handshake. This setting is dependent on your EPP device.
Note: The above 2 options will not be displayed unless the EPP/ECP function is selected.

3. Press <ESC> and follow the screen instructions to save or disregard your settings.

Supervisor/User Password

These two options allow you to set your system passwords. Normally, supervisor has a higher right to change the CMOS setup option than the user. The way to set up the passwords for both Supervisor and User are as follows:

1. Choose "Change Password" in the Main Menu and press <Enter>. The following message appears:

"Enter Password: "

2. The first time you run this option, enter your password up to only 8 characters and press <Enter>. The screen does not display the entered characters.
3. After you enter the password, the following message appears prompting you to confirm the password:

"Confirm Password: "

4. Enter exactly the same password you just typed again to confirm the password and press <Enter>.
5. Move the cursor to Save & Exit Setup to save the password.
6. If you need to delete the password you entered before, choose the Supervisor Password and press <Enter>. It will delete the password that you had before.
7. Move the cursor to Save & Exit Setup to save the option you did, otherwise the old password will still be there when you turn on your machine next time.
8. Press <ESC> to exit to the Main Menu.

Note: *If you forget or lose the password, the only way to access the system is to clear the CMOS RAM by setting JBAT1. All setup information will be lost and you need to run the BIOS setup program again.*

IDE HDD Auto Detection

IDE HDD Auto Detection detects the parameters of an IDE hard disk drive and automatically enters them to the Standard CMOS Setup screen.

The screen will ask you to select a specific hard disk for Primary Master after you select this option. If you accept a hard disk detected by the BIOS, you can enter "Y" to confirm and then press <Enter> to check next hard disk. This function allows you to check four hard disks and you may press the <ESC> after the <Enter> to skip this function and go back to the Main Menu.

Save & Exit Setup

Save & Exit Setup allows you to save all modifications you have specified into the CMOS memory. Highlight this option on the Main Menu and the following message appears:

```
SAVE to CMOS and EXIT (Y/N)? Y
```

Press <Enter> key to save the configuration changes.

Exit Without Saving

Exit Without Saving allows you to exit the Setup utility without saving the modifications that you have specified. Highlight this option on the Main Menu and the following message appears:

```
Quit Without Saving (Y/N)? N
```

You may change the prompt to "Y" and press <Enter> key to leave this option.