



Notice to End Users

This User's Guide & Technical Reference is for assisting system manufacturers and end users in setting up and installing the mainboard.

Every effort has been made to ensure that the information in this manual is accurate. Soltek Computer Inc. is not responsible for printing or clerical errors. Information in this document is subject to change without notice and does not represent a commitment on the part of Soltek Computer Inc.

Companies and products mentioned in this manual are for identification purposes only. Product names appearing in this manual may or may not be registered trademarks or copyrights of their respective companies.

SOLTEK COMPANY INC. PROVIDES THIS MANUAL "ASIS" WITHOUT WARRANTY OF ANY KIND, EITHER EXPRESS OR IMPLIED, INCLUDING BUT NOT LIMITED TO THE IMPLIED WARRANTIES OR CONDITIONS OF MERCHANTABILITY OR FITNESS FOR A PARTICULAR PURPOSE. IN NO EVENT SHALL SOLTEK COMPUTER INC. BE LIABLE FOR ANY LOSS OR PROFITS, LOSS OF BUSINESS, LOSS OF USE OR DATA, INTERRUPTION OF BUSINESS, OR FOR INDIRECT, SPECIAL, INCIDENTAL, OR CONSEQUENTIAL DAMAGES OF ANY KIND, EVEN IF SOLTEK COMPUTER INC. HAS BEEN ADVISED OF THE POSSIBILITY OF SUCH DAMAGES ARISING FROM ANY DEFECT OR ERROR IN THIS MANUAL OR PRODUCT.

(C)Copyright 1999 Soltek Computer Inc. All rights reserved

WebSite http ://www.soltek.com.tw
E-Mail :support@soltek.com.tw

Edition :August 1999
Version :1.0

SL-67G60E, SL-67G64E SERIALS

CONTENT

CHAPTER 1 INTRODUCTION.....	6
■ FEATURES	6
1-1 CPU	6
1-2 CHIPSET	6
1-3 L2 CACHE.....	6
1-4 MAIN MEMORY	7
1-5 BIOS	7
1-6 SUPER I/O FUNCTION	7
1-7 AC '97 CODEC FUNCTION	8
1-8 VGA FUNCTIONS	8
1-9 OTHER FUNCTIONS	9
1-10 MAINBOARD LAYOUT WITH DEFAULT SETTINGS	10
CHAPTER 2 HARDWARE SETUP	11
2-1 CPU TYPE CONFIGURATION.....	11
2-2 JUMPER SETTINGS	13
#FA1: Onboard FAN(12V) Connector	13
J2 Switch Signal Summary.....	14
J3 Switch Signal Summary.....	15
JP2/JP3: Line Out/Speaker Out.....	17
JP4: AMR Setting.....	17
JP6/JP21: CPU Host Clock Select.....	17
JP14: BIOS Boot Block Lock.....	17
JP15: Clear CMOS Data.....	18
JP16/JP18: Onboard Sound Chip (AC'97 Codec).....	18
JKB1: Keyboard Power On Function.....	18
RT2: Thermal Sensor Connector.....	18
CD1/CD2: CD-ROM Audio Connector.....	19
GAME / MIDI port:.....	19
Mic: Microphone Jack.....	19
Line in: Audio in Jack	19
Line Out / Speaker Out: Audio out Jack.....	19
JWOL1: Wake On LAN (WOL) Connector	19
DRIVERS AND SOFTWARES SETUP PROCESS	20
Flash Memory Programming Procedures.....	20
Intel Chipsets INF driver.....	20
Onboard VGA driver.....	21

<i>Onboard Intel AC97 Audio Codec driver</i>	21
CHAPTER 3 AWARD BIOS SETUP	23
■ MAIN MENU	23
■ STANDARD CMOS SETUP	24
MAIN MENU SELECTIONS	25
IDE ADAPTERS	26
■ ADVANCED BIOS FEATURES	27
VIRUS WARNING	28
CPU INTERNAL CACHE/EXTERNAL CACHE	28
CPU L2 CACHE ECC CHECKING	28
QUICK POWER ON SELF TEST	28
FIRST/SECOND/THIRD/OTHER BOOT DEVICE	28
SWAP FLOPPY DRIVE	29
BOOT UP FLOPPY SEEK	29
BOOT UP NUMLOCK STATUS	29
GATE A20 OPTION	29
TYPEMATIC RATE SETTING	29
TYPEMATIC RATE (CHARS/SEC)	29
TYPEMATIC DELAY (MSEC)	30
SECURITY OPTION	30
OS SELECT FOR DRAM > 64MB	30
REPORT NO FDD FOR WIN 95	30
■ ADVANCED CHIPSET FEATURES	31
SDRAM CAS LATENCY TIME	32
SDRAM CYCLE TIME TRAS / TRC	32
SDRAM ADDRESS SETUP TIME	32
SDRAM RAS-TO-CAS DELAY	32
SDRAM RAS PRECHARGE TIME	32
SYSTEM BIOS CACHEABLE	33
VIDEO BIOS CACHEABLE	33
MEMORY HOLE AT 15M-16M	33
DELAY TRANSACTION	33
ON-CHIP VIDEO WINDOW SIZE	33
LOCAL MEMORY FREQUENCY	34
CAS # LATENCY	34
PAGING MODE CONTROL	34

RAS-TO-CAS OVERRIDE.....	34
RAS # TIMING	34
RAS # PRECHARGE TIMING	34
CPU VCORE SELECT	35
■ INTEGRATED PERIPHERALS	36
ON-CHIP PRIMARY / SECONDARY PCI IDE.....	37
IDE PRIMARY / SECONDARY MASTER / SLAVE PIO.....	37
IDE PRIMARY / SECONDARY MASTER / SLAVE UDMA.....	37
USB CONTROLLER.....	37
USB KEYBOARD SUPPORT.....	37
INIT DISPLAY FIRST	37
AC97 AUDIO / MODEM	38
IDE HDD BLOCK MODE	38
KBC INPUT CLOCK.....	38
ONBOARD FDC CONTROLLER.....	38
ONBOARD SERIAL PORT 1/PORT 2	38
UART MODE SELECT.....	38
UR2 DUPLEX MODE.....	39
ONBOARD PARALLEL PORT.....	39
PARALLEL PORT MODE.....	39
ECP MODE USE DMA.....	39
GAME PORT ADDRESS.....	39
MIDI PORT ADDRESS	39
MIDI PORT IRQ	39
■ POWER MANAGEMENT SETUP	40
ACPI FUNCTION	41
POWER MANAGEMENT	41
VIDEO OFF METHOD.....	41
VIDEO OFF IN SUSPEND	41
SUSPEND TYPE	42
MODEM USE IRQ.....	42
SUSPEND MODE.....	42
HDD POWER DOWN.....	42
SOFT-OFF BY PWR-BTTN	42
WAKE-UP BY PCI CARD	42
RESUME BY ALARM.....	42
<i>Reload Global Timer Events</i>	43
PRIMARY IDE 0/1, SECONDARY IDE 0/1	43
FDD, COM, LPT PORT	43

PCI PIRQ [A ~ D]#	43
■ PNP / PCI CONFIGURATION SETUP.....	44
RESET CONFIGURATION DATA.....	45
RESOURCE CONTROLLED BY.....	45
IRQ RESOURCES	45
MEMORY RESOURCES.....	45
PCI / VGA PALETTE SNOOP.....	45
■ PC HEALTH STATUS	46
■ FREQUENCY / VOLTAGE CONTROL.....	47
AUTO DETECT DIMM / PCI CLK.....	47
CPU CLOCK / SPREAD SPECTRUM.....	48
CPU RATIO.....	49
■ LOAD OPTIMIZED DEFAULTS.....	50
■ SET SUPERVISOR / USER PASSWORD.....	51
■ EXIT SELECTING	52
SAVE & EXIT SETUP	52
EXIT WITHOUT SAVING.....	52

Chapter 1

Introduction

■ Features

1-1 CPU

- Support Intel Celeron, Pentium II / Pentium III CPUs using SLOT1 at 300 ~ 700MHz or higher.
- Support CPU voltage auto-detect circuit.

1-2 Chipset

- Intel 82810E chipset (Graphics and Memory Controller Hub)
- PCI Rev 2.2 compliant, 5V, 33MHz PCI operations.
- Supports 66/133MHz, 3.3V AGP (Accelerated Graphics Port) slot at AGP Rev 2.0 compliant.
- Meet PC '99 Requirements.
- Onboard integrated AGP graphics controller.
- AC '97 2.1 compliant link for Audio and Telephony CODECs. (AC '97 2.1 features: Variable sample rate & True line-level output)
- Integrated IDE controller with Ultra ATA 33/66.
- Alert On LAN.

1-3 L2 Cache

- Intel Pentium II / III CPU supports 512K and Celeron CPU supports 128K write back cache with Pipelined Burst SRAMs.

1-4 Main Memory

- Memory range from 8MB(minimum) to 512MB(maximum) SDRAM with DRAM Table Free configurations.
- Up to 2 double side DIMM module that support 16MB, 32MB, 64MB, 128MB, 256MB SDRAM technology.
- Supports SDRAM with 12ns/10ns/8ns speed.
- Supports 2pcs 168pin DIMM sockets (**3.3V** Unbuffered and 4 Clock type).
- 4MB VGA SDRAM Display Cache onboard. (67G64E only)

NOTE: The SDRAM must be compatible with PC100 specification.

1-5 BIOS

- Award Plug & Play BIOS.
- Supports Advanced Power Management(APM) function and ACPI(Advanced Configuration and Power Management) function.
- Flash Memory for easy upgrade.
- Select CPU Clock Bus Ratio & CPU Host Clock in the BIOS.
- Supports “Suspend to RAM” function.
- Supports “BIOS Virus Protection” function.
- Supports “CPU Core Voltage Setting” function.

1-6 Super I/O Function

- Integrated USB(Universal Serial Bus) controller with two USB ports.
- Supports 2 IDE channels with 4 IDE devices(including ZIP / LS-120 devices).
- Provides PCI IDE Bus Master function and supports Ultra ATA 33/66 function.
- One floppy port.
- Two high speed 16550 FIFO UART ports.
- One parallel port with EPP/ECP/SPP capabilities.
- PS/2 mouse connector.
- Built-in RTC, CMOS, keyboard controller on single I/O chip.
- Peripherals boot function(with ATX power).

1-7 AC '97 Codec Function

- Full compliant AC '97 analog I/O component.
- Multi-bit Sigma-Delta converter architecture for improved S/N ratio greater than 90dB.
- Full duplex variable 7kHz to 48kHz sampling rate with 1Hz resolution.
- Extended 6-bit master volume control.
- Audio amp power down signal.
- Split power supplies. (3.3V Digital / 5V Analog)
- 3D stereo enhancement.
- Digital audio mixer mode.
- 16-bit stereo Full-Duplex Codec.
- Four analog line-level stereo inputs for connection from LINE, CD, VIDEO and AUX; Two analog line-level inputs for speakerphone and PC BEEP.
- Stereo line-level output & mono output for speakerphone.
- High quality CD input with ground sense.
- Power Management support.

1-8 VGA Functions

- Integrated 2D & 3D Graphics Engine.
- 64-bit System Memory Interface with optimized support for SDRAM at 100MHz.
- Integrated 24-bit 230MHz RAMDAC.
- Up to 1600 x 1200 in 8-bit color at 85Hz refresh in 2D graphics.
- 4MB Display Cache. (67G64E only)

1-9 Other Functions

- ATX size 17cm x 30.5cm
- 5pcs PCI Master slots(67G60E/64E), 1 Audio Modem Riser(AMR) slot.
- Supports SCSI/CD-ROM/ZIP/LS-120 Boot up function.
- Supports jumperless setting.
- Supports 66/75/83/95/100/112/117/124/133/138/140/150 MHz Bus Clock (from BIOS).
- Supports Wake On LAN(WOL)* function.
- Supports keyboard power on function.

* : For support WOL, the ATX power supply must have at least **5V/720mA** standby current.

1-10 Mainboard layout with default settings

The mainboard default settings of the following is for the Celeron 300A/66MHz or Pentium II 450/100MHz.

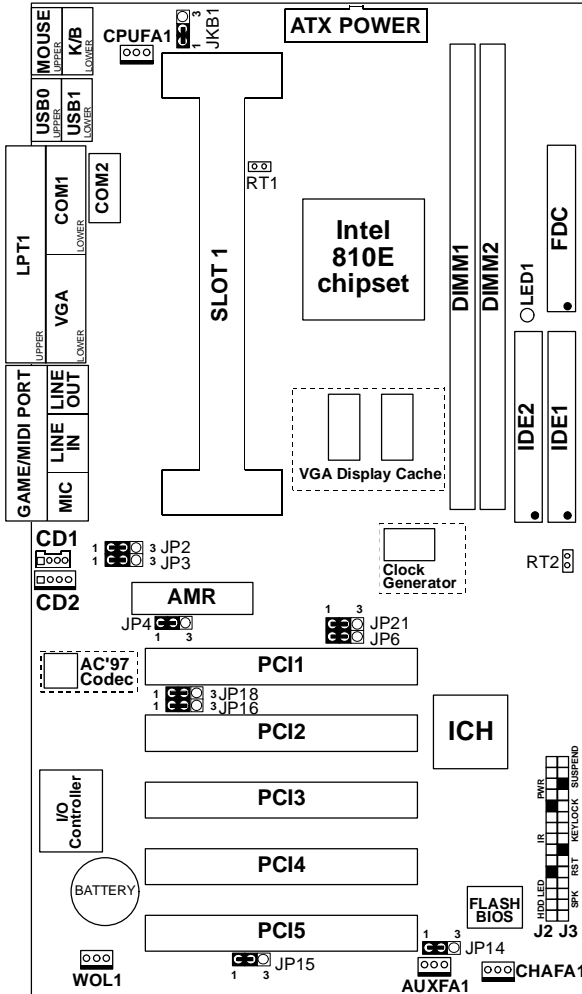

NOTE: For 100/133MHz CPU environment, the SDRAM specification must comply with PC-100 spec.

Chapter 2

HARDWARE SETUP

This mainboard is jumperless for CPU settings, as a result that user can select CPU settings in the Award BIOS program without toggling the jumpers on the mainboard manually. Please refer to the Chapter 3 "Frequency / Voltage Control" sector at page 48 for more descriptions.

2-1 CPU Type Configuration

CMOS Setup Utility - Copyright (C) 1984-1999 Award Software
Frequency/Voltage Control

Auto Detect DIMM/PCI Clk Disabled CPU Clock/Spread Spectrum Default CPU Ratio X 3	Item Help <hr/> Menu Level
<div style="border: 1px solid black; padding: 10px; margin: 0 auto; width: 80%;"> <p>CPU Clock/Spread Spectrum</p> <p>95MHz/Off -----[<input checked="" type="checkbox"/>] 138MHz/Off -----[] 100MHz/Off -----[] 140MHz/On -----[] 100MHz/On -----[] 150MHz/Off -----[] 112MHz/On -----[] 117MHz/On -----[] 124MHz/Off -----[] 133MHz/Off -----[] 133MHz/On -----[]</p> <p style="text-align: center;">:Move ENTER:Accept ESC:Abort</p> </div>	
<p style="text-align: center;">Move Enter:Select +/-/PU/PD:Value F10:Save ESC:Exit</p> <p>F1:General Help F5:Previous Values F6:Fail-Safe Defaults</p> <p>F7:Optimized Defaults</p>	

BIOS Setup Screen 2-1

CMOS Setup Utility - Copyright (C) 1984-1999 Award Software
Frequency/Voltage Control

Auto Detect DIMM/PCI Clk	Disabled	Item Help
CPU Clock/Spread Spectrum	Default	Menu Level
CPU Ratio	X 3	

CPU Ratio

X 3	-----[■]	X 7	-----[]
X 3.5	-----[]	X 7.5	-----[]
X 4	-----[]	X 8	-----[]
X 4.5	-----[]		
X 5	-----[]		
X 5.5	-----[]		
X 6	-----[]		
X 6.5	-----[]		

:Move ENTER:Accept ESC:Abort

Move Enter:Select +/-/PU/PD:Value F10:Save ESC:Exit
F1:General Help F5:Previous Values F6:Fail-Safe Defaults
F7:Optimized Defaults

BIOS Setup Screen 2-2

⚠ WATCH OUT!!

1. Please refer to your processor installation or other documentation attached with your CPU for detailed installing instruction.
2. Installing a heat sink and cooling fan is necessary for proper heat dissipation from your CPU. Uncorrected installation may result in overheating and damage of your CPU.
3. Before changing the setting of CPU Vcore from BIOS program, user SHOULD make sure of correct specification both of CPU CLOCK and RATIO. Uncorrected setting may cause damage to your CPU.

CPU CLOCK / RATIO SELECT LIST

BIOS Setup "Frequency / Voltage Control"		
CPU Model	CPU Clock/Speed	CPU Ratio
Celeron 300A/66 Pentium II / III 450/100	 <p style="text-align: center;">66/100/133MHz Auto Select</p>	4.5 x
Celeron 333/66 Pentium II / III 500/100		5.0 x
Celeron 366/66 Pentium II / III 550/100		5.5 x
Celeron 400/66 Pentium II / III 600/100		6.0 x
Celeron 433/66 Pentium II / III 650/100		6.5 x
Celeron 466/66		7.0 x
Celeron 500/66		7.5 x
Celeron 533/66		8.0 x

NOTE: This Intel 82810E mainboard supports 168pin DIMM of 16MB, 32MB, 64MB, 128MB and 256MB to form a memory size between 8MB to 512MB(SDRAM). Intel 82810E chipsets provides "Table-Free" function, but do remember that the DRAM must be **3.3V Unbuffered and 4-clock type**.

2-2 Jumper Settings

#FA1: Onboard FAN(12V) Connector

#FA1	Function
CPUFA1	CPU FAN
AUXFA1	POWER FAN
CHAFA1	CHASSIS FAN

J2 Switch Signal Summary

<i>J2</i>	<i>Pin</i>	<i>Signal Description</i>
HDD LED Connector	1	+5V
	2	HDD LED Signal
	3	HDD LED Signal
	4	+5V
N.C.	5	No Connection
Infrared Connector	6	Infrared Transmit Signal
	7	GND
	8	Infrared Receive Signal (low speed)
	9	No Connection
	10	+5V
N.C.	11	No Connection
ATX Power Switch	12	ATX Power Switch
	13	GND
N.C.	14	No Connection
	15	No Connection

J2 pin1 ~ pin4: IDE LED Activity Light

This connector connects to the hard disk activity indicator light on the case.

J2 pin6 ~ pin10: Infrared Port Module Connector

The system board provides a 5-pin infrared connector-R1 for an optional wireless transmitting and receiving module. Pin 6 through pin 10 are Transmit, GND, Receive (low speed), Receive (high speed), and Vcc, respectively.

J2 pin12, pin13: ATX Power Switch

Toggle this pin for turning on/off the ATX Power Supply.

J3 Switch Signal Summary

<i>J3</i>	<i>Pin</i>	<i>Signal Description</i>
Speaker Connector	1	Speaker Signal
	2	No Connection
	3	GND
	4	+5V
Reset Switch	5	Reset Signal
	6	GND
N.C.	7	No Connection
Power LED Connector	8	+5V
	9	No Connection
	10	GND
Keylock Connector	11	Keylock Signal
	12	GND
N.C.	13	No Connection
Suspend LED	14	Suspend LED Connector
	15	+5V

J3 pin1 ~ pin4: Speaker Connector

The speaker connector is a 4-pin connector for connecting the system and the speaker.

J3 pin5, pin6: Reset Switch

The system board has a 2-pin connector for rebooting your computer without having to turn off your power switch. This prolongs the life of the system's power supply.

J3 pin8 ~ pin12: Power LED and Keylock Switch

The keylock switch is a 5-pin connector for locking the keyboard for security purposes. (See the following drawing for jumper position, and pin8 ~ pin10 is connected to power LED and pin11 ~ pin12 is connected to keylock switch.)

J3 pin14 ~ pin15: Suspend LED

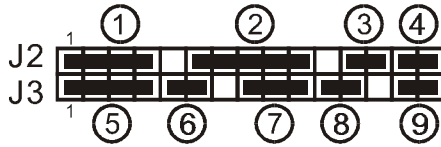

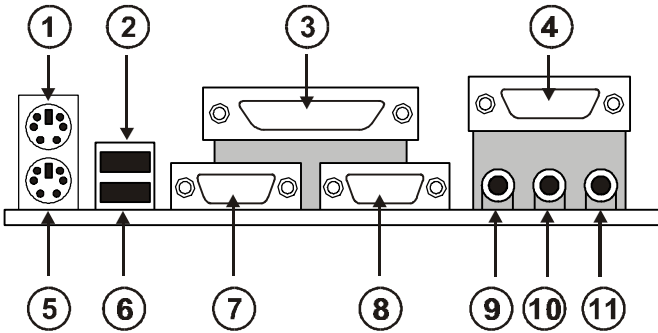

- | | |
|------------------|-------------------|
| ① : HDD LED | ② : INFRARED (IR) |
| ③ : POWER SWITCH | ④ : No Connection |
| ⑤ : SPEAKER | ⑥ : RESET SWITCH |
| ⑦ : POWER LED | ⑧ : KEYLOCK |
| ⑨ : SUSPEND LED | |





- | | |
|-------------------|--------------------|
| ① : PS/2 mouse | ② : USB0 |
| ③ : LPT port | ④ : GAME/MIDI port |
| ⑤ : PS/2 keyboard | ⑥ : USB1 |
| ⑦ : COM1 | ⑧ : VGA port |
| ⑨ : Line Out | ⑩ : Line In |
| ⑪ : MIC | |

JP2/JP3: Line Out/Speaker Out

Those jumpers control Line out or Speaker out.



<i>Status</i>	<i>JP2/JP3</i>
Line out	 ○ ●● JP2 ○ ●● JP3 1 3
Speaker out (default)	 ●●○ JP2 ●●○ JP3 1 3

JP4: AMR Setting

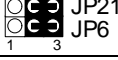

<i>Status</i>	<i>JP4</i>
Set AMR as secondary device (default)	 ●●○ 1 3
Set AMR as primary device	 ○●● 1 3

JP6/JP21: CPU Host Clock Select

These jumpers allow user to control CPU Host Clock.



<i>Auto Select</i>	<i>JP6/JP21</i>
100MHz	 ●●○ JP21 ○●● JP6 1 3
133MHz	 ○●● JP21 ○●● JP6 1 3
66/100/133MHz Auto Select (default)	 ●●○ JP21 ○●● JP6 1 3

JP14: BIOS Boot Block Lock

<i>Boot Block</i>	<i>JP14</i>
Unlocked(default)	 ●●○ 1 3
Locked	 ○●● 1 3

JP15: Clear CMOS Data



Clear the CMOS memory by shorting this jumper 2 & 3 momentarily, and then remove the cap back to 1 & 2 to retain original setting.

<i>CMOS data</i>	<i>JP15</i>
Clear Data	
Retain Data (default)	



NOTE: After updated newer BIOS version, user must set JP15 to clear CMOS data. For more update BIOS information, please refer to Page 20.

JP16/JP18: Onboard Sound Chip (AC'97 Codec)

This jumper allows user to control onboard sound chip function. "Enabled" uses onboard sound chip(AC'97 Codec)

<i>AC '97 Codec</i>	<i>JP16/JP18</i>
Disabled	
Enabled (default)	

JKB1: Keyboard Power On Function

<i>Keyboard Power On</i>	<i>JKB1</i>
Enable	
Disable(default)	

RT2: Thermal Sensor Connector

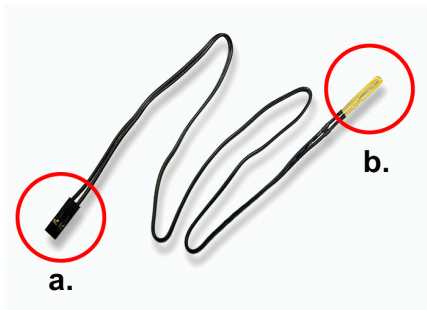

- a. : Connect to RT2.
- b. : Connect this thermal sensor to some device which generates heat such as Hard Disk, VGA chip etc. When connected, user could watch the temperature change from the BIOS program.

CD1/CD2: CD-ROM Audio Connector

Connect CD1 & CD2 to the CD-ROM Audio Connector.

GAME / MIDI port:

Connect the joystick or MIDI to this connector.

Mic: Microphone Jack

Connect to microphone device.

Line in: Audio in Jack

Control Audio line in.

Line Out / Speaker Out: Audio out Jack

Control speaker out or line out.

JWOL1: Wake On LAN (WOL) Connector

This connector is designed to use LAN to boot up the system. Connect the wake on signal from LAN card to this connector.

Drivers and Softwares setup process

Flash Memory Programming Procedures

- 1. Please be sure that JP14 is set to 1-2 short first.**
2. Download BIOS files and flash utility from your board vendor. They are: awdf flash.exe and .bin file.
3. Copy them to bootable diskette and boot from diskette.
4. The diskette does not include memory manager e.g. emm386.exe, qemmm or himem.sys
5. Type "awdf flash filename(XXXX.bin)".
6. Next screen will ask you save current bios to file or not? Depend on your diskette capacity, choose Y or N for this option.
7. Then screen asks you programming the flash memory now? type Y for this option.
8. Programming finish, utility will ask you reboot system. In this step, please shut down the system.
9. Clear CMOS data. Please refer to Page 18 "**JP15: Clear CMOS Data**" for the process.
10. Boot up system and press DEL key enter bios setup screen.
11. Select LOAD SETUP DEFAULTS, press ENTER, press Y,press F10,press Y
12. Finish update procedure.

NOTE: Before update the BIOS Flash Memory, user must confirm the **Flash Utility V7.20** version.

Intel Chipsets INF driver

1. "Start"-->"Program"-->"Windows Explorer".
2. Change directory to CD label, we suggest the CD label is **D:**
3. Go to and run **D:\Driver\Intel\810_2INF\Setup.exe**
4. The setup window will appear "**INF for Intel® 810, Intel® 820 Chipsets**" process.
5. The default setup directory is **C:\Program Files\Intel\Ntel\INF**.
When installation is finished, restart your system.

***User must install **Intel Chipsets INF driver** after installed Windows95/98. ***

If user's O.S. is Windows 98 Second Edition, then user can skip "Intel Chipsets INF driver" sector.

Onboard VGA driver

For Windows 95/98:

1. "Start"-->"Program"-->"Windows Explorer".
2. Change directory to CD label, we suggest the CD label is **D:**
3. Go to and run **D:\Driver\Intel\vga\Win9xcd(or Winnt4cd, only Windows NT 4.0)\Graphics\Setup.exe**
4. The setup window will appear "**Intel® 810 Chipset Graphics Driver Software**" process.
5. The default setup directory is **C:\Program Files\Intel\GfxDrvEUD**.
6. When installation is finished, restart your system.

Onboard Intel AC97 Audio Codec driver

For Windows 95:

1. Be sure that the CD is in the CD-ROM.
2. Change directory to CD label, we suggest the CD label is **D:**
3. Run **D:\Driver\Audio\Intel AC97Win95\SETUP.EXE**.
4. Then Windows95 will finish the left process and find new device: "**SoundMAX AC'97 Audio Device**"
5. Restart your system.

For Windows 98&2000:

1. Be sure that the CD is in the CD-ROM.
2. Change directory to CD label, we suggest the CD label is **D:**
3. Run **D:\Driver\Audio\Intel AC97Win98&2000\SETUP.EXE**.
4. Then Windows98 will finish the left process and find new device: "**SoundMAX AC'97 Audio Device**"
5. Restart your system.

NOTE: If user wants to use external sound card, then user must **DISABLE** “AC97 Audio”, “Game Port Address” and “MIDI Port Address” Option in the BIOS “Integrated Peripherals”.

NOTE: Before you setup any driver, you can check your device information in:

1. “Start”-->“Settings”-->“System”-->“Device Manager”.
2. In the “Device Manager”, you will find out there are three unknown devices describe:

① ?PCI Card Refer to “Appendix-1”
② ?PCI Multimedia Audio Device Refer to “Intel AC '97 Audio driver”
③ ?PCI System Management Bus Refer to “VGA driver”

After your setup finished, the three unknown devices will disappear from “Device Manager”.

■ Appendix-1

When “?PCI Card” appears, that means “**AC '97 MODEM**” function is “**ENABLED**” from BIOS program “**Integrated Peripherals**” sector, if user doesn't use this function, it's better for user to “**DISABLED**” with it.

■ Appendix-2

NOTE !! IF USER'S HARD DISK SUPPORTS UDMA/66, THEN USER MUST USE SPECIFIC CABLE FOR UDMA/66 TO GET THE BEST TRANSMISSION!!

Chapter 3

AWARD BIOS SETUP

■ Main Menu

Once you enter the AwardBIOS™CMOS Setup Utility, the Main Menu will appear on the screen. The Main Menu allows you to select from several setup functions and two exit choices. Use the arrow keys to select among the items and press <Enter> to accept and enter the sub-menu.

CMOS Setup Utility - Copyright (C) 1984-1999 Award Software

Standard CMOS Features	Frequency/Voltage Control
Advanced BIOS Features	Load Optimized Defaults
Advanced Chipset Features	Set Supervisor Password
Integrated Peripherals	Set User Password
Power Management Setup	Save & Exit Setup
PnP/PCI Configuration	Exit Without Saving
PC Health Status	
Esc : Quit	
F10 : Save & Exit Setup	
AT Clock, DRAM timings...	

Note that a brief description of each highlighted selection appears at the bottom of the screen.

■ Standard CMOS Setup

The items in Standard CMOS Setup Menu are divided into 10 categories. Each category includes no, one or more than one setup items. Use the arrow keys to highlight the item and then use the <PgUp> or <PgDn> keys to select the value you want in each item.

CMOS Setup Utility - Copyright (C) 1984-1999 Award Software
Standard CMOS Features

Date (mm:dd:yy)	Wed, Apr 21 1999	Item Help
Time (hh:mm:ss)	15 : 25 : 30	
IDE Primary Master	Press Enter None	Change the day, month, year and century
IDE Primary Slave	Press Enter None	
IDE Secondary Master	Press Enter None	
IDE Secondary Slave	Press Enter None	
Drive A	1.44M, 3.5 in	
Drive B	None	
Video	EGA/VGA	
Halt On	All Errors	
Base Memory	640K	
Extended Memory	63488K	
Total Memory	64512K	
Move Enter:Select +/-/PU/PD:Value F10:Save ESC:Exit F1:General Help F5:Previous Values F6:Fail-Safe Defaults F7:Optimized Defaults		

Figure 1: The Main Menu

Main Menu Selections

CMOS Setup Utility - Copyright (C) 1984-1999 Award Software
Standard CMOS Features

Date (mm:dd:yy)	Wed, Apr 21 1999	Item Help
Time (hh:mm:ss)	15 : 25 : 30	
IDE Primary Master	Press Enter None	Change the day, month, year and century
IDE Primary Slave	Press Enter None	
IDE Secondary Master	Press Enter None	
IDE Secondary Slave	Press Enter None	
Drive A	1.44M, 3.5 in	
Drive B	None	
Video	EGA/VGA	
Halt On	All Errors	
Base Memory	640K	
Extended Memory	63488K	
Total Memory	64512K	
Move Enter:Select +/-/PU/PD:Value F10:Save ESC:Exit F1:General Help F5:Previous Values F6:Fail-Safe Defaults F7:Optimized Defaults		

This table shows the selections that you can make on the Main Menu.

Item	Options	Description
Date	Mm:dd:yy	Set the system date. Note that the 'Day' automatically change when you set the date.
Time	hh: mm:ss	Set the system time
IDE Primary Master	Options are in its sub menu (described below)	Press <Enter> to enter the sub menu of detailed options
IDE Primary Slave		
IDE Secondary Master		
IDE Secondary Slave		

IDE Adapters

The IDE adapters control the hard disk drive. Use a separate sub menu to configure each hard disk drive.

Use the legend keys to navigate through this menu and exit to the main menu. Use below table to configure the hard disk.

<i>Item</i>	<i>Options</i>	<i>Description</i>
IDE HDD Auto-Detection	Press <Enter>	Press <Enter> to auto-detect the HDD on this channel. If detection is successful, it fills the remaining fields on this menu.
IDE Primary Master	None Auto Manual	Selecting 'manual' lets you set the remaining fields on this screen. Selects the type of fixed disk. "User Type" will let you select the number of cylinders, heads, etc. NOTE: PRECOMP=65535 means NONE!
Capacity	Auto Display your disk drive size	Disk drive capacity (Approximated). Note that this size is usually slightly greater than the size of a formatted disk given by a disk checking program.
Access Mode	Normal LBA Large Auto	Choose the access mode for this hard disk.
The following options are selectable only if the 'IDE Primary Master' item is set to 'Manual'.		
Cylinder	Min=0 Max=65535	Set the number of cylinders for this hard disk.
Head	Min=0 Max=255	Set the number of read/write heads.
Precomp	Min=0 Max=65535	**** Warning: Setting a value of 65535 means no hard disk.
Landing zone	Min=0 Max=65535	****
Sector	Min=0 Max=255	Numbers of sectors per track.

■ Advanced BIOS Features

This section allows you to configure your system for basic operation. You have the opportunity to select the system's default speed, boot-up sequence, keyboard operation, shadowing and security.

CMOS Setup Utility - Copyright (C) 1984-1999 Award Software
Advanced BIOS Features

Virus Warning	Disabled	<p>Item Help</p> <p>Menu Level</p> <p>Allows you to choose the VIRUS warning feature for IDE Hard Disk boot sector protection. If this function is enabled and someone attempts to write data into this area, BIOS will show a warning message on screen and alarm beep.</p>
CPU Internal Cache	Enabled	
External Cache	Enabled	
CPU L2 Cache ECC Checking	Enabled	
Quick Power On Self Test	Enabled	
First Boot Device	Floppy	
Second Boot Device	HDD-0	
Third Boot Device	LS/ZIP	
Boot Other Device	Enabled	
Swap Floppy Drive	Disabled	
Boot Up Floppy Seek	Disabled	
Boot Up NumLock Status	Off	
Gate A20 Option	Fast	
Typematic Rate Setting	Disabled	
Typematic Rate(Char/Sec)	6	
Typematic Delay(Msec)	250	
Security Option	Setup	
OS Select For DRAM > 64MB	Non-OS2	
Report No FDD For Win95	No	
<p>Move Enter:Select +/-/PU/PD:Value F10:Save ESC:Exit</p> <p>F1:General Help F5:Previous Values F6:Fail-Safe Defaults</p> <p>F7:Optimized Defaults</p>		

Virus Warning

Allows you to choose the VIRUS Warning feature for IDE Hard Disk boot sector protection. If this function is enabled and someone attempts to write data into this area, BIOS will show a warning message on screen and alarm beep.

The Choice:

Disabled --- Activates automatically when the system boots up causing a warning message to appear when anything attempts to access the boot sector or hard disk partition table.

Enabled --- No warning message will appear when anything attempts to access the boot sector or hard disk partition table.

CPU Internal Cache/External Cache

These two categories speed up memory access. However, it depends on CPU/chipset design.

The Choice: Disabled, Enabled

CPU L2 Cache ECC Checking

This item allows you to enable/disable CPU L2 Cache ECC checking.

The Choice: Disabled, Enabled

Quick Power On Self Test

This category speeds up Power On Self Test (POST) after you power up the computer. If it is set to Enable, BIOS will shorten or skip some check items during POST.

The Choice: Disabled, Enabled

First/Second/Third/Other Boot Device

The BIOS attempts to load the operating system from the devices in the sequence selected in these items.

The Choice: Floppy, LS/ZIP, HDD, SCSI, CDROM, LAN, and Disabled.

Swap Floppy Drive

If the system has two floppy drives, you can swap the logical drive name assignments.

The choice: Enabled, Disabled.

Boot Up Floppy Seek

Seeks disk drives during boot up. Disabling speeds boot up.

The choice: Enabled, Disabled.

Boot Up NumLock Status

Select power on state for NumLock.

The choice: Enabled, Disabled.

Gate A20 Option

Select if chipset or keyboard controller should control GateA20.

The Choice:

Normal --- A pin in the keyboard controller controls Gate A20.

Fast --- Lets chipset control Gate A20.

Typematic Rate Setting

Key strokes repeat at a rate determined by the keyboard controller. When enabled, the typematic rate and typematic delay can be selected.

The choice: Enabled, Disabled.

Typematic Rate (Chars/Sec)

Sets the number of times a second to repeat a key stroke when you hold the key down.

The choice: 6, 8, 10, 12, 15, 20, 24, 30.

Typematic Delay (Msec)

Sets the delay time after the key is held down before it begins to repeat the keystroke.

The choice: 250, 500, 750, 1000.

Security Option

Select whether the password is required every time the system boots or only when you enter setup.

The Choice:

System --- The system will not boot and access to Setup will be denied if the correct password is not entered at the prompt.

Setup --- The system will boot, but access to Setup will be denied if the correct password is not entered at the prompt.

NOTE: To disable security, select PASSWORD SETTING at Main Menu and then you will be asked to enter password. Do not type anything and just press <Enter>, it will disable security. Once the security is disabled, the system will boot and you can enter Setup freely.

OS Select For DRAM > 64MB

Select the operating system that is running with greater than 64MB of RAM on the system.

The choice: Non-OS2, OS2.

Report No FDD For WIN 95

Whether report no FDD for Windows 95 or not.

The choice: Yes, No.

■ Advanced Chipset Features

This section allows you to configure the system based on the specific features of the installed chipset. This chipset manages bus speeds and access to system memory resources, such as DRAM and the external cache. It also coordinates communications between the conventional ISA bus and the PCI bus. It must be stated that these items should never need to be altered. The default settings have been chosen because they provide the best operating conditions for your system. The only time you might consider making any changes would be if you discovered that data was being lost while using your system.

CMOS Setup Utility - Copyright (C) 1984-1999 Award Software
Advanced Chipset Features

SDRAM CAS Latency Time	3	Item Help
SDRAM Cycle Time Tras/Trc	5/7	Menu Level
SDRAM RAS-to-CAS Delay	3	
SDRAM RAS Precharge Time	3	
System BIOS Cacheable	Disabled	
Video BIOS Cacheable	Disabled	
Memory Hole At 15M-16M	Disabled	
Delayed Transaction	Disabled	
On-Chip Video Window Size	64MB	
Local Memory Frequency	100 MHz	
* Onboard Display Cache Setting *		
CAS# Latency	3	
Paging Mode Control	Close	
RAS-to-CAS Override	By CAS# LT	
RAS# Timing	Slow	
RAS# Precharge Timing	Slow	
CPU Vcore Select	Default	
Move Enter:Select +/-/PU/PD:Value F10:Save ESC:Exit F1:General Help F5:Previous Values F6:Fail-Safe Defaults F7:Optimized Defaults		

DRAM Settings

The first chipset settings deal with CPU access to dynamic random access memory (DRAM). The default timings have been carefully chosen and should only be altered if data is being lost. Such a scenario might well occur if your system had mixed speed DRAM chips installed so that greater delays may be required to preserve the integrity of the data held in the slower memory chips.

SDRAM CAS Latency Time

When synchronous DRAM is installed, the number of clock cycles of CAS latency depends on the DRAM timing.

The Choice: 2, 3

SDRAM Cycle Time T_{ras} / T_{rc}

Select the number of SCLKs for an access cycle.

The Choice: 5 / 7, 6 / 8

SDRAM Address Setup Time

This item controls the Address Setup to the SDRAM timing.

The Choice: 1, 2

SDRAM RAS-to-CAS Delay

This field lets you insert a timing delay between the CAS and RAS strobe signals, used when DRAM is written to, read from, or refreshed. *Fast* gives faster performance; and *Slow* gives more stable performance. This field applies only when synchronous DRAM is installed in the system.

The Choice: 2, 3

SDRAM RAS Precharge Time

If an insufficient number of cycles is allowed for the RAS to accumulate its charge before DRAM refresh, the refresh may be incomplete and the DRAM may fail to retain data. *Fast* gives faster performance; and *Slow* gives more

stable performance. This field applies only when synchronous DRAM is installed in the system.

The Choice: 2, 3

System BIOS Cacheable

Selecting *Enabled* allows caching of the system BIOS ROM at F0000h-FFFFFh, resulting in better system performance. However, if any program writes to this memory area, a system error may result.

The choice: Enabled, Disabled.

Video BIOS Cacheable

Select Enabled allows caching of the video BIOS , resulting in better system performance. However, if any program writes to this memory area, a system error may result.

The Choice: Enabled, Disabled.

Memory Hole At 15M-16M

You can reserve this area of system memory for ISA adapter ROM. When this area is reserved, it cannot be cached. The user information of peripherals that need to use this area of system memory usually discusses their memory requirements.

The Choice: Enabled, Disabled.

Delay Transaction

The chipset has an embedded 32-bit posted write buffer to support delay transactions cycles. Select *Enabled* to support compliance with PCI specification version 2.1.

The Choice: Enabled, Disabled.

On-Chip Video Window Size

Select the on-chip video window size for VGA drive use.

The Choice: 32MB, 64MB, Disabled.

Local Memory Frequency

The Choice: 100MHz, 133MHz.

Onboard Display Cache Setting

Setting the onboard display cache timing.

CAS # Latency

Select the local memory clock periods.

The Choice: 2, 3

Paging Mode Control

Select the paging mode control.

The Choice: Close, Open.

RAS-to-CAS Override

Select the display cache clock periods control

The Choice: By CAS# LT, Override (2)

RAS # Timing

This item controls RAS# active to Protegra, and refresh to RAS# active delay (in local memory clocks).

The Choice: Fast, Slow.

RAS # Precharge Timing

This item controls RAS# precharge (in local memory clocks).

The Choice: Fast, Slow.

CPU Vcore Select

The Choice: default, -0.05V, -0.1V, +0.05V, +0.1V, +0.2V, +0.3V, +0.4V.

NOTE: Wrong setting of CPU Vcore may cause damage to CPU. In consequence of such a potential risk, we strongly recommend user to leave DEFAULT setting unless user does comprehend how to set accurate CPU Vcore.

■ Integrated peripherals

CMOS Setup Utility - Copyright (C) 1984-1999 Award Software
Integrated Peripherals

On-Chip Primary	PCI IDE	Enabled	Item Help
On-Chip Secondary	PCI IDE	Enabled	
IDE Primary Master	PIO	Auto	Menu Level
IDE Primary Slave	PIO	Auto	
IDE Secondary Master	PIO	Auto	
IDE Secondary Slave	PIO	Auto	
IDE Primary Master	UDMA	Auto	
IDE Primary Slave	UDMA	Auto	
IDE Secondary Master	UDMA	Auto	
IDE Secondary Slave	UDMA	Auto	
USB Controller		Enabled	
USB Keyboard Support		Disabled	
Init Display First		PCI Slot	
AC97 Audio		Enabled	
AC97 Modem		Disabled	
IDE HDD Block Mode		Enabled	
KBC Input clock		8 MHz	
Power On Function		Password	
KB Power On Password		Enter	
Hot Key Power On		Ctrl-F1	
Onboard FDC Controller		Enabled	
Onboard Serial Port 1		3F8/IRQ4	
Onboard Serial Port 2		2F8/IRQ3	
UART Mode Select		Normal	
UR2 Duplex Mode		Half	
Onboard Parallel Port		378/IRQ7	
Parallel Port Mode		SPP	
ECP Mode Use DMA		3	
Game Port Address		Disabled	
Midi Port Address		Disabled	
Midi Port IRQ		10	
Move Enter:Select +/-/PU/PD:Value F10:Save ESC:Exit			
F1:General Help F5:Previous Values F6:Fail-Safe Defaults			
F7:Optimized Defaults			

On-Chip Primary / Secondary PCI IDE

The integrated peripheral controller contains an IDE interface with support for two IDE channels. Select *Enabled* to activate each channel separately.

The choice: Enabled, Disabled.

IDE Primary / Secondary Master / Slave PIO

The four IDE PIO (Programmed Input/Output) fields let you set a PIO mode (0-4) for each of the four IDE devices that the onboard IDE interface supports. Modes 0 through 4 provide successively increased performance. In Auto mode, the system automatically determines the best mode for each device.

The choice: Auto, Mode 0, Mode 1, Mode 2, Mode 3, Mode 4.

IDE Primary / Secondary Master / Slave UDMA

Ultra DMA 33/66 implementation is possible only if your IDE hard drive supports it and the operating environment includes a DMA driver (Windows 95 OSR2 or a third-party IDE bus master driver). If your hard drive and your system software both support Ultra DMA33/66, select Auto to enable BIOS support.

The Choice: Auto, Disabled.

USB Controller

Select *Enabled* if your system contains a Universal Serial Bus (USB) controller and you have USB peripherals.

The choice: Enabled, Disabled.

USB Keyboard Support

Select *Enabled* if your system contains a Universal Serial Bus (USB) controller and you have a USB keyboard.

The choice: Enabled, Disabled.

Init Display First

This item allows you to decide to active whether PCI Slot or on-chip VGA first.

The choice: PCI Slot, Onboard.

AC97 Audio / Modem

This item allows you to decide to enable/disable the 810 chipset family to support AC97 Audio/Modem.

The choice: Enabled, Disabled.

IDE HDD Block Mode

Block mode is also called block transfer, multiple commands, or multiple sector read/write. If your IDE hard drive supports block mode (most new drives do), select Enabled for automatic detection of the optimal number of block read/writes per sector the drive can support.

The choice: Enabled, Disabled.

KBC Input clock

The choice: 8 MHz, 12 MHz.

Onboard FDC Controller

Select Enabled if your system has a floppy disk controller (FDC) installed on the system board and you wish to use it. If you install and-in FDC or the system has no floppy drive, select Disabled in this field.

The choice: Enabled, Disabled.

Onboard Serial Port 1/Port 2

Select an address and corresponding interrupt for the first and second serial ports.

The choice: 3F8/IRQ4, 2E8/IRQ3, 3E8/IRQ4, 2F8/IRQ3, Disabled, Auto.

UART Mode Select

The Choice: Normal (Default), IrDA, ASKIR or SCR.

UR2 Duplex Mode

Use default setting.

Onboard Parallel Port

The Choice: 378H/IRQ (Default), 3BCH/IRQ7, 278H/IRQ5, Disabled.

Parallel Port Mode

Parallel port mode depends on the external device connects to this port.

The Choice: Normal (Default), ECP/EPP, EPP or ECP mode.

ECP Mode Use DMA

Most sound cards use DMA1, check with your sound card configuration to make sure that there is no conflict with this function.

The Choice: DMA3 (Default), DMA1.

NOTE: THIS OPTION WILL NOT BE DISPLAYED UNLESS THE EPP / ECP FUNCTION IS SELECTED.

Game Port Address

Use factory fault setting.

Midi Port Address

Use factory fault setting.

Midi Port IRQ

Use factory fault setting.

■ Power Management Setup

The Power Management Setup allows you to configure you system to most effectively save energy while operating in a manner consistent with your own style of computer use.

CMOS Setup Utility - Copyright (C) 1984-1999 Award Software
Power Management Setup

ACPI Function	Enabled	Item Help
Power Management	User Define	Menu Level
Video Off Method	DPMS	
Video Off In Suspend	Yes	
Suspend Type	Stop Grant	
MODEM Use IRQ	3	
Suspend Mode	Disabled	
HDD Power Down	Disabled	
Soft-Off by PWR-BTTN	Instant-Off	
Wake-Up by PCI card	Disabled	
Resume by Alarm	Disabled	
Date (of Month) Alarm	0	
Time (hh:mm:ss) Alarm	0 0 0	
** Reload Global Timer Events **		
Primary IDE 0	Disabled	
Primary IDE 1	Disabled	
Secondary IDE 0	Disabled	
Secondary IDE 1	Disabled	
FDD, COM, LPT Port	Disabled	
PCI PIRQ[A-D]#	Disabled	
Move Enter:Select +/-/PU/PD:Value F10:Save ESC:Exit		
F1:General Help F5:Previous Values F6:Fail-Safe Defaults		
F7:Optimized Defaults		

ACPI Function

This item allows you to enable/disable the Advanced Configuration and Power Management (ACPI).

The choice: Enabled, Disabled.

Power Management

This category allows you to select the type (or degree) of power saving and is directly related to the following modes:

The Choice:

User Define --- Allows you to set each mode individually. When not disabled, each of the ranges are from 1 min. to 1 hr. except for HDD Power Down which ranges from 1min. to 15 min. and disable.

Min Saving --- Minimum power management. Doze mode = 1 hr., Standby mode = 1 hr., Suspend mode = 1 hr. and HDD power down = 15 min.

Max Saving --- Maximum power management --- **ONLY AVAILABLE FOR SL CPU's**. Doze mode = 1 min., Standby mode = 1 min., Suspend mode = 1 min. and HDD power down = 1 min.

Video Off Method

This determines the manner in which the monitor is blanked.

The Choice:

V/H SYNC+Blank --- This selection will cause the system to turn off the vertical and horizontal synchronization ports and write blanks to the video buffer.

Blank Screen --- This option only writes blanks to the video buffer.

DPMS --- Initial display power management signaling.

Video Off In Suspend

This determines the manner in which the monitor is blanked.

The choice: Yes, No.

Suspend Type

Select the Suspend Type

The choice: PWRON Suspend, Stop Grant.

MODEM Use IRQ

This determines the IRQ in which the MODEM can use.

The choice: 3, 4, 5, 7, 9, 10, 11, NA.

Suspend Mode

When enabled and after the set time of system inactivity, all devices except the CPU will be shut off.

The Choice: Disabled, 1 min, 2 min, 4 min, 8 min, 12 min, 20 min, 30 min, 40 min, 1 hour.

HDD Power Down

When enabled and after the set time of system inactivity, the hard disk drive will be powered down while all other devices remain active.

The Choice: Disabled, 1 min to 15 min.

Soft-Off by PWR-BTTN

Pressing the power button for more than 4 seconds forces the system to enter the Soft-Off state when the system has "hung."

The choice: Delay 4 Sec, Instant-Off.

Wake-Up by PCI card

The choice: Delay 4 Sec, Instant-Off.

Resume by Alarm

The choice: Disabled, Enabled.

Reload Global Timer Events

Reload Global Timer events are I/O events whose occurrence can prevent the system from entering a power saving mode or can awaken the system from such a mode. In effect, the system remains alert for anything which occurs to a device which is configured as *Enabled*, even when the system is in a power down mode.

Primary IDE 0/1, Secondary IDE 0/1

The Choice: Disabled, Enabled.

FDD, COM, LPT Port

The Choice: Disabled, Enabled.

PCI PIRQ [A ~ D]#

The Choice: Disabled, Enabled.

■ PnP / PCI Configuration Setup

This section describes configuring the PCI bus system. PCI, or **Personal Computer Interconnect**, is a system which allows I/O devices to operate at speeds nearing the speed the CPU itself uses when communicating with its own special components. This section covers some very technical items and it is strongly recommended that only experienced users should make any changes to the default settings.

CMOS Setup Utility - Copyright (C) 1984-1999 Award Software
PnP/PCI Configurations

Reset Configuration Data	Disabled	Item Help
Resources Controlled By	Auto (ESCD)	Menu Level
IRQ Resources	Press Enter	Default is Disabled. Select Enabled to reset Extended System Configuration Data (ESCD) when you exit Setup if you have installed a new add-on and the system reconfiguration has caused such a serious conflict that the OS cannot boot.
PCI/VGA Palette Snoop	Disabled	
Move Enter:Select +/-/PU/PD:Value F10:Save ESC:Exit F1:General Help F5:Previous Values F6:Fail-Safe Defaults F7:Optimized Defaults		

Reset Configuration Data

Normally, you leave this field Disabled. Select Enabled to reset Extended System Configuration Data (ESCD) when you exit Setup if you have installed a new add-on and the system reconfiguration has caused such a serious conflict that the operating system can not boot.

The choice: Enabled, Disabled.

Resource controlled by

The Award Plug and Play BIOS has the capacity to automatically configure all of the boot and Plug and Play compatible devices. However, this capability means absolutely nothing unless you are using a Plug and Play operating system such as Windows®95. If you set this field to "manual" choose specific resources by going into each of the sub menu that follows this field (a sub menu is preceded by a "➤").

The choice: Auto (ESCD), Manual.

IRQ Resources

When resources are controlled manually, assign each system interrupt a type, depending on the type of device using the interrupt.

Memory Resources

This sub menu can let you control the memory resource.

PCI / VGA Palette Snoop

Leave this field at *Disabled*.

The Choice: Enabled, Disabled.

■ PC Health Status

CMOS Setup Utility - Copyright (C) 1984-1999 Award Software
PC Health Status

Voltage0 Voltage1 Voltage2 Voltage3 Voltage4 Voltage5 Voltage6 Voltage7 Voltage battery Temperature1 Temperature2 Temperature3 Fan1 speed Fan2 speed Fan3 speed	Item Help Menu Level
Move Enter:Select +/-/PU/PD:Value F10:Save ESC:Exit F1:General Help F5:Previous Values F6:Fail-Safe Defaults F7:Optimized Defaults	

This sector window only displays the computer's information, there is no any selection for user to change or select.

■ Frequency / Voltage Control

CMOS Setup Utility - Copyright (C) 1984-1999 Award Software
Frequency/Voltage Control

Auto Detect DIMM/PCI Clk	Disabled	Item Help
CPU Clock/Spread Spectrum	Default	Menu Level
CPU Ratio	X 3	
Move Enter:Select +/-/PU/PD:Value F10:Save ESC:Exit F1:General Help F5:Previous Values F6:Fail-Safe Defaults F7:Optimized Defaults		

Auto Detect DIMM / PCI Clk

This item allows you to enable/disable auto detect DIMM/PCI Clock.
The choice: Enabled, Disabled.

CPU Clock / Spread Spectrum

This item allows you to enable/disable the spread spectrum modulate.

CMOS Setup Utility - Copyright (C) 1984-1999 Award Software
Frequency/Voltage Control

Auto Detect DIMM/PCI Clk	Disabled	Item Help
CPU Clock/Spread Spectrum	Default	Menu Level
CPU Ratio	X 3	

CPU Clock/Spread Spectrum

90MHz/Off -----[■] 138MHz/Off-----[]

100MHz/Off-----[] 140MHz/On -----[]

100MHz/On -----[] 150MHz/Off -----[]

112MHz/On -----[]

117MHz/On -----[]

124MHz/Off-----[]

133MHz/Off-----[]

133MHz/On -----[]

:Move ENTER:Accept ESC:Abort

Move Enter:Select	+/-/PU/PD:Value	F10:Save	ESC:Exit
F1:General Help	F5:Previous Values	F6:Fail-Safe Defaults	
F7:Optimized Defaults			

The choice: 90MHz/Off, 100MHz/Off, 100MHz/On, 112MHz/On, 117MHz/On, 124MHz/Off, 133MHz/Off, 133MHz/On, 138MHz/Off, 140MHz/On, 150MHz/Off.

CPU Ratio

This item allows you to select the CPU ratio.

CMOS Setup Utility - Copyright (C) 1984-1999 Award Software
Frequency/Voltage Control

Auto Detect DIMM/PCI Clk	Disabled	Item Help
CPU Clock/Spread Spectrum	Default	Menu Level
CPU Ratio	X 3	

CPU Ratio

X 3 -----[■]	X 7 -----[]
X 3.5-----[]	X 7.5-----[]
X 4 -----[]	X 8 -----[]
X 4.5-----[]	
X 5 -----[]	
X 5.5-----[]	
X 6 -----[]	
X 6.5-----[]	

:Move ENTER:Accept ESC:Abort

Move Enter:Select	+/-/PU/PD:Value	F10:Save	ESC:Exit
F1:General Help	F5:Previous Values	F6:Fail-Safe Defaults	
F7:Optimized Defaults			

The choice: x3, x3.5, x4, x4.5, x5, x5.5, x6, x6.5, x7, x7.5, x8

■ Load Optimized Defaults

Selecting “Defaults” from the main menu shows you two options which are described below

```
CMOS Setup Utility - Copyright (C) 1984-1999 Award Software
```

Standard CMOS Features	Frequency/Voltage Control
Advanced BIOS Features	<u>Load Optimized Defaults</u>
Advanced Chipset Features	Set Supervisor Password
Integrated Peripherals	Set User Password
Power Management	Load Optimized Defaults (Y/N)? ____
PnP/PCI Configurations	Exit Without Saving
PC Health Status	

Esc : Quit
F10 : Save & Exit Setup

AT Clock, DRAM timings...

When you press <Enter> on this item you get a confirmation dialog box with a message similar to:

Pressing 'Y' loads the default values that are factory settings for optimal performance system operations.

■ Set Supervisor / User Password

You can set either supervisor or user password, or both of them. The differences between are:

supervisor password : can enter and change the options of the setup menus.

user password : just can only enter but do not have the right to change the options of the setup menus. When you select this function, the following message will appear at the center of the screen to assist you in creating a password.

ENTER PASSWORD:

Type the password, up to eight characters in length, and press <Enter>. The password typed now will clear any previously entered password from CMOS memory. You will be asked to confirm the password. Type the password again and press <Enter>. You may also press <Esc> to abort the selection and not enter a password.

To disable a password, just press <Enter> when you are prompted to enter the password. A message will confirm the password will be disabled. Once the password is disabled, the system will boot and you can enter Setup freely.

PASSWORD DISABLED.

When a password has been enabled, you will be prompted to enter it every time you try to enter Setup. This prevents an unauthorized person from changing any part of your system configuration.

Additionally, when a password is enabled, you can also require the BIOS to request a password every time your system is rebooted. This would prevent unauthorized use of your computer.

You determine when the password is required within the BIOS Features Setup Menu and its Security option (see Section 3). If the Security option is

set to “System”, the password will be required both at boot and at entry to Setup. If set to “Setup”, prompting only occurs when trying to enter Setup.

■ Exit Selecting

Save & Exit Setup

Pressing <Enter> on this item asks for confirmation:

Save to CMOS and EXIT (Y/N)?

Pressing “Y” stores the selections made in the menus in CMOS – a special section of memory that stays on after you turn your system off. The next time you boot your computer, the BIOS configures your system according to the Setup selections stored in CMOS. After saving the values the system is restarted again.

Exit Without Saving

Pressing <Enter> on this item asks for confirmation:

Quit without saving (Y/N)?

This allows you to exit Setup without storing in CMOS any change. The previous selections remain in effect. This exits the Setup utility and restarts your computer.