

Safety and Regulatory Information

Notice for the USA

FCC Part 15: This equipment has been tested and found to comply with the limits for a class B digital device, pursuant to Part 15 of the FCC Rules. These limits are designed to provide reasonable protection against harmful interference in a residential installation. This equipment generates, uses, and can radiate radio frequency energy and, if not installed and used in accordance with the instructions, may cause harmful interference to radio communications. However, this notice is not a guarantee that interference will not occur in a particular installation.

CAUTION: To comply with the limits for the class B device, pursuant to Part 15 of the FCC Rules, this device must be installed in computer equipment certified to comply with the Class B limits. All cables used to connect the computer and peripherals must be shielded and grounded. Operation with non-certified computers or non-shielded cables may result in interference to radio or television reception.

Any changes or modifications not expressly approved by the grantee of this device could void the user's authority to operate the device.

COPYRIGHT: This publication, including all photographs, illustrations and software, is protected under international copyright laws, with all rights reserved. Neither this manual, nor any of the material contained herein, may be reproduced without the express written consent of the manufacturer.

DISCLAIMER: The information in this document is subject to change without notice. The manufacture makes no representations or warranties with respect to the contents hereof and specifically disclaims any implied warranties of merchantability or fitness for any particular purpose.

TABLE OF CONTENTS

CH1. MOTHERBOARD FEATURE	2
1.1 ABOUT THE MANUAL	3
1.2 SPECIFICATIONS.....	3
1.3 DIFINITION OF BVC3A MODEL.....	5
1.4 POWER OFF CONTROL SOFTWARE	5
1.5 PACKAGING CHECK LIST.....	6
CH2. SETUP GUIDE.....	6
2.1 MOTHERBOARD LAYOUT.....	6
2.2 CONNECTOR & JUMPER REFERENCE CHART	7
2.3 THE SETUP STEPS.....	9
2.3-1 JUMPER & CONNECTOR SETTING	9
2.3-2 MEMORY INSTALLATION.....	19
2.3-3 HOW TO INSTALL THE CPU	22
2.3-4 INSTALLING THE MOTHERBOARD.....	24
2.3-5 INSTALLING THE INTERFACE CARD	25
2.3-6 INSTALLING ACCESSORY CABLES	26
CH3. AWARD BIOS SETUP	28
3.1 THE MAIN MENU.....	30
3.2 STANDARD CMOS SETUP	32
3.3 BIOS FEATURES SETUP.....	34
3.4 CHIPSET FEATURES SETUP.....	39
3.5 POWER MANAGEMENT	42
3.6 PNP / PCI CONFIGURATION SETUP.....	46
3.7 INTEGRATED PERIPHERALS.....	49
3.8 SUPERVISOR PASSWORD & USER PASSWORD	52
3.9 IDE HDD AUTO DETECTION OPTION.....	52
3.10 SAVE AND EXIT SETUP OPTION	53
3.11 EXIT WITHOUT SAVING OPTION	53
CH4. SOFTWARE SETUP	54
4.1 INSTALLING THE IDE BUS MASTER DRIVER.....	54

Chapter 1

Motherboard Feature Introduction

Congratulations on purchasing a BVC3A motherboard, which we are certainly will provide you with years of reliable and stable performance.

Based on the VIA Apollo pro plus chipset, the **BVC3A** comes with a Socket 370 interface and supports Intel Celeron PPGA and Intel FCPGA processors operating at speeds ranging from 300 to 550MHz . An ATX-sized board, the **BVC3A** measures 180mm by 305mm and includes AGP, ISA and PCI expansion slots, as well as three DIMM sockets for the addition of up to 384MB of memory.

The **BVC3A**'s clock generator can operate at speeds of 66, 75, 83 or 150 MHz, and up to 256MB of RAM may be added to each of the board's three DIMM sockets. In addition, the **BVC3A** comes with one AGP, two ISA and five PCI slots for the addition of devices such as graphics adapters, modems and sound cards. One ISA and one PCI slot are shared, meaning you may connect either two ISA and four PCI cards or one ISA and five PCI cards.

The board has a 2MB Award PnP BIOS with enhanced ACPI features. Not only does the BIOS support 120MB ATAPI floppy disk and ZIP disk drives, it also supports multiple boots from IDE, SCSI, CD-ROM and FDD drives. And with Trend's ChipAway AntiVirus protection built into the BIOS, the BVC3A helps ensure your system will remain virus free. The BIOS also comes with system temperature and fan speed detectors and can be configured to generate a warning if user-defined fan speeds or temperatures are exceeded.

Other advanced features include keyboard and mouse power-on, a wake-on LAN header, wake-up alarm support and PC' 99-compliant color-coded connectors. The BVC3A comes with one parallel port, two serial ports, two USB ports, a PS/2 mouse port and a PS/2 keyboard port.

The **BVC3A** motherboard is a high-performance device that offers full functionality at a low cost, and its ease of use and reliability will become evident from the moment you begin to use it.

1.1 ABOUT THE MANUAL

The manual consist of the following chapters:

- CH1. Motherboard features introduction – Introduce the features of **BVC3A** and the checklist of items that are shipped with the package.
- CH2. Setup guide – Let you learn how to install the motherboard and get your system up and running.
- CH3. Award BIOS setup – Configure the BIOS of motherboard for optimum performance.
- CH4. Software setup – Let you learn how to install the software drivers and support programs that are provided with this motherboard.

1.2 SPECIFICATIONS

System Chipset	VIA Apollo Pro-Plus (VT82C693A + VT82C596B) with AGP solution.
Processor	Intel Socket370 PPGA and FCPGA at 300MHz ~ 550MHz
Bus Architecture	AGP/PCI/ISA
Clock Generator	66, 68, 75, 83, 100,112, up to150*Mhz (* Not recommend)
DRAM Modules	168 pin DIMMs x 3. Support 8MB to 768MB SDRAM.

BVC3A

BIOS	2MB Award PnP BIOS with enhanced ACPI feature for PC98 compliance. Supports 120MB ATAPI floppy disk. Supports ZIP disk drive. Supports multi-boot from IDE,SCSI,CD-ROM and FDD. Supports software clock control. Supports Trend TM ChipAway AntiVirus. Supports HDD S.M.A.R.T.
On Board I/O	1 Floppy port (up to 2.88MB, 3 mode floppy supported & LS-120). 2 Serial ports, 1 Parallel port (SPP/EPP/ECP). 2 USB, 1 PS/2 mouse, 1 PS/2 keyboard. 1 IrDA.
On Board IDE Port	Dual Ultra DMA 33/66 IDE ports Supports ATAPI IDE CD-ROM & LS-120.
Expansion slot	1 x 32-bit AGP slot. 5 x 32-bit PCI slots. 2 x 16-bit ISA slots.
I/O Chip	Winbond super I/O W83977TF-AW.
Other Feature	Supports keyboard & mouse power on feature with ATX power. Support Keyboard password power on feature with ATX power. Wake-up On LAN header.
Board Size	ATX form factor Size : 305mm x 180mm (12" x 7.1")

1.3 POWER OFF CONTROL SOFTWARE

The motherboard design supports the software power off Control feature through the SMI code in the BIOS under WIN98/95 operating system environment. It is an ATX form factor, so you should use ATX power supply.

First, connect the power switch cable (provided by the ATX/AT case Supplier) to the connector [PWBT] on the motherboard (Please refer to the following illustration). In the BIOS screen of “POWER MANAGEMENT SETUP”, choose “User Defined”(or min power saving or Max power saving) in “POWER MANAGEMENT” and choose “Yes” in “PM Control by APM”.

Note: BIOS Setup. Please refer the “Chapter 3 Award BIOS Setup”

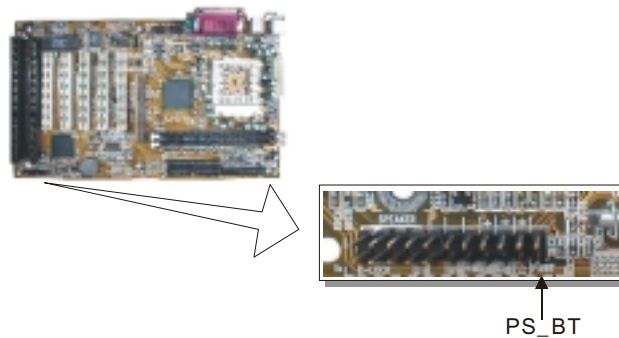

In Windows 98/95, under the “SHUT DOWN” option, the computer’s power will switch off automatically and put the PC in a suspend mode. This will be indicated by a blinking power light. To restart the system, simply press the Power Button.

1.4 PACKAGING CHECK LIST

The Motherboard comes securely packed in a gift box and shipping carton. If any of the above items are missing or damaged, please contact your supplier.

The motherboard contains:

Q' TY		Description
1	Motherboard	: With VIA Apollo Pro-Plus chipset
1	Driver	: CD-Title w/Installation label <ul style="list-style-type: none">• PC-Cillin Software• Motherboard Bus master Driver
1	Cable	: IDE Cable
1	Cable	: Floppy Cable
1	User' s guide	: PC-Cillin
1	Manual	: User' s manual

Chapter 2

Setup Guide

2.1 Motherboard layout

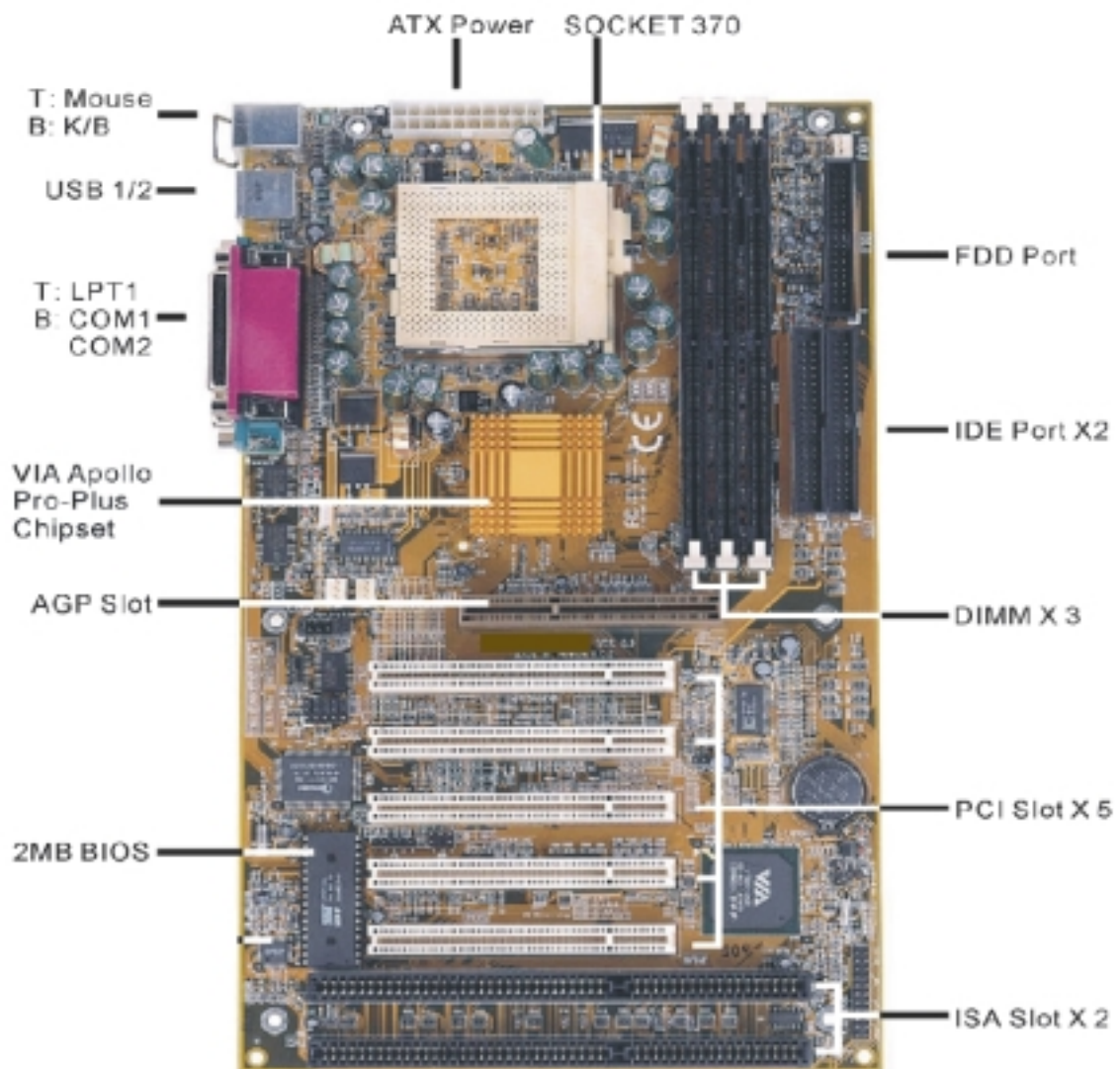

2.2 Connector & Jumper Reference Chart

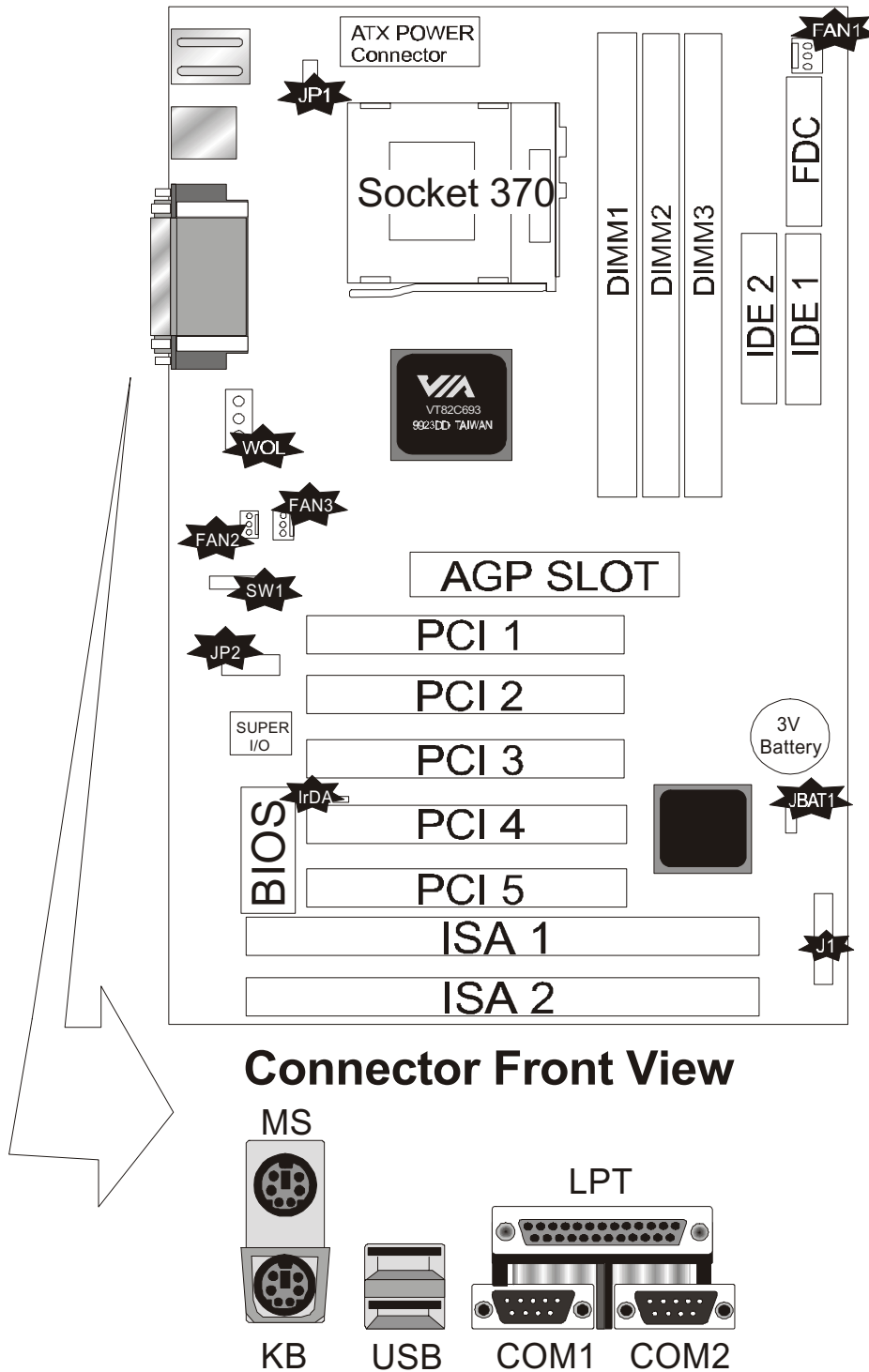

2.3 The setup steps

Please refer to the following steps to setup your computer:

- I. Refer to the Jumper Setup section to set up the jumpers correctly.
- II. Install the DIMM modules on the motherboard; be sure to set up safely.
- III. Install the CPU on the motherboard (please refer to the CPU installation manual).
- IV. Choose a case and install the motherboard into this case.
- V. Plug in all the interface cards of your system equipment.
- VI. Connect the cable, power supply and other message lines in the correct position.
- VII. Reboot, and enter the Award BIOS setup Menu to correct the definitions.
- VIII. Turn on the power and set up your computer system software.

2.3-1 Jumper & Connector Setting

PS/2 Keyboard Connector

This connector can connect PS/2 Keyboard and has better performance.

Pin	Description	Pin	Description
1	Keyboard Data	2,6	N.C.
3	Ground	4	+5V
5	Keyboard Clock		

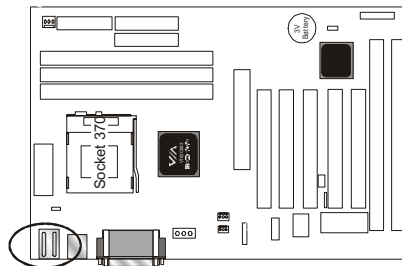

BVC3A

PS/2 Mouse Connector

This connector can connect PS/2 Mouse and has better performance.

Pin	Description	Pin	Description
1	Mouse Data	2,6	N.C.
3	Ground	4	+5V
5	Mouse Clock		

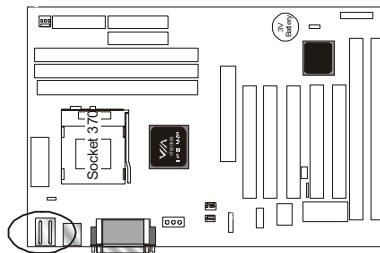

ATX Power Supply Connector

This connector allows the motherboard to draw the power form ATX power supply. It requires an ATX power supply of 250 watt at least.

Pin	Description	Pin	Description
1,2,11	+ 3.3 V	3,5,7,13,15,16,17	Ground
4,6,19,20	+ 5 V	8	POWER GOOD
9	5VSB	10	+12 V
12	-12 V	14	PS-ON
18	- 5 V		

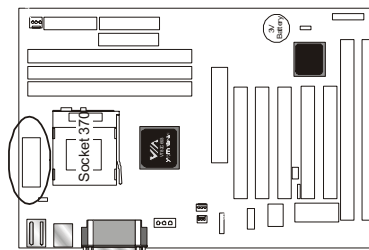

BVC3A

Printer Connector

This Connector can transfer the data to printer for printing on paper.

Pin	Signal Name	Pin	Signal Name
1	Strobe-	14	AFD
2	Data Bit 0	15	Error
3	Data Bit 1	16	INIT
4	Data Bit 2	17	SLCTIN
5	Data Bit 3	18	GND
6	Data Bit 4	19	GND
7	Data Bit 5	20	GND
8	Data Bit 6	21	GND
9	Data Bit 7	22	GND
10	ACK	23	GND
11	Busy	24	GND
12	PE	25	GND
13	SLCT	26	GND

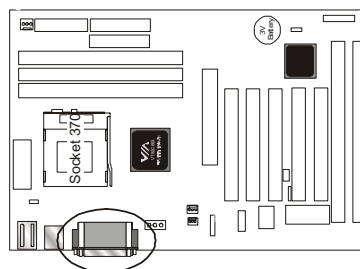

BVC3A

COM1,COM2 –Serial Connectors

These connectors allow mouse or the other device which use this type connector for transferring data between computer and devices.

Pin	Signal Name	Pin	Signal Name
1	DCD	6	DSR
2	SIN	7	RTS
3	SOUT	8	CTS
4	DTR	9	RI
5	GND	10	NC

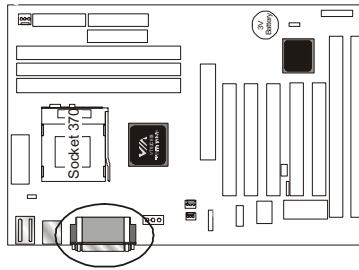

USB- Universal Serial Bus (USB1, USB2) Connectors

These connectors allow the device which use this type connector for transferring information between computer and devices.

USB1 Pin	Signal Name	USB2 Pin	Signal Name
1	USB VCC 0	1	USB VCC 1
2	USB Data -	2	USB Data -
3	USB Data +	3	USB Data +
4	USB GND 0	4	USB GND 1
5	GND	5	GND

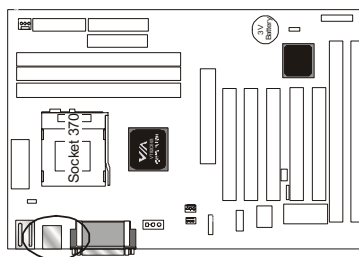

BVC3A

IrDA - Infrared Connector: IR

This connector is used to connect IR Device.

Pin	Signal Name
1	VCC
2	NC
3	SIRRX
4	GND
5	IRTX

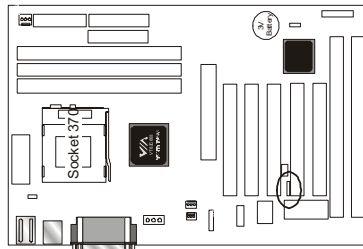

WOL – Wake-up On LAN Connector

This connector is used to connect an add-in NIC (Network Interface Card) which gives WOL function to the motherboard. Enable this function for remotely managing PC on a network. When a PC receives the wake up command during sleep, the LAN controller will wake up the PC.

Pin	Signal Name
1	5VSB
2	GND
3	LID

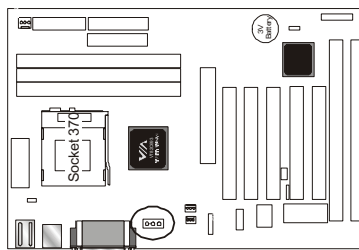

BVC3A

JP1 – Keyboard & PS/2 Mouse ON NOW Connector

This connector is used to enable keyboard & PS/2 mouse power on with hot keys or mouse button.

Pin	Signal Name
1-2	Disable
2-3	Enable

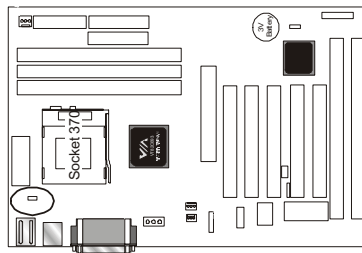

JBAT1 – CMOS Clear

This jumper is able to clear the current data stored in the CMOS memory.

Pin	Description
1-2	Normal (default)
2-3	Clear CMOS

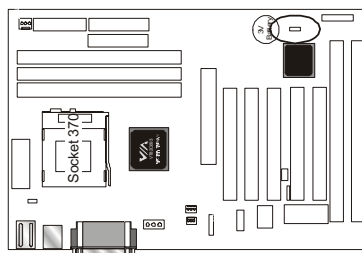

PANEL CONNECTORS SETTING

Locate the bank of switch and indicator connectors. These connectors provide control functions to your system case. Such as Speaker, HD LED, Power LED, Key Lock, SMI Switch, SMI ED and Reset ...etc. Please use the cable below to make the connections.

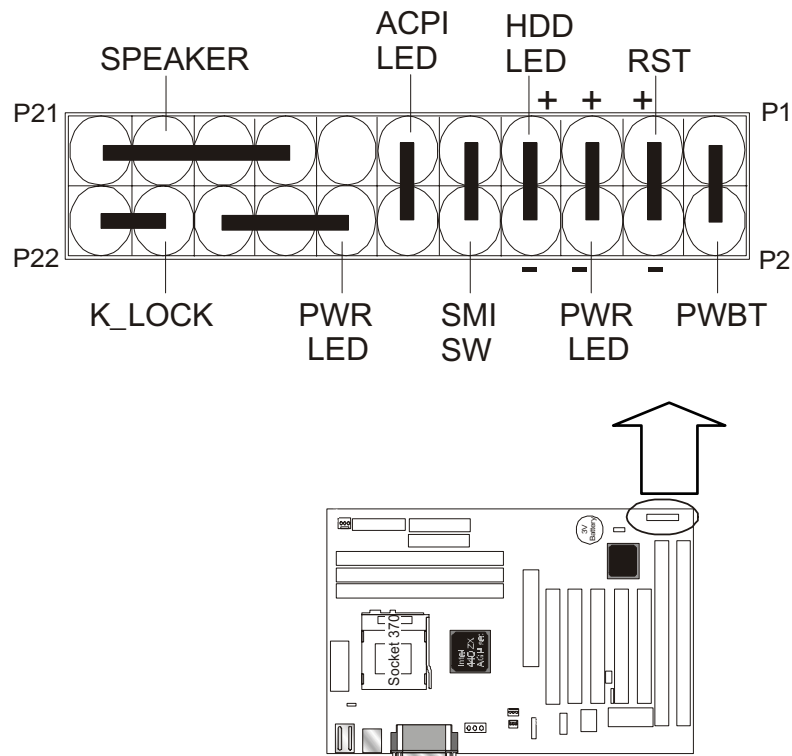

Pin	Name	Description
15,17,19,21	SPEAKER	Speaker
20,22	K-LOCK	Key Lock
14,16,18	PWR LED	Power LED
11,12	ACPI LED	ACPI LED
9,10	SMI SW	Suspend mode
7,8	HDD LED	Hard Disk LED
5,6	PWR LED	Power LED
3,4	RST	Reset
1,2	PWBT	Power Button

FAN1, FAN2, FAN3 - FAN CONNECTORS

These connectors allow the fans of CPU and system to draw the power from the motherboard.

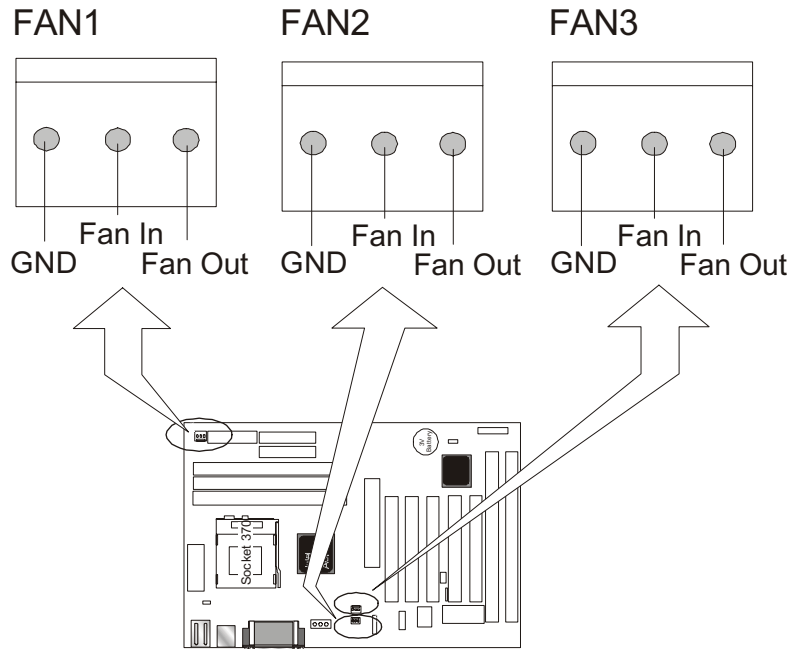

FAN1 : CPU FAN CONNECTOR.

FAN2 : For SYSTEM COOL FAN CONNECTOR.

FAN3 : For SYSTEM COOL FAN CONNECTOR.

CPU TYPE SELECT



The Socket 370 processor supports external bus frequencies of both 66MHz and 100MHz, but not all Intel Pentium® CPUs can support both frequencies. Please refer to your CPU specifications before setting the bus speed on your motherboard.

The BVC3A will auto-detect your CPU type without your having to set any jumpers. You just need to install your CPU and your system will help you to find the CPU type.

The clock frequency is 66 by default. But you can change the frequency in the BIOS Setup; refer to 3.3–Chipset Features in Chapter 3. That means that even if your Intel Pentium® CPU doesn't support an external bus speed of 100MHz, you can still set your motherboard's external bus speed to

BVC3A

100MHz.

If you want to change the CPU ratio and clock settings, you can also use the on board jumpers to do it. Refer to the list below — CPU TYPE SELECTION LIST.

Note: When you want to use these on board jumpers to change the CPU ratio and clock settings, be sure the CPU Host/SDRAM clock setting in the BIOS is “Default” and your CPU type must be non-fixing CPU (please refer your CPU specifications).

CPU TYPE SELECTION LIST

SW1,2,3,4 – CPU Ratio

RATIO	SW1-1	SW1-2	SW1-3	SW1-4
3.5	Short	Open	Open	Short
4.0	Short	Short	Short	Open
4.5	Short	Open	Short	Open
5.0	Short	Short	Open	Open
5.5	Short	Open	Open	Open
6.0	Open	Short	Short	Short
6.5	Open	Open	Short	Short
7.0	Open	Short	Open	Short
7.5	Open	Open	Open	Short
8.0	Open	Short	Short	Open

JP6 (For BUS clock)

CLOCK	1-2	3-4
Auto	Short	Short
100 MHz	Open	Short
133 MHz	Short	Open

JP2 – CPU Voltage Regulation

AUTO-Detect CPU Voltage

CPU Voltage	1-2	2-3	4-5	5-6	7-8	8-9	10-11	11-12	13-14	14-15
Auto		Short		Short		Short		Short		Short

Select CPU Voltage Regulation

CPU Voltage	1-2	4-5	7-8	10-11	13-14
1.30 V					Short
1.35 V	Short				Short
1.40 V		Short			Short
1.45 V	Short	Short			Short
1.50 V			Short		Short
1.55 V	Short		Short		Short
1.60 V		Short	Short		Short
1.65 V	Short	Short	Short		Short
1.70 V				Short	Short
1.75 V	Short			Short	Short
1.80 V		Short		Short	Short
1.85 V	Short	Short		Short	Short
1.90 V			Short	Short	Short
1.95 V	Short		Short	Short	Short
2.00 V		Short	Short	Short	Short
2.05 V	Short	Short	Short	Short	Short
2.10 V	Short				
2.20 V		Short			
2.30 V	Short	Short			
2.40 V			Short		
2.50 V	Short		Short		
2.60 V		Short	Short		
2.70 V	Short	Short	Short		
2.80 V				Short	
2.90 V	Short			Short	
3.00 V		Short		Short	
3.10 V	Short	Short		Short	
3.20 V			Short	Short	
3.30 V	Short		Short	Short	
3.40 V		Short	Short	Short	
3.50 V	Short	Short	Short	Short	

2.3-2 Memory installation

No jumper setting is necessary for DRAM setting; BIOS will check DRAM type and size automatically. This motherboard contains 3 by 168-pin DIMM socket (DIMM1, DIMM2, DIMM3). The motherboard has a table-free (or auto-bank) feature; the user can install DIMM into any bank. The three DIMM Sockets permit system memory expansion from 8MB to 768MB. Each bank provides a 64-bit wide data path. You can install 133MHz or 100MHz SD RAM into the motherboard, using your CPU clock to make the selection.

If you want to install more memory and there are no sockets available, you must remove some installed modules and replace them with the upgrade modules.

If you have to do this, be sure to identify what type of memory is already installed. In some cases, there may be a mix of module types. You can confirm this by checking the configuration screen that appears while the computer is starting up. Press the pause key to temporarily interrupt the start-up so that you have more time to read the screen. When you're done, press any key to resume.

Remove the lowest performance and smallest size modules and replace them with the upgrades.

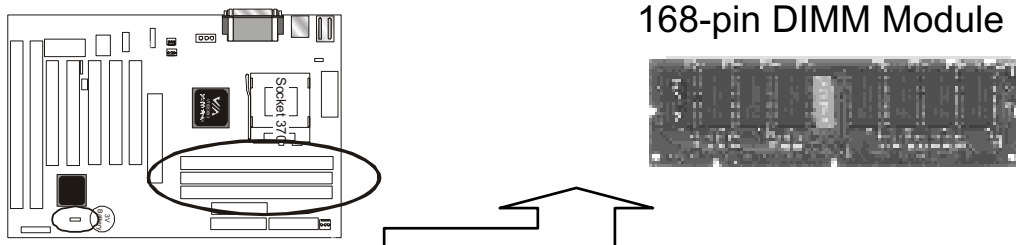

How to Install DIMM Modules on Motherboard

1. The SDRAM sockets are keyed with notches and the DIMMs are keyed with cut-outs so that they cannot be installed incorrectly. Check that the cut-outs on the DIMM edge connector match the notches in the SDRAM socket. In other words, before inserting the DIMM, make sure the pin1 of the DIMM matches with the pin1 on the DIMM socket.
2. Push down the latches on each side of the SDRAM socket.
3. Install the DIMM into the socket and press it carefully but firmly down so that it seats correctly. The latches at either side of the socket will be levered upwards and latch on the edges of the DIMM when it is installed correctly.

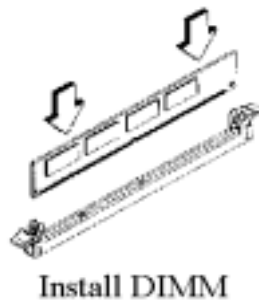

How to Remove DIMM Modules from Motherboard

1. Press the holding latches at either side of the socket outward to release the DIMM.
2. Gently pull the DIMM out of the socket.



NOTE: Samples of System Memory Combinations Options

DIMM1	DIMM2	DIMM3	TOTAL
8MB	---	---	8MBytes
---	8MB	---	8MBytes
---	---	8MB	8MBytes
8MB	8MB	---	16MBytes
8MB	---	8MB	16MBytes
16MB	---	---	16MBytes
---	---	16MB	16MBytes
8MB	8MB	8MB	24MBytes
16MB	8MB	---	24MBytes
16MB	---	16MB	32MBytes
32MB	---	---	32MBytes
8MB	16MB	16MB	40MBytes
32MB	32MB	---	64MBytes
64MB	---	---	64MBytes
64MB	64MB	---	128MBytes
:	:	:	:
128MB	128MB	128MB	384MBytes

DIMM type : 3.3V, unbuffered or registered, 64/72-bit Synchronous DRAM with SPD. Supports Single/Double-side 16/32/64/128 Mbytes module size with parity or non-parity.

2.3-3 How to install the CPU

Prepare the motherboard by installing the supplied CPU-Socket 370, then install the CPU according to the instructions supplied. Complete the processor installation by installing the supplied heat-sink support, and connecting the heat sink power cable to the motherboard connector.

Referential Steps of installing the Socket 370 CPU

This section is only for CPU installation, the motherboard in the picture is not the **BVC3A**. Regarding the heat-sink, please refer to the instructions supplied.

1. Review the CPU and motherboard.



2. Pull the lever sideways away from the socket then raise the lever up to a 90-degree angle.

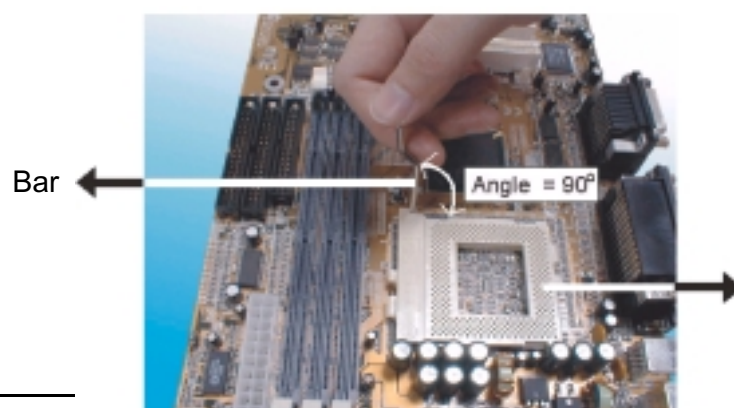

BVC3A

3. Locate Pin 1 in the socket and look for the cut edge in the CPU, match Pin 1 with the cut edge then insert the CPU. It should be inserted easily.

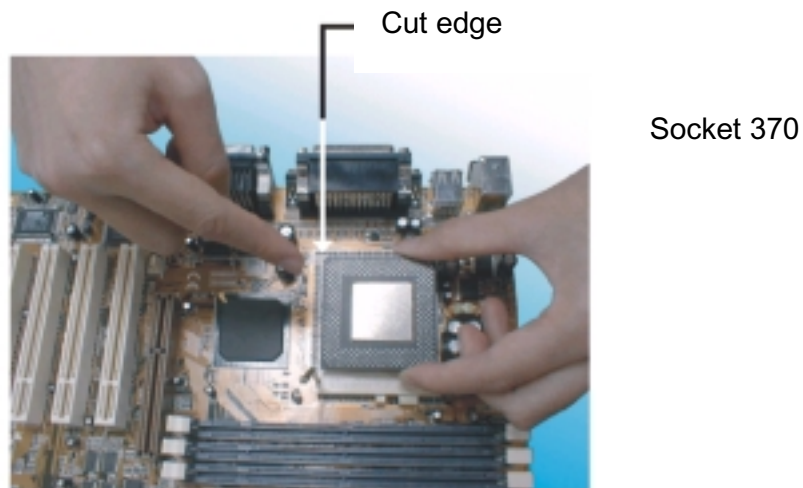

4. Press the lever down to lock the CPU into the socket.



Note:
Regarding the heatsink installation, please refer to the instruction of the supplier.

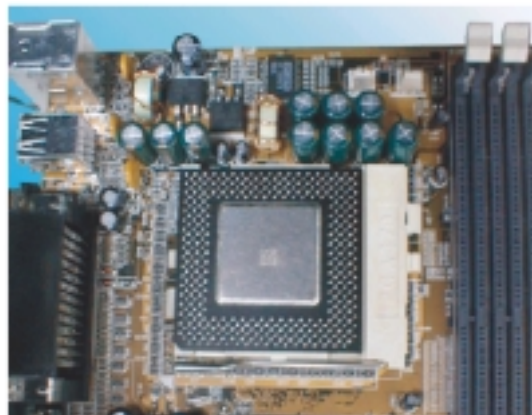

CPU & Power Supply Fan Connectors (3-pin FanPWR)

These connectors support cooling fans of 500mAMP (6 watts) or less. Position the fans so that the heat-sink fins allow the airflow to go across the onboard heat-sink(s) instead of the expansion slots. Depending on the fan manufacturer, the wiring and plug may be different. The red wire should be positive, while the black one should be grounded. Connect the fan's plug to the board, taking into consideration the polarity of this connector.

The "rotation" signal is to be used only by a specially designed fan with a rotation signal.



The CPU and motherboard will overheat if the hot air generated by the CPU does not flow across the onboard heat-sinks, and the CPU fan and motherboard can be damaged if these pins are used improperly.

2.3-4 Installing the Motherboard

The **BVC3A** motherboard complies with the specifications for an ATX board, so you can also install this kind of board into a full-size ATX case. Some features on the motherboard are implemented by cabling connectors on the motherboard to indicators and switches on the system case. Ensure that your case supports all the features required. The **BVC3A** motherboard can support one or two floppy diskette drives and four enhanced IDE drives. Ensure that your case has sufficient power and space for all the drives that you intend to install.



Caution: Make sure that you have already installed the system board components like the CPU and memory, and have set the appropriate jumpers before you proceed.

2.3-5 Installing the interface card

This section explains how to install new interface cards on your motherboard. It covers installing ISA cards, PCI cards and AGP cards. There are seven expansion card slots on the motherboard, one AGP slot, five PCI slots and two ISA slots. When you get an expansion card, it will come with instructions on how to install it, so this section covers relevant information for the motherboard only.

AGP Card and Slot

The AGP (Accelerated Graphics Port) slot is for an AGP display card. With the Optimum Settings loaded in the BIOS Setup Utility the AGP has a default memory aperture of 4MB, expandable to 256MB.

PCI Cards and Slots

With very few exceptions, any PCI expansion card you are likely to get will be Plug and Play compliant. If you are using an Operating System that supports PnP, such as Windows 98/95, you should be able to follow the installation instructions that come with the card and have the Operating System automatically recognize and configure the card.

The PCI slots on the motherboard all have “Bus Master” capability. For installed PCI cards to use this feature, an Operating system specific Bus Master software driver that comes with this motherboard must be installed under your Operating System. These drivers are located on the support Disk.

ISA Cards and Slots

ISA expansion cards often use system resources in the form of IRQs and DMA channels. Newer cards that comply with the Plug and Play (PnP) standard are designed to allow the Operating System to automatically configure system resources. Cards that do not support PnP may require manual configuration of both the card hardware and settings in the CMOS Setup Utility.

If you have a PnP compliant card to install, there should be little to do other than follow the installation instructions. If, however, you have a non-PnP card and it requires configuring system resources, you may need to setup the configuring expansion card resources in CMOS Setup.

2.3-6 Installing Accessory Cables

This section describes how to connect the accessory cable that motherboard or system housing supports. In the case of ATX, there is no need to use a bracket to extend the connectors to the rear panel, so here we will discuss only the installation instructions for Floppy, IDE, Power supply and Front Panel switch/LED cables.



Caution: Make sure that the power supply is OFF before connecting or disconnecting any bracket or cable.

ATX Power Cable

The 20-pin ATX power cable supports 5V standby current and soft power-on switch. The soft power switch can be either momentary or toggle type and must comply with the ATX specification.

Plug in the power cable to the onboard power connector.

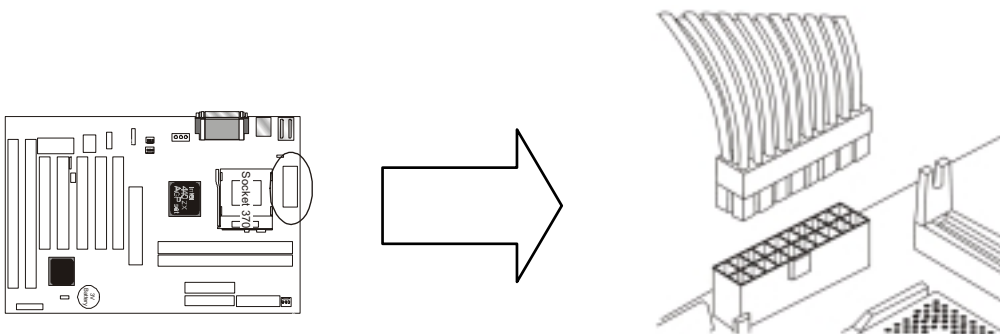

Front Panel Switch and LED Cables

Normally, the front-panel housing has power switch, power LED, reset switch, suspend switch, speaker, keylock and HDD LED. These accessories are included in the housing package.

Refer to the 2.3-1 “PANEL CONNECTORS SETTING” for proper location of the connector.

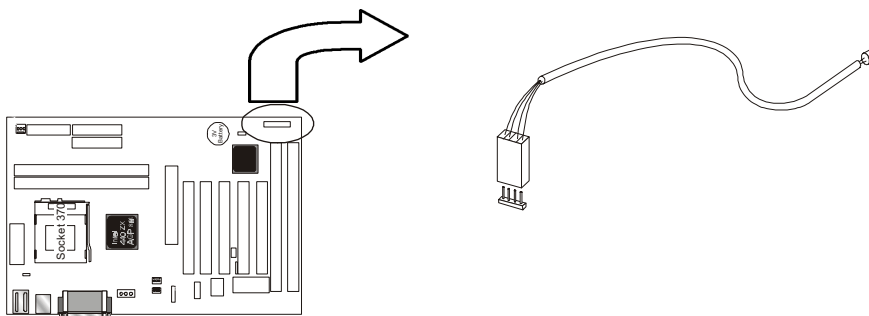

Floppy Cable

The floppy cable for floppy drives is a 34-pin flat cable with 5 connectors classified as follows:

1. Female header (For floppy connector onboard)
2. Female header and Edge connector (For driver B)
3. Female header and Edge connector (For driver A)

The end-most connector cable is twisted to support floppy drive A, while the middle connectors are for floppy drive B. The drive B connectors are designed to accommodate both 1.44MB and 1.2MB drives. The female header supports the 1.44MB drive, while the female edge connector supports the 1.2MB drive. When connecting the drive, make sure that pin1 of the cable (ie., the red-colored wire) matches pin1 of the drive.

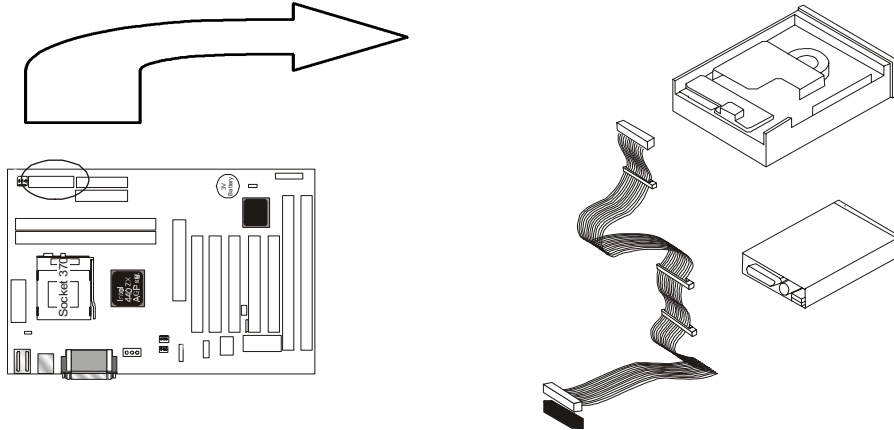

IDE Cables for HDD and CDROM

The motherboard comes with two IDE interfaces; primary IDE and secondary IDE connectors. Each channel supports two IDE devices via 34-pin flat cable, thus enabling the system to accommodate a maximum of four devices.

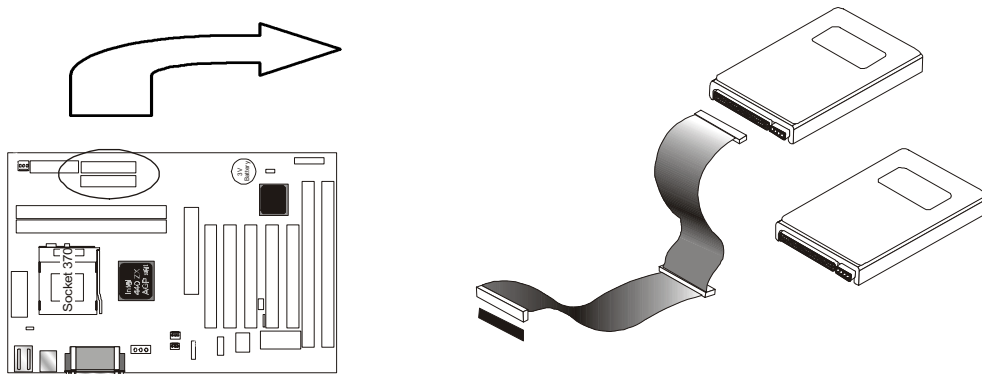

Chapter 3

Award BIOS Setup

This chapter explains how to use and modify the BIOS setup utility that is stored on the motherboard. The setup utility stores information about the motherboard components, and the configuration of other devices that are connected to it. The system uses this information to test and initialize components when it is started up, and to make sure everything runs properly when the system is operating.

The setup utility is installed with a set of default values. The default values are designed to ensure that the system will operate adequately. You will probably have to make changes to the setup utility whenever you add new components to your system such as new disk drives. You may be able to generate increased performance by changing some of the timing values in the setup, but this can be limited by the kind of hardware you are using, for example the rating of your memory chips. In certain circumstances, the system may generate an error message which asks you to make changes to the setup utility. This happens when the system finds an error during the POST (power on self test) that it carries out at start up.

Starting the Setup Utility

You can only start the setup utility shortly after the computer has been turned on. A prompt appears on the computer display which says "**Press DEL to run Setup**". When you see this prompt press the **Delete** key, and the system will start the setup utility and display the main menu of the utility.

Using the Setup Utility

When you press the **Delete** key to start setup, the main menu of the utility appears.

The main menu of the setup utility shows a list of the options that are available in the utility. A highlight shows which option is currently selected. You can use the cursor arrow keys to move the highlight to other options.

BVC3A

When an option is highlighted, you can execute the option by pressing the **Enter** key. Some options lead to dialog boxes which ask you verify that that you wish to execute that option. You usually answer these dialogs by typing **Y** for yes and **N** for no.

Some options lead to dialog boxes which ask for more information. Setting the User Password or Supervisor Password has this kind of dialog box.

PRESS F1 TO CONTINUE, CTRL-ALT-ESC OR DEL TO ENTER SETUP

Control Keys

Up Arrow	Move to previous item
Down Arrow	Move to next item
Left Arrow	Move to the item in the left hand
Right Arrow	Move to the item in the right hand
Esc Key	Main Menu Quit and not to save changes to CMOS Status Page setup menu and Option Page Setup Menu Exit current page and return to Main Menu
PgUp Key	Increase the numeric value or make changes
PgDn Key	Decrease the numeric value or make changes
F1 Key	General help, only for Status Page Setup Menu and Option Setup Menu
F2 Key	Change color from total 16 colors
F3 Key	Calendar, only for Status Page Setup Menu
F4 Key	Reserved
F5 Key	Restore the previous CMOS value from BIOS, only for Option Page Setup Menu
F6 Key	Load the default CMOS value from BIOS default table, only for Option Page Setup Menu
F7 Key	Load the default
F8 Key	Reserved
F9 Key	Reserved
F10 Key	Save all the CMOS changes, only for Main Menu

3.1 The Main Menu

Once you enter Award BIOS CMOS Setup Utility, the Main Menu will appear on the Screen. Use arrow keys to select among the items and press to accept or enter the **sub-menu**.

Some options lead to tables of items. These items usually have a value on the right side. The value of the first item is highlighted, and you can use the cursor arrow keys to select any of the other values in the table of items. When an item is highlighted, you can change the value by pressing the **PageUp** or **PageDown** keys, or the **Plus** or **Minus** keys. The **PageUp** and **Plus** keys cycle forward through the available values, the **PageDown** and **Minus** keys cycle backwards through the values.

When you are in the main menu, you can exit the utility by pressing the **Escape** key. You can save the current selections and exit the utility by pressing the F10 key. You can change the color scheme of **the** utility by pressing the **F2** key **while** holding down **the Shift** key. When you are in one of the options that displays a dialog box, you can return to the main menu by pressing the **Escape** key.

When you are in one of the options that displays a table of items, you can return to the main menu by pressing the **Escape** key. For some items, you can display a help message by pressing the **F1** key. You can change the color scheme of the utility by pressing **the F2** key while holding down the **Shift** key. You can press **FS** to discard any changes you have made and return all items to the value **that** they held when the setup utility was started. You can press **F6** to load the displayed items with a list of default values. You can press **F7** to load the displayed items with a **high-performance** list of default values.

BVC3A

ROM PC/ISA BIOS (2A6LGPND)
CMOS SETUP UTILITY
AWARD SOFTWARE, INC.

STANDARD CMOS SETUP	INTEGRATED PERIPHERALS
BIOS FEATURE SETUP	SUPERVISOR PASSWORD
CHIPSET FEATURES SETUP	USER PASSWORD
POWER MANAGEMENT SETUP	IDE HDD AUTO DETECTION
PNP/PCI CONFIGURATION	SAVE & EXIT SETUP
LOAD BIOS DEFAULTS	EXIT WITHOUT SAVING
LOAD SETUP DEFAULTS	
Esc : Quit F10 : Save & Exit Setup	↑ ↓ → ← : Select Item (Shift) F2 : Change Color

Standard CMOS Setup

This setup page includes all the items in standard compatible BIOS.

BIOS Features Setup

This setup page includes all the items of Award special enhanced features.

Chipset Features Setup

This setup page includes all the items of chipset special features.

Power Management Setup

This menu provides functions for Green products by allowing users to set the timeout value for monitor and HDD.

PNP / PCI CONFIGURATION SETUP

This menu allows the user to modify PNP / PCI configuration function.

Load BIOS Defaults

BIOS defaults indicates the most appropriate value of the system parameter which the system would be in minimum performance.

Load Setup Defaults

Chipset defaults indicates the values required by the system for the maximum performance.

INTEGRATED PERIPHERALS

This section page includes all the items of IDE hard drive and Programmed Input / Output features.

Supervisor / User Password Setting

Change, set, or disable password. It allows you to limit access to the system and Setup, or just to setup.

IDE HDD Auto Detection

Automatically configure hard disk parameters.

Save & Exit Setup

Save CMOS value changes to CMOS and exit setup.

Exit Without Saving

Abandon all CMOS value changes and exit setup.

3.2 Standard CMOS Setup

The item in Standard CMOS Setup Menu is divided into several categories. Each category includes no, one or more than one setup items. Use the arrow keys to highlight the item and then use the <PgUp> or <PgDn> keys to select the value you want in each item.

da_2bUj A[eS2T] ae2: DSH^Yb` V; ef`S` VSDV2U ae2eWgb Si SdV2eaXfi SdW2] `U@									
Vs^w2 @ELwL'; 2L2_f.>2\%a2DHCKKK f{6w2 zZLEELf; 2L22K2L2GD2L2FD									
ZSdV2M[e	fkBW	e[1W	Uk^e	ZV8V	bdWba_b	^S`M	eWfad	_aWw	
b{6s+ 2_s+ w 2222222B		B	B	B	B	B	B	B	NORMAL
b{6s+ 2e-sSw2222222B22		B	B	B	B	B	B	B	NORMAL
evuf, vs+ 2_s+ wL	B	B	B	B	B	B	B	B	NORMAL
evuf, vs+ 2e-sSwL	B	B	B	B	B	B	B	B	NORMAL
Vf{Sw2S222L2C@F_>2E@C2{, @ Vf{Sw2I222L2`f, w X-f, ..' 2E2_fvw2e%a, f+ 2L2M f+st~w									
h{vwf2222L2VWSAhYS Zs~ 2a, 2L2S-->2I%a2] w t fs+ v					2222Ts+ w2_vEft+ L222222B] WEw vvw2_vEft+ L222222B] 222a~ zw+ 2_vEft+ L222222C] 222f` s~2_vEft+ L222222C]				
WLU222L22c%o XC2222L22Zw, ..									
ez{x'; 2XD222L2L2s, yw2Uf~-ft									

BVC3A

Date and Time

The Date and Time items show the current date and time held by your computer. If you are running a Windows operating system, these items will automatically be updated whenever you make changes to the Windows Date and Time Properties utility.

Hard Disks

Default: Auto

These items show the characteristics of any hard disk drives on the four available IDE channels. (Note that SCSI hard disk drives do not appear here.) You can automatically install most modem hard disks using the IDE HDD Auto Detect Option from the main menu. However, if you find that a drive cannot be automatically detected, you can use these items to select USER, and then manually enter the characteristics of the drive. The documentation provided with your drive provides the data you need to fill in the values for CYLS (cylinders), HEAD (read/write heads), and so on.

The documentation provided with the drive may not tell you what value to use under the MODE heading. If the drive is smaller than 528 NM, set MODE to Normal. If the drive is larger dm 528 NM and it supports Logical Block Addressing, set MODE to LBA- Very few high-capacity drives do not support Logical Block Addressing. If you have such a drive, you might be able to configure it by setting the MODE to Large. If you're not sure which MODE setting is required by your drive, set MODE to Auto and let the setup utility try to determine the mode automatically.

Drive A and Drive B

Default: 1.44M, 3.5 in., None

These items define the characteristics of any diskette drive attached to the system. You can connect one or two diskette drives.

Floppy 3 Mode Support

Default: Disabled

Floppy 3 mode refers to a 3.5" diskette with a capacity of 1.2MB. Floppy 3 mode is sometimes used in Japan.

Video

Default: Disabled

This item defines the video mode of the system. This motherboard has a built-in VGA graphics system so you must leave this **item** at the default value.

Halt On

Default: All. But Keyboard

This item defines the operation of the system POST (Power On Self Test)

BVC3A

routine. You can use this item to select which kind of errors in the POST is sufficient to halt the system.

Base, Extended and Other Memory *Default: All. But Keyboard*

These items show how much memory is available on the system. They are automatically detected by the system so you cannot manually make changes to these items.

3.3 BIOS Features Setup

This option displays a table of items which defines more advanced information about your system. You can make modifications to most of these items without introducing fatal errors to your system.

ROM PCI/ISA BIOS (2A6LGPND)
BIOS FEATURE SETUP
AWARD SOFTWARE, INC

Anti-Virus Protection	: Enabled	Video BIOS Shadow	: Enabled
External Cache	: Enabled	C8000-CBFFF Shadow	: Disabled
CPU L2 Cache ECC Checking	: Enabled	CC000-CFFFF Shadow	: Disabled
		D0000-D3FFF Shadow	: Disabled
Quick Power On Self Test	: Enabled	D4000-D7FFF Shadow	: Disabled
Boot Sequence	: A, C ,SCSI	D8000-DBFFF Shadow	: Disabled
Swap Floppy Drive	: Disabled	DC000-DFFFF Shadow	: Disabled
Boot Up Floppy Seek	: Disabled		
Boot Up NumLock Status	: On		
Gate A20 Option	: Fast		
Memory Parity/ECC Check	: Enabled		
Typematic Rate Setting	: Disabled		
Typematic Rate (Chars/Sec)	: 6		
Typematic Delay (Msec)	: 250		
Security Option	: Setup		
PCI/VGA Palette Snoop	: Disabled		
OS Select For DRAM > 64MB	: Non-OS2	Esc : Quit	↑↓→← : Selection Item
HDD S.M.A.R.T. capability	: Enabled	F1 : Help	PU/PD/+/- : Modify
Report No FDD For Win95	: No	F5 : Old Values	(Shift) F2 : Color
		F6 : Load BIOS Defaults	
		F7 : Load Setup Defaults	

Anti-Virus Protection

Default: Enabled

Anti-Virus program could locate and remove the problem before any damage is done. So when this item is enabled, the Award BIOS will monitor the boot sector and partition table of the hard disk drive for any attempt at modification. If an attempt is made, the Anti-Virus program built-in the BIOS will be run for protecting your system to be clean.



WARNING:

Disk boot sector is to be modified
Types 'Y' to accept write or 'N' to abort write
Award Software, Inc.

Enabled : Activates automatically when the system boots up, if anything attempts to access the boot sector or hard disk partition table will cause a warning message to appear.

Disabled : No warning message will appear when anything attempts to access the boot sector or hard disk partition table.

Many disk diagnostic programs that attempt to access the boot sector table can cause the above warning message.

External Cache

Default: Enabled

Most of the processor cartridges that can be installed in this motherboard have (level 2) external cache memory (the Celeron-266MHz is an exception). Only enable this item if your processor cartridge has external cache memory.

CPU L2 Cache ECC Checking

Default: Enabled

This item can be used to enable ECC (Error Checking Code) for the level-2 cache memory. We recommend that you leave this item at the default value Enabled.

Quick Power On Self Test

Default: Enabled

You can enable this item to shorten the power on testing and have your system start up a little faster.

BVC3A

Boot Sequence

Default: A, C, SCSI

This item defines where the system will look for an operating system, and the order of priority. You can boot an operating system from many locations including a SCSI device, a ZEP drive, a floppy diskette drive, or an LS-120 high-capacity diskette drive.

Swap Floppy Drive

Default: Disabled

If you have two floppy diskette drives in your system, this item allows you to swap around the assigned drive letters so that drive A becomes drive B, and drive B becomes drive A.

Boot Up Floppy Seek

Default: Disabled

During POST, BIOS will determine if the Floppy disk drive installed is 40 or 80 tracks. 360 K type is 40 tracks while 720K, 1.2M and 1.44M drive type as they are all 80 tracks.

Enabled: BIOS searches for floppy disk drive to determine if it is 40 or 80 tracks. Note that BIOS can not tell from 720K, 1.2M or 1.44M drive type as they are all 80 tracks.

Disabled: BIOS will not search for the type of floppy disk drive by track number. Note that there will not be any warning message if the drive installed is 360K.

Boot Up NumLock Status

Default: On

This item defines if the keyboard Num Lock key is active when your system is started.

Gate A20 Option

Default: Fast

This option provides compatibility with older software written for the 286 processor. Leave this item at the default value Fast.

Memory Parity/ECC Check

Default: Enabled

This motherboard supports memory with a parity bit or memory with error correction code, so leave this item at the default value of Enabled so that potential memory errors can be eliminated.

Typematic Rate Setting

Default: Disabled

This determines if the typematic rate is to be used. When disabled, continually holding down a key on your keyboard will generate only one key instance. In other words, the BIOS will only report that the key is down.

BVC3A

When the typematic rate is enabled, the BIOS will report as before, but it will then wait a moment, and, if the key is still down, it will begin the report that the key has been depressed repeatedly. For example, you would use such a feature to accelerate cursor movements with the arrow keys.

Typematic Rate (Chars/Sec)

Default: 6

When the typematic rate is enabled, this section allows you select the rate at which the keys are repeated.

<u>6</u>	<u>6 characters per second</u>	<u>15</u>	<u>15 characters per second</u>
<u>8</u>	<u>8 characters per second</u>	<u>20</u>	<u>20 characters per second</u>
<u>10</u>	<u>10 characters per second</u>	<u>24</u>	<u>24 characters per second</u>
<u>12</u>	<u>12 characters per second</u>	<u>30</u>	<u>30 characters per second</u>

Typematic Delay (Msec)

Default: 250

When the typematic rate is enabled, this section allows you select the delay between when the key was first depressed and when the acceleration begins.

<u>250</u>	<u>250 msec</u>
<u>500</u>	<u>500 msec</u>
<u>750</u>	<u>750 msec</u>
<u>1000</u>	<u>1000 msec</u>

Security Option

Default: Setup

If you have installed password protection, this item defines if the password is required at system start up, or if it is only required when a user tries to enter the setup utility.

PCI/VGA Palette Snoop

Default: Disabled

This item can help overcome problems that are caused by some non-standard VGA cards. We recommend that you leave this item at the default value Disabled.

OS Select For DRAM > 64 MB

Default: Non-OS2

This item is required if you have installed more than 64 NM of memory and you are running the OS/2 operating system. Otherwise, leave this item at the default Non-OS2.

HDD S.M.A.R.T Capability

Default: Enabled

S.M.A.R.T is an industry acronym for Self-monitoring, Analysis and Reporting Technology. If the documentation of your hard disk states that S.M.A.R.T. is supported, you can enable this item.

BVC3A

Report No FDD For WIN 95

Default: No

Set this item to Yes BIOS will report FDD to Win95. If in standard CMOS setup, set Drive A to none, and set this item to yes. Inside Win95, My Computer and File manager Disk(A:) will show Removable Disk (A:).

Video BIOS Shadow

Default: Enabled

This item allows the video BIOS to be copied to system memory for faster performance.

XXXXX-XXXXX Shadow

Default: Disabled

These items allow the BIOS of other devices to be copied to system memory for faster performance.

3.4 Chipset Features Setup

This option displays a table of items, which define timing parameters of the motherboard components including the graphics system, the memory, and the system logic. In general rule you should leave the items on this page at the default values unless you are very familiar with the technical specifications of your hardware. If you change the values, you may introduce fatal errors or recurring instability into your system.

ROM PCI/ISA BIOS (2A6LGPND)
CHIPSET FEATURES SETUP
AWARD SOFTWARE, INC

Bank 0/1 DRAM Timing	: SDRAM 10ns	Auto Detect DIMM/PCI Clk	: Enabled
Bank 2/3 DRAM Timing	: SDRAM 10ns	Spread Spectrum	: Disabled
Bank 4/5 DRAM Timing	: SDRAM 10ns	CPU Host Clock (CPU/PCI)	: Default
SDRAM Cycle Length	: 3	CPU Warning Temperature	: Disabled
SDRAM Bank Interleave	: 4 Bank	Current CPUFAN1 Speed	:
DRAM Clock	: 66 MHz	Current CPUFAN2 Speed	:
DRAM Page-Mode	: Disabled	Current CPUFAN3 Speed	:
Memory Hole	: Disabled	IN0 (V) :	IN1(V) :
Read Around write	: Disabled	IN2 (V) :	+5V :
Concurrent PCI/Host	: Disabled	+12 V :	-12V :-
System BIOS Cacheable	: Enabled	- 5 V :-	
Video RAM Cacheable	: Enabled	Shutdown Temperature	: 60°C/140°F
AGP Aperture Size	: 64M		
AGP-2X Mode	: Disabled		
		Esc : Quit	↑↓→← : Selection Item
		F1 : Help	PU/PD/+/- : Modify
		F5 : Old Values	(Shift) F2 : Color
		F6 : Load BIOS Default	
		F7 : Load Setup Default	

Bank 0/1 DRAM Timing

Default: SDRAM 10ns

Bank 2/3 DRAM Timing

SDRAM 10ns

Bank 4/5 DRAM Timing

SDRAM 10ns

These items define the timing parameters for Fast Page-mode and EDO RAM. We recommend that you leave these items at the default values. The default value ensures reliability if slower memory is used.

BVC3A

SDRAM Cycle Length

Default: 3

This item defines the CPU cycles' s number between SDRAM refresh. The refreshment may be not complete and data can be lost when insufficient time is allowed. We recommend that you leave this item at the default values 3.

SDRAM Bank Interleave

Default: 4 Bank

This item sets the SDRAM internal multi-bank function, from 2-banks ~ 4-banks.

DRAM Clock

Default: 66MHz

This item sets your DRAM clock; you can use this item to select the value of DRAM clock. We recommend that you leave this item at the default values 66 if you purchase the DRAM, which is 66MHz type.

DRAM Page-Mode

Default: Disabled

Enabled : Support Fast Page DRAM Multi-Page mode.

Disabled : Support EDO RAM and SRAM.

Memory Hole

Default: Disabled

In order to improve performance, certain space in memory can be reserved for ISA cards. This memory must be mapped into the memory below 16MB.

Read Around write

Default: Disabled

This item control memory data bus turn around time between two consecutive SDRAM read and writes cycles. Disable : the turn around time should to be 17. Enabled : the turn around time should to be 27.

Concurrent PCI/Host

Default: Disabled

Disabled : The CPU will be occupied during the entire PCI operation.

Enabled : The CPU bus is only requested before cycle starting.

System BIOS Cacheable

Default: Enabled

System BIOS segment is cacheable if this item been enable.

Video RAM Cacheable

Default: Enabled

Video RAM segment is cacheable if this item been enable.

AGP Aperture Size (MB)

Default: 64

Select the size of the AGP aperture. The aperture is a portion of the PCI memory address range dedicated for graphics memory address space. Host cycle that hit the aperture range is forwarded to the AGP without any translation. The choice 4, 8, 16, 32, 64, 128, 256.

BVC3A

AGP-2X Mode

Default: Disabled

Enabled : The system transfers the data by double speed. It can save more transferring time.

Disabled : The system transfers the data by normal speed. It can keep your system under stability environment.

Auto Detect DIMM/PCI Clk

Default: Enabled

Enabled : The unused DIMM and PCI slot clock will be disabled.

Disabled : The unused DIMM and PCI slot will still get the active clock signal.

Spread Spectrum

Default: Disabled

Enable / Disable this item the BIOS will Enable / Disable the clock generator spread spectrum.

CPU Host Clock (CPU/PCI)

Default: Default

This item allows other PCI devices to work concurrently with the host PCI IDE channel. We recommend that you leave this item at the default value Disabled.

CPU Warning Temperature

Default: Disabled

When this item is enabled, we can set the CPU warning temperature. If the CPU temperature is higher than the setting temperature, the system will beep.

Current CPUFAN1 Speed

Current CPUFAN2 Speed

Current CPUFAN3 Speed

It shows the running speed of the system fan, Chassis fan and power fan. The value will be changing when the system is running. If you do not install the fan, the value will show 0.

Shutdown Temperature

Default: 60°C/140°F

When the system temperature up to 60°C/140°F, it will be shutdown.

Note:

The items on the right side of the Chipset Features option are concerned with monitoring certain temperatures, voltages, and so on in your system. These items do not function unless you have installed an optional system-monitoring clip on your motherboard.

3.5 Power Management

This option displays a table of items which lets you control the power management of the system. Modern operating systems take care of much of the routine power management. This motherboard supports ACPI (advanced configuration and power interface).

This system supports three levels of power-saving modes; doze mode, standby mode, and suspend mode. Standby mode uses less power than doze mode and suspend mode uses the least power.

The power management in the setup utility lets you specify a timeout for each of the power-saving modes, and a timeout for a hard disk drive power down. A timeout, means a period of time when the system (or the hard disk drive) is inactive. If the timeout completes, the system power-saving mode will execute, or the hard disk drive will power down.

You can resume from the power-saving modes by carrying out any of the activities which are enabled in the list Reload Global Timer Events. If the hard disk has been powered down it will automation resume to full power when an access to the hard disk is required (this takes just a few seconds).

ROM PCI/ISA BIOS (2A6LGPND)
POWER MANAGEMENT SETUP
AWARD SOFTWARE, INC.

ACPI function	: Enabled	Primary INTR	: ON
Power Management	: User Define	IRQ3 (COM 2)	: Primary
PM Control by APM	: Yes	IRQ4 (COM 1)	: Primary
Video off After	: Suspend	IRQ5 (LPT 2)	: Primary
Video Off Method	: V/H SYNC+Blank	IRQ6 (Floppy Disk)	: Primary
MODEM Use IRQ	: 3	IRQ7 (LPT 1)	: Primary
Soft-off by PWR-BTTN	: Instant-off	IRQ8 (RTC Alarm)	: Disabled
HDD Power Down	: Disable	IRQ9 (IRQ2 Redir)	: Secondary
Doze Mode	: Disable	IRQ10 (Reserved)	: Secondary
Suspend Mode	: Disable	IRQ11 (Reserved)	: Secondary
** PM Events **		IRQ12 (PS/2 Mouse)	: Primary
VGA	: OFF	IRQ13 (Coprocessor)	: Primary
LPT & COM	: LPT/COM	IRQ14 (Hard Disk)	: Primary
HDD & FDD	: ON	IRQ15 (Reserved)	: Disabled
DMA/master	: OFF	ECS : Quit	↑↓→← : Selection Item
Modem Ring Resume	: Disabled	F1 : Help	PU / PD / + / - : Modify
RTC Alarm Resume	: Disabled	F5 : Old Values	(Shift)F2 : Color
Wake Up on LAN	: Enabled	F6 : Load BIOS Defaults	
		F7 : Load Setup Defaults	

BVC3A

ACPI function

Default: Enabled

When Enabled, this function can save the power of your system.

Power Management

Default: User Define

This category allows you to select the type (or degree) of power saving and is directly related to the following modes : Doze; Standby; Suspend; HDD Power Down.

Min.Power Saving	Minimum power management. Doze =1 hr.; Standby= 1 hr.; Suspend= 1 hr.; HDD Power <u>Down=15min</u>
Max. Power Saving	Maximum power management only available for SL CPU.Doze=1min.; Standby=1min.;Suspend=1 min.;HDD <u>Power Down= 1 min</u>
User Defined	Allows you to set each mode individually. When not disabled, each of the ranges are from 1 min. to 1 hr. except for HDD Power Down which ranges from 1 to 15min. and <u>disable</u>

If you would like to use Software Power-off Control function, you cannot choose " Disabled "here, and should select "Yes" in PM Control by APM.

PM Control by APM

Default: Yes

Windows 95 and 98 have built-in power management capabilities called APM (advanced power management). When you enable this item, you allow the APM routines in Windows to operate on your system.

Video Off After

Default: Standby

When enabled, this feature allows the VGA adapter to operate in a power saving mode.

N/A	Monitor will remain on during power saving modes.
Suspend	Monitor blanked when the systems enter the Suspend mode.
Standby	Monitor blanked when the system enters Standby mode.
Doze	Monitor blanked when the system enters any power saving mode.

Video Off Method

Default: V/H SYNC+Blank

This determines the manner in which the monitor is blanked.

V/H SYNC+ Blank	This selection will cause the system to turn off the
-----------------	--

BVC3A

	vertical and horizontal sync. Ports and write blanks to the video buffer
Blank	This option only writes blanks to the
Screen	video buffer
DPMS	Initial display power management signaling

MODEM Use IRQ

Default: 3

This item determines the IRQ in which the MODEM can be used.
The choice: 3,4,5,7,9, 10,11,N/A.

MODEM Use IRQ

Default: 3

This item determines the IRQ in which the MODEM can be used.
The choice: 3,4,5,7,9, 10,11,N/A.

Soft-off by PWR-BTTN

Default: Instant-off

Under ACPI (advanced configuration and power interface) the system can be turned off mechanically (by the power button) or it can undergo a software power off. If the system has been turned off by software, the system can be resumed by a LAN, MODEM or ALARM wake up signal. This item allows you to define a software power off using the power button. If the value is set to Instant-Off, the power button will automatically cause a software power off. If the value is set to Delay 4 Sec. the power button must be held down for a full four seconds to cause a software power off.

HDD Power Down

Default: Disable

You can use this item to set a timeout for a hard disk power down. You can set a time from 1 to 15 minutes. If the hard disk is inactive for the time specified, it will power down. It will automatically return to full power when it is next accessed.

Doze Mode

Default: Disable

If you have selected User Define for the Power Management item, you can set this item to a selection of timeouts from 20 seconds to 40 minutes.

Suspend Mode

Default: Disable

If you have selected User Define for the Power Management item, you can set this item to a selection of timeouts from 20 seconds to 40 minutes.

VGA

Default: OFF

When the item is enabled, any video active restarts the global timer for standby mode.

BVC3A

LPT & COM

Default: LPT/COM

If the system is “LPT” : The system will auto wake up from standby mode or suspend mode, when the system transfers the data by parallel port.

If the system is “COM” : The system will auto wake up from standby mode or suspend mode, when the system transfers the data by serial port.

If the system is “LPT/COM” : The system will auto wake up from standby mode or suspend mode, when the system transfers the data by parallel port or serial port.

HDD & FDD

Default: ON

If the item sets “ON”, the system will be normal mode from standby mode or suspend mode, when it is reading the data from hard disk or floppy.

DMA/master

Default: OFF

If the item sets “ON”, the system will auto wake up from standby mode or suspend mode, when the DMA is active.

Modem Ring Resume

Default: Disabled

Enabled: when system in suspend mode, it can be wake up by modem.

Disabled: it cannot be wake up by modem.

RTC Alarm Resume

Default: Disabled

When Enabled, two additional lines will be added to the screen Date (of Month) Alarm; Time (hh:mm:ss) Alarm to let user set the desired date and time. After power off, the system will automatic power on at the specified date and time.

Wake Up On LAN

Default: Disabled

Enabled: If you have installed LDCM administrator software, and any client side is powered off, you can wake up by LAN through the LDCM mechanism.

Primary INTR

Default: ON

This item acts like a master switch for all the interrupt items that follow. If this item is set to ON, the all the following interrupts can be manually configured to act as resets for the power saving timeouts. If this item is set to OFF, then all the following interrupt items cannot be used to reset the power saving timeouts.

IRQX

These interrupt events can act as triggers to reset the power saving timeouts

or other system maintenance tasks. If you set an interrupt event to Primary, any activity on that interrupt will reset the timeouts that use the primary timer (e.g. the power saving modes). If you set an interrupt to Secondary, then any activity on the interrupt will reset those timeouts that use the secondary timer (usually background maintenance tasks). If you set an interrupt event to Disabled, any activity on the interrupt will not reset the timeouts.

3.6 PNP/PCI Configuration Setup

The PNP/PCI Configuration Setup allows you to configure the ISA and PCI devices installed in your system. The following screen appears if you select the option PNP/PCI Configuration setup from the main menu.

ROM PCI/ISA BIOS(2A6LGPND)
PNP/PCI CONFIGURATION
AWARD SOFTWARE, INC.

PNP OS Installed	: No	CPU to PCI Write Buffer	: Enabled
Resources Contorlled By	: Manual	PCI Dynamic Bursting	: Enabled
Reset Configuration Data	: Disabled	PCI Master 0 WS Write	: Enabled
IRQ-3 assigned to	: PCI/ISA PnP	PCI Delay Transaction	: Enabled
IRQ-4 assigned to	: PCI/ISA PnP	PCI Master Read Caching	: Disabled
IRQ-5 assigned to	: PCI/ISA PnP	PCI Master Broken Timer	: Disabled
IRQ-7 assigned to	: PCI/ISA PnP	PCI#2 Access #1 Retry	: Disabled
IRQ-9 assigned to	: PCI/ISA PnP	AGP Master 1 ws Write	: Enabled
IRQ-10 assigned to	: PCI/ISA PnP	AGP Master 1 ws Read	: Disabled
IRQ-11 assigned to	: PCI/ISA PnP	PCI IRQ Actived By	: Level
IRQ-12 assigned to	: PCI/ISA PnP	Used MEM base addr	: N/A
IRQ-14 assigned to	: PCI/ISA PnP	Assign IRQ For USB	: Enabled
IRQ-15 assigned to	: PCI/ISA PnP	Assign IRQ For VGA	: Enabled
DMA-0 assigned to	: PCI/ISA PnP	ESC: Quit	↑↓→←: Select Item
DMA-1 assigned to	: PCI/ISA PnP	F1 : Help	PU / PD / + / - : Modify
DMA-3 assigned to	: PCI/ISA PnP	F5 : Old Values	(Shift)F2 : Color
DMA-5 assigned to	: PCI/ISA PnP	F6 : Load BIOS Defaults	
DMA-6 assigned to	: PCI/ISA PnP	F7 : Load Setup Defaults	
DMA-7 assigned to	: PCI/ISA PnP		

BVC3A

PNP OS Installed

Default: No

If you have installed a Plug and Play **operating** system such as Windows 95 or 98, you can change this item to Yes. When the item is set to Yes you can use the Device Manager utility in the operating system to make changes to the configuration of expansion cards.

Resources Controlled By

Default: Manual

You should leave this item at the default Auto. If you find that you cannot get a particular expansion card to work properly, you might be able to solve the problem by changing this item to Manual, and defining the characteristics of the card in the new items which appear.

If you change this item to Manual, the display will list a series of items that allow you to define the assignments of the system interrupt lines (IRQs) and Direct Memory Access (DMA) channels. As default, these items are set to PCI/ISA PnP. If you install an ISA Bus card that does not support PNP, and it requires a special IRQ and DMA, you can modify the list of assignments. Change the values of the IRQ and DMA that are required to Legacy ISA.

Reset Configuration Data

Default: Disabled

If you enable this item and restart the system, any PNP configuration data stored in the BIOS setup will be cleared from memory. New updated configuration data will be created.

IRQ 3/4/5/7/9/10/11/12/14/15

DMA 0/1/3/5/6/7

This item allows you to determine the IRQ/DNM assigned to the ISA bus and is not available to any PCI slot. Choices are Legacy ISA and PCI/ISA PnP.

CPU to PCI Write Buffer

Default: Enabled

Enabled the function reduce cycle when the CPU to PCI buffer becomes available after being full.

PCI Dynamic Bursting

Default: Enabled

Enabled the function, every write transactions goes to the write buffer.

PCI Master 0 WS Write

Default: Enabled

Enabled for PCI Master data transfer ready.

Disable for waiting state for PCI Master data transfer ready.

BVC3A

PCI Delay Transaction

Default: Enabled

If the chipset has an embedded 32-bit write buffer to support delay transaction cycles, you can enable this item to provide compliance with PCI Ver.2.1 specifications. We recommend that you leave this item at the default value Enabled.

PCI Master Read Caching

Default: Disabled

Enabled : The PCI Master read the data by Caching mode.

Disabled : The PCI Master read the data will not by caching mode.

PCI Master Broken Timer

Default: Disabled

Enable the function, PCI Master transfer the data will wait 16 PCICLK. It will continue transfer next data if the system don't set be disconnected.

PCI#2 Access #1 Retry

Default: Disabled

Disable the function, AGP will not be disconnected until access finishes.

Enabled, AGP will be disconnected if max retries are attempted without success.

AGP Master 1 WS Write

Default: Enabled

Enabled : 1 wait state for AGP data transfer ready.

Disabled : 0 wait state for AGP data transfer ready.

AGP Master 1 WS Read

Default: Disabled

Enabled : 1 wait state for AGP Master read data ready.

Disabled : 0 wait state for AGP Master read data ready.

PCI IRQ Actived By

Default: Level

Level : The PCI IRQ will active by level mode.

Edge : The PCI IRQ will active by edge mode.

Used MEM base addr

Default: N/A

This item allows you to determine which basic address will not be occupied by PCI card and leave these address for some special ISA card used only.

Choices are C800, CCOO, DOOO, D400, D800, DCOO.

Assign IRQ For VGA

Default: Enabled

To assign an IRQ to VGA card if you enable this item.

Assign IRQ For USB

Default: Enabled

To assign an IRQ to USB Ports if you enable this item.

3.7 Integrated Peripherals

This option displays a list of items which **defines** the operation of some peripheral items on the system's input/output ports.

ROM PC/ISA BIOS(2A6LGPND)
INTEGRATED PERIPHERALS
AWARD SOFTWARE, INC.

OnChip IDE Channel0	: Enabled	Onboard FDC Controller	: Enabled
OnChip IDE Channel1	: Enabled	Onboard Serial Port 1	: 3F8/IRQ4
IDE Prefetch Mode	: Enabled	Onboard Serial Port 2	:
IDE HDD Block Mode	: Enabled	UART Mode Select	:
Primary Master PIO	: Enabled	UART2 Duplex Mode	: Half
Primary Slave PIO	: Auto	RxD , TxD Active	: Hi , Lo
Secondary Master PIO	: Auto	IR Transmittiion delay	: Enabled
Secondary Slave PIO	: Auto	Onboard Parallel Port	:
Primary Master UDMA	: Auto	Parallel Port	:
Primary Slave UDMA	: Auto	ECP Mode Use DMA	: 3
Secondary Master UDMA	: Auto	EPP Mode Select	: EPP1.9
Secondary Slave UDMA	: Auto	OnChip USB	: Enabled
Init Display First	: PCI Slot	USB Keyboard Support	: Disabled
POWER ON Function	:	Esc : Quit	↑↓→← : Selection Item
KB Power ON Password	: Enter	F1 : Help	PU/PD/+/- : Modify
Hot Key Power ON	: Ctrl-F1	F5 : Old Values	(Shift) F2 : Color
KBC input clock	: 8 MHz	F6 : Load BIOS Default	
		F7 : Load Setup Default	

OnChip IDE Channel0*Default: Enabled***OnChip IDE Channel1***Enabled*

You can use this item to enable or disable the primary and secondary IDE channels that are built into this motherboard. When one or both channels are enabled (the default value is Both) items appear which allow you to set the PIO (programmable input/output) mode and the UltraDMA mode for master and slave devices on the channels. We recommend that you leave these items at the default value Auto. The system will then automatically use the best performance PIO mode and UltraDMA mode for each device.

IDE Prefetch Mode*Default: Enabled*

The built-in IDE drive interfaces support IDE presetting for faster drive accesses. If you use an alternative IDE interface (on an expansion card,

BVC3A

disable this field if the alternate IDE interface does not support presetting.

IDE HDD Block Mode

Default: Enabled

This allows your HDD controller to use the fast block mode to transfer data to and from your HDD drive; Enabled IDE controller uses block mode ; Disabled IDE controller uses standard mode.

CDROM Set PIO Mode

Default: Disabled

When the item sets Enabled, CD ROM read the data by PIO mode. If the item sets Disabled, CD ROM will read the data by best mode.

Primary Master/Slave PIO

Default: Auto

Secondary Master/Slave PIO

PIO - Programmed Input / Output, it allows the BIOS to tell the controller what it wants and then let the controller and the CPU to complete the task by themselves. This is simpler and faster. Your system supports five modes, 0 - 4, which primarily differ in timing. When **Auto** is selected, the BIOS will select the best available mode.

Primary Master/Slave UDMA

Default: Auto

Secondary Master/Slave UDMA

Auto, will support the Ultra DMA function. Disabled, will not support the Ultra DMA function.

Init Display First

Default: PCI Slot

Use this item to define if your graphics adapter is installed in one of the PCI slots, or if you have installed an AGP graphics adapter into the AC-RP slot.

POWER ON Function

Default: BUTTON ONLY

The Power On Function item allows you to power on the system by pressing hot-keys. If you set this item to Hot Key, you can use the item Hot Key Power On to choose which hot keys are installed.

KBC input clock

Default: 8 MHz

This item lets you set a frequency for the input clock of the keyboard controller. Leave this item at the default value 8 MHz.

Onboard FDC Controller

Default: Enabled

This item will enable or disable the floppy disk controller.

BVC3A

Onboard FDC Controller

Default: Enabled

To enable/disable the write protection of floppy.

Onboard Serial Port 1

Default: 3F8/IRQ4

User can select serial port IRQ. If set to Auto, system will assign an IRQ for it. Note : Set to Auto is not recommended.

Onboard Serial Port 2

Default: 2F8/IRQ3

User can select serial port IRQ. If set to Auto, system will assign an IRQ for it. Note : Set to Auto is not recommended.

UART Mode Select

Default: Normal

This lets you select the Infrared mode. Choices are Standard, HPIR, and ASKIR. If you choose BPIR or ASKIR mode, the screen will show another two lines to let you choose 'IR Function Duplex' (Full or Half) and " RxD TxD Active" (Hi Lo; Lo Hi; Hi Hi-,Lo Lo).

Onboard Parallel Port

Default: 378/IRQ7

This item lets you disable the built-in parallel port, or enable it by assigning a I/O address and an Interrupt Request Line (IRQ).

Parallel Port Mode

Default: ECP+EPP

This item defines the operation of the parallel port. As a default it is set to ECP + EPP. If you are connected to a parallel device that supports the higher-performance EPP (enhanced parallel port) or the ECP (extended capabilities port) make the appropriate changes to this item. If you change the parallel port to EPP or ECP, new items appear that let you

ECP Mode Use DMA

Default: 3

Select a DMA channel for the port. Choices are 3, 1.

EPP Mode Select

Default: EPP1.9

Select EPP mode for the port.

USB Keyboard Support

Default: Disabled

Enabled will support USB keyboard in Win95 2.1 and NT 5.0 or above operating system.

3.8 Supervisor Password & User Password

These two items can be used to install a Supervisor Password and a User Password. If you log on as Supervisor, you have full access to the system, and you can restrict the permissions granted to someone who logs on as User. For example, a Supervisor can restrict a User from entering the setup utility.

To install a Supervisor or User Password, follow these steps:

1. Highlight the item Supervisor/User password on the main menu and press Enter.
2. The password dialog box will appear.
3. If you are installing a new password, carefully 4W in the password. You cannot use more than 8 characters or numbers. The password will differentiate between upper case and lower characters. Press **Enter** after you have typed in the password. If you are deleting a password that is already installed just press **Enter** when the password dialog box appears.
4. The system will ask you to confirm the new password by asking you to type it in a second time, Carefully type the password again and press **Enter**, or just press **Enter** if you are deleting a password that is already installed.
5. If you type the password correctly, the password will be installed.

3.9 IDE HDD Auto Detection Option

This feature allows you to check all the information on your hard disk formation. When you access "IDE HDD Auto Detection", the system executes auto detection.

At the prompt, it represents all the information on your HDD, and you are asked:

Do you accept this drive C: (Y/N) ?

1. If you accept the test result, press [Y] then [Enter] and the result is saved, then the system continues to detect another HDD.
6. If not, press [N] then [enter] and the system continues to detect another HDD.

3.10 Save and Exit Setup Option

This allows you to save the new setting values in the CMOS memory and continue with the booting process. Select what you want to do, press <Enter>.

3.11 Exit Without Saving Option

This allows you to exit the BIOS setup utility without recording any new values or changing old ones.

Highlight this item and press **Enter** to save the change that you have made in the setup utility and exit the setup program. When the *Save and Exit* dialog box appears, press **Y** to discard changes and exit, or press **N** to return to the setup main menu.

Chapter 4

Software Setup

The support software for this motherboard may be supplied on a CD-Title, or it may be supplied on diskettes. All the support programs are stored in separate folders, so you can find the program you need easily enough. The support software contains the following programs:

- IDE Bus Master drivers for Win 95/NT.
- PC-Cillin 98 Software.

Note: Please refer the PC-Cillin 98 installation guide for installing the PC-Cillin 98.

4.1 Installing the IDE Bus Master Driver

After you have finished the hardware setup, you have to install the IDE Bus Master software of the motherboard, then you can enjoy the advance Motherboard.

Note: If your system is Win98, please skip this section. Because Windows 98 have been built-in the IDE Bus Master Driver, you don't need to install the software again.

According the follow steps for IDE Bus Master driver installation:

1. Turn on your PC then put the “**CD title**” into your CD-ROM drive.
(Please make sure it's under Win98/95 mode)
2. The CD title will be auto-run. If not, please click the “**start**” button and select “**Run**” item. Then type-> **D:\setup** (D is assigned your CD-ROM Device)

3. Press “VIA APOLLO PRO” button.

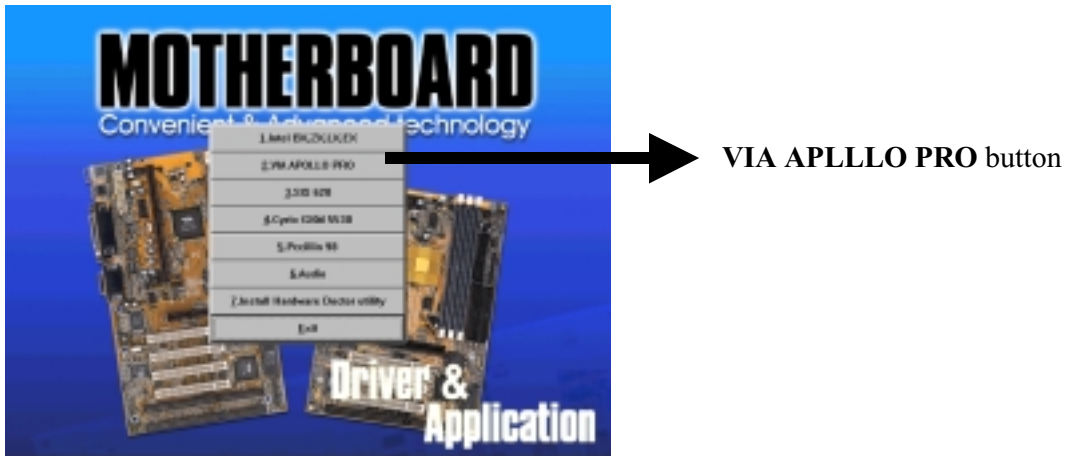

4. Then you will see the dialog box as following:

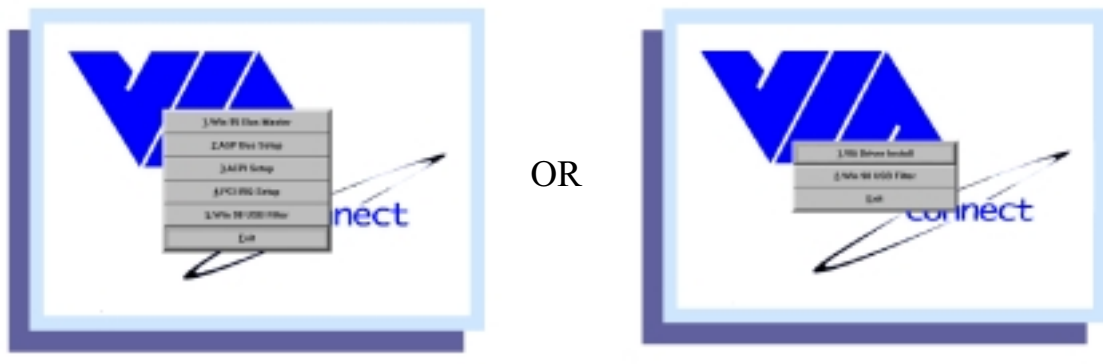

(A Type)

(B Type)

- A. IF your CD ROM shows “A Type” dialog box, you should install these item (Item1 ~ Item4) step by step and follow the instructions to setup these software.
- B. IF your CD ROM shows “B Type” dialog box, you just click the “1. VIA Driver Install” item and follow the instructions to setup these software. Because this item “1. VIA Driver Install” includes this item as “A Type” in one item.

6. Follow the instructions to complete the software installation, then re-boot your PC.

This page was intentionally left blank

This page was intentionally left blank