

Safety and Regulatory Information

Notice for the USA

FCC Part 15: This equipment has been tested and found to comply with the limits for a class B digital device, pursuant to Part 15 of the FCC Rules. These limits are designed to provide reasonable protection against harmful interference in a residential installation. This equipment generates, uses, and can radiate radio frequency energy and, if not installed and used in accordance with the instructions, may cause harmful interference to radio communications. However, this notice is not a guarantee that interference will not occur in a particular installation.

CAUTION: To comply with the limits for the class B device, pursuant to Part 15 of the FCC Rules, this device must be installed in computer equipment certified to comply with the Class B limits. All cables used to connect the computer and peripherals must be shielded and grounded. Operation with non-certified computers or non-shielded cables may result in interference to radio or television reception.

Any changes or modifications not expressly approved by the grantee of this device could void the user's authority to operate the device.

COPYRIGHT: This publication, including all photographs, illustrations and software, is protected under international copyright laws, with all rights reserved. Neither this manual, nor any of the material contained herein, may be reproduced without the express written consent of the manufacturer.

DISCLAIMER: The information in this document is subject to change without notice. The manufacture makes no representations or warranties with respect to the contents hereof and specifically disclaims any implied warranties of merchantability or fitness for any particular purpose.

TABLE OF CONTENTS

ch1. MOTHERBOARD FEATURE	2
1.1 ABOUT THE MANUAL	3
1.2 DETERMINING YOUR BS61B <i>SERIES</i> MODEL	3
1.3 BS61B <i>SERIES</i> SPECIFICATION	4
1.4 POWER OFF CONTROL SOFTWARE	5
1.5 PACKAGING CHECK LIST	6
ch2. Setup Guide	7
2.1 MOTHERBOARD LAYOUT	7
2.2 CONNECTOR & JUMPER REFERENCE CHART	8
2.3 THE SETUP STEPS	9
2.3-1 CONNECTOR & JUMPER SETTING	9
2.3-2 MEMORY INSTALLATION	19
2.3-3 HOW TO INSTALL THE CPU	22
2.3-4 INSTALLING THE MOTHERBOARD	28
2.3-5 INSTALLING THE INTERFACE CARD	29
2.3-6 INSTALLING ACCESSORY CABLES	30
ch3. AWARD BIOS SETUP	32
3.1 THE MAIN MENU	34
3.2 STANDARD CMOS SETUP	36
3.3 BIOS FEATURES SETUP	38
3.4 CHIPSET FEATURES SETUP	42
3.5 POWER MANAGEMENT	46
3.6 PNP / PCI CONFIGURATION SETUP	51
3.7 INTEGRATED PERIPHERALS	53
3.8 SUPERVISOR PASSWORD & USER PASSWORD	56
3.9 IDE HDD AUTO DETECTION OPTION	56
3.10 SAVE AND EXIT SETUP OPTION	57
3.11 EXIT WITHOUT SAVING OPTION	57
ch4. SOFTWARE SETUP	58
4.1 INSTALLING SIS 620 VGA DRIVER	58
4.2 INSTALLING THE IDE DRIVER	60
4.3 INSTALLING THE AUDIO DRIVER & AP	61

Chapter 1

Motherboard Feature Introduction

Procomp's BS61B motherboard series offer the ultimate combination of value and performance, with models that deliver high performance at a low price.

BS61B series motherboards are Baby-AT form factor boards no larger than 220 mm by 230 mm. They are based on the SiS620/SiS5595 chipsets and come with both Socket 370 and Slot 1 CPU connectors, which means either newer-generation Intel Pentium II and III CPUs or older socket-style CPUs can be used.

Motherboards in the BS61B series support system bus speeds of both 66MHz and 100MHz, which means either inexpensive 66MHz memory chips or high-performance 100MHz chips may be used.

The boards come with a pair of DIMM modules, which permit memory expansions of up to 256MB, and one ISA and three PCI slots for add-on cards. Advanced features include onboard audio, full Y2K compatibility, a VGA design that enables the use of 2-8MB of shared memory, and support for various power-on events, such as Bottom Up, Alarm Up, Ring Up, LAN Up and Password Security Up.

Motherboards in the BS61B series feature a 2MB Award flash BIOS with enhanced ACPI functions. The BIOS can support a 120MB ATAPI floppy disk, a ZIP disk drive, software clock controls, and multi-boots from IDE, SCSI, CD-ROM and FDD drives.

BS61B series motherboards come with a PC/AT 5-pin keyboard connector on board, as well as pins for connections to other ports, including PS/2 keyboard and mouse ports, USB ports, parallel ports and serial ports.

By combining advanced features with an economical design, the BS61B series enables users to do more with less.

1.1 ABOUT THE MANUAL

This manual contains the following:

- CH1. An introduction of the features of your motherboard and a list of the items that should be included along with it.
- CH2 A setup guide that will help you to get your system up and running.
- CH3 Configuring your Award BIOS for optimum performance.
- CH4 Installing and configuring software drivers and support programs that are provided along with your motherboard.

1.2 Determining Your BS61Bseries Model

There are several motherboard models in the **BS61Bseries**, and all have been designed to meet the specific needs of our customers. Of course, different people have different needs. That's why motherboards in the series come with a variety of advanced functions, some of which are not available on certain models. To determine what special functions are available on your motherboard, follow these steps:

1. Find your **BS61Bseries** motherboard model number.
2. Check to see whether the model number contains a dash followed by letters.
3. If so, consult the chart below to determine what features your motherboard possesses.

Codes Definition

Code	Description
A	Audio

Example:

◆ BS61B-A —your motherboard comes with audio functions.
It is easy to differentiate between varieties of **BS61Bseries** motherboards.

1.3 **BS61Bseries SPECIFICATIONS**

Following are the specifications for all the motherboards in the **BS61Bseries**. To determine which features your model has, it is first necessary to identify the exact model of your motherboard. Please refer to section 1.2 for additional information on determining your model number.

Chipset	SiS620/SiS5595
Processor	Supports both of Intel PPGA S-370 or Slot 1 CPU Intel Celeron processor 300MHz ~ 500MHz., PII 233~450MHz, PIII 450MHz UP
Bus Architecture	PCI / ISA
Clock Generator	Supports CPUCLK 66, 75,83.3, 90, 95, 100, 112, 124, 133MHz
Front Side Bus	Supports 66/100MHz Front Side Bus Frequency Synchronous Host/DRAM Clock Scheme: 100/100, 83/83, 75/75, 66/66MHz.
DRAM Module	2 x 168 pins DIMM Sockets Supports Max. to 256 MB SDARM
BIOS	2MB Award flash BIOS with enhanced ACPI feature ready for PC98 Supports 120MB ATAPI floppy disk Supports ZIP disk drive Supports multi-boot from IDE, SCSI, CD-ROM and FDD Supports software Clock Control (I ² C) Supports HDD S.M.A.R.T.
On Board I/O	1 x Floppy Port (up to 2.88MB, 3 mode floppy supported & LS-120) 2 x Serial ports cable out 1 x Parallel port (SPP/EPP/ECP) with VGA cable out 2 x USB pin out 1 x PC/AT 5pin Keyboard connector on board 1 x PS/2 Keyboard pin out 1 x PS/2 Mouse pin out

BS61B*series*

	1 x IrDA (Optional – by I/O Chip) 1 x Game port with Audio port (One Mic. In, One Line In, One Line Out) cable out
On Board IDE Port	Dual Ultra DMA 33/66 IDE ports
Expansion Slot	3 x PCI Slots 1 x ISA Slot
I/O Chip	SiS6801 or IT8661F Super I/O
Advanced Features	1. Supports various Power on events, Such as Bottom Up, Alarm Up, Ring Up, LAN Up, Password Security Up 2. Provides RTC year 2000 solution 3. VGA share system memory 2~8 MB 4. On Board PCI Audio (ESS1938), it can be Disabled 5. Supports H/w monitoring function, include 2 of CPU/SYS fan speed, 1 of CPU temperature, 4 of voltage detectors.
Form Factor	Baby-AT form factor with size : 220mm X 230mm

1.4 POWER OFF CONTROL SOFTWARE

Our motherboards are all designed to support software-based shutdowns through the SMI code in Windows 95/98. As it is a Baby AT form factor, an ATX or AT power supply should be used.

First, connect the power switch cable (provided by the case supplier) to the connector [PWBT] on the motherboard (see below). To activate this feature, enter the BIOS setup program and under POWER MANAGEMENT SETUP, choose "User Defined" (or the minimum or maximum power saving settings) in POWER MANAGEMENT and select YES under the option "PM Control by APM."

Note: BIOS Setup. Please refer the “Chapter 3 Award BIOS Setup”

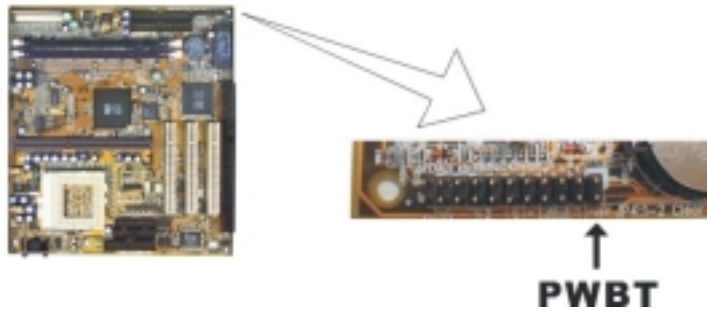

When you select “Shutdown” in Windows 95/98, the computer's power will be switched off automatically, and the computer will enter a suspended mode, indicated by a blinking power light. To restart the system, simply press the power button.

1.5 PACKAGING CHECK LIST

Your motherboard should come securely packed in a box and shipping carton. If any of the items below are missing or damaged, please contact your supplier immediately.

The motherboard contains:

QUANTITY		DESCRIPTION
1	Motherboard	: With SiS620/SiS5595 chipset
1	Driver	: CD-Title w/Installation label <ul style="list-style-type: none">• PC-Cillin Software• Motherboard Bus master Driver• Audio Driver and AP
1	Cable	: IDE Cable
1	Cable	: Floppy Cable
1	Cable	: COM1, COM2 Cable
1	Cable	: VGA, Printer Cable
1	Cable	: Game, Audio Cable
1	User' s guide	: PC-Cillin
1	Manual	: User' s Manual

Chapter 2

Setup Guide

2.1 Motherboard layout

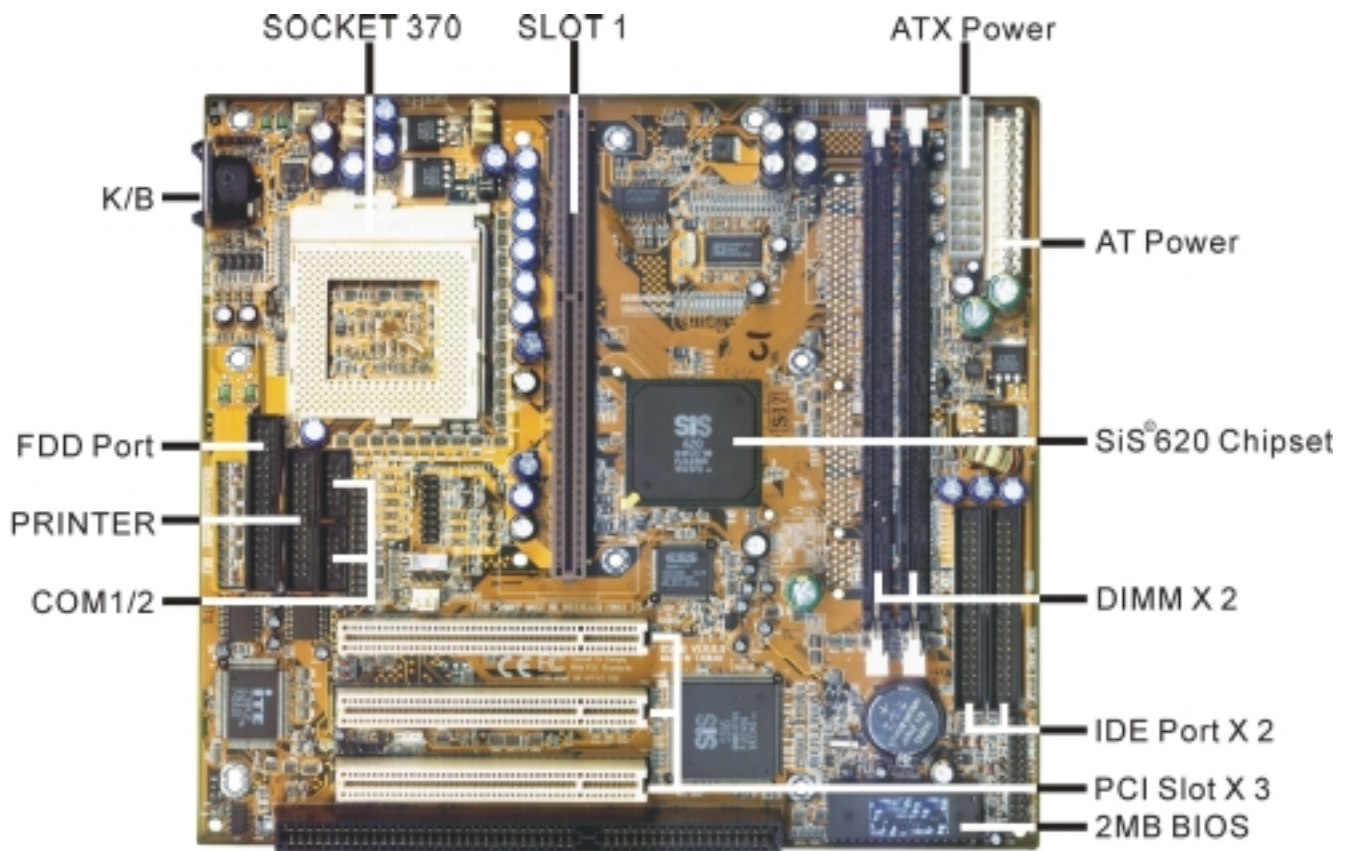

2.2 Connector & Jumper Reference Chart

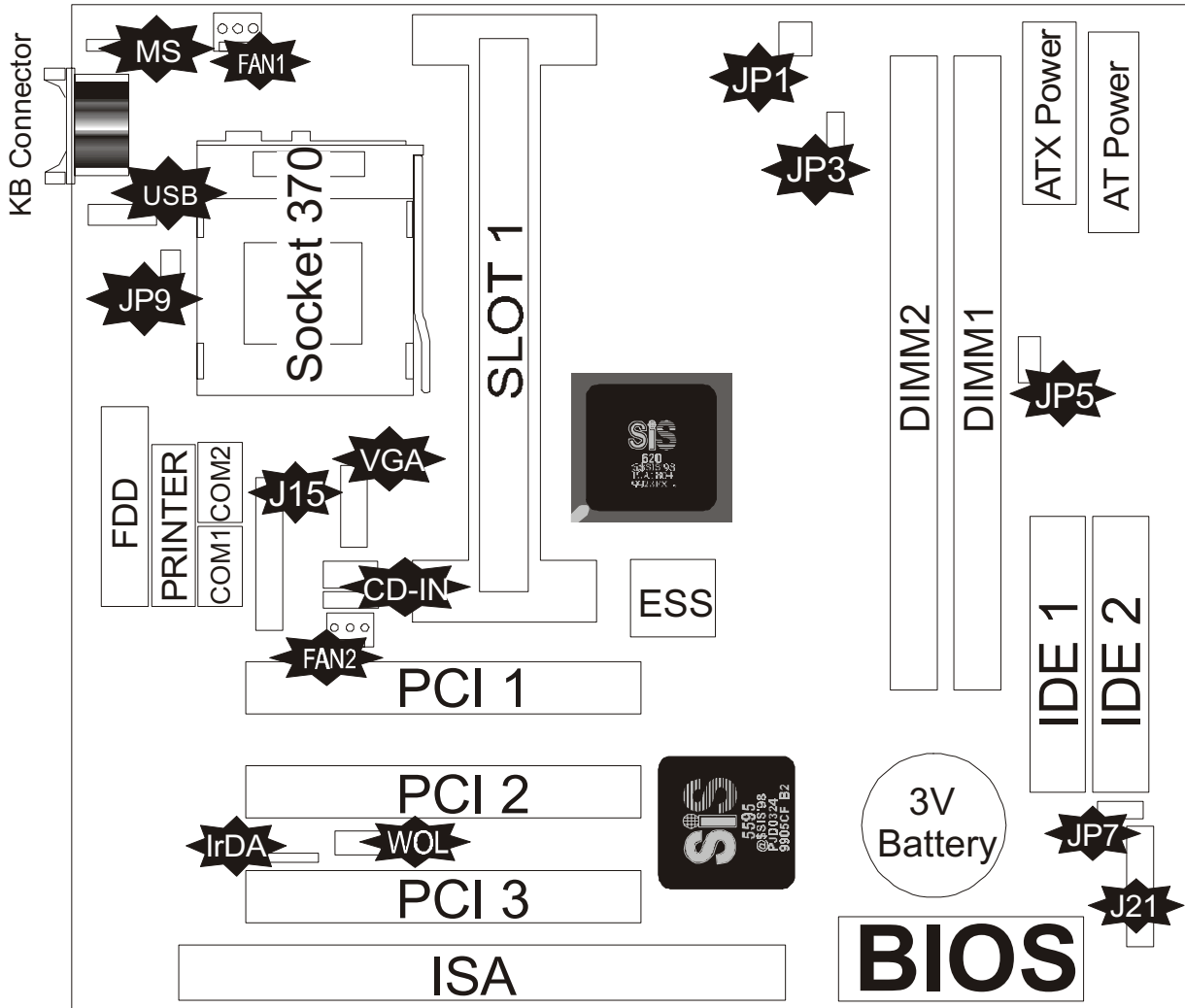

2.3 The setup steps

Please perform the following steps to setup your computer:

- I. Refer to the "Jumper Setup" section to set jumpers correctly.
- II. Install the DIMM modules on the motherboard (please be sure to set them up safely).
- III. Install the CPU on the motherboard (please refer to the CPU installation manual).
- IV. Choose a case and attach the motherboard in to the case.
- V. Plug in any interface cards you may have.
- VI. Connect the cable, power supply and other messages lines in the correct position.
- VII. Reboot, and enter the Award BIOS setup menu to correct configuration settings.
- VIII. Turn on the power, and set up your computer system software.

2.3-1 Connector & Jumper Setting

BS61Bseries motherboards are advanced motherboards that can automatically detect CPUs, and they allow you to select the CPU clock frequency and the CPU frequency ratio in BIOS setup. You can also choose whether to enable or disable on-board audio functions. All these settings are made in the BIOS, rather than through jumpers.

MS - PS/2 Mouse Connector

This connector can connect PS/2 Mouse and has better performance.

Pin	Description	Pin	Description
1	Mouse Data	2,6	N.C.
3	Ground	4	+5V
5	Mouse Clock		

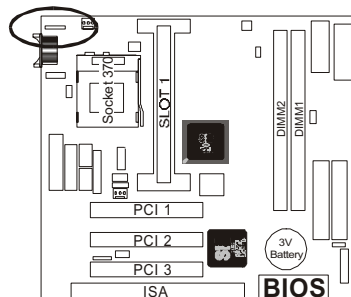

J5 - ATX Power Supply Connector

This connector allows the motherboard to draw the power from ATX power supply. It requires an ATX power supply of 250 watt at least.

Pin	Description	Pin	Description
1,2,11	+ 3.3 V	3,5,7,13, 15,16,17	Ground
4,6,19,20	+ 5 V	8	POWER GOOD
9	5VSB	10	+12 V
12	-12 V	14	PS-ON
18	- 5 V		

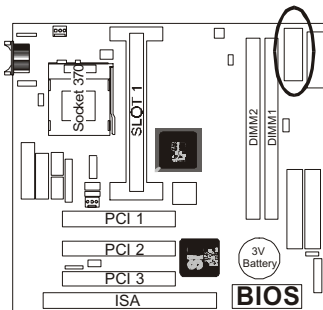
**J6 - AT Power Supply Connector**

This connector allows the motherboard to draw the power from AT power supply. It requires an AT power supply of 250 watt at least.

Pin	Description	Pin	Description
1	Power Good	7	Ground
2	+5V DC	8	Ground
3	+12V DC	9	-5V DC
4	-12V DC	10	+5V Dc
5	Ground	11	+5V DC
6	Ground	12	+5V DC

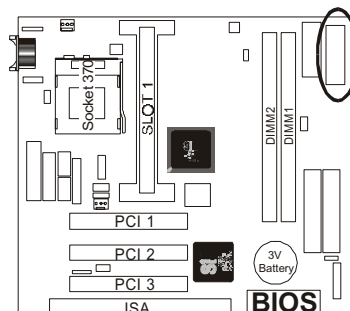

PRINTER - Printer Connector Pins

This Connector can transfer the data to printer for printing.

Pin	Signal Name	Pin	Signal Name
1	Strobe-	14	AFD
2	Data Bit 0	15	Error
3	Data Bit 1	16	INIT
4	Data Bit 2	17	SLCTIN
5	Data Bit 3	18	GND
6	Data Bit 4	19	GND
7	Data Bit 5	20	GND
8	Data Bit 6	21	GND
9	Data Bit 7	22	GND
10	ACK	23	GND
11	Busy	24	GND
12	PE	25	GND
13	SLCT	26	GND

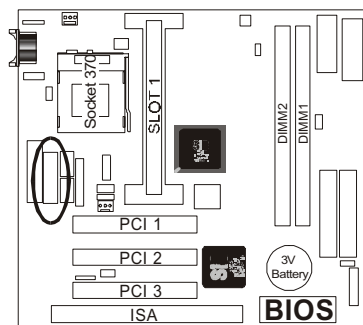

COM1 & COM2 – Serial Ports Pins

These ports allow mouse or the other RS-232 device which use this type connector to transfer data between computer and devices.

Pin	Signal Name	Pin	Signal Name
1	DCD	6	DSR
2	SIN	7	RTS
3	SOUT	8	CTS
4	DTR	9	RI
5	GND	10	NC

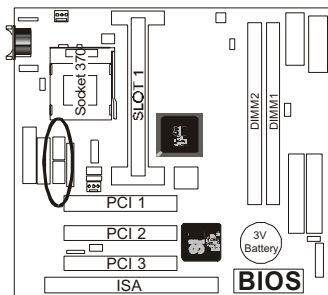

VGA – VGA Out Port Pins

This port is for the external monitor. Use this port to connect to a VGA or higher resolution display monitor.

Pin	Signal Name	Pin	Signal Name
1	RED Signal	9	N.C.
2	GREEN Signal	10	GND
3	BLUE Signal	11	N.C.
4	N.C.	12	Display data channel data
5	GND	13	Horizontal Sync
6	GND	14	Vertical Sync
7	GND	15	Display data channel clock
8	GND		

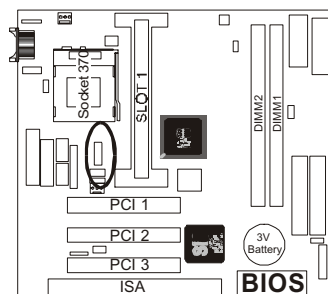

USB - Universal Serial Bus (USB1, USB2) Port Pins

This Port allows the device which use this type connector to transfer information between computer and devices.

USB Pin	Signal Name	USB Pin	Signal Name
1	USB VCC 0	2	USB VCC 1
3	USB Data -	4	USB Data -
5	USB Data +	6	USB Data +
7	USB GND 0	8	USB GND 1
9	GND	10	GND

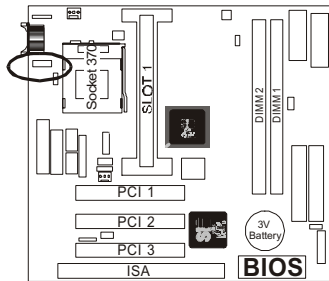

J15 – Audio & Game Port Pins

This port is for audio functions - stereo line out, stereo line in & microphone. Also, You can use this port to connect a joystick or a MIDI device to your system.

Pin	Signal Name	Pin	Signal Name	Pin	Signal Name	Pin	Signal Name
1	VCC	8	GND	15	N.C.	22	MIC-in
2	VCC	9	XTD	16	VCC	23	N.C.
3	SWC	10	GND	17	Line-out	24	GND
4	SWA	11	SWB	18	Line-out	25	Line-in
5	XTC	12	XTB	19	GND	26	Line-in
6	XTA	13	MSIN	20	GND		
7	MSOUT	14	SWD	21	MIC-in		

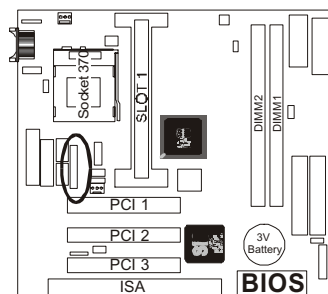

IrDA - Infrared Connector: IR

This connector is used to connect IR Device.

Pin	Signal Name
1	VCC
2	-----
3	SIRRX
4	GND
5	IRTX

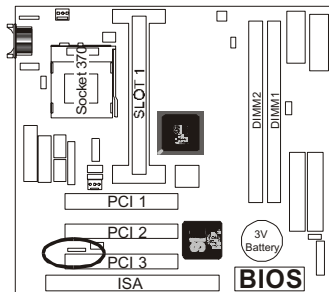

WOL – Wake-up On LAN Connector

This connector is used to connect an add-in NIC (Network Interface Card) which gives WOL function to the motherboard. Enable this function for remotely managing PC on a network. When a PC receives the wake up command during sleep, the LAN controller will wake up the PC.

Pin	Signal Name
1	5VSB
2	GND
3	LID

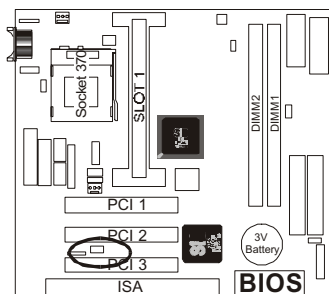

CD-IN – CD audio Connector

This connector is used to connect CD-ROM audio output to motherboard, through this, the CD audio can output to ESS audio chip directly.

Pin	Description
1	Left
2	Ground
3	Ground
4	Right

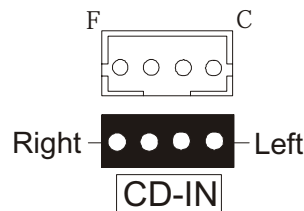
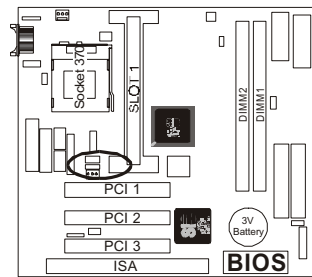

JP1, JP9 – Socket 370 / SLOT 1 Selection Jumpers

You may use either a Socket 370- or a Slot 1-style CPU with your **BS61Bseries** motherboard; however, there are two jumpers that must be set to indicate which type of CPU is being used. It is important that all three jumpers are set correctly. The tables below indicate the proper jumper settings. Set the jumpers for a Slot 1-style CPU if you are using a Pentium II/III CPU; for a Pentium I or a non-Intel CPU, use the Socket 370 settings.

JP1	Description
1-2, 3-4	Socket 370
1-3	SLOT 1

JP9	Description
1-2	Socket 370
2-3	SLOT 1

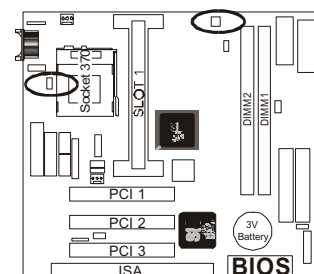

JP3 –Clock Frequency select

Your motherboard supports CPU clock speeds of 66MHz and 100MHz, and you may overclock it —i.e., use the 100MHz setting even with an older CPU that operates at only 66MHz —for improved performance. If the jumper is set to 100MHz by default, though you may change it to 66MHz according to the setting in the table below.

When you want to use this jumper to select Clock Frequency, you must confirm the Ch3 Chipset Features Setup – CPU Host/SDRAM Clock item is set “Default”.

JP3	Description
1-2	66 MHz
2-3	100 MHz

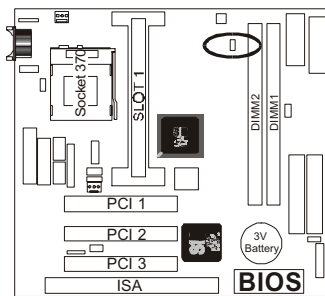

JP5 – VGA Enable/Disable

This jumper lets you enable or disable the video function that is integrated on the motherboard. You must disable the video function if you install a VGA interface card using one of the PCI slots.

Pin	Description
1-2	Disable on board video function
2-3	Enable on board video function

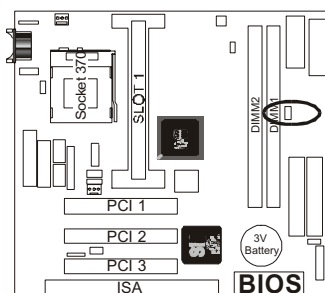

JP7 – Clear CMOS Memory Jumper

This jump lets you erase the system setup settings that are stored in CMOS memory. You might need to erase this data if incorrect settings are preventing your system from operating. To clear the CMOS memory, turn off the system, disconnect the power cable from the motherboard, and short the appropriate pins for a few seconds.

JP7	Description
1-2	Clear CMOS
2-3	Normal (default)

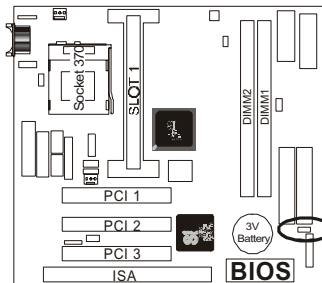

J21 – CASE PANEL CONNECTOR

Locate the bank of switch and indicator connectors. These connectors provide control functions to your system case. Such as Speaker, HD LED, Power LED, Key Lock, ACPI LED and Reset ...etc.

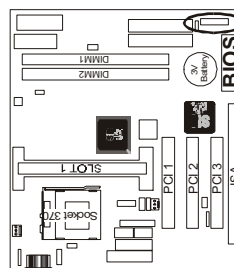
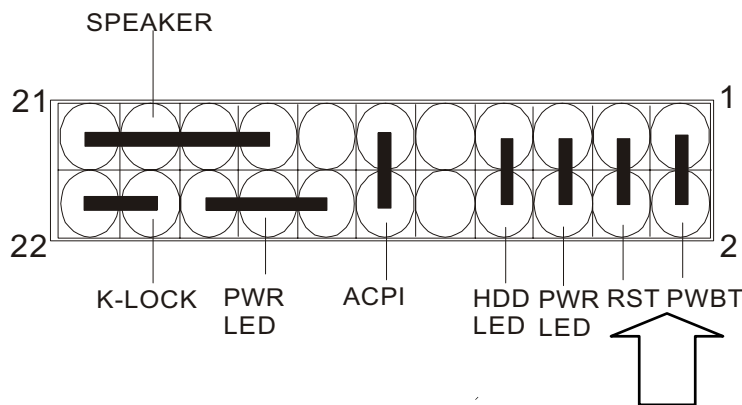

Pin	Name	Description
1 - 2	PWBT	Power button
3 - 4	RST	Reset button
5 - 6	PWR LED	Power LED
7 - 8	HDD LED	IDE LED
11-12	ACPI	ACPI LED
15-21	SPEAKER	Speaker
14-22	K-LOCK (PWR LED including)	Key Lock

FAN1, FAN2 : FAN CONNECTORS

These connectors allow the fans of CPU and System to connect the power from the motherboard.

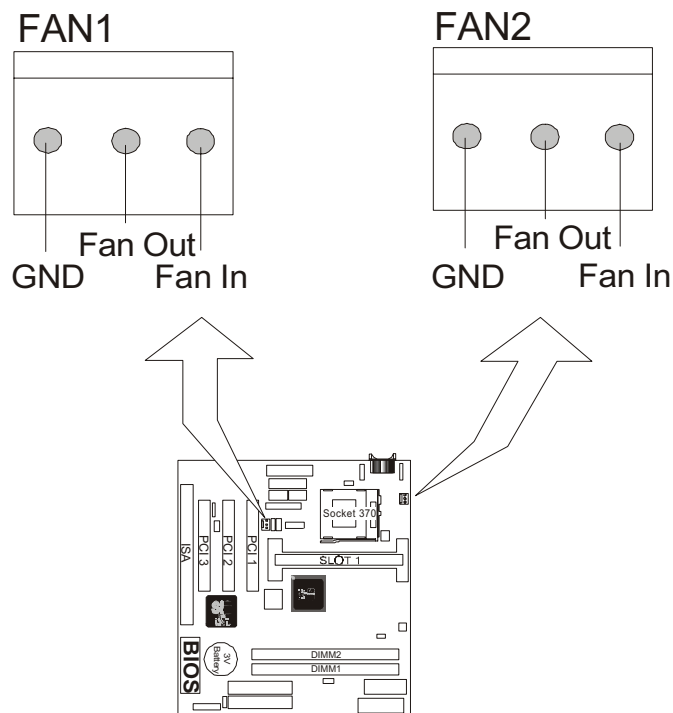

CPU TYPE SELECT



Although your motherboard can support CPU bus speeds of 66MHz and 100MHz, not all CPUs can support both frequencies. Please refer to your CPU specifications before setting the bus speed on your motherboard.

BS61B*series* motherboards can support either Socket 370- or Slot 1-style CPUs, and what type of CPU is being used is indicated through two jumpers (JP1 & JP9). For more information please refer to 2.3-1 Connector & Jumper Settings.

After you have installed the CPU onto the motherboard and ensured that the JP1 and JP9 jumpers are set correctly, your motherboard should be able to detect automatically whether a Socket 370- or a Slot 1-style CPU has been installed.

The CPU's clock frequency is set to 66MHz, you may change this setting to 100MHz through the JP3 jumper. For more information please refer to 2.3-1 Connector & Jumper Settings.

2.3-2 Memory installation

NOTE: Be noted that DIMM1 should be filled before DIMM2 because of sharing system memory issue.

No jumpers need to be set to add DRAM modules; the BIOS will automatically determine the type and size of the DRAM module that has been added. Your motherboard contains two 168-pin DIMM sockets, marked DIMM1 and DIMM2. The motherboard has a table-free, also known as an auto-bank, feature that allows users to install DIMMs into any bank. The three sockets permit system memory expansions of 8MB to 256MB or higher, and each bank provides a 64-bit wide data path. You can install 100MHz

SPD RAM or 66MHz SD RAM modules onto your motherboard—which type to add depends, of course, on the clock speed of your CPU.

If you want to install more memory and there are no sockets available, you must remove some installed modules and replace them with upgrade modules.

If you have to do this, be sure to identify what type of memory is already installed. In some cases, there may be a mix of module types. You can confirm this by checking the configuration screen that appears while the computer is starting up. Press the pause key to temporarily interrupt the startup process so that you will have enough time to read the screen. When you're done, press any key to resume startup.

Remove the lowest performance and smallest module and replace it with the upgrade.

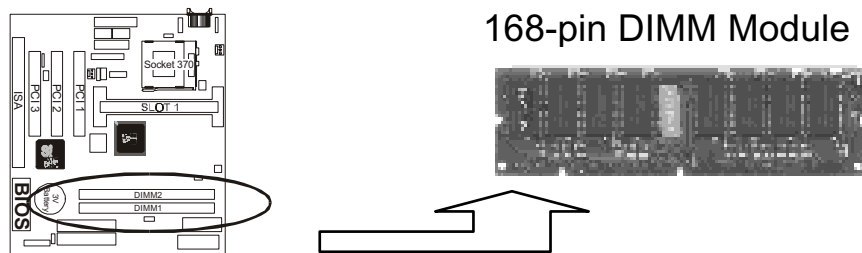

How to Install DIMM Modules on Motherboard

Both the DIMM module that you will install and the SDRAM socket into which the module will be placed have special notches and nicks that are designed to prevent modules from being installed incorrectly. To install a DIMM module, perform the following steps:

1. Check to ensure the cut-outs on the DIMM edge connector match the notches in the SDRAM socket—pin 1 on the module should match pin 1 on the socket.
2. Push down the latches on each side of the SDRAM Socket.
3. Press the module into the socket, pushing it down carefully but firmly so that it sits correctly. The latches on either side of the socket will be levered upward and latch on the edges of the module when it is installed correctly.

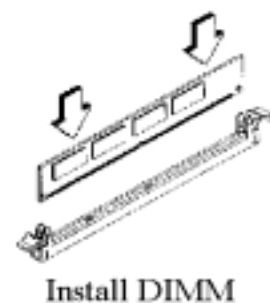

Install DIMM

How to Remove DIMM Modules from Motherboard

1. Press a latch on either side of the socket to release the module.
2. Gently lift the module out of the socket.



Remove DIMM

NOTE: Samples of System Memory Combinations Options

DIMM1	DIMM2	TOTAL
8MB	---	8MBytes
---	8MB	8MBytes
8MB	8MB	16MBytes
8MB	---	16MBytes
16MB	8MB	24MBytes
8MB	16MB	24MBytes
32MB	---	32MBytes
32MB	32MB	64MBytes
64MB	---	64MBytes
64MB	64MB	128MBytes
:	:	:
128MB	128MB	256MBytes

DIMM type : 3.3V, unbuffered or registered, 64/72-bit Synchronous DRAM with SPD. Supports Single/Double-side 16/32/64/128 Mbytes module size with parity or non-parity.

2.3-3 How to install the CPU

– Socket 370 / Solt 1

◆ **Socket 370 Part:**

Installing a CPU involves three steps: the insertion of the CPU into the proper socket or slot, the installation of the heat-sink and the connection of the heat-sink fan power cable to the appropriate motherboard connector.

Installing a Socket 370 CPU

Please note that the motherboard pictured below is not a **BS61B***series* one. Also, the instructions below refer only to the installation of the CPU; to install the heat-sink, please refer to the instructions supplied with your heat-sink.

1. Review the CPU and Motherboard.



2. Pull the lever sideways away from the socket then raise the lever up to a 90-degree angle.

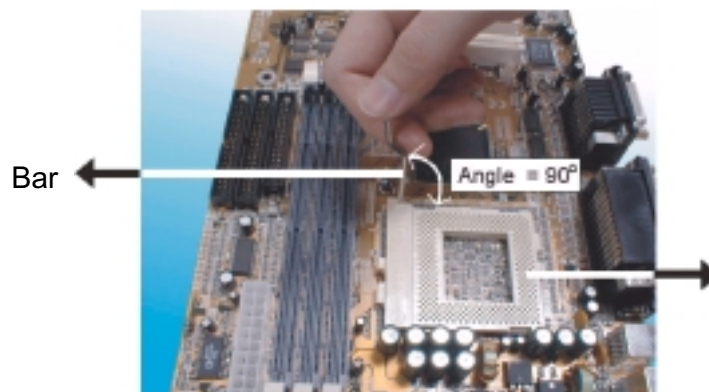

3. Locate Pin 1 in the socket and look for the cut edge in the CPU, match Pin 1 with the cut edge then insert the CPU. It should insert easily.

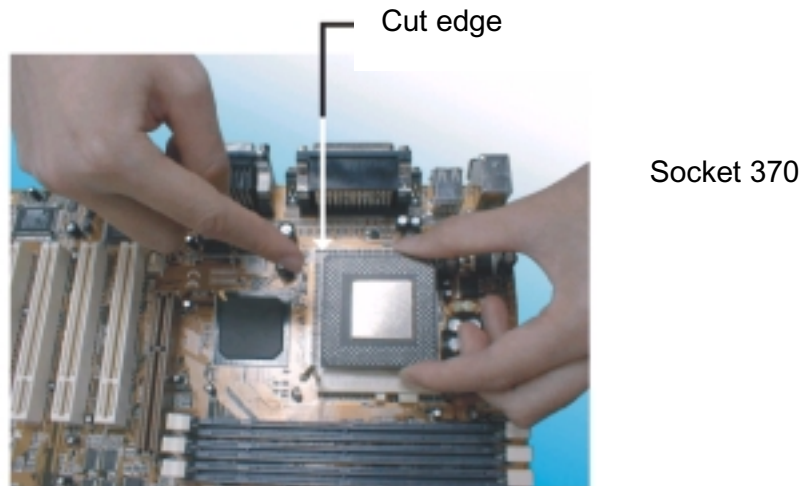

4. Press the lever down to lock the CPU into the socket.



Note:
Regarding to the heatsink installation, please refer the instruction of supplier.



CPU & Power Supply Fan Connectors (3-pin FanPWR)

These connectors support cooling fans of 500mAMP (6 watts) or less. Position the fans so that the heat-sink fins allow the airflow to go across the onboard heat-sink(s) instead of the expansion slots. Depending on the fan manufacturer, the wiring and plug may be different. The red wire should be positive, while the black one should be grounded. Connect the fan's plug to the board, taking into consideration the polarity of this connector.

The "rotation" signal is to be used only by a specially designed fan with a rotation signal.



The CPU and motherboard will overheat if there the hot air generated by the CPU does not flow across the onboard heat-sinks, and the CPU fan and motherboard can be damaged if these pins are used improperly.

◆ **Slot 1 Part:**

Installing a CPU involves three steps: the insertion of the CPU into the proper slot, the installation of the heat-sink and the connection of the heat-sink fan power cable to the appropriate motherboard connector.

Installing a Slot 1 CPU

Please note that the motherboard pictured below is not a BS61Bseries one. Also, the instructions below refer only to the installation of the CPU; to install the heat-sink, please refer to the instructions supplied with your heat-sink.

1. Inspect the area around Slot1, verify the position of four around-sockets, and then locate the small protruding rectangular tab on the side of Slot1 (see diagram).

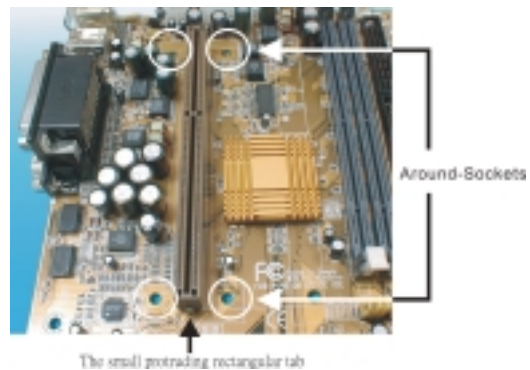

2. Examine the CPU Retention and attachments. There are three sets of attachments: 1. The stand itself. 2. The CPU locking caps (two). 3. The plastic screws (four).

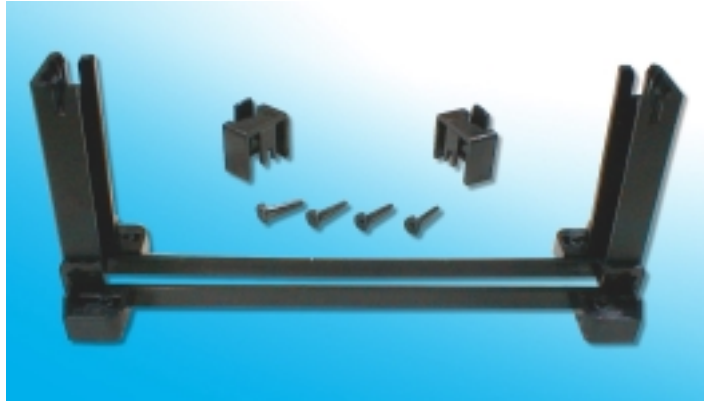

3. Once the above two steps have been completed, slot the CPU Retention into Slot1. Pull up the CPU stays on both side of the CPU Retention so they are horizontal, at an angle of 90°. Then the side of the CPU Retention with no mark on it and the side of Slot1 with the small rectangular tab should be on the same side.

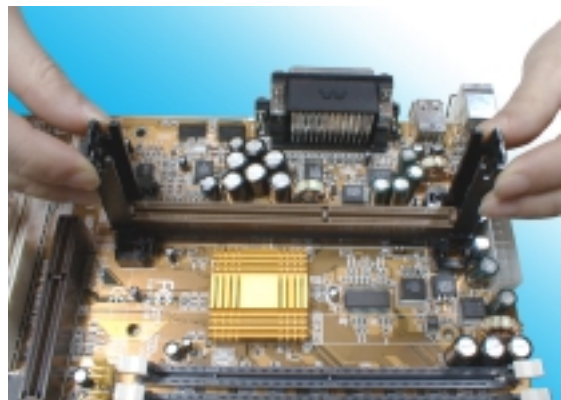
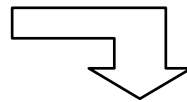
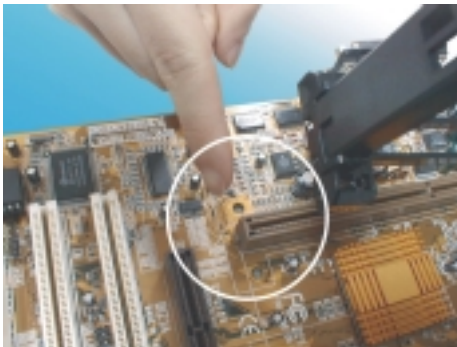

The CPU Retention has to go in a particular direction. Make sure that it is the right way round before slotting it in. Do not force it in, otherwise you may damage the motherboard and CPU Retention.

4. Ensure that the CPU Retention has been slotted all the way in, then screw the four plastic screws into the sockets on each side of Slot1 to make sure that the CPU Retention is fixed firmly in position.

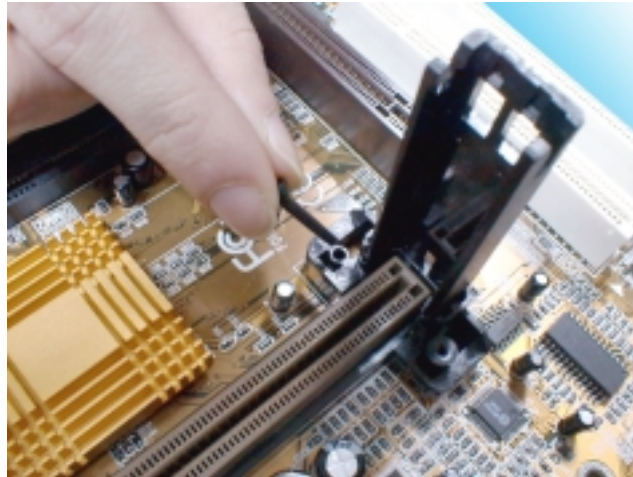

5. Slide the CPU slowly into Slot1 along the two sides of the CPU Retention.



Note: Some Slot 1 processors with different packing maybe need the caps to let them be fixed. So if it need the caps during installing Slot 1 CPU, please follow this step: “ Fix the CPU locking caps onto the two ends of the CPU stays ”.

6. Connect the CPU Fan head to the CPU Fan connector on the motherboard, and make sure that the CPU has been fixed firmly onto the motherboard. You have now completed assembly.

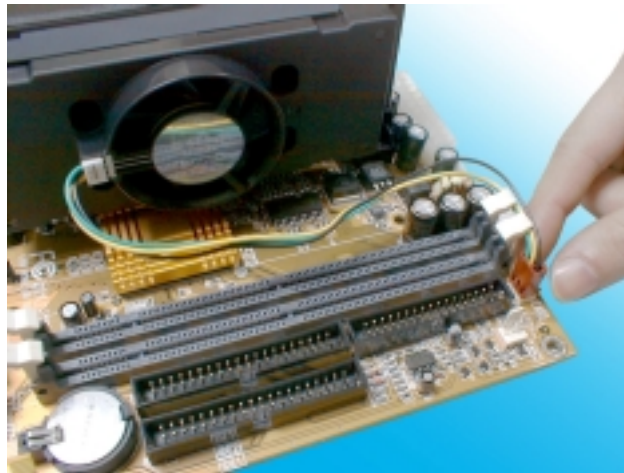

SLOT 1 CPU Disassembly/Replacement Procedures

1. Move the protruding part on top of the CPU locking caps gently outwards, so that the locking caps come off.
2. Pull the CPU Fan connector off the motherboard, and then gently pull the CPU out from Slot1.
3. If you need to install another CPU, follow the instructions for Slot1 CPU installation given above.

CPU & Power Supply Fan Connectors (3-pin FanPWR)

These connector support cooling fans of 500mAMP (6WATT) or less. Orientate the fans so that the heat sink fins allow airflow to go across the onboard heat sink(s) instead of expansion slots. Depending on the fan manufacturer, the wiring and plug may be different. The red wire should be positive, while the black should be ground. Connect the fan's plug to the board taking into consideration the polarity of this connector.

The “Rotation” signal is to be used only by a specially designed fan with rotation signal.



The CPU and motherboard will overheat if there is no airflow across the CPU and onboard heatsinks. Damage may occur to the motherboard and the CPU fan if these pins are incorrectly used.

2.3-4 Installing the Motherboard

Your **BS61B***series* motherboard complies with ATX board specifications, which means the board may be installed into a full-sized ATX case. Some of the motherboard's features require connections from the motherboard to indicators and switches on the system case. Ensure that your case supports all the features included with the motherboard. Your **BS61B***series* motherboard can support one or two floppy disk drives and four enhanced IDE drives. Ensure that your case has sufficient power and space for all the drives that you intend to install.



Caution: Make sure you have already installed system board components such as the CPU and memory modules, and that have set the appropriate jumpers before you proceed.

2.3-5 Installing the interface card

This section explains how to install new interface cards onto your motherboard. It covers the installation of ISA cards and PCI cards. Your motherboard comes with seven interface cards expansion slots: three PCI slots and two ISA slots. When you purchase an expansion card, it will come with installation instructions, so the information below pertains to the installation of cards as they relate to the motherboard.

PCI Cards and Slots

Nearly any PCI card you buy these days will be plug-and-play (PnP) installable. If you are using an operating system that supports PnP, such as Windows 95/98, your operating system should automatically detect the new device and configure its settings, though you may still need to install the appropriate drivers or software.

The PCI slots on your motherboard also have “Bus Master” capabilities. For installed PCI cards to use this feature, an operating system-specific Bus Master software driver that comes with this motherboard must be installed on your system. These drivers are on the support disk.

ISA Cards and Slots

ISA expansion cards often use system resources in the form of IRQs and DMA channels, although newer, PnP cards are designed to allow the operating system to automatically configure system resources. Cards that don't support PnP may require that both the CMOS settings and the settings within the operating system be set manually.

If you have a PnP card, installation should be quite easy as most, if not all, necessary adjustments will be made for you. If, however, you have a card that doesn't support PnP, you may need to set resource settings manually in the CMOS setup.

2.3-6 Installing Accessory Cables

This section describes how to connect the accessory cables that the motherboard or system housing supports. In the case of ATX, there is no need to use a bracket to extend the connectors to the rear panel, so discussion here is limited to the connection of cables for floppy drives, IDE drives, the power supply and front-panel switch and LED panels.



Caution: Make sure the power is off before connecting or disconnecting brackets and cables.

ATX Power Cable

The 20-pin ATX power cable supports 5V standby current and has a soft power-on switch. The switch can be either a press-and-release or toggle type, though it must conform to ATX specifications.

Plug the power cable into the onboard power connector.

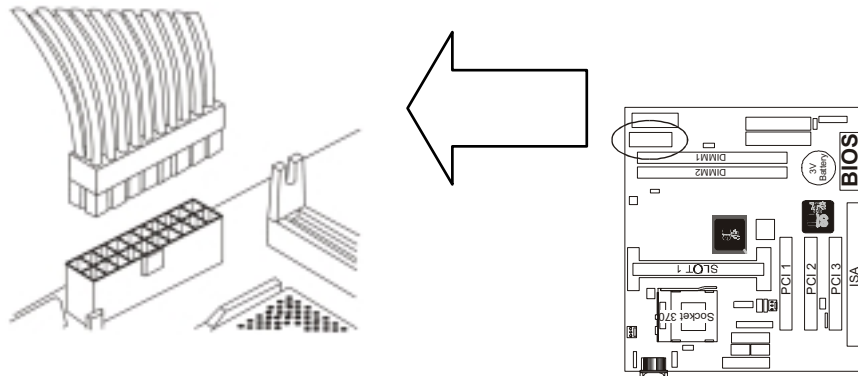

Front Panel Switch and LED Cables

Normally the front-panel housing has a power switch, power LED reset switch, suspend switch, speaker, key lock and HDD LED.

Please refer to Section 2.3-1 “Other Jumper Settings” for information on the proper location of the connectors.

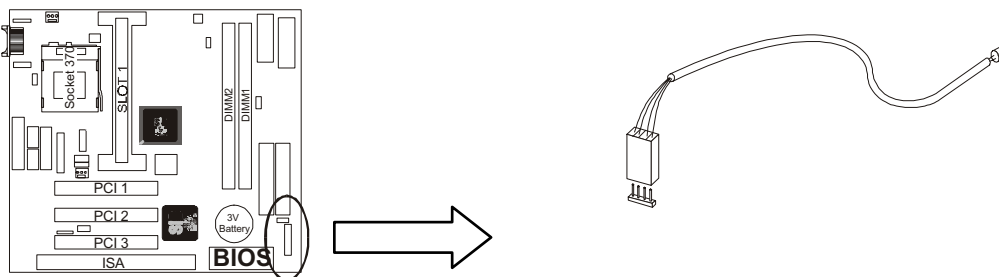

Floppy Cable

The cable for the floppy drive is a 34-pin flat cable with five connectors:

- One female header (for the onboard floppy connector)
- One female header for drive A
- One edge connector for drive A
- One female header for drive B
- One edge connector for drive B

The end-most connector cable is twisted to support floppy drive A, while the middle connectors are for floppy drive B. The drive B connectors are designed to accommodate both 1.44MB and 1.2MB drives. The female header supports 1.44MB drives, while the female edge connector supports 1.2MB drives. When connecting the cable to a drive, make sure that pin1 of the cable (i.e., the red wire) matches pin1 on the drive connector.

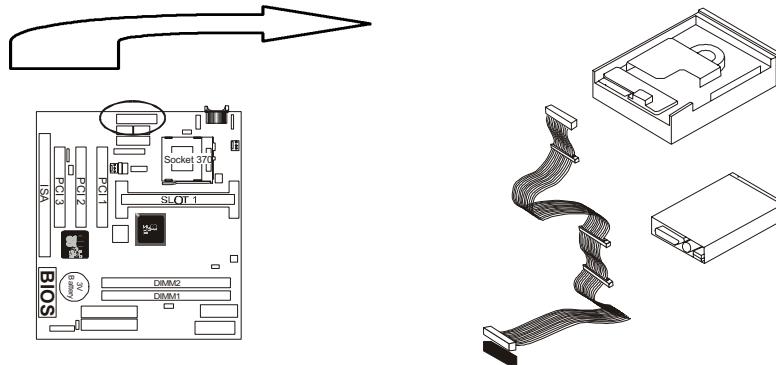

IDE Cables for HDD and CDROM

Your motherboard comes with two IDE interfaces—a primary and a secondary connector. Each channel supports two IDE devices via a 34-pin flat cable, and the system is capable of supporting a maximum of four devices.

Note: If you want to connect any ATA66 device on IDE Port, please use the specified cable of ATA66. Regarding to the relate information of ATA devices, please refer the instruction of ATA66 devices supplier.

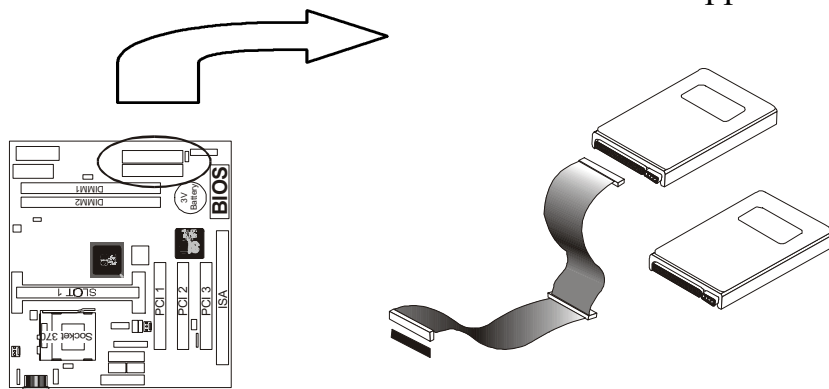

Chapter 3

Award BIOS Setup

This chapter explains how to use and modify the BIOS setup utility that is stored on the motherboard. The setup utility stores information about the motherboard components, and the configuration of other devices that are connected to it. The system uses this information to test and initialize components when it is started up, and to make sure everything runs property when the system is operating.

The setup utility is installed with a set of default values. The default values are designed to ensure that the system will operate adequately. You will probably have to make changes to the setup utility whenever you add new components to your system such as new disk drives. You may be able to generate increased performance by changing some of the timing values in the setup, but this can be limited by the kind of hardware you are using, for example the rating of your memory chips. In certain circumstances, the system may generate an error message which asks you to make changes to the setup utility. This happens when the system finds an error during the POST (power on self test) that it carries out at start up.

Starting the Setup Utility

You can only start the setup utility shortly after the computer has been turned on. A prompt appears on the computer display which says "**Press DEL to run Setup**". When you see this prompt press the **Delete** key, and the system will start the setup utility and display the main menu of the utility.

Using the Setup Utility

When you press the **Delete** key to start setup, the main menu of the utility appears.

The main menu of the setup utility shows a list of the options that are available in the utility. A highlight shows which option is currently selected. You can use the cursor arrow keys to move the highlight to other options.

When an option is highlighted, you can execute the option by pressing the **Enter** key. Some options lead to dialog boxes which ask you verify that that you wish to execute that option. You usually answer these dialogs by typing **Y** for yes and **N** for no.

Some options lead to dialog boxes which ask for more information. Setting the User Password or Supervisor Password has this kind of dialog box.

PRESS F1 TO CONTINUE, CTRL-ALT-ESC OR DEL TO ENTER SETUP

Control Keys

Up Arrow	Move to previous item
Down Arrow	Move to next item
Left Arrow	Move to the item in the left hand
Right Arrow	Move to the item in the right hand
Esc Key	Main Menu Quit and not to save changes to CMOS Status Page setup menu and Option Page Setup Menu Exit current page and return to Main Menu
PgUp Key	Increase the numeric value or make changes
PgDn Key	Decrease the numeric value or make changes
F1 Key	General help, only for Status Page Setup Menu and Option Setup Menu
F2 Key	Change color from total 16 colors
F3 Key	Calendar, only for Status Page Setup Menu
F4 Key	Reserved
F5 Key	Restore the previous CMOS value from BIOS, only for Option Page Setup Menu
F6 Key	Load the default CMOS value from BIOS default table, only for Option Page Setup Menu
F7 Key	Load the default
F8 Key	Reserved
F9 Key	Reserved
F10 Key	Save all the CMOS changes, only for Main Menu

3.1 The Main Menu

Once you enter Award BIOS CMOS Setup Utility, the Main Menu will appear on the Screen. Use arrow keys to select among the items and press to accept or enter the **sub-menu**.

Some options lead to tables of items. These items usually have a value on the right side. The value of the first item is highlighted, and you can use the cursor arrow keys to select any of the other values in the table of items. When an item is highlighted, you can change the value by pressing the **PageUp** or **PageDown** keys, or the **Plus** or **Minus** keys. The **PageUp** and **Plus** keys cycle forward through the available values, the **PageDown** and **Minus** keys cycle backwards through the values.

When you are in the main menu, you can exit the utility by pressing the **Escape** key. You can save the current selections and exit the utility by pressing the F10 key. You can change the color scheme of the utility by pressing the **F2** key **while** holding down **the Shift** key. When you are in one of the options that displays a dialog box, you can return to the main menu by pressing the **Escape** key.

When you are in one of the options that displays a table of items, you can return to the main menu by pressing the **Escape** key. For some items, you can display a help message by pressing the **F1** key. You can change the color scheme of the utility by pressing **the F2** key while holding down **the Shift** key. You can press **FS** to discard any changes you have made and return all items to the value **that** they held when the setup utility was started. You can press **F6** to load the displayed items with a list of default values. You can press **F7** to load the displayed items with a **high-performance** list of default values.

ROM PC/ISA BIOS (2A6INPNA)
CMOS SETUP UTILITY
AWARD SOFTWARE, INC.

STANDARD CMOS SETUP	INTEGRATED PERIPHERALS
BIOS FEATURE SETUP	SUPERVISOR PASSWORD
CHIPSET FEATURES SETUP	USER PASSWORD
POWER MANAGEMENT SETUP	IDE HDD AUTO DETECTION
PNP/PCI CONFIGURATION	SAVE & EXIT SETUP
LOAD BIOS DEFAULTS	EXIT WITHOUT SAVING
LOAD SETUP DEFAULTS	
Esc : Quit F10 : Save & Exit Setup	↑ ↓ → ← : Select Item (Shift) F2 : Change Color

Standard CMOS Setup

This setup page includes all the items in a standard compatible BIOS.

BIOS Features Setup

This setup page includes all the items of Award special enhanced features.

Chipset Features Setup

This setup page includes all the items of chipset special features.

Power Management Setup

This menu provides functions for Green products by allowing users to set the timeout value for monitor and HDD.

PNP / PCI CONFIGURATION SETUP

This menu allows the user to modify PNP / PCI configuration function.

Load BIOS Defaults

BIOS defaults indicates the most appropriate value of the system parameter which the system would be in minimum performance.

Load Setup Defaults

Chipset defaults indicates the values required by the system for the maximum performance.

INTEGRATED PERIPHERALS

This section page includes all the items of IDE hard drive and Programmed Input / Output features.

Supervisor / User Password Setting

Change, set, or disable password. It allows you to limit access to the system and Setup, or just to setup.

IDE HDD Auto Detection

Automatically configure hard disk parameters.

Save & Exit Setup

Save CMOS value changes to CMOS and exit setup.

Exit Without Saving

Abandon all CMOS value changes and exit setup.

3.2 Standard CMOS Setup

The item in Standard CMOS Setup Menu are divided into several categories. Each category includes no, one or more than one setup items. Use the arrow keys to highlight the item and then use the <PgUp> or <PgDn> keys to select the value you want in each item.

da_2bUj A[eS2Tj ae2 DSH `b` S; ef`S` VsdV2U ae2eWgb Si SdV2eaXfi SdW2j `U@									
Vs`w2: @ELvL` ; 2L2fz%2\%2C2CKK f{ 6w2 zzL@ELj; 2L2CD2L2L2L2FE									
ZSdV2M[e	fkBW	e[1W	Uk^e	ZV8V	bdW@a_b	^S`M	eWf ad	_aVW	
b{ {6s+ 2_s+`w 2222222B		B	B	B	B	B	B	B	NORMAL
b{ {6s+ 2e-sSw2222222B22		B	B	B	B	B	B	B	NORMAL
evuf, vs+ 2_s+`wL	B	B	B	B	B	B	B	B	NORMAL
evuf, vs+ 2e-sSwL	B	B	B	B	B	B	B	B	NORMAL
V{ {Sw2S222L2C@F_>2E@C2{ , @ V{ {Sw2I222L2`f, w X-f, .. 2E2_fvw2e%a, f+ 2L2M jst~w					2222Ts+vw2_vEj+ L22222Bj WEw vvw2_vEj+ L22222Bj 222a`zw+2_vEj+ L2222GDj				
h{ vwj2222L2WSAhYS Zs~ 2a, 22L2S-->2T%2j w t fs+ v					222f`f` s~2_vEj+ L2222GDj				
W@L222L22c%o									
Xc2222L22Zw,									

Date and Time

The Date and Time items show the current date and time held by your computer. If you are running a Windows operating system, these items will automatically be updated whenever you make changes to the Windows Date and Time Properties utility.

Hard Disks

Default: Auto

These items show the characteristics of any hard disk drives on the four available IDE channels. (Note that SCSI hard disk drives do not appear here.) You can automatically install most modem hard disks using the IDE HDD Auto Detect Option from the main menu. However, if you find that a drive cannot be automatically detected, you can use these items to select USER, and then manually enter the characteristics of the drive. The documentation provided with your drive provides the data you need to fill in the values for CYLS (cylinders), HEAD (read/write heads), and so on.

The documentation provided with the drive may not tell you what value to use under the MODE heading. If the drive is smaller than 528 NM, set MODE to Normal. If the drive is larger dm 528 NM and it supports Logical Block Addressing, set MODE to LBA- Very few high-capacity drives do not support Logical Block Addressing. If you have such a drive, you might be able to configure it by setting the MODE to Large. If you're not sure which MODE setting is required by your drive, set MODE to Auto and let the setup utility try to determine the mode automatically.

Drive A and Drive B

Default: 1.44M, 3.5 in., None

These items define the characteristics of any diskette drive attached to the system. You can connect one or two diskette drives.

Floppy 3 Mode Support

Default: Disabled

Floppy 3 mode refers to a 3.5" diskette with a capacity of 1.2MB. Floppy 3 mode is sometimes used in Japan.

Video

Default: Disabled

This item defines the video mode of the system. This motherboard has a built-in VGA graphics system so you must leave this **item** at the default value.

Halt On

Default: All. But Keyboard

This item defines the operation of the system POST (Power On Self Test)

routine. You can use this item to select which kind of errors in the POST is sufficient to halt the system.

Base, Extended and Other Memory *Default: All. But Keyboard*

These items show how much memory is available on the system. They are automatically detected by the system so you cannot manually make changes to these items.

3.3 BIOS Features Setup

This option displays a table of items which defines more advanced information about your system. You can make modifications to most of these items without introducing fatal errors to your system.

ROM PCI/ISA BIOS (2A6INPNA)
BIOS FEATURE SETUP
AWARD SOFTWARE, INC

Anti-Virus Protection	: Enabled	Video BIOS Shadow	: Enabled
CPU Internal Cache	: Enabled	C8000-CBFFF Shadow	: Disabled
External Cache	: Enabled	CC000-CFFFF Shadow	: Disabled
Quick Power On Self Test	: Enabled	D0000-D3FFF Shadow	: Disabled
Boot Sequence	: A, C ,SCSI	D4000-D7FFF Shadow	: Disabled
Swap Floppy Drive	: Disabled	D8000-DBFFF Shadow	: Disabled
Boot Up Floppy Seek	: Disabled	DC000-DFFFF Shadow	: Disabled
Boot Up NumLock Status	: On		
IDE HDD Block Mode	: Enabled		
IDE 32-bit Transfer Mode	: Enabled		
Typematic Rate Setting	: Disabled		
Typematic Rate (Chars/Sec)	: 6		
Typematic Delay (Msec)	: 250		
Security Option	: Setup		
PCI/VGA Palette Snoop	: Disabled		
OS Select For DRAM > 64MB	: Non-OS2	Esc : Quit	↑↓→← : Selection Item
HDD S.M.A.R.T. capability	: Enabled	F1 : Help	PU/PD/+/- : Modify
Report No FDD For Win95	: No	F5 : Old Values	(Shift) F2 : Color
		F6 : Load BIOS Defaults	
		F7 : Load Setup Defaults	

Anti-Virus Protection

Default: Enabled

Anti-Virus program could locate and remove the problem before any damage is done. So when this item is enabled, the Award BIOS will monitor the boot sector and partition table of the hard disk drive for any attempt at modification. If an attempt is made, the Anti-Virus program built-in the BIOS will be run for protecting your system to be clean.



WARNING:

Disk boot sector is to be modified
Type 'Y' to accept write or 'N' to abort write
Award Software, Inc.

Enabled : Activates automatically when the system boots up, if anything attempts to access the boot sector or hard disk partition table will cause a warning message to **appear**.

Disabled : No warning message will appear when anything attempts to access the boot **sector or hard disk partition table**.

Many disk diagnostic programs which attempt to access the boot sector table can cause the above warning message.

CPU Internal Cache

Default: Enabled

All the processors that can be installed in this motherboard use internal (level 1) cache memory to improve performance. Leave this item at the default value Enabled for better performance.

External Cache

Default: Enabled

Most of the processor cartridges that can be installed in this motherboard have (level 2) external cache memory (the Celeron-266MHz is an exception). Only enable this item if your processor cartridge has external cache memory.

Quick Power On Self Test

Default: Enabled

This category speeds up Power On Self Test (POST) after you power up the computer. If it is set to Enable, BIOS will shorten or skip some check items during POST.

Boot Sequence**Default: A, C, SCSI**

This item defines where the system will look for an operating system, and the order of priority. You can boot an operating system from many locations including a SCSI device, a ZEP drive, a floppy diskette drive, or an LS-120 high-capacity diskette drive.

Swap Floppy Drive**Default: Disabled**

This item allows you to determine whether enable the swap floppy drive or not.

Boot Up Floppy Seek**Default: Disabled**

During POST, BIOS will determine if the Floppy disk drive installed is 40 or 80 tracks. 360 K type is 40 tracks while 720K, 1.2M and 1.44M drive type as they are all 80 tracks.

Enabled: BIOS searches for floppy disk drive to determine if it is 40 or 80 tracks. Note that BIOS can not tell from 720K, 1.2M or 1.44M drive type as they are all 80 tracks.

Disabled: BIOS will not search for the type of floppy disk drive by track number. Note that there will not be any warning message if the drive installed is 360K.

Boot Up NumLock Status**Default: On**

This item defines if the keyboard Num Lock key is active when your system is started.

IDE HDD Block Mode**Default: Enabled**

This item can let you save the time of hard disk saving or reading data, if you enable this function.

IDE 32-bit Transfer Mode**Default: Enabled**

When this item is enabled, the data will be transferred by 32-bit mode, otherwise the data be transferred by 16-bit mode.

Typematic Rate Setting**Default: Disabled**

This determines if the typematic rate is to be used. When disabled, continually holding down a key on your keyboard will generate only one key instance. In other words, the BIOS will only report that the key is down. When the typematic rate is enabled, the BIOS will report as before, but it will then wait a moment, and, if the key is still down, it will begin the report that the key has been depressed repeatedly. For example, you would use such a feature to accelerate cursor movements with the arrow keys.

Typematic Rate (Chars/Sec)**Default: 6**

When the typematic rate is enabled, this section allows you select the rate at which the keys are repeat.

<u>6</u>	<u>6 characters per second</u>	<u>15</u>	<u>15 characters per second</u>
<u>8</u>	<u>8 characters per second</u>	<u>20</u>	<u>20 characters per second</u>
<u>1 0</u>	<u>1 0 characters per second</u>	<u>24</u>	<u>24 characters per second</u>
<u>12</u>	<u>12 characters per second</u>	<u>30</u>	<u>30 characters per second</u>

Typematic Delay (Msec)**Default: 250**

When the typematic rate is enabled, this section allows you select the delay between when the key was first depressed and when the acceleration begins.

<u>250</u>	<u>250 msec</u>
<u>500</u>	<u>500 msec</u>
<u>750</u>	<u>750 msec</u>
<u>1000</u>	<u>1000 msec</u>

Security Option**Default: Setup**

If you have installed password protection, this item defines if the password is required at system start up, or if it is only required when a user tries to enter the setup utility.

PCI/VGA Palette Snoop**Default: Disabled**

This item can help overcome problems that are caused by some non-standard VGA cards. We recommend that you leave this item at the default value Disabled.

OS Select For DRAM > 64 MB**Default: Non-OS2**

This item is required if you have installed more than 64 NM of memory and you are running the OS/2 operating system. Otherwise, leave this item at the default Non-OS2.

HDD S.M.A.R.T capability**Default: Enabled**

S.M.A.R.T is an industry acronym for Self-monitoring, Analysis and Reporting Technology. If the documentation of your hard disk states that S.M.A.R.T. is supported, you can enable this item.

Report No FDD For WIN 95**Default: No**

Set this item to Yes BIOS will report FDD to Win95. If in standard CMOS setup, set Drive A to none, and set this item to yes. Inside Win95, My Computer and File manager Disk(A:) will show Removable Disk (A:).

Video BIOS Shadow

Default: Enabled

This item allows the video BIOS to be copied to system memory for faster performance.

XXXXX-XXXXX Shadow

Default: Disabled

These items allow the BIOS of other devices to be copied to system memory for faster performance.

3.4 Chipset Features Setup

This option displays a table of items which define timing parameters of the motherboard components including the graphics system, the memory, and the system logic. In general rule, you should leave the items on this page at the default values unless you are very familiar with the technical specifications of your hardware. If you change the values, you may introduce fatal errors or recurring instability into your system.

Your CPU will be detected and setup by our motherboard automatically. If you want select the kind of CPU Clock Frequency and CPU Frequency Ratio you want. In this section, you can do these functions by yourself, but not all CPU being compatible by every choice, please refer your CPU specifications to set these function firstly.

ROM PCI/ISA BIOS (2A6INPNA)
 CHIPSET FEATURES SETUP
 AWARD SOFTWARE, INC

Auto Configuration	: Enabled	Auto Detect DIMM/PCI Clk	: Enabled
RAS Pulse Width Refresh	: 5T	Spread Spectrum Modulated	: Disabled
RAS Precharge Time	: 3T	CPU Host/SDRAM Clock	: Default
RAS to CAS Delay	: 3T	CPU Clock Ratio Jumpless	: Disabled
ISA Bus Clock Frequency	: PCICLK/4		:
Starting Point of Paging	: 1T		:
SDRAM CAS Latency	: 3T		:
SDRAM WR Retire Rate	: X-1-1-1		:
CPU to PCI Burst Mem. WR	: Enabled		:
System BIOS Cacheable	: Enabled		:
Video RAM Cacheable	: Enabled		:
Memory Hole at 15M-16M	: Disabled		:
AGP Aperture Size	: 64MB		:
Concurrent function (MEM)	: Enabled		:
Concurrent function (PCI)	: Enabled		:
CPU Pipeline Control	: Enabled		:
PCI Delay Transaction	: Enabled		:
Power-Supply Type	: ATX		:
		Esc : Quit	↑↓→← : Selection Item
		F1 : Help	PU/PD/+/- : Modify
		F5 : Old Values	(Shift) F2 : Color
		F6 : Load BIOS Default	
		F7 : Load Setup Default	

Auto Configuration**Default: Enabled**

This function can make BIOS auto-setting the best DRAM parameter.

RAS Pulse Width Refresh**Default: 5T****RAS Precharge Time****Default: 4T****RAS to CAS Delay****Default: 4T**

These items install the settings for the Row Address Strobe (RAS) and the Column Address Strobe (CAS). The RAS and CAS determine the timing of the system's access to the main memory. We recommend that you leave these items at the default values.

ISA Bus Clock Frequency**Default: PCICLK/4**

This item sets the timing for the ISA bus by dividing the frequency of the PCI bus. The PCI bus is usually set to 33 MHz, and we recommend that you divide this by four to set the ISA bus frequency.

Starting Point of Paging**Default: 1T**

This item controls the start timing of memory paging operations. We recommend that you leave this item at the default setting.

SDRAM CAS Latency**Default: 3T****SDRAM WR Retire Rate****Default: X-1-1-1**

These items set the timing parameters for the installed SDRAM (Synchronous Dynamic Random Access Memory). We recommend that you leave these items at the default values.

CPU to PCI Burst Mem. WR**Default: Enabled**

Writes from the CPU to the PCI bus are buffered when this item is enabled, to compensate for the difference in speed between the CPU and the PCI bus. The writes are not buffered and the CPU must wait until the write is complete before starting another write cycle when the item is disabled. We recommend that you leave this item at the default value Disabled.

System BIOS Cacheable**Default: Enabled**

This item allows the system BIOS to be cached for faster performance. We recommend that you leave this item at the default value enabled.

Video RAM Cacheable**Default: Enabled**

Video RAM segment is cacheable if this item been enable.

Memory Hole at 15M-16M**Default: Disabled**

In order to improve performance, certain space in memory can be reserved for ISA cards. This memory must be mapped into the memory below 16MB.

AGP Aperture Size**Default: 64 MB**

Select the size of the AGP aperture. The aperture is a portion of the PCI memory address range dedicated for graphics memory address space. Host cycle that hit the aperture range are forwarded to the AGP without any translation. The choice 4, 8, 16, 32, 64, 128, 256.

Concurrent Function(MEM)**Default: Enabled****Concurrent Function(PCI)****Default: Enabled**

These items define the properties and the operation of the system memory controller. We recommend that you leave these items at the default value.

CPU Pipeline Control**Default: Enabled**

Pipelining allows the system controller to signal the CPU for new memory addresses even before all data transfers for the current cycle are complete, resulting in increased throughput.

PCI Delay Transaction**Default: Enabled**

If the chipset has an embedded 32-bit write buffer to support delay transaction cycles, you can enable this item to provide compliance with PCI Ver.2.1 specifications. We recommend that you leave this item at the default value Enabled.

Power-Supply Type**Default: ATX**

This item allow you to select power supply type, if you want use AT power supply, please select “AT”. As same way, when you use ATX power supply, you must be sure this item is selected “ATX”.

Auto Detect DIMM/PCI Clk**Default: Enabled**

If this item is enabled, the unused DIMM and PCI slot clock will be disabled. If this item is disabled the unused DIMM and PCI slot will still get the active clock signal.

Spread Spectrum**Default: Disabled**

Enable / Disable this item the BIOS will Enable / Disable the clock generator spread spectrum .

CPU Host/ SDRAM Clock**Default: Default**

There are 16 sets of Host/SDRAM clock, you can choose anyone you want. If your Intel Pentium® CPU doesn't support an external bus speed of 100MHz or other kind of clock, you can still set your motherboard's external bus speed to 100MHz or other kind of clock. But we recommend that you follow the default value.

CPU Clock Ratio Jumpless**Default: Disabled**

There are 14 sets of CPU clock ratio, you can choose anyone you want. If you want to overclock the speed of your CPU, you can refer above item – CPU Host/SDRAM Clock and this item – CPU Clock Ratio to change the speed of your CPU. But we don't promise your system will be stable when your system under the overclock condition. So we recommend that you follow the default value.

3.5 Power Management

This option displays a table of items that lets you control the system's power management. Modern operating systems take care of many routine power management chores. This motherboard supports ACPI (advanced configuration and power interface).

This system supports three power-saving modes: doze mode, standby mode and suspend mode. Standby mode uses less power than doze mode, while suspend mode uses the least amount of power.

ROM PCI/ISA BIOS (2A6INPNA)
POWER MANAGEMENT SETUP
AWARD SOFTWARE, INC.

ACPI function	: Enabled	VGA Activity	: Enabled
Power Management	: User Define	IRQ [3-7, 9-15], NMI	: Enabled
PM Control by APM	: Yes	IRQ 8 Break Suspend	: Disabled
Video Off Option	: Susp, Stby -> Off	Power Button Over Ride	: Instant Off
Video off Method	: V/H SYNC+Blank	Ring Power Up Control	: Enabled
Switch Function	: Break/Wake	LAN Power Up Control	: Enabled
Doze Speed (div by)	: 2/8	KB Power ON Password	: Enter
Standby Speed (div by)	: 1/8	Power Up by Alarm	: Disabled
MODEM Use IRQ	: 3		
PM Timers			
HDD Off After	: Disable		
Doze Mode	: Disable		
Standby Mode	: Disable		
Suspend Mode	: Disable		
PM Events			
HDD Ports Activity	: Enabled	ECS : Quit	↑↓→← : Selection Item
COM Ports Activity	: Enabled	F1 : Help	PU / PD / + / - : Modify
LPT Ports Activity	: Enabled	F5 : Old Values	(Shift)F2 : Color
		F6 : Load BIOS Defaults	
		F7 : Load Setup Defaults	

The power management function in the setup utility lets you specify timeout periods for the activation of each of the power-saving modes, as well as a timeout period for a hard disk drive power down. A timeout is simply a period of system or hard disk inactivity. At the end of a timeout, your computer may enter a power-saving mode or its hard disk drive may power down, depending on how you have configured your system.

If your PC has entered a power-saving mode, you can awaken your computer by carrying out any of the activities that are enabled on the Reload Global Timer Events list. If the hard disk has been powered down, it will automatically power up again whenever access to the hard disk is required (this typically takes only a few seconds).

ACPI function**Default: Enabled**

When Enabled, this function can save the power of your system.

Power Management**Default: User Define**

This category allows you to select the type (or degree) of power saving and is directly related to the following modes : Doze; Standby; Suspend; HDD Power Down.

Min.Power Saving	Minimum power management. Doze =1 hr.; Standby= 1 hr.; Suspend= 1 hr.; HDD Power <u>Down=15min</u>
Max. Power Saving	Maximum power management only available for SL CPU.Doze=1min.; Standby=1min.;Suspend=1 min.;HDD <u>Power Down= 1 min</u>
User Defined	Allows you to set each mode individually. When not disabled, each of the ranges are from 1 min. to 1 hr. except for HDD Power Down which ranges from 1 to 15min. and <u>disable</u>

If you would like to use Software Power-off Control function, you cannot choose " Disabled "here, and should select "Yes" in PM Control by APM.

PM Control by APM**Default: Yes**

Windows 95 and 98 have built-in power management capabilities called APM (advanced power management). When you enable this item, you allow the APM routines in Windows to operate on your system.

Video Off Option**Default: Susp, Stby -> Off**

When enabled, this feature allows the VGA adapter to operate in a power saving mode.

N/A	Monitor will remain on during power saving modes.
Suspend	Monitor blanked when the systems enters the Suspend mode.
Standby	Monitor blanked when the system enters Standby mode.

Doze Monitor blanked when the system enters any power saving mode.

Video Off Method**Default: V/H SYNC+Blank**

This determines the manner in which the monitor is blanked.

V/H SYNC+ Blank	This selection will cause the system to turn off the vertical and horizontal sync. ports and write blanks to the video buffer
Blank Screen	This option only writes blanks to the video buffer
DPMS	Initial display power management signaling

Switch Function**Default: Break/Wake**

If this item is enabled, it permits the use of a suspend switch (connected to J17- Other Jumper Setting, See Chapter 2). If the item is set to Break, the suspend switch puts the system in suspend mode. If the item is set to Break, the suspend switch puts the system in suspend mode. If the item is set to Break/Wake, you can press the suspend switch a second time to wake up the system. If the item is set to Disabled, the suspend switch does not function.

Doze Speed (div by)**Default: 2/8**

The item defines the clock speed of the CPU when the system is in the Doze power saving mode. As a default, the CPU will run at a quarter of its rated speed.

Stby Speed (div by)**Default: 1/8**

This item defines the clock speed of the CPU when the system is in the Standby power saving mode. As a default, the CPU will run at a 1/8 of its rated speed.

MODEM Use IRQ**Default: 3**

This item determines the IRQ in which the MODEM can be used.
The choice: 3,4,5,7,9, 10,11,N/A.

HDD Off After**Default: Disable**

You can use this item to set a timeout for a hard disk powerdown. You can set a time from 1 to 15 minutes. If the hard disk is inactive for the time specified, it will power down. It will automatically return to full power when it is next accessed.

Doze Mode**Default: Disable**

If you have selected User Define for the Power Management item, you can set this item to a selection of timeouts from 10 seconds to 4 hours.

Standby Mode**Default: Disable**

If you have selected User Define for the Power Management item, you can set this item to a selection of timeouts from 10 seconds to 4 hours.

Suspend Mode**Default: Disable**

If you have selected User Define for the Power Management item, you can set this item to a selection of timeouts from 10 seconds to 4 hours.

HDD Ports Activity**Default: Enabled**

When this item is enabled, any activity on the disk drives connected to the system can reset power-saving mode timeouts to zero, or resume the system from a power saving mode.

COM Ports Activity**Default: Enabled**

When this item is enabled, any transmission through the serial ports connected to the system can reset power-saving mode timeouts to zero, or resume the system from a power saving mode.

LPT Ports Activity**Default: Enabled**

When this item is enabled, any transmission through the parallel ports connected to the system can reset power-saving mode timeouts to zero, or resume the system from a power saving mode.

VGA Activity**Default: Enabled**

When Enabled, any video active restarts the global timer for standby mode.

IRQ [3-7, 9-15], NMI**Default: Enabled**

When enabled, an event occurring on each device listed below restarts the global time for Standby mode.

IRQ 8 Break Suspend**Default: Disabled**

When enabled, the device which occupies the IRQ8 can wake up the system.

Power Button Over Ride**Default: Instant Off**

Under ACPI (advanced configuration and power interface) the system can be turned off mechanically (by the power button) or it can undergo a software

power off. If the system has been turned off by software, the system can be resumed by a LAN, MODEM or ALARM wake up signal. This item allows you to define a software power off using the power button. If the value is set to Instant-Off, the power button will automatically cause a software power off. If the value is set to Delay 4 Sec. the power button must be held down for a full four seconds to cause a software power off.

Ring Power Up Control

Default: Enabled

When this item is enabled, any activity through an internal modem that is connected to the Wake On Modem connector can resume the system from a power saving mode or a software power off.

LAN Power Up Control

Default: Enabled

Enabled: If you have installed LDCM administrator software, and any client side is powered off, you can wake up by LAN through the LDCM mechanism.

KB Power ON Password

Default: Enter

If your system is installed with a keyboard power on capability, this item lets you add a password that must be typed on the keyboard in order to turn on the power.

Power Up by Alarm

Default: Enabled

If you enabled this item, new fields appear which let you set a date and time for an alarm that can resume the system from a power saving mode or a software power off.

3.6 PNP/PCI Configuration Setup

The PNP/PCI Configuration Setup allows you to configure the ISA and PCI devices installed in your system. The following screen appears if you select the option PNP/PCI Configuration setup from the main menu.

ROM PCI/ISA BIOS(2A6INPN9)
 PNP/PCI CONFIGURATION
 AWARD SOFTWARE, INC.

PNP OS Installed : No Resources Contorlled By : Manual Reset Configuration Data : Disabled IRQ-3 assigned to : PCI/ISA PnP IRQ-4 assigned to : PCI/ISA PnP IRQ-5 assigned to : PCI/ISA PnP IRQ-7 assigned to : PCI/ISA PnP IRQ-9 assigned to : PCI/ISA PnP IRQ-10 assigned to : PCI/ISA PnP IRQ-11 assigned to : PCI/ISA PnP IRQ-12 assigned to : PCI/ISA PnP IRQ-14 assigned to : PCI/ISA PnP IRQ-15 assigned to : PCI/ISA PnP DMA-0 assigned to : PCI/ISA PnP DMA-1 assigned to : PCI/ISA PnP DMA-3 assigned to : PCI/ISA PnP DMA-5 assigned to : PCI/ISA PnP DMA-6 assigned to : PCI/ISA PnP DMA-7 assigned to : PCI/ISA PnP	Assign IRQ For VGA : Enabled NCR/SYMBIOS SCSI ROM : Auto ESC: Quit ↑↓→←: Select Item F1 : Help PU / PD / + / - : Modify F5 : Old Values (Shift)F2 : Color F6 : Load BIOS Defaults F7 : Load Setup Defaults
---	--

PNP OS Installed

Default: No

If you have installed a Plug and Play **operating** system such as Windows 95 or 98, you can change this item to Yes. When the item is set to Yes you can use the Device Manager utility in the operating system to make changes to the configuration of expansion cards.

Resources Controlled By

Default: Manual

You should leave this item at the default Auto. If you find that you cannot get a particular expansion card to work properly, you might be able to solve the problem by changing this item to Manual, and defining the characteristics of the card in the new items which appear.

If you change this item to Manual, the display will list a series of items that

allow you to define the assignments of the system interrupt lines (IRQS) and Direct Memory Access (DMA) channels. As a default, these items are set to PCI/ISA PnP. If you install an ISA Bus card that does not support PNP, and it requires a special IRQ and DMA, you can modify the list of assignments. Change the values of the IRQ and DMA that are required to Legacy ISA.

Reset Configuration Data

Default: Disabled

If you enable this item and restart the system, any PNP configuration data stored in the BIOS setup will be cleared from memory. New updated configuration data will be created.

IRQ 3/4/5/7/9/10/11/12/14/15

DMA 1/3/5/6/7

This item allows you to determine the IRQ/DNM assigned to the ISA bus and is not available to any PCI slot. Choices are Legacy ISA and PCI/ISA PnP.

Assign IRQ For VGA

Default: Enabled

To assign a IRQ to VGA card if you enable this item.

NCR/SYMBIOS SCSI ROM

Default: Auto

If you want to use the SCSI interface card with NCR type booting your system, you can select “Auto” for it.

3.7 Integrated Peripherals

This option displays a list of items which **defines** the operation of some peripheral items on the system's input/output ports.

ROM PC/ISA BIOS(2A6INPNA)
 INTEGRATED PERIPHERALS
 AWARD SOFTWARE, INC.

Internal PCI/IDE	: Both	PS/2 mouse function	: Enabled
IDE Primary Master PIO	: Auto	USB Controller	: Enabled
IDE Primary Slave PIO	: Auto	USB Keyboard Support	: Disabled
IDE Secondary Master PIO	: Auto	Init Display First	:
IDE Secondary Slave PIO	: Auto	VGA Shared Memory Size	: 8 MB
Primary Master UltraDMA	: Auto	Onboard Sound Chip	: Enabled
Primary Slave UltraDMA	: Auto		
Secondary Master UltraDMA	: Auto	Current CPU Temperature	:
Secondary Slave UltraDMA	: Auto	Current CPUFAN1 Speed	:
IDE Burst Mode	: Enabled	Current CPUFAN2 Speed	:
Onboard FDC Controller	: Enabled	IN0(V):	IN1(V):
FDC Write Protect	: Disabled	IN2(V):	IN3(V):
Onboard Serial Port 1	: 3F8/IRQ4		
Onboard Serial Port 2	: 2F8/IRQ3		
IR Address Select	: Disable		
		Esc : Quit	↑↓→← : Selection Item
Onboard Parallel Port 1	: 378/IRQ7	F1 : Help	PU/PD/+/- : Modify
Parallel Port Mode	: EPP	F5 : Old Values	(Shift) F2 : Color
		F6 : Load BIOS Default	
		F7 : Load Setup Default	

Internal PCI/IDE

Default: Both

This item lets you enable or disable the primary and secondary PCI/IDE channels that are integrated into this motherboard. Leave this item at the default value unless you intend using other IDE channels installed on an expansion card.

IDE Primary Master/Slave PIO

Default: Auto

IDE Secondary Master/Slave PIO

PIO - Programmed Input / Output, it allows the BIOS to tell the controller what it wants and then let the controller and the CPU to complete the task by themselves. This is simpler and more faster. Your system supports five modes,

0 - 4, which primarily differ in timing. When **Auto** is selected, the BIOS will select the best available mode.

Primary Master/Slave UltraDMA *Default: Auto*

Secondary Master/Slave UltraDMA *Default: Auto*

Auto, will support the Ultra DMA function. Disabled, will not support the Ultra DMA function.

IDE Burst Mode *Default: Enabled*

Burst mode transfer can improve the access to IDE devices. Enable this item for improved performance. If your IDE drives cannot support high performance, or if you feel that too many disk errors are being generated, disable this item.

Onboard FDC Controller *Default: Enabled*

Use this item to turn on or off the floppy disk controller that is built into this motherboard.

FDC Write Protect *Default: Disabled*

To enable/disable the write protection of floppy.

Onboard Serial Port 1 *Default: 3F8/IRQ4*

User can select serial port IRQ. If set to Auto, system will assign an IRQ for it. Note : Set to Auto is not recommended.

Onboard Serial Port 2 *Default: 2F8/IRQ3*

User can select serial port IRQ. If set to Auto, system will assign an IRQ for it. Note : Set to Auto is not recommended.

IR Address Select *Default: Disable*

This item will enable or disable the IR address controller.

Onboard Parallel Port *Default: 378/IRQ7*

This item lets you disable the built-in parallel port, or enable it by assigning an I/O address and an Interrupt Request Line (IRQ).

Parallel Port Mode *Default: ECP+EPP*

This item defines the operation of the parallel port. As a default it is set to ECP + EPP. If you are connected to a parallel device that supports the higher-performance EPP (enhanced parallel port) or the ECP (extended capabilities port) make the

appropriate changes to this item. If you change the parallel port to EPP or ECP, new items appear that let you configure the EPP and ECP modes.

PS/2 mouse function**Default: Enabled**

This item lets you disable the PS/2 mouse connector on this system. You should disable this item if you are using a mouse or printing device which connects through a serial port.

USB Controller**Default: Enabled**

This item lets you enable or disable the USB ports that are integrated into this motherboard.

USB Keyboard Support**Default: Disabled**

Enable this item if you are using a keyboard connected through the USB interface.

Init Display First**Default: PCI**

Use this item to define if your graphics adapter is installed in one of the PCI slots, or if you have installed an AGP graphics adapter into the AGP slot.

VGA Shared Memory Size**Default: 8MB**

You can select the share memory size on this item, but if you want have better display speed and keep your main memory not be shared on VGA function, you should select more memory size.

Onboard Sound Chip**Default: Enabled**

Use this item to Enable or disable the onboard audio function. If you want to add other sound card on expansive slots, you should disable this item, otherwise you enable this item that you can enjoy the music from onboard Sound Chip.

Current CPU Temperature**Current CPUFAN1 Speed****Current CPUFAN2 Speed****IN0(V), IN1(V), IN2(V), IN3(V)**

These items are for hardware monitoring features of this system, so if your motherboard has this function that you can use it (Please refer Chapter 1).

3.8 Supervisor Password & User Password

These two items can be used to install a Supervisor Password and a User Password. If you log on as Supervisor, you have full access to the system, and you can restrict the permissions granted to someone who logs on as User. For example, a Supervisor can restrict a User from entering the setup utility.

To install a Supervisor or User Password, follow these steps:

1. Highlight the item Supervisor/User password on the main menu and press **Enter**.
2. The password dialog box will appear.
3. If you are installing a new password, carefully 4W in the password. You cannot use more than 8 characters or numbers. The password will differentiate between upper case and lower characters. Press **Enter** after you have typed in the password. If you are deleting a password that is already installed just press **Enter** when the password dialog box appears.
4. The system will ask you to confirm the new password by asking you to type it in a second time, Carefully type the password again and press **Enter**, or just press **Enter** if you are deleting a password that is already installed.
5. If you type the password correctly, the password will be installed.

3.9 IDE HDD Auto Detection Option

This feature allows you to check all the information on your hard disk formation. When you access "IDE HDD Auto Detection", the system executes auto detection.

At the prompt, it represents all the information on your HDD, and you are asked:

Do you accept this drive C: (Y/N) ?

1. If you accept the test result, press [Y] then [Enter] and the result is saved, then the system continues to detect another HDD.
7. If not, press [N] then [enter] and the system continues to detect another HDD.

3.10 Save and Exit Setup Option

This allows you to save the new setting values in the CMOS memory and continue with the booting process. Select what you want to do, press <Enter>.

3.11 Exit Without Saving Option

This allows you to exit the BIOS setup utility without recording any new values or changing old ones.

Highlight this item and press **Enter** to save the change that you have made in the setup utility and exit the setup program. When the *Save and Exit* dialog box appears, press **Y** to discard changes and exit, or press **N** to return to the setup main menu.

Chapter 4

Software Setup

Support software for this motherboard may be supplied either on a CD-ROM or on diskettes. In either case, all the support programs are stored in separate folders, which makes it easier to find a particular program.

After you have finished setting up the hardware, you will need to install the software that accompanies your motherboard to enjoy all its advanced features. Remember, though, that your particular motherboard may not contain all the same advanced features as other models. To determine what special functions are available with your motherboard, please refer to section 1.2 of this manual). The support software bundled with your motherboard should contain:

- SiS 620 VGA & IDE drivers for Win 98/Win95/NT.
- ESS solo-1 Audio driver and AP
- PC-Cillin 98 Software.
- Motherboard Manual

Note: Please refer to the PC-Cillin 98 installation guide for instructions on installing that particular program.

4.1 Installing SiS 620 VGA driver

Note: After you have finished setting up your hardware, reboot your computer and install the standard VGA driver (if you are using a plug-and-play operating system, it will likely install the driver automatically). After the standard VGA driver has been installed, reboot the computer again, and perform the following steps to install the SiS 620 VGA driver.

1. Turn on your PC, load Windows 95/98 and then insert the “CD title” into your CD-ROM drive.

- The disc should begin to run automatically. If it does not, click the “Start” button and select “Run.” Then type: D:/setup (if your CD-ROM does not use the drive letter “D,” replace “D” with whatever letter your CD-ROM has been assigned).
- Press “SiS 620” button.



Click SiS 620 button

- Press “VGA DRIVER” and follow the on-screen instructions.



VGA DRIVER button

- Click “Next” when the Setup Type screen appears.

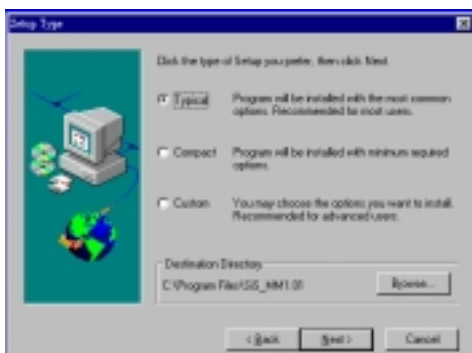

6. Follow the instructions to complete the software installation.

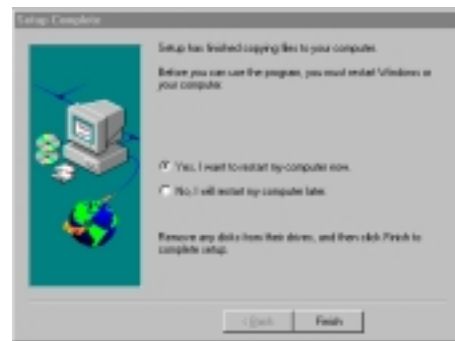
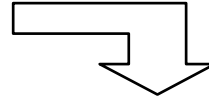
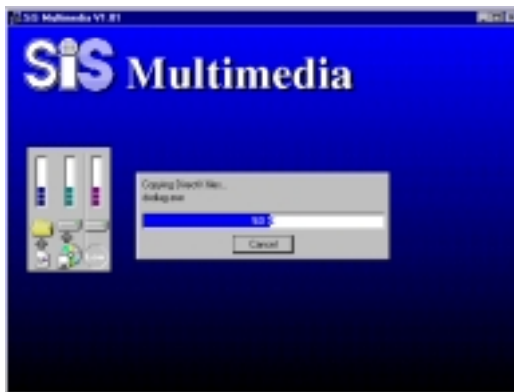

7. Then reboot your PC. You are now finished installing the driver.

4.2 Installing the IDE Driver

By installing our customized IDE Driver, your system will benefit from increased performance speeds. There is a possibility, however, that the driver can cause an already-unstable system to crash, so we recommend that you avoid installing the IDE driver until you are certain that your system is stable and functioning properly.

Installing the driver:

1. Turn on your PC, load Windows 95/98 and then insert the “**CD title**” into your CD-ROM drive.
2. The disc should begin to run automatically. If it does not, click the “**Start**” button and select “**Run**” Then type: D:/setup (if your CD-ROM does not use the drive letter “D,” replace “D” with whatever letter your CD-ROM has been assigned).
3. Press the “**SiS 620**” button.
4. Press “**IDE DRIVER**” and follow the on-screen instructions to complete installation. Then reboot your computer.

4.3 Installing the Audio Driver & AP

(Optional)

Turn on your PC and follow the below steps to install the audio driver. If your system is Win98, it will detect the new hardware and setup the audio driver automatically, so you can skip this section – (4.3-1).

4.3-1 Installing the Audio Driver

1. Turn on your computer and run “**Add New Hardware**” which is under “**Control panel**”.
2. Click “**No, I want to select the hardware from a list**” when the below screen appears.



3. Select "Sound, video and game controllers" in hardware types list and press "Next".

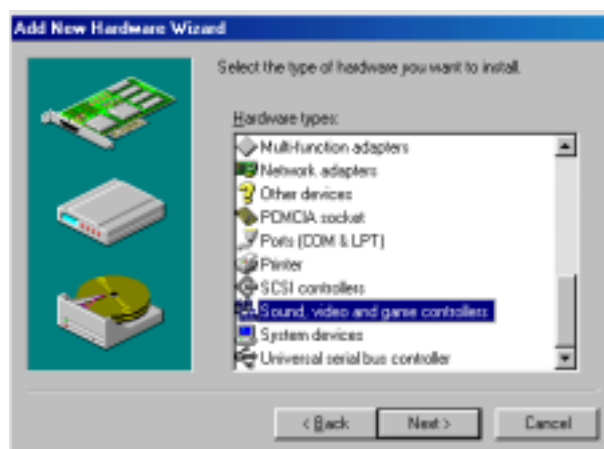

4. Press "Have Disk" to install driver from our CD-title, then type ->E:\Audio\SOLO-1\WIN98 (E is assigned your CD-ROM Device, "WIN98" is for windows 98 system, if your system is under windows 95 then please type "WIN95").

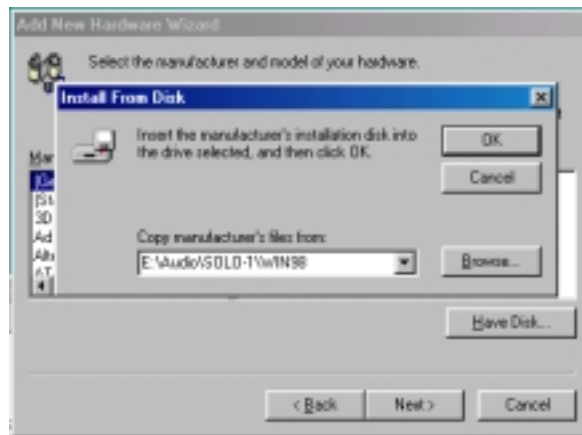

5. Select "ESS Solo-1 PCI Audio Drive" and click "Finish" to continue installing the drivers needed by ESS Solo-1 drive.

4.3-2 Installing the Audio Application (AP)

After the Audio driver had been installed completely, you may install the Audio AP to enjoy the musical by friendly musical control panel - *AudioRack32*. The installation steps as shown in the following:

1. Put the "driver CD" into your CD-ROM drive. (Please make sure it's under Win98/95 mode)
2. The CD title will be auto-run. If not, please click the "start" button and select "Run" item. Then type-> **D:\setup** (D is assigned your CD-ROM Device)

3. Click “Audio” ...



4. Click the **ESS Solo-1** ...

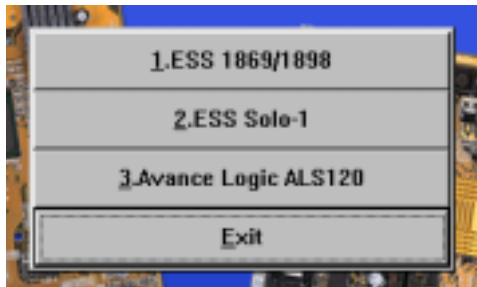

5. Click the **Utility** to setup the Audio Application and following the instruction to finish it.

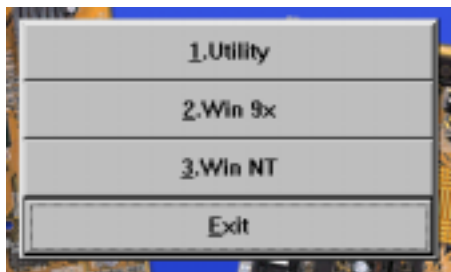

4.3-3 *AudioRack32* brief Introduction

The *AudioRack32* enables you to take advantage of your computer's audio capabilities with all of the controls conveniently in one compact space. You can play audio CDs, wave files (in WAV and .AUD formats), and MIDI files (in .MID and .RMI formats).

With the multisource Audio Mixer, you can blend these sources with line-in and microphone sources any way you choose. Add tone control and spatialization to your computer with the 3-D/Tone Controller. You can then record your creations as wave files and edit them with the Audio Recorder.

The *AudioRack32* has six main parts:

- Command Center. To customize the appearance of the *AudioRack32*.
- 3-D/Tone Controller. To enable 3-D stereo and tone controls to the *AudioRack32*.
- Audio Mixer. Control the volume and balance of the *AudioRack32* devices.
- Digital Audio Player. To play and record files in the WAV format.
- MIDI Player. To play MIDI files.
- Compact Disk Player. To play audio CDs on a CD-ROM drive.

In addition, the *AudioRack32* has a miniature mode enabling you to control the *AudioRack32* while using minimal screen space.

The Audio Recorder is a separate application from the *AudioRack32*. It can be used to add effects and edit files recorded with the Digital Audio Player or by the Audio Recorder itself. The Audio Recorder can be launched from the *AudioRack32* Digital Audio Player or on its own.

The System Diagram









The Mixer Control



Close the *AudioRack32* window.



Displays or hides the 3-D/Tone Controller.

-  Enables the Miniature mode, minimizing the *AudioRack3* 2 display.
-  Displays or hides the Digital Audio Player.
-  Accesses On-line Help.
-  Displays or hides the Compact Disk Player.
-  Displays or hides the Audio Mixer.
-  Displays or hides the MIDI Player.

This page was intentionally left blank

This page was intentionally left blank