

Safety and Regulatory Information

USA Notice

FCC Part 15: This equipment has been tested and found to comply with the limits for a class B digital device, pursuant to Part 15 of the FCC Rules. These limits are designed to provide reasonable protection against harmful interference in a residential installation. This equipment generates, uses, and can radiate radio frequency energy and, if not installed and used in accordance with the instructions, may cause harmful interference to radio communications. However, this notice is not a guarantee that interference will not occur in a particular installation.

CAUTION: To comply with the limits for the class B device, pursuant to Part 15 of the FCC Rules, this device must be installed in computer equipment certified to comply with the Class B limits. All cables used to connect the computer and peripherals must be shielded and grounded. Operation with non-certified computers or non-shielded cables may result in interference to radio or television reception.

Any changes or modifications not expressly approved by the grantee of this device could void the user's authority to operate the device.

COPYRIGHT: This publication, including all photographs, illustrations and software, is protected under international copyright laws, with all rights reserved. Neither this manual, nor any of the material contained herein, may be reproduced without the express written consent of the manufacturer.

DISCLAIMER: The information in this document is subject to change without notice. The manufacture makes no representations or warranties with respect to the contents hereof and specifically disclaims any implied warranties of merchantability or fitness for any particular purpose.

Table of Contents

Ch1. Motherboard Features	3
1.1 About The Manual	4
1.2 Specifications	6
1.3 Power Off Control Software.....	7
1.4 Packaging Check List.....	8
Ch2. Setup Guide	8
2.1 Motherboard Layout	8
2.2 Connector & Jumper Reference Chart.....	9
2.3 Motherboard Setup Procedure	10
2.3-1 Connector & Jumper Settings	10
2.3-2 Memory Installation	21
2.3-3 Installing A CPU	24
2.3-4 Installing The Motherboard	30
2.3-5 Installing The Interface Card	31
2.3-6 Installing Accessory Cables	32
Ch3. Award BIOS Setup.....	34
3.1 The Main Menu	36
3.2 Standard Cmos Setup	38
3.3 Advanced Bios Features Setup.....	40
3.4 Advanced Chipset Features Setup	43
3.5 Integrated Peripherals	46
3.6 Power Management Setup.....	49
3.7 PnP / PCI Configuration Setup.....	52
3.8 PC Health Status.....	53
3.9 Frequency / Voltage Control.....	54
3.10 Load Fail-Safe Defaults	55
3.11 Load Optimized Defaults.....	55
3.12 Supervisor/User Password Setting	55
3.13 Save And Exit Setup Option.....	56
3.14 Exit Without Saving Option.....	56
Ch4. Software Setup	57
4.1 Installing The IDE Bus Master Driver	57
4.2 Installing The Intel 810 VGA Driver.....	59
4.3 Installing The Adi 1881 Audio Driver.....	60

Chapter 1

Motherboard Feature Introduction

The BIW2B motherboard is based on Intel's 810 GMCH0set & ICH (82810 82801) chipsets. It is an advanced motherboard that comes with onboard audio and video capabilities, an audio modem riser slot, a 4MB BIOS with built-in anti-virus protection and UltraDMA/66 technology for lightning-fast IDE transfer speeds.

The BIW2B is a "BabyAT" form factor motherboard, measuring 220 mm by 230 mm, and has a four-layer printed circuit board. This motherboard has two CPU connectors on it, a Socket 370 and a SLOT1. This allows the use of Intel Celeron PPGA and FCPGA CPUs or Celeron and Pentium II/III cartridge CPUs. The BIW2B has two DIMM sockets that take 3.3-Volt unbuffered memory modules for a maximum memory capacity of 512MB. The external system bus supports speeds of 66MHz to 100MHz, allowing the use of either inexpensive 66MHz or high-performance 100MHz memory in the system.

In addition to its 32-bit onboard sound functionality, the BIW2B comes with an integrated VGA adapter with 2D and 3D graphics engines and. An audio modem riser slot is included as well as hardware monitoring and wake-on LAN capabilities. Built-in anti-virus protection ensures you will maintain an operating environment free of harmful viruses. The BIW2B also uses UltraDMA/66 technology, which allows for Bus Master IDE data transfer rates of up to 66MB/sec.

The BIW2B is a powerful platform that leverages the benefits of a low-cost system with high-performance functionality, and we are confident you will see for yourself how convenient this motherboard is when you assemble your system.

FEATURES**Full-function Processing**

Intel's new-generation chipset—the Intel 810 GMCH0set—supports all Socket 370 and SLOT1-compatible processors. The motherboard comes with many built-in features, such as an audio modem riser slot, onboard 3D graphics, UltraDMA/66 support and built-in anti-virus protection. Processor speed configurations are set automatically via the motherboard firmware, making changing switch or jumper settings on the unnecessary.

High Performance

The board has two DIMM sockets for the installation of 168-pin, 3.3-Volt unbuffered DIMM memory modules. The DIMM memory modules must use SDRAM memory chips. The board supports a memory bus of 100 or 66MHz, and each DIMM socket can accept modules of up to 256MB for up to 512MB of total system memory.

2D/3D VGA Graphic Display & Quality 32-bit Audio Built-In

Full multimedia functionality is integrated onto this motherboard, so you won't need to spend extra money on additional adapters, processors and cards. Both 2D and 3D graphics can be displayed up to 1024 x 768 x 16-bit color 3D graphics and 1600 x 1200 x 8-bit color 2D graphics. An AC'97 DAC/ADC, which is built into the audio CODEC, reduces noise and results in improved audio quality and performance for a signal to noise ratio of +90dB. These features greatly improve voice synthesis and recognition.

Double or Quadruple IDE Transfer Speeds

The BIW2B supports both UltraDMA/33 Bus Master IDE technology at data transfer rates of up to 33MB/sec and UltraDMA/66 at rates of up to 66MB/sec. It also supports existing ATA-2 IDE specifications, so there is no need to upgrade current IDE devices or cables.

Expansion Slot Options

The motherboard has three 32-bit PCI expansion slots. There is also a mini expansion slot for the optional Audio Modem Riser card.

Integrated I/O

The onboard Winbond I/O chip supports a complete set of integrated I/O ports. The I/O port array features an AT keyboard port and PS/2 mouse port pin header for an optional PS/2 mouse port bracket. There are onboard connectors for a parallel port and two serial ports. There are also pin headers for the display port, the composite audio and game/MIDI ports. There are also pin headers for optional USB and infrared ports. This motherboard comes with port brackets for all the standard ports. Port brackets are not provided for the optional ports. The motherboard also has two PCI-IDE connectors and a floppy disk drive interface.

ACPI Ready -

The BIW2B supports ACPI (Advanced Configuration and Power Interface) energy saving functions for Operating Systems that implement ACPI and OS Direct Power Management (OSPM).

Programmable Firmware -

The motherboard includes a 4MB flash memory chip for the Award BIOS. The CPU parameters can be set through the BIOS. The programmable firmware controls enhanced system features and allow users to set power management, CPU speed and memory timing, as well as LAN and modem wake-up alarms.

1.1 ABOUT THE MANUAL

The manual consists of the following chapters:

- Ch1: Motherboard features introduction – Introduces **BIW2B** features and has a checklist of items that are shipped with the motherboard.
- Ch2: Setup guides – Explains how to install the motherboard and get your system up and running.
- Ch3: Award BIOS Setup – How to configure the motherboard BIOS for optimum performance.
- Ch4: Software Setup – Explains how to install the driver software and support programs that come with this motherboard.

1.2 SPECIFICATIONS

Chipset	Intel 810 GMCH0set & ICH (82810 + 82801) solution
Processor	Supports Both Slot1 and Socket 370 PPGA Supports Intel Celeron processor 300~ 533Mhz Slot1 Supports Pentium II 233~450Mhz and Pentium III 450~550Mhz FCPGA370 Supports Pentium III 500~600Mhz
Bus Architecture	PCI
Clock Generator	66,68,70,75, 100 & up to 150 MHz
DRAM Modules	2 x 168 pin DIMM Sockets Support Maximum Memory Size to 512 MB SDRAM PC100 SDRAM.
BIOS	4Mbit Firmware Hub (82802AB). Award PnP BIOS Supports 120MB ATAPI floppy disk. Supports ZIP disk drive. Supports multi-boot from IDE, SCSI, CD-ROM and FDD. Supports software clock frequency control.
On Board VGA Port	Graphics and Memory Controller Hub (82810) Gamma Corrected Video DDC2B Compliant Integrated 2D & 3D Graphics Engines 2D Graphics Up to 1600 x 1200 in 8bit Color at 85Hz Integrated 24 bit 230MHz DAC
On Board Audio	AC97 Compliant Codec. 1 CD audio-in (2 pin header types). 1 Video audio-in 1 Mic-in.(Cable out) 1 Line-in.(Cable out) 1 Speaker out.(Cable out)

BIW2B

On Board I/O	1 VGA display port [pin header & port bracket] 2 Serial ports [pin header & port bracket] 1 Parallel port [pin header & port bracket] 1 AT keyboard connector 1 Audio & game ports [pin header & port bracket] 2 USB [pin header - port bracket optional] 1 PS/2 mouse port [pin header - port bracket optional] 1 IrDA infrared port module connector [pin header - module optional] 1 Floppy controller connector (up to 2.88MB, 3 mode floppy supported & LS-120) [cable supplied]
On Board IDE Connectors	Dual backwards compatible UltraDMA66 IDE ports, Also support ATAPI IDE CD-ROM, Zip & LS-120
Expansion slots	3 32-bit PCI slots (PCI Rev 2.2) 1 AMR Riser slot
ICH	I/O Controller Hub (82801AA I/O) Supports PCI Rev 2.2 Specification Supports 3 Master Devices on PCI Supports IDE UltraDMA66 Mode AC 97 2.1 Link Compliant Low Pin Count (LPC) I/F SMBus Interface Firmware Hub I/F
LPC I/F Chip & Hardware Monitoring	Winbond W83627HF
Advanced Features	Keyboard/Password/Mouse power on (ATX Power Only) CPU & System temperature sensor Ring Power on(ATX Power Only) Wake-on-Lan(ATX Power Only) APM Rev 1.2 Compliant. Modem riser (Optional) Supports BabyAT and ATX Power Suply
Form Factor	Baby-AT (220mm x 230mm)

1.3 Power Off Control Software

This motherboard supports a software power off control feature through an SMI code in the BIOS under Windows 98 or 95 Operating Systems. To use this feature you should use an ATX power supply and system case.

First, connect the power button cable from an ATX case to the connector [PWBT] on the motherboard (please refer to the following illustration). In the POWER MANAGEMENT SETUP of the BIOS Setup Utility, set the POWER MANAGEMENT entry to User Defined, Min power saving or Max power saving and set PM Control by APM to Yes.

Note: For BIOS Setup Utility, please see “Chapter 3 Award BIOS Setup”

In Windows 98 or 95, under the Shut Down option, the computer's power will switch off automatically and put the PC in a suspend mode. A blinking power light will indicate this. To restart the system, simply press the Power Button.

1.4 Packaging Check List

The motherboard comes securely packed in a box. If any of the items are missing or damaged, please contact your supplier. The motherboard package contains:

Quantity		Description
1	Motherboard	: BIW2B
1	Support CD	: Included software: <ul style="list-style-type: none">• EIDE Bus Master Driver• Audio Driver• Display Driver• PC-Cillin Software
1	Cable	: IDE Device Connector Cable
1	Cable	: Floppy Drive Connector Cable
1	Port Bracket Set	: VGA and Parallel port bracket : Com1/COM2 port bracket : Audio port bracket
1	User's Guide	: For PC-Cillin software
1	User's Manual	: This manual

Chapter 2

Setup Guide

2.1 Motherboard Layout

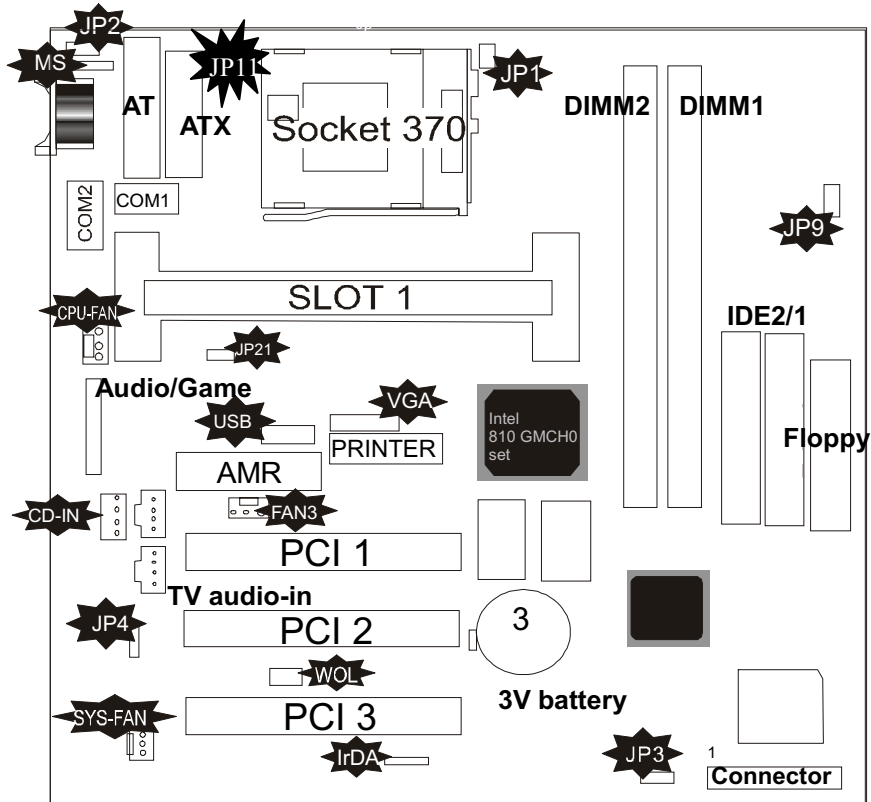

2.2 Connector & Jumper Reference Chart

Component	Description
AMR Riser	Audio Modem Riser slot
PCI 1,2,3	3 x 32-bit PCI expansion slots
WOL	Connector for LAN Wake up
Socket 370	Socket 370 CPU
Slot1	Pentium II and Pentium III
DIMM1, DIMM2	Slots for 168-pin memory modules
FDD	Connector for floppy disk drives
IDE1, IDE2	Primary and secondary IDE channels
ATX Power	Connector for ATX power supply
AT Power	Connector for AT power supply
IrDA	Connector for optional infrared port
MS	Connector for optional PS/2 Mouse cable.
CPU FAN, FAN2, FAN3	Power connector for CPU or System cooling fan
COM 1/2	Serial port cable connectors
Audio/Game	Audio & game port cable connectors
Print Port	Connector for print port cable
VGA port	Connector for VGA Cable
USB	Connector for optional USB port
JP1	CPU Type Select
JP11	CPU Type Select(For CPU CMOS Voltage)
JP2	K/B Power-on Jump Select
JP3	Clear CMOS memory jumper
JP4	On Board AC97 Sound Switch
JP9	CPU Frequency Select Jump
JP21	Thermal resistor select

2.3 Motherboard Setup Procedure

Please refer to the following steps to setup your computer:

1. Refer to the Jumper Setup section to configure the jumpers correctly.
2. Install DIMM modules on the motherboard. Use precautions against damage from static electric discharge.
3. Install the CPU on the motherboard (please refer to the CPU installation manual).
4. Choose a system chassis (case) and install the motherboard in it.
5. Install any interface cards required.
6. Install whatever disk drives you will use with the system.
7. Connect cables, power supply, port brackets and any other required internal and external connections.
8. Turn on the computer and run the Award BIOS CMOS Setup Utility to set up the system as explained in Chapter 3.
9. Reboot and set up your computer system software.

2.3-1 Connector & Jumper Settings

PS/2 Mouse Connector

Color: Green

This connector is for the optional PS/2 Mouse port bracket.

Pin	Description	Pin	Description
1	Mouse Data	2,6	N.C.
3	Ground	4	+5V
5	Mouse Clock		

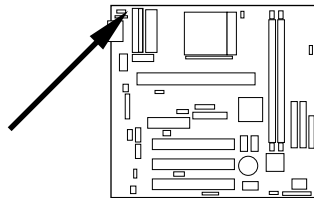

AT Power Supply Connector

This connector allows the motherboard to draw power from an AT-type power supply. Use a power supply of at least 250 watts. At power supplies have two connectors. When you plug them onto the motherboard make sure the black wires are in the middle.

Pin	Description	Pin	Description
1	Power Good	7	Ground
2	+5V DC	8	Ground
3	+12V DC	9	-5V DC
4	-12V DC	10	+5V Dc
5	Ground	11	+5V DC
6	Ground	12	+5V DC

ATX Power Supply Connector

This connector allows the motherboard to draw power from an ATX-type power supply. Use a power supply of at least 250 watts.

Pin	Description	Pin	Description
1,2,11	+ 3.3 V	3,5,7,13, 15,16,17	Ground
4,6,19,20	+ 5 V	8	POWER GOOD
9	5VSB	10	+12 V
12	-12 V	14	PS-ON
18	- 5 V		

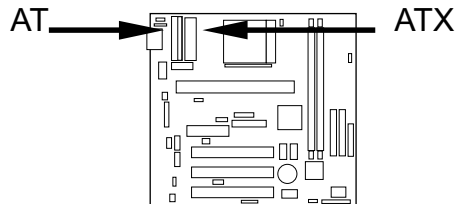

Parallel Port

Color: Burgundy

This connector is for the parallel port on the port bracket. It is commonly used for connecting a printer to the system. The port can operate in one of several modes which you select in the BIOS CMOS Setup Utility.

Pin	Signal Name	Pin	Signal Name
1	Strobe-	14	AFD
2	Data Bit 0	15	Error
3	Data Bit 1	16	INIT
4	Data Bit 2	17	SLCTIN
5	Data Bit 3	18	GND
6	Data Bit 4	19	GND
7	Data Bit 5	20	GND
8	Data Bit 6	21	GND
9	Data Bit 7	22	GND
10	ACK	23	GND
11	Busy	24	GND
12	PE	25	GND
13	SLCT	26	GND

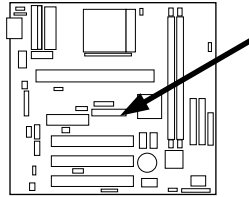

COM1/COM2 – Serial Connectors

Color: Turquoise

These connectors are for the serial port bracket. Both connectors have the same pin-outs.

Pin	Signal Name	Pin	Signal Name
1	DCD	6	DSR
2	SIN	7	RTS
3	SOUT	8	CTS
4	DTR	9	RI
5	GND	10	NC

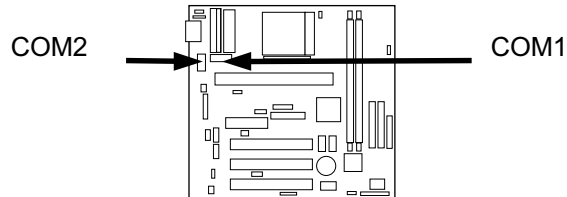
**VGA – VGA Out Connector**

Color: Blue

This connector is for the VGA display port. Connect a VGA or higher resolution display monitor to it.

Pin	Signal Name	Pin	Signal Name
1	RED Signal	9	N.C.
2	GREEN Signal	10	GND
3	BLUE Signal	11	N.C.
4	N.C.	12	Display data channel data
5	GND	13	Horizontal Sync
6	GND	14	Vertical Sync
7	GND	15	Display data channel clock
8	GND		

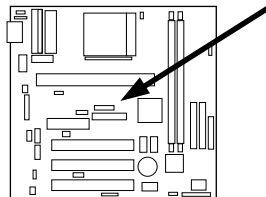

USB - Universal Serial Bus Connector Color: Black

This connector is for an optional dual USB port bracket.

USB1 Pin	Signal Name	USB2 Pin	Signal Name
1	USB VCC 0	1	USB VCC 1
2	USB Data -	2	USB Data -
3	USB Data +	3	USB Data +
4	USB GND 0	4	USB GND 1
5	GND	5	GND

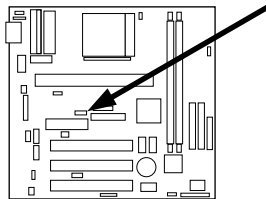
**Audio & Game Port Pin Header**

This header is for the audio port bracket. It connects audio ports - stereo line-out, stereo line-in and microphone – and a game port (for a joystick or MIDI device) to your system.

Pin	Signal Name	Pin	Signal Name	Pin	Signal Name	Pin	Signal Name
1	VCC	8	GND	15	N.C.	22	MIC-in
2	VCC	9	XTD	16	VCC	23	N.C.
3	SWC	10	GND	17	Line-out	24	GND
4	SWA	11	SWB	18	Line-out	25	Line-in
5	XTC	12	XTB	19	GND	26	Line-in
6	XTA	13	MSIN	20	GND		
7	MSOUT	14	SWD	21	MIC-in		

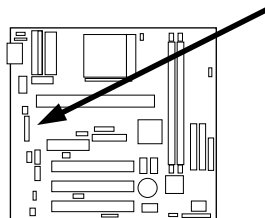

IrDA - IR (Infrared) Connector

This connector is for connecting an infrared port module.

Pin	Signal Name
1	VCC
2	NC
3	SIRRX
4	GND
5	IRTX

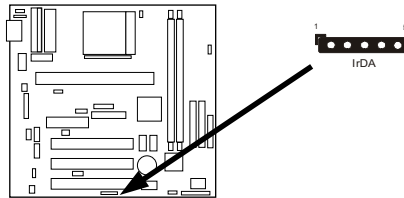
**WOL – Wake-up On LAN Connector**

This connector is used to connect a Network Interface Card (NIC) which supports the WOL function to the motherboard. Enable this function for remotely managing the computer on a network. When the computer is in Suspend mode and the wake-up command arrives, the NIC will wake up the computer.

Pin	Signal Name
1	5VSB
2	GND
3	LID

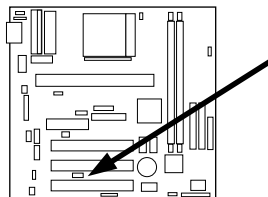

CD-IN: CD Audio Connectors

These connectors are used to connect CD-ROM drive audio output to motherboard with the drive's audio cable. This outputs CD audio directly to the onboard audio chip. There are two connector headers on the motherboard for two types of audio cable connectors. The pin assignments are the same.

Pin	Description
1	Left
2	Ground
3	Ground
4	Right

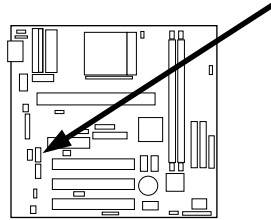
**JP1 & JP11: CPU Type Selector**

This jumper selects which CPU connector is active, either the Socket 370 or the Slot1 connector. **Note:** Jumper JP21 MUST be set to the same setting.

JP1	Setting	JP11	Setting
Open	Slot1	Open	PGA-370[Default]
Short	PGA-370[Default]	Short	Slot1

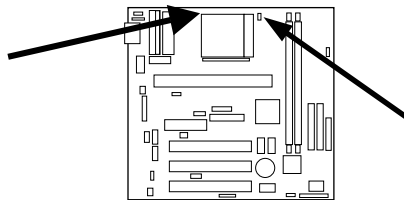

JP2 – Keyboard On Now Connector

This connector is used to enable keyboard power on with hot keys or mouse button.

Pin	Setting
1-2	Enable [Default]
2-3	Disable

JP3 – CMOS Clear

This jumper clears the current system configuration data from the BIOS CMOS Setup utility that is stored in CMOS memory. You might need to erase this data if incorrect settings are preventing your system from operating. To clear the CMOS memory, turn off the system, disconnect the power cable from the motherboard, and short the pins 2-3 for a few seconds.

Pin	Setting
1-2	Normal [Default]
2-3	Clear CMOS

JP4 – On Board AC97 Sound Switch

This jumper is enables or disables the onboard audio function.

Pin	Setting
1-2	Disable
2-3	Enable [Default]

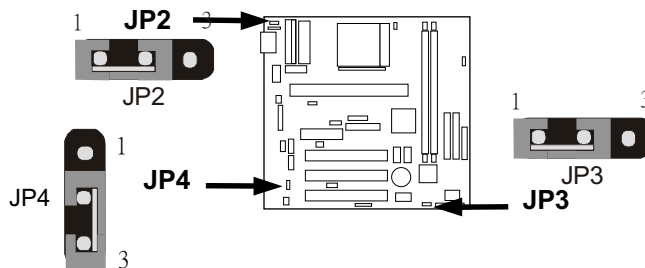

JP9 – CPU External Bus Speed Selector

Jumper JP9 sets your motherboard's external bus speed. There are two speed settings, 66MHz and 100MHz. The Socket 370 processor supports external bus frequencies of both 66MHz and 100MHz, but not all Intel Pentium® CPUs can support both frequencies. Please refer to your CPU specifications before setting the bus speed on the motherboard. If in doubt use the default auto-detect setting.

Pin	Setting
Short 1-2	66 MHz
Short 2-3	Auto Detect (Default)
Open Jumper	100MHz

JP21 – CPU Thermal Resister Selector

This jumper selects which CPU socket the thermal resister monitors. It must be set for the CPU socket in use and must be set the same as JP1.

Pin	Setting
1-2	Socket370 (Default)
2-3	Slot1

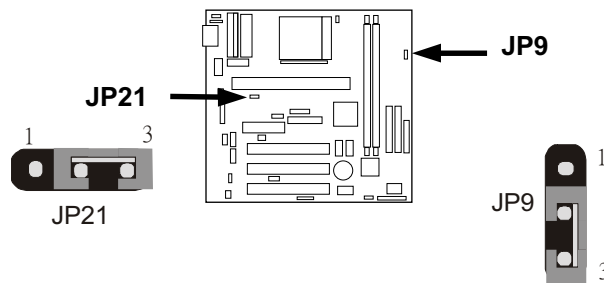

Panel Connector Definition

Many system cases have a power switch, power LED, Reset button, Suspend switch, Suspend LED, speaker, keylock and Hard Disk Drive LED. These features are all supported on the panel connector pin header. Connect leads from the case to it. Refer to the diagram below to make the connections.

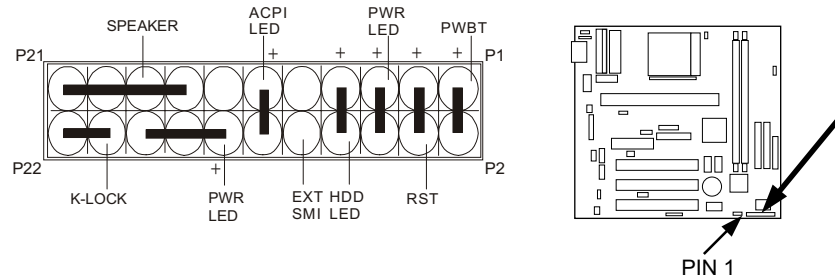

Pin	Name	Description
1 – 2	PWBT	Power Button
3 – 4	RST	Reset
5 – 6	PWR LED	Power LED
7 – 8	HDD LED	HDD LED
9 – 10	EXT SMI	Suspend Button
11 – 12	ACPI LED	Suspend LED
14 – 18	PWR LED	Power LED
20 – 22	K-LOCK	KEY LOCK
15 – 21	SPEAKER	Speaker

CPUFAN, FAN2, FAN3 - FAN CONNECTORS

These connectors allow the CPU and system fans draw power from the motherboard.

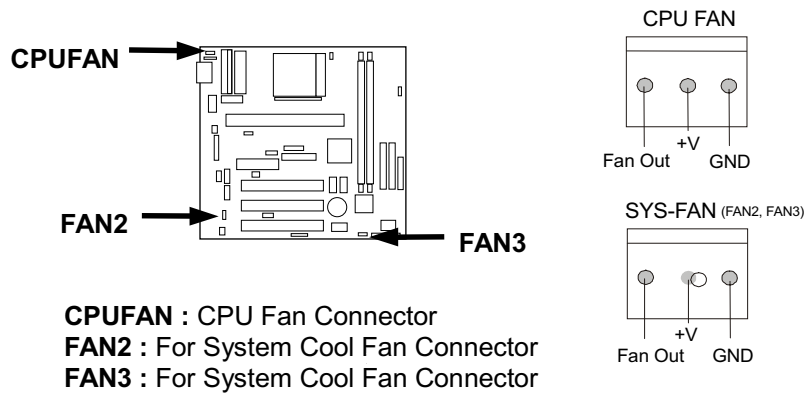
**CPU VOLTAGE SELECT**

The Socket 370 processor supports external bus frequencies of both 66MHz and 100MHz, but not all Intel Pentium® CPUs can support both frequencies. Please refer to your CPU specifications before setting the bus speed on your motherboard.

BIW2B will auto-detect the CPU voltage without any jumper setting. So you just need to install your CPU on Socket 370 and your system determine the CPU voltage.

You can change the clock frequency in the BIOS CMOS Setup, so you can refer to the section on Chipset Features Setup in Chapter 3. Even if your Intel Pentium® CPU doesn't support an external bus speed of 100MHz, you can still set your motherboard's external bus speed to 100MHz, so caution is advised.

2.3-2 Memory installation

No jumper setting is necessary for DRAM setting; BIOS will check DRAM type and size automatically. This motherboard contains 2 by 168-pin DIMM socket (DIMM1, DIMM2). The motherboard has a table-free (or auto-bank) feature; the user can install DIMM into any bank. The two DIMM Sockets permit system memory expansion from 8MB to 512MB. Each bank provides a 64-bit wide data path. You can install 100MHz SPD RAM or 66MHz SDRAM into the motherboard, using your CPU clock to make the selection.

If you want to install more memory and there are no sockets available, you must remove some installed modules and replace them with the upgrade modules.

If you have to do this, be sure to identify what type of memory is already installed. In some cases, there may be a mix of module types. You can confirm this by checking the configuration screen that appears while the computer is starting up. Press the pause key to temporarily interrupt the start-up so that you have more time to read the screen. When you're done, press any key to resume.

Remove the lowest performance and smallest size modules and replace them with the upgrades.

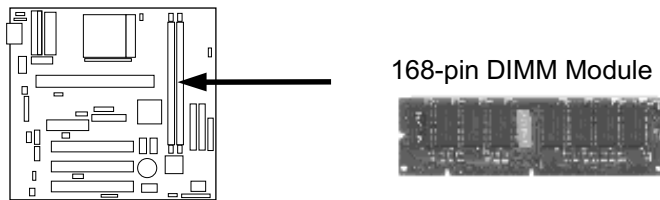

How to Install DIMM Modules on Motherboard

1. The SDRAM sockets are keyed with notches and the DIMMs are keyed with cut-outs so that they cannot be installed incorrectly. Check that the cut-outs on the DIMM edge connector match the notches in the SDRAM socket. In other words, before inserting the DIMM, make sure the pin1 of the DIMM matches with the pin1 on the DIMM socket.
2. Push down the latches on each side of the SDRAM socket.
3. Install the DIMM into the socket and press it carefully but firmly down so that it seats correctly. The latches at either side of the socket will be levered upwards and latch on the edges of the DIMM when it is installed correctly.

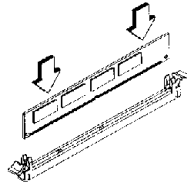

Install DIMM

How to Remove DIMM Modules from Motherboard

1. Press the holding latches at either side of the socket outward to release the DIMM.
2. Gently pull the DIMM out of the socket.

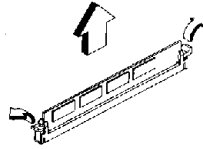

Remove DIMM

NOTE: Samples of System Memory Combinations Options

DIMM1	DIMM2	TOTAL
8MB	-----	8MBytes
-----	8MB	8MBytes
8MB	8MB	16MBytes
-----	16MB	16MBytes
16MB	-----	16MBytes
16MB	8MB	24MBytes
8MB	16MB	24MBytes
16MB	16MB	32MBytes
32MB	-----	32MBytes
-----	32MB	32MBytes
8MB	32MB	40MBytes
32MB	32MB	64MBytes
-----	64MB	64MBytes
64MB	-----	64MBytes
64MB	64MB	128MBytes
:	:	:
:	:	:
128MB	128MB	256MBytes
256MB	256MB	512MBytes

DIMM type : 3.3V, unbuffered or registered, 64/72-bit Synchronous DRAM with SPD. Supports Single/Double-side 16/32/64/128 Mbytes module size with parity or non-parity.

2.3-3 Installing a CPU

Prepare the motherboard by setting the motherboard for a Socket 370 CPU, then install the CPU according to the instructions supplied. Complete the processor installation by installing the supplied heat sink, and connecting the heat sink power cable to the motherboard connector.

Socket 370 CPU Installation Procedure

This section is only for CPU installation, the motherboard in the picture is not the **BIW2B**. Regarding the heatsink, please refer to the instructions that come with it.

1. Review the CPU and motherboard.



2. Pull the lever slightly sideways away from the socket then raise the lever up to a 90-degree angle.

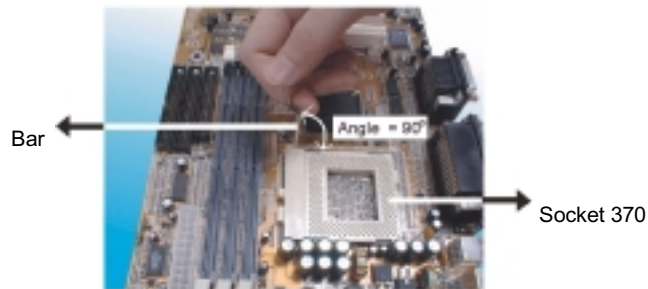

3. Locate Pin 1 in the socket and look for the cut edge in the CPU, match Pin 1 with the cut edge then insert the CPU. It should insert easily.

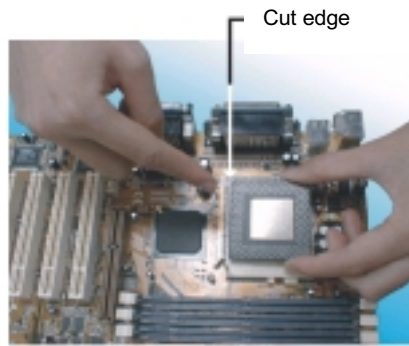

4. Press the lever down to lock the CPU into the socket.



Note:
Regarding the heatsink installation, please refer to the vendor's instructions.



CPU & Power Supply Fan Connectors (3-pin FanPWR)

These connectors support cooling fans of 500mAMP (6WATT) or less. Orient the fans so that the heat sink fins allow airflow across the heat sink(s). The wiring and connector may vary depending on the fan manufacturer. The fan connector only plugs onto the motherboard in one orientation, so you can not connect it incorrectly.

The "rotation" signal is to be used only by a specially designed fan with a rotation signal.



The CPU and motherboard will overheat if the hot air generated by the CPU does not flow across the onboard heat sinks, and the CPU fan and motherboard can be damaged if these pins are used improperly.

Installing a Slot 1 CPU

Installing a CPU involves three steps: the insertion of the CPU into the proper slot, the installation of the heat sink and the connection of the heat-sink fan power cable to the appropriate motherboard connector.

Installing Procedure

Please note that the motherboard pictured below is not a BIW2B. Also, the instructions below refer only to the installation of the CPU; to install the heat sink, please refer to the instructions supplied with your heat sink.

1. Inspect the area around Slot1, verify the position of four around-sockets, and then locate the small protruding rectangular tab on the side of Slot1 (see diagram).

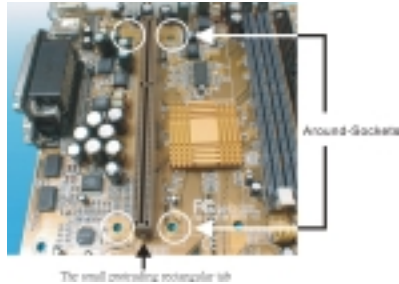

2. Examine the CPU Retention Module and attachments. There are three sets of attachments: 1. The module, 2. Two CPU locking caps. 3. Four plastic screws.

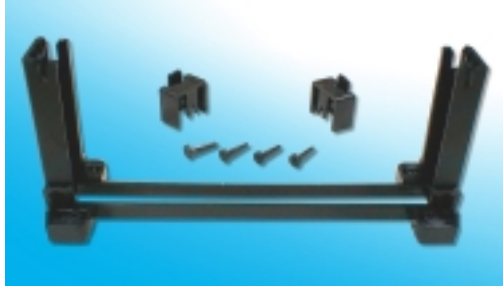

3. Once the above two steps have been completed, slot the CPU Retention into Slot1. Pull up the CPU stays on both side of the CPU Retention so they are horizontal, at an angle of 90°. Then the side of the CPU Retention with no mark on it and the side of Slot1 with the small rectangular tab should be on the same side.

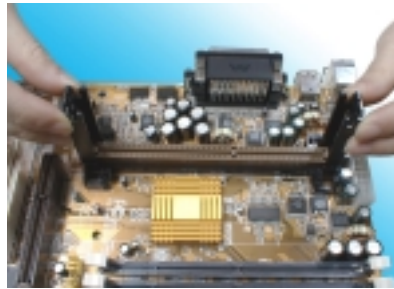
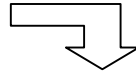

The CPU Retention has to go in a particular direction. Make sure that it is the right way round before slotting it in. Do not force it in, otherwise you may damage the motherboard and CPU Retention.

4. Ensure that the CPU Retention has been slotted all the way in, and then screw the four plastic screws into the sockets on each side of Slot1 to make sure that the CPU Retention is fixed firmly in position.

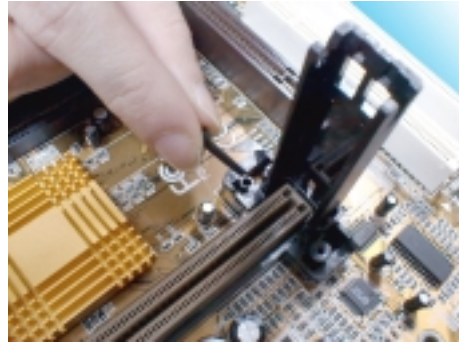

5. Slide the CPU slowly into Slot1 along the two sides of the CPU Retention.



Note: Some Slot 1 processors with different packing maybe need the caps to let them are fixed. So if it need the caps during installing Slot 1 CPU, please follow this step: “ Fix the CPU locking caps onto the two ends of the CPU stays ”.

6. Connect the CPU Fan head to the CPU Fan connector on the motherboard, and make sure that the CPU has been fixed firmly onto the motherboard. You have now completed assembly.

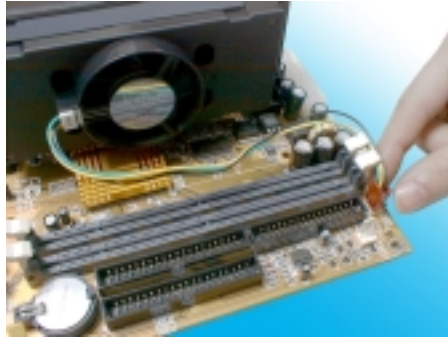

SLOT 1 CPU Disassembly/Replacement Procedures

1. Move the protruding part on top of the CPU locking caps gently outwards, so that the locking caps come off.
2. Pull the CPU Fan connector off the motherboard, and then gently pull the CPU out from Slot1.
3. If you need to install another CPU, follow the instructions for Slot1 CPU installation given above.

CPU & Power Supply Fan Connectors (3-pin FanPWR)

These connectors support cooling fans of 500mAMP (6WATT) or less. Orient the fans so that the heat sink fins allow airflow across the heat sink(s). The wiring and connector may vary depending on the fan manufacturer. The fan connector only plugs onto the motherboard in one orientation, so you can not connect it incorrectly.

The “Rotation” signal is to be used only by a specially designed fan with rotation signal.



The CPU and motherboard will overheat if there is no airflow across the CPU and onboard heatsinks. Damage may occur to the motherboard and the CPU fan if these pins are incorrectly used.

2.3-4 Installing the Motherboard

The **BIW2B** motherboard complies with the specifications for a BabyAT board, so you can also install this kind of board into any BabyAT case. Some features on the motherboard are implemented by cabling connectors on the motherboard to indicators and switches on the system case. Ensure that your case supports all the features required. The **BIW2B** motherboard can support one or two floppy diskette drives and four enhanced IDE drives. Ensure that your case has sufficient power and space for all the drives that you intend to install.



Caution: Make sure that you have already installed the system board components like the CPU and memory, and have set the appropriate jumpers before you proceed.

2.3-5 Installing Interface Cards

This section explains how to install interface cards. There are three PCI expansion card slots on the motherboard. When you get an expansion card, it will come with instructions on how to install it, so this section covers relevant information for the motherboard only.

PCI Cards and Slots

With very few exceptions, any PCI expansion card you are likely to get will be Plug and Play compliant. If you are using an Operating System that supports PnP, such as Windows 98 or 95, you should be able to follow the installation instructions that come with the card and have the Operating System automatically recognize and configure the card.

The PCI slots on the motherboard all have “Bus Master” capability. For installed PCI cards to use this feature, an Operating System specific Bus Master software driver that comes with this motherboard must be installed in your Operating System. These drivers are located on the Support Disk.

2.3-6 Installing Accessory Cables

This section describes how to connect the accessory cable that motherboard or system housing supports. In the case of ATX, there is no need to use a bracket to extend the connectors to the rear panel, so here we will discuss only the installation instructions for Floppy, IDE, Power supply and Front Panel switch/LED cables.



Caution: Make sure that the power supply is OFF before connecting or disconnecting any bracket or cable.

ATX Power Cable

The 20-pin ATX power cable supports 5V standby current and soft power-on switch. The soft power switch can be either momentary or toggle type and must comply with the ATX specification.

Plug in the power cable to the onboard power connector.

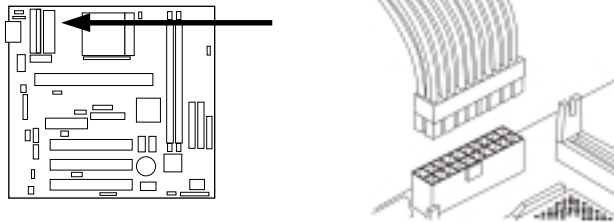

Front Panel Switch and LED Cables

Many system cases have a power switch, power LED, Reset button, Suspend switch, speaker, keylock and HDD LED. These features are all supported on the panel connector pin header. Connect leads from the case to it.

Refer to the 2.3-1 Panel Connector Definition for the for the panel connector's pin assignments.

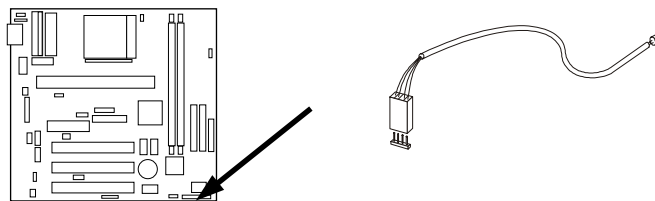

Floppy Cable

The floppy cable for floppy drives is a 34-pin flat cable with 5 connectors classified as follows:

1. Female header (For floppy connector onboard)
2. Female header and Edge connector (For driver B)
3. Female header and Edge connector (For driver A)

The end-most connector cable is twisted to support floppy drive A, while the middle connectors are for floppy drive B. The drive B connectors are designed to accommodate both 1.44MB and 1.2MB drives. When connecting the drive, make sure that Pin 1 on the cable (ie. the red-colored wire) matches Pin1 on the drive's connector.

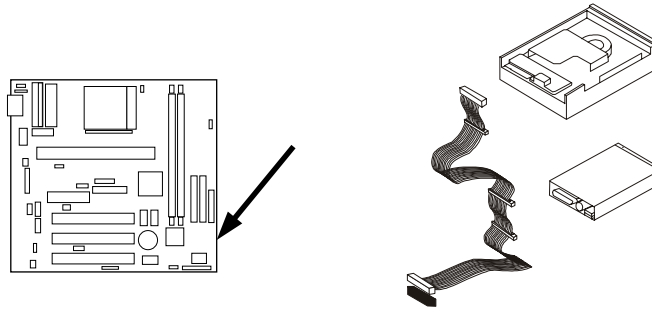
**IDE Cables for HDD and CDROM**

The motherboard has two IDE channels, Primary IDE and Secondary IDE for connecting IDE devices. Each channel supports two IDE devices via a 34-pin flat cable, which allows connection of a maximum of four IDE devices.

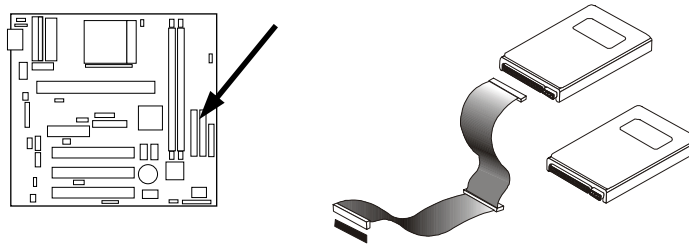

Chapter 3

Award BIOS Setup

This chapter explains how to use and modify the BIOS setup utility that is stored on the motherboard. The setup utility stores information about the motherboard components, and the configuration of other devices that are connected to it. The system uses this information to test and initialize components when it is started up, and to make sure everything runs properly when the system is operating.

The setup utility is installed with a set of default values. The default values are designed to ensure that the system will operate adequately. You will probably have to make changes to the setup utility whenever you add new components to your system such as new disk drives. You may be able to generate increased performance by changing some of the timing values in the setup, but this can be limited by the kind of hardware you are using, for example the rating of your memory chips. In certain circumstances, the system may generate an error message which asks you to make changes to the setup utility. This happens when the system finds an error during the POST (power on self-test) that it carries out at start up.

Starting the Setup Utility

You can only start the setup utility shortly after the computer has been turned on. A prompt appears on the computer display which says "**Press DEL to run Setup**". When you see this prompt press the **Delete** key, and the system will start the setup utility and display its main menu of the utility.

Using the Setup Utility

When you press the **Delete** key to start setup, the main menu of the utility appears.

The main menu of the setup utility shows a list of the options that are available in the utility. A highlight shows which option is currently selected. You can use the cursor arrow keys to move the highlight to other options.

When an option is highlighted, you can execute the option by pressing the **Enter** key. Some options lead to dialog boxes which ask you verify that that you wish to execute that option. You usually answer these dialogs by typing **Y** for yes and **N** for no.

Some options lead to dialog boxes which ask for more information. Setting the User Password or Supervisor Password has this kind of dialog box.

PRESS F1 TO CONTINUE, CTRL-ALT-ESC OR DEL TO ENTER SETUP

Control Keys

Up Arrow	Move to previous item
Down Arrow	Move to next item
Left Arrow	Move to the item in the left hand
Right Arrow	Move to the item in the right hand
Esc Key	Main Menu: Quit without saving changes Submenus: Exit Current page to the next higher level menu
PgUp Key	Increase the numeric value or make changes
+ key	Increase the numeric value or make changes
- key	Decrease the numeric value or make changes
PgDn Key	Decrease the numeric value or make changes
F1 Key	General help, only for Status Page Setup Menu and Option Setup Menu
F5 Key	Load previous values from CMOS
F6 Key	Load the default CMOS value from BIOS default table, only for Option Page Setup Menu
F7 Key	Load the default
F8 Key	Reserved
F9 Key	Reserved
F10 Key	Save all the CMOS changes, only for Main Menu

Advanced Chipset Features

This setup page includes all the items of chipset special features.

Integrated Peripherals

This section page includes all the items of IDE hard drive and Programmed Input / Output features.

Power Management Setup

This menu provides functions for Green products by allowing users to set the timeout value for monitor and HDD.

PnP / PCI Configurations

This menu allows the user to modify PNP / PCI configuration function.

PC Health Status

This menu allows users to monitor PC Health status

Frequency/Voltage Control

This menu to specify your settings for frequency/voltage control

Load Fail-Save Defaults

Use this menu to load the BIOS default values for the minimal/stable performance for your system to operate.

Load Optimized Defaults

Use this menu to load the BIOS default values that are factory settings for optimal performance system operations. While Award has designed the custom BIOS to maximize performance, the factory has the right to change these defaults to meet their needs.

Supervisor / User Password Setting

Change, set, or disable password. It allows you to limit access to the system and Setup, or just to setup.

Save & Exit Setup

Save CMOS value changes to CMOS and exit setup.

Exit Without Saving

Abandon all CMOS value changes and exit setup.

3.2 Standard CMOS Setup

The items in Standard CMOS Setup Menu are divided into several categories. Each category includes no, one or more than one setup items. Use the arrow keys to highlight the item and then use the <PgUp> or <PgDn> keys to select the value you want in each item.

Standard CMOS Features		Item Help
Date(mm:dd:yy)	Mon, Jul 8 1999	
Time(hh:mm:ss)	16:19:20	
➤ IDE Primary Master	Press Enter 2557 MB	Menu Level ➤
➤ IDE Primary Slave	Press Enter None	
➤ IDE Secondary Master	Press Enter None	Change the day, month, year and century
➤ IDE Secondary Slave	Press Enter None	
Drive A	1.44M, 3.5 in.	
Drive B	None	
Floppy 3 Mode Support	Disabled	
Video	EGA/VGA	
Halt On	All Errors	
Based Memory	640K	
Extended Memory	64512K	
Total Memory	65536K	
↑↓←→Move Enter: Select +/-/PU/PD: Value F10:Save ESC: Exit F1:General Help F5:Previous Values F6:Fail-safe defaults F7:Optimized Defaults		

Date and Time

The Date and Time items show the current date and time held by your computer. If you are running a Windows operating system, these items will automatically be updated whenever you make changes to the Windows Date and Time Properties utility.

Hard Disks

Default: Auto

These items show the characteristics of any hard disk drives on the four available IDE channels. (Note that SCSI hard disk drives do not appear here.) You can automatically install most modem hard disks using the IDE HDD Auto Detect Option from the main menu. However, if you find that a drive

cannot be automatically detected, you can use these items to select USER, and then manually enter the characteristics of the drive. The documentation provided with your drive provides the data you need to fill in the values for CYLS (cylinders), HEAD (read/write heads), and so on.

The documentation provided with the drive may not tell you what value to use under the MODE heading. If the drive is smaller than 528 NM, set MODE to Normal. If the drive is larger than 528 NM and it supports Logical Block Addressing, set MODE to LBA- Very few high-capacity drives do not support Logical Block Addressing. If you have such a drive, you might be able to configure it by setting the MODE to Large. If you're not sure which MODE setting is required by your drive, set MODE to Auto and let the setup utility try to determine the mode automatically.

Drive A and Drive B *Default: 1.44M, 3.5 in., None*

These items define the characteristics of any diskette drive attached to the system. You can connect one or two diskette drives.

Floppy 3 Mode Support *Default: Disabled*

Floppy 3 mode refers to a 3.5" diskette with a capacity of 1.2MB. Floppy 3 mode is sometimes used in Japan.

Video *Default: EGA/VGA*

This item defines the video mode of the system. This motherboard has a built-in VGA graphics system so you must leave this **item** at the default value.

Halt On *Default: All. But Keyboard*

This item defines the operation of the system POST (Power On Self Test) routine. You can use this item to select which kind of errors in the POST is sufficient to halt the system.

Base, Extended and Other Memory *Default: Auto Detect*

These items show how much memory is available on the system. They are automatically detected by the system so you cannot manually make changes to these items.

3.3 Advanced BIOS Features

This section allows you to configure your system for basic operation. You have the opportunity to select the system's default speed, boot-up sequence, keyboard operation, shadowing and security.

CMOS Setup Utility – Copyright © 1984 – 1998 Award Software
Advanced BIOS Features

Anti-Virus Protection	Enabled	Item Help	
CPU Internal Cache	Enabled		
External Cache	Enabled	Menu Level ➤	
CPU L2 Cache ECC Checking	Enabled		
Quick Power On Self Test	Enabled	Allows you to choose the VIRUS warning feature for IDE Hard Disk boot sector protection. If this function is enabled and someone attempt to write data into this area, BIOS will show a warning message on screen and alarm beep	
First Boot device	Floppy		
Second Boot device	HDD-0		
Third Boot device	LS/ZIP		
Boot other device	Enabled		
Swap Floppy Drive	Disabled		
Boot Up Floppy Seek	Disabled		
Boot Up NumLock Status	On		
Gate A20 Option	Normal		
Typematic Rate Setting	Disabled		
Typematic Rate (Chars/Sec)	6		
Typematic Delay (Msec)	250		
Security Option	Setup		
OS Select For DRAM > 64MB	Non-OS2		
BIOS Write Protect	Disabled		
HDD S.M.A.R.T. Capability	Enabled		
Report NO FDD For Win 95	No		
↑↓←→Move Enter: Select +/-/PU/PD: Value F10:Save ESC: Exit F1:General Help F5:Previous Values F6:Fail-safe defaults F7:Optimized Defaults			

Anti-Virus Protection *Default: Enabled*

Anti-Virus program could locate and remove the problem before any damage is done. So when this item is enabled, the Award BIOS will monitor the boot sector and partition table of the hard disk drive for any attempt at modification. If an attempt is made, the Anti-Virus program built-in the BIOS will be run for protecting your system to be clean.



WARNING:

Disk boot sector is to be modified
 Type **'Y'** to accept write or **'N'** to abort writes
 Award Software, Inc.

Enabled : Activates automatically when the system boots up, if anything

attempts to access the boot sector or hard disk partition table will cause a warning message to **appear**.

Disabled : No warning message will appear when anything attempts to access the boot **sector or hard disk partition table**.

Many disk diagnostic programs, which attempt to access the boot sector table, can cause the above warning message.

CPU Internal Cache *Default: Enabled*

All the processors that can be installed in this motherboard use internal (level 1) cache memory to improve performance. Leave this item at the default value Enabled for better performance.

External Cache *Default: Enabled*

Most of the processor cartridges that can be installed in this motherboard have (level 2) external cache memory (the Celeron-266MHz is an exception). Only enable this item if your processor cartridge has external cache memory.

CPU L2 Cache ECC Checking *Default: Enabled*

This item can be used to enable ECC (Error Checking Code) for the level-2 cache memory. We recommend that you leave this item at the default value Enabled.

Quick Power On Self Test *Default: Enabled*

You can enable this item to shorten the power on testing and have your system start up a little faster.

First/Second/Third Boot Device *Default: Floppy,HDD-0,LS/ZIP*

The BIOS attempts to load the operating system from the devices in the sequence selected in these items.

Swap Floppy Drive *Default: Disabled*

If you have two floppy diskette drives in your system, this item allows you to swap around the assigned drive letters so that drive A becomes drive B, and drive B becomes drive A.

Boot Up Floppy Seek *Default: Disabled*

During POST, BIOS will determine if the Floppy disk drive installed is 40 or 80 tracks. 360 K type is 40 tracks while 720K, 1.2M and 1.44M drive type as they are all 80 tracks.

Enabled: BIOS searches for floppy disk drive to determine if it is 40 or 80 tracks. Note that BIOS can not tell from 720K, 1.2M or 1.44M drive type, as they are all 80 tracks.

Disabled: BIOS will not search for the type of floppy disk drive by track number. Note that there will not be any warning message if the drive installed is 360K.

Boot Up NumLock Status**Default: On**

This item defines if the keyboard Num Lock key is active when your system is started.

Gate A20 Option**Default: Normal**

This option provides compatibility with older software written for the 286 processor. Leave this item at the default value normal.

Typematic Rate Setting**Default: Disabled**

This determines if the typematic rate is to be used. When disabled, continually holding down a key on your keyboard will generate only one key instance. In other words, the BIOS will only report that the key is down. When the typematic rate is enabled, the BIOS will report as before, but it will then wait a moment, and, if the key is still down, it will begin the report that the key has been depressed repeatedly. For example, you would use such a feature to accelerate cursor movements with the arrow keys.

Typematic Rate (Chars/Sec)**Default: 6**

When the typematic rate is enabled, this section allows you select the rate at which the keys are repeated.

<u>6</u>	<u>6 characters per second</u>	<u>15</u>	<u>15 characters per second</u>
<u>8</u>	<u>8 characters per second</u>	<u>20</u>	<u>20 characters per second</u>
<u>10</u>	<u>10 characters per second</u>	<u>24</u>	<u>24 characters per second</u>
<u>12</u>	<u>12 characters per second</u>	<u>30</u>	<u>30 characters per second</u>

Typematic Delay (Msec)**Default: 250**

When the typematic rate is enabled, this section allows you select the delay between when the key was first depressed and when the acceleration begins.

<u>250</u>	<u>250 msec</u>
<u>500</u>	<u>500 msec</u>

<u>750</u>	<u>750 msec</u>
<u>1000</u>	<u>1000 msec</u>

Security Option *Default: Setup*

If you have installed password protection, this item defines if the password is required at system start up, or if it is only required when a user tries to enter the setup utility.

OS Select For DRAM > 64 MB *Default: Non-OS2*

This item is required if you have installed more than 64 NM of memory and you are running the OS/2 operating system. Otherwise, leave this item at the default Non-OS2.

BIOS Write Protect *Default: Disabled*

This item allow users to protect the BIOS been written

HDD S.M.A.R.T Capability *Default: Enabled*

S.M.A.R.T is an industry acronym for Self-monitoring, Analysis and Reporting Technology. If the documentation of your hard disk states that S.M.A.R.T. is supported, you can enable this item.

Report No FDD For WIN 95 *Default: No*

Set this item to Yes BIOS will report FDD to Win95. If in standard CMOS setup, set Drive A to none, and set this item to yes. Inside Win95, My Computer and File manager Disk(A:) will show Removable Disk (A:).

3.4 Advanced Chipset Features

This section allows you to configure the system based on the specific features of the installed chipset. This chipset manages bus speeds and access to system memory resources, such as DRAM and the external cache. It must be stated that these items should never need to be altered. The default settings have been chosen because they provide the best operating conditions for your system. The only time you might consider making any changes would be if you discovered that data was being lost while using your system.

SDRAM CAS Latency Time	3	Item Help
SDRAM Cycle Time Tras/Trc	6/8	Menu Level >
SDRAM RAS-to-CAS Delay	3	
SDRAM RAS Precharge Time	3	
System BIOS Cacheable	Enabled	
Video BIOS Cacheable	Enabled	
Memory Hole At 15M-16M	Disabled	
CPU Latency Timer	Disabled	
Delay Transaction	Enabled	
On-Chip Video Window Size	64MB	
Use VGA BIOS in VBU Block	Enabled	
Power Supply Type	ATX	
↑↓←→Move Enter: Select +/-/PU/PD: Value F10:Save ESC: Exit F1:General Help F5:Previous Values F6:Fail-safe defaults F7:Optimized Defaults		

SDRAM CAS Latency Time *Default: 3*

When synchronous DRAM is installed, the number of clock cycles of CAS latency depends on the DRAM timing.

SDRAM Cycle Time Tras/Trc *Default: 6/8*

Select the number of SCLKs for an access cycle.

SDRAM RAS-to-CAS Delay *Default: 3*

This field lets you insert a timing delay between the CAS and RAS strobe signals, used when DRAM is written to, read from, or refreshed. *Fast* gives faster performance; and *Slow* gives more stability. This field applies only when synchronous DRAM is installed in the system.

SDRAM RAS Precharge Time *Default: 3*

If an insufficient number of cycles are allowed for the RAS to accumulate its charge before DRAM refreshes, the refresh may be incomplete and the DRAM may fail to retain data. This field applies only when synchronous DRAM is installed in the system.

System BIOS Cacheable *Default: Enabled*

Selecting *Enabled* allows caching of the system BIOS ROM at F0000h-FFFFh, resulting in better system performance. However, if any program writes to this memory area, a system error may result.

Video BIOS Cacheable *Default: Enabled*

Select *Enabled* allows caching of the video BIOS, resulting in better system performance. However, if any program writes to this memory area, a system error may result.

Memory Hole At 15M-16M *Default: Disabled*

You can reserve this area of system memory for ISA adapter ROM. When this area is reserved, it cannot be cached. The user information of peripherals that need to use this area of system memory usually discusses their memory requirements.

Delayed Transaction *Default: Enabled*

This chipset has an embedded 32-bit posted write buffer to support deadly transactions cycles. Select *Enabled* to support compliance with PCI specification version 2.1.

On-Chip Video Window Size *Default: 64MB*

Select the on-chip video window size for VGA driver use.

Power-Supply Type *Default: ATX*

Sets the power supply type used. Options are AT and ATX

3.5 Integrated Peripherals

This option displays a list of items which **defines** the operation of some peripheral items on the system's input/output ports.

CMOS Setup Utility – Copyright © 1984 – 1998 Award Software
Integrated Peripherals

OnChip Primary PCI IDE	Enabled	Item Help
OnChip Secondary PCI IDE	Enabled	
IDE 32-bit Transfer Mode	Enabled	Menu Level > If your IDE hard drive supports block mode select Enabled for automatic detection of the optimal number of block read/write per sector the drive can support
IDE Primary Master PIO	Auto	
IDE Primary Slave PIO	Auto	
IDE Secondary Master PIO	Auto	
IDE Secondary Slave PIO	Auto	
IDE Primary Master UDMA	Auto	
IDE Primary Slave UDMA	Auto	
IDE Secondary Master UDMA	Auto	
IDE Secondary Slave UDMA	Auto	
USB Controller	Enabled	
USB Keyboard Support	disabled	
Init Display First	PCI Slot	
AC97 Audio	Enabled	
AC97 Modem	Enabled	
IDE HDD Block Mode	Enabled	
POWER ON Function	Button Only	
KB Power ON Password	Enter	
Hot Key Power On	Ctrl-F1	
Onboard FDC Controller	Enabled	
Onboard Serial Port 1	3F8/IRQ4	
Onboard Serial Port 2	2F8/IRQ3	
UART Mode Select	Nomal	
Onboard Parallel Port	378/IRQ7	
Parallel Port Mode	ECP+EPP	
EPP Mode Select	EPP1.9	
ECP Mode Use DMA	3	
PWRON After PWR-Fail	Off	
Game Port Address	201	
Midi Port Address	Disabled	
Midi Port IRQ	10	
↑↓←→ Move Enter: Select +/-PU/PD: Value F10:Save ESC: Exit F1:General Help F5:Previous Values F6:Fail-safe defaults F7:Optimized Defaults		

On-Chip Primary/Secondary PCI IDE *Default: Enabled*

This setup item allows you to either enable or disable the primary/secondary controller. You might choose to disable the controller if you were to add higher performance or specialized controller.

IDE Primary/Secondary Master/Slave *Default: Auto*
PIO

The four IDE PIO (Programmed Input/Output) fields let you set a PIO mode (0-4) for each of the four IDE devices that the onboard IDE interface supports. Modes 0 through 4 provide successively increased performance. In Auto mode, the system automatically determines the best mode for each device.

IDE Primary/Secondary Master/Slave *Default: Auto***UDMA**

Ultra DMA/33 implementation is possible only if your IDE hard drive supports it and the operating environment includes a DMA driver (Windows 95 OSR2 or a third-party IDE bus master driver). If your hard drive and your system software both support Ultra DMA/33, select Auto to enable BIOS support.

USB Controller *Default: Enabled*

Select *Enabled* if your system contains a Universal Serial Bus (USB) controller and you have USB peripherals

USB Keyboard Support *Default: Disabled*

Select *Enabled* if your system contains a Universal Serial Bus (USB) controller and you have a USB keyboard.

Init Display First *Default: PCI Slot*

This item allows you to decide to active whether PCI Slot or on-chip VGA first.

AC97 Audio/Modem *Default: Auto*

This item allows you to decide to enable/disable the 810 chipset family to support AC97 Audio/Modem.

IDE HDD Block Mode *Default: Enabled*

Block mode is also called block transfer, multiple commands, or multiple sector read/write. If your IDE hard drive supports block mode (most new drives do), select Enabled for automatic detection of the optimal number of block read/writes per sector the drive can support.

POWER ON Function *Default: BUTTON ONLY*

The Power On Function item allows you to power on the system by pressing

hot-keys. If you set this item to Hot Key, you can use the item Hot Key Power On to choose which hot keys are installed. If you set this item to Password, you can use the item KB Power On Password to choose which password is installed.

Onboard FDC Controller *Default: Enabled*

This item will enable or disable the floppy disk controller.

FDC Write Protect *Default: Disabled*

To enable/disable the write protection of floppy.

Onboard Serial Port 1/Port 2 *Default: 3F8/IRQ4*

Select an address and corresponding interrupt for the first and second serial ports. Note : Set to Auto is not recommended.

UART Mode Select *Default: Normal*

This lets you select the Infrared mode. Choices are Standard, HPIR, and ASKIR. If you choose BPIR or ASKIR mode, the screen will show another two lines to let you choose 'IR Function Duplex' (Full or Half) and " RxD TxD Active" (Hi Lo; Lo Hi; Hi Hi-,Lo Lo).

Onboard Parallel Port *Default: 378/IRQ7*

This item lets you disable the built-in parallel port, or enable it by assigning a I/O address and an Interrupt Request Line (IRQ).

EPP Mode Select *Default: EPP1.9*

Select EPP mode for the port.

ECP Mode Use DMA *Default: 3*

Select a DMA channel for the port. Choices are 3, 1.

3.6 Power Management Setup

CMOS Setup Utility – Copyright © 1984 – 1998 Award Software

Power Management Setup

ACPI function	Enabled	Item Help
Power Management	User Define	
Video Off Method	DPMS	Menu Level >
Video Off In Suspend	YES	
Suspend Type	Stop Grant	
MODEM Use IRQ	3	
Suspend Mode	Disabled	
HDD Power Down	Disabled	
Soft-Off by PWRBTN	Instant-off	
Wake-up by PCI Card	Disabled	
Power on by Ring	Disabled	
CPU THRM-Throttling	62.5%	
Resume by Alarm	Disable	
Date(of Month) Alarm	0	
Time(hh:mm:ss) Alarm	0 0 0	
** Reload Global Timer Events **		
Primary IDE 0	Disabled	
Primary IDE 1	Disabled	
Secondary IDE 0	Disabled	
Secondary IDE 1	Disabled	
FDD, COM, LPT Port	Disabled	
PCI IRQ [A-D]#	Disabled	
↑↓←→Move Enter: Select +/-/PU/PD: Value F10:Save ESC: Exit F1:General Help F5:Previous Values F6:Fail-safe defaults F7:Optimized Defaults		

ACPI function

Default: Enabled

When Enabled, this function can save the power of your system.

Power Management

Default: User Define

This category allows you to select the type (or degree) of power saving and is directly related to the following modes : Doze; Standby; Suspend; HDD Power Down.

- Min.Power Minimum power management. Doze =1hr.;
 Saving Standby= 1 hr.; Suspend= 1 hr.; HDD Power Down=15min
- Max. Power Maximum power management.
 Saving .Doze=1min.; Standby=1min.;Suspend=1 min.;
 HDD Power Down= 1 min
- User Allows you to set each mode individually.
- Defined When not disabled, each of the ranges are from 1 min. to 1 hr. except for HDD Power Down which ranges from 1 to

15min. and disable

If you would like to use Software Power-off Control function, you cannot choose "Disabled" here, and should select "Yes" in PM Control by APM.

Video Off Method

Default: DPMS

This determines the manner in which the monitor is blanked.

V/H SYNC+ Blank	This selection will cause the system to turn off the vertical and horizontal sync. ports and write blanks to the video buffer
Blank Screen	This option only writes blanks to the video buffer
DPMS	Initial display power management signaling

Video Off In Suspend

Default: Yes

This determines the manner in which the monitor is blanked.

Suspend Type

Default: Stop Grant

Select the Suspend Type.

The choice: PWRON Suspend, Stop Grant.

MODEM Use IRQ

Default: 3

This item determines the IRQ in which the MODEM can be used.

The choice: 3,4,5,7,9, 10,11,N/A.

Suspend Mode

Default: Disable

If you have selected User Define for the Power Management item, you can set this item to a selection of timeouts from 20 seconds to 40 minutes.

HDD Power Down

Default: Disable

When enabled and after the set time of system inactivity, the hard disk drive will be powered down while all other devices remain active.

Soft-off by PWR-BTTN

Default: Instant-off

Under ACPI (advanced configuration and power interface) the system can be turned off mechanically (by the power button) or it can undergo a software power off. If the system has been turned off by software, the system can be resumed by a LAN, MODEM or ALARM wake up signal. This item allows you to define a software power off using the power button. If the value is set to Instant-Off, the power button will automatically cause a software power off. If the value is set to Delay 4 Sec. the power button must be held down for a full four seconds to cause a software power off.

PowerOn by Ring

Default: Disabled

Enabled: when system in suspend mode, it can be wake up by modem.
Disabled: it cannot be wake up by modem.

Wake Up On LAN*Default: Enabled*

Enabled: If you have installed LDCM administrator software, and any client side is powered off, you can wake up by LAN through the LDCM mechanism.

Resume by Alarm*Default: Disabled*

When Enabled, two additional lines will be added to the screen Date (of Month) Alarm; Time (hh:mm:ss) Alarm to let user set the desired date and time. After power off, the system will automatic power on at the specified date and time.

Reload Global Timer Events

When enabled, an event occurring on each device listed below restarts the global time for Standby mode.

IRQ [3 -7, 9-15], NM;
Primary IDE 0;
Primary IDE 1;
Secondary IDE0;
Secondary IDEL;
FDD,COM,LPT Port
PCI PIRQ[A-D]#

3.7 PNP/PCI Configuration Setup

The PNP/PCI Configuration Setup allows you to configure the and PCI devices installed in your system. The following screen appears if you select the option PNP/PCI Configuration setup from the main menu.

CMOS Setup Utility – Copyright © 1984-1998 Award Software
PnP/PCI Configurations

Reset Configuration Data	Disabled	Item Help
Resources Controlled By	Auto(ESCD)	Menu Level >
IRQ Resources	Press Enter	Default is Disabled.
DMA Resources	Press Enter	Select Enabled to reset
PCI/VGA Palette Snoop	Disabled	Extended System
Assign IRQ For VGA	Disabled	Configuration Data (ESCD)
Assign IRQ For USB	Enabled	when you exit Setup if you
NCR/SYMBIOS SCSI ROM	Auto	have installed a new
		add-on and the system
		reconfiguration has
		caused such a serious
		conflict that the OS
		cannot boot
↑↓←→Move Enter: Select +/-/PU/PD: Value F10:Save ESC: Exit F1:General Help F5:Previous Values F6:Fail-safe defaults F7:Optimized Defaults		

Resources Controlled By *Default: Auto(ESCD)*

You should leave this item at the default Auto. If you find that you cannot get a particular expansion card to work properly, you might be able to solve the problem by changing this item to Manual and manually configuring the card. If you change this item to Manual, a series of items will appear that allow you to define the assignments of the system interrupt lines (IRQS) and Direct Memory Access (DMA) channels. By default, these items are set to PCI/ISA PnP.

Assign IRQ For VGA *Default: Enabled*

To assign an IRQ to VGA card if you enable this item.

Assign IRQ For USB *Default: Enabled*

To assign an IRQ to USB Ports if you enable this item.

3.8 PC Health Status

This option displays a list of PC health status which are detected by on board

sensor chips.

CMOS Setup Utility – Copyright © 1984-1998 Award Software
Frequency/Voltage Control

CPU Warning Temperature	Disabled	Item Help	
Current System Temp.	40°C/104°F		
Current CPU1 Temperature	40°C/104°F	Menu Level >	
Current CPUFAN1 Speed	5037 RPM		
Current CPUFAN2 Speed	0 RPM		
Current CPUFAN3 Speed	0 RPM		
IN0(V)	2.01 V		
IN2(V)	2.48 V		
IN2(V)	3.42 V		
+ 5 V	4.99 V		
+12 V	11.97 V		
-12 V	-11.86 V		
- 5 V	- 5.09 V		
VBAT(V)	3.22 V		
5VSB(V)	5.45 V		
Shutdown Temperature	60°C/140°F		
↑↓←→ Move Enter: Select +/-/PU/PD: Value F10:Save ESC: Exit F1:General Help F5:Previous Values F6:Fail-safe defaults F7:Optimized Defaults			

CPU Warning Temperature

Default: Disabled

When this item is enabled, we can set the CPU warning temperature . If the CPU temperature is higher than the setting temperature, the system will beep.

Current System Temp.

This field displays the *current* system temperature.

Current CPU1 Temperature

It shows the current CPU temperature.

Current CPUFAN1 Speed

Current CPUFAN2 Speed

Current CPUFAN3 Speed

It shows the running speed of the system fan, Chassis fan and power fan. The

value will be changing when the system is running. If you do not install the fan, the value will show 0.

Shutdown Temperature *Default: 60°C/140°F*

When the system temperature up to 60°C/140°F, it will be shutdown.

3.9 Frequency/Voltage Control

CMOS Setup Utility – Copyright © 1984-1998 Award Software
Frequency/Voltage Control

Auto Detect DIMM/PCI CLK	Enabled	Item Help
Spread Spectrum	Disabled	
CPU/SDRAM/PCI Clock	Default	
CPU Ratio	X 3	Menu Level >
↑↓←→ Move Enter: Select +/-PU/PD: Value F10:Save ESC: Exit F1:General Help F5:Previous Values F6:Fail-safe defaults F7:Optimized Defaults		

Auto Detect DIMM/PCI Clk *Default: Enabled*

This item allows you to enable/disable auto detect DIMM/PCI Clock.

Spread Spectrum Modulated *Default: Disabled*

Enable / Disable this item the BIOS will Enable / Disable the clock generator spread spectrum .

CPU/SDRAM/PCI Clock *Default: Default*

This item allows you to select the CPU/SDRam/PCI frequency. We recommend that you leave this item at the default value.

CPU Clock Ratio *Default: X 3*

This item allows you to select the CPU frequency.

3.10 Load Fail-Safe Defaults

When you press <Enter> on this item you get a confirmation dialog box with a message similar to:

Load Fail-Safe Defaults (Y/N) ? **N**

Pressing 'Y' loads the BIOS default values for the most stable, minimal-performance system operations.

3.11 Load Optimized Defaults

When you press <Enter> on this item you get a confirmation dialog box with a message similar to:

Load Optimized Defaults (Y/N) ? **N**

Pressing 'Y' loads the default values that are factory settings for optimal performance system operations.

3.12 Supervisor/User Password Setting

These two items can be used to install a Supervisor Password and a User Password. If you log on as Supervisor, you have full access to the system, and you can restrict the permissions granted to someone who logs on as User. For example, a Supervisor can restrict a User from entering the setup utility.

To install a Supervisor or User Password, follow these steps:

1. Highlight the item Supervisor/User password on the main menu and press Enter.
2. The password dialog box will appear.
3. If you are installing a new password, carefully 4W in the password. You cannot use more than 8 characters or numbers. The password will differentiate between upper case and lower characters. Press **Enter** after you have typed in the password. If you are deleting a password that is already installed just press **Enter** when the password dialog box appears.
4. The system will ask you to confirm the new password by asking you to type

- it in a second time, Carefully type the password again and press **Enter**, or just press **Enter** if you are deleting a password that is already installed.
5. If you type the password correctly, the password will be installed.

3.13 Save and Exit Setup Option

This allows you to save the new setting values in the CMOS memory and continue with the booting process. Select what you want to do, press <Enter>.

3.14 Exit Without Saving Option

This allows you to exit the BIOS setup utility without recording any new values or changing old ones.

Highlight this item and press **Enter** to save the change that you have made in the setup utility and exit the setup program. When the *Save and Exit* dialog box appears, press **Y** to discard changes and exit, or press **N** to return to the setup main menu.

Chapter 4

Software Setup

The support software for this motherboard may be supplied on a CD-Title, or it may be supplied on diskettes. All the support programs are stored in separate folders, so you can find the program you need easily enough. The support software contains the following programs:

- IDE Bus Master drivers for Win 98/Win 95/NT.
- Intel 810 VGA driver.
- ADI 1881 Audio driver.
- PC-Cillin 98 Software.

Note: Please refers the PC-Cillin 98 installation guide for installing the PC-Cillin 98.

4.1 Installing the IDE Bus Master Driver

After you have finished the hardware setup, you have to install the IDE Bus Master software of the motherboard, then you can enjoy the advance Motherboard.

According the follow steps for IDE Bus Master driver installation:

1. Turn on your PC then put the “**CD title**” into your CD-ROM drive.
(Please make sure it’s under Win98/95 mode)
2. The CD title will be auto-run. If not, please click the “**start**” button and select “**Run**” item. Then type-> **D:\setup** (D is assigned your CD-ROM Device)

3. Press “Intel Chip” button.

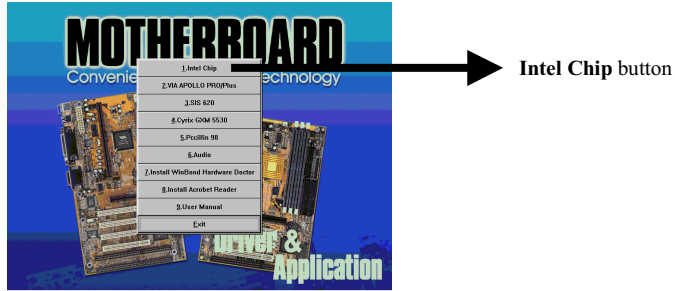

4. Press “Win9x INF Update for Bus Master” and follow the instructions to this software. Then Re-boot your PC.

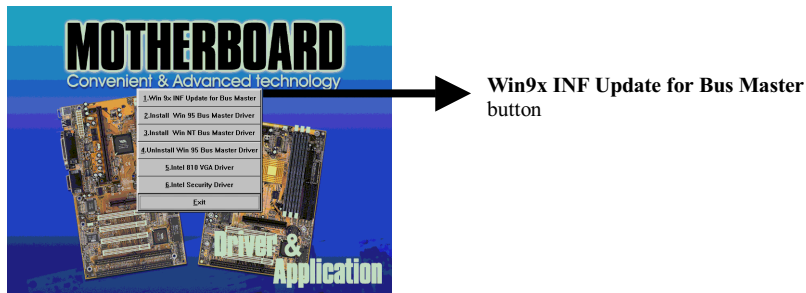

5. Click **Next** when the Welcome screen appears.

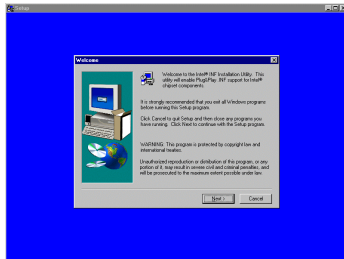

6. Follow the instructions to complete the software installation, then re-boot your PC.

4.2 Installing the Intel 810 VGA Driver

According the follow steps for Intel 810 graphics driver installation:

1. Turn on your PC then put the “**CD title**” into your CD-ROM drive.
(Please make sure it’s under Win98/95 mode)
2. The CD title will be auto-run. If not, please click the “**start**” button and select “**Run**” item. Then type-> **D:\setup** (D is assigned your CD-ROM Device)
3. Press “**Intel Chip**” button.

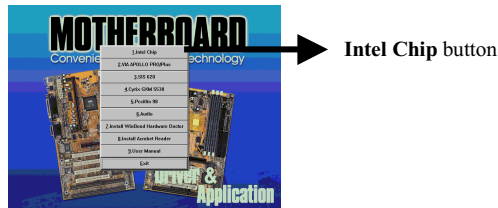

4. Press “**Intel 810 VGA driver**” button.

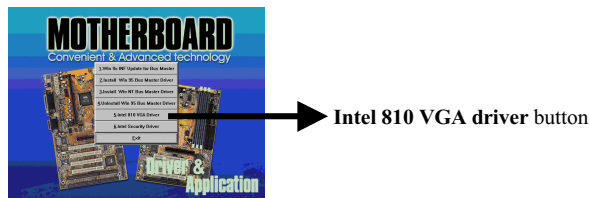

5. Press “**Win9x Intel 810 VGA driver**” button.

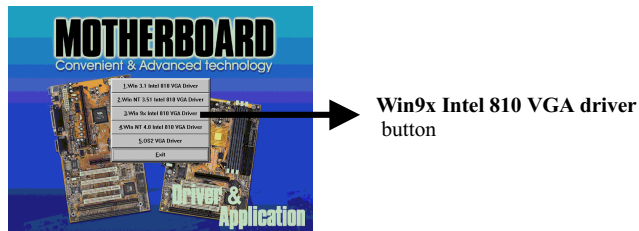

6. Follow the instructions to complete the software installation, then re-boot your PC.

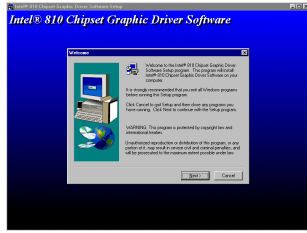

4.3 Installing the ADI 1881 Audio Driver

According the follow steps for ADI 1881 audio driver installation:

1. Turn on your PC then put the “**CD title**” into your CD-ROM drive.
(Please make sure it’s under Win98/95 mode)
2. The CD title will be auto-run. If not, please click the “**start**” button and select “**Run**” item. Then type-> **D:\setup** (D is assigned your CD-ROM Device)
3. Press “**Audio**” button.

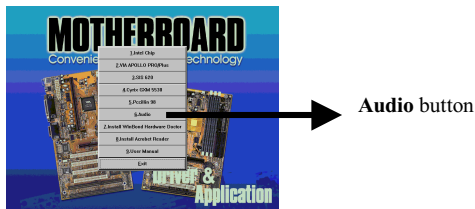

4. Press “**ADI 1881**” button.

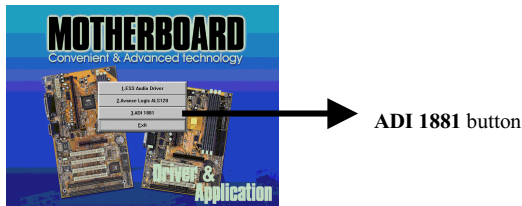

5. Press “Win 98 [WDM]” button.

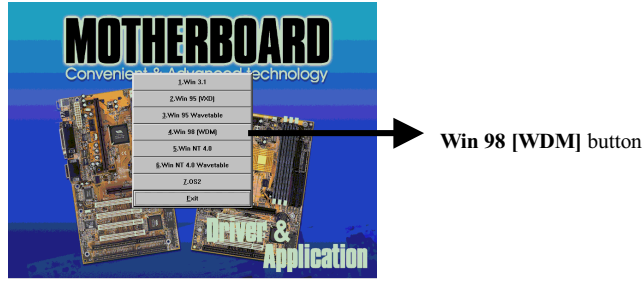

Note: If your O.S. is Win95, please press “Win95 [Vxd] & Win95 Wavetable” button to install the audio driver.

6. Follow the instructions to complete the software installation, then re-boot your PC.

