



M6Pi Pentium Pro Server Class PCI/ISA System Board Manual

Document Number: 06-00257-01, Rev. 3A

November 1995

221 Warren Ave., Fremont, CA 94539-7085

Copyright Notices

Micronics Computers, Inc.

The information contained in the M6Pi system board manual has been carefully checked and is believed to be accurate. Micronics assumes no responsibility for any inaccuracies that may be contained in this document. Micronics makes no commitments to update or to keep the information in this manual at a current level when changes are made to the product.

Micronics reserves the right to make improvements to this document and/or product at any time and without notice.

All Rights Reserved. No part of this document may be photocopied, reproduced, translated, or reduced to any medium or machine form without prior, written consent from Micronics.

COPYRIGHT (C) 1995, Micronics Computers, Inc.

Portions of the Manual

Portions of this manual were copied (with permission) from Phoenix Technologies, Ltd.

Trademarks

IBM is a registered trademark of International Business Machines. Microsoft, Microsoft Word, Windows are registered trademarks of Microsoft Corporation. Intel and PCI are registered trademarks of Intel Corporation. UNIX is a registered trademark of AT&T Corporation. Lotus 1-2-3 is a registered trademark of Lotus Development Corp. All other product names mentioned herein are used for identification purposes only and may be the trademarks of their respective companies.

Micronics Quick Installation

We know that many experienced people prefer to read as little of the documentation as possible. If this sounds like you, here's a quick overview:

1. Ground yourself to prevent damaging static discharge, then remove the M6Pi from its packaging.
2. Configure and verify the system board's jumper settings. (See Jumper Settings in Chapter 2)
3. Install the CPU and the system memory (Chapter 3).
4. Install the CPU Power Module (Chapter 3).
5. Install the system board into the chassis and make all necessary connections (Chapter 3).
6. Install any peripherals (Chapter 3).
7. Turn the computer on and press the <F2> key when you see the screen below:

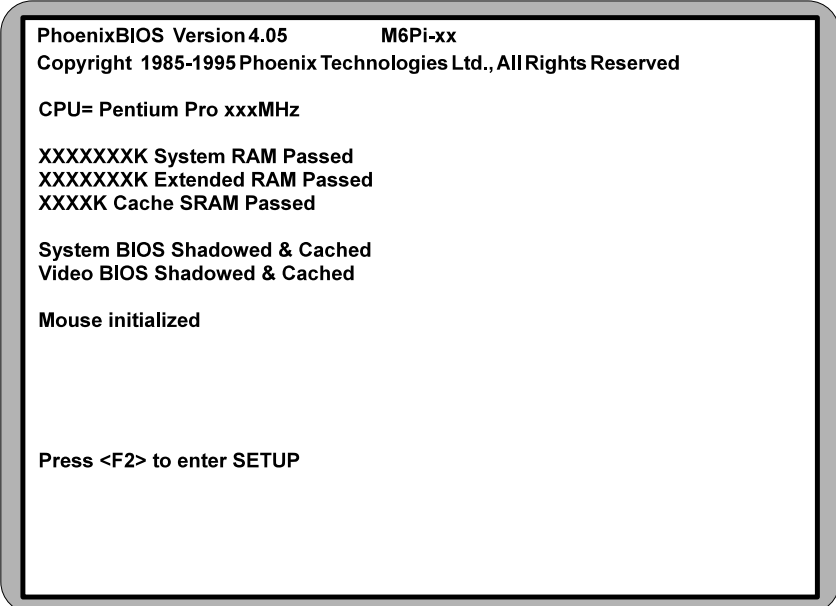

PhoenixBIOS Version 4.05 M6Pi-xx
Copyright 1985-1995 Phoenix Technologies Ltd., All Rights Reserved

CPU= Pentium Pro xxxMHz

XXXXXXXXK System RAM Passed
XXXXXXXXK Extended RAM Passed
XXXXK Cache SRAM Passed

System BIOS Shadowed & Cached
Video BIOS Shadowed & Cached

Mouse initialized

Press <F2> to enter SETUP

8. Set the time and date. Adjust the BIOS settings to match your configuration. If installing an IDE drive, select the IDE device you wish to configure. Press <Enter> with Autotype Fixed Disk selected and the BIOS will automatically configure the drive for you (Chapter 4).
9. After you have configured the Main Setup menu, make any desired setting configurations in the Advanced and Security menu. When finished, go to the exit screen, select “Save Changes and Exit,” and you are finished with the BIOS configuration (Chapter 4).

Contents

Introduction	1-1
Features	1-2
Software Compatibility	1-2
Configuring the M6Pi	2-1
Static Electricity	2-1
Office Environment	2-1
M6Pi Components	2-2
Jumper Settings	2-3
Installing the M6Pi, System Memory, CPUs and Peripherals	3-1
Installation of the M6Pi	3-2
Tools Required	3-2
Equipment Required	3-2
System Memory	3-3
SIMMs Supported	3-3
Upgrading Rules	3-3
Common Memory Configurations	3-4
Installing the SIMMs	3-5
Removing SIMMs	3-5
Installing a CPU	3-6
Installing the CPU Power Module	3-7
Removing the CPU Power Module	3-7
Installing a PCI Peripheral Card	3-8
Installing an ISA Peripheral Card	3-9
The BIOS Setup Utility	4-1
Configuration	4-1
Initial Boot Up	4-1
Setup	4-2
Running the Setup Procedure	4-3
Setting the Main Screen	4-3
System Time and Date	4-3

Diskette A or B	4-4
IDE Adapters (Hard Disk Setup)	4-4
Video System	4-6
System Memory	4-6
Extended Memory	4-6
Cache State	4-6
Setting the Advanced Screen	4-7
Serial Port A	4-7
Serial Port B	4-7
Serial Port B Mode	4-7
Parallel Port	4-8
Parallel Port Mode	4-8
Diskette Controller	4-8
IDE Controller	4-8
Boot Sequence	4-8
Plug & Play O/S	4-8
Reset Configuration Data	4-8
Large Disk Access Mode	4-8
Security Screen	4-9
Supervisor Password	4-9
User Password	4-9
Set Supervisor Password	4-9
Set User Password	4-10
Password on Boot	4-10
Diskette Access	4-10
Fixed Disk Boot Sector	4-10
Exit Screen	4-11
POST Messages	A-1
Beep and POST Codes	B-1
Hard Disk Drive Types	C-1
Specifications	D-1
Environmental Specifications	D-2
Temperature Range	D-2
Relative Humidity	D-2
Battery Disposal	D-3

FCC Warning Statement F-1

Glossary G-1

Limited Warranty W-1

Non-Warranty Service W-2

List of Figures

Figure 2-1: M6Pi Components	2-2
Figure 3-1: Installing a 72-Pin SIMM	3-5
Figure 3-2: Installing the CPU Power Module	3-7
Figure 3-3: Installing an PCI Peripheral Card	3-8
Figure 3-4: Installing an ISA Peripheral Card	3-9
Figure 4-1: Power-Up Screen	4-2
Figure 4-2: CMOS Main Screen	4-3
Figure 4-3: IDE Device Submenu	4-4
Figure 4-4: Advanced Screen	4-7
Figure 4-5: Security Setup Screen	4-9
Figure 4-6: Exit Screen	4-11

List of Tables

Table 2-1: CPU Speed Selection	2-3
Table 2-2: BIOS Reset Jumper	2-3
Table 2-3: Case and Peripheral Connections	2-4
Table 3-1: Common Memory Configurations	3-4

1 Introduction

Congratulations for choosing the Micronics M6Pi! The M6Pi is a high-performance Pentium Pro system board designed to be the foundation for servers, advanced systems, and processor-intensive applications. The Intel Pentium Pro processor combined with Micronics' system board experience makes this is one of the best performing system boards on the market.

The M6Pi comes with many high performance features. These include Mode 4 support for four IDE hard drives, support for up to 512MB of RAM, Level 2 (L2) cache, the PCI bus, and Phoenix 4.05 Plug and Play BIOS.

The M6Pi also includes the features that you have come to expect from Micronics. These include on-board support for two floppy drives, a bi-directional parallel port, and two high speed serial ports.

Micronics builds all products to exacting standards, using the highest quality components available. We are proud to provide this system board and hope it brings you years of reliable service.

Features

The M6Pi includes the following features:

- Support for 150MHz, 166MHz, 180MHz, or 200MHz Pentium Pro processors.
- Baby AT size system board (13.25" X 8.5").
- 256K Level 2 (L2) cache.
- Supports up to 512MB of on-board system memory.
- Supports 2 way interleaved memory access.
- Supports ECC (Error Correct Code).
- PCI Mode 4 IDE controller (supports two drives).
- Floppy controller for two floppy drives (supports 2.88MB, 1.44MB, 1.2MB, 720K, and 360K floppy drives).
- Two high speed NS16550 compatible serial ports.
- Bi-directional parallel port which is EPP and ECP compatible (see Specifications).
- Upgradeable Flash Phoenix BIOS.
- All slots accomodate full length peripheral cards.

Software Compatibility

The M6Pi system board was thoroughly tested for compatibility with a variety of operating systems and environments, including:

- Windows, Windows 95, and Windows NT.
- OS/2.
- SCO UNIX and Open Desktop.
- Novell NetWare.
- MS-DOS.
- PC-DOS.
- NeXTStep.

2 Configuring the M6Pi

Although the M6Pi system board is packaged in protective materials, it is important to use care while unpacking and setting up.

Static Electricity

The M6Pi is shipped from the factory in an antistatic bag. To reduce the possibility of damage, it is important to neutralize any accumulated static charges on your body before handling the board. The best way to neutralize these static charges is to ground yourself using a special wrist or ankle strap. If you do not have a strap, you should touch both of your hands to a safely grounded object. After you have grounded yourself, ground the M6Pi via the solder pads surrounding one of its mounting holes.

Once the M6Pi is removed from its packaging, place it on top of the antistatic bag. Carefully inspect the board for damage which may have occurred during shipment.

Office Environment

Make sure the finished computer system is in an area with good ventilation. The system should not be in direct sunlight, near heaters, or exposed to moisture, dust, or dirt.

M6Pi Components

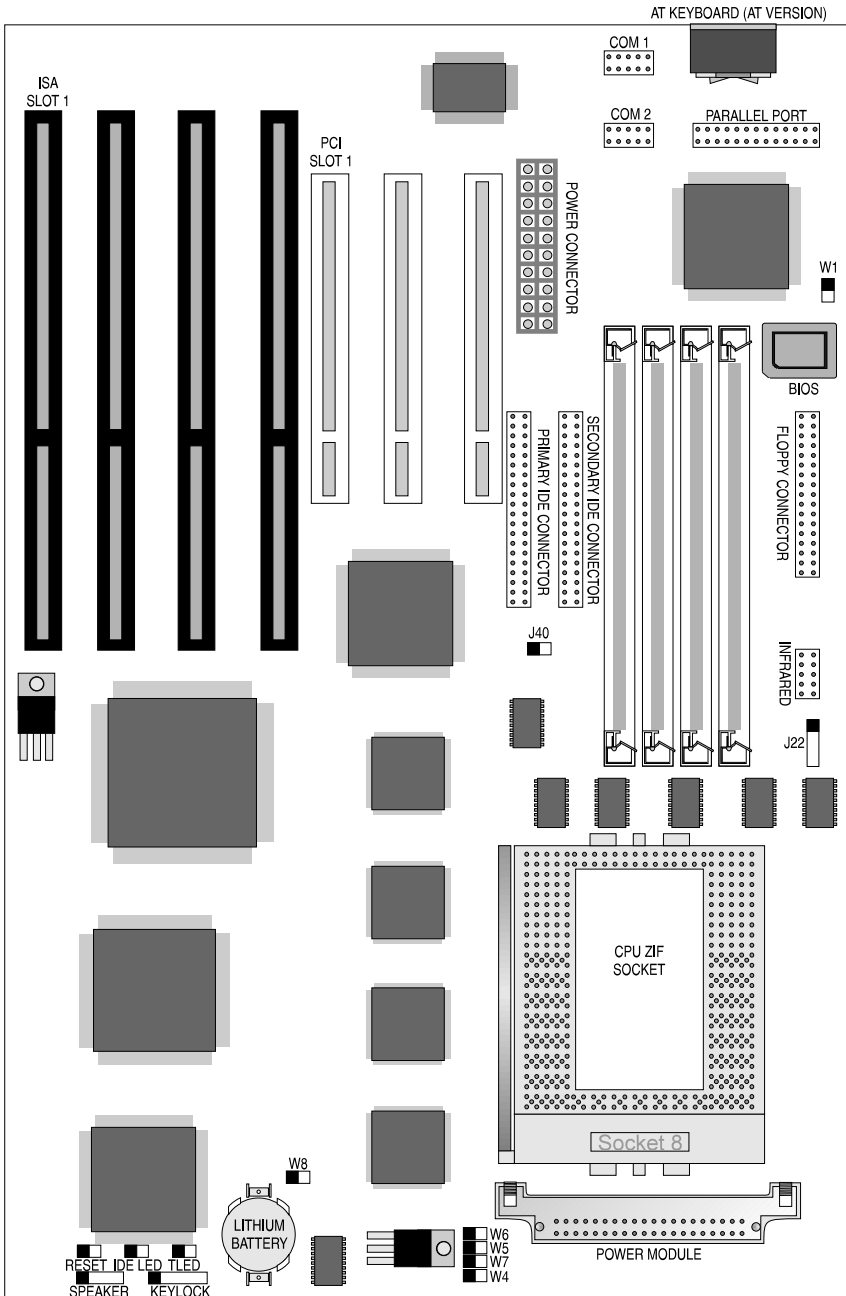

Figure 2-1 M6Pi System Board

Jumper Settings

Table 2-1 lists the jumper settings to configure the CPU speed.

CPU Speed	Jumper	W4	W5	W6	W7	W8
150MHz Ext., 60MHz Int.		closed	closed	closed	open	open
166MHz Ext., 66MHz Int.		closed	closed	closed	open	closed
180MHz Ext., 60MHz Int.		closed	open	closed	closed	open
200MHz Ext., 66MHz Int.		closed	open	closed	closed	closed

Table 2-1 CPU Speed Selection

Table 2-2 lists the jumper settings to reset the BIOS. With the computer's power off, short Jumper W1 for about five seconds and place the jumper back in the open position. *The jumper must be placed back into the open position for the system to function properly.*

Jumper	Function	Setting
W1	Normal operation (default)	open
	Clear CMOS RAM settings	closed

Table 2-2 BIOS Reset Jumper

Note:

This will reset all BIOS settings to their defaults. Any changes you have made will be lost.

Table 2-4 lists the jumper settings for case and peripheral connections.

Jumper	Function	Notes
J10	Primary IDE Connector	Primary
J11	Secondary IDE Connector	Secondary
J27	Floppy Connector	
J24	Parallel Port Connector	Can be disabled at the CMOS configuration screen.
J25	Serial Port 1(Com1)	Can be disabled at the CMOS configuration screen.
J26	Serial Port 2(Com 2)	Can be disabled at the CMOS configuration screen.
J23	Infrared Connector	
J22	Infrared Connector	
J33	Power Module Connector	
J30 & J28	PS/2 Keyboard & Mouse	PS/2 Version
J31	AT Keyboard	AT Version
J34	Power Supply Connector	ATX standard.
J12	Hard Disk LED	1-+5V DC, 2-Ground
J38	Reset	
J36	Turbo LED	1-+5V DC, 2-Ground
J32	Keylock/Power LED	1-Power; 2-N/C; 3-Ground; 4-Keylock; 5-Ground
J13	Speaker Connector	1-Speaker; 2-5V DC; 3-N/C; 4-5V DC

Table 2-4 Case and Peripheral Connections

3 Installing the M6Pi, System Memory, CPUs and Peripherals

This section explains how to install the M6Pi system board, SIMMs, CPUs, and peripherals.

Warning:

Before installing or removing any peripherals or components, make sure you have a clear work space and adhere to all anti-static precautions described on page 2-1. Micronics recommends only trained technicians operate on the system board. Damage which occurs to the board while adding or removing peripherals or components may void the warranty.

If problems arise while installing peripherals, contact the computer outlet where you purchased the peripheral or Micronics' Technical Support Department.

Installation of the M6Pi

The installation of the M6Pi system board depends on the type of case you use. The M6Pi is an integrated baby AT size system board and may be installed into most cases.

Prior to installing the M6Pi, make sure you have a clear work space available and adhere to all anti-static precautions.

If you are unfamiliar with installing a system board, Micronics highly recommends you read the computer user's manual or contact your dealer's technical support department.

Tools Required

Micronics recommends using the following tools to install the M6Pi:

- m Small Phillips screwdriver.
- m Tweezers or a pair of needle-nose pliers.
- m Tray (to hold loose screws).

Equipment Required

Micronics recommends using the following equipment with the M6Pi for a typical configuration:

- m Chassis with standard hardware.
- m A high quality ATX power supply. A power filter may be used with a noisy AC power source.
- m AT compatible keyboard (AT Version).
- m PS/2 compatible keyboard (PS/2 Version).
- m Eight ohm speaker.
- m Standard ribbon cables for internal connections.
- m Standard power cord (grounded).
- m CPU heat sink with cooling fan (strongly recommended).

System Memory

System memory devices, commonly known as SIMMs (Single Inline Memory Modules), are necessary to operate the M6Pi system board. The M6Pi has four SIMM sockets and may be upgraded to 256 Megabytes of RAM. This section will explain the type of SIMMs supported, list the rules of adding memory to the M6Pi, give some examples of common memory configurations, and show how to physically install the new SIMMs.

SIMMs Supported

The M6Pi supports the following 72 pin, 60ns or 70ns SIMMs:

- 4MB (1Mx36 or 1Mx32)
- 8MB (2Mx36 or 2Mx32)
- 16MB (4Mx36 or 4Mx32)
- 32MB (8Mx36 or 8Mx32)
- 64MB (16Mx36 or 16Mx32)

Note:

For long term reliability, Micronics recommends using SIMMs with tin-plated contacts. The use of gold-plated contacts may conflict with the tin-alloy on the SIMM socket.

Upgrading Rules

The following is a list of rules to follow when upgrading SIMMs. If you follow these rules, your upgrade should be trouble-free:

- Use 70ns or faster SIMMs.
- Upgrade SIMMs one bank at a time. All SIMM sockets must contain SIMMs of the same size and preferably from the same manufacturer. To add 16MB of memory to the system board, install two 8MB SIMMs into the same bank.
- When installing SIMMs, fill bank 0, then bank 1.

Common Memory Configurations

The following table (Table 3-1) lists all available memory configurations.

Memory	Bank 0	Bank 1
8MB	(2) 4MB	
16MB	(2) 4MB	(2) 4MB
16MB	(2) 8MB	
32MB	(2) 16MB	
32MB	(2) 8MB	(2) 8MB
64MB	(2) 32MB	
64MB	(2) 16MB	(2) 16MB
128MB	(2) 64MB	
128MB	(2) 32MB	(2) 32MB
256MB	(2) 128MB	
256MB	(2) 64MB	(2) 64MB

Table 3-1 Common Memory Configurations

Note:

The Micronics M6Pi utilizes 2-way interleaved access to achieve optimal memory performance. To take advantage of this, it is necessary to install two banks of memory (four SIMMs) at a time.

Installing the SIMMs

To install the SIMMs, locate the memory banks on the system board and perform the following steps:

1. Hold the SIMM so the notched edge is aligned with the notch on the SIMM socket (Figure 3-1).
2. Insert the SIMM at a 45 degree angle.
3. Gently push the SIMM into an upright position until it locks into place (past the release tabs).

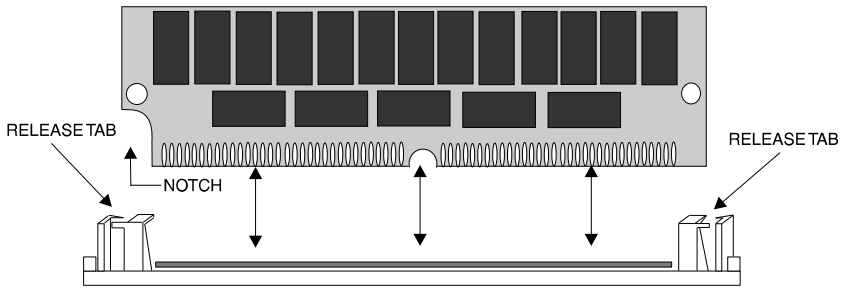

Figure 3-1 Installing a 72-Pin SIMM

Removing SIMMs

Perform the following steps to remove SIMMs, if necessary:

1. With both thumbs (or a finger from each hand), press the release tabs away from the socket.
2. With the SIMM free from the release tabs, lift the module up and place in an anti-static bag or package.

Installing a CPU

The M6Pi is designed to a variety of Pentium Pro processors. Follow the steps below to install a processor:

1. Turn off the computer and remove its cover.
2. Locate the ZIF socket illustrated in Figure 2-1.
3. Lift the lever of the socket.
4. Locate pin 1 on the processor and pin 1 on the socket. Gently set the processor into the socket, making sure pin 1 on the processor and pin 1 on the socket are aligned.
5. Push the lever down until it locks into place.
6. Make sure the speed selection jumpers are set correctly (Chapter 2).

Warning:

Pentium Pro processors require a heat-sink with a cooling fan. Failure to provide adequate cooling of the processor may seriously affect system performance or cause permanent damage to the processor.

Installing the CPU Power Module

To install the CPU Power Module, follow the instructions below:

1. Turn the computer off and remove the chassis cover.
2. Locate the CPU Power Module socket located below the ZIF socket.
3. Ground yourself and remove the CPU Power Module from its antistatic bag.
4. Insert the module with the bottom edge level to the socket. Gently press straight down until the module locks into place (Figure 3-2).

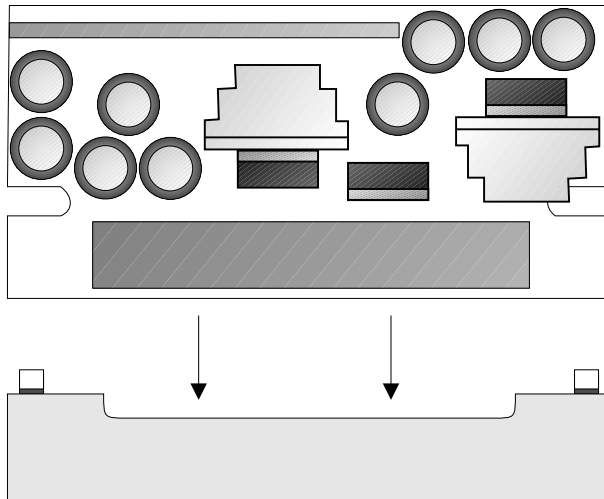

Figure 3-2 Installing the CPU Power Module

Removing the CPU Power Module

Perform for the following steps to remove the power module.

1. With both thumbs (or a finger from each hand), press the release tabs away from the socket until the module rises slightly from the socket.
2. With the SIMM free from the release tabs, lift the module up and place in an anti-static bag or package.

Installing a PCI Peripheral Card

Micronics PCI slots accommodate all PCI peripherals which adhere to the PCI 2.0 specifications. Complete the following steps to install a PCI card:

1. Turn the computer system off and remove its cover.
2. Choose an unused PCI slot and remove the slot cover.
3. Insert the card with the bottom edge level to the slot. **Never insert the card at an angle!**
4. Carefully push the card straight down, making sure the card is inserted fully.
5. Replace the screw which holds the card into place.
6. Replace the computer cover.
7. Read the card's manual for additional instructions concerning installation and software drivers.

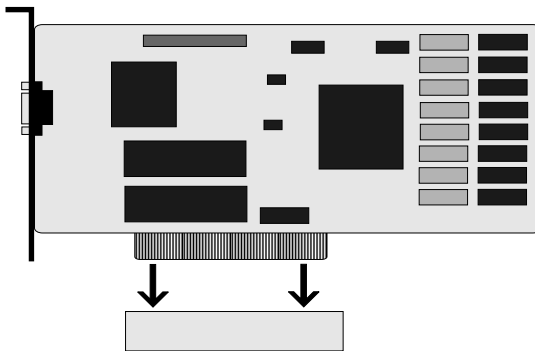

Figure 3-3 Installing a PCI Peripheral Card

Installing an ISA Peripheral Card

Micronics ISA slots accommodate all standard ISA peripherals. Complete the following steps to install an ISA card:

1. Turn the computer system off and remove its cover.
2. Choose an unused ISA slot and remove the slot cover.
3. Insert the card with the bottom edge level to the slot. **Never insert the card at an angle!**
4. Carefully push the card straight down, making sure the card is inserted fully.
5. Replace the screw which holds the card into place.
6. Replace the computer cover.
7. Read the card's manual for additional instructions concerning installation and software drivers.

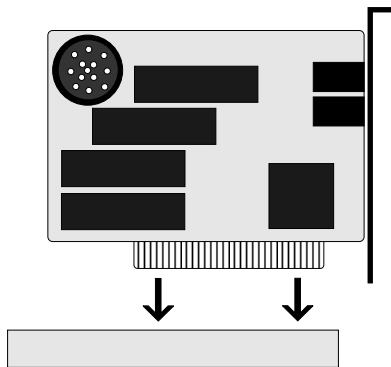

Figure 3-4 Installing an ISA Peripheral Card

4 The BIOS Setup Utility

Configuration

After the M6Pi system board and all hardware is installed, the system is ready for configuration. Before turning on the computer, make sure all cables are correctly connected and all jumpers are correctly set.

It is recommended you keep the computer cover off the first time you boot the system. This will make it easier to correct any difficulties that might arise.

Initial Boot Up

Power up the M6Pi. If the system does not properly boot, check all your cables and peripherals for bad connections. You may also get beep codes or error messages. If this occurs, consult Appendices A and/or B for a guide to possible solutions.

After the system properly boots, it is ready to be configured. The following pages explain the proper procedures for BIOS configuration.

Setup

The Setup program is used to configure the computer's BIOS (Basic Input/Output System). The computer's BIOS is responsible for configuring the system board and providing hardware information to the operating system. In order for the computer to run properly, run the Setup procedure after first installing the system board and whenever you make a hardware change to the system.

After the system is turned on and goes through a memory test, the Power-Up Screen (Figure 4-1) will appear on your monitor:

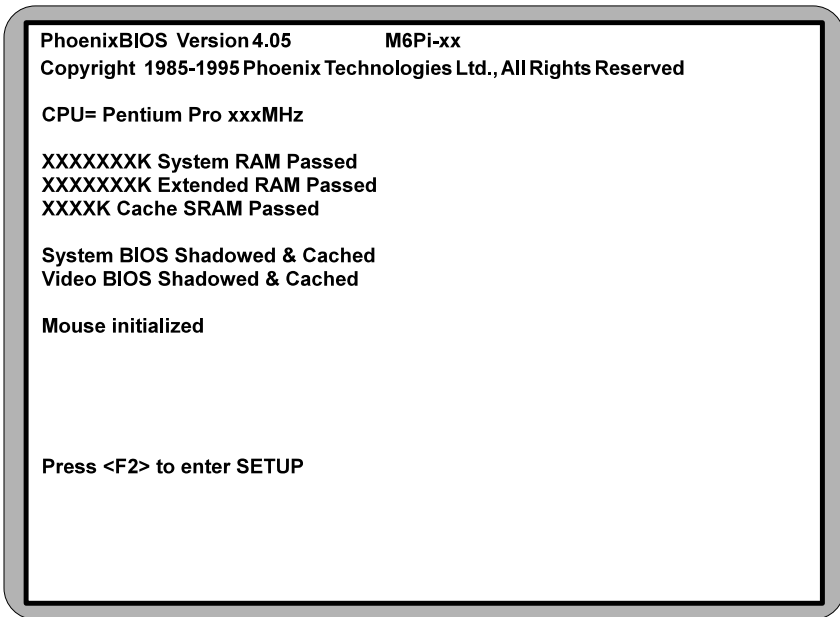

Figure 4-1 Power-Up Screen

When “Press <F2> to enter SETUP” appears at the bottom of the screen, press the <F2> key to begin the Setup procedure. The CMOS Main Screen (Figure 4-2) should appear and the prompt should be on the time line. The Setup procedure can only be activated during the boot sequence.

Running the Setup Procedure

The M6Pi system board has four primary CMOS configuration screens: the Main Screen (Figure 4-2), the Advanced Screen (Figure 4-5), the Security Screen (Figure 4-10), and the Exit Screen (Figure 4-10). To toggle between the screens, press the right arrow <→> and the left arrow <←> keys.

Setting the Main Screen

The CMOS Main Screen (Figure 4-2) is used to set the time and date, to set the floppy drive types, to configure the hard disks, and to configure the video. This section explains how to configure each of these categories. To move between the categories, use the up and down arrow keys <↑/↓>.

PhoenixBIOS Setup - Copyright 1985-94 Phoenix Technologies Ltd.			
Main	Advanced	Security	Exit
System Time:		[HH:MM:SS]	Item Specific Help <Tab>, <Shift-Tab>, or <Enter> selects field.
System Date:		[MM/DD/YYYY]	
Diskette A:		[1.44 MB, 3 1/2"]	
Diskette B:		[Not Installed]	
▶IDE Device 0 Master:		[None]	
▶IDE Device 0 Slave:		[None]	
▶IDE Device 1 Master:		[None]	
▶IDE Device 1 Slave:		[None]	
Video System:		[VGA/SVGA]	
System Memory:		xxx KB	
Extended Memory:		xxx MB	
Cache State:		[Enabled]	
F1 Help	↑↓ Select Item	-/+ Change Values	F9 Setup Defaults
Esc Exit	←→ Select Menu	Enter Select Sub-Menu	F10 Previous Values

Figure 4-2 CMOS Main Screen

System Time and Date

To set the time, use the <-> key to decrease the number and the <+> key to increase the number. To move the prompt forward, use the <Tab> key; to move the prompt backward, use the <Shift-Tab> key. To set the date, use the

up and down arrows<↑/↓> to highlight the System Date and follow the same procedure used to set the time.

Diskette A or B

To configure a floppy drive added to or removed from your computer, use the up and down arrow keys <↑/↓> to select the desired drive. Use the <+/-> keys to change the setting until it matches the floppy drive you installed. The BIOS supports 2.88MB, 1.44MB, 1.2MB, 720KB, and 360KB floppy drives.

IDE Adapters (Hard Disk Setup)

If you are setting up a SCSI hard disk, select None in the IDE Device parameters (see your SCSI card manual for more details).

To install an IDE device, select the device to configure and press <Enter>. An IDE Device submenu will appear. (Figure 4-3).

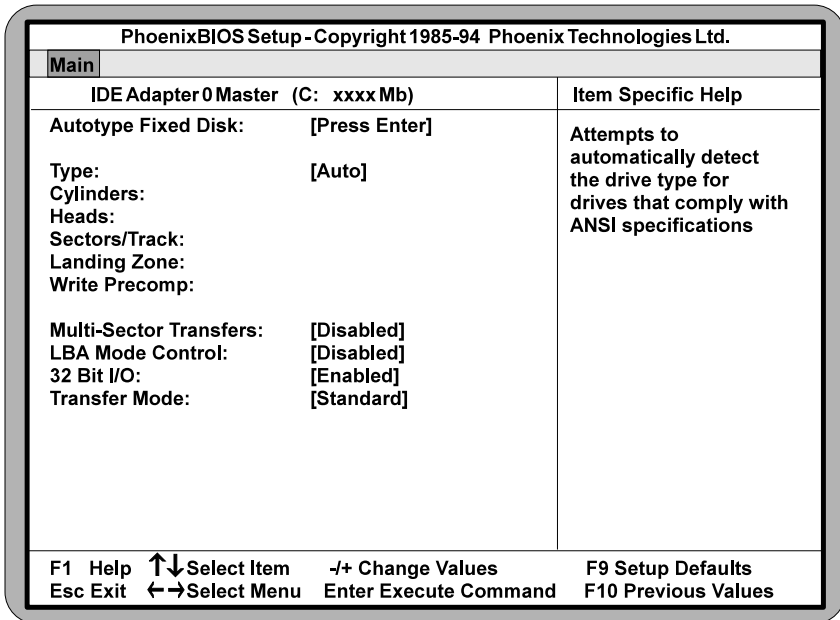

Figure 4-3 IDE Device Submenu

Autotype Fixed Disk

The easiest way to set your IDE devices is to let the BIOS do it for you. When the IDE Device submenu first appears, the Autotype Fixed Disk selection is highlighted. Simply press <Enter>, and the remaining information is entered automatically.

Do not adjust the rest of the settings unless absolutely necessary. The BIOS automatically enters the optimal settings.

Type

This category selects the drive type installed in the system. The options are 1-39, User, Auto or None.

Selecting 1 through 39 is not recommended.

If Autotype Fixed Disk does not find your drive's parameters, fill this information in manually under the User category. This information may be in the manual which came with your system. If not, contact your dealer or the hard drive manufacturer to fill in this category.

If you are using a SCSI hard drive, select None and refer to the documentation which came with the SCSI adapter.

Multiple-Sector Transfers

This category determines the number of sectors per block for multiple sector transfers. The options are Disabled (default), 2 Sectors, 4 Sectors, 8 Sectors, and 16 Sectors.

LBA Mode Control

Enable LBA (Logical Block Addressing) to support IDE drives larger than 528MB in size. The default setting is Disabled.

32-Bit I/O

This category allows the user to enable the 32-bit I/O function of the PCI IDE controller. Select Disabled if your drive will not run at this speed. The default setting is Enabled.

Transfer Mode

This category provides the transfer modes for the PCI IDE controller. The options are Fast PIO 4, Fast PIO 3, Fast PIO 2, Fast PIO 1, and Standard (default).

Fast PIO 4 is equivalent to Mode 4 supporting a minimum cycle time of 120ns (15.5 MB/sec.). Fast PIO 3 is equivalent to Mode 3 supporting a minimum cycle time of 180ns (11.1 MB/sec.). Fast PIO 2 supports a minimum cycle time of 240ns (8.33 MB/sec.). Fast PIO 1 supports a minimum cycle time of 383ns (5.22 MB/sec.). Standard supports a minimum cycle time of 600ns (3.3 MB/sec.).

See your drive specifications before setting this category.

Video System

This sets the type of video board installed into the system. You may choose VGA/SVGA (default), CGA 80x25, MONO, or Not Installed.

System Memory

The System Memory category identifies the size of the base memory. It cannot be changed.

Extended Memory

The Extended Memory category automatically detects the amount of memory installed above the amount in the System Memory category. Because the BIOS automatically calculates the amount of memory installed in your system, you cannot change this category without adding or removing memory.

Cache State

This category allows you to enable the external cache. For optimal performance, select Enabled.

Setting the Advanced Screen

To move to the Advanced Screen, use the left and right arrow keys <←/→> keys until you see the screen below (Figure 4-4).

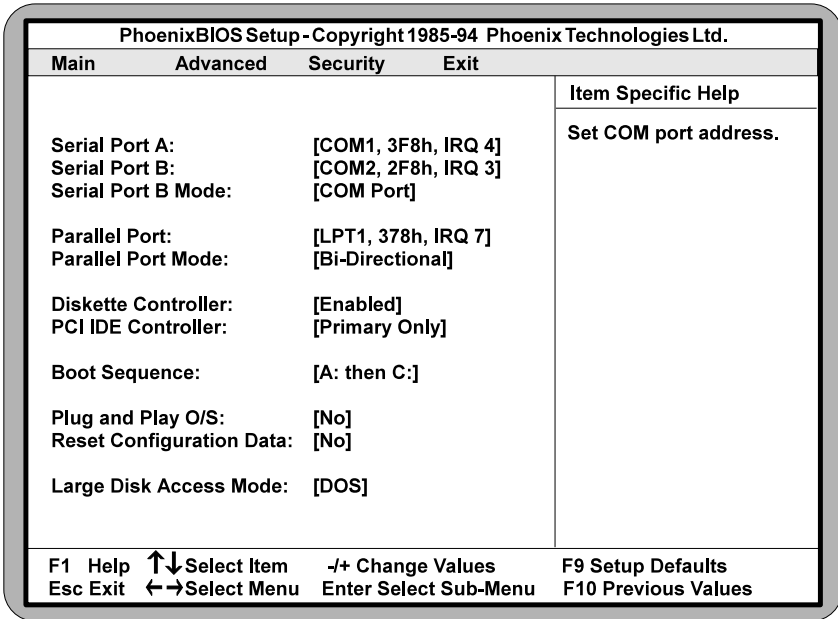

Figure 4-4 Advanced Screen

Serial Port A

Serial Port A may be set for Auto, COM1 (default), COM2, COM3, COM4, or Disabled. Auto will automatically provide a conflict free setting, but gives you less control over your configuration.

Serial Port B

Serial Port B may be set for Auto, COM1, COM2 (default), COM3, COM4, or Disabled. Auto will automatically provide a conflict free setting, but gives you less control over your configuration.

Serial Port B Mode

This category defines the function for Serial Port B. Serial Port B may be configured for COM Port (default), IrDA (infrared setting), or ASKIR (infrared setting).

Parallel Port

The parallel port may be set for LPT1 (default), LPT2, or may be disabled.

Parallel Port Mode

The parallel port may be set for output mode (AT) (default), bidirectional mode (PS/2), Enhanced Parallel Port (EPP), Extended Capabilities Port (ECP), or Disabled.

Diskette Controller

The floppy disk controller may be set for Enabled or Disabled.

IDE Controller

The IDE controller may be set for Primary Only (up to two hard disks), Primary and Secondary (up to four hard disks), or it may be disabled.

Boot Sequence

This category selects the order the system searches for a boot disk and may be set for A: then C:, C: then A:, or C: only.

Plug & Play O/S

This category, when set to Yes, allows the system to work with a Plug & Play operating system such as Windows 95. The default setting is No.

Reset Configuration Data

Select Yes to clear the PCI Plug & Play configuration data. The default setting is No.

Large Disk Access Mode

If you are using a DOS operating system (MS-DOS, DR-DOS, or PC-DOS), set this category to DOS (default). If you are using anything else, set it to OTHER.

Security Screen

The Security Screen (Figure 4-5) controls access to the computer. The security screen allows for settings of two passwords. The Supervisor Password allows access to the system and Setup. The User Password allows access to the system, but not to all Setup features.

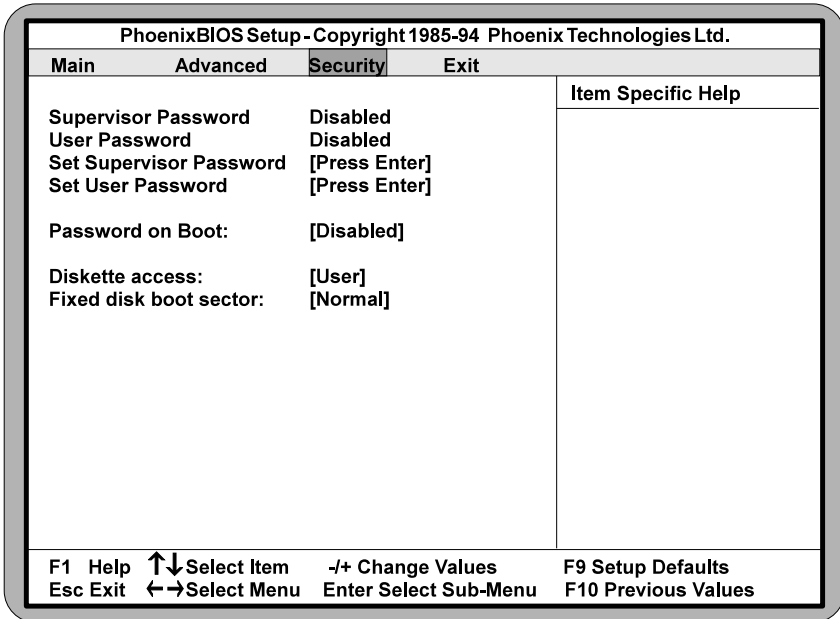

Figure 4-5 Security Setup Screen

Supervisor Password

If a Supervisor Password is set up for the system, it reads Enabled. If the password is not set up, it reads Disabled (default).

User Password

If a User Password is set up for the system, it reads Enabled. If the password is not set up, it reads Disabled (default).

Set Supervisor Password

Move the cursor to Set Supervisor Password and press the <Enter> key.

The Supervisor Password submenu will appear. Type the password and press the <Enter> key. Retype the password and press the <Enter> key again.

Write down the password somewhere safe so it will not be forgotten.

The password may be disabled by setting the new password to nothing (pressing the <Enter> key without first typing a password).

Warning:

If you forget the Supervisor Password, it cannot be disabled without discharging the CMOS.

Set User Password

Follow the same procedure used to set the Supervisor Password.

Note:

After a password is entered, it is saved immediately. All other changes may still be discarded (see Exit Screen).

Password on Boot

When enabled, the system requires a password upon boot. Either the Supervisor or User Password may be entered.

Diskette Access

This category allows floppy disk access with an option of the supervisor or user. Selecting Supervisor gives floppy disk access to the supervisor only. Selecting User (default) gives floppy disk access to both the user and the supervisor. If the passwords are enabled, this option may only be changed by the supervisor.

Fixed Disk Boot Sector

This category allows the boot sector of the fixed disk to be write protected. The default setting is Normal. When set for Write Protect, it serves as a form of virus protection. If the passwords are enabled, this option may only be changed by the supervisor.

Exit Screen

After you complete configuring the BIOS, select the Exit Screen (Figure 4-9).

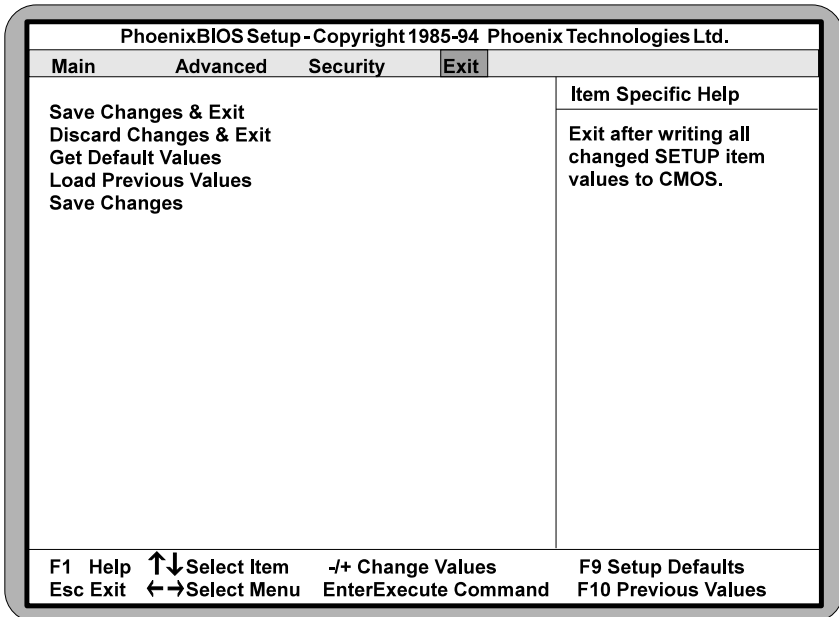

Figure 4-9 Exit Screen

Choose “Save Changes and Exit” and reboot the computer. The computer is ready for use.

A POST Messages

The following table lists the Power On Self Test (POST) messages, possible causes, and solutions.

Message	Possible Cause	Solution
DISKETTE DRIVE A FAILURE	Drive A failed or is missing.	Check Setup and cable connections.
DISKETTE DRIVE B FAILURE	Drive B failed or is missing.	Check Setup and cable connections.
EXTENDED RAM FAILED AT OFFSET: nnnn	Extended memory not working or configured properly.	Replace defective memory.
FAILING BITS: nnnn	Memory failure in System, Extended, or Shadow memory.	Replace defective memory.
FIXED DISK X FAILURE (where X =0 or 1)	The hard disk is not configured or working properly.	Rerun SETUP and check connections, or replace hard disk.
FIXED DISK CONTROLLER FAILURE	The controller card has failed.	Check configuration and connections, or replace controller card.
INCORRECT DRIVE A TYPE	Floppy drive A: not set correctly in Setup.	Run Setup.
INCORRECT DRIVE B TYPE	Floppy drive A: not set correctly in Setup.	Run Setup.
INVALID NVRAM MEDIA TYPE	NVRAM chip is bad.	Requires repair of system board.
KEYBOARD ERROR, or KEYBOARD CONTROLLER ERROR	The keyboard or keyboard controller failed.	Check connections. You may have to replace the keyboard or controller.
KEYBOARD ERROR nn	A key is jammed or was held down during boot.	Make sure the keys are not jammed or dirty.
KEYBOARD LOCKED	Keyswitch on the front of the case is locked.	Unlock the keyswitch.

Message	Possible Cause	Solution
MONITOR TYPE DOES NOT MATCH CMOS	Monitor type not correctly identified in Setup.	Run Setup and enter correct monitor type.
OPERATING SYSTEM NOT FOUND	Operating system cannot be located on Drive C: or Drive A:	Check Setup to see if Drive A: and C: are properly configured, or put a bootable disk in Drive A:
PARITY CHECK 1 nnnn	Parity error found in the system bus.	Check Setup. Board repair may be required.
PARITY CHECK 2 nnnn	Parity error found in the I/O bus.	Check Setup. Board repair may be required.
PREVIOUS BOOT INCOMPLETE - DEFAULT CONFIGURATION USED	Previous POST did not complete successfully.	Run Setup, load default BIOS settings, make any necessary adjustments, and save the changes
REAL TIME CLOCK ERROR	Real-time clock failed BIOS test.	May require battery replacement or board repair.
SHADOW RAM FAILED AT OFFSET	Shadow RAM failed.	May require repair of system board.
SYSTEM BATTERY IS DEAD	System battery died.	Replace the system battery and run Setup to reconfigure the system.
SYSTEM CACHE ERROR - CACHE DISABLED	External (L2) cache failed BIOS test.	System will still run, but slower. Replace cache at convenience.
SYSTEM CMOS CHECKSUM BAD - RUN SETUP	System CMOS has been corrupted or modified incorrectly.	Run Setup and reconfigure the system.
SYSTEM RAM FAILED AT OFFSET: nnnn	System RAM failed.	Replace defective RAM.
SYSTEM TIMER ERROR	Timer test failed.	Requires repair of system board.

B Beep and POST Codes

Beep codes are a series of beeps sent through the speaker which indicate a problem during the Power On Self Test (POST). If text appears on the video screen, the M6Pi has completed POST; any other tone from the speaker indicates something other than a POST error. These tones **are not** described in Table B-1.

The beep error codes are a series of beeps. The duration of the beep tones are constant, but the length of the pauses between the beeps varies. For example: a 1-3-3 beep code will sound like one beep, a pause; three beeps consecutively, another pause; and then three more beeps.

One beep code is often misunderstood. If a video card is not installed or is failing, the system board will generate a long-short-long-short beep code. This is often interpreted as a 1-2-1 beep code. But POST errors always vary in the length of the pause and not the duration of the beep tone.

Another way of identifying a POST error is to use a device called a POST card. This peripheral card is inserted into one of the ISA slots and has an LED (or LCD) read out showing the contents of port 80h.

The following table provides a list of all beep codes and POST routines..

Code	Beeps	POST Routine Description
02		Verify Real Mode.
04		Get CPU type.
06		Initialize system hardware.
08		Initialize chipset registers with initial POST values.
09		Get in POST Reg.
0A		Initialize CPU registers.
0C		Initialize cache initial POST values.
0E		Initialize I/O.
0F		Initialize the localbus IDE.
10		Initialize Power Management.
11		Load alternate registers with initial POST values.
12		Jump to UserPatch0.
14		Initialize keyboard controller.
16	2-2-3	BIOS ROM checksum.
18		8254 timer initialization.
1A		8237 DMA controller initialization.
1C		Reset Programmable Interrupt Controller.
20	3-1-1	Test DRAM refresh.
22	3-1-3	Test 8742 Keyboard Controller.
24		Set ES segment register to 4 GB.
28		Autosize DRAM.
2A		Clear 512K base RAM.
2C	3-4-1	Test 512K base address lines.
2E	3-4-3	Test 512K base memory.
32		Test CPU bus-clock frequency.
34		Test CMOS RAM.
35		Initialize alternate chipset registers.
37		Reinitialize the chipset (MB only).
38		Shadow system BIOS ROM.
39		Reinitialize the cache (MB only).
3A		Autosize cache.
3C		Configure advanced chipset registers.
3D		Load alternate registers with CMOS values.
40		Set initial CPU speed.
42		Initialize interrupt vectors.
44		Initialize BIOS interrupts.
46	2-1-2-3	Check ROM copyright notice.
47		Initialize manager for PCI Option ROMs.
48		Check video configuration against CMOS.
49		Initialize PCI bus and devices.

Code	Beeps	POST Routine Description
4A		Initialize all video adapters in system.
4C		Shadow video BIOS ROM.
4E		Display copyright notice.
50		Display CPU type and speed.
51		Initialize EISA board.
52		Test keyboard.
54		Set key click if enabled.
56		Enable keyboard.
58	2-2-3-1	Test for unexpected interrupts.
5A		Display prompt "Press F2 to enter SETUP".
5C		Test RAM between 512 and 640k.
60		Test extended memory.
62		Test extended memory address lines.
64		Jump to UserPatch1.
66		Configure advanced cache registers.
68		Enable external and CPU caches.
6A		Display external cache size.
6C		Display shadow message.
6E		Display non-disposable segments.
70		Display error messages.
72		Check for configuration errors.
74		Test real-time clock.
76		Check for keyboard errors.
7C		Set up hardware interrupt vectors.
7E		Test coprocessor if present.
80		Disable onboard I/O ports.
82		Detect and install external RS232 ports.
84		Detect and install external parallel ports.
86		Re-initialize on-board I/O ports.
88		Initialize BIOSData Area.
8A		Initialize Extended BIOS Data Area.
8C		Initialize floppy controller.
90		Initialize hard-disk controller.
91		Initialize localbus hard-disk controller.
92		Jump to UserPatch2.
93		Build MPTABLE for multi-processor boards.
94		Disable A20 address line.
96		Clear huge ES segment register.
98		Search for option ROMs.
9A		Shadow option ROMs.

Code	Beeps	POST Routine Description
9C		Set up Power Management.
9E		Enable hardware interrupts.
A0		Set time of day.
A2		Check key lock.
A4		Initialize typematic rate.
A8		Erase F2 prompt.
AA		Scan for F2 keystroke.
AC		Enter SETUP.
AE		Clear in-POST flag.
B0		Check for errors.
B2		POST done - prepare to boot operating system.
B4		One beep.
B6		Check password (optional).
B8		Clear global descriptor table.
BC		Clear parity checkers.
BE		Clear screen (optional).
BF		Check virus and backup reminders.
C0		Try to boot with INT 19.
D0		Interrupt handler error.
D2		Unknown interrupt error.
D4		Pending Interrupt.
D6		Initialize option ROM error.
D8		Shutdown error.
DA		Extended Block Move.
DC		Shutdown 10 error.
		The following are for boot block in Flash ROM:
E2		Initialize the chipset.
E3		Initialize refresh counter.
E4		Check for Forced Flash.
E5		Check HW status of ROM.
E6		BIOS ROM is OK.
E7		Do a complete RAM test.
E8		Do OEM initialization.
E9		Initialize interrupt controller.
EA		Read in the bootstrap code.
EB		Initialize all vectors.
EC		Boot the Flash program.
ED		Initialize the boot device.
EE		Boot code was read OK.

C Hard Disk Drive Types

The following table lists the hard disk types supported by M6Pi.

Type	Cylinders	Heads	Write Precomp	Sectors	Size
1	306	4	128	17	10
2	615	4	300	17	21
3	615	6	300	17	32
4	940	8	512	17	65
5	940	6	512	17	99
6	615	4	none	17	21
7	462	8	256	17	32
8	733	5	none	17	31
9	900	15	none	17	117
10	820	3	none	17	21
11	855	5	none	17	37
12	855	7	none	17	52
13	306	8	128	17	21
14	733	7	none	17	44
15	N/A	N/A	N/A	N/A	N/A
16	612	4	0	17	21
17	977	5	300	17	42
18	977	7	none	17	59
19	1024	7	512	17	62
20	733	5	300	17	31
21	733	7	300	17	94
22	733	5	300	17	31
23	306	4	0	17	10
24	612	4	305	17	21
25	612	2	300	17	10
26	614	4	none	17	21
27	820	6	none	17	42
28	977	5	none	17	42
29	1218	15	none	36	336
30	1224	15	none	17	159

Type	Cylinders	Heads	Write Precomp	Sectors	Size
31	823	10	512	17	71
32	809	6	128	17	42
33	830	7	none	17	50
34	830	10	none	17	72
35	1024	5	none	17	44
36	1024	8	none	17	71
37	615	8	128	17	42
38	1024	8	none	26	109
39	925	9	none	17	72

D Specifications

Processor	150MHz, 166MHz, 180MHz, or 200MHz Pentium Pro processor.
Chipset	Intel 82450 chipset. SMC 932/935 Super I/O chip.
CPU Clock Select	Frequency synthesizer chip. Jumper selectable CPU speed.
Form Factor	Baby AT footprint (8.5" x 13").
Expansion	Three ISA slots, two PCI slots, and one shared slot.
BIOS	Phoenix 4.05 Plug and Play BIOS on 1MB Flash EPROM. Mode 4 IDE drive support. Auto-detection of memory size. Auto-configuration of IDE hard disk drives.
RAM Capacity	8 MB to 512MB. Supports ECC (Error Correcting Code).
Keyboard	AT compatible (AT Version). PS/2 compatible (PS/2 Version).
Level 1 Cache	32K.
Level 2 Cache	256K.
I/O Ports	Built in support. Two high speed serial ports (16550 compatible). One bi-directional parallel port. Enhanced Parallel Port (EPP) compatible. Microsoft and Hewlett Packard Extended Capabilities Port (ECP) compatible.
Floppy Port	Supports two floppy drives (2.88, 1.44, 1.2, 720K, 360K).

PCI IDE Port Supports four IDE hard disks.
 Mode 4 support.
 Multiple sector transfer support.
 LBA support.

Environmental Specifications

The environment in which the M6Pi is located is critical. Micronics recommends the following environmental specifications:

Temperature Range

Operating: 50 to 104 degrees Fahrenheit (10 to 40 degrees Celsius).

Non -Operating: 50 to 140 degrees Fahrenheit (10 to 60 degrees Celsius).

Shipping: -22 to 140 degrees Fahrenheit (-30 to 60 degrees Celsius).

Relative Humidity

Operating: 20% to 80%.

Non-Operating: 5% to 90%.

Battery Disposal

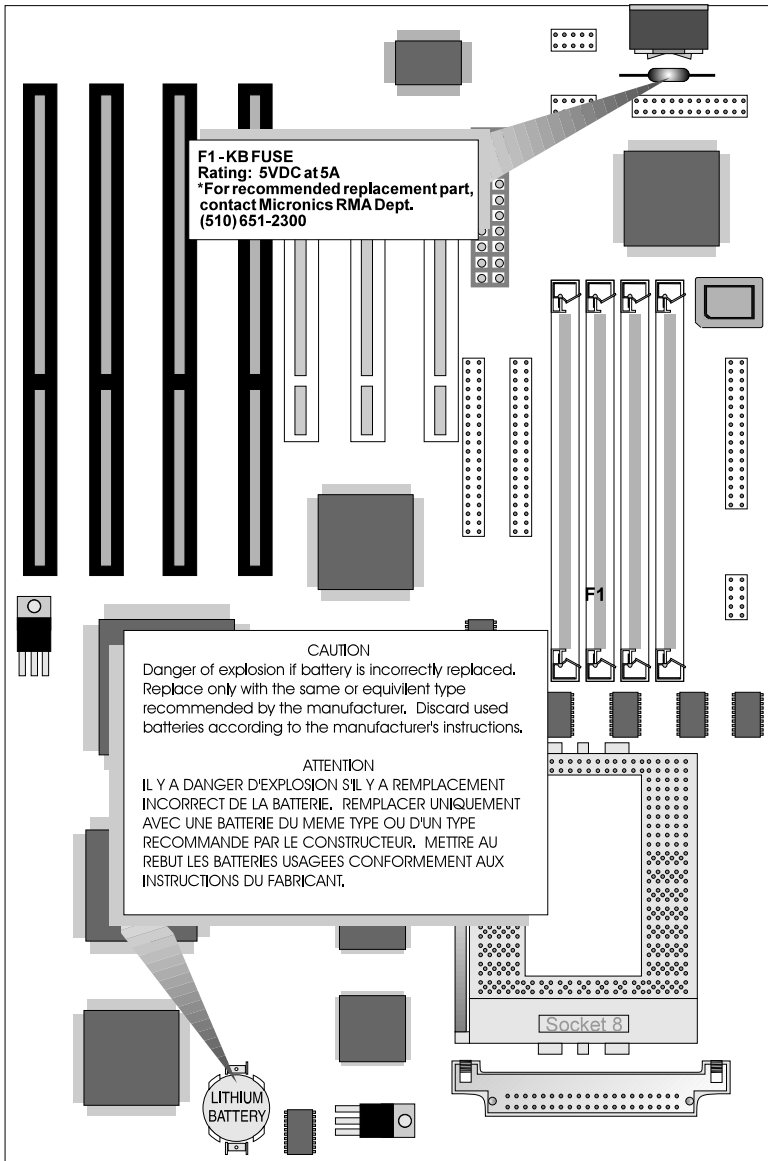





Warning:

DO NOT: open battery; dispose of in fire; recharge; put in backwards, mix with used or other battery types.

May explode or leak and cause personal injury.

FCC Warning Statement

This equipment has been tested and found to comply within the limits for a Class B digital device, pursuant to Part 15 of the FCC Rules. These limits are designed to provide reasonable protection against harmful interference in a residential installation. This equipment generates, uses and can radiate radio frequency energy and, if not used in accordance with the instructions, may cause harmful interference to radio communications. Interference to radio or television reception can be determined by turning the equipment off and on. The user is encouraged to try to correct the interference by one or more of the following measures:

-  Reorient the receiving antenna.
-  Increase the separation between the equipment and the receiver.
-  Connect the equipment into an outlet on a circuit different from that to which the receiver is connected.
-  Consult your dealer or an experienced radio/TV technician for help.

To meet FCC requirements, shielded cables are required.

Note:

Changes or modifications not expressly approved by Micronics could void the user's authority to operate the equipment.

Glossary

16550 UART - A high speed chip for controlling serial ports. Although unnecessary for a mouse, it is required for modems that are 14,400 baud or faster.

486DX - A type of 32-bit CPU with a built-in math-coprocessor and internal cache.

486DX2 - A 486DX CPU where the internal speed of the CPU operates at twice the external speed.

486DX4 - A 486DX CPU where the internal speed of the CPU operates at three times the external speed.

486SX - A 486DX CPU with no math-coprocessor.

Asynchronous - Operations that do not require the clocks of communicating devices to be coordinated. See *synchronous*.

Baby AT - A standard system board size measuring approximately 13.25" x 8.5".

Bidirectional Parallel Port - A type of parallel port that can send and receive information.

BIOS - An Acronym for Basic Input/Output System. Configures the system board and provides hardware information to the operating system.

Bit - A contraction of Binary digit. The smallest unit of information in a binary number system. A bit represents a choice between either zero or one.

Boot - To start up the computer and load the operating system software. See *cold boot* and *warm boot*.

Bus - A group of electronic paths used to send data between parts of the system. On a system board, the bus connects the peripheral cards with the microprocessor via the expansion slots.

Bus Mastering - The ability of an peripheral card to control the bus without requiring intervention of the CPU.

Byte - A group of adjacent *bits* treated as a unit. Eight bits are typically considered one byte. Also called a character.

Cache - A process where information is copied from the slower memory (DRAM) to the faster memory (SRAM). Information which is likely to be read or edited is stored in the cache providing significant performance increases.

Cache hit - The percentage of request for data from memory that can be served from the cache.

Cache miss - A memory access which cannot be supplied from cache.

Cold Boot - Starting the computer by turning on the power or pressing the RESET button. A cold boot makes the processor execute all of the diagnostics. See *boot* and *warm boot*.

CPU - An acronym for Central Processing Unit. A CPU performs arithmetic calculations, makes logical decisions, and directs the operation of the computer in conjunction with the operating system.

Disk Drive - A hardware device which provides for the storage of data on diskettes or hard metal disks that have a magnetic coating. A disk drive functions by spinning at high speed while moving a device called the read/write head across the disk's surface in order to read or write data in magnetic code.

DRAM - An acronym for Dynamic Random Access Memory. A type of memory chip that only keeps its memory if supplied with regular clock pulses and a chance to regularly refresh its data. It is slower and more cost effective than SRAM. See *SRAM*.

ECP - An acronym for Expanded Capabilities Port. A standard set by Hewlett Packard and Microsoft Corporation to expand the capabilities of the parallel port.

EDO Memory - An acronym for Extended Data Output. A type of DRAM with built-in cache.

EISA - An acronym for Extended Industry Standard Architecture. EISA is a bus design standard which is fully backward compatible with the ISA bus. Although it is a 32-bit bus, it only runs at 8MHz. See *PCI, VESA, and ISA*.

EPP - An acronym for Enhanced Parallel Port. A standard which increases the capabilities of the parallel port.

EPROM - Acronym for Erasable Programmable Read Only Memory. A type of ROM chip that can be programmed with relatively simple tools that will retain its data until erased. It can only be erased by exposing the circuitry in the chip to ultraviolet light. See also *Flash ROM*.

External Cache - Cache which is external to the CPU. See *Cache*.

Fast SCSI - A SCSI data transfer standard which supports a rate of up to 10MB/sec.

Fast Wide SCSI - A SCSI data transfer which supports a rate of up to 20MB/sec.

Flash ROM - A type of ROM chip that will retain its data until erased. It can be erased or reprogrammed by supplying it with +12V of voltage. See *ROM* and *EPROM*.

Full Size - A standard system board size measuring approximately 12" x 13.75".

Gigabyte - A disk storage capacity measurement. Approximately one thousand megabytes or 1,073,741,824 bytes.

IDE - An acronym for Integrated Device Electronics. A standard for communicating between a hard drive and a computer.

Internal Cache - Cache which is built into the CPU. See *Cache*.

ISA - An acronym for Industry Standard Architecture. A well-established bus standard originating with the IBM AT. See *PCI, VESA, and EISA*.

Jumper - a small plug that fits over and shorts pins on a circuit board. Jumpers allow the various functions of the board to be enabled or disabled.

Kilobyte (KB) - 1,024 bytes.

L1 Cache - See *Internal Cache*.

L2 Cache - See *External Cache*.

LBA - An acronym for Logical Block Addressing. Any IDE hard drive larger than 528MB.

Math coprocessor - A microprocessor designed specifically for performing mathematical calculations. A math coprocessor performs these calculations faster than the CPU, and by doing so, frees the CPU for other activities.

Megabyte (MB) - 1,024 Kilobytes or 1,048,576 bytes.

Mini AT - A standard system board size measuring approximately 8.5" x 9.5".

Mode 1 - An IDE data transfer standard which supports transfer rates of up to 5.22 Mbytes/sec.

Mode 2 - An IDE data transfer standard which supports transfer rates of up to 8.33 Mbytes/sec.

Mode 3 - An IDE data transfer standard which supports transfer rates of up to 11.1 Mbytes/sec.

Mode 4 - An IDE data transfer standard which supports transfer rates of up to 15.5 Mbytes/sec.

Parallel - A form of data transmission in which the data is sent one byte at a time over several wires that each carry one byte. In parallel transmission, all the bytes arrive simultaneously, as opposed to serial transmission in which bits arrive one by one.

Parallel Port - A connection for a printer or similar peripheral. Generally, parallel ports are output only. See *Bidirectional Parallel Port* and *ECP*.

PCI - An acronym for Peripheral Component Interconnect. A high performance 32-bit or 64-bit bus developed by Intel Corporation. PCI is designed to be independent of the hardware architecture to ensure compatibility with future computer systems. See *VESA, EISA, and ISA*.

Pentium - A high performance 64-bit CISC processor designed and manufactured by Intel Corporation. As of this writing, Pentium is the highest performing X86 processor available.

Plug and Play - A standard developed to ensure easy installation of peripherals. Theoretically, a newly installed card automatically configures itself and works properly without requiring jumper configuration or device drivers.

POST - An acronym for Power On Self Test. A diagnostic program which is run whenever the system is cold booted.

RAM - An acronym for Random Access Memory. A type of memory used as the "working memory" of a computer system. See *DRAM* and *SRAM*.

ROM - An acronym for Read Only Memory. A type of memory that retains its data without requiring power. Once written, it cannot be modified. See *EPROM* and *Flash ROM*.

SCSI - An acronym for Small Computer Systems Interface. An interface standard used to interface hard disk drives, removable cartridge drives, tape drives, and CD-ROMs to the computer system. SCSI allows multiple, high-performance peripheral devices to be connected in a chain. Each has its own address. Data and control signals are sent along the chain and only the specifically addressed device responds.

SCSI II - An interface standard that adds features to the SCSI standard. These include 32-bit data transfer, command queuing, Fast SCSI, and support for a wider variety of peripherals.

SCSI III - A proposed standard which supports transfer rates of up to 40MB/sec.

Serial - A type of data transmission in which the data is sent one bit at a time over a single wire. See *parallel*.

Serial Port - A communications port used to connect peripherals such as modems and mice.

Setup - A program which allows you to make changes to the system configuration.

Shadow RAM - A technique used to load a duplicate copy of BIOS from slower ROM into faster RAM. This enhances system performance providing higher access speed to the BIOS.

SIMM - An acronym for Standard Inline Memory Module. A small printed circuit board containing memory chips.

SRAM - An acronym for Static Random Access Memory. A type of memory that can retain data without requiring a regular clock signal. Although they are faster than DRAM, they hold less data and are more expensive.

Synchronous - Protocols that require the clocks of communicating machines or devices to be coordinated.

Synchronous Cache - A type of cache that uses a clock signal to latch the inputs and the data output. This structure spreads the cache access across two or three cycles while maintaining a bandwidth of one access per cycle. Improves performance by 5-10%.

Terabyte - A measurement for very, very large storage capacity. One Terabyte is equivalent one-thousand gigabytes, one-million megabytes, or 1,099,511,627,766 bytes.

VESA - An acronym for Video Electronics and Standards Association.

VESA Localbus (VL-Bus) - A high performance bus designed by VESA. A 32-bit version of the ISA bus which operates at the speed of the computer's CPU. See *PCI*, *EISA*, and *ISA*.

VGA - An acronym for Video Graphics Array. A standard for monitor displays.

VR - Pentium CPU voltage ranging from 3.300 - 3.465 Volts.

VRE - Pentium CPU voltage ranging from 3.400 - 3.600 Volts.

Warm Boot - Restarting the system by simultaneously pressing the <Ctrl>, <Alt>, and <Delete> keys.

Write-Back Cache - Upon a cache hit, the cache is updated and the main memory is not affected. Upon a cache miss, only the main memory is updated.

Write-Through Cache - Upon a cache hit, the cache and the main memory are updated. Upon a cache miss, only the main memory is updated.

Limited Warranty

Except as described below, Micronics warrants the products to be free from defects in material and workmanship in normal use for a period of one (1) year from date of purchase. Should any product fail to perform according to this warranty at any time during the warranty period, except as provided below, Micronics or its authorized service centers will, at Micronics' option, repair or replace the product at no additional charge.

The warranty does not cover loss or damage which occurs in shipment or which is due to: (1) improper installation or maintenance, misuse, neglect or any cause other than ordinary commercial application, including without limitation, accidents or acts of God; (2) adjustment, repair, or modification by other than a Micronics authorized service center; (3) improper environment, excessive or inadequate heating or air conditioning, or electrical power failures, surges or other irregularities; (4) any statement about the product other than those set forth in this warranty; or (5) nonconformity to models or samples shown to the purchaser. Any models or samples were for the sole purpose of suggesting the character of the product and are not intended to form the basis of the bargain.

A receipt or copy of the invoice with the date of purchase from a Micronics reseller is required before any warranty service can be rendered. Service can be obtained by calling Micronics for a Return Merchandise Authorization (RMA) Number.

The RMA Number should be prominently displayed on the outside of the shipping carton of the returned product. Returned product should be shipped prepaid or hand carried to Micronics. The purchaser assumes risk of loss or damage in transit, and unless otherwise agreed to in writing by Micronics, will pay inbound shipping charges.

The exclusive remedy of the purchaser under this warranty above will be repair or replace at Micronics' option, but if for any reason that remedy should fail of its essential purpose, the exclusive remedy of the purchaser shall then be actual damages up to amounts paid for the defective product by the purchaser. This limited warranty shall be deemed to "fail of its essential purpose" if, after repeated efforts, Micronics is unable to make the product operate as warranted. Micronics' liability for damages to the purchaser for any cause whatsoever; regardless of the form of action and whether in contract or in tort, shall be limited to the purchase price in effect when the cause of action arose for the product that is the basis of the claim.

Micronics will not be liable for any lost profits or any indirect, special incidental or consequential damages in connection with the product, even if Micronics has been advised of the possibility of such damages.

Micronics makes no warranties or representations as to performance of products or as to service to distributor or to any person, except as set forth in Micronics; limited warranty accompanying delivery of product.

Micronics disclaims all other warranties whether oral, written, expressed, or implied, including without limitation, the warranties of design, merchantability, or fitness for a particular purpose, if applicable, or arising from a course of dealing, usage or trade practice.

Non-Warranty Service

After the one year warranty service is no longer in effect, repair service is still available for Micronics products. For more information, contact Micronics' RMA department at (510) 683-0428 or (510) 683-0389. The RMA department is open between 8:30 A.M. and 5 P.M. Pacific Standard Time.