

## FCC Compliance Statement:

<p style="text-align: center;"><b>DECLARATION OF CONFORMITY</b> Per FCC Part 2 Section 2.107(a)</p> <p style="text-align: center;"><b>FC</b></p> <p>Responsible Party Name: G.B.T. INC.</p> <p style="text-align: center;">Address: 18365 Valley Blvd., Suite#A LA Puente, CA 91744</p> <p style="text-align: center;">Phone/Fax No: (818) 854-9338 / (818) 854-9339</p> <p>hereby declares that the product</p> <p style="text-align: center;">Product Name: Mother Board</p> <p style="text-align: center;">Model Number: GA-7ZXR</p> <p>Conforms to the following specifications:</p> <p style="text-align: center;">FCC Part 15, Subpart B, Section 15.107(a) and Section 15.109(a), Class B Digital Device.</p> <p><b>Supplementary Information:</b></p> <p style="text-align: center;"><small>This device complies with part 15 of the FCC Rules. Operation is subject to the following two conditions: (1) This device may not cause harmful and (2) this device must accept any interference received, including that may cause undesired operation.</small></p> <p>Representative Person's Name: <u>ERIC LU</u></p> <p>Signature: <u>Eric Lu</u></p> <p>Date: <u>Feb. 09, 2001</u></p>
---

This equipment has been tested and found to comply with limits for a Class B digital device, pursuant to Part 15 of the FCC rules. These limits are designed to provide reasonable protection against harmful interference in residential installations. This equipment generates, uses, and can radiate radio frequency energy, and if not installed and used in accordance with the instructions, may cause harmful interference to radio communications. However, there is no guarantee that interference will not occur in a particular installation. If this equipment does cause interference to radio or television equipment reception, which can be

determined by turning the equipment off and on, the user is encouraged to try to correct the interference by one or more of the following measures:

- Reorient or relocate the receiving antenna
- Move the equipment away from the receiver
- Plug the equipment into an outlet on a circuit different from that to which the receiver is connected
- Consult the dealer or an experienced radio/television technician for additional suggestions

You are cautioned that any change or modifications to the equipment not expressly approve by the party responsible for compliance could void Your authority to operate such equipment.

This device complies with Part 15 of the FCC Rules. Operation is subjected to the following two conditions 1) this device may not cause harmful interference and 2) this device must accept any interference received, including interference that may cause undesired operation.

# Declaration of Conformity

We, Manufacturer/Importer  
(full address)

**G.B.T. Technology Trading GmbH**  
**Ausschlagler Weg 41, 1F, 20537 Hamburg, Germany**

declare that the product  
( description of the apparatus, system, installation to which it refers)

**Mother Board**  
GA-7ZXR

is in conformity with  
(reference to the specification under which conformity is declared)  
in accordance with 89/336 EEC-EMC Directive

- |   |  |  |   |
|---|--|--|---|
| <input type="checkbox"/> EN 55011   | Limits and methods of measurement of radio disturbance characteristics of industrial, scientific and medical (ISM high frequency equipment                 | <input type="checkbox"/> EN 61000-3-2*           | Disturbances in supply systems caused by household appliances and similar electrical equipment "Harmonics"            |
| <input type="checkbox"/> EN55013  | Limits and methods of measurement of radio disturbance characteristics of broadcast receivers and associated equipment                                     | <input checked="" type="checkbox"/> EN60555-2    |   |
| <input type="checkbox"/> EN 55014   | Limits and methods of measurement of radio disturbance characteristics of household electrical appliances, portable tools and similar electrical apparatus | <input checked="" type="checkbox"/> EN61000-3-3* | Disturbances in supply systems caused by household appliances and similar electrical equipment "Voltage fluctuations" |
| <input type="checkbox"/> EN 55015   | Limits and methods of measurement of radio disturbance characteristics of fluorescent lamps and luminaries   | <input checked="" type="checkbox"/> EN 50081-1   | Generic emission standard Part 1: Residual, commercial and light industry   |
| <input type="checkbox"/> EN 55020   | Immunity from radio interference of broadcast receivers and associated equipment   | <input checked="" type="checkbox"/> EN 50082-1   | Generic immunity standard Part 1: Residual, commercial and light industry   |
| <input checked="" type="checkbox"/> EN 55022  | Limits and methods of measurement of radio disturbance characteristics of information technology equipment   | <input type="checkbox"/> EN 55081-2              | Generic emission standard Part 2: Industrial environment  |
| <input type="checkbox"/> DIN VDE 0855<br><input type="checkbox"/> part 10<br><input type="checkbox"/> part 12 | Cabled distribution systems; Equipment for receiving and/or distribution from sound and television signals   | <input type="checkbox"/> EN 55082-2              | Generic immunity standard Part 2: Industrial environment  |
| <input checked="" type="checkbox"/> CE marking  |  | <input type="checkbox"/> ENV 55104               | Immunity requirements for household appliances tools and similar apparatus  |
|   |  | <input type="checkbox"/> EN 50091- 2             | EMC requirements for uninterruptible power systems (UPS)  |



(EC conformity marking)

**The manufacturer also declares the conformity of above mentioned product with the actual required safety standards in accordance with LVD 73/23 EEC**

- |                                   |   |                                     |   |
|-----------------------------------|---|-------------------------------------|---|
| <input type="checkbox"/> EN 60065 | Safety requirements for mains operated electronic and related apparatus for household and similar general use | <input type="checkbox"/> EN 60950   | Safety for information technology equipment including electrical business equipment |
| <input type="checkbox"/> EN 60335 | Safety of household and similar electrical appliances   | <input type="checkbox"/> EN 50091-1 | General and Safety requirements for uninterruptible power systems (UPS)             |

Manufacturer/Importer

Signature : Rex Lin  
Name : Rex Lin

(Stamp)

Date : Feb. 09, 2001

**7ZXR Series**  
**AMD Athlon™/Duron™ Socket A Motherboard**

**USER'S MANUAL**

AMD Athlon™/Duron™ Socket A Processor Motherboard  
REV. 2.3 First Edition  
R-23-01-010430



## How This Manual Is Organized

This manual is divided into the following sections:

<b>1) Revision History</b>	Manual revision information
<b>2) Item Checklist</b>	Product item list
<b>3) Features</b>	Product information & specification
<b>4) Hardware Setup</b>	Instructions on setting up the motherboard
<b>5) Performance &amp; Block Diagram</b>	Product performance & block diagram
<b>6) Suspend to RAM &amp; Dual BIOS</b>	Instructions on STR installation & Dual BIOS
<b>7) Four Speaker &amp; SPDIF</b>	Four Speaker & SPDIF introduction
<b>8) @BIOS &amp; Easy Tune///™</b>	Instructions on @BIOS & Easy Tune///™
<b>9) RAID</b>	Instructions on RAID
<b>10) BIOS Setup</b>	Instructions on setting up the BIOS software
<b>11) Appendix</b>	General reference



## Table Of Content

Revision History	P.1
Item Checklist	P.2
Summary of Features	P.3
7ZXr Series Motherboard Layout	P.5
Page Index for CPU Speed Setup / Connectors / Panel and Jumper Definition	P.6
Performance List	P.25
Block Diagram	P.26
Suspend to RAM Installation	P.27
Dual BIOS Introduction	P.33
Four Speaker & SPDIF Introduction	P.40
@BIOS Introduction	P.46
Easy Tune///™ Introduction	P.48
RAID Introduction	P.49
Memory Installation	P.72
Page Index for BIOS Setup	P.73
Appendix	P.103

## Revision History

Revision	Revision Note	Date
2.1	Initial release of the 7ZXR Series motherboard user's manual.	Dec. 2000
2.2	Initial release of the 7ZXR Series motherboard user's manual.	Jan. 2001
2.2	Second release of the 7ZXR Series motherboard user's manual.	Feb. 2001
2.3	Initial release of the 7ZXR Series motherboard user's manual.	Apr. 2001

The author assumes no responsibility for any errors or omissions that may appear in this document nor does the author make a commitment to update the information contained herein. Third-party brands and names are the property of their respective owners.



---

## Item Checklist

- The 7ZXR Series motherboard
- Cable for IDE / floppy device
- Diskettes or CD (TUCD) for motherboard driver & utility
- 7ZXR Series user's manual

## Summary Of Features

Form Factor	<ul style="list-style-type: none"> <li>• 30.5 cm x 24.4 cm ATX size form factor, 4 layers PCB.</li> </ul>
Motherboard	<ul style="list-style-type: none"> <li>• 7ZXR Series includes 7ZXR , 7ZXR-C</li> </ul>
CPU	<ul style="list-style-type: none"> <li>• AMD Athlon (K7) Socket A Processor</li> <li>• 256K/64K L2 cache on die</li> <li>• Supports 500MHz ~ 1GHZ</li> </ul>
Chipset	<p>Apollo KT133A ,consisting of:</p> <ul style="list-style-type: none"> <li>• VT8363A Memory/AGP/PCI Controller(PAC)</li> <li>• VT82C686B PCI Super-I/O Integrated Peripheral Controller (PSIPC)</li> </ul>
Clock Generator	<ul style="list-style-type: none"> <li>• ICS94236AF</li> </ul> <p>95 / 100 / 102 / 105 / 110 / 113 / 115 / 120 / 133 / 135 / 137 / 139 / 141 / 143 / 145 / 150 MHz system bus speeds</p>
Memory	<ul style="list-style-type: none"> <li>• 3 168-pin DIMM sockets</li> <li>• Supports PC-100 / PC-133 SDRAM and VCM SDRAM</li> <li>• Supports up to 1.5GB DRAM</li> <li>• Supports 3.3V / 3.4V / 3.5V SDRAM DIMM</li> </ul>
I/O Control	<ul style="list-style-type: none"> <li>• VT82C686B</li> </ul>
Slots	<ul style="list-style-type: none"> <li>• 1 AGP slot supports 4X mode 1.5V ,1.6V ,1.7V &amp; AGP 2.0 compliant</li> <li>• 6 PCI slots support 33MHz &amp; PCI 2.2 compliant</li> <li>• 1 AMR(Audio Modem Riser) slot</li> </ul>
On-Board IDE	<ul style="list-style-type: none"> <li>• IDE 1and IDE 2 Supports UDMA 33 / ATA 66/ATA100 IDE &amp; ATAPI CD-ROM</li> <li>• IDE 3 and IDE 4 Compatible with RAID, Ultra ATA/100, Ultra ATA/66, Ultra ATA/33, EIDE (Optional)</li> <li>• 4 IDE bus master IDE ports for up to 8 ATAPI devices</li> </ul>
On-Board Peripherals	<ul style="list-style-type: none"> <li>• 1 floppy port supports 2 FDD with 360K, 720K,1.2M, 1.44M and 2.88M bytes</li> <li>• 1 parallel ports supports Normal/EPP/ECP mode</li> <li>• 2 serial ports (COM A and COM B)</li> <li>• 4 USB ports</li> <li>• 1 IrDA connector for IR</li> </ul>
Hardware Monitor	<ul style="list-style-type: none"> <li>• CPU/System fan revolution detect</li> <li>• CPU/System temperature detect</li> <li>• System voltage detect</li> </ul>

To be continued...

PS/2 Connector	<ul style="list-style-type: none"> <li>• PS/2<sup>®</sup> Keyboard interface and PS/2<sup>®</sup> Mouse interface</li> </ul>
On-Board Sound	<ul style="list-style-type: none"> <li>• Creative CT5880 sound</li> <li>• AC'97 CODEC</li> <li>• Line In/Line Out/Mic In/AUX In/CD In/TEL/Game Port /Four Speaker &amp; SPDIF</li> </ul>
On-Board RAID (Optional)	<ul style="list-style-type: none"> <li>• Support data striping (RAID 0) or mirroring (RAID 1) .</li> <li>• Supports concurrent dual IDE controller operation.</li> <li>• Supports IDE bus master operation.</li> <li>• Displays status and error checking messages during boot-up.</li> <li>• Mirroring supports automatic background rebuilds</li> <li>• Features LBA and Extended Interrupt13 drive translation in controller onboard BIOS.</li> </ul>
BIOS	<ul style="list-style-type: none"> <li>• Licensed AMI BIOS, 2M bit flash ROM</li> <li>• Support Dual BIOS</li> </ul>
Additional Features	<ul style="list-style-type: none"> <li>• Support Wake-On-LAN (WOL)</li> <li>• Support Internal / External Modem Ring On</li> <li>• Support USB KB/MS Wake up from S3</li> <li>• Includes 3 fan power connectors</li> <li>• Poly fuse for keyboard over-current protection</li> <li>• Support STR (Suspend-To-RAM) function</li> </ul>

# 7ZXR Series Motherboard Layout

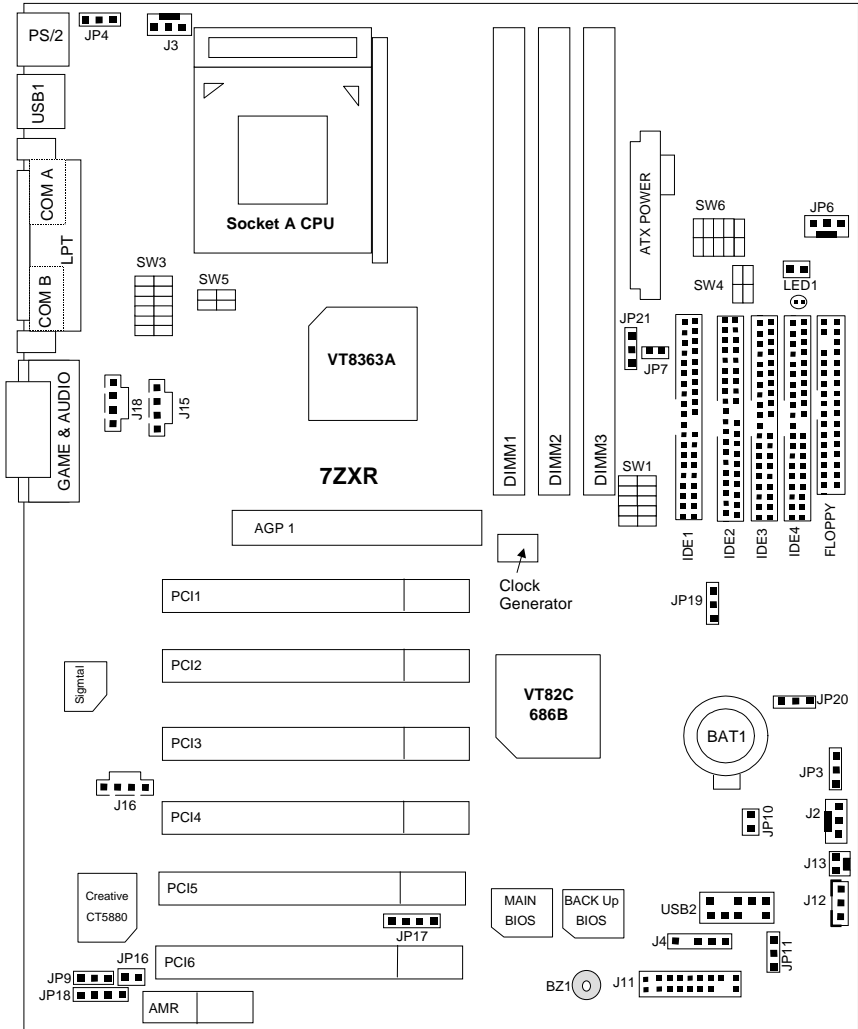

 Page Index for CPU Speed Setup/Connectors/Panel and Jumper Definition	Page
CPU Speed Setup	P.7
Connectors	P.10
ATX Power	P.10
COM A / COM B / LPT Port	P.10
Floppy Port	P.11
Game & Audio Port	P.11
IDE 1/IDE2 (Primary/Secondary), IDE3/IDE4(Promise RAID/ATA100) Port	P.12
J2 (System Fan)	P.12
J3 (CPU Fan)	P.13
J4 (IR)	P.13
J12 (Wake On LAN)	P.14
J13 (Ring Power On)	P.14
J15 (AUX_IN)	P.15
J16 (TEL)	P.15
J18 (CD Audio Line In)	P.16
JP6 (Power Fan)	P.16
JP8 / LED1 (STR LED Connector & DIMM LED)	P.17
PS/2 Keyboard & PS/2 Mouse Connector	P.17
USB 1 Connector	P.18
USB 2 Connector	P.18
Panel and Jumper Definition	P.19
J11 (2x11 Pins Jumper)	P.19
JP3 (Clear CMOS Function)[Optional]	P.20
JP4 (Rear USB Device Wake Up Selection)	P.20
JP7 (STR Function Enabled)	P.21
JP9 (Onboard Sound Function Selection)	P.21
JP10 (BIOS Write Protection)[Optional]	P.22
JP11 (Front USB Device Wake Up Selection)	P.22
JP16/JP17/JP18 (AMR Select)	P.23
JP19 (Onboard Promise select) [Optional]	P.23
JP20 (RAID/ATA100 Select) [Optional]	P.24
BAT1 (Battery)	P.24

## CPU Speed Setup

There are 2 ways to set system bus speed. To set system bus speed by BIOS, please refer to P. 95. To set system bus speed by DIP switch (**SW1** and **JP21**). Please refer to table below.

### Set System Bus Speed

SW1: (CPU Freq.)

O : ON, X : OFF

CPU CLK	PCI CLK	1	2	3	4	5
95.00	31.67	O	O	O	O	O
100.00	33.33	O	O	X	O	O
102.00	34.00	O	O	O	X	O
105.00	35.00	O	O	X	X	O
110.00	36.67	X	O	O	O	O
113.00	37.67	X	O	X	O	O
115.00	38.33	X	O	O	X	O
120.00	40.00	X	O	X	X	O
133.33	33.33	O	X	O	O	O
135.00	33.75	O	X	X	O	O
137.00	34.25	O	X	O	X	O
139.00	34.75	O	X	X	X	O
141.00	35.25	X	X	O	O	O
143.00	35.75	X	X	X	O	O
145.00	36.25	X	X	O	X	O
150.00	37.50	X	X	X	X	O
100.90	33.63	O	O	O	O	X
100.00	33.33	O	O	X	O	X
103.00	34.33	O	O	O	X	X
107.00	35.67	O	O	X	X	X
117.00	39.00	X	O	O	O	X
120.00	30.00	X	O	X	O	X
123.00	30.75	X	O	O	X	X
125.00	31.25	X	O	X	X	X
133.33	33.33	O	X	O	O	X
133.90	33.48	O	X	X	O	X
147.00	36.75	O	X	O	X	X
151.00	37.75	O	X	X	X	X
153.00	38.25	X	X	O	O	X
155.00	38.75	X	X	X	O	X
160.00	40.00	X	X	O	X	X
200.00	50.00	X	X	X	X	X

★ The FSB Speed of the VIA KT133A is 100MHz or 133MHz.

Pin No.	Definition
1-2 close	CPU Clock Frequency 133MHz
2-3 close	CPU Clock Frequency 100MHz (Default)

The CPU speed must match with the frequency ratio. It will cause system hanging up if the frequency ratio is higher than that of CPU.

● AMD CPU Heat Sink Installation:

Beware: Please check that the heat sink is in good contact with the CPU before you turn on your system.

The poor contact will cause over heat, and might cause damage to your processor.

SW3: (CPU Over Voltage Tage)

O : ON, X : OFF

FSB	1	2	3	4	5	6
Auto	X	X	X	X	X	X
1.5V	0	X	X	X	0	0
1.525V	X	0	X	X	0	0
1.55V	0	0	X	X	0	0
1.575V	X	X	0	X	0	0
1.6V	0	X	0	X	0	0
1.625V	X	0	0	X	0	0
1.65V	0	0	0	X	0	0
1.675V	X	X	X	0	0	0
1.7V	0	X	X	0	0	0
1.725V	X	0	X	0	0	0
1.75V	0	0	X	0	0	0
1.775V	X	X	0	0	0	0
1.8V	0	X	0	0	0	0
1.825V	X	0	0	0	0	0
1.85V	0	0	0	0	0	0

7ZXR Series Motherboard

SW4: (Memory Over Voltage )

FSB	1	2
3.3V	ON	ON
3.4V	OFF	ON
3.5V	OFF	OFF

SW5: (AGP Over Voltage )

FSB	1	2
1.5V	ON	ON
1.6V	OFF	ON
1.7V	OFF	OFF

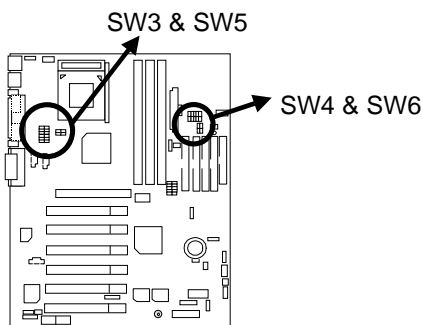

SW6: (CPU Ratio )

O : ON, X : OFF

FSB	1	2	3	4	5
Auto	X	X	X	X	O
5X	O	O	X	O	X
5.5X	X	O	X	O	X
6X	O	X	X	O	X
6.5X	X	X	X	O	X
7X	O	O	O	X	X
7.5X	X	O	O	X	X
8X	O	X	O	X	X
8.5X	X	X	O	X	X
9X	O	O	X	X	X
9.5X	X	O	X	X	X
10X	O	X	X	X	X
10.5X	X	X	X	X	X
11X	O	O	O	O	X
11.5X	X	O	O	O	X
12X	O	X	O	O	X
12.5X	X	X	O	O	X

●\*Note: Please set the CPU host frequency in accordance with your processor's specifications. We don't recommend you to set the system bus frequency over the CPU's specification because these specific bus frequencies are not the standard specifications for CPU, chipset and most of the peripherals. Whether your system can run under these specific bus frequencies properly will depend on your hardware configurations, including CPU, Chipsets, SDRAM, Cards....etc.



## Connectors

### ATX Power

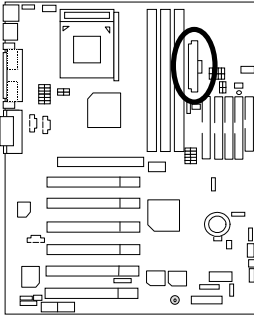

Pin No.	Definition
3,5,7,13, 15-17	GND
1,2,11	3.3V
4,6,19,20	VCC
10	+12V
12	-12V
18	-5V
8	Power Good
9	5V SB(stand by+5V)
14	PS-ON(Soft On/Off)

### COM A / COM B / LPT Port

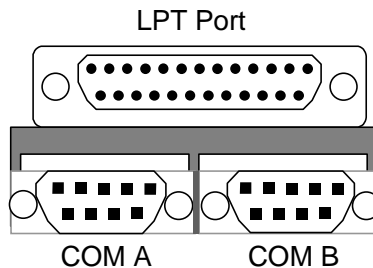
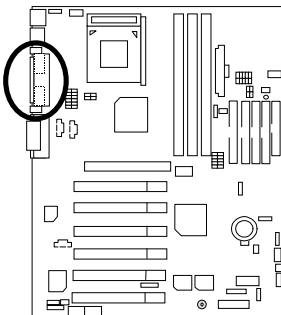

## Floppy Port

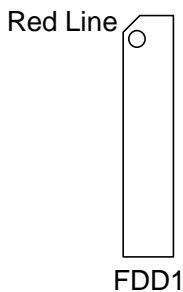
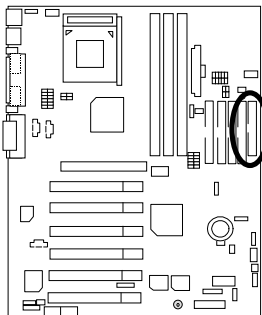

## Game & Audio Port

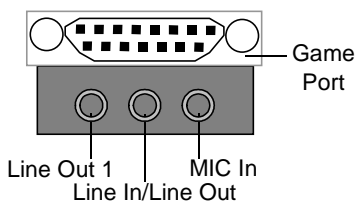
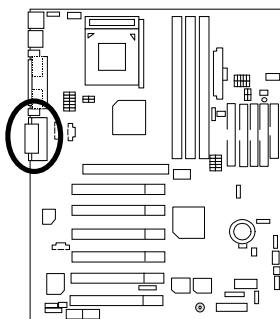

Line Out 1: Line Out or SPDIF (The SPDIF output is capable of providing digital audio to external speakers or compressed AC3 data to an external Dolby digital decoder). To enable SPDIF, simply insert SPDIF connector into Line Out1. Line Out1 will become SPDIF Out automatically. (see page 43 for more information).

To enable Four Speaker (for Creative 5880 audio only), simply follow instructions on page 40 and Line In will become Line Out2 to support second pair of stereo speakers.

IDE1,IDE2 (Primary/Secondary),  
IDE3/IDE4(RAID/ATA100) Port(Optional)

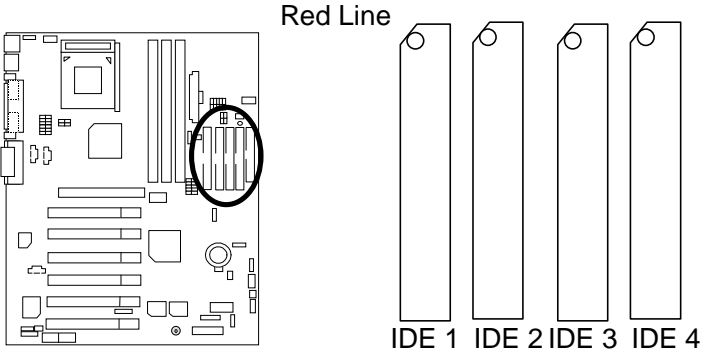

J2 : System Fan

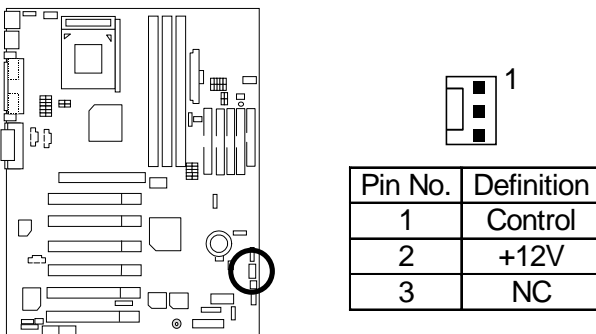

### J3 : CPU Fan

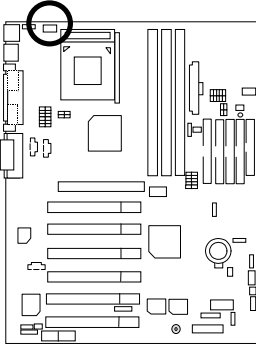

Pin No.	Definition
1	Control
2	+12V
3	SENSE

### J4 : IR

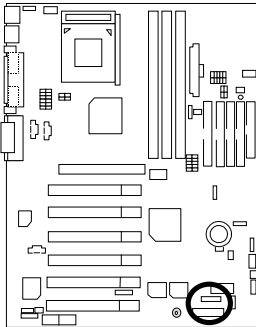

Pin No.	Definition
1	VCC (+5V)
2	NC
3	IR Data Input
4	GND
5	IR Data Output

## J12 : Wake On LAN

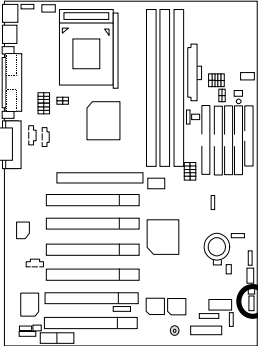

Pin No.	Definition
1	+5V SB
2	GND
3	Signal

## J13 : Ring Power On (Internal Modem Card Wake Up)

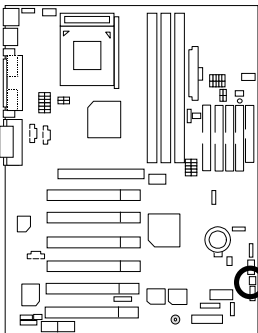

Pin No.	Definition
1	Signal
2	GND

### J15 : AUX\_IN

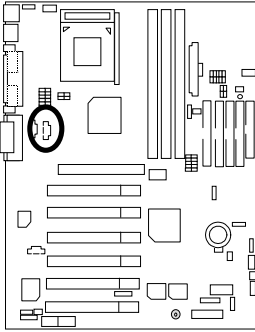

Pin No.	Definition
1	AUX-L
2	GND
3	GND
4	AUX-R

### J16 TEL : The connector is for Modem with internal voice connector

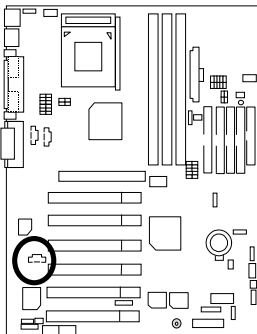

Pin No.	Definition
1	Signal-In
2	GND
3	GND
4	Signal-Out

## J18 : CD Audio Line In

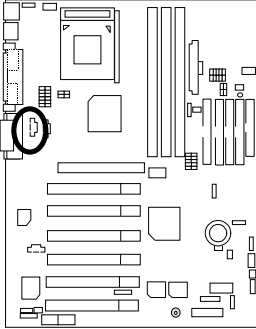

Pin No.	Definition
1	CD-L
2	GND
3	GND
4	CD-R

## JP6 : Power Fan

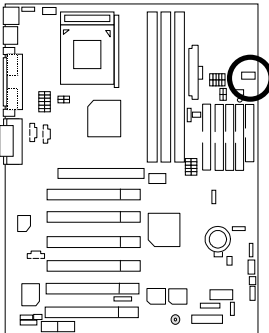

Pin No.	Definition
1	Control
2	+12V
3	NC

JP8 / LED1: STR LED Connector & DIMM LED

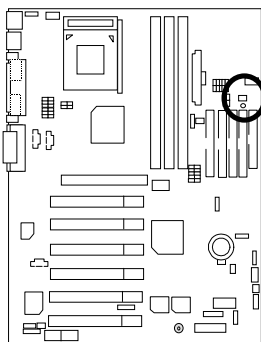

STR LED Connector External.



PS/2 Keyboard & PS/2 Mouse Connector

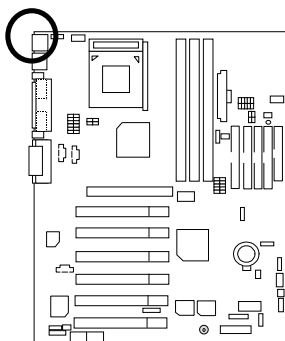

PS/2 Mouse

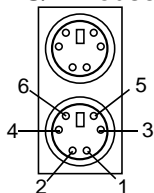

PS/2 Keyboard

PS/2 Mouse/Keyboard	
Pin No.	Definition
1	Data
2	NC
3	GND
4	VCC(+5V)
5	Clock
6	NC



## USB 1 Connector

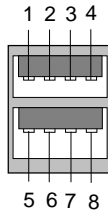
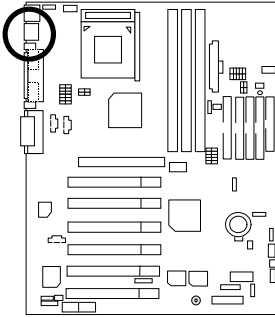

Pin No.	Definition
1	USB V0
2	USB D0-
3	USB D0+
4	GND
5	USB V1
6	USB D1-
7	USB D1+
8	GND

## USB 2 Connector

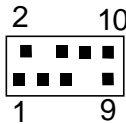
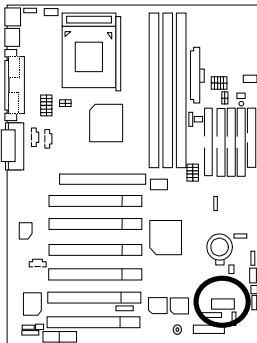

Pin No.	Definition
1	+5V
2	GND
3	USB D2-
4	NC
5	USB D2+
6	USB D3+
7	NC
8	USB D3-
9	GND
10	+5V

## Panel And Jumper Definition

### J11: 2x11 Pins Jumper

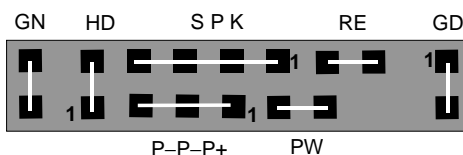
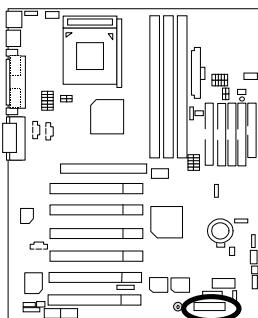

GN (Green Switch)	Open: Normal Operation Close: Entering Green Mode
GD (Green LED)	Pin 1: LED anode(+) Pin 2: LED cathode(-)
HD (IDE Hard Disk Active LED)	Pin 1: LED anode(+) Pin 2: LED cathode(-)
SPK (Speaker Connector)	Pin 1: VCC(+) Pin 2- Pin 3: NC Pin 4: Data(-)
RE (Reset Switch)	Open: Normal Operation Close: Reset Hardware System
P+P-P-(Power LED)	Pin 1: LED anode(+) Pin 2: LED cathode(-) Pin 3: LED cathode(-)
PW (Soft Power Connector)	Open: Normal Operation Close: Power On/Off

### JP3 : Clear CMOS Function (Optional)

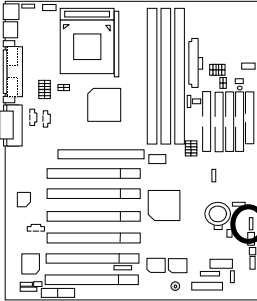

Pin No.	Definition
1-2 close	Normal (Default)
2-3 close	Clear CMOS

### JP4: Rear USB Device Wake up Selection (USB Connector → USB1)

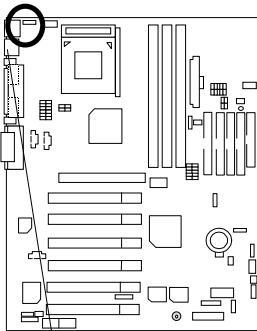

USB1



Pin No.	Definition
1-2 Close	Normal (Default)
2-3 Close	USB Device Wake up

(If you want to use "USB Dev Wakeup From S3-S5" function, you have to set the BIOS setting "USB Dev Wakeup From S3-S5" enabled, and the jumper "JP4&JP7" enabled).

\*(Power on the computer and as soon as memory counting starts, press <Del>. You will enter BIOS Setup. Select the item "POWER MANAGEMENT SETUP", then select "USB Dev Wakeup From S3-S5: Enabled". Remember to save the setting by pressing "ESC" and choose the "SAVE & EXIT SETUP" option.)

### JP7 : STR Function Enabled

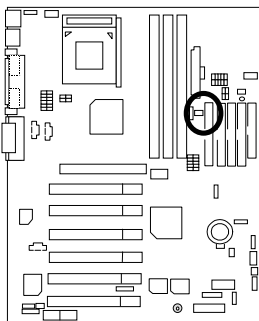

Pin No.	Definition
Open	Normal (Default)
Close	STR Enabled

### JP9 : Onboard Sound Function Selection

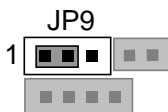
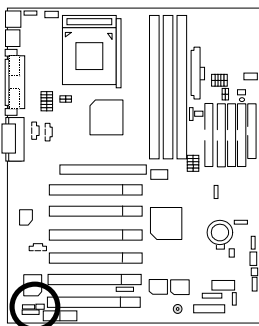

Pin No.	Definition
1-2 close	Onboard Sound Enable (Default)
2-3 close	Onboard Sound Disable

### JP10 : BIOS Write Protection (Optional)

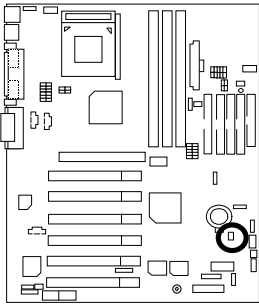

Pin No.	Definition
ON	Write Protect Enable
OFF	Write Protect Disable (Default)

● Please Set Jumper JP10 to "Open" to enabled BIOS Write Function when you update new BIOS or new device

### JP11 : Front USB Device Wake up Selection (USB Port → USB2)

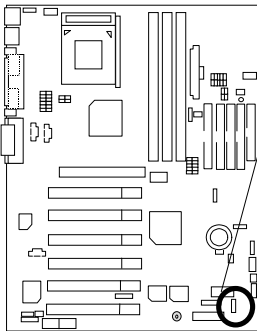

USB2



Pin No.	Definition
1-2 close	Normal (Default)
2-3 close	Enabled Front USB Device Wake up

(If you want to use "USB Dev Wakeup From S3-S5" function, you have to set the BIOS setting "USB Dev Wakeup From S3-S5" enabled, and the jumper "JP11&JP7" enabled).

\*(Power on the computer and as soon as memory counting starts, press <Del>. You will enter BIOS Setup. Select the item "POWER MANAGEMENT SETUP", then select "USB Dev Wakeup From S3-S5: Enabled". Remember to save the setting by pressing "ESC" and choose the "SAVE & EXIT SETUP" option.)

JP16 /JP17/JP18: AMR (Primary or Secondary) Select  
(AMR→ Audio Modem Riser)

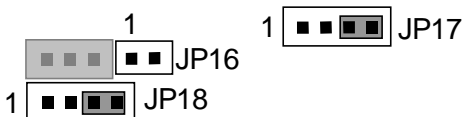
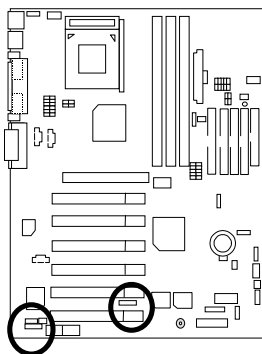

	JP16	JP17	JP18
Onboard AC97	ON	1-2	1-2
AMR (Primary) (Default)	OFF	3-4	3-4
Onboard AC97+MR (Secondary)	ON	1-2 3-4	1-2

JP19 : Onboard Promise Selection (Optional)

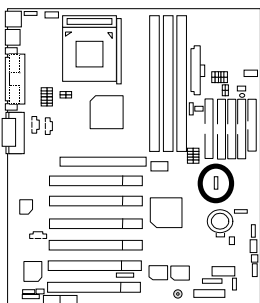

Pin No.	Definition
1-2 close	IDE Raid disabled (Promise chipset disabled)
2-3 close	IDE Raid enabled(Default) (Promise chipset enabled)

## JP20 : RAID/ATA100 Selection (Optional)

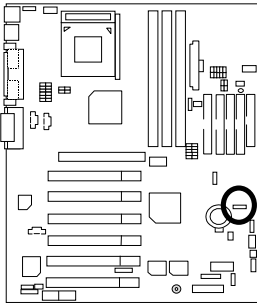

Pin No.	Definition
1-2 close	Raid Function
2-3 close	ATA 100 Function (Default)

(If you want to use "Raid Function", your IDE3 and IDE4 must be connected with Hard Driver.)

## BAT1: Battery

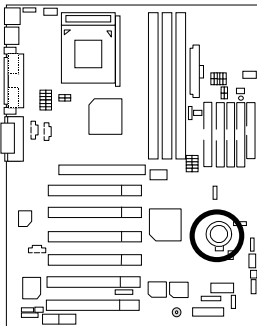

### CAUTION

- ☞ Danger of explosion if battery is incorrectly replaced.
- ☞ Replace only with the same or equivalent type recommended by the manufacturer.
- ☞ Dispose of used batteries according to the manufacturer's instructions.

## Performance List

The following performance data list is the testing results of some popular benchmark testing programs.

These data are just referred by users, and there is no responsibility for different testing data values gotten by users. (The different Hardware & Software configuration will result in different benchmark testing results.)

- CPU AMD Althon™ 1200MHz
- DRAM (128x2) MB SDRAM (MICRON MT48LC8M8A2-8E B)
- CACHE SIZE 384 KB included in CPU
- DISPLAY Gigabyte GF2000
- O.S. Windows NT™ 4.0 SPK6
- DRIVER Display Driver at 1024 x 768 x 16 bit colors 75Hz.

Processor	AMD Althon™ 1200MHz (133x9)	AMD Althon™ 1200MHz (133x9)	AMD Althon™ 1200MHz (133x9)
STORAGE	Promise IDE IBM DTLA-307045 x2 (RAID 0)	Onboard IDE IBM DTLA-307045	Promise ATA100 IDE IBM DTLA-307045
<b>Winbench99</b>			
CPU mark 99	107	108	108
FPU Winmark 99	6590	6590	6590
Business Disk Winmark 99	11500	8590	8590
Hi-End Disk Winmark 99	28200	21400	21300
Business Graphics Winmark 99	585	583	583
Hi-End Graphics Winmark 99	1220	1190	1230
<b>Winstone99</b>			
Business Winstone 99	54.7	55.1	55.1
Hi-End Winstone 99	70.9	69.1	68

● If you wish to maximize the performance of your system, please refer to details on P.82



# Block Diagram

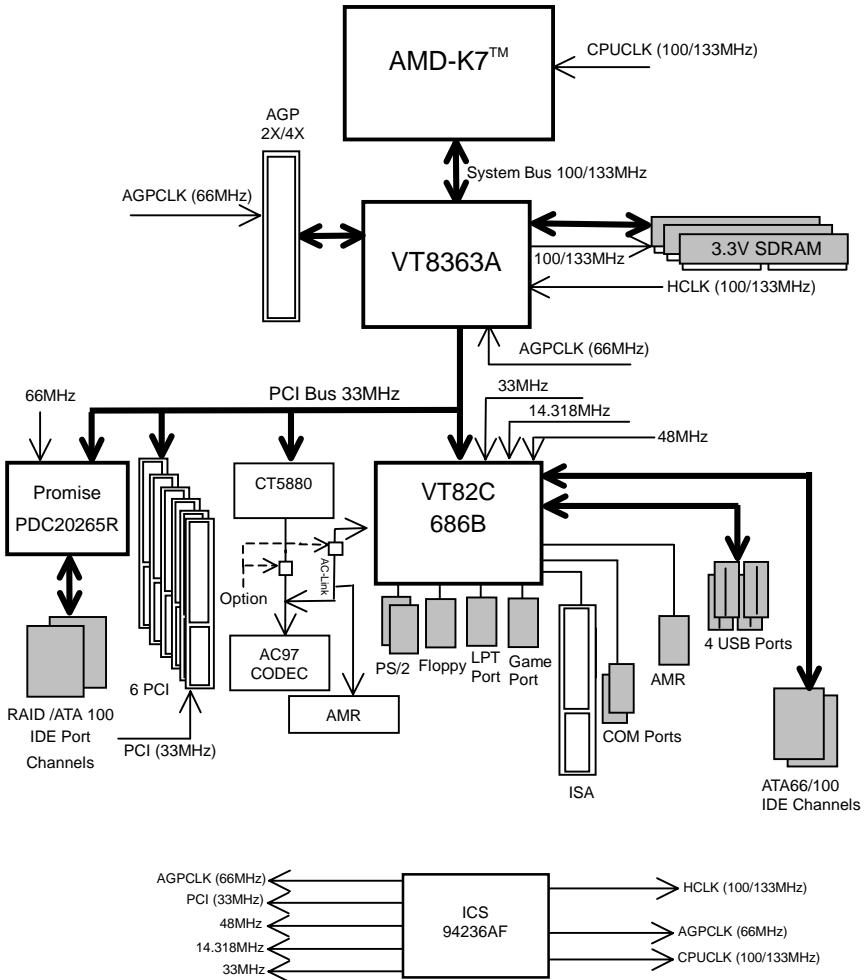

## Suspend To RAM Installation

### A.1 Introduce STR function:

Suspend-to-RAM (STR) is a Windows 98 ACPI sleep mode function. When recovering from STR (S3) sleep mode, the system is able, to retrieve the last “state” of the system before it went to sleep and recover to that state in just a few seconds. The “state” is stored in memory (RAM) before the system goes to sleep. During STR sleep mode, the system uses only enough energy to maintain critical information and system functions, primarily the system state and the ability to recognize various “wake up” triggers or signals, respectively.

### A.2 STR function Installation

Please use the following steps to complete the STR function installation.

#### Step-By-Step Setup

##### Step 1:

To utilize the STR function, the system must be in Windows 98 ACPI mode.

Putting Windows 98 into ACPI mode is fairly easy.

#### Setup with Windows 98 CD:

- A. Insert the Windows 98 CD into your CD-ROM drive, select Start, and then Run.
- B. Type (without quotes) “**D:\setup**” in the window provided. Hit the enter key or click OK.
- C. After setup completes, remove the CD, and reboot your system  
(This manual assumes that your CD-ROM device drive letter is D:).

**Step 2:**

(If you want to use STR Function, please set jumper JP7 Closed.)

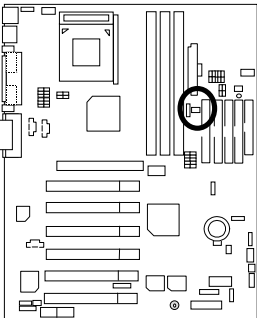

Pin No.	Definition
Open	Normal (Default)
Close	STR Enabled

**Step 3:**

Power on the computer and as soon as memory counting starts, press <Del>. You will enter BIOS Setup. Select the item **“POWER MANAGEMENT SETUP”**, then select **“ACPI Sleep Type : S3 / STR”**. Remember to save the settings by pressing “ESC” and choose the **“SAVE & EXIT SETUP”** option.

Congratulation! You have completed the installation and now can use the STR function.

### A.3 How to put your system into STR mode?

There are two ways to accomplish this:

1. Choose the "Stand by" item in the "Shut Down Windows" area.
  - A. Press the "Start" button and then select "Shut Down"



- B. Choose the "Stand by" item and press "OK"

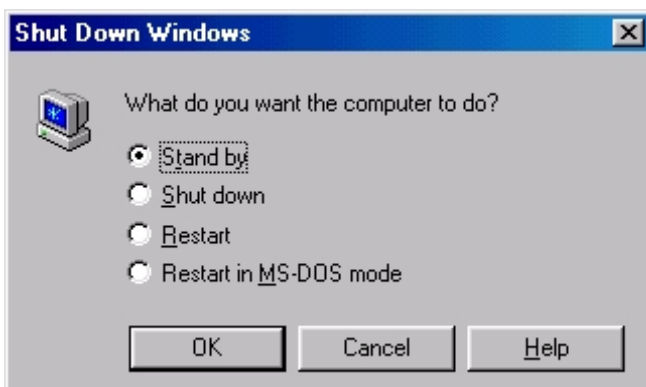

2. Define the system "power on" button to initiate STR sleep mode:

A. Double click "My Computer" and then "Control Panel"

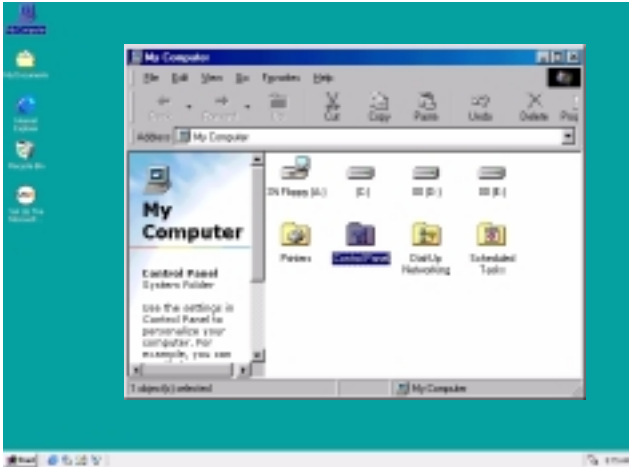

B. Double click the " Power Management" item.

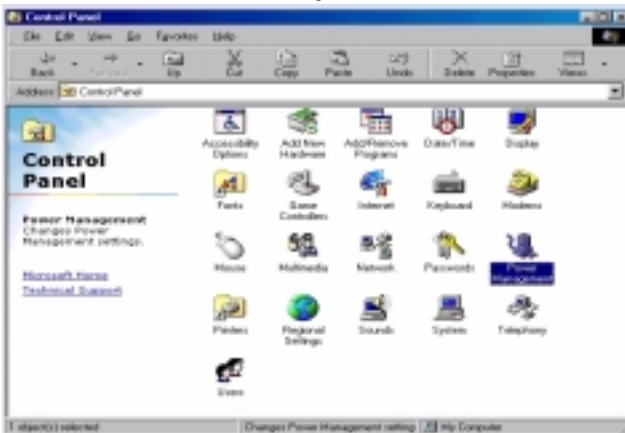

C. Select the "Advanced" tab and "Standby" mode in Power Buttons.

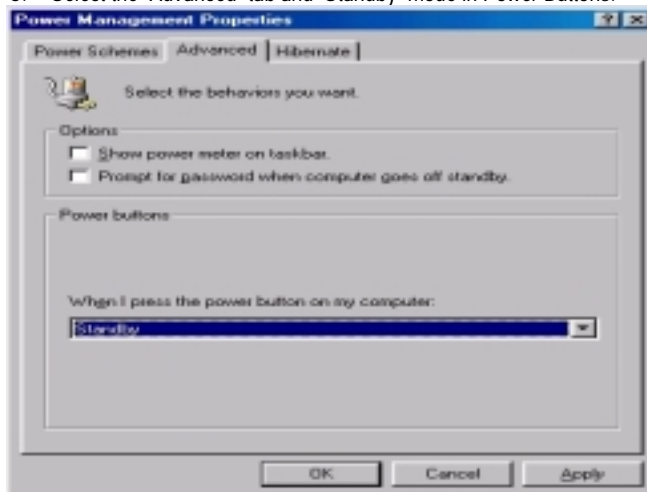

**Step 4:**

Restart your computer to complete setup.

Now when you want to enter STR sleep mode, just momentarily press the "Power on" button.

**A.4 How to recover from the STR sleep mode?**

There are five ways to "wake up" the system:

1. Press the "Power On" button.
2. Use the "Resume by Alarm" function.
3. Use the "Modem Ring On" function.
4. Use the "Wake On LAN" function.
5. Use the "USB Device Wake Up" function.

**A.5 Notices :**

1. In order for STR to function properly, several hardware and software requirements must be satisfied:
  - A. Your ATX power supply must comply with the ATX 2.01 specification (provide more than 720 mA 5V Stand-By current).
  - B. Your SDRAM must be PC-100 compliant.
2. Jumper JP8 is provided to connect to the STR LED in your system chassis. [Some chassis may not provide this feature.] The STR LED will be illuminated when your system is in STR sleep mode.

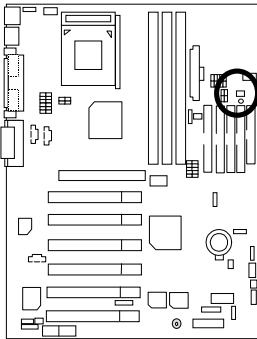

STR LED Connector External.



## Dual BIOS Introduction

### A. What is Dual BIOS Technology?

Dual BIOS means that there are two system BIOS (ROM) on the motherboard, one is the Main BIOS and the other is Backup BIOS. Under the normal circumstances, the system works on the Main BIOS. If the Main BIOS is corrupted or damaged, the Backup BIOS can take over while the system is powered on. This means that your PC will still be able to run stably as if nothing has happened in your BIOS.

### B. How to use Dual BIOS?

#### a. Boot Screen

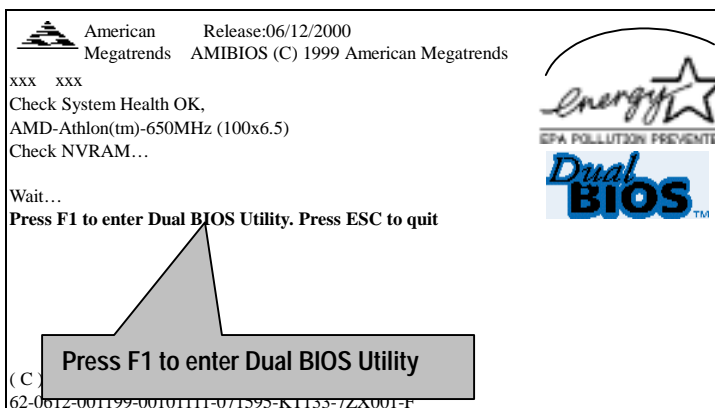



## b. AMI Dual BIOS Flash ROM Programming Utility

AMI Dual BIOS Flash ROM Programming Utility	
Boot From.....	Main BIOS
Main ROM Type.....	SST 39SF020
Backup ROM Type.....	SST 39SF020
<p style="text-align: center;"> <b>Wide Range Protection</b> Disable  <b>Boot From</b> Main BIOS  <b>Auto Recovery</b> Enable  <b>Halt On Error</b> Disable  Copy Main ROM Data to Backup  Load Default Settings  Save Settings to CMOS </p>	
PgDn/PgUp:Modify    ↑↓:Move    ESC:Reset    F10:Power Off	

## c. Dual BIOS Item explanation:

**BIOS will auto detect:****Boot From** : Main BIOS**Main ROM Type** : SST 39SF020**Backup ROM Type** : SST 39SF020**Wide Range Protection: Disable(Default), Enable***Status 1:*

If any failure (ex. Update ESCD failure, checksum error or reset...) occurs in the Main BIOS, just before the Operating System is loaded and after the power is on, and that the Wide Range Protection is set to "Enable", the PC will boot from Backup BIOS automatically.

*Status 2:*

If the ROM BIOS on peripherals cards(ex. SCSI Cards, LAN Cards,..) emits signals to request restart of the system after the user make any alteration on it, the boot up BIOS will not be changed to the Backup BIOS.

### **Boot From : Main BIOS (Default), Backup BIOS**

#### *Status 1:*

The user can set to boot from main BIOS or Backup BIOS.

### **Auto Recovery : Enabled(Default), Disabled**

When one of the Main BIOS or Backup BIOS occurs checksum failure, the working BIOS will automatically recover the BIOS of checksum failure.

(In the Power Management Setup of the BIOS Setting, if ACPI Suspend Type is set to Suspend to RAM, the Auto Recovery will be set to Enable automatically.)

(If you want to enter the BIOS setting, please press "Del" key when the boot screen appears.)

### **Halt On Error : Disable(Default), Enable**

If the BIOS occurs a checksum error or the Main BIOS occurs a WIDE RANGE PROTECTION error and Halt On BIOS Defects set to Enable, the PC will show messages on the boot screen, and the system will pause and wait for the user's instruction.

If Auto Recovery: **Disable**, it will show *<or the other key to continue.>*

If Auto Recovery: **Enable**, it will show *<or the other key to Auto Recover.>*

### **Copy Main ROM Data to Backup**

Backup message:

***Are you sure to copy BIOS?***

***[Enter] to continue or [Esc] to abort ...***

The means that the Main BIOS works normally and could automatically recover the Backup BIOS. Or the means that the Backup BIOS works normally and could automatically recover the Main BIOS.

(This auto recovery utility is set by system automatically and can't be changed by user.)



## DualBIOS™ Technology FAQ

GIGABYTE Technology is pleased to introduce DualBIOS technology, a hot spare for your system BIOS. This newness "Value-added" feature, in a long of innovations from GIGABYTE, is available on GA-7ZXR motherboard. Future GIGABYTE motherboards will also incorporate this innovation.

### What's DualBIOS™?

On GIGABYTE motherboards with DualBIOS there are physically two BIOS chips. For simplicity we'll call one your "Main BIOS" and the other we'll call your "Backup" BIOS (your "hot spare"). If your Main BIOS fails, the Backup BIOS almost automatically takes over on your next system boot. Almost automatically and with virtually zero down time! Whether the problem is a failure in flashing your BIOS or a virus or a catastrophic failure of the Main BIOS chip, the result is the same - the Backup BIOS backs you up, almost automatically.

### **I. Q: What is DualBIOS™ technology?**

#### **Answer:**

DualBIOS technology is a patented technology from Giga-Byte Technology. The concept of this technology is based on the redundancy and fault tolerance theory. DualBIOS™ technology simply means there are two system BIOSes (ROM) integrated onto the motherboard. One is a main BIOS, and the other is a backup BIOS. The mainboard will operate normally with the main BIOS, however, if the main BIOS is corrupt or damaged for various reasons, the backup BIOS will be automatically used when the system powered-On. Your PC will operate as before the main BIOS was damaged, and is completely transparent to the user.

### **II. Q: Why does anyone need a motherboard with DualBIOS™ technology?**

#### **Answer:**

In today's systems there are more and more BIOS failures. The most common reasons are virus attacks, BIOS upgrade failures, and/or deterioration of the BIOS (ROM) chip itself.

1. New computer viruses are being found that attack and destroy the system BIOS. They may corrupt your BIOS code, causing your PC to be unstable or even not boot normally.
2. BIOS data will be corrupted if a power loss/surge occurs, or if a user resets the system, or if the power button is pressed during the process of performing a system BIOS upgrade.
3. If a user mistakenly updates their mainboard with the incorrect BIOS file, then the system may not be able to boot correctly. This may cause the PC system hang in operation or during boot.
4. A flash ROM's life cycle is limited according to electronic characteristics. The modern PC utilizes the Plug and Play BIOS, and is updated regularly. If a user changes peripherals often, there is a slight chance of damage to the flash ROM.

With Giga-Byte Technology's patented DualBIOS™ technology you can reduce the possibility of hangs during system boot up, and/or loss BIOS data due to above reasons. This new technology will eliminate valuable system down time and costly repair bills cause by BIOS failures.

### **III. Q: How does DualBIOS™ technology work?**

#### **Answer:**

1. DualBIOS™ technology provides a wide range of protection during the boot up procedure. It protects your BIOS during system POST, ESCD update, and even all the way to PNP detection/assignment.
2. DualBIOS™ provides automatic recovery for the BIOS. When the first BIOS used during boot up does not complete or if a BIOS checksum error occurs, boot-up is still possible. In the DualBIOS™ utility, the "Auto Recovery" option will guarantee that if either the main BIOS or backup BIOS is corrupted, the DualBIOS™ technology will use the good BIOS and correct the wrong BIOS automatically.
3. DualBIOS™ provides manual recovery for the BIOS. DualBIOS™ technology contains a built-in flash utility, which can flash your system BIOS from backup to main and/or visa versa. There is no need for an OS-dependent flash utility program.
4. DualBIOS™ contains a one-way flash utility. The built-in one-way flash utility will ensure that the corrupt BIOS is not mistaken as the good BIOS during recovery and that the correct BIOS (main vs. backup) will be flashed. This will prevent the good BIOS from being flashed.

### **IV. Q: Who Needs DualBIOS™ technology?**

#### **Answer:**

1. Every user should have DualBIOS™ technology due to the advancement of computer viruses.  
Everyday, there are new BIOS-type viruses discovered that will destroy your system BIOS. Most commercial products on the market do not have solutions to guard against this type of virus intrusion. The DualBIOS™ technology will provide a state-of-the-art solution to protect your PC:  
Case I.) Vicious computer viruses may wipe out your entire system BIOS. With a conventional single system BIOS PC, the PC will not be functional until it is sent for repairs.  
Case II.) If the "Auto Recovery" option is enabled in the DualBIOS™ utility, and if a virus corrupts your system BIOS, the backup BIOS will automatically reboot the system and correct the main BIOS.  
Case III.) A user may override booting from the main system BIOS. The DualBIOS™ utility may be entered to manually change the boot sequence to boot from the backup BIOS.

2. During or after a BIOS upgrade, if DualBIOS™ detects that the main BIOS is corrupt, the backup BIOS will take over the boot-up process automatically. Moreover, it will verify the main and backup BIOS checksums when booting-up. DualBIOS™ technology examines the checksum of the main and backup BIOS while the system is powered on to guarantee your BIOS operates properly.
3. Power Users will have the advantage of having two BIOS versions on their mainboard. The benefit is being able to select either version BIOS to suit the performance system needs.
4. Flexibility for high-end desktop PCs and workstation/servers. In the DualBIOS™ utility, the option can be set, "Halt On When BIOS Defects," to be enabled to halt your system with a warning message that the main BIOS has been corrupted. Most workstation/servers require constant operation to guarantee services have not been interrupted. In this situation, the "Halt On When BIOS Defects" message may be disabled to avoid system pauses during normal booting. Another advantage you gain from Giga-Byte's DualBIOS™ technology is the ability to upgrade from dual 2 Mbit BIOS to dual 4 Mbit BIOS in the future if extra BIOS storage is need.

## Four Speaker & SPDIF Introduction

### Four Speaker Introduction

#### A. What is Four Speaker?

The Creative CT5880 audio chip can support up to 4 speaker output. If you select “Four speaker out”, Line In will be reconfigured as another line out to support a second pair of speakers.

#### B. How to use Four Speaker?

Microsoft Windows 98 Second Edition setup procedure:

- a. Click the audio icon along the task bar and select “Configure 3D Audio”

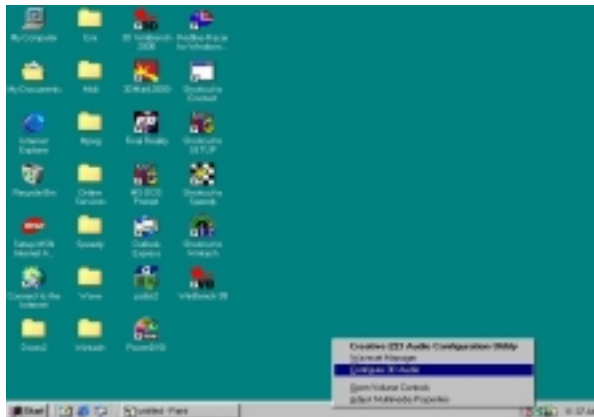

- b. Select two speaker (Default)

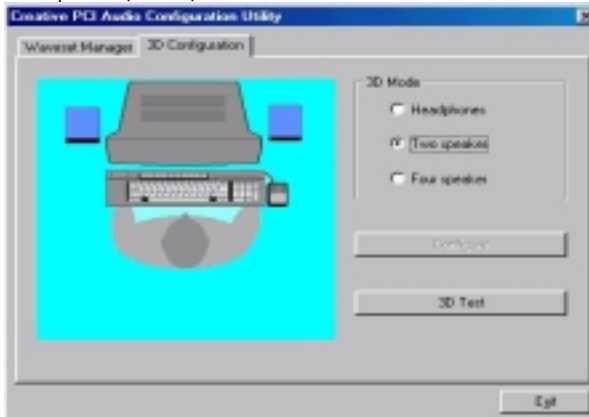

7ZXR Series Motherboard

---

c. Select "Four speaker" item.



Microsoft Windows Me setup procedure:

a. Go to "Control Panel"

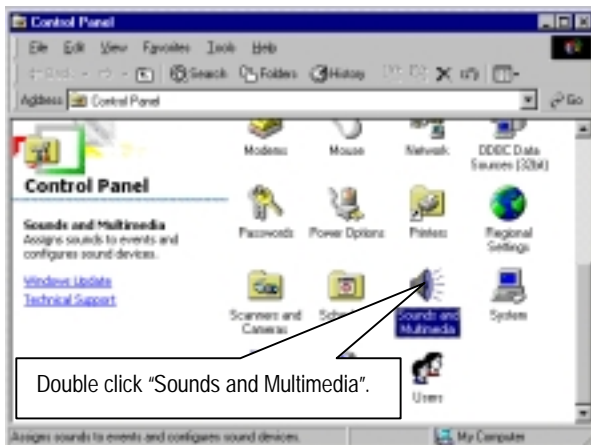



b. Select "Audio" Page, and click "Advanced" button.

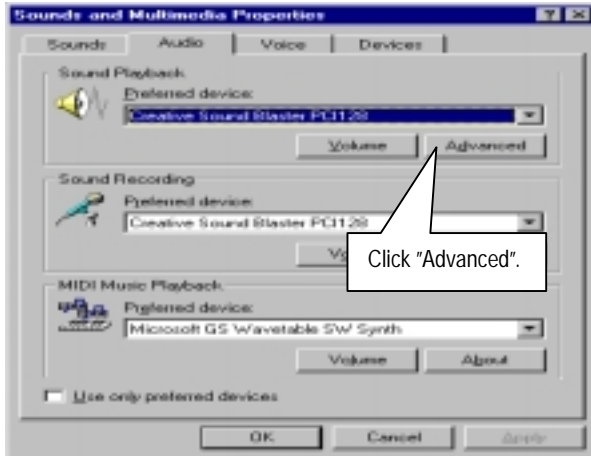

c. Select "Quadraphonic Speakers" and click ok.

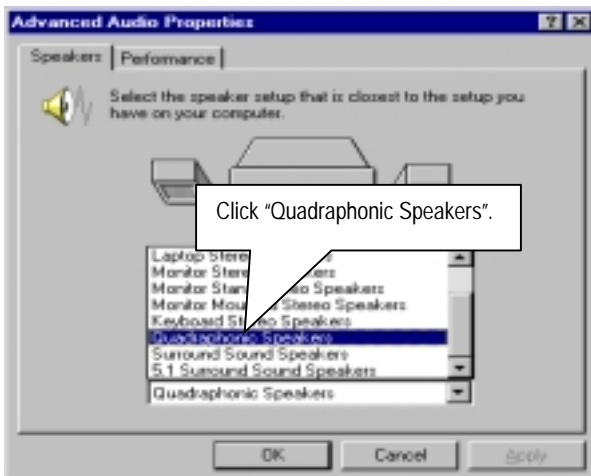

### C. Four Speaker Application

The four speaker function will only be supported in application softwares that use Microsoft DirectX and Creative EAX, for example, the game titles, software DVD player and MP3 player.

## SPDIF Introduction

### A. What is SPDIF?

The SPDIF output is capable of providing digital audio to external speakers or compressed AC3 data to an external Dolby digital decoder.

### B. How to use SPDIF?

- a. Click your mouse right button in "My Computer" and select the "Properties" item.

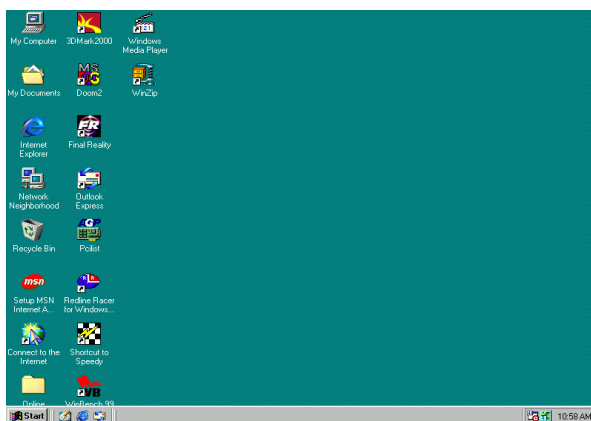

- b. Click "Device Manager" item.

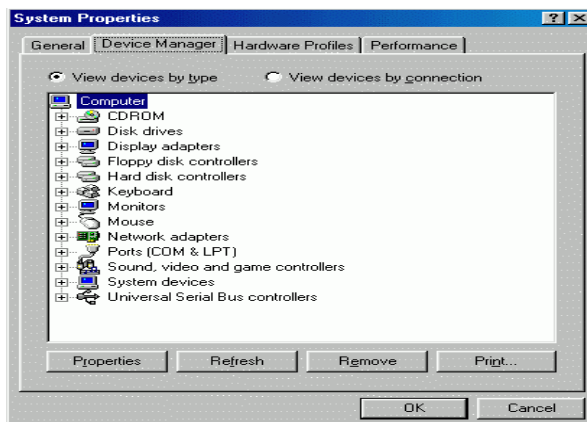

- c. Click “Sound, video and game controllers” item and select the “Creative Sound Blaster PCI128” item.

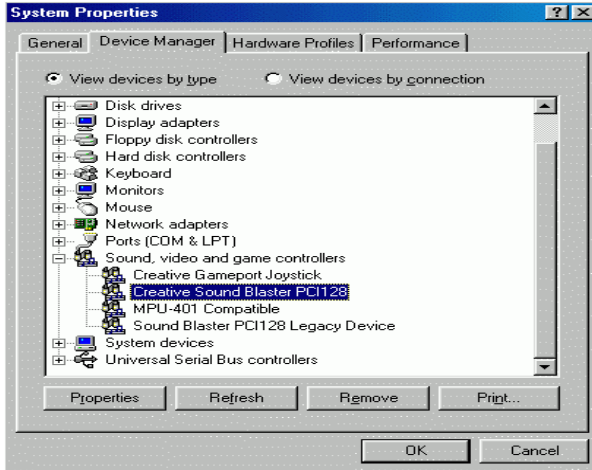

- d. Click “Settings” item and select the “Output Mode” item.

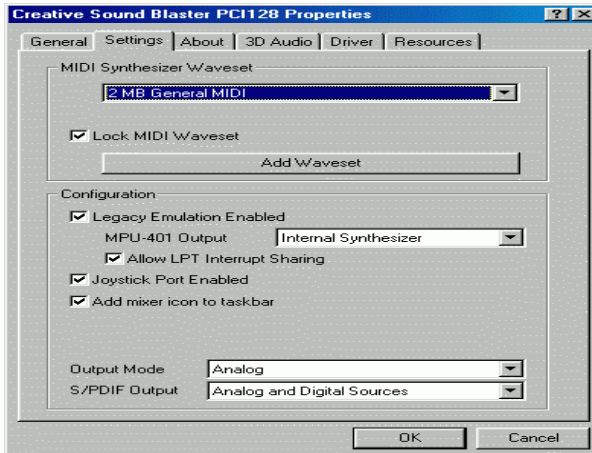

e. Click "Digital" item, Line Out will be reconfigure to SPDIF Out.

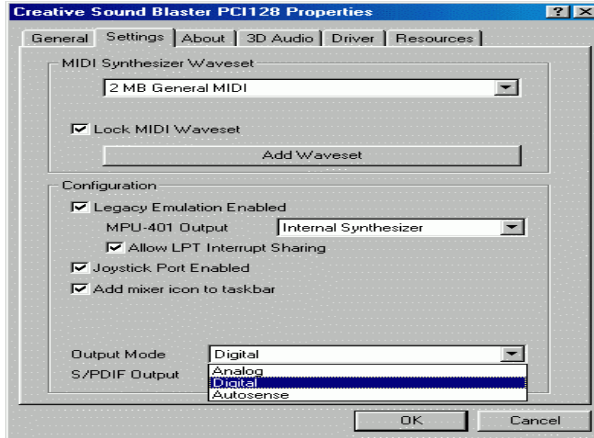

※Note, The motherboard doesn't support "Autosense".

## @ BIOS Introduction

### Gigabyte announces @ BIOS Windows BIOS live update utility



Have you ever updated BIOS by yourself? Or like many other people, you just know what BIOS is, but always hesitate to update it? Because you think updating newest BIOS is unnecessary and actually you don't know how to update it.

Maybe not like others, you are very experienced in BIOS updating and spend quite a lot of time to do it. But of course you don't like to do it too much. First, download different BIOS from website and then switch the operating system to DOS mode. Secondly, use different flash utility to update BIOS. The above process is not a interesting job. Besides, always be carefully to store the BIOS source code correctly in your disks as if you update the wrong BIOS, it will be a nightmare.

Certainly, you wonder why motherboard vendors could not just do something right to save your time and effort and save you from the lousy BIOS updating work? Here it comes! Now Gigabyte announces @BIOS--the first Windows BIOS live update utility. This is a smart BIOS update software. It could help you to download the BIOS from internet and update it. Not like the other BIOS update software, it's a Windows utility. With the help of "@BIOS", BIOS updating is no more than a click.

Besides, no matter which mainboard you are using, if it's a Gigabyte's product\*, @BIOS help you to maintain the BIOS. This utility could detect your correct mainboard model and help you to choose the BIOS accordingly. It then downloads the BIOS from the nearest Gigabyte ftp site automatically. There are several different choices; you could use "Internet Update" to download and update your BIOS directly. Or you may want to keep a backup for your current BIOS, just choose "Save Current BIOS" to save it first. You make a wise choice to use Gigabyte, and @BIOS update your BIOS smartly. You are now worry free from updating wrong BIOS, and capable to maintain and manage your BIOS easily. Again, Gigabyte's innovative product erects a milestone in mainboard industries.

For such a wonderful software, how much it costs? Impossible! It's free! Now, if you buy a Gigabyte's motherboard, you could find this amazing software in the attached driver CD. But please remember, connected to internet at first, then you could have a internet BIOS update from your Gigabyte @BIOS.

## EasyTune III™ Introduction

### Gigabyte announces *EasyTune III* Windows overdrive utility



“Overdrive” might be one of the most common issues in computer field. But have many users ever tried it? The answer is probably “no”. Because “overdrive” is thought to be very difficult and includes a lot of technical know-how, sometimes “overdrive” is even considered as special skills found only in some enthusiasts.

But as to the experts in “overdrive”, what’s the truth? They may spend quite a lot of time and money to study, try and use many different hardware and software tools to do “overdrive”. And even with these technologies, they still learn that it’s quite a risk because the safety and stability of an “overdrive” system is unknown.

Now everything is different because of a Windows overdrive utility EasyTuneIII --announced by Gigabyte. This utility has totally changed the gaming rule of “overdrive”. This is the first overdrive utility suitable for both normal and power users. Users can choose either “Easy Mode” or “Advanced Mode” to run “overdrive” at their convenience. For users who choose “Easy Mode”, they just need to click “Auto Optimize” to have auto and immediate CPU overclocking. This software will then overdrive CPU speed automatically with the result being shown in the control panel. If someone prefers to “overdrive” by oneself, there is also another choice. Click “Advanced Mode” to enjoy “sport drive” class overclocking. In “Advanced Mode”, one can change the system bus speed in small increments to get ultimate system performance. And no matter which mainboard is used, if it’s a Gigabyte’s product\*, EasyTuneIII helps to perform the best of system.

Besides, different from other traditional over-clocking methods, EasyTuneIII doesn’t require users to change neither BIOS nor hardware switch/ jumper setting; on the other hand, they can do “overdrive” at only one click. Therefore, this is a safer way for “overdrive” as nothing is changed on software or hardware. If user runs EasyTuneIII over system’s limitation, the biggest lost is only to restart the computer again and the side effect is then well controlled. Moreover, if one well-performed system speed been tested in EasyTuneIII, user can “Save” this bus speed and “Load” it in next time. Obviously, Gigabyte EasyTuneIII has already turned the “overdrive” technology toward to a newer generation.

This wonderful software is now free bundled in Gigabyte motherboard attached driver CD. Users may make a test drive of "EasyTuneIII" to find out more amazing features by themselves.

For further technical information, please link to: <http://www.gigabyte.com.tw>

**※ Note: If your TUCD version is 1.6 or below, please visit our website and download the latest EasyTuneIII™ version.**

## RAID Introduction (Optional)

### What is RAID?

This motherboard implements two different types of RAID levels as follows:

#### RAID 0 (stripe)

**For capacity** -- The motherboard array will be as big as the smallest HDD in the array times however many HDDs are in the array. Any larger HDDs will simply be truncated. The truncated space on the bigger HDDs will then be unusable.

**For sustained data transfers** -- A RAID 0 array consisting of two HDDs will transfer at about twice the speed of the slowest HDD in the array. A RAID 0 array consisting of four HDDs will transfer at about three times the speed of the slowest HDD in the array.

#### RAID 1 (mirror)

**For capacity** -- This Motherboard array will be as big as the smallest HDD in the array. The larger HDD will simply be truncated. The truncated space on the bigger HDD will then be unusable.

**For sustained data transfers** -- This motherboard array will write data at the rate of the slowest HDD in the array. This motherboard array will read data at twice the rate of the slowest HDD in the array.



## About RAID Levels

### *Striping (RAID 0)*

Reads and writes sectors of data interleaved between multiple drives. When any disk member fails, it affects the entire array. Performance is better than a single drive since the workload is balanced between the array members. This array type is for high performance systems. Identical drives are recommended for performance as well as data storage efficiency. The disk array data capacity is equal to the number of drive members times the smallest member capacity. For example, one 1GB and 1 drives will form a 2GB (2 x 1GB) disk array.

**Stripe Size** - a value can be set from 1KB to 1024KB sector size. The size can directly affect performance. In the FastBuild BIOS, the "Desktop" default is 8KB while "Server" and "A/V Editing" are 64KB.

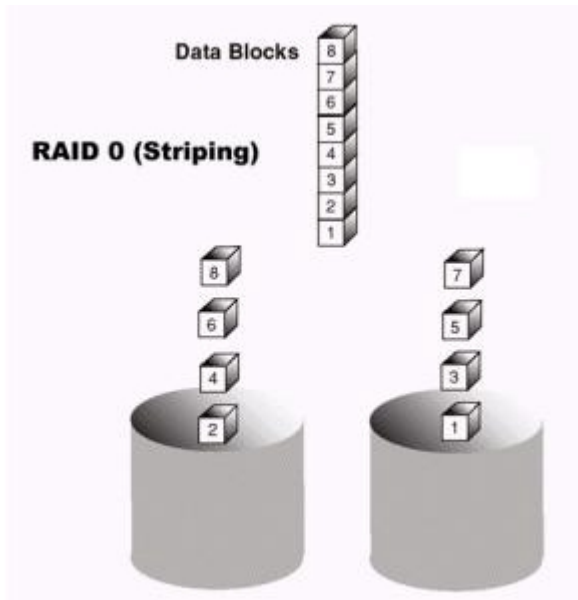

### *Mirroring (RAID 1)*

Writes duplicate data on to a pair of drives while reads are performed in parallel. ATA RAID 1 is fault tolerant because each drive of a mirrored pair is installed on separate IDE channels. If one of the mirrored drives suffers a mechanical failure (e.g. spindle failure) or does not respond, the remaining drive will continue to function. This is called ***Fault Tolerance***. If one drive has a physical sector error, the mirrored drive will continue to function.

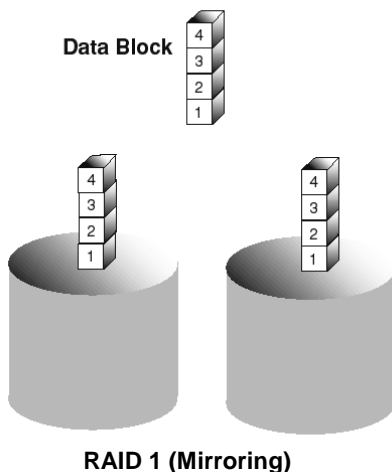

On the next reboot, the FastBuild™ utility will display an error in the array and recommend to replace the failed drive. Users may choose to continue using their PC, however Promise recommends replacing the failed drive as soon as possible. See Chapter 4 for a functional description.

Due to redundancy, the drive capacity of the array is half the total drive capacity. For example, two 1GB drives that have a combined capacity of 2GB would have 1GB of usable storage. With drives of different capacities, there may be unused capacity on the larger drive.

## Creating Your Disk Array

You will now use the FastBuild BIOS utility to create your array using the attached drives. There are two different scenarios in creating this array. You can create an array for performance, you can create a Security array using new hard drives (recommended).



**WARNING:** *If creating a Security array using an existing hard drive, backup any necessary data. Failure to follow this accepted PC practice could result in data loss.*

1. Boot your system. If this is the first time you have booted with RAID, the FastBuild BIOS will display the following screen.

```
FastTrak100 (tm) "Lite" BIOS Version 1.xx (Build xxxx)
(c) 1995-2000 Promise Technology, Inc. All Rights Reserved.
```

```
No array defined . . .
```

```
Press <Ctrl-F> to enter FastBuild (tm) Utility
Or press <ESC> key to continue booting the system.
```

2. Press <Ctrl-F> keys to display the FastBuild (tm) Utility Main Menu
3. Press "1" to display the Auto Setup Menu below. This is the fastest and easiest method to creating your first array.

```
FastBuild (tm) Utility 1.xx (c) 1995-2000 Promise Technology, Inc.
[Auto Setup Options Menu]
```

```
Optimize Array for:      Performance
Typical Application usage:  A/V Editing
```

```
[ Auto Setup Configuration ]
```

```
Mode.....Stripe
Spare Driver.....0
Drives used in Array.....2
Array Disk Capacity..... 16126
```

```
[ Keys Available ]
```

```
[↑] Up [↓] Down  [←, →, Space] Change Option  [ESC] Exit  [Ctrl-Y] Save
```

### ***Creating an Array for Performance***

**NOTE:** *This motherboard allows users to create striped arrays with 1, 2 drives.*

To create an array for best performance, follow these steps:

1. Using the Spacebar, choose "Performance" under the **Optimize Array for** section.
2. Select how you will use your PC most under the **Typical Application usage** section. The choices are A/V Editing, Server, and Desktop (the default).
3. Press <Ctrl-Y> keys to Save and create the array.
4. Reboot your system.
5. Once the array has been created, you will need to FDISK and format the array as if it were a new single hard drive.
6. Proceed to Installing Drivers section of the manual (see **RAID Manual of the TUCD**).

### ***Creating a Security Array With New Drives***

**NOTE:** *This motherboard permit only two drives to be used for a single Mirrored array in Auto Setup.*

To create an array for data protection using new hard drives, follow these steps:

1. Using the Spacebar, choose "Security" under the **Optimize Array for** section.
2. Press <Ctrl-Y> keys to Save your selection.
3. The window below will appear.

Do you want the disk image to be duplicated to another? (Yes/No) Y - Create and Duplicate N - Create Only
---

4. Press "N" for the Create Only option.
5. A window will appear almost immediately confirming that your Security array has been created. Press any key to reboot the system

Array has been created. <Press Any Key to Reboot>
--

6. Proceed with normal FDISK and format procedures as if you had just installed a new hard drive.
7. Once the arrayed drives have been formatted, proceed to the **Installing Driver** chapter (see **RAID Manual of the TUCD**) to install your operating system.

### Creating a Security Array With An Existing Data Drive

**NOTE:** This motherboard permits only two drives to be used for a single Mirrored array in Auto Setup.

You would use this method if you wish to use a drive that already contains data and/or is the bootable system drive in your system. You will need another drive of identical or larger storage capacity.



**WARNING:** Backup any necessary data before proceeding. Failure to follow this accepted PC practice could result in data loss.



**WARNING:** If you wish to include your current bootable drive using the Windows NT 4.x or Windows 2000 operating system as part of a bootable Mirrored (RAID 1) array on your system, do NOT connect the hard drive to the motherboard controller yet. You MUST install the Windows NT4 or 2000 driver software first (see **RAID Manual of the TUCD**) to this drive while it is still attached to your existing hard drive controller. For all other Operating Systems, proceed here.

Follow these steps:

- Using the Spacebar, choose "Security" under the **Optimize Array for** section.
- Press <Ctrl-Y> keys to Save your selection. The window below will appear.

Do you want the disk image to be duplicated to another? (Yes/No) Y - Create and Duplicate N - Create Only
---

- Press "Y" for the Create and Duplicate option. The window below will appear asking you to select the Source drive to use. FastBuild will copy all data from the Source drive to the Target drive.

Source Disk		
Channel:ID	Drive Model	Capacity (MB)
Target Disk		
Channel:ID	Drive Model	Capacity (MB)
[Please Select A Source Disk]		
Channel:ID	Drive Model	Capacity (MB)
1 :Master	QUANTUMCR8.4A	8063
2 :Master	QUANTUMCR8.4A	8063
[↑] Up [↓] [ESC] Exit [Ctrl-Y] Save		

## 7ZXR Series Motherboard

---

4. Use the arrow keys to choose which drive contains the existing data to be copied.
5. Press [Ctrl-Y] keys to Save selection and start duplication. The following progress screen will appear.

Start to duplicate the image . . .  
Do you want to continue? (Yes/No)  
Y – Continue N - Abort

6. Select "Y" to continue. If you choose "N" , you will be returned to step 1.
7. Once complete, the following screen will appear confirming that your Security array has been created. Press any key to reboot the system

Array has been created.  
<Press Any Key to Reboot>

8. Proceed to the **Installing Driver** chapter (see **RAID Manual of the TUCD**) to install the RAID driver and/or operating system.

## Using FastBuild™ Configuration Utility

The FastBuild™ Configuration Utility offers several menu choices to create and manage the drive array on the motherboard. For purposes of this manual, it is assumed you have already created an array in the previous chapter and now wish to make a change to the array or view other options.

### Viewing BIOS Screen

When you boot your system with the RAID function and drives installed, the FastBuild BIOS will detect the drives attached and show the following screen.

```
FastTrak100 (tm)"Lite" BIOS Version 1.xx (Build xx)
(c) 1995-2000 Promise Technology, Inc. All Rights Reserved.

Scanning IDE drives . . . . .
```

If an array exists already, the BIOS will display the following screen showing the board RAID BIOS version and status of the array.

```
FastTrak100 (tm) "Lite" BIOS Version 1.xx (Build xxxx)
(c) 1995-2000 Promise Technology, Inc. All Rights Reserved.

  ID      MODE SIZE      TRACK-MAPPING      STATUS
  1 *     1*2 Mirror    16126M  611/128/32    Functional

Press <Ctrl-F> to enter FastBuild (tm) Utility....
```

The array status consists of three possible conditions: *Functional*, *Critical*, *Offline*.

**Functional** - The array is operational.

**Critical** - A mirrored array contains a drive that has failed or disconnected. The remaining drive member in the array is functional. However, the array has temporarily lost its ability to provide fault tolerance. The user should identify the failed drive through the FastBuild™ Setup utility, and then replace the problem drive.

**Offline** - A striped array has 1 drive that has failed or been disconnected. When the array condition is "offline," the user must replace the failed drive(s), then restore data from a backup source.

### Navigating the FastBuild™ Setup Menu

When using the menus, these are some of the basic navigation tips: Arrow keys highlights through choices; [Space] bar key allows to cycle through options; [Enter] key selects an option; [ESC] key is used to abort or exit the current menu.

#### *Using the Main Menu*

This is the first option screen when entering the FastBuild™ Setup.

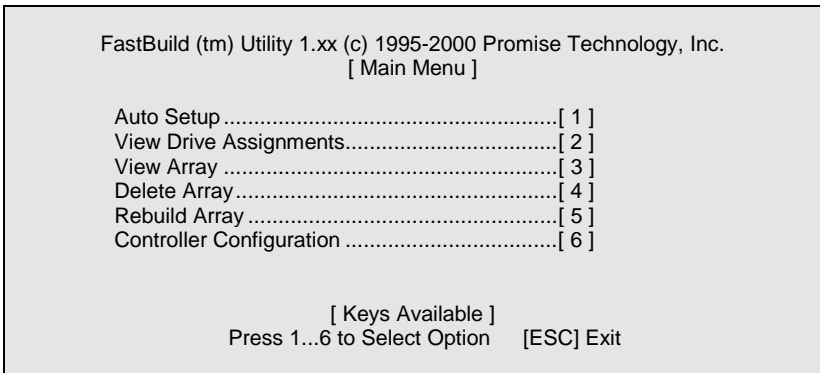

To create a new array automatically, follow the steps under “Creating Arrays Automatically” on page 58. Promise recommends this option for most users.

To view drives assigned to arrays, see “Viewing Drive Assignments” on page 60.

To delete an array (but not delete the data contained on the array), select “Deleting An Array” on page 67.

To rebuild a mirrored array, see “Rebuilding an Array” on page 69.

To view controller settings, see “Viewing Controller Configuration” on page 71.



**NOTE:** After configuring an array using FastBuild, you should **FDISK** and format the arrayed drive(s) if you are using new, blank drives. Depending on the type of array you are using.



## Creating Arrays Automatically

The Auto Setup <1> selection from the Main Menu can intuitively help create your disk array. It will assign all available drives appropriate for the disk array you are creating. After making all selections, use Ctrl-Y to Save selections. FastBuild will automatically build the array.

```

FastBuild (tm) Utility 1.xx (c) 1995-2000 Promise Technology, Inc.
[Auto Setup Options Menu]

Optimize Array for:      Performance
Typical Application usage:  A/V Editing

[ Auto Setup Configuration ]

Mode.....Stripe
Spare Drive Count.....0
Drives used in Array.....2
Array Disk Capacity..... 16126

[ Keys Available ]

[↑] Up [↓] Down  [←, →, Space] Change Option  [ESC] Exit  [Ctrl-Y] Save

```

### ***Optimize Array For***

Select whether you want Performance (RAID 0), Security (RAID 1) under the "Optimize Array for" setting.

#### Performance (RAID 0 Striping)

Supports the maximum performance. The storage capacity equals the number of drives times the capacity of the smallest drive in the disk array.

***NOTE:*** *This motherboard permits striped arrays using 1, 2 drive attached in Auto Setup mode.*

#### Security (RAID 1 Mirroring)

Creates a mirrored (or fault tolerant) array for data security.

***NOTE:*** *Under the Security setting, This motherboard permits two drives to be used for a single Mirrored array only.*

### ***Defining Typical Application Usage***

Allows the user to choose the type of PC usage that will be performed in order to optimize how *This motherboard* handles data blocks to enhance performance. Your choice will determine the block size used. You may choose from: A/V Editing (for audio/video applications, or any similar application that requires large file transfers), Server (for numerous small file transfers), or Desktop (a combination of large and small file sizes).

### ***Creating Multiple Disk Arrays***

1. If you plan to create multiple arrays, attach only the drives necessary to create the first disk array and complete the <1> Auto Setup.
2. Install the additional drives needed for the second array and again use the <1> Auto Setup.

***NOTE:*** *If you wish to customize the settings of individual disk arrays (such as block size), you must manually create disk arrays with the Define Array <3> option from the Main Menu.*

## Viewing Drive Assignments

The View Drive Assignments <2> option in the Main Menu displays whether drives are assigned to a disk arrays or are unassigned.

Under the "Assignment" column, drives are labeled with their assigned disk array or shown as "Free" if unassigned. Such "Free" drives can be used for a future array. Unassigned drives are not accessible by the OS. The menu also displays the data transfer mode that relates to speed used by each drive (U5 refers to 100MB/sec transfers, U4 refers to 66MB/sec transfers, etc...)

FastBuild (tm) Utility 1.xx (c) 1995-2000 Promise Technology, Inc.				
[ View Drive Assignments ]				
Channel:ID	Drive Model	Capacity(MB)	Assignment	Mode
1 : Master	QUANTUMCR8.4A	8063	Array 1	U5
1 : Slave	QUANTUMCR8.4A	8063	Free	U5
2 : Master	QUANTUMCR8.4A	8063	Array 1	U5
[ Keys Available ]				
[↑] Up [↓] Down [ESC] Exit Mode (U=UDMA, P=PIO, D=DMA)				

## Manually Creating an Array

The Define Array <3> option from the Main Menu allows users to begin the process of manually defining the drive elements and RAID levels for one or multiple disk arrays attached to this motherboard. Users will commonly create one or two drive arrays with the motherboard, though the motherboard will support a maximum of four arrays<sup>1</sup>.

**NOTE:** For most installations, We recommends the <1> Auto Setup for easy disk array creation.

FastBuild (tm) Utility 1.xx (c) 1995-2000 Promise Technology, Inc.				
[Define Array Menu]				
Array No	RAID Mode	Total Drv	Capacity(MB)	Status
Array 1	Stripe	2	16126	Functional
Array 2	---	---	---	---
Array 3	---	---	---	---
Array 4	---	---	---	---
[ Keys Available ]				
Note: * — Bootable Array				
[↑] Up [↓] Down [ESC] Exit [Enter] Select [Space] Change Boot Drive				

1. To manually create an array from the Define Array Menu, use the arrow keys to highlight the array number you wish to define, and press [Enter] to select.
2. The Define Array Definition Menu will next appear that allows drive assignments to the disk array (see next page).

<sup>1</sup> A user may use a single drive in either striping mode with system. In this rare scenario, the motherboard will create an individual array ID but will offer conventional controller performance, depending on the drive type. At a later time, a second drive can be added to the array and the array re-created to support RAID 1 mirroring.

**Selecting Array Type**

1. Under the Definition section of this menu, highlight the Array # for which you want to assign a RAID level.
2. Use the [Space] key to cycle through two array types: Performance (RAID 0 Striping), Security (RAID 1 Mirroring).

```

FastBuild (tm) Utility 1.xx (c) 1995-2000 Promise Technology, Inc.
[ Define Array Definition Menu ]

Array No   RAID Mode  Total Drv  Capacity(MB)   Status
Array 1     Stripe        2             16126             Functional

Stripe Block: 64 KB
                [ Drive Assignments ]

Channel:ID   Drive Model         Capacity (MB)   Assignment
1 :          MasterQUANTUMCR8.4A  8063             Y
1 :          Slave QUANTUMCR8.4A   8063             N
2 :          MasterQUANTUMCR8.4A   8063             Y

                [ Keys Available ]

[↑] Up [↓] Down  [ESC] Exit  [Space] Select  [Ctrl-Y] Save

```

**Selecting Stripe Block**

For RAID 0 Striped arrays only, you may manually select the "stripe block size." Use the Spacebar to scroll through choices progressing as follows (1, 2, 4, 8, 16 . . . 1024).

The size selected affects how montherboard sends and retrieves data blocks from the drives. You will need to perform your own testing to determine how the data block size is affecting your particular use of the array. In general, a larger block size is better when handling large data transfers (such as in A/V editing or graphics) while a smaller block size is better when handling e-mail and other common server data. The default is 64K.

**Assigning Drive(s) to Array**

1. Under the [ Drive Assignments ] section, highlight a drive using the [↑] Up [↓] keys.
2. With the [Space] bar key, change the Assignable option to "Y" to add the drive to the disk array.

3. Press <Ctrl-Y> to save the disk array information. Depending on the array type selected, the following scenarios will take place:
  - a) If choosing a Striping array, the initial Define Array Menu screen will appear with the arrays defined. From there you may ESC to exit and return to the Main Menu of FastBuild.
  - b) If you selected a Mirroring array for two drives, there is an additional window that appears as described in order to create the array. To do this you will use either two brand new drives, or one drive that contains existing data that you wish to mirror.

### ***Creating A Mirrored Array Using New Drives***

As described in the Drive Assignments Option section above, if you selected a mirroring array and wish to use two new assigned drives, follow the directions here.

1. After assigning new drives to a Mirroring array and saving the information with <Ctrl-Y>, the window below will appear.

Do you want the disk image to be duplicated to another? (Yes/No) Y - Create and Duplicate N - Create Only
---

2. Press "N" for the Create Only option.
3. A window will appear almost immediately confirming that your Security array has been created. Press any key to reboot the system

Array has been created. <Press Any Key to Reboot>
--

### ***Adding Fault Tolerance to an Existing Drive***

This motherboard will create a mirrored array using an existing system drive with data. You must assign the existing drive and another drive of same or larger capacity to the Mirroring array. The BIOS will send the existing data to the new blank drive.



***WARNING:*** Backup any necessary data before proceeding. Failure to follow this accepted PC practice could result in data loss.

***WARNING:*** If you wish to include your current bootable drive using the Windows NT 4.x or Windows 2000 operating system as part of a bootable Mirrored (RAID 1) array on your system, do NOT connect the hard drive to the system controller yet. You MUST install the Windows NT4 or 2000 driver software first (see ***RAID Manual of the TUCD***) to this drive while it is still attached to your existing hard drive controller. For all other Operating Systems, proceed here.

After assigning the drives to a Mirroring array, press <Ctrl-Y> keys to Save your selection. The window below will appear.

```
Do you want the disk image to be duplicated to another? (Yes/No)
Y - Create and Duplicate
N - Create Only
```

1. Press "Y" for the Create and Duplicate option. The window below will appear asking you to select the Source drive to use. FastBuild will copy all data from the Source drive to the Target drive.

```

Source Disk
Channel:ID      Drive Model      Capacity (MB)

Target Disk
Channel:ID      Drive Model      Capacity (MB)

[Please Select A Source Disk]
Channel:ID      Drive Model      Capacity (MB)
1 :Master      QUANTUMCR8.4A   8063
2 :Master      QUANTUMCR8.4A   8063

[↑] Up [↓] [ESC] Exit [Ctrl-Y] Save
```

2. Use the arrow keys to choose which drive contains the existing data to be copied.



**WARNING:** All target drive data will be erased. Make sure you choose the correct drive.

3. Press [Ctrl-Y] keys to Save selection and start duplication. The following confirmation screen will appear.

```
Start to duplicate the image . . .
Do you want to continue? (Yes/No)
Y - Continue N - Abort
```

4. Select "Y" to continue. If you choose "N", you will be returned to step 1.
5. Once "Y" is selected, the following progress screen will appear. The process will take a few minutes.

```
Please Wait While Duplicating The Image
████████████████████████████████████████████████████████████████████████████████
10% Complete
```

6. Once mirroring is complete, the following screen will appear confirming that your Security array has been created. Press any key to reboot the system

Array has been created.  
<Press Any Key to Reboot>

### ***Making a Disk Array Bootable***



***WARNING:*** In order for you to boot from an array on the system, your PC or server must be configured in the CMOS Setup to use the system as a bootable device (versus the onboard controller). This option is not available if the system is being used as a secondary controller.

1. Once you have returned to the Define Array Menu window (below), you will see the array(s) you have created. You now may use the menu to select which previously-defined array will be used as the bootable array.

FastBuild (tm) Utility 1.xx DELL (c) 1995-2000 Promise Technology, Inc.  
[ Define Array Menu ]

Array No	RAID Mode	Total Drv	Capacity(MB)	Status
* Array 1	Stripe	2	13044	Functional

Note: \* — Bootable Array

[↑] Up [↓] Down    [ESC] Exit    [Enter] Select    [Space] Change Boot Drive

2. Highlight the array which you want to boot from using the [↑] Up [↓] Down keys.
3. Press the [Space] bar key.
4. An \* asterisk will appear next to the array number indicating it as bootable. The system will now recognize this array as the first array seen
5. The system will then use this bootable array as the (fixed) boot C: drive.

***NOTE:*** The bootable array must contain your configured operating system.



### ***How Orders Arrays***

During startup, the disk arrays on the motherboard are recognized in this order: 1) The array set to bootable in the FastBuild™ Setup, and 2) the Array number (i.e. Array 0, Array 1...).

This would be involved in determining which drive letters will be assigned to each disk array.

### ***How Saves Array Information***

All disk array data is saved into the reserved sector on each array member. We suggests that users record their disk array information for future reference.

Another feature of the motherboard disk array system is to recognize drive members even if drives are moved between different motherboard connectors(IDE3&IDE4). Since each drive's array data identifies itself to the array, it is possible to move or swap drives without modifying the array setup. This is valuable when adding drives, or during a rebuild.

## Deleting An Array

The Delete Array <4> Menu option allows for deletion of disk array assignments. This is not the same as deleting data from the drives themselves. If you delete an array by accident (and before it has been used again), the array can normally be recovered by defining the array identically as the deleted array.

**WARNING:** *Deleting an existing disk array could result in its data loss. Make sure to record all array information including the array type, the disk members, and stripe block size in case you wish to undo a deletion.*

FastBuild (tm) Utility 1.xx (c) 1995-2000 Promise Technology, Inc. [ Delete Array Menu ]				
Array No	RAID Mode	Total Drv	Capacity(MB)	Status
Array 1	Mirror	2	8063	Functional
Array 2	Stripe	1	8063	Functional
Array 3	Stripe	1	8063	Functional
Array 4	_____	_____	_____	_____
[ Keys Available ]				
[↑] Up [↓] Down		[ESC] Exit	[Del] Delete	

1. To delete an array, highlight the Array you wish to delete and press the [Del] key.
2. The View Array Definition menu will appear (see below) showing which drives are assigned to this array.

FastBuild (tm) Utility 1.xx (c) 1995-2000 Promise Technology, Inc. [ Define Array Menu ]				
Array No	RAID Mode	Total Drv	Capacity(MB)	Status
Array 1	Mirror	2	8063	Functional
Stripe Block: 64 KB				
[ Drive Assignments ]				
Channel:ID	Drive Model	Capacity (MB)	Assignment	
1 : Master	QUANTUMCR8.4A	8063	Y	
2 : Master	QUANTUMCR8.4A	8063	Y	

3. Confirm yes to the following warning message with the <Ctrl-Y> key to continue array deletion:

Are you sure you want to delete this array?  
Press Ctrl-Y to Delete, others to Abort

4. After deleting the array, you should create a new array using Auto Setup or the Define Array menu from the FastBuild Main Menu.

### Rebuilding A Mirrored Array

The Rebuild Array <5> Menu option is necessary to recover from an error in a mirrored disk array. You will receive an error message when booting your system from the BIOS.

**NOTE:** Drives *MUST* be replaced if they contain any physical errors.

Follow these steps BEFORE using the Rebuild Array menu option:

1. On bootup, the system Startup BIOS will display an error message identifying which drive has failed.
2. Press <Ctrl-F> keys to enter FastBuild Main Menu.
3. Select submenu Define Array <3>.
4. Select the failed array and identify the Channel and ID of the failed drive.
5. Power off and physically remove the failed drive.
6. Replace the drive with an identical model.
7. Reboot the system and enter the FastBuild Main Menu.
8. Select the <5> Rebuild Array option. The following screen will appear.

FastBuild (tm) Utility 1.xx (c) 1995-2000 Promise Technology, Inc.				
[ Rebuild Array Menu ]				
Array No	RAID Mode	Total Drv	Capacity(MB)	Status
Array 1	Mirror	2	16126	Critical
Array 2	Stripe	1	8063	Functional
Array 3	Stripe	1	8063	Functional
Array 4	_____	_____	_____	_____

[ Keys Available ]

[↑] Up [↓] Down [ESC] Exit [Enter] Select

9. Highlight the array whose Status is "Critical".
10. Press [Enter]. The following screen will then appear (see next page).

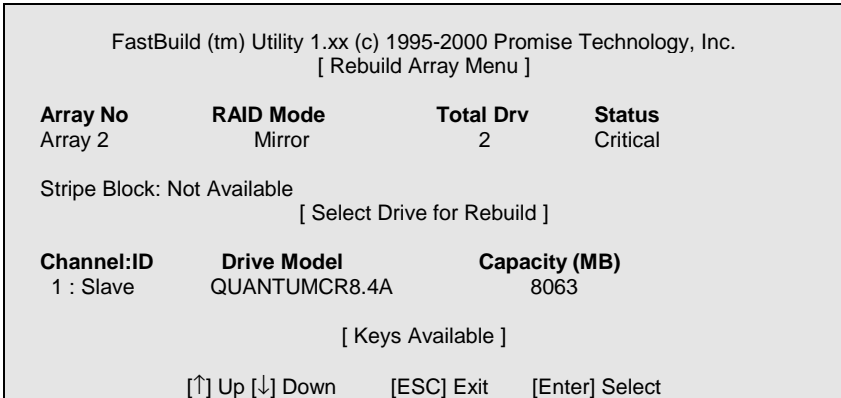

11. Under [Select Drive for Rebuild], highlight the replacement drive.
12. Press [Enter] and confirm that the data will be copied on to the selected drive. All data on the replacement drive will be written over with mirrored information from the array drive. A progress bar will appear as below.

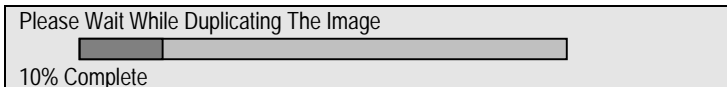

13. Once the rebuild process is complete, the user will be asked to reboot the system.

### Viewing Controller Settings

The Controller Configuration <6> menu selection allows you to enable or disable the BIOS from halting (the default) if it detects an error on boot up. You may also view the system resources (Interrupt and I/O port address) of data channels.

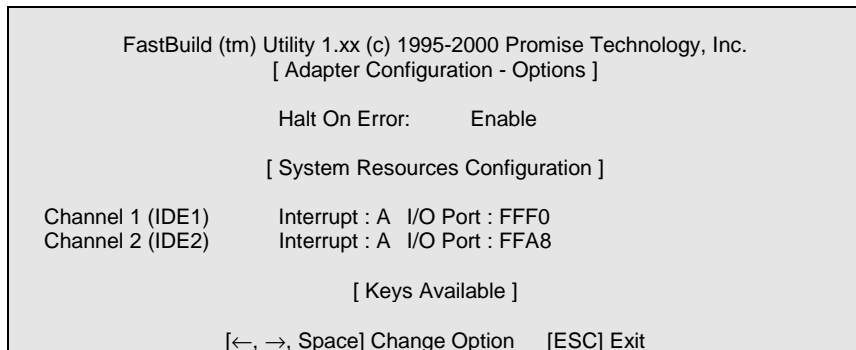

### Halting BIOS On Bootup Errors

The [Adapter Configuration – Options] section allows you to enable or disable The system to Halt operation at the BIOS startup screen should an error be detected. This is the only option that can be changed on this screen.

### *Viewing System Resources*

The [System Resources Configuration] section of this submenu displays the PCI slot interrupt and port address used by the system. The resources used are determined by the Mainboard PCI PnP BIOS for the PCI slot in which the system resides.

In the rare case that there is a resource conflict, refer to the Mainboard BIOS documentation on changes on resources allocated to the system PCI slot.

## Memory Installation

The motherboard has 3 dual inline memory module (DIMM) sockets. The BIOS will automatically detects memory type and size. To install the memory module, just push it vertically into the DIMM Slot .The DIMM module can only fit in one direction due to the two notch. Memory size can vary between sockets.

Install memory in any combination table:

DIMM	168-pin SDRAM DIMM Modules	
DIMM 1	Supports 16 / 32 / 64 / 128 / 256 / 512 MB	X 1 pcs
DIMM 2	Supports 16 / 32 / 64 / 128 / 256 / 512 MB	X 1 pcs
DIMM 3	Supports 16 / 32 / 64 / 128 / 256 / 512 MB	X 1 pcs

★Total System Memory (Max 1.5GB)

## 7ZXR Series Motherboard

---

 Page Index for BIOS Setup	Page
The Main Menu	P.75
Standard CMOS Setup	P.77
BIOS Features Setup	P.80
Chipset Features Setup	P.82
Power Management Setup	P.86
PNP/ PCI Configuration	P.89
Load BIOS Defaults	P.92
Load Setup Defaults	P.93
Integrated Peripherals	P.94
Hardware Monitor & MISC Setup	P.98
Supervisor Password / User Password	P.99
IDE HDD Auto Detection	P.100
Save & Exit Setup	P.101
Exit Without Saving	P.102



## BIOS Setup

BIOS Setup is an overview of the BIOS Setup Interface. The interface allows users to modify the basic system configuration, which is stored in battery-backed CMOS RAM so that it retains the Setup information can be retained when the power is turned off.

### ENTERING SETUP

Power ON the computer and press <Del> immediately will allow you to enter Setup. If unsuccessful, you can restart the system and try again by pressing the "RESET" bottom on the system case. You may also restart by simultaneously pressing <Ctrl> – <Alt>– <Del> keys.

### CONTROL KEYS

<↑>	Move to previous item
<↓>	Move to next item
<←>	Move to the item in the left hand
<→>	Move to the item in the right hand
<Esc>	Main Menu - Quit and not save changes into CMOS Status Page Setup Menu and Option Page Setup Menu - Exit current page and return to Main Menu
<+/PgUp>	Increase the numeric value or make changes
<-/PgDn>	Decrease the numeric value or make changes
<F1>	General help, only for Status Page Setup Menu and Option Page Setup Menu
<F2>	Reserved
<F3>	Reserved
<F4>	Reserved
<F5>	Restore the previous CMOS value from CMOS, only for Option Page Setup Menu
<F6>	Load the default CMOS value from BIOS default table, only for Option Page Setup Menu
<F7>	Load the Setup Defaults.
<F8>	Reserved
<F9>	Reserved
<F10>	Save all the CMOS changes, only for Main Menu

## GETTING HELP

### Main Menu

The on-line description of the highlighted setup function is displayed at the bottom of the screen.

### Status Page Setup Menu / Option Page Setup Menu

Press F1 to pop up a small help window that describes the appropriate keys to use and the possible selections for the highlighted item. To exit the Help Window press <Esc>.

## The Main Menu

Once you enter AMI BIOS CMOS Setup Utility, the Main Menu (Figure 1) will appear on the screen. The Main Menu allows you to select from nine setup functions and two exit choices. Use arrow keys to select among the items and press <Enter> to accept or enter the sub-menu.

AMIBIOS SIMPLE SETUP UTILITY-VERSION 1.24b ( C ) 1999 American Megatrends, Inc. All Rights Reserved	
STANDARD CMOS SETUP	INTEGRATED PERIPHERALS
BIOS FEATURES SETUP	HARDWARE MONITOR & MISC SETUP
CHIPSET FEATURES SETUP	SUPERVISOR PASSWORD
POWER MANAGEMENT SETUP	USER PASSWORD
PNP/PCI CONFIGURATION	IDE HDD AUTO DETECTION
LOAD BIOS DEFAULTS	SAVE & EXIT SETUP
LOAD SETUP DEFAULTS	EXIT WITHOUT SAVING
ESC : Quit      ↑↓←→ : Select Item      (Shift) F2 : Change Color      F5 : Old Values F6 : Load BIOS Defaults      F7: Load Setup Defaults      F10: Save & Exit	
Time, Date, Hard Disk Type, ...	

Figure 1: Main Menu

- **Standard CMOS Setup**

This setup page includes all the adjustable items in standard compatible BIOS.

- **BIOS Features Setup**

This setup page includes all the adjustable items of AMI special enhanced features.

- **Chipset Features Setup**

This setup page includes all the adjustable items of chipset special features.

- **Power Management Setup**

This setup page includes all the adjustable items of Green function features.

- **PnP/PCI Configurations**

This setup page includes all the adjustable configurations of PCI & PnP ISA resources.

- **Load BIOS Defaults**

Load BIOS Defaults option loads preset system parameter values to set the system in its most stable configurations.

- **Load Setup Defaults**

Load Setup Defaults option loads preset system parameter values to set the system in its highest performance configurations.

- **Integrated Peripherals**

This setup page includes all onboard peripherals.

- **Hardware Monitor & MISC Setup**

This setup page is auto detect fan and temperature status.

- **Set Supervisor Password**

Set Change or disable password. It allows you to limit access to the system and/or BIOS setup.

- **Set User Password**

Set Change or disable password. It allows you to limit access to the system.

- **IDE HDD auto detection**

Automatically configure hard disk parameters.

- **Save & Exit Setup**

Save CMOS value settings to CMOS and exit setup.

- **Exit Without Saving**

Abandon all CMOS value changes and exit setup.

## Standard CMOS Setup

The items in Standard CMOS Setup Menu (Figure 2) are divided into 9 categories. Each category includes none, one or more than one setup items. Use the arrows to highlight the item and then use the <PgUp> or <PgDn> keys to select the value in each item.

AMIBIOS SETUP – STANDARD CMOS SETUP ( C ) 1999 American Megatrends, Inc. All Rights Reserved	
Date (mm/dd/yyyy) : Tue Jan 25, 2000 Time (hh/mm/ss) : 10:36:24	
	TYPE SIZE CYLS HEAD PRECOMP LANDZ SECTOR MODE
Pri Master : Auto Pri Slave : Auto Sec Master : Auto Sec Slave : Auto	
Floppy Drive A: 1.44 MB 3 ½ Floppy Drive B: Not Installed	Base Memory : 640 Kb Other Memory: 384 Kb Extended Memory: 30Mb Total Memory: 31Mb
Boot Sector Virus Protection : Disabled	
Month: Jan – Dec Day: 01 – 31 Year: 1990– 2099	ESC : Exit ↑↓ : Select Item PU/PD/+/- : Modify (Shift)F2 : Color

Figure 2: Standard CMOS Setup

- **Date**

The date format is <Week> <Month> <Day>, <Year>.

Week	The week, from Sun to Sat, determined by the BIOS and is display-only
Month	The month, Jan. Through Dec.
Day	The day, from 1 to 31 (or the maximum allowed in the month)
Year	The year, from 1990 through 2099

- **Time**

The times format in <hour> <minute> <second>. The time is calculated base on the 24-hour military-time clock. For example, 1 p.m. is 13:00:00.

- **Primary Master / Slave , Secondary Master / Slave**

The category identifies the type of hard disk from drive C to F that has been installed in the computer. There are two settings: Auto, and Manual. Manual: HDD type is user-definable; Auto will automatically detect HDD type.

Note that the specifications of your drive must match with the drive table. The hard disk will not work properly if you enter improper information for this category.

If you select User Type, related information will be asked to enter to the following items. Enter the information directly from the keyboard and press <Enter>. Such information should be provided in the documentation form your hard disk vendor or the system manufacturer.

CYLS.	Number of cylinders
HEADS	number of heads
PRECOMP	write precomp
LANDZONE	Landing zone
SECTORS	number of sectors

If a hard disk has not been installed select NONE and press <Enter>.

- **Floppy Drive A / Drive B**

The category identifies the type of floppy disk drive A or drive B that has been installed in the computer.

None	No floppy drive installed
360K, 5.25 in.	5.25 inch PC-type standard drive; 360K byte capacity.
1.2M, 5.25 in.	5.25 inch AT-type high-density drive; 1.2M byte capacity (3.5 inch when 3 Mode is Enabled).
720K, 3.5 in.	3.5 inch double-sided drive; 720K byte capacity
1.44M, 3.5 in.	3.5 inch double-sided drive; 1.44M byte capacity.
2.88M, 3.5 in.	3.5 inch double-sided drive; 2.88M byte capacity.

- **Boot Sector Virus Protection**

If it is set to enable, the category will flash on the screen when there is any attempt to write to the boot sector or partition table of the hard disk drive. The system will halt and the following error message will appear in the mean time. You can run anti-virus program to locate the problem.

Enabled	Activate automatically when the system boots up causing a warning message to appear when anything attempts to access the boot sector or hard disk partition table
Disabled	No warning message to appear when anything attempts to access the boot sector or hard disk partition table. <b>(Default Value)</b>

- **Memory**

The category is display-only which is determined by POST (Power On Self Test) of the BIOS.

**Base Memory**

The POST of the BIOS will determine the amount of base (or conventional) memory installed in the system.

The value of the base memory is typically 512 K for systems with 512 K memory installed on the motherboard, or 640 K for systems with 640 K or more memory installed on the motherboard.

**Extended Memory**

The BIOS determines how much extended memory is present during the POST.

This is the amount of memory located above 1 MB in the CPU's memory address map.

**Other Memory**

This refers to the memory located in the 640 K to 1024 K address space. This is memory that can be used for different applications.

DOS uses this area to load device drivers to keep as much base memory free for application programs. Most use for this area is Shadow RAM

## BIOS Features Setup

AMIBIOS SETUP – BIOS FEATURES SETUP	
( C ) 1999 American Megatrends, Inc. All Rights Reserved	
1st Boot Device	Floppy
2nd Boot Device	IDE-0
3rd Boot Device	CDROM
S.M.A.R.T. for Hard Disks	Disabled
BootUp Num-Lock	On
Floppy Drive Seek	Enabled
Password Check	Setup
ESC : Quit                      ↑↓→← : Select Item F1 : Help                        PU/PD+/- : Modify F5 :Old Values                (Shift)F2:Color F6 : Load BIOS Defaults F7 : Load SETUP Defaults	

Figure 3: BIOS Features Setup

- 1st / 2nd / 3rd Boot Device

Floppy	Set your boot device priority to Floppy.
ZIP A: / LS-120	Set your boot device priority to ZIP A: / LS-120.
CDROM	Set your boot device priority to CDROM.
SCSI	Set your boot device priority to SCSI.
NETWORK	Set your boot device priority to NETWORK.
IDE-0-IDE-3	Set your boot device priority to IDE-0-IDE-3.
Disabled	Disable this function.
USB FDD	Set your boot device priority to USB FDD.
ATAPI ZIP C:	Set your boot device priority to ATAPI ZIP C:.
RAID / ATA100	Set your boot device priority to RAID/ATA100.

- **S.M.A.R.T. for Hard Disks**

Enabled	Enabled S.M.A.R.T. Hard for Disks.
Disabled	Disable S.M.A.R.T. Hard for Disks. <b>(Default Value)</b>

- **Boot Up Num-Lock**

On	Keypad is number keys. <b>(Default Value)</b>
Off	Keypad is arrow keys.

- **Floppy Drive Seek**

During POST, BIOS will determine if the floppy disk drive installed is 40 or 80 tracks. 360 type is 40 tracks while 720 , 1.2 and 1.44 are all 80 tracks.

Enabled	BIOS searches for floppy disk drive to determine if it is 40 or 80 tracks. Note that BIOS can not tell from 720, 1.2 or 1.44 drive type as they are all 80 tracks. <b>(Default Value)</b>
Disabled	BIOS will not search for the type of floppy disk drive by track number. Note that there will not be any warning message if the drive installed is 360.

- **Password Check**

Always	The user must enter correct password in order to access the system and/or BIOS Setup.
Setup	The user must enter correct password in order to access the system. <b>(Default value)</b>



## Chipset Features Setup

AMIBIOS SETUP – CHIPSET FEATURES SETUP ( C ) 1999 American Megatrends, Inc. All Rights Reserved			
*****DRAM Timing***			
Top Performance	Disabled	SDRAM Command Drive	24 mA
DRAM Frequency	100MHz	Memory Address Drive	24 mA
SDRAM CAS# Latency	3	CAS# Drive	12 mA
		RAS# Drive	24 mA
AGP Fast Write	Disbaled		
AGP Mode	4X		
AGP Comp. Driving	Auto		
Manual AGP Comp. Driving	DB		
AGP Aperture Size	64MB		
PCI Delay Transaction	Enabled		
USB Controller	Enabled		
USB Legacy Support	Disabled		
USB Port 64/60 Emulation	Disabled		
BIOS Flash Protection	Disabled		
DRAM Drive Strength	Auto	ESC : Quit	↑↓→←: Select Item
MD Bus Strength	High	F1 : Help	PU/PD+/-/: Modify
CAS Bus Strength	High	F5 :Old Values	(Shift)F2:Color
Delay DRAM Read Latch	1.0ns	F6 : Load BIOS Defaults	
Memory Data Drive	8 mA	F7 : Load SETUP Defaults	

Figure 4: Chipset Features Setup

- **Top Performance**

If you wish to maximize the performance of your system, set "Top Performance" to "Enabled".

Disabled	Disable Top Performance. <b>(Default Value)</b>
Enabled	Top Performance Enabled.

- **DRAM Frequency**

100MHz	Set DRAM Frequency to 100MHz. <b>(Default Value)</b>
133MHz	Set DRAM Frequency to 133MHz.

- **SDRAM CAS# Latency**

2	For Fastest SDRAM DIMM module.
3	For Slower SDRAM DIMM module. <b>(Default Value)</b>
Auto	Detect SDRAM CAS# Latency by SPD.

- **AGP Fast Write**

Enabled	Enable this function only if the AGP Card support Fast Write Function. (Enable this function can increase AGP performance).
Disabled	Disable this function. <b>(Default Value)</b>

- **AGP Mode**

4X	Set AGP Mode to 4X. <b>(Default Value)</b>
1X	Set AGP Mode to 1X.
2X	Set AGP Mode to 2X.

- **AGP Comp. Driving**

Auto	Set AGP Comp. Driving to Auto. <b>(Default Value)</b>
Manual	Set AGP Comp. Driving to Manual.

If AGP Comp. Driving is Manual.

Manual AGP Comp. Driving :	00-FF
----------------------------	-------

- **AGP Aperture Size**

4MB	Set AGP Aperture Size to 4MB.
8MB	Set AGP Aperture Size to 8 MB.
16MB	Set AGP Aperture Size to 16 MB.
32MB	Set AGP Aperture Size to 32 MB.
64MB	Set AGP Aperture Size to 64 MB. <b>(Default Value)</b>
128MB	Set AGP Aperture Size to 128 MB.
256MB	Set AGP Aperture Size to 256 MB.

- **PCI Delay Transaction**

Enabled	Enabled Delay Transaction. <b>(Default Value)</b>
Disabled	Disable Delay Transaction.

- **USB Controller**

Enabled	Enable USB Controller. <b>(Default Value)</b>
Disabled	Disable USB Controller.

- **USB Legacy Support**

Keyboard/FDD	Set USB Legacy Support Keyboard / Floppy.
KB/Mouse/FDD	Set USB Legacy Support Keyboard / Mouse / Floppy.
Disabled	Disable USB Legacy Support Function. <b>(Default Value)</b>

- **USB Port 64/60 Emulation**

Enabled	To use USB mouse under Win NT environment, set USB Legacy Support to KB/Mouse/FDD and USB Port 64/60 Emulation to enabled.
Disabled	Disable this Function. <b>(Default Value)</b>

- **BIOS Flash Protection**

Enabled	BIOS Flash Write Protection.
Disabled	Normal. <b>(Default Value)</b>

- **DRAM Drive Strength**

Auto	Set DRAM Drive Strength Auto. <b>(Default Value)</b>
Manual	Set DRAM Drive Strength Manual.

If DRAM Drive Strength is Manual, then you can adjust item below.

- **MD Bus Strength**

High	Set MD Bus Strength High. <b>(Default Value)</b>
Low	Set MD Bus Strength Low.

- **CAS Bus Strength**

High	Set CAS Bus Strength High. <b>(Default Value)</b>
Low	Set CAS Bus Strength Low.

- **Delay DRAM Read Latch**

1.0ns	Set DRAM Read Latch Delay 1.0ns. <b>(Default Value)</b>
1.5ns	Set DRAM Read Latch Delay 1.5ns.
0.5ns	Set DRAM Read Latch Delay 0.5ns.
No delay	Set DRAM Read Latch No delay.

- **Memory Data Drive**

6 mA	Set Memory Data Drive 6 mA.
8 mA	Set Memory Data Drive 8 mA. <b>(Default Value)</b>

- **SDRAM Command Drive**

16 mA	Set SDRAM Command Drive 16 mA.
24 mA	Set SDRAM Command Drive 24 mA. <b>(Default Value)</b>

- **Memory Address Drive**

16 mA	Set Memory Address Drive 16 mA.
24 mA	Set Memory Address Drive 24 mA. <b>(Default Value)</b>

- **CAS# Drive**

8 mA	Set CAS# Drive 8 mA.
12 mA	Set CAS# Drive 12 mA. <b>(Default Value)</b>

- **RAS# Drive**

16 mA	Set RAS# Drive 16 mA.
24 mA	Set RAS# Drive 24 mA. <b>(Default Value)</b>

## Power Management Setup

AMIBIOS SETUP – POWER MANAGEMENT SETUP ( C ) 1999 American Megatrends, Inc. All Rights Reserved			
ACPI Sleep Type	S1/POS	RTC Alarm Date	Every Day
USB Dev Wakeup From S3-S5	Disabled	RTC Alarm Hour	00
Suspend Time Out(Minute)	Disabled	RTC Alarm Minute	00
Display Activity	Ignore	RTC Alarm Second	00
IRQ3	Monitor		
IRQ4	Monitor		
IRQ5	Ignore		
IRQ7	Monitor		
IRQ9	Ignore		
IRQ10	Ignore		
IRQ11	Ignore		
IRQ13	Ignore		
IRQ14	Monitor		
IRQ15	Ignore		
Soft-Off by Power Button	Instant-Off		
System after AC Back	Soft-Off	ESC : Quit	↑↓→←: Select Item
Modem Use IRQ	4	F1 : Help	PU/PD+/-: Modify
Resume On Ring/LAN	Enabled	F5 :Old Values	(Shift)F2:Color
PME Event Wake Up	Enabled	F6 : Load BIOS Defaults	
Resume On RTC Alarm	Disabled	F7 : Load SETUP Defaults	

Figure 5: Power Management Setup

- **ACPI Sleep Type**

S1/POS	Set ACPI sleep type to S1. <b>(Default Value)</b>
S3/STR	Set ACPI sleep type to S3.

- **USB Dev Wakeup From S3-S5**

Enabled	Enable USB Device Wakeup From S3-S5.
Disabled	Disable USB Device Wakeup From S3-S5. <b>(Default Value)</b>

- **Suspend Time Out (Minute.)**

Disabled	Disable Suspend Time Out Function. <b>(Default Value)</b>
1-60	Set the timer to enter Suspend Time Out .

- **Display Activity**

Ignore	Ignore Display Activity. <b>(Default Value)</b>
Monitor	Monitor Display Activity.

- **IRQ 3-IRQ15**

Ignore	Ignore IRQ3 -IRQ15.
Monitor	Monitor IRQ3-IRQ15.

- **Soft-off by Power Button**

Instant-off	Soft switch ON/OFF for POWER ON/OFF. <b>(Default Value)</b>
Delay 4 sec	Soft switch on 4sec for power OFF.

- **System after AC Back Function**

Memory	This function depends on computer status.
Soft-Off	Set System Soft-Off Status. <b>(Default Value)</b>
Full-On	Set System Full-On Status.

- **Modem USE IRQ**

3, 4, <b>(Default Value:4)</b> 5, 7, N/A
--

- **Resume On Ring / LAN**

Disabled	Disable Resume On Ring / LAN.
Enabled	Enable Resume On Ring / LAN. <b>(Default Value)</b>

- **PME Event Wake Up**

Disabled	Disable PME Event Wake Up.
Enabled	Enable PME Event Wake Up. <b>(Default Value)</b>

- **Resume On RTC Alarm**

You can set "Resume On RTC Alarm" item to enabled and key in Data/time to power on system.

Disabled	Disable this function. <b>(Default Value)</b>
Enabled	Enable alarm function to POWER ON system.

If the "Resume On RTC Alarm" is Enabled.

RTC Alarm Date :	Every Day, 1~31
RTC Alarm Hour:	0~23
RTC Alarm Minute :	0~59
RTC Alarm Second :	0~59

## PnP/PCI Configurations

AMIBIOS SETUP – PNP / PCI CONFIGURATION ( C ) 1999 American Megatrends, Inc. All Rights Reserved		
PnP OS Installed	No	
Reset Configuration Data	No	
VGA Boot from	AGP	
PCI AGP Palette Snoop	Disabled	
PCI Slot 1/5 IRQ Priority	: Auto	
PCI Slot 2/6 IRQ Priority	: Auto	
PCI Slot 3 IRQ Priority	: Auto	
PCI Slot 4 IRQ Priority	: Auto	
IRQ 3	PCI/PnP	
IRQ 4	PCI/PnP	
IRQ 5	PCI/PnP	
IRQ 7	PCI/PnP	
IRQ 9	PCI/PnP	
IRQ 10	PCI/PnP	ESC: Quit      ↑↓→←: Select Item
IRQ 11	PCI/PnP	F1 : Help      PU/PD+/-/: Modify
IRQ 14	PCI/PnP	F5 :Old Values (Shift)F2:Color
IRQ 15	PCI/PnP	F6 : Load BIOS Defaults
		F7 : Load SETUP Defaults

Figure 6: PnP/PCI Configuration

- **PnP OS Installed**

Yes	Enable PNP OS Installed function.
No	Disable PNP OS Installed function. <b>(Default Value)</b>

- **Reset Configuration Data**

No	Disable this function. <b>(Default Value)</b>
Yes	Clear PnP information in ESCD & update DMI data.

- **VGA Boot From**

AGP	Primary Graphics Adapter From AGP. <b>(Default Value)</b>
PCI	Primary Graphics Adapter From PCI.



- **PCI Slot 1,5 IRQ Priority**

Auto	The system will reserved a free IRQ for PCI slot 1 & 5 device. <b>(Default Value)</b>
3	The system will reserved IRQ3 for PCI slot 1 & 5 device if no legacy ISA device using IRQ3.
4	The system will reserved IRQ4 for PCI slot 1 & 5 device if no legacy ISA device using IRQ4.
5	The system will reserved IRQ5 for PCI slot 1 & 5 device if no legacy ISA device using IRQ5.
7	The system will reserved IRQ7 for PCI slot 1 & 5 device if no legacy ISA device using IRQ7.
9	The system will reserved IRQ9 for PCI slot 1 & 5 device if no legacy ISA device using IRQ9.
10	The system will reserved IRQ10 for PCI slot 1 & 5 device if no legacy ISA device using IRQ10.
11	The system will reserved IRQ11 for PCI slot 1 & 5 device if no legacy ISA device using IRQ11.

- **PCI Slot 2,6 IRQ Priority**

Auto	The system will reserved a free IRQ for PCI slot 2 & 6 device. <b>(Default Value)</b>
3	The system will reserved IRQ3 for PCI slot 2 & 6 device if no legacy ISA device using IRQ3.
4	The system will reserved IRQ4 for PCI slot 2 & 6 device if no legacy ISA device using IRQ4.
5	The system will reserved IRQ5 for PCI slot 2 & 6 device if no legacy ISA device using IRQ5.
7	The system will reserved IRQ7 for PCI slot 2 & 6 device if no legacy ISA device using IRQ7.
9	The system will reserved IRQ9 for PCI slot 2 & 6 device if no legacy ISA device using IRQ9.
10	The system will reserved IRQ10 for PCI slot 2 & 6 device if no legacy ISA device using IRQ10.
11	The system will reserved IRQ11 for PCI slot 2 & 6 device if no legacy ISA device using IRQ11.

- **PCI Slot 3 / 4 IRQ Priority**

Auto	The system will reserved a free IRQ for PCI slot 3 / 4 device. <b>(Default Value)</b>
3	The system will reserved IRQ3 for PCI slot 3 / 4 device if no legacy ISA device using IRQ3.
4	The system will reserved IRQ for PCI slot 3 / 4 device if no legacy ISA device using IRQ4.
5	The system will reserved IRQ5 for PCI slot 3 / 4 device if no legacy ISA device using IRQ5.
7	The system will reserved IRQ7 for PCI slot 3 / 4 device if no legacy ISA device using IRQ7.
9	The system will reserved IRQ9 for PCI slot 3 / 4 device if no legacy ISA device using IRQ9.
10	The system will reserved IRQ10 for PCI slot 3 / 4 device if no legacy ISA device using IRQ10.
11	The system will reserved IRQ11 for PCI slot 3 / 4 device if no legacy ISA device using IRQ11.

- **PCI/VGA Palette Snoop**

Enabled	For having Video Card on ISA Bus and VGA Card on PCI Bus.
Disabled	For VGA Card only. <b>(Default Value)</b>

- **DMA Channel (0,1,3,5,6,7)**

ISA/EISA	The resource is used by Legacy ISA device.
PnP	The resource is used by PnP device.

- **IRQ (3,4,5,7,9,10,11,14,15)**

ISA/EISA	The resource is used by Legacy ISA device.
PCI/PnP	The resource is used by PCI/ PnP device.

## Load BIOS Defaults

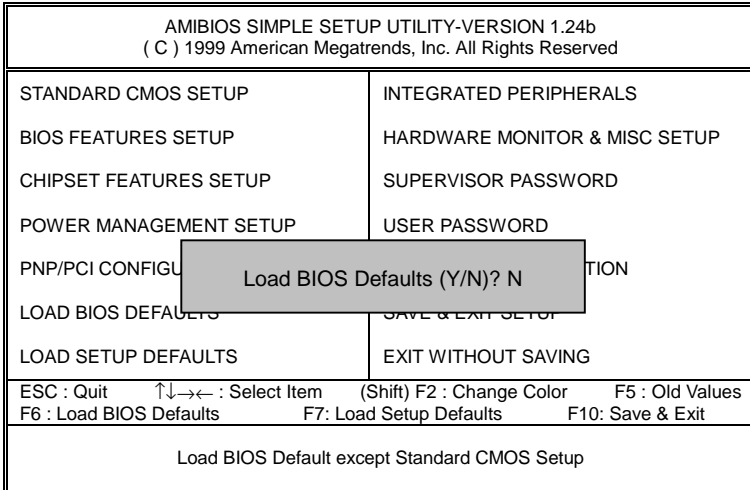

Figure 7: Load BIOS Defaults

- **Load BIOS Defaults**

Load BIOS defaults contain the most appropriate system parameter values of to configure the system to achieve maximum stability.

## Load Setup Defaults

AMIBIOS SIMPLE SETUP UTILITY-VERSION 1.24b ( C ) 1999 American Megatrends, Inc. All Rights Reserved	
STANDARD CMOS SETUP	INTEGRATED PERIPHERALS
BIOS FEATURES SETUP	HARDWARE MONITOR & MISC SETUP
CHIPSET FEATURES SETUP	SUPERVISOR PASSWORD
POWER MANAGEMENT SETUP	USER PASSWORD
PNP/PCI CONFIGURATION	LOAD SETUP Defaults (Y/N)? N
LOAD BIOS DEFAULTS	SAVE & EXIT SETUP
LOAD SETUP DEFAULTS	EXIT WITHOUT SAVING
ESC : Quit    ↑↓→← : Select Item    (Shift) F2 : Change Color    F5 : Old Values F6 : Load BIOS Defaults    F7: Load Setup Defaults    F10: Save & Exit	
Load Setup Default except Standard CMOS Setup	

Figure 8: Load Setup Defaults

- **Load Setup Defaults**

Load Setup defaults contain the most appropriate system parameter values to configure the system to achieve maximum performance.

## Integrated Peripherals

AMIBIOS SETUP – INTEGRATED PERIPHERALS		( C ) 1999 American Megatrends, Inc. All Rights Reserved	
OnBoard IDE	Both		
OnBoard Serial Port A	Auto		
OnBoard Serial Port B	Auto		
Serial PortB Mode	Normal		
*Duplex Mode	N/A		
OnBoard Parallel Port	Auto		
Parallel Port Mode	ECP		
Parallel Port DMA	Auto		
Parallel Port IRQ	Auto		
AC97 Audio	Auto		
MC97 Modem	Auto		
◆ OnBoard Legacy Audio	Enabled		
◆ Sound Blaster	Disabled		
◆ SB I/O Base Address	220h-22Fh		
◆ SB IRQ Select	5	ESC: Quit	↑↓→←: Select Item
◆ SB DMA Select	1	F1 : Help	PU/PD+/-/: Modify
◆ MPU-401	Disabled	F5 :Old Values	(Shift)F2:Color
◆ MPU-401 I/O Address	330h-333h	F6 : Load BIOS Defaults	
◆ Game Port(200h-207h)	Enabled	F7 : Load SETUP Defaults	

Figure 9: Integrated Peripherals

\*This items will be available when “Serial PortB Mode” is set to IrDA or ASK IR.

◆ These eight items will be shown when there are only AC'97 CODEC sound.

- OnBoard IDE

Disabled	Disable OnBoard IDE.
Both	Both Primary & Secondary IDE channel will be enabled. <b>(Default Value)</b>
Primary	Only Primary IDE channel is enable.
Secondary	Only Secondary IDE channel is enable.

- On Board Serial Port A

Auto	BIOS will automatically setup the port A address. <b>(Default Value)</b>
3F8/COM1	Enable on Board Serial port A and address to 3F8.
2F8/COM2	Enable on Board Serial port A and address to 2F8.
3E8/COM3	Enable on Board Serial port A and address to 3E8.
2E8/COM4	Enable on Board Serial port A and address to 2E8.
Disabled	Disable on Board Serial port A.

- **On Board Serial Port B**

Auto	BIOS will automatically setup the port B address. <b>(Default Value)</b>
3F8/COM1	Enable on Board Serial port B and address to 3F8.
2F8/COM2	Enable on Board Serial port B and address to 2F8.
3E8/COM3	Enable on Board Serial port B and address to 3E8.
2E8/COM4	Enable on Board Serial port B and address to 2E8.
Disabled	Disable on Board Serial port B.

- **Serial Port B Mode**

Normal	Normal operation. <b>(Default Value)</b>
IrDA	Onboard I/O chip supports IRDA
ASK IR	Onboard I/O chip supports ASK IR.

- **Duplex Mode**

Half Duplex	IR Function Duplex Half.
N/A	Disable this function. <b>(Default Value)</b>
Full Duplex	IR Function Duplex Full.

- **On Board Parallel port**

378	Enable On Board LPT port and address to 378.
278	Enable On Board LPT port and address to 278.
3BC	Enable On Board LPT port and address to 3BC.
Auto	Set On Board LPT port to Auto. <b>(Default Value)</b>
Disabled	Disable On Board LPT port.

- **Parallel Port Mode**

EPP	Using Parallel port as Enhanced Parallel Port.
ECP	Using Parallel port as Extended Capabilities Port. <b>(Default Value)</b>
Normal	Normal Operation.
EPP+ECP	Using Parallel port as Enhanced Parallel Port & Extended Capabilities Port.

- **Parallel Port DMA**

Auto	Set Auto to parallel port mode DMA Channel. <b>(Default Value)</b>
3	Set Parallel Port DMA to 3.
1	Set Parallel Port DMA to 1.
0	Set Parallel Port DMA to 0.

- **Parallel Port IRQ**

7	Set Parallel Port IRQ to 7.
Auto	Set Auto to parallel Port IRQ DMA Channel. <b>(Default Value)</b>
5	Set Parallel Port IRQ to 5.

- **AC'97 Audio**

Auto	Enabled On Board AC'97 Audio. <b>(Default Value)</b>
Disabled	Disable On Board AC'97 Audio.

- **MC'97 Modem**

Auto	Enable On Board MC'97 Modem. <b>(Default Value)</b>
Disabled	Disable On Board MC'97 Modem.

- **OnBoard Legacy Audio**

Enabled	Enable OnBoard Legacy Audio. <b>(Default Value)</b>
Disabled	Disable OnBoard Legacy Audio.

- **Sound Blaster**

Enabled	Enable Sound Blaster.
Disabled	Disable Sound Blaster. <b>(Default Value)</b>

- **SB I/O Base Address**

220h-22Fh	Set SB I/O Base Address to 220h-22Fh. <b>(Default Value)</b>
280h-28Fh	Set SB I/O Base Address to 280h-28Fh.
260h-26Fh	Set SB I/O Base Address to 260h-26Fh.
240h-24Fh	Set SB I/O Base Address to 240h-24Fh.

- **SB IRQ Select**

IRQ 5 / 7 / 9 / 10. <b>(Default Value: 5)</b>
---

- **SB DMA Select**

DMA 0 / 1 / 2 / 3. <b>(Default Value: 1)</b>
--

- **MPU-401**

Enabled	Enable MPU-401.
Disabled	Disable MPU-401. <b>(Default Value)</b>

Ps. When Force Feedback joystick is used, MPU-401 needs to be Enable.

- **MPU-401 I/O Address**

330h-333h	Set MPU-401 I/O Address to 330h-333h. <b>(Default Value)</b>
300h-303h	Set MPU-401 I/O Address to 300h-303h.
310h-313h	Set MPU-401 I/O Address to 310h-313h.
320h-323h	Set MPU-401 I/O Address to 320h-323h.

- **Game Port (200h-207h)**

Disabled	Disable Game Port (200h-207h).
Enabled	Enable Game Port (200h-207h). <b>(Default Value)</b>



## Hardware Monitor

AMIBIOS SETUP – HARDWARE MONITOR & MISC SETUP	
( C ) 1999 American Megatrends, Inc. All Rights Reserved	
Front Side Bus Clock (MHz)	By Jumper
CPU Temperature	32°C/89°F
System Temperature	32°C/89°F
CPU Fan Speed	7123 RPM
System Fan Speed	0 RPM
Vcore	1.76 V
Vdd	3.33 V
Vcc3	3.27 V
+5.000V	4.97 V
+12.000V	12.18 V
ESC: Quit                      ↑↓→←: Select Item F1 : Help                        PU/PD+/-: Modify F5 :Old Values (Shift)F2:Color F6 : Load BIOS Defaults F7 : Load Setup Defaults	

Figure 10: Hardware Monitor

- Front Side Bus Clock (MHz)

By Jumper	When set "By Jumper", system clock speed will depend on DIP Switch (SW1) setting. <b>(Default Value)</b>
100~150MHz	For CPU with 100MHz FSB, you can set "Front Side Bus Clock" to100MHz~120MHz. For CPU with 133MHz FSB, you can set "Front Side Bus Clock" to133MHz~150MHz.

- CPU Temperature (°C / °F)

Detect CPU Temperature automatically.

- System Temperature (°C / °F)

Detect System Temperature automatically.

- CPU Fan / System Fan Speed

Detect CPU Fan / System Fan speed status automatically.

- Current Voltage (V) Vcore / Vdd / Vcc3 / +5V / +12V

Detect system's voltage status automatically.

## Set Supervisor / User Password

When you select this function, the following message will appear at the center of the screen to assist you in creating a password.

AMIBIOS SIMPLE SETUP UTILITY-VERSION 1.24b ( C ) 1999 American Megatrends, Inc. All Rights Reserved	
STANDARD CMOS SETUP	INTEGRATED PERIPHERALS
BIOS FEATURES SETUP	HARDWARE MONITOR & MISC SETUP
CHIPSET FEATURES SETUP	SUPERVISOR PASSWORD
POWER MANAGEMENT SETUP	USER PASSWORD
PNP/PCI CONFIGURATION	ON
LOAD BIOS DEFAULTS	SAVE & EXIT SETUP
LOAD SETUP DEFAULTS	EXIT WITHOUT SAVING
ESC : Quit    ↑↓→← : Select Item    (Shift) F2 : Change Color    F5 : Old Values F6 : Load BIOS Defaults    F7: Load Setup Defaults    F10: Save & Exit	
Enter new supervisor password:	
Chang /Set /Disabled Password	

Figure 11: Password Setting

Type the password, up to six characters, and press <Enter>. You will be asked to confirm the password. Type the password again and press <Enter>. You may also press <Esc> to abort the selection and not enter a password.

To disable password, just press <Enter> when you are prompted to enter password. A message **"PASSWORD DISABLED"** will appear to confirm the password being disabled. Once the password is disabled, the system will boot and you can enter Setup freely.

The BIOS Setup program allows you to specify two separate passwords: a **SUPERVISOR PASSWORD** and a **USER PASSWORD**. When disabled, anyone may access all BIOS Setup program function. When enabled, the Supervisor password is required for entering the BIOS Setup program and having full configuration fields, the User password is required to access only basic items.

If you select **"Always"** at **"Password Check"** in BIOS Features Setup Menu, you will be prompted for the password every time the system is rebooted or any time you try to enter Setup Menu.

If you select **"Setup"** at **"Password Check"** in BIOS Features Setup Menu, you will be prompted only when you try to enter Setup.

## IDE HDD AUTO Detection

AMIBIOS SETUP – STANDARD CMOS SETUP ( C ) 1999 American Megatrends, Inc. All Rights Reserved							
Date (mm/dd/yyyy) : Tue Jan 25, 2000							
Time (hh/mm/ss) : 10:36:24							
TYPE	SIZE	CYLS	HEAD	PRECOMP	LANDZ	SECTOR	MODE
Pri Master : Not Installed							
Pri Slave : Not Installed							
Sec Master : Not Installed							
Sec Slave : Not Installed							
Floppy Drive A: 1.44 MB 3 ½				Base Memory : 640 Kb			
Floppy Drive B: Not Installed				Other Memory: 384 Kb			
				Extended Memory: 31Mb			
Boot Sector Virus Protection : Disabled				Total Memory: 32Mb			
Month: Jan – Dec				ESC : Exit			
Day: 01 – 31				↑↓ : Select Item			
Year: 1990– 2099				PU/PD/+/- : Modify			
				(Shift)F2 : Color			

Figure 12: IDE HDD Auto Detection

Type "Y" will accept the H.D.D. parameter reported by BIOS.

Type "N" will keep the old H.D.D. parameter setup. If the hard disk cylinder number is over 1024, then the user can select LBA mode or LARGER mode for DOS partition larger than 528 MB.

## Save & Exit Setup

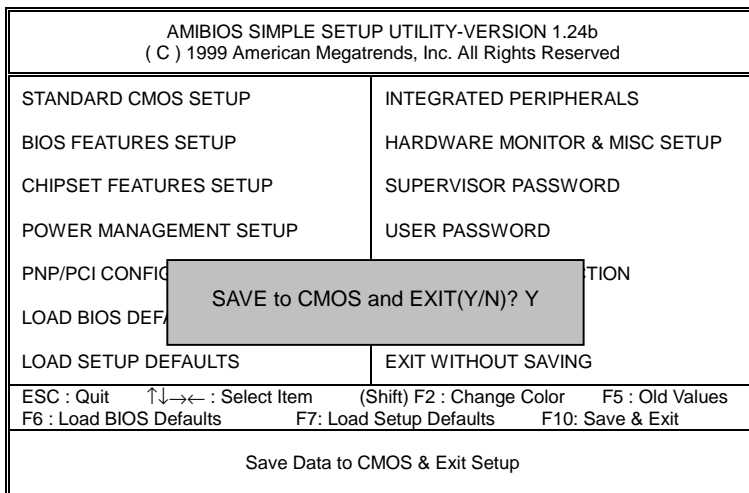

Figure 13: Save & Exit Setup

Type "Y" will quit the Setup Utility and save the user setup value to RTC CMOS.

Type "N" will return to Setup Utility.

## Exit Without Saving

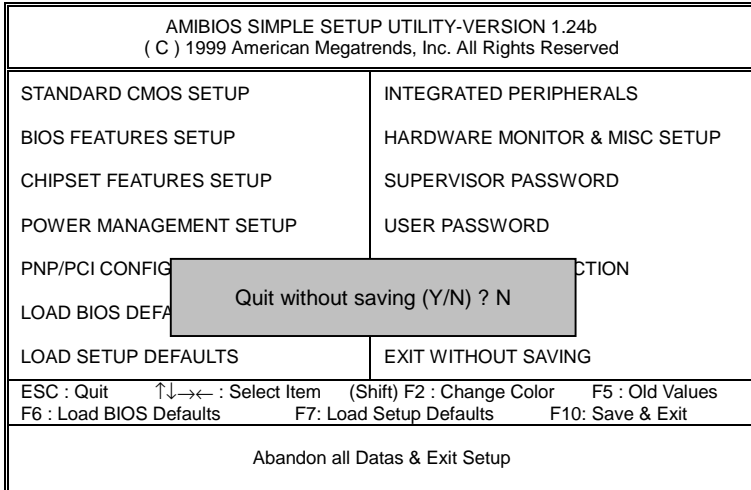

Figure 14: Exit Without Saving

Type "Y" will quit the Setup Utility without saving to RTC CMOS.

Type "N" will return to Setup Utility.

## Appendix

### Appendix A : VIA KT133 Chipsets Driver Installation

#### A.VIA 4 in 1 Service Pack Utility:

Insert the support CD that came with your motherboard into your CD-ROM driver or double –click the CD driver icon in My Computer to bring up the screen.

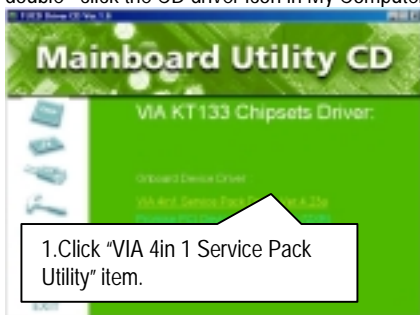

(1)

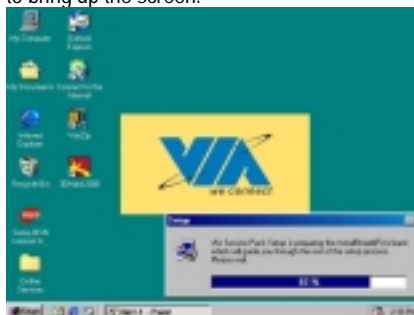

(2)

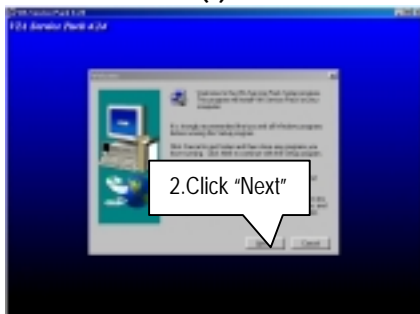

(3)

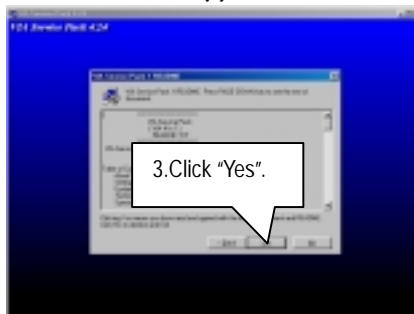

(4)

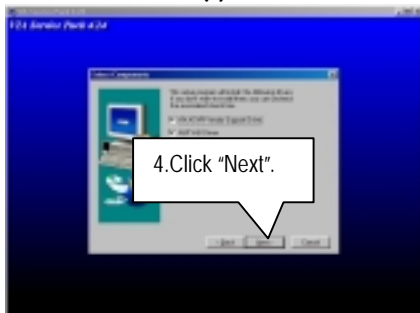

(5)

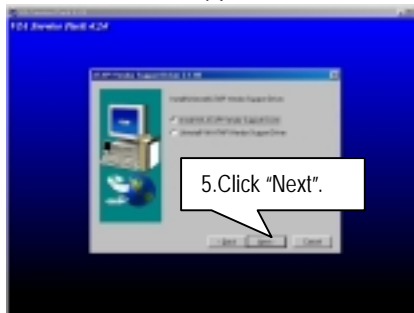

(6)

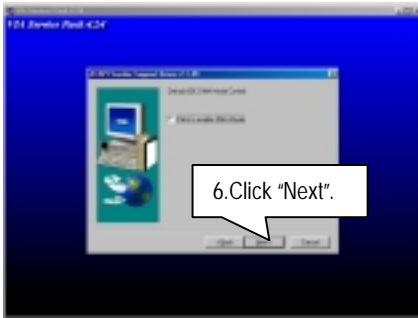

(7)

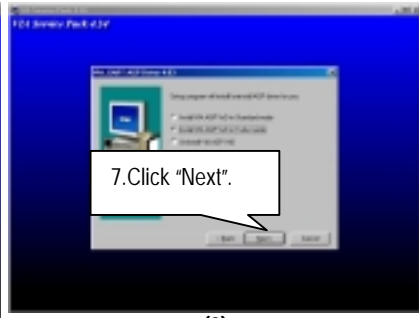

(8)

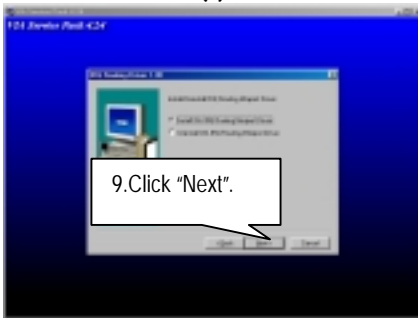

(9)



(10)

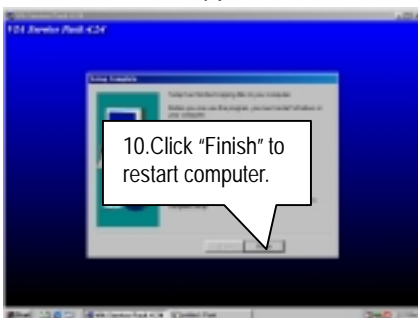

## Appendix B: Creative Sound Driver Installation

Insert the support CD that came with your motherboard into your CD-ROM driver or double-click the CD driver icon in My Computer to bring up the screen.

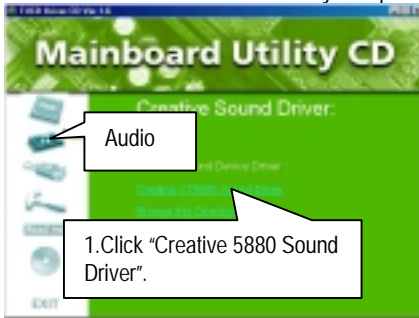

(1)

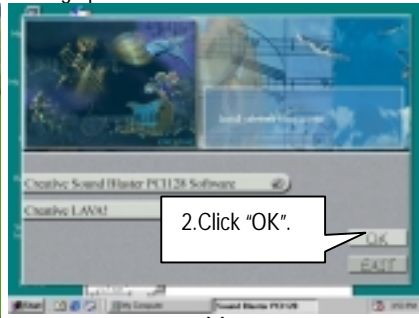

(2)

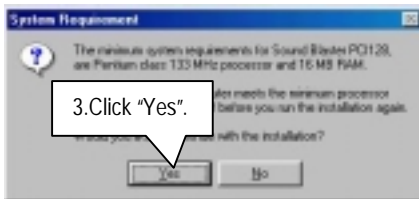

(3)

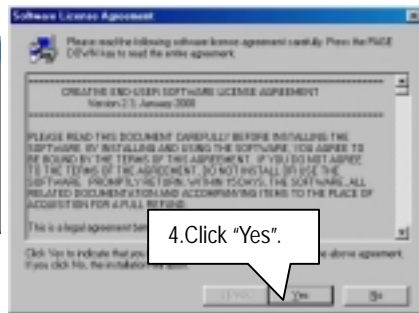

(4)

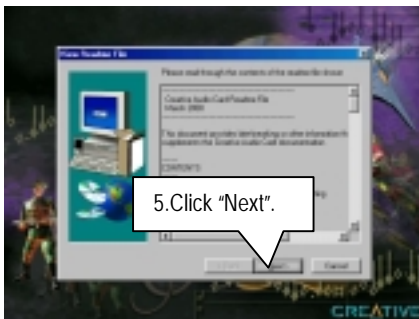

(5)

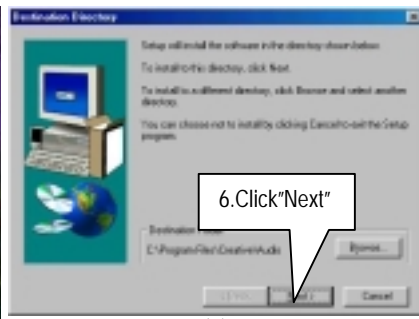

(6)



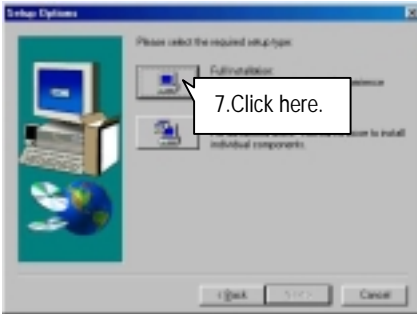

(7)

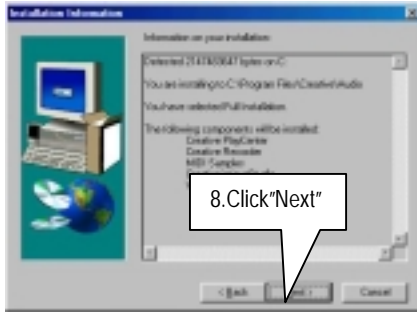

(8)

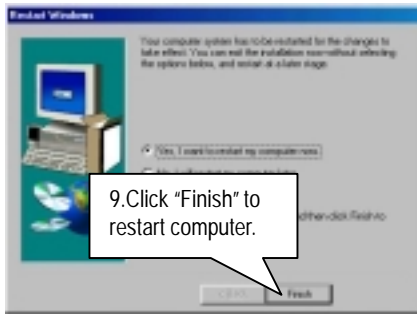
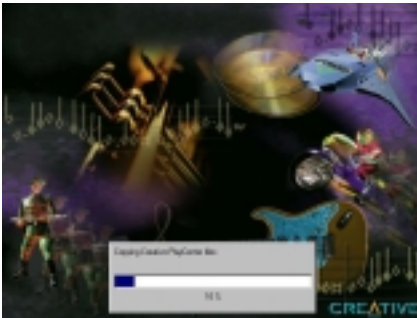

## Appendix C: Promise PCI Device Installation (Optional)

### A. Promise ATA100 Driver Installation:

Insert the support CD that came with your motherboard into your CD-ROM driver or double-click the CD driver icon in My Computer to bring up the screen.



(1)

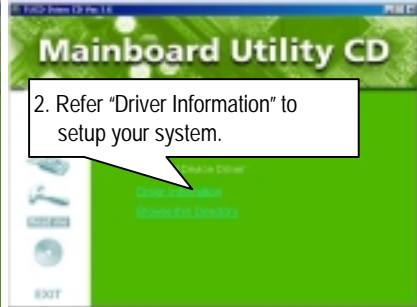

(2)

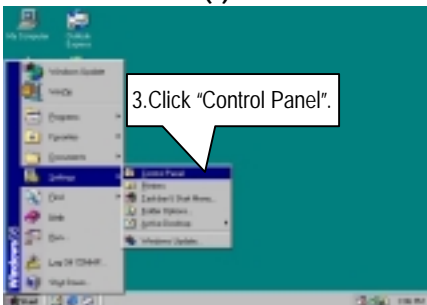

(3)

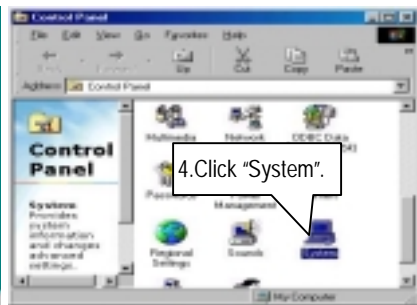

(4)

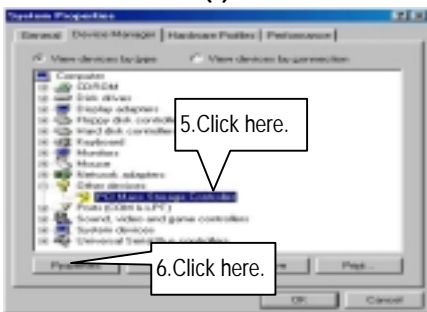

(5)

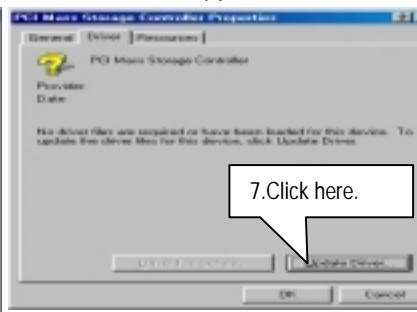

(6)

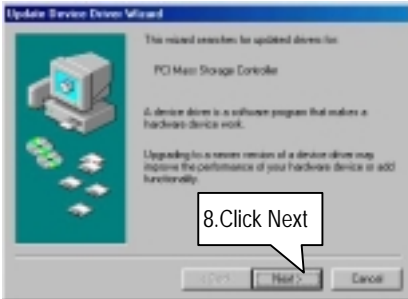

(7)

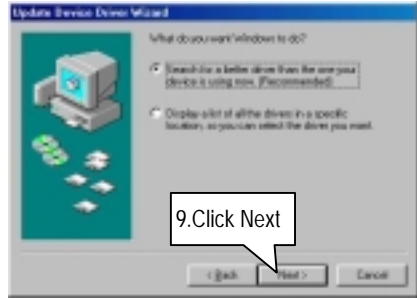

(8)

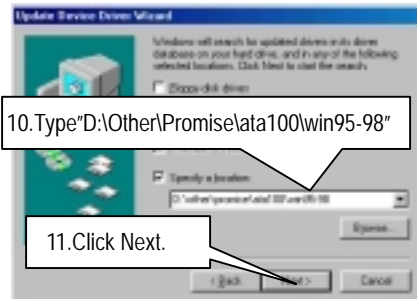

(9)

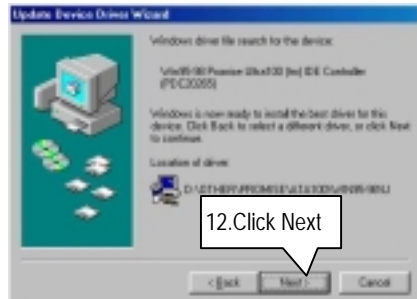

(10)

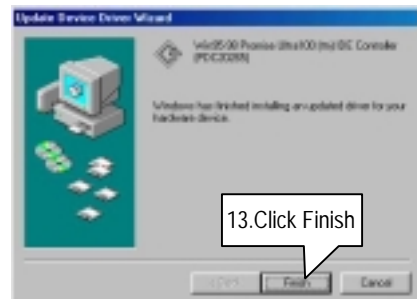

(11)

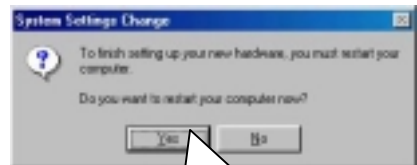

(12)

### B. FastTrak Utility Installation:

Insert the support CD that came with your motherboard into your CD-ROM driver or double –click the CD driver icon in My Computer to bring up the screen.



(1)



(2)



(3)



(4)

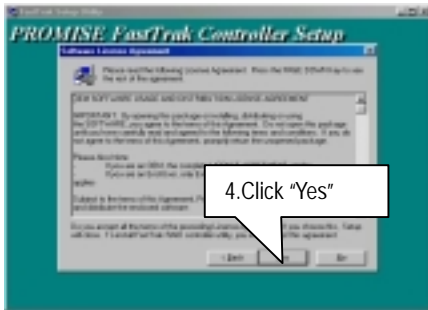

(3)



(4)



(7)



(8)



(9)



(10)



(11)



(12)

### C. Promise RAID Driver Installation:

Insert the support CD that came with your motherboard into your CD-ROM driver or double-click the CD driver icon in My Computer to bring up the screen.



If you want to realize the setup information in detail, please refer to the “driver information” for setting your system completely.

## Appendix D: BIOS Flash Procedure

BIOS update procedure:

If your OS is Win9X, we recommend that you used Gigabyte @BIOS Program to flash BIOS.

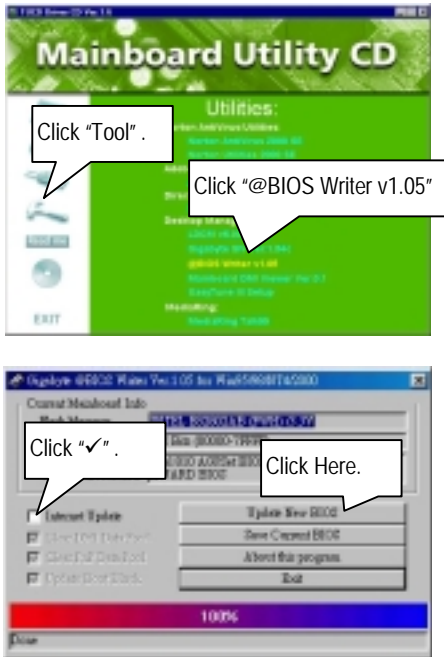

Methods and steps :

### I. Update BIOS through Internet

- a. Click "Internet Update" icon
- b. Click "Update New BIOS" icon
- c. Select @BIOS sever ("Gigabyte @BIOS sever 1 in Taiwan" and "Gigabyte @BIOS sever 2 in Taiwan" are available for now, the others will be completed soon)
- d. Select the exact model name on your motherboard
- e. System will automatically download and update the BIOS.

### II. Update BIOS **NOT** through Internet :

- a. **Do not** click "Internet Update" icon
- b. Click "Update New BIOS"
- c. Please select "All Files" in dialog box while opening the old file.
- d. Please search for BIOS unzip file, downloading from internet or any other methods (such as: 7ZXR.F1).
- e. Complete update process following the instruction.

### III. Save BIOS

In the very beginning, there is "Save Current BIOS" icon shown in dialog box. It means to save the current BIOS version.

### IV. Check out supported motherboard and Flash ROM :

In the very beginning, there is "About this program" icon shown in dialog box. It can help you check out which kind of motherboard and which brand of Flash ROM are supported.

### Note :

- a. In method I, if it shows two or more motherboard's model names to be selected, please make sure your motherboard's model name again. Selecting name will cause the system unbooted.
- b. In method II, be sure that motherboard's model name in BIOS unzip file are the same as your motherboard's. Otherwise, your system won't boot.
- c. In method I, if the BIOS file you need cannot be found in @BIOS server, please go onto Gigabyte's web site for downloading and updating it according to method II.
- d. Please note that any intercorruption during updating will cause system unbooted



---

Or else you can select flash BIOS in DOS mode.

● Please check your **BIOS vendor (AMI or AWARD)**, your **motherboard name** and **PCB version** on the motherboard.

1. Format a bootable system floppy diskette by the command "**format a:/s**" in command mode.
2. Visit the Gigabyte website at [http:// www.gigabyte.com.tw](http://www.gigabyte.com.tw) ,Select the BIOS file you need and download it to your bootable floppy diskette.
3. Insert the bootable diskette containing the BIOS file into the floppy diskette driver.
4. Assuming that the floppy diskette driver is A, reboot the system by using the A: driver. At the A: > prompt, run the BIOS upgraded file by executing the Flash BIOS utility and the BIOS file with its appropriate extension.

Example: *(AMI tool) (Where TZXR.f1 is name of the BIOS file name)*

```
A:>flashxxx.exe TZXR.f1 ↵
```

Example: *(Award tool) (Where TZXR.f1 is name of the BIOS file name)*

```
A:>wdfflash.exe TZXR.f1 ↵
```

5. Upon pressing the <Enter> key, a flash memory writer menu will appear on screen. Enter the new BIOS file name with its extension filename into the text box after file name to program.
6. If you want to save the old BIOS file(perform as soon as system is operational, this is recommended), select Y to **DO YOU WANT TO SAVE BIOS**, then type the old BIOS filename and the extension after filename to save: This option allows you to copy the contents of the flash memory chip onto a diskette, giving you a backup copy of the original motherboard BIOS in case you need to re-install it. Select N to **DO YOU WANT TO SAVE BIOS**, if you don't want to save the old BIOS file.
7. After the decision to save the old BIOS file or not is made, select Y to **ARE YOU SURE TO PROGRAM** when the next menu appear; wait until a message showing Power Off or Reset the system appears. Then turn off your system.
8. Remove the diskette and restart your system.
9. Hold down <Delete> key to enter BIOS setup. You must select "Load Setup BIOS Default" to activate the new BIOS, then you may set other item from the main menu.

## Appendix E: Acronyms

Acronyms	Meaning
ACPI	Advanced Configuration and Power Interface
APM	Advanced Power Management
AGP	Accelerated Graphics Port
AMR	Audio Modem Riser
ACR	Advanced Communication Riser
BIOS	Basic Input / Output System
CPU	Central Processing Unit
CMOS	Complementary Metal Oxide Semiconductor
CRIMM	Continuity RIMM
CNR	Communication and Networking Riser
DMA	Direct Memory Access
DMI	Desktop Management Interface
DIMM	Dual Inline Memory Module
DRM	Dual Retention Mechanism
DRAM	Dynamic Random Access Memory
DDR	Double Data Rate
ECP	Extended Capabilities Port
ESCD	Extended System Configuration Data
ECC	Error Checking and Correcting
EMC	Electromagnetic Compatibility
EPP	Enhanced Parallel Port
ESD	Electrostatic Discharge
FDD	Floppy Disk Device
HDD	Hard Disk Device
IDE	Integrated Dual Channel Enhanced
IRQ	Interrupt Request
I/O	Input / Output
IOAPIC	Input Output Advanced Programmable Input Controller
ISA	Industry Standard Architecture
LAN	Local Area Network
LBA	Logical Block Addressing
LED	Light Emitting Diode
MHz	Megahertz
MIDI	Musical Interface Digital Interface
MTH	Memory Translator Hub
MPT	Memory Protocol Translator
NIC	Network Interface Card
OS	Operating System

To be continued...

---

Acronyms	Meaning
OEM	Original Equipment Manufacturer
PAC	PCI A.G.P. Controller
POST	Power-On Self Test
PCI	Peripheral Component Interconnect
RIMM	Rambus in-line Memory Module
SCI	Special Circumstance Instructions
SECC	Single Edge Contact Cartridge
SRAM	Static Random Access Memory
SMP	Symmetric Multi-Processing
SMI	System Management Interrupt
USB	Universal Serial Bus
VID	Voltage ID