

FCC Compliance Statement:

<p>DECLARATION OF CONFORMITY Per FCC Part 2 Section 2.107(a)</p> <p>FCC</p> <p>Responsible Party Name: G.B.T. INC. Address: 18305 Valley Blvd., Suite 618 LA Puente, CA 91744 Phone/Fax No: (818) 854-9338 / (818) 854-9339</p> <p>hereby declares that the product Product Name: Mother Board Model Number: GA-72MMHC</p> <p>Conforms to the following specifications: FCC Part 15, Subpart B, Section 15.107(a) and Section 15.109(a), Class B Digital Device</p> <p>Supplementary Information: This device complies with part 15 of the FCC Rules. Operation is subject to the following two conditions: (1) This device may not cause harmful interference and (2) this device must accept any interference received, including that may cause undesired operation.</p> <p>Representative Person's Name: <u>ERIC LU</u> Signature: <u>Eric Lu</u> Date: <u>Oct. 24, 2001</u></p>

This equipment has been tested and found to comply with limits for a Class B digital device, pursuant to Part 15 of the FCC rules. These limits are designed to provide reasonable protection against harmful interference in residential installations. This equipment generates, uses, and can radiate radio frequency energy, and if not installed and used in accordance with the instructions, may cause harmful interference to radio communications. However, there is no guarantee that interference will not occur in a particular installation. If this equipment does cause interference to radio or television equipment reception, which can be

determined by turning the equipment off and on, the user is encouraged to try to correct the interference by one or more of the following measures:

- Reorient or relocate the receiving antenna
- Move the equipment away from the receiver
- Plug the equipment into an outlet on a circuit different from that to which the receiver is connected
- Consult the dealer or an experienced radio/television technician for additional suggestions

You are cautioned that any change or modifications to the equipment not expressly approve by the party responsible for compliance could void Your authority to operate such equipment.

This device complies with Part 15 of the FCC Rules. Operation is subjected to the following two conditions 1) this device may not cause harmful interference and 2) this device must accept any interference received, including interference that may cause undesired operation.

Declaration of Conformity

We, Manufacturer/Importer
(full address)

G.B.T. Technology Trading GmbH
Ausschlager Weg 41, 1F, 20537 Hamburg, Germany

declare that the product
(description of the apparatus, system, installation to which it refers)

Mother Board
GA-7ZMMHC

is in conformity with
(reference to the specification under which conformity is declared)
in accordance with 89/336 EEC-EMC Directive

- | | | | |
|---|--|--|---|
| <input type="checkbox"/> EN 55011 | Limits and methods of measurement of radio disturbance characteristics of industrial, scientific and medical (ISM high frequency equipment | <input type="checkbox"/> EN 61000-3-2* | Disturbances in supply systems caused by household appliances and similar electrical equipment "Harmonics" |
| <input type="checkbox"/> EN55013 | Limits and methods of measurement of radio disturbance characteristics of broadcast receivers and associated equipment | <input checked="" type="checkbox"/> EN60555-2 | |
| <input type="checkbox"/> EN 55014 | Limits and methods of measurement of radio disturbance characteristics of household electrical appliances, portable tools and similar electrical apparatus | <input checked="" type="checkbox"/> EN60555-3 | Disturbances in supply systems caused by household appliances and similar electrical equipment "Voltage fluctuations" |
| <input type="checkbox"/> EN 55015 | Limits and methods of measurement of radio disturbance characteristics of fluorescent lamps and luminaries | <input checked="" type="checkbox"/> EN 50081-1 | Generic emission standard Part 1: Residual, commercial and light industry |
| <input type="checkbox"/> EN 55020 | Immunity from radio interference of broadcast receivers and associated equipment | <input checked="" type="checkbox"/> EN 50082-1 | Generic immunity standard Part 1: Residual, commercial and light industry |
| <input checked="" type="checkbox"/> EN 55022 | Limits and methods of measurement of radio disturbance characteristics of information technology equipment | <input type="checkbox"/> EN 55081-2 | Generic emission standard Part 2: Industrial environment |
| <input type="checkbox"/> DIN VDE 0855
<input type="checkbox"/> part 10
<input type="checkbox"/> part 12 | Cabled distribution systems; Equipment for receiving and/or distribution from sound and television signals | <input type="checkbox"/> EN 55082-2 | Generic immunity standard Part 2: Industrial environment |
| <input checked="" type="checkbox"/> CE marking | | <input type="checkbox"/> ENV 55104 | Immunity requirements for household appliances tools and similar apparatus |
| | | <input type="checkbox"/> EN 50091- 2 | EMC requirements for uninterruptible power systems (UPS) |



(EC conformity marking)

The manufacturer also declares the conformity of above mentioned product with the actual required safety standards in accordance with LVD 73/23 EEC

- | | | | |
|-----------------------------------|---|-------------------------------------|---|
| <input type="checkbox"/> EN 60065 | Safety requirements for mains operated electronic and related apparatus for household and similar general use | <input type="checkbox"/> EN 60950 | Safety for information technology equipment including electrical business equipment |
| <input type="checkbox"/> EN 60335 | Safety of household and similar electrical appliances | <input type="checkbox"/> EN 50091-1 | General and Safety requirements for uninterruptible power systems (UPS) |

Manufacturer/Importer

Signature: Rex Lin

(Stamp)

Date : Oct. 24, 2001

Name : Rex Lin

7ZMMHC

AMD Athlon™/Duron™ Socket A Processor
Motherboard

USER'S MANUAL

AMD Athlon™/Duron™ Socket A Processor Motherboard
REV. 1.01 First Edition
12ME-7ZMMHC-1011

How This Manual Is Organized

This manual is divided into the following sections:

1) Revision List	Manual revision information
2) Item Checklist	Product item list
3) Features	Product information & specification
4) Installation Guide	Instructions on CPU & Memory Installation
5) Performance & Block Diagram	Product performance & block diagram
6) Suspend to RAM	Instructions on STR
7) Q-Flash	Q-Flash introduction
8) @BIOS™	@BIOS™ introduction
9) BIOS Setup	Instructions on setting up the BIOS software
10) Technical Support / RMA Sheet	Document equipment used for after sales service
11) Appendix	General reference

Table Of Content

Revision History	P.1
Item Checklist	P.2
Features Summary	P.3
7ZMMHC Motherboard Layout	P.5
Installation Guide	P. 6
Page Index for Connectors / Panel and Jumper Definition	P.12
Performance List	P.27
Block Diagram	P.29
Suspend to RAM Installation	P.30
Q-Flash Introduction	P.36
@BIOS™ Introduction	P.38
Page Index for BIOS Setup	P.39
Technical Support / RMA Sheet	P.66
Appendix	P.67

Revision History

Revision	Revision Note	Date
1.01	Initial release of the 7ZMMHC motherboard user's manual.	Oct. 2001

The author assumes no responsibility for any errors or omissions that may appear in this document nor does the author make a commitment to update the information contained herein. Third-party brands and names are the property of their respective owners.

Oct. 15, 2001 Taipei, Taiwan, R.O.C

Item Checklist

- The 7ZMMHC motherboard
- Cable for IDE / floppy device
- CD for motherboard driver & utility
- 7ZMMHC user's manual

Features Summary

Form factor	<ul style="list-style-type: none"> 24.4 cm x 23.1 cm Micro ATX size form factor, 4 layers PCB.
CPU	<ul style="list-style-type: none"> AMD Athlon™/Duron™ (K7) Socket A Processor 256K/64K L2 cache on die Supports 600MHz ~ 1GHz and above
Chipset	Pro Savage KM133A, consisting of: <ul style="list-style-type: none"> VT8365A Memory/AGP/PCI Controller(PAC) VT82C686B PCI Super-I/O Integrated Peripheral Controller (PSIPC)
Clock Generator	<ul style="list-style-type: none"> ICS 94236AF 95/100/102/105/110/113/115/120/133/135/137/139/141 MHz system bus speeds
Memory	<ul style="list-style-type: none"> 2 168-pin DIMM sockets Supports PC-100/133 and VCM SDRAM Supports up to 1.0GB DRAM Supports only 3.3V SDRAM DIMM
I/O Control	<ul style="list-style-type: none"> VT82C686B
Slots	<ul style="list-style-type: none"> 1 AGP slot supports 4X mode & AGP 2.0 compliant 3 PCI slots supports 33MHz & PCI 2.2 compliant 1 CNR (Communication and Networking Riser) Slot
On-Board IDE	<ul style="list-style-type: none"> 2 IDE bus master (UDMA 33/ATA 66/ATA100) IDE ports for up to 4 ATAPI devices Supports PIO mode 3, 4 (UDMA 33/ATA 66/ATA 100) IDE & ATAPI CD-ROM
On-Board Peripherals	<ul style="list-style-type: none"> 1 floppy port supports 2 FDD with 360K, 720K, 1.2M, 1.44M and 2.88M bytes 1 parallel port supports Normal/EPP/ECP mode 2 serial port (COM A & COM B) 4 USB ports
Hardware Monitor	<ul style="list-style-type: none"> CPU/System fan revolution detection CPU/Power/System fan control System voltage detection CPU/System temperature detection

To be continued...

On-Board Sound	<ul style="list-style-type: none"> • AC'97 CODEC • Line In / Line Out / Mic In / AUX In / CD In / TEL / Game Port
PS/2 Connector	<ul style="list-style-type: none"> • PS/2[®] Keyboard interface and PS/2[®] Mouse interface
BIOS	<ul style="list-style-type: none"> • Licensed AMI BIOS, 2M bit flash ROM
On-Board VGA	<ul style="list-style-type: none"> • Build S3 Savage4 (86C370) in VT8365A • Support shared memory architecture
Additional Features	<ul style="list-style-type: none"> • Support Wake-On-LAN (WOL) • Support Internal / External Modem Ring On • Support USB KB/MS Wake up from S3-S5 • Includes 3 fan power connectors • Poly fuse for keyboard over-current protection • Support STR (Suspend-To-RAM) function • Support @BIOS™

7ZMMHC Motherboard Layout

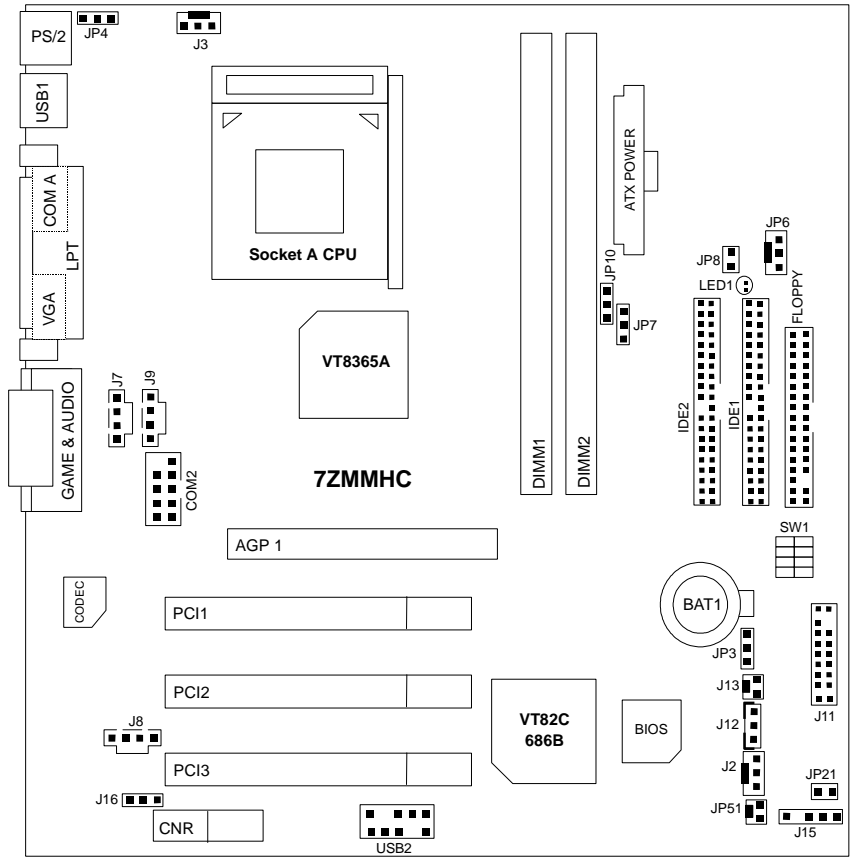

Installation Guide

Getting Started

**WARNING!**

Computer motherboards and expansion cards contain very delicate Integrated Circuit (IC) chips. To protect them against damage from static electricity, you should follow some precautions whenever you work on your computer.

1. Unplug your computer when working on the inside.
2. Use a grounded wrist strap before handling computer components. If you do not have one, touch both of your hands to a safely grounded object or to a metal object, such as the power supply case.
3. Hold components by the edges and try not touch the IC chips, leads or connectors, or other components.
4. Place components on a grounded antistatic pad or on the bag that came with the components whenever the components are separated from the system.
5. Ensure that the ATX power supply is switched off before you plug in or remove the ATX power connector on the motherboard.

Installing the motherboard to the chassis...

If the motherboard has mounting holes, but they don't line up with the holes on the base and there are no slots to attach the spacers, do not become alarmed you can still attach the spacers to the mounting holes. Just cut the bottom portion of the spacers (the spacer may be a little hard to cut off, so be careful of your hands). In this way you can still attach the motherboard to the base without worrying about short circuits. Sometimes you may need to use the plastic springs to isolate the screw from the motherboard PCB surface, because the circuit wire may be near by the hole. Be careful, don't let the screw contact any printed circuit write or parts on the PCB that are near the fixing hole, otherwise it may damage the board or cause board malfunctioning.

To set up your computer, you must complete the following steps:

- ▶ Step 1 - Set system jumpers
- ▶ Step 2- Install the Central Processing Unit (CPU)
- ▶ Step 3-Install memory modules
- ▶ Step 4-Install expansion cards
- ▶ Step 5-Connect ribbon cables, cabinet wires, and power supply
- ▶ Step 6-Set up BIOS software
- ▶ Step 7-Install supporting software tools

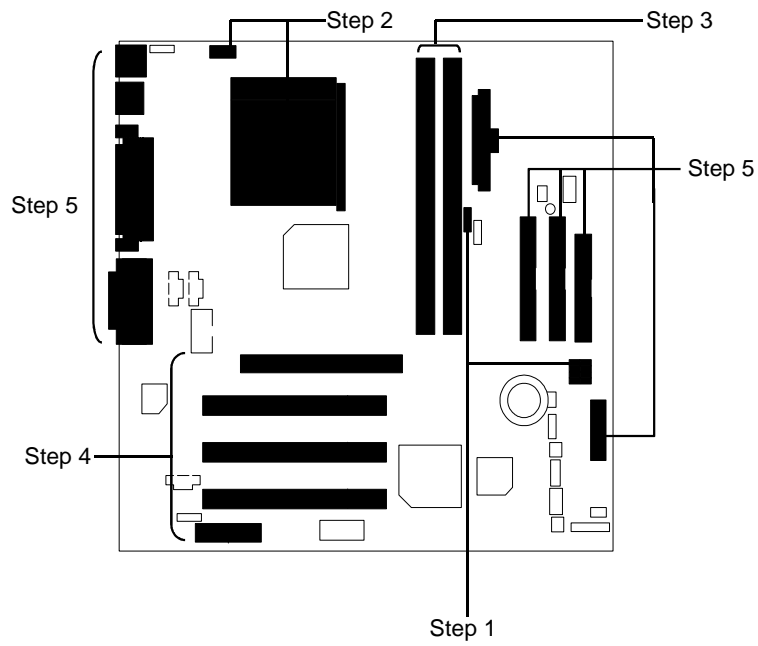

CPU Speed Setup

The system bus frequency can be switched at 95MHz-145MHz by adjusting SW 1 & JP10.
(The frequency ratio depend on CPU).

SW1 Select the System Speed at 95MHz - 145MHz.

O: ON, X: OFF

FSB	1	2	3	4	JP10
95	O	O	O	O	2-3
100	O	O	X	O	2-3
102	O	O	O	X	2-3
105	O	O	X	X	2-3
110	X	O	O	O	2-3
113	X	O	X	O	2-3
115	X	O	O	X	2-3
120	X	O	X	X	2-3
133	O	X	O	O	1-2
135	O	X	X	O	1-2
137	O	X	O	X	1-2
139	O	X	X	X	1-2
141	X	X	O	O	1-2
143	X	X	X	O	1-2
145	X	X	O	X	1-2

 Please make sure that JP10 setting is in accordance with your CPU clock frequency. Wrong setting may cause system unable to boot.

CPU Installation

Please make sure the CPU should be supported to the motherboard.

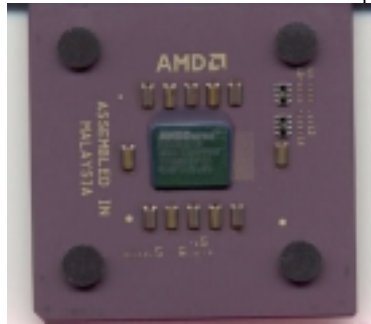

CPU Top View

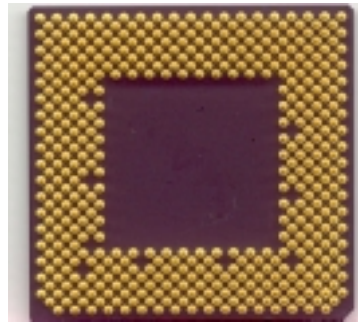

CPU Bottom View

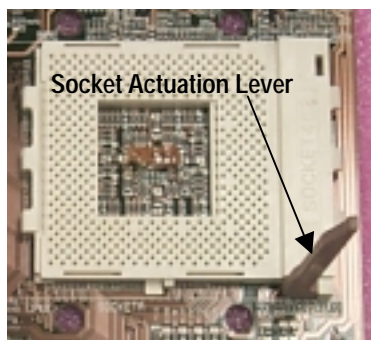

1. Pull the lever out and lift it up.

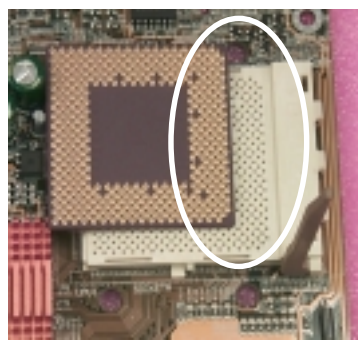

2. The notched corner should be orientated toward the blank space on the socket nearest the lever. The CPU will only fit in the orientation as shown.

CPU Heat Sink Installation:

Beware: Please check that the heat sink is in good contact with the CPU before you turn on your system. **The poor contact will cause over heat, and might cause damage to your processor!**

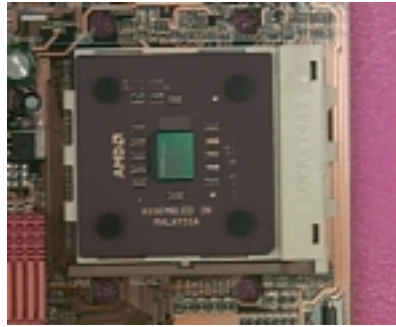

3. Align CPU and insert it
(Please refer to your heatsink installation manual for application of thermal grease to provide better heat conduction between your CPU and heatsink.)



4. Use compliant fan approved by AMD.

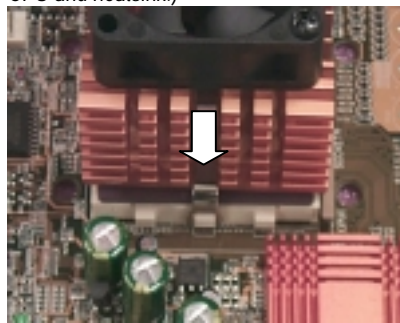

5. Hook one end of the cooler bracket to the CPU socket.

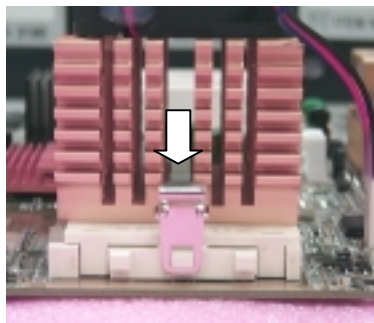

6. Hook the other end of the cooler bracket to the CPU socket.

 (Please refer to the cooler's installation manual for detailed installation steps)

Memory Installation

The motherboard has 2 dual inline memory module (DIMM) sockets support 4 banks. The BIOS will automatically detects memory type and size. To install the memory module, just push it vertically into the DIMM Slot .The DIMM module can only fit in one direction due to the two notch. Memory size can vary between sockets.

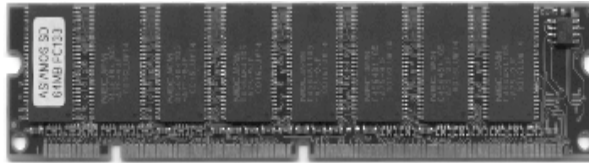

SDRAM

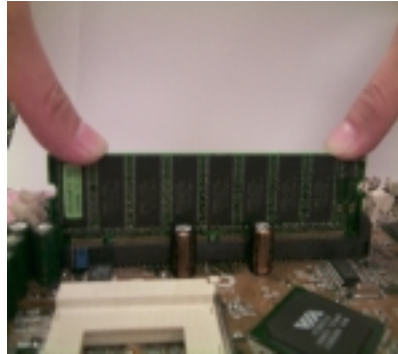
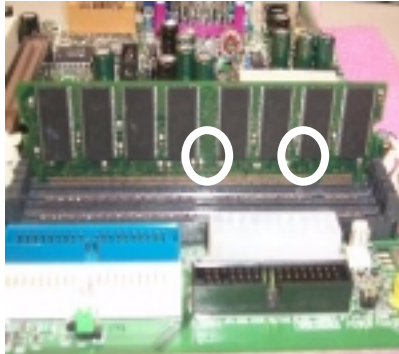

1. The DIMM slot has two notch, so the DIMM memory module can only fit in one direction.
 2. Insert the DIMM memory module vertically into the DIMM slot. Then push it down.
 3. Close the plastic clip at both edges of the DIMM slots to lock the DIMM module.
-  Reverse the installation steps when you wish to remove the DIMM module.

Page Index for Connectors/Panel and Jumper Definition	Page
Connectors	P.13
ATX Power	P.13
COM A / VGA / LPT Port	P.13
COM2 (COM B)	P.21
Floppy Connector	P.15
Game & Audio Port	P.16
IDE 1(Primary) / IDE 2(Secondary) Connector	P.16
J2 (System Fan)	P.19
J3 (CPU Fan)	P.20
J7 (AUX_IN)	P.17
J8 (TEL)	P.18
J9 (CD Audio Line In)	P.17
J12 (Wake On LAN)	P.20
J13 (Ring Power On)	P.18
J15 (IR)	P.22
JP6 (Power Fan)	P.19
JP8 / LED1 (STR LED Connector & DIMM LED)	P.21
JP51 (S_IRQ)	P.22
PS/2 Keyboard & PS/2 Mouse Port	P.14
USB1 (Rear USB Port)	P.14
USB2 (Front USB Connector)	P.15
Panel and Jumper Definition	P.23
BAT1 (Battery)	P.26
J11 (2x11 Pins Jumper)	P.23
J16 (CNR Select)	P.25
JP21 (Case Open)	P.25
JP3 (Clear CMOS Function)	P.24
JP4 (USB Device Wake up Selection)	P.24
JP7 (STR Selection)	P.26

Connectors

ATX Power

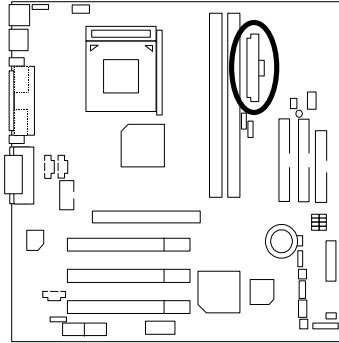

Pin No.	Definition
3,5,7,13,15-17	GND
1,2,11	3.3V
4,6,19,20	VCC
10	+12V
12	-12V
18	-5V
8	Power Good
9	5V SB (stand by+5V)
14	PS-ON(Soft On/Off)



Please note:
AC power cord should only be inserted to your power supply unit after ATX power cable and other related devices are firmly connected to the mainboard.

COM A / VGA / LPT Port

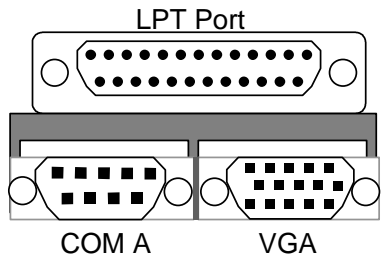
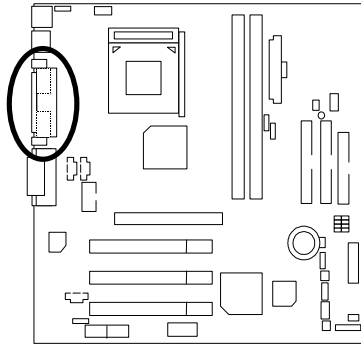

Please note:
This mainboard supports 1 standard COM port, 1 VGA port and 1 LPT port. Device like printer can be connected to LPT port ; mouse and modem etc can be connected to COM port.

PS/2 Keyboard & PS/2 Mouse Connector

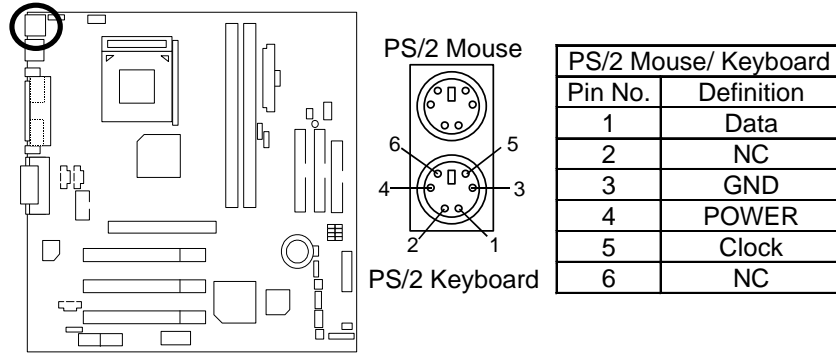
**Please note:**

This mainboard supports standard PS/2 keyboard and PS/2 mouse interface connector.

USB1: USB Connector

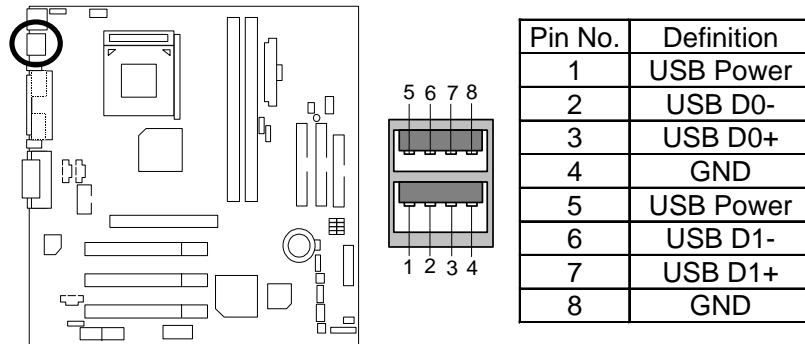
**Please note:**

Before you connect your device(s) into USB connector(s), please make sure your device(s) such as USB keyboard, mouse, scanner, zip, speaker..etc. have a standard USB interface. Also make sure your OS (Win 95 w/ USB support, Win98, Windows 2000, Windows ME, Win NT w/ SP 6) supports USB controller. If your OS does not support USB controller, please contact OS vendor for possible patch or driver upgrade. For more information please contact your OS or device(s) vendors.

USB2: Front USB Connector

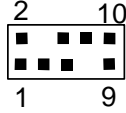
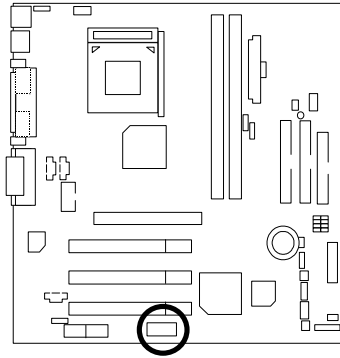

Pin No.	Definition
1	POWER
2	GND
3	USB D2-
4	NC
5	USB D2+
6	USB D3+
7	NC
8	USB D3-
9	GND
10	POWER



Please note:

Be careful with the polarity of the front panel USB connector. Check the pin assignment while you connect the front panel USB cable. Please contact your nearest dealer for optional front panel USB cable.

Floppy Port

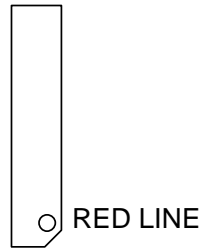
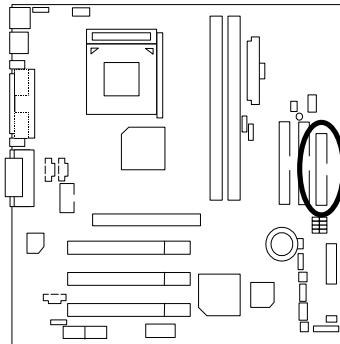

Game & Audio Port

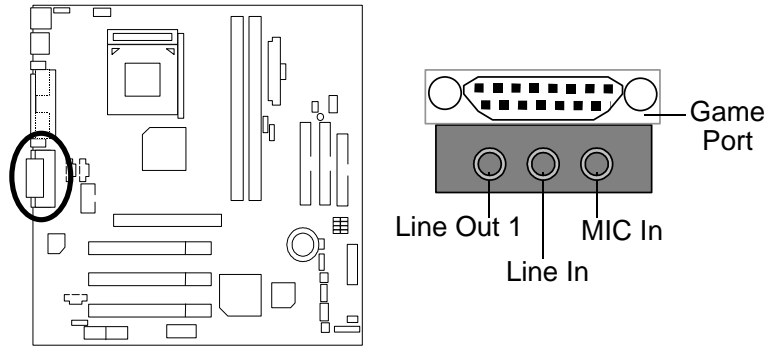

Please note:

This motherboard supports standard audio port and game port. After install onboard audio driver, you may connector speaker to line out jack, micro phone to MIC in jack Device like CD-ROM , walkman etc can be connected to line-in jack.

IDE1 (Primary), IDE2 (Secondary) Port

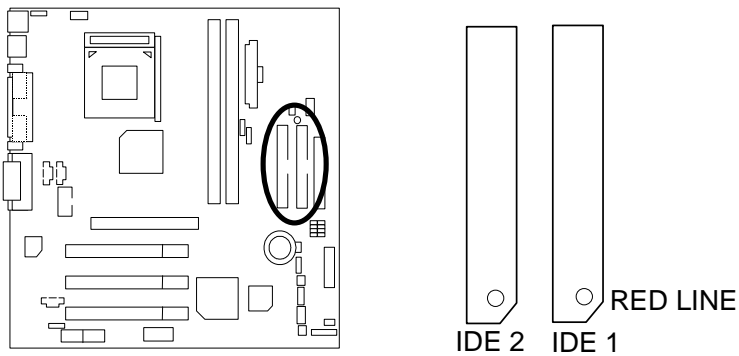

Line Out
capable
or comp
decode
connec
Out aut
To enab
simply f
become
speake

J9: CD Audio Line In

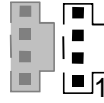
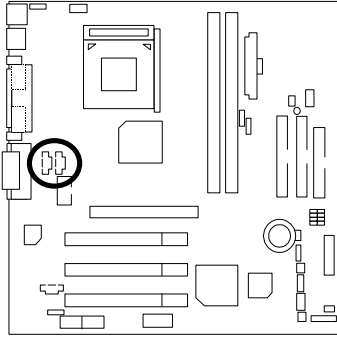

Pin No.	Definition
1	CD-L
2	GND
3	GND
4	CD-R

J7: AUX_IN

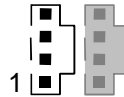
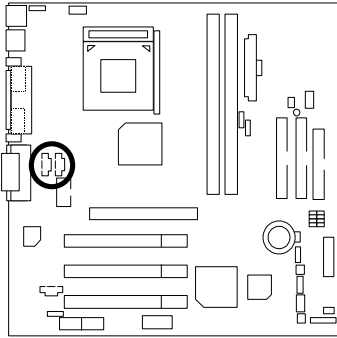

Pin No.	Definition
1	AUX-L
2	GND
3	GND
4	AUX-R

J8: TEL (The connector is for internal modem card with voice connector)

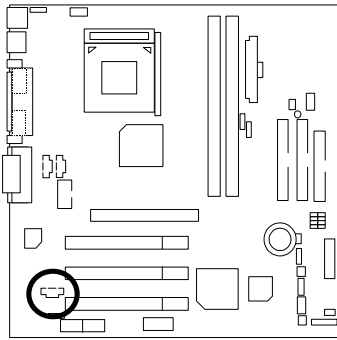

Pin No.	Definition
1	Signal-In
2	GND
3	GND
4	Signal-Out

J13: Ring Power On

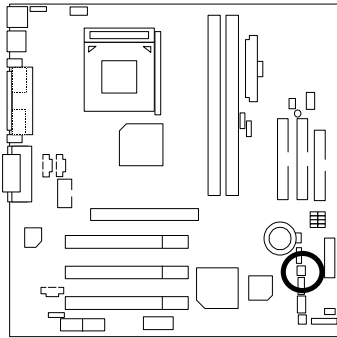

Pin No.	Definition
1	Signal
2	GND

J2: System FAN

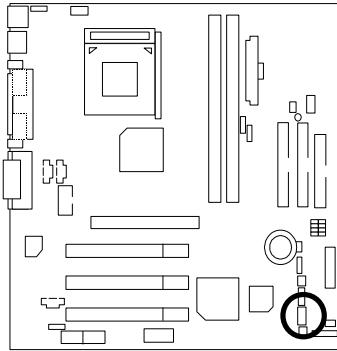

Pin No.	Definition
1	Control
2	+12V
3	SENSE

JP6: Power FAN

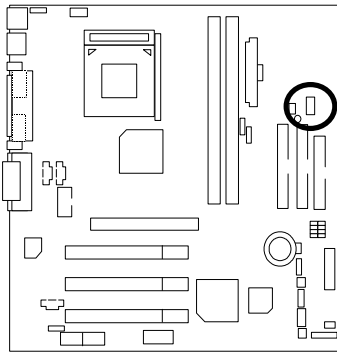

Pin No.	Definition
1	Control
2	+12V
3	SENSE

J3: CPU FAN

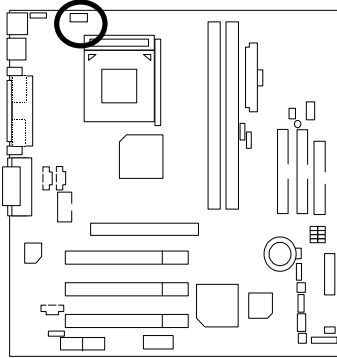

Pin No.	Definition
1	Control
2	+12V
3	SENSE

**Please note:**

A proper installation of the CPU cooler is essential to prevent the CPU from running under abnormal condition or damaged by overheating.

J12: Wake on LAN

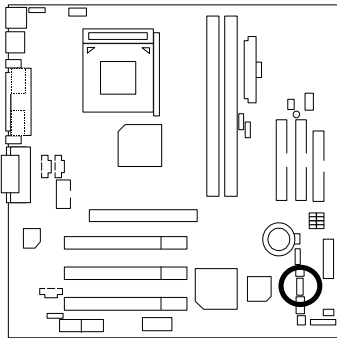

Pin No.	Definition
1	+5V SB
2	GND
3	Signal

JP8 / LED1: STR LED Connector & DIMM LED

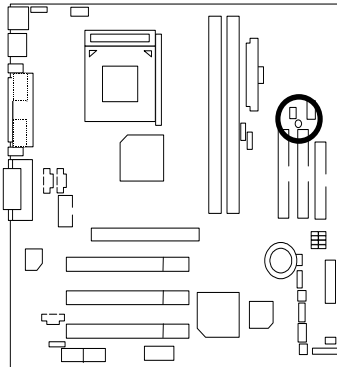

STR LED Connector External.



Please note:

Do not remove memory modules while DIMM LED is on. It might cause short or other unexpected damages due to the 3.3V stand by voltage. Remove memory modules only when STR function is disabled by jumper and AC Power cord is disconnected.

COM2: COM B

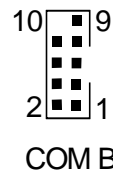
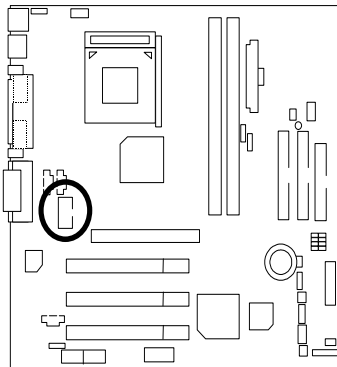

J15: IR

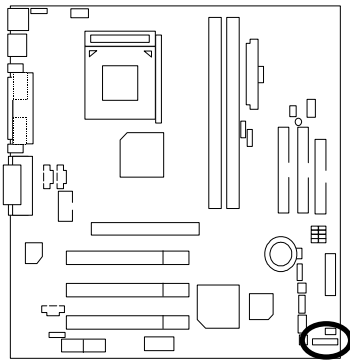

1

Pin No.	Definition
1	VCC (+5V)
2	NC
3	IR Data Input
4	GND
5	IR Data Output

**Please note:**

Be careful with the polarity of the IR connector while you connect the IR.
Please contact you nearest dealer for optional IR device.

JP51: S_IRQ

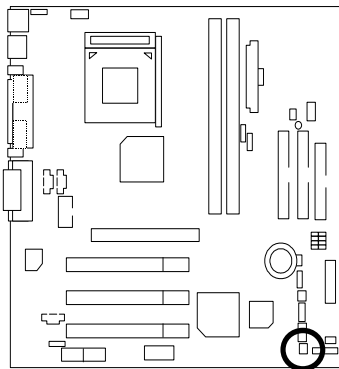

1

Pin No.	Definition
1	Signal
2	GND

Panel And Jumper Definition

J11: For 2X11 Pins Jumper

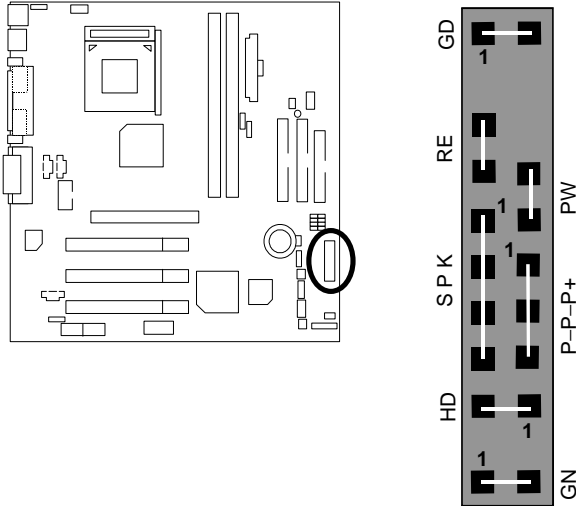

GN (Green Switch)	Open: Normal Operation Close: Entering Green Mode
GD (Green LED)	Pin 1: LED anode(+) Pin 2: LED cathode(-)
HD (IDE Hard Disk Active LED)	Pin 1: LED anode(+) Pin 2: LED cathode(-)
SPK (Speaker Connector)	Pin 1: VCC(+) Pin 2- Pin 3: NC Pin 4: Data(-)
RE (Reset Switch)	Open: Normal Operation Close: Reset Hardware System
P+P-P-(Power LED)	Pin 1: LED anode(+) Pin 2: LED cathode(-) Pin 3: LED cathode(-)
PW (Soft Power Connector)	Open: Normal Operation Close: Power On/Off



Please note:

Please connect the power LED, PC speaker, reset switch and power switch etc of your chassis front panel to the front panel jumper according to the pin assignment above.

JP3: Clear CMOS Function

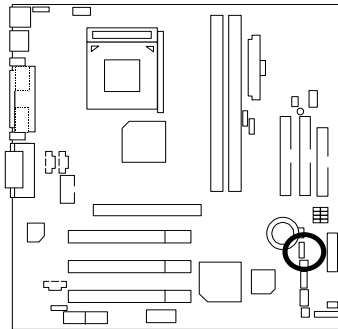

Normal (Default)



Clear CMOS

Pin No.	Definition
1-2 close	Normal (Default)
2-3 close	Clear CMOS



Please note:
You may clear the CMOS data to its default values by this jumper.

JP4: USB Device Wake up Selection

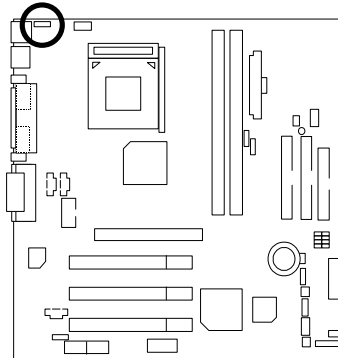

Normal (Default)



Enable

Pin No.	Definition
1-2 close	Normal (Default)
2-3 close	USB Device Wake up



Please note:
(If you want to use "USB Dev Wakeup from S3~S5" function, you have to set the BIOS setting "USB Dev Wakeup from S3~S5" enabled, and the jumper "JP4" enabled).
*(Power on the computer and as soon as memory counting starts, press . You will enter BIOS Setup. Select the item "POWER MANAGEMENT SETUP", then select "USB Dev Wakeup from S3~S5: Enabled". Remember to save the setting by pressing "ESC" and choose the "SAVE & EXIT SETUP" option.)

J16: CNR Select

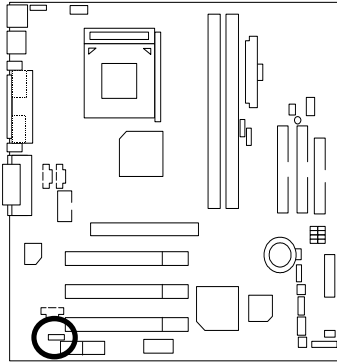

Pin No.	Definition
1-2 close	Secondary
2-3 close	Primary



Please note:

J16: 1-2 close: If you use software audio(onboard CODEC only), your modem riser must be "Secondary". J16: 2-3 close: If you don't use onboard software audio, your audio/modem riser must be "Primary". Mainboard's software audio will be disabled. There are two types of CNR card in the market, Primary and secondary. If your CNR card is primary, J16 should be set to 2-3, if you have secondary CNR card J16 should be set to 1-2.
Warning! If Primary CNR card is used, on-board CODEC will be disabled.

JP21: Case Open

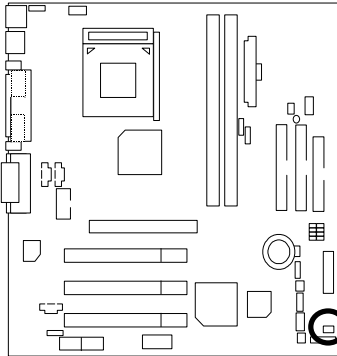

Pin No.	Definition
1	Signal
2	GND

JP7: STR Selection

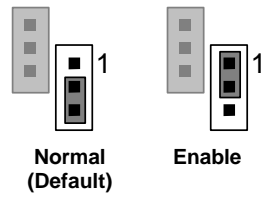
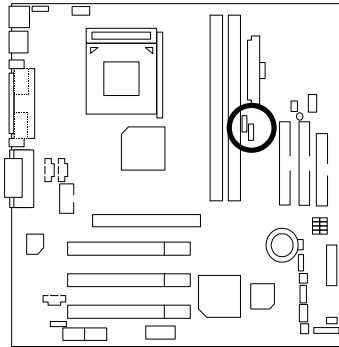

Pin No.	Definition
1-2 close	STR Enable
2-3 close	Normal (Default)

BAT1: Battery

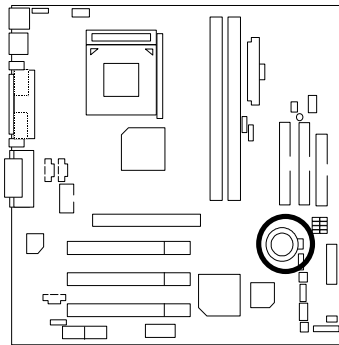

CAUTION

- ▶ Danger of explosion if battery is incorrectly replaced.
- ▶ Replace only with the same or equivalent type recommended by the manufacturer.
- ▶ Dispose of used batteries according to the manufacturer's instructions.

Performance List

The following performance table lists the results of some popular benchmark testing programs. These data are provided as reference only and in no way guarantee the system shall perform, and there is no responsibility for different testing data at exactly the same level. (The different Hardware & Software configuration will result in different benchmark testing results.)

- CPU AMD K7 Athlon™ 1333MHz / Duron™ 900MHz processor
- DRAM (128x1) MB SDRAM (Kingmax KSV884T4A1A-07)
- CACHE SIZE 384 KB included in Athlon™
192 KB included in Duron™
- DISPLAY Gigabyte GF2000
- STORAGE Onboard IDE (Quantum AS30000AT 30GB)
- O.S. Windows 2000 + SP1 + DirectX8
- DRIVER Display Driver at 1024 x 768 x 64k colors x 75Hz.

Processor	AMD Athlon™ 1333MHz (266x5)	AMD Duron™ 900MHz (200x4.5)
Winbench99		
Business Disk Winmark 99	7860	7340
Hi-End Disk Winmark 99	17700	16300
Business Graphics Winmark 99	571	363
Hi-End Graphics Winmark 99	1300	872
Winstone 2001		
Business Winstone 2001	45.3	34.5
Content Creative Winstone 2001	44.6	38

- CPU AMD K7 Athlon™ 1333MHz / Duron™ 900MHz processor
- DRAM (128x1) MB SDRAM (Kingmax KSV884T4A1A-07)
- CACHE SIZE 384 KB included in Athlon™
192 KB included in Duron™
- DISPLAY Onboard VGA
- STORAGE Onboard IDE (Quantum AS30000AT 30GB)
- O.S. Windows 2000 + SP1 + DirectX8
- DRIVER Display Driver at 1024 x 768 x 64k colors x 75Hz.

Processor	AMD Athlon™ 1333MHz (266x5)	AMD Duron™ 900MHz (200x4.5)
Winbench99		
Business Disk Winmark 99	6240	7340
Hi-End Disk Winmark 99	15900	15900
Business Graphics Winmark 99	224	186
Hi-End Graphics Winmark 99	813	589
Winstone 2001		
Business Winstone 2001	38.6	29.6
Content Creative Winstone 2001	40	33.8

Block Diagram

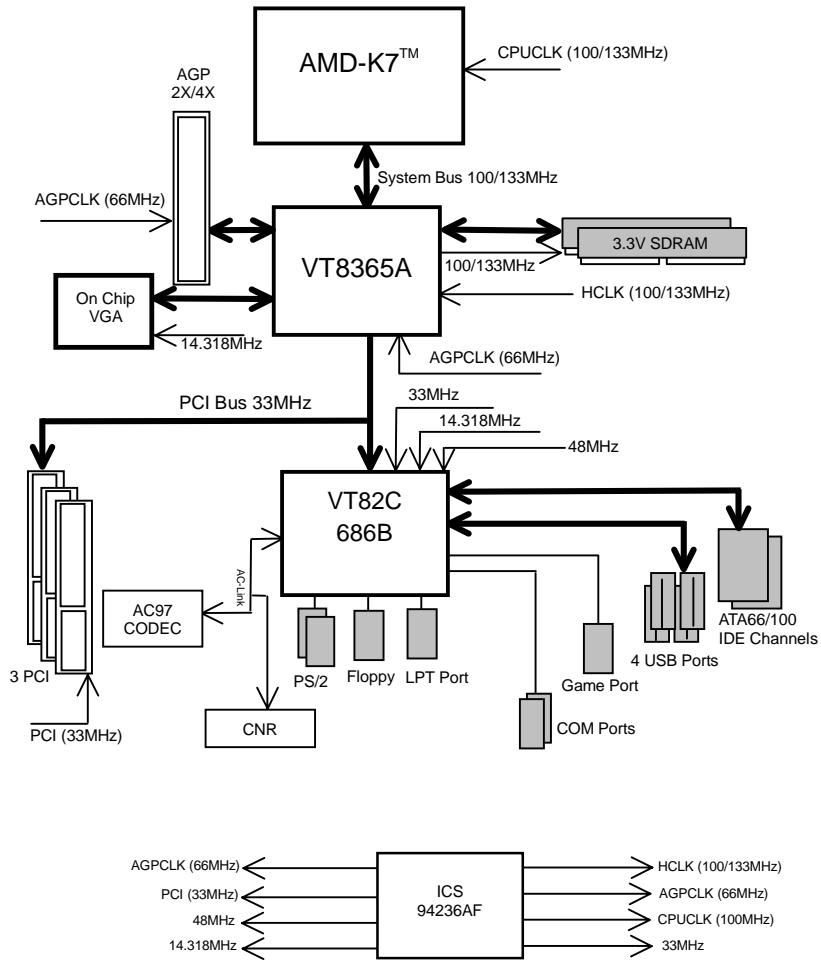

Suspend To RAM Installation

A.1 Introduce STR function:

Suspend-to-RAM (STR) is a Windows 98/ME/2000 ACPI sleep mode function. When recovering from STR (S3) sleep mode, the system is able, in just a few seconds, to retrieve the last "state" of the system before it went to sleep and recover to that state. The "state" is stored in memory (RAM) before the system goes to sleep. During STR sleep mode, your system uses only enough energy to maintain critical information and system functions, primarily the system state and the ability to recognize various "wake up" triggers or signals, respectively.

A.2 STR function Installation

Please use the following steps to complete the STR function installation.

Step-By-Step Setup

Step 1:

To utilize the STR function, the system must be in Windows 98/ME/2000 ACPI mode.

Putting Windows 98/ME/2000 into ACPI mode is fairly easy.

Setup with Windows 98/ME/2000 CD:

- A. Insert the Windows 98/ME/2000 CD into your CD-ROM drive, select Start, and then Run.
- B. Type (without quotes) "**D:\setup** " in the window provided. Hit the enter key or click OK.
- C. After setup completes, remove the CD, and reboot your system

(This manual assumes that your CD-ROM device drive letter is D:).

Step 2:

(If you want to use STR Function, please set jumper JP7 Pin1-2 (Closed.)

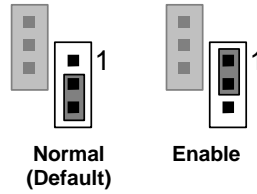
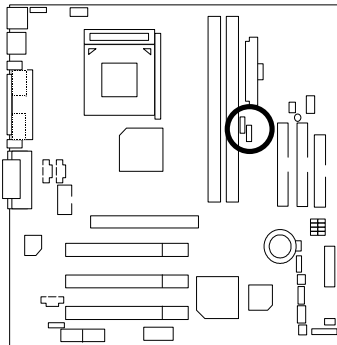

Pin No.	Definition
1-2 close	STR Enable
2-3 close	Normal (Default)

Step 3:

Power on the computer and as soon as memory counting starts, press . You will enter BIOS Setup. Select the item "**POWER MANAGEMENT SETUP**", then select "**ACPI Standby State: S3 /STR**". Remember to save the settings by pressing "ESC" and choose the "**SAVE & EXIT SETUP**" option.

Congratulation! You have completed the installation and now can use the STR function.

A.3 How to put your system into STR mode? (For example: Windows ME)

There are two ways to accomplish this:

1. Choose the "Stand by" item in the "Shut Down Windows" area.
 - A. Press the "Start" button and then select "Shut Down"

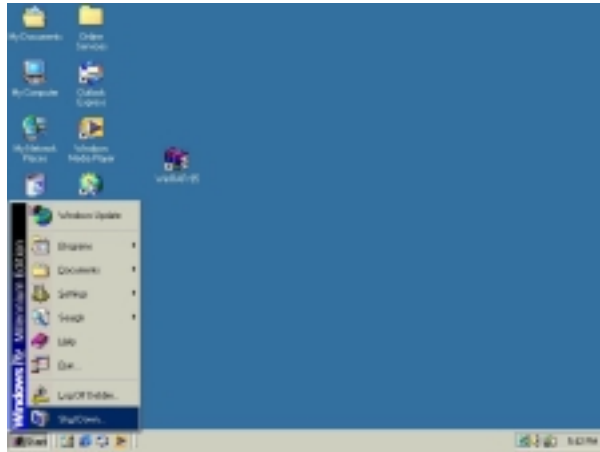

- B. Choose the "Stand by" item and press "OK"



2. Define the system "power on" button to initiate STR sleep mode:
 - A. Double click "My Computer" and then "Control Panel"



- B. Double click the " Power Management" item.

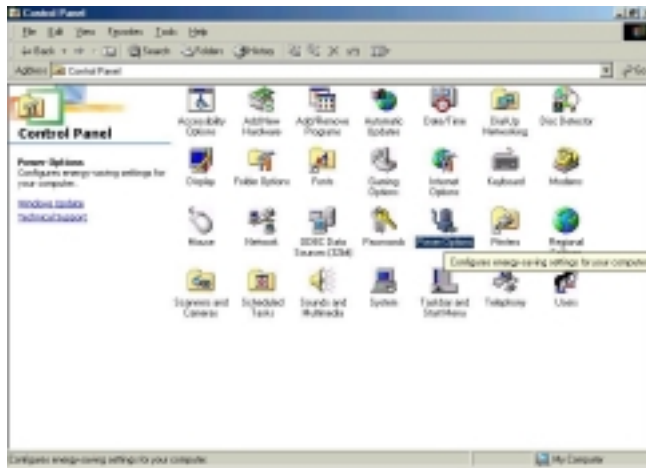

- C. Select the "Advanced" tab and "Standby" mode in Power Buttons.

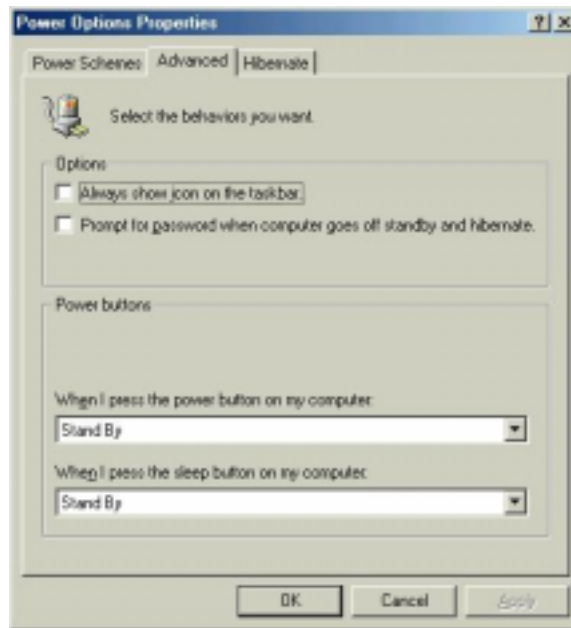

- D. Restart your computer to complete setup.

Now when you want to enter STR sleep mode, just momentarily press the "Power on" button.

A.4 How to recover from the STR sleep mode?

There are five ways to "wake up" the system:

1. Press the "Power On" button.
2. Use the "Resume by Alarm" function.
3. Use the "Modem Ring On" function.
4. Use the "Wake On LAN" function.
5. Use the "USB Device Wake up" function.

A.5 Notices:

1. In order for STR to function properly, several hardware and software requirements must be satisfied:
 - A. Your ATX power supply must comply with the ATX 2.01 specification (provide more than 720 mA 5V Stand-By current).
 - B. Your SDRAM must be PC-100/PC-133 compliant.
2. Jumper JP8 is provided to connect to the STR LED in your system chassis. [Your chassis may not provide this feature.] The STR LED will be illuminated when your system is in STR sleep mode.

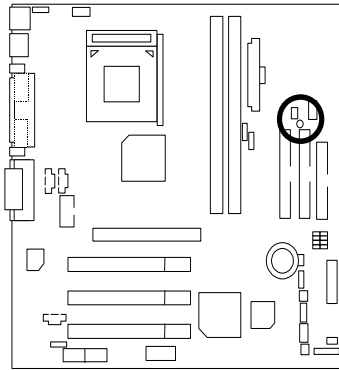

STR LED Connector External.



Please note:

Do not remove memory modules while DIMM LED is on. It might cause short or other unexpected damages due to the 3.3V stand by voltage. Remove memory modules only when STR function is disabled by jumper and AC Power cord is disconnected.

Q-Flash Introduction

A. What's Q-Flash?

Gigabyte's brings you another BIOS upgrade technology. Today, You don't have to follow the inconvenient traditional way of updating BIOS. With Instant BIOS Flash Utility you don't need to boot into DOS or Windows.

You can now easily update BIOS by just pressing F8 during boot up.

B. How to use Q-Flash?

- a. After power on the computer, pressing immediately during POST (Power On Self Test) it will allow you to enter AMI BIOS CMOS SETUP, then press <F8> to enter Flash utility.

AMIBIOS SIMPLE SETUP UTILITY – VERSION 1.24g (C) 1999 American Megatrends, Inc. All Rights Reserved	
STANDARD CMOS SETUP	INTEGRATED PERIPHERALS
BIOS FEATURES SETUP	HARDWARE MONITOR & MISC SETUP
CHIPSET FEATURES SETUP	SUPERVISOR PASSWORD
POWER MANAGEMENT SETUP	USER PASSWORD
PNP / PCI CONFIGURATION	IDE HDD AUTO DETECTION
LOAD FAIL-SAFE DEFAULTS	SAVE & EXIT SETUP
LOAD OPTIMIZED DEFAULTS	EXIT WITHOUT SAVING
ESC: Quit ↑↓←→: Select Item (Shift)F2: Change Color F5: Old Values F6: Fail-Safe Values F7: Optimized Values F8: Flash Utility F10: Save & Exit	
Time, Date, Hard Disk Type...	

- b. AMI BIOS Flash Utility

AMI BIOS Flash Utility V1.03	
Flash ROM Type.....	SST 39SF020
<div style="border: 1px solid gray; background-color: #cccccc; padding: 5px; width: fit-content; margin: 0 auto;">Load BIOS from Floppy</div>	
Enter : Run	ESC : Reset F10 : Power Off

c. In the A: drive, insert the "BIOS" diskette, then Press Enter to Run.

d. Input BIOS file name in the text box. Press "Enter".

Load XXX.XX

Where XXX.XX is name of the BIOS file.

Are you sure to COPY BIOS?
[Enter] to Continue Or [Esc] to abort..

!! COPY BIOS Completed –Pass !!
Please press any key to continue

Congratulation! You have completed the flashed and now can restart system.

@BIOS™ Introduction

Gigabyte announces @BIOS™ Windows BIOS live update utility



Have you ever updated BIOS by yourself? Or like many other people, you just know what BIOS is, but always hesitate to update it? Because you think updating newest BIOS is unnecessary and actually you don't know how to update it.

Maybe not like others, you are very experienced in BIOS updating and spend quite a lot of time to do it. But of course you don't like to do it too much. First, download different BIOS from website and then switch the operating system to DOS mode. Secondly, use different flash utility to update BIOS. The above process is not a interesting job. Besides, always be carefully to store the BIOS source code correctly in your disks as if you update the wrong BIOS, it will be a nightmare.

Certainly, you wonder why motherboard vendors could not just do something right to save your time and effort and save you from the lousy BIOS updating work? Here it comes! Now Gigabyte announces @BIOS™ --the first Windows BIOS live update utility. This is a smart BIOS update software. It could help you to download the BIOS from internet and update it. Not like the other BIOS update software, it's a Windows utility. With the help of "@BIOS™", BIOS updating is no more than a click.

Besides, no matter which mainboard you are using, if it's a Gigabyte's product*, @BIOS™ help you to maintain the BIOS. This utility could detect your correct mainboard model and help you to choose the BIOS accordingly. It then downloads the BIOS from the nearest Gigabyte ftp site automatically. There are several different choices: you could use "Internet Update" to download and update your BIOS directly. Or you may want to keep a backup for your current BIOS, just choose "Save Current BIOS" to save it first. You make a wise choice to use Gigabyte, and @BIOS™ update your BIOS smartly. You are now worry free from updating wrong BIOS, and capable to maintain and manage your BIOS easily. Again, Gigabyte's innovative product erects a milestone in mainboard industries.

For such a wonderful software, how much it costs? Impossible! It's free! Now, if you buy a Gigabyte's motherboard, you could find this amazing software in the attached driver CD. But please remember, connected to internet at first, then you could have a internet BIOS update from your Gigabyte @BIOS™.

Page Index for BIOS Setup	Page
The Main Menu	P.41
Standard CMOS Setup	P.43
BIOS Features Setup	P.46
Chipset Features Setup	P.48
Power Management Setup	P.50
PNP/ PCI Configuration	P.53
Load BIOS Defaults	P.55
Load Setup Defaults	P.56
Integrated Peripherals	P.57
Hardware Monitor & MISC Setup	P.61
Supervisor Password / User Password	P.62
IDE HDD Auto Detection	P.63
Save & Exit Setup	P.64
Exit Without Saving	P.65

BIOS Setup

BIOS Setup is an overview of the BIOS Setup Interface. The interface allows users to modify the basic system configuration, which is stored in battery-backed CMOS RAM so that it retains the Setup information can be retained when the power is turned off.

ENTERING SETUP

Power ON the computer and press immediately will allow you to enter Setup.

CONTROL KEYS

<↑>	Move to previous item
<↓>	Move to next item
<←>	Move to the item in the left hand
<→>	Move to the item in the right hand
<Esc>	Main Menu - Quit and not save changes into CMOS Status Page Setup Menu and Option Page Setup Menu - Exit current page and return to Main Menu
<+/PgUp>	Increase the numeric value or make changes
<-/PgDn>	Decrease the numeric value or make changes
<F1>	General help, only for Status Page Setup Menu and Option Page Setup Menu
<F2>	Reserved
<F3>	Reserved
<F4>	Reserved
<F5>	Restore the previous CMOS value from CMOS, only for Option Page Setup Menu
<F6>	Load the default CMOS value from BIOS default table, only for Option Page Setup Menu
<F7>	Load the Setup Defaults
<F8>	Reserved
<F9>	Reserved
<F10>	Save all the CMOS changes, only for Main Menu

GETTING HELP

Main Menu

The on-line description of the highlighted setup function is displayed at the bottom of the screen.

Status Page Setup Menu / Option Page Setup Menu

Press F1 to pop up a small help window that describes the appropriate keys to use and the possible selections for the highlighted item. To exit the Help Window press <Esc>.

The Main Menu (For example: BIOS Ver. : F2)

Once you enter AMI BIOS CMOS Setup Utility, the Main Menu (Figure 1) will appear on the screen. The Main Menu allows you to select from nine setup functions and two exit choices. Use arrow keys to select among the items and press <Enter> to accept or enter the sub-menu.

AMIBIOS SIMPLE SETUP UTILITY-VERSION 1.24g (C) 1999 American Megatrends, Inc. All Rights Reserved	
STANDARD CMOS SETUP	INTEGRATED PERIPHERALS
BIOS FEATURES SETUP	HARDWARE MONITOR & MISC SETUP
CHIPSET FEATURES SETUP	SUPERVISOR PASSWORD
POWER MANAGEMENT SETUP	USER PASSWORD
PNP/PCI CONFIGURATION	IDE HDD AUTO DETECTION
LOAD FAIL-SAFE DEFAULTS	SAVE & EXIT SETUP
LOAD OPTIMIZED DEFAULTS	EXIT WITHOUT SAVING
ESC : Quit ↑↓←→ : Select Item (Shift) F2 : Change Color F5 : Old Values F6 : Fail-Safe Values F7: Optimized Values F8: Flash Utility F10: Save & Exit	
Time, Date, Hard Disk Type, ...	

Figure 1: Main Menu

- **Standard CMOS Setup**
This setup page includes all the adjustable items in standard compatible BIOS.
- **BIOS Features Setup**
This setup page includes all the adjustable items of Award special enhanced features.
- **Chipset Features Setup**
This setup page includes all the adjustable items of chipset special features.

- **Power Management Setup**

This setup page includes all the adjustable items of Green function features.
- **PnP/PCI Configuration**

This setup page includes all the adjustable configurations of PCI & PnP ISA resources.
- **Load Fail-Safe Defaults**

Load Fail-Safe Defaults option loads preset system parameter values to set the system in its most stable configurations.
- **Load Optimized Defaults**

Load Optimized Defaults option loads preset system parameter values to set the system in its highest performance configurations.
- **Integrated Peripherals**

This setup page includes all onboard peripherals.
- **Hardware Monitor & MISC Setup**

This setup page is auto detect fan and temperature status.
- **Set Supervisor Password**

Set Change or disable password. It allows you to limit access to the system and/or BIOS setup.
- **Set User Password**

Set Change or disable password. It allows you to limit access to the system.
- **IDE HDD auto detection**

Automatically configure hard disk parameters.
- **Save & Exit Setup**

Save CMOS value settings to CMOS and exit setup.
- **Exit Without Saving**

Abandon all CMOS value changes and exit setup.

Standard CMOS Setup

The items in Standard CMOS Setup Menu (Figure 2) are divided into 10 categories. Each category includes none, one or more than one setup items. Use the arrows to highlight the item and then use the <PgUp> or <PgDn> keys to select the value in each item.

AMIBIOS SETUP – STANDARD CMOS SETUP (C) 1999 American Megatrends, Inc. All Rights Reserved	
Date (mm/dd/yyyy) : Mon Feb 05, 2001 Time (hh/mm/ss) : 10:36:24	
TYPE SIZE CYLS HEAD PRECOMP LANDZ SECTOR MODE	
Pri Master : Auto Pri Slave : Auto Sec Master : Auto Sec Slave : Auto	
Floppy Drive A: 1.44 MB 3 ½ Floppy Drive B: Not Installed	Base Memory : 640 Kb Other Memory : 384 Kb Extended Memory : 111Mb Total Memory : 112Mb
Boot Sector Virus Protection : Disabled	
Month: Jan – Dec Day: 01 – 31 Year: 1990– 2099	ESC : Exit ↑↓ : Select Item PU/PD/+/- : Modify (Shift)F2 : Color

Figure 2: Standard CMOS Setup

- **Date**

The date format is <Week> <Month> <Day>, <Year>.

Week	The week, from Sun to Sat, determined by the BIOS and is display-only
Month	The month, Jan. Through Dec.
Day	The day, from 1 to 31 (or the maximum allowed in the month)
Year	The year, from 1990 through 2099

- **Time**

The times format in <hour> <minute> <second>. The time is calculated base on the 24-hour military-time clock. For example, 1 p.m. is 13:00:00.

- **Primary Master / Slave, Secondary Master / Slave**

The category identifies the type of hard disk from drive C to F that has been installed in the computer. There are two settings: Auto, and Manual. Manual: HDD type is user-definable; Auto will automatically detect HDD type.

Note that the specifications of your drive must match with the drive table. The hard disk will not work properly if you enter improper information for this category.

If you select User Type, related information will be asked to enter to the following items. Enter the information directly from the keyboard and press <Enter>. Such information should be provided in the documentation form your hard disk vendor or the system manufacturer.

CYLS.	Number of cylinders
HEADS	number of heads
PRECOMP	write precomp
LANDZONE	Landing zone
SECTORS	number of sectors

If a hard disk has not been installed select NONE and press <Enter>.

- **Floppy Drive A / Drive B**

The category identifies the type of floppy disk drive A or drive B that has been installed in the computer.

None	No floppy drive installed
360K, 5.25 in.	5.25 inch PC-type standard drive; 360K byte capacity.
1.2M, 5.25 in.	5.25 inch AT-type high-density drive; 1.2M byte capacity (3.5 inch when 3 Mode is Enabled).
720K, 3.5 in.	3.5 inch double-sided drive; 720K byte capacity
1.44M, 3.5 in.	3.5 inch double-sided drive; 1.44M byte capacity.
2.88M, 3.5 in.	3.5 inch double-sided drive; 2.88M byte capacity.

- **Boot Sector Virus Protection**

If it is set to enable, the category will flash on the screen when there is any attempt to write to the boot sector or partition table of the hard disk drive. The system will halt and the following error message will appear in the mean time. You can run anti-virus program to locate the problem.

Enabled	Activate automatically when the system boots up causing a warning message to appear when anything attempts to access the boot sector or hard disk partition table
Disabled	No warning message to appear when anything attempts to access the boot sector or hard disk partition table. (Default Value)

- **Memory**

The category is display-only which is determined by POST (Power On Self Test) of the BIOS.

Base Memory

The POST of the BIOS will determine the amount of base (or conventional) memory installed in the system.

The value of the base memory is typically 512 K for systems with 512 K memory installed on the motherboard, or 640 K for systems with 640 K or more memory installed on the motherboard.

Extended Memory

The BIOS determines how much extended memory is present during the POST.

This is the amount of memory located above 1 MB in the CPU's memory address map.

Other Memory

This refers to the memory located in the 640 K to 1024 K address space. This is memory that can be used for different applications.

DOS uses this area to load device drivers to keep as much base memory free for application programs. Most use for this area is Shadow RAM

BIOS Features Setup

AMIBIOS SETUP – BIOS FEATURES SETUP	
(C) 1999 American Megatrends, Inc. All Rights Reserved	
1st Boot Device	Floppy
2nd Boot Device	IDE-0
3rd Boot Device	CDROM
S.M.A.R.T. for Hard Disks	Disabled
BootUp Num-Lock	On
Floppy Drive Seek	Disabled
Password Check	Setup
BIOS Flash Protection	Auto
ESC : Quit ↑↓ ←→ : Select Item F1 : Help PU/PD/+/- : Modify F5 :Old Values (Shift)F2:Color F6 : Fail-Safe F8: Flash Utility F7 : Optimized	

Figure 3: BIOS Features Setup

- **1st / 2nd / 3rd Boot Device**

Floppy	Set your boot device priority to Floppy.
ZIP A: / LS120	Set your boot device priority to ZIP A: / LS120.
CDROM	Set your boot device priority to CDROM.
SCSI	Set your boot device priority to SCSI.
NETWORK	Set your boot device priority to NETWORK.
USB FDD	Set your boot device priority to USB FDD.
IDE-0-IDE-3	Set your boot device priority to IDE-0~IDE-3.
Disabled	Disable this function.
ATAPI ZIP C:	Set your boot device priority to ATAPI ZIP C:.

- **S.M.A.R.T. for Hard Disks**

Enabled	Enabled S.M.A.R.T. Feature for Hard Disks.
Disabled	Disabled S.M.A.R.T. Feature for Hard Disks. (Default Value)

- **Boot Up Num-Lock**

On	Keypad is number keys. (Default Value)
Off	Keypad is arrow keys.

- **Floppy Drive Seek**

During POST, BIOS will determine if the floppy disk drive installed is 40 or 80 tracks. 360 type is 40 tracks while 720 , 1.2 and 1.44 are all 80 tracks.

Enabled	BIOS searches for floppy disk drive to determine if it is 40 or 80 tracks. Note that BIOS can't differentiate between from 720, 1.2 or 1.44 drive type as they are all 80 tracks.
Disabled	BIOS will not search for the type of floppy disk drive by track number. Note that there will not be any warning message if the drive installed is 360. (Default Value)

- **Password Check**

 Please refer to the detail on P.62

Setup	The user must enter correct password in order to access BIOS setup utility. (Default Value)
Always	The user must enter correct password in order to access the system and/or BIOS Setup.

- **BIOS Flash Protection**

This field lets you determine the states that flash BIOS

Enabled	During POST, DMI/ESCD would not be updated. But flash tools can update BIOS always
Auto	BIOS enables flash write access automatically when updating BIOS data/DMI/ESCD. (Default Value)

Chipset Features Setup

 We would not suggest you change the chipset default setting unless you really need it.

AMBIOS SETUP – CHIPSET FEATURES SETUP	
(C) 1999 American Megatrends, Inc. All Rights Reserved	
Configure Timing by SPD	Disabled
DRAM Frequency	100MHz
SDRAM CAS# Latency	3
AGP Mode	4X
AGP Comp. Driving	Auto
Manual AGP Comp. Driving	CB
AGP Fast Write	Disabled
AGP Aperture Size	64MB
USB Controller	All USB Port
USB Legacy Support	Disabled
ESC : Quit ↑↓ ←→ : Select Item F1 : Help PU/PD/+/- : Modify F5 : Old Values (Shift)F2:Color F6 : Fail-Safe F8: Flash Utility F7 : Optimized	

Figure 4: Chipset Features Setup

- **Configure Time by SPD**

Disabled	Disable Configure Time by SPD function. (Default Value)
Enabled	Enable Configure Time by SPD function.

- **DRAM Frequency**

100MHz	Set DRAM Frequency to 100MHz. (Default Value)
133MHz	Set DRAM Frequency to 133MHz.

- **SDRAM CAS# Latency**

2	For Fastest SDRAM DIMM module.
3	For Slower SDRAM DIMM module. (Default Value)

- **AGP Mode**

4X	Set AGP Mode to 4X (Only if the AGP Card support 4X Rate). (Default Value)
1X	Set AGP Mode to 1X.
2X	Set AGP Mode to 2X.

- **AGP Comp. Driving**

Auto	Set AGP Comp. Driving to Auto. (Default Value)
Manual	Set AGP Comp. Driving to Manual.

If AGP Comp. Driving is Manual.

Manual AGP Comp. Driving:	00~FF
---------------------------	-------

- **AGP Fast Write**

Enabled	Enable this function only if the AGP Card support Fast Write Function. (Enable this function can increase AGP performance).
Disabled	Disable this function. (Default Value)

- **AGP Aperture Size**

4MB	Display AGP Aperture Size is 4MB.
8MB	Display AGP Aperture Size is 8 MB.
16MB	Display AGP Aperture Size is 16 MB.
32MB	Display AGP Aperture Size is 32 MB.
64MB	Display AGP Aperture Size is 64 MB. (Default Value)
128MB	Display AGP Aperture Size is 128 MB.
256MB	Display AGP Aperture Size is 256 MB.

- **USB Controller**

All USB Port	Enable All USB Ports 0,1,2,3. (Default Value)
Disabled	Disable USB Controller.
USB Port 0&1	Enable USB Ports 0&1.
USB Port 2&3	Enable USB Ports 2&3.

- **USB Legacy Support**

Keyboard/FDD	Enable USB Legacy Support for USB Keyboard & USB Floppy.
KB/Mouse/FDD	Enable USB Legacy Support for USB Keyboard/USB Mouse & USB Floppy.
Disabled	Disable USB Legacy Support Function. (Default Value)

Power Management Setup

AMIBIOS SETUP – POWER MANAGEMENT SETUP (C) 1999 American Megatrends, Inc. All Rights Reserved			
ACPI Standby State	S1/POS	RTC Alarm Hour	12
USB Dev Wakeup From S3-S5	Disabled	RTC Alarm Minute	30
Suspend Time Out (Minute)	Disabled	RTC Alarm Second	30
Display Activity	Ignore		
IRQ3	Monitor		
IRQ4	Monitor		
IRQ5	Ignore		
IRQ7	Monitor		
IRQ9	Ignore		
IRQ10	Ignore		
IRQ11	Ignore		
IRQ13	Ignore		
IRQ14	Monitor		
IRQ15	Ignore		
Soft-Off by Power Button	Instant-Off		
System after AC Back	Last State	ESC : Quit	↑↓ ←→: Select Item
Resume On Ring/LAN	Enabled	F1 : Help	PU/PD/+/- : Modify
Resume On PME#	Enabled	F5 :Old Values	(Shift)F2:Color
Resume On RTC Alarm	Disabled	F6 : Fail-Safe	F8: Flash Utility
RTC Alarm Date	15	F7 : Optimized	

Figure 5: Power Management Setup

- **ACPI Standby State**

S1/POS	Set ACPI Standby State to S1/POS (Power On Suspend). (Default value)
S3/STR	Set ACPI Standby State to S3/STR (Suspend To RAM).

- **USB Dev Wakeup From S3-S5**

Enabled	Enable USB Dev Wakeup from ACPI S3, S4 and S5 mode.
Disabled	Disable USB Dev Wakeup from ACPI S3, S4 and S5 mode. (Default Value)

- **Suspend Time Out (Minute.)**

 System enters suspend power state when the length of period selected by this optional has expired.

Disabled	Disable the timer to enter suspend mode. (Default Value)
1min ~ 60min	Set the timer to enter suspend mode.

- **Display Activity**

Ignore	System will ignore display activity and enter suspend mode. (Default Value)
Monitor	System will not enter suspend mode when there is display activity.

- **IRQ3-IRQ15**

Ignore	Ignore IRQ3 -IRQ15.
Monitor	IRQ3-IRQ15 event can wake up the system from sleep state (S1).

- **Soft-off by Power Button**

Instant off	The user press the power button once, he can turn off the system. (Default Value)
Suspend	The user press the power button once, then he can enter suspend mode.

- **System after AC Back**

Off	When AC-power back to the system, the system will be in "Off" state.
On	When AC-power back to the system, the system will be in "On" state.
Last State	When AC-power back to the system, the system will return to the Last state before AC-power off. (Default Value)

- **Resume On Ring / LAN**

Disabled	Disable Resume On Ring / LAN.
Enabled	The modem ring / LAN wake up will bring the system out of soft-off or suspend state if this option is set "Enabled". (Default Value)

- **Resume On PME#**

Disabled	Disable Resume On PME#.
Enabled	The PME event wake up will bring the system out of soft-off or suspend state if this option is set "Enabled". (Default Value)

- **Resume On RTC Alarm**

You can set "Resume On RTC Alarm" item to enabled and key in Data/time to power on system.

Disabled	Disable this function. (Default Value)
Enabled	Enable alarm function to POWER ON system.

If the default value is Enabled.

RTC Alarm Date:	Every Day, 1-31
RTC Alarm Hour:	0-23
RTC Alarm Minute:	0-59
RTC Alarm Second:	0-59

PNP/PCI Configuration

AMIBIOS SETUP – PNP / PCI CONFIGURATION (C) 1999 American Megatrends, Inc. All Rights Reserved		
VGA Frame Buffer Size	16MB	
VGA Boot from	PCI	
PCI Slot 1 IRQ Priority	Auto	
PCI Slot 2 IRQ Priority	Auto	
PCI Slot 3 IRQ Priority	Auto	
IRQ 3	PCI/PnP	
IRQ 4	PCI/PnP	
IRQ 5	PCI/PnP	
IRQ 7	PCI/PnP	
IRQ 9	PCI/PnP	
IRQ 10	PCI/PnP	
IRQ 11	PCI/PnP	
IRQ 14	PCI/PnP	
IRQ 15	PCI/PnP	
		ESC : Quit ↑↓ ←→ : Select Item F1 : Help PU/PD/+/- : Modify F5 : Old Values (Shift)F2:Color F6 : Fail-Safe F8: Flash Utility F7 : Optimized

Figure 6: PNP/PCI Configuration

- **VGA Frame Buffer Size**

Disabled	Disable this function.
8MB	Set VGA Frame Buffer Size to 8MB.
16MB	Set VGA Frame Buffer Size to 16MB. (Default Value)
32MB	Set VGA Frame Buffer Size to 32MB.

- **VGA Boot From**

AGP	Set VGA Boot from AGP VGA Card.
PCI	Set VGA Boot from PCI VGA Card. (Default Value)

- **PCI Slot 1 / 2 / 3 IRQ Priority**

Auto	The system will reserved a free IRQ for PCI slot 1 / 2 / 3 device. (Default Value)
3	The system will reserved IRQ3 for PCI slot 1 / 2 / 3 device if no legacy ISA device using IRQ3.
4	The system will reserved IRQ for PCI slot 1 / 2 / 3 device if no legacy ISA device using IRQ4.

5	The system will reserved IRQ5 for PCI slot 1 / 2 / 3 device if no legacy ISA device using IRQ5.
7	The system will reserved IRQ7 for PCI slot 1 / 2 / 3 device if no legacy ISA device using IRQ7.
9	The system will reserved IRQ9 for PCI slot 1 / 2 / 3 device if no legacy ISA device using IRQ9.
10	The system will reserved IRQ10 for PCI slot 1 / 2 / 3 device if no legacy ISA device using IRQ10.
11	The system will reserved IRQ11 for PCI slot 1 / 2 / 3 device if no legacy ISA device using IRQ11.

● **IRQ (3, 4, 5, 7, 9, 10, 11, 14, 15)**

ISA/EISA	The resource is used by Legacy ISA device.
PCI/PnP	The resource is used by PCI/ PnP device. (Default Value)

Load Fail-Safe Defaults

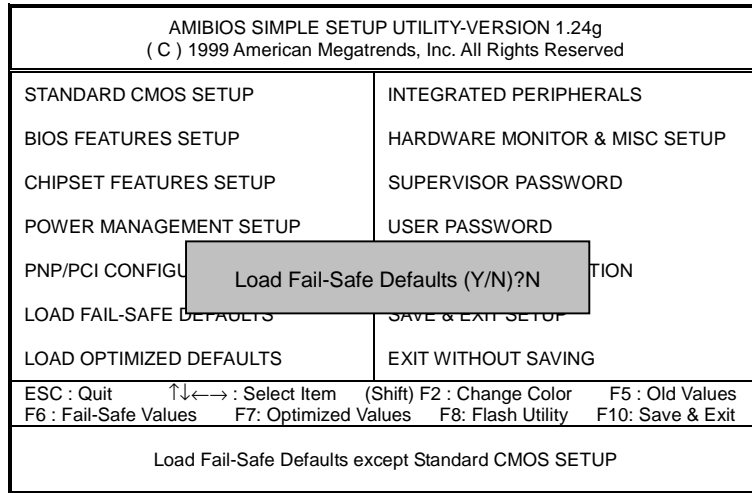

Figure 7: Load Fail-Safe Defaults

- **Load Fail-Safe Defaults**

Fail-Safe defaults contain the most appropriate system parameter values of to configure the system to achieve maximum stability.

Load Optimized Defaults

AMBIOS SIMPLE SETUP UTILITY-VERSION 1.24g (C) 1999 American Megatrends, Inc. All Rights Reserved	
STANDARD CMOS SETUP	INTEGRATED PERIPHERALS
BIOS FEATURES SETUP	HARDWARE MONITOR & MISC SETUP
CHIPSET FEATURES SETUP	SUPERVISOR PASSWORD
POWER MANAGEMENT SETUP	USER PASSWORD
PNP/PCI CONFIGURATION	Load Optimized Defaults (Y/N)?N
LOAD FAIL-SAFE DEFAULTS	SAVE & EXIT SETUP
LOAD OPTIMIZED DEFAULTS	EXIT WITHOUT SAVING
ESC : Quit ↑↓←→ : Select Item (Shift) F2 : Change Color F5 : Old Values F6 : Fail-Safe Values F7 : Optimized Values F8 : Flash Utility F10 : Save & Exit	
Load Optimized Defaults except Standard CMOS SETUP	

Figure 8: Load Optimized Defaults

- **Load Optimized Defaults**

Optimized defaults contain the most appropriate system parameter values to configure the system to achieve maximum performance.

Integrated Peripherals

AMIBIOS SETUP – INTEGRATED PERIPHERALS (C) 1999 American Megatrends, Inc. All Rights Reserved			
OnBoard FDC	Auto	MPU-401	Disabled
OnBoard Serial Port 1	Auto	MPU-401 I/O Address	330h-333h
OnBoard Serial Port 1	Auto	Game Port (200h-207h)	Enabled
Serial Port2 Mode	Normal		
Duplex Mode	N/A		
OnBoard Parallel Port	Auto		
Parallel Port Mode	ECP		
Parallel Port DMA	Auto		
Parallel Port IRQ	Auto		
OnBoard IDE	Both		
Enhance ATAPI Performance	Disabled		
IDE Boot Delay(Sec.)	7		
OnBoard AC'97 Audio	Auto		
OnBoard MC'97 Modem	Auto		
OnBoard Legacy Audio	Enabled	ESC : Quit	↑↓ ←→: Select Item
Sound Blaster	Disabled	F1 : Help	PU/PD/+/- : Modify
SB I/O Base Address	220h-22Fh	F5 :Old Values	(Shift)F2:Color
SB IRQ Select	5	F6 : Fail-Safe	F8: Flash Utility
SB DMA Select	1	F7 : Optimized	

Figure 9: Integrated Peripherals

- **Onboard FDC**

Disabled	Disable this function.
Enabled	Enable on board floppy disk controller.
Auto	Set the floppy disk controller automatically. (Default Value)

- **OnBoard Serial Port 1**

Auto	BIOS will automatically setup the port 1 address. (Default Value)
3F8/COM1	Enable onboard Serial port 1 and address is 3F8.
2F8/COM2	Enable onboard Serial port 1 and address is 2F8.
3E8/COM3	Enable onboard Serial port 1 and address is 3E8.
2E8/COM4	Enable onboard Serial port 1 and address is 2E8.
Disabled	Disable onboard Serial port 1.

- **OnBoard Serial Port 2**

Auto	BIOS will automatically setup the port 2 address. (Default Value)
3F8/COM1	Enable onboard Serial port 2 and address is 3F8.
2F8/COM2	Enable onboard Serial port 2 and address is 2F8.
3E8/COM3	Enable onboard Serial port 2 and address is 3E8.

2E8/COM4	Enable onboard Serial port 2 and address is 2E8.
Disabled	Disable onboard Serial port 2.

- **Serial Port2 Mode**

Normal	Set onboard I/O chip Serial Port 2 to Normal Mode. (Default Value)
IrDA	Onboard I/O chip supports IrDA.
ASK IR	Onboard I/O chip supports ASK IR.

- **Duplex Mode**

Half Duplex	IR Function Duplex Half.
N/A	Disable this function. (Default Value)
Full Duplex	IR Function Duplex Full.

- **OnBoard Parallel port**

378	Set On Board LPT port and address to 378.
278	Set On Board LPT port and address to 278.
3BC	Set On Board LPT port and address to 3BC.
Auto	Set On Board LPT port Automatically. (Default Value)
Disabled	Disable this function.

- **Parallel Port Mode**

EPP	Using Parallel port as Enhanced Parallel Port.
ECP	Using Parallel port as Extended Capabilities Port. (Default Value)
Normal	Normal Operation.
EPP+ECP	Using Parallel port as Enhanced Parallel Port & Extended Capabilities Port.

- **Parallel Port DMA**

Auto	Set Auto to parallel port mode DMA Channel. (Default Value)
3	Set Parallel Port DMA to 3.
1	Set Parallel Port DMA to 1.
0	Set Parallel Port DMA to 0.

- **Parallel Port IRQ**

7	Set Parallel Port IRQ to 7.
Auto	Set Auto to parallel Port IRQ DMA Channel. (Default Value)
5	Set Parallel Port IRQ to 5.

- **OnBoard IDE**

Disabled	Disable OnBoard IDE.
Both	Both Primary & Secondary IDE channel will be enabled. (Default Value)
Primary	Only Primary IDE channel is enable.
Secondary	Only Secondary IDE channel is enable.

- **Enhance ATAPI Performance**

If you wish to maximize the performance of your ATAPI devices , set "Enhance ATAPI Performance" as "Enabled" . Please note, enabling this function may cause your ATAPI devices become unstable. For power End-User use only.

Disabled	Disable Enhance ATAPI Performance. (Default Value)
Enabled	Enhance ATAPI Performance function.

- **IDE Boot Delay (Sec.)**

1-10	Set IDE Boot Delay to 1~10 Sec. (Default Value: 7)
Disabled	Disable this function.

- **OnBoard AC'97 Audio**

Auto	Enabled onboard AC'97 audio function. (Default Value)
Disabled	Disable this function.

- **OnBoard MC'97 Modem**

Auto	BIOS will search MC97 Codec (AMR Modem Card). If found, MC97 function will be enabled. If no MC97 Codec found, MC97 function will be disabled. (Default Value)
Disabled	Disable this function.

- **OnBoard Legacy Audio**

Enabled	Enable OnBoard Legacy Audio. (Default Value)
Disabled	Disable OnBoard Legacy Audio.

- **Sound Blaster**

Enabled	Enable Sound Blaster.
Disabled	Disable Sound Blaster. (Default Value)

- **SB I/O Base Address**

220h-22Fh	Set SB I/O Base Address to 220h-22Fh. (Default Value)
280h-28Fh	Set SB I/O Base Address to 280h-28Fh.
260h-26Fh	Set SB I/O Base Address to 260h-26Fh.
240h-24Fh	Set SB I/O Base Address to 240h-24Fh.

- **SB IRQ Select**

IRQ 5 / 7 / 9 / 10. (Default Value: 5)

- **SB DMA Select**

DMA 0 / 1 / 2 / 3. (Default Value: 1)
--

- **MPU-401**

Enabled	Enable MPU-401.
Disabled	Disable MPU-401. (Default Value)

Ps. When Force Feedback joystick is used, MPU-401 needs to be Enable.

- **MPU-401 I/O Address**

330h-333h	Set MPU-401 I/O Address to 330h-333h. (Default Value)
300h-303h	Set MPU-401 I/O Address to 300h-303h.
310h-313h	Set MPU-401 I/O Address to 310h-313h.
320h-323h	Set MPU-401 I/O Address to 320h-323h.

- **Game Port (200h-207h)**

Disabled	Disable Game Port (200h-207h).
Enabled	Enable Game Port (200h-207h). (Default Value)

Hardware Monitor & MISC Setup

AMIBIOS SETUP – HARDWARE MONITOR & MISC SETUP (C) 1999 American Megatrends, Inc. All Rights Reserved	
CPU Temperature	47°C/116°F
System Temperature	32°C/89°F
CPU Fan Speed	7123 RPM
System Fan Speed	0 RPM
Vcore	1.750 V
Vdd	3.050 V
Vcc3	3.340 V
+5.000V	4.996 V
+12.000V	12.166 V
ESC : Quit ↑↓ ←→ : Select Item F1 : Help PU/PD/+/- : Modify F5 :Old Values (Shift)F2:Color F6 : Fail-Safe F8: Flash Utility F7 : Optimized	

Figure 10: Hardware Monitor & MISC Setup

- **CPU Temperature. (°C / °F)**
Detect CPU Temperature automatically.
- **System Temperature. (°C / °F)**
Detect System Temperature automatically.
- **CPU Fan Speed**
Detect CPU Fan speed status automatically.
- **System Fan Speed**
Detect System Fan speed status automatically.
- **Voltage (V) Vcore / Vdd / Vcc3 / +5V / +12V**
Detect system's voltage status automatically.

Set Supervisor / User Password

When you select this function, the following message will appear at the center of the screen to assist you in creating a password.

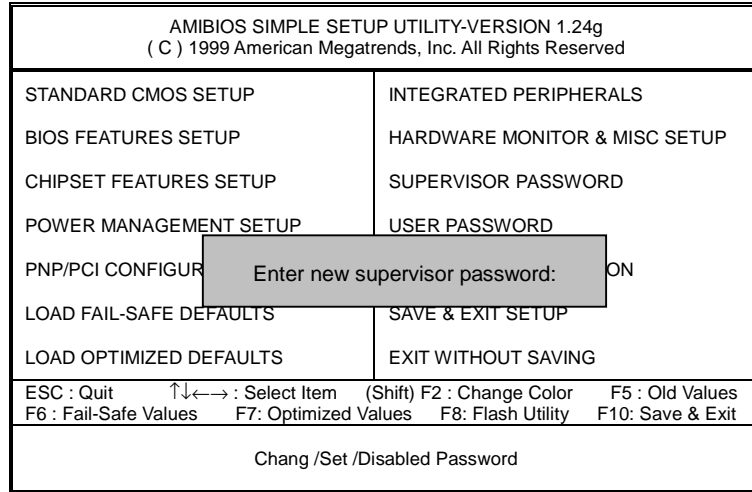

Figure 11: Password Setting

Type the password, up to six characters, and press <Enter>. You will be asked to confirm the password. Type the password again and press <Enter>. You may also press <Esc> to abort the selection and not enter a password.

To disable password, just press <Enter> when you are prompted to enter password. A message **"PASSWORD DISABLED"** will appear to confirm the password being disabled. Once the password is disabled, the system will boot and you can enter Setup freely.

The BIOS Setup program allows you to specify two separate passwords: a **SUPERVISOR PASSWORD** and a **USER PASSWORD**. When disabled, anyone may access all BIOS Setup program function. When enabled, the Supervisor password is required for entering the BIOS Setup program and having full configuration fields, the User password is required to access only basic items.

If you select **"Always"** at **"Password Check"** in BIOS Features Setup Menu, you will be prompted for the password every time the system is rebooted or any time you try to enter Setup Menu.

If you select **"Setup"** at **"Password Check"** in BIOS Features Setup Menu, you will be prompted only when you try to enter Setup.

IDE HDD AUTO Detection

AMBIOS SETUP – STANDARD CMOS SETUP (C) 1999 American Megatrends, Inc. All Rights Reserved							
Date (mm/dd/yyyy) : Mon Feb 05, 2001 Time (hh/mm/ss) : 10:36:24							
TYPE	SIZE	CYLS	HEAD	PRECOMP	LANDZ	SECTOR	MODE
Pri Master : Not Installed Pri Slave : Not Installed Sec Master : Not Installed Sec Slave : Not Installed							
Floppy Drive A: 1.44 MB 3 ½ Floppy Drive B: Not Installed				Base Memory : 640 Kb Other Memory: 384 Kb Extended Memory: 111Mb Total Memory: 112Mb			
Boot Sector Virus Protection : Disabled							
Month: Jan – Dec Day: 01 – 31 Year: 1990– 2099				ESC : Exit ↑↓ : Select Item PU/PD/+/- : Modify (Shift)F2 : Color			

Figure 12: IDE HDD Auto Detection

Type "Y" will accept the H.D.D. parameter reported by BIOS.

Type "N" will keep the old H.D.D. parameter setup. If the hard disk cylinder number is over 1024, then the user can select LBA mode or LARGER mode for DOS partition larger than 528 MB.

Save & Exit Setup

AMIBIOS SIMPLE SETUP UTILITY-VERSION 1.24g (C) 1999 American Megatrends, Inc. All Rights Reserved	
STANDARD CMOS SETUP	INTEGRATED PERIPHERALS
BIOS FEATURES SETUP	HARDWARE MONITOR & MISC SETUP
CHIPSET FEATURES SETUP	SUPERVISOR PASSWORD
POWER MANAGEMENT SETUP	USER PASSWORD
PNP/PCI CONFIGURATION	
LOAD FAIL-SAFE	SAVE to CMOS and EXIT(Y/N)? Y
LOAD OPTIMIZED DEFAULTS	EXIT WITHOUT SAVING
ESC : Quit ↑↓←→ : Select Item (Shift) F2 : Change Color F5 : Old Values F6 : Fail-Safe Values F7: Optimized Values F8: Flash Utility F10: Save & Exit	
Save Data to CMOS & Exit Setup	

Figure 13: Save & Exit Setup

Type "Y" will quit the Setup Utility and save the user setup value to RTC CMOS.

Type "N" will return to Setup Utility.

Exit Without Saving

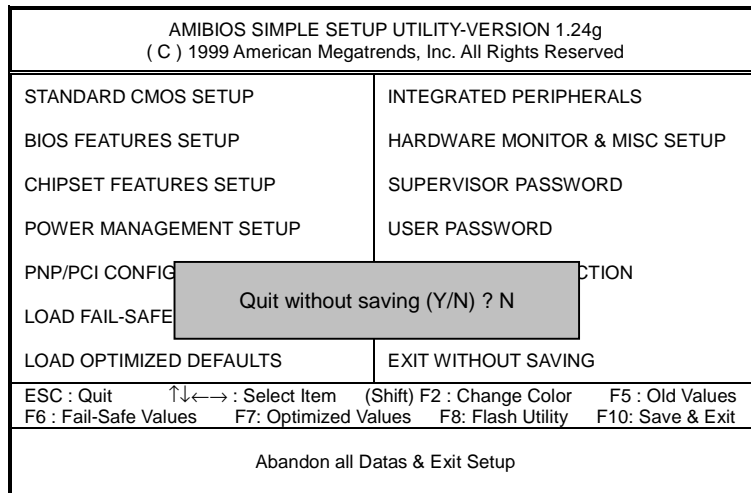

Figure 14: Exit Without Saving

Type "Y" will quit the Setup Utility without saving to RTC CMOS.

Type "N" will return to Setup Utility.

Technical Support / RMA Sheet

Customer/Country:	Company:	Phone No.:
Contact Person:	E-mail Add. :	
Model name/Lot Number:		PCB revision:
BIOS version:	O.S./A.S.:	

Hardware Configuration	Mfs.	Model name	Size:	Driver/Utility:
CPU				
Memory Brand				
Video Card				
Audio Card				
HDD				
CD-ROM / DVD-ROM				
Modem				
Network				
AMR / CNR				
Keyboard				
Mouse				
Power supply				
Other Device				

 Problem Description:

Appendix

Picture below are shown in Windows ME (VUCD driver version 1.81)
Appendix A: VIA Chipsets Driver Installation

A. VIA 4 in 1 Service Pack Driver:

Insert the driver CD-title that came with your motherboard into your CD-ROM driver, the driver CD-title will auto start and show the installation guide. If not, please double click the CD-ROM device icon in "My computer", and execute the setup.exe.

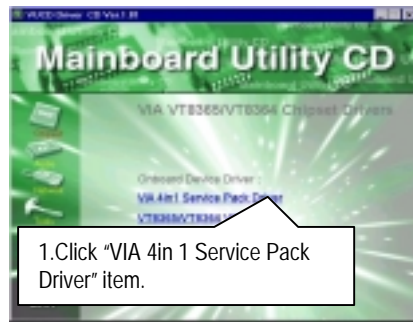

(1)

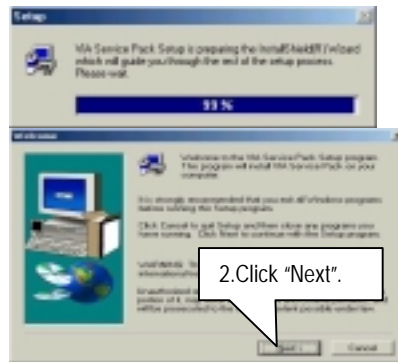

(2)

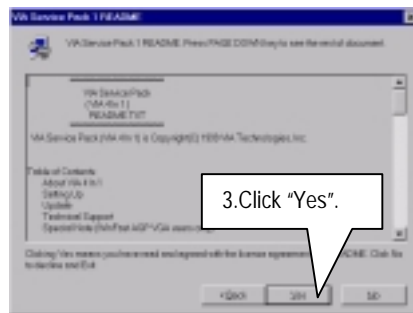

(3)

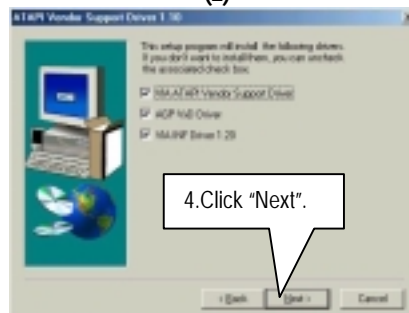

(4)

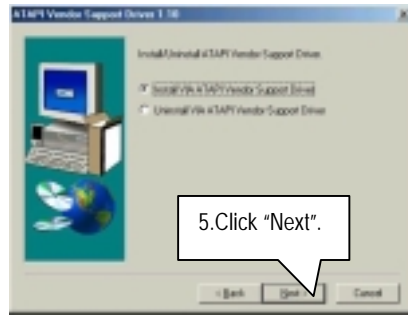

(5)

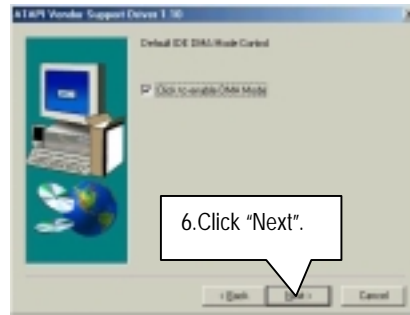

(6)

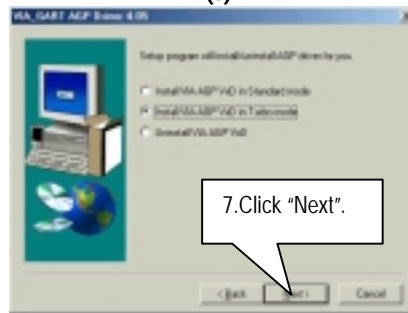

(7)

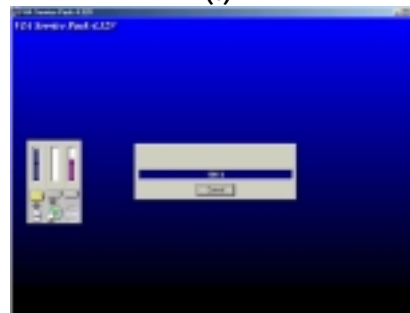

(8)

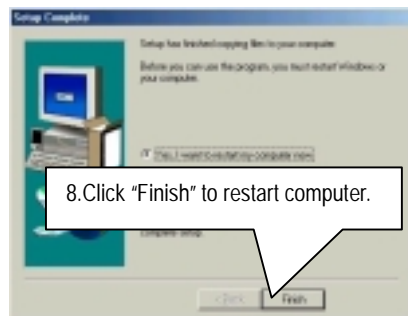

(9)

B. VT8365/VT8364 VGA Driver:

Insert the driver CD-title that came with your motherboard into your CD-ROM driver, the driver CD-title will auto start and show the installation guide. If not, please double click the CD-ROM device icon in "My computer", and execute the setup.exe.

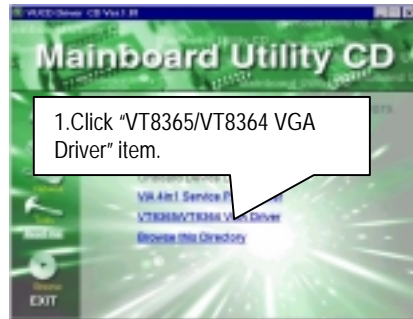

(1)

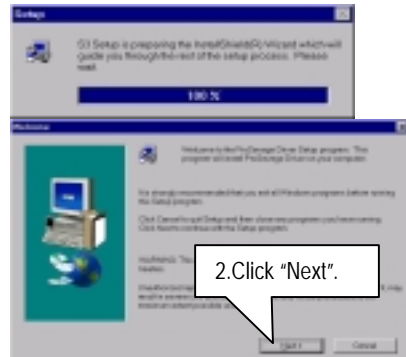

(2)

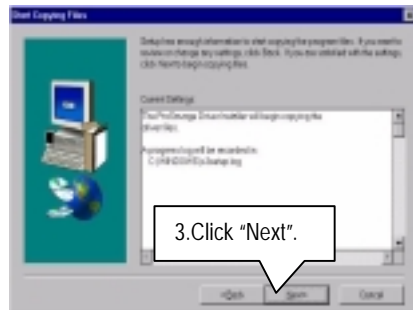

(3)



(4)

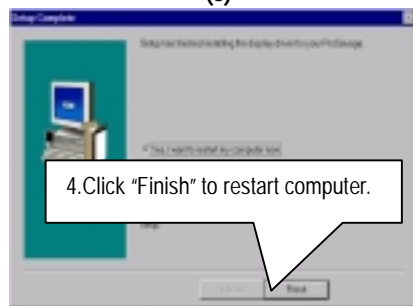

(5)

Appendix B: VIA AC'97 Audio Driver

Insert the driver CD-title that came with your motherboard into your CD-ROM driver, the driver CD-title will auto start and show the installation guide. If not, please double click the CD-ROM device icon in "My computer", and execute the setup.exe.



(1)

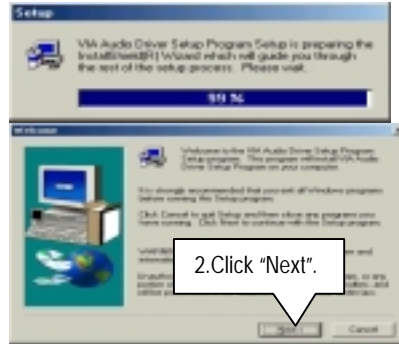

(2)

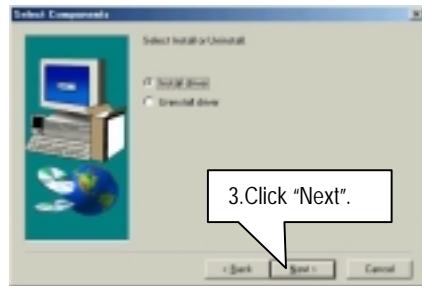

(3)

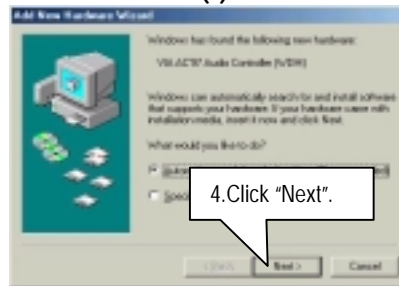

(4)

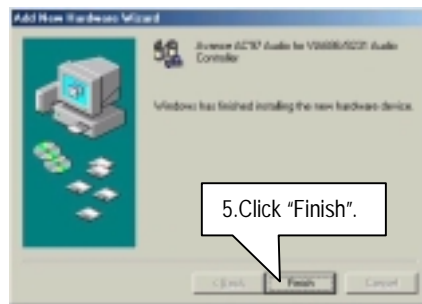

(5)

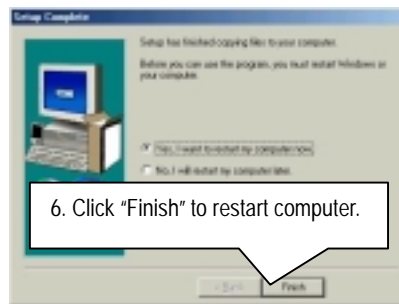

(6)

Appendix C: BIOS Flash Procedure

BIOS update procedure:

If your OS is Win9X, we recommend that you used Gigabyte @BIOS™ Program to flash BIOS.

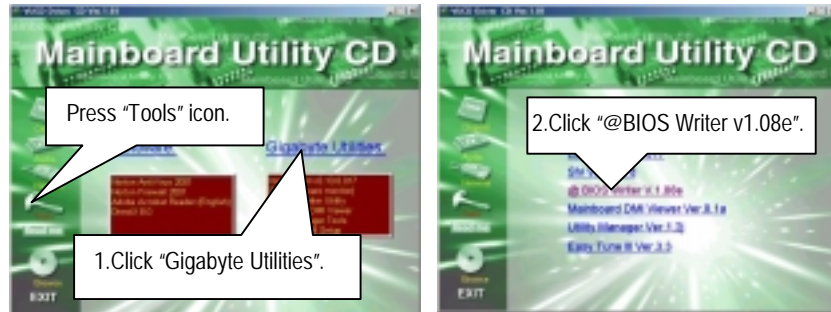

(1)

(2)

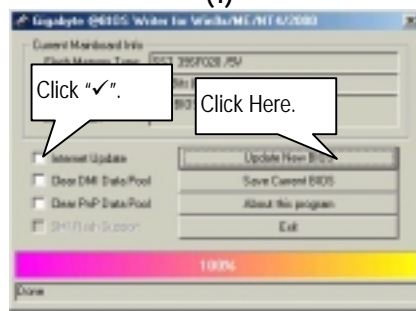

(3)

Methods and steps:

- I. Update BIOS through Internet
 - a. Click "Internet Update" icon
 - b. Click "Update New BIOS" icon
 - c. Select @BIOS™ sever ("Gigabyte @BIOS™ sever 1 in Taiwan" and "Gigabyte @BIOS™ sever 2 in Taiwan" are available for now, the others will be completed soon)
 - d. Select the exact model name on your motherboard
 - e. System will automatically download and update the BIOS.

II. Update BIOS **NOT** through Internet:

- a. **Do not** click "Internet Update" icon
- b. Click "Update New BIOS"
- c. Please select "All Files" in dialog box while opening the old file.
- d. Please search for BIOS unzip file, downloading from internet or any other methods (such as: 7ZMMHC.F1).
- e. Complete update process following the instruction.

III. Save BIOS

In the very beginning, there is "Save Current BIOS" icon shown in dialog box. It means to save the current BIOS version.

IV. Check out supported motherboard and Flash ROM:

In the very beginning, there is "About this program" icon shown in dialog box. It can help you check out which kind of motherboard and which brand of Flash ROM are supported.

Note:

- a. In method I, if it shows two or more motherboard's model names to be selected, please make sure your motherboard's model name again. Selecting wrong model name will cause the system unbooted.
- b. In method II, be sure that motherboard's model name in BIOS unzip file are the same as your motherboard's. Otherwise, your system won't boot.
- c. In method I, if the BIOS file you need cannot be found in @BIOS™ server, please go onto Gigabyte's web site for downloading and updating it according to method II.
- d. Please note that any interruption during updating will cause system unbooted

Or else you can select flash BIOS in DOS mode.

☛ Please check your **BIOS vendor (AMI or AWARD)**, your **motherboard name** and **PCB version** on the motherboard.

1. Format a bootable system floppy diskette by the command "**format a:/s**" in command mode.
2. Visit the Gigabyte website at [http:// www.gigabyte.com.tw](http://www.gigabyte.com.tw) , Select the BIOS file you need and download it to your bootable floppy diskette.
3. Insert the bootable diskette containing the BIOS file into the floppy diskette driver.
4. Assuming that the floppy diskette driver is A, reboot the system by using the A: driver. At the A: > prompt, run the BIOS upgraded file by executing the Flash BIOS utility and the BIOS file with its appropriate extension.

Example: (AMI tool) (Where 7zmmhc.f1 is name of the BIOS file name)

```
A:>flashxxx.exe 7zmmhc.f1 ↵
```

Example: (Award tool) (Where 7zmmhc.f1 is name of the BIOS file name)

```
A:>Awdflash.exe 7zmmhc.f1 ↵
```

5. Upon pressing the <Enter> key, a flash memory writer menu will appear on screen. Enter the new BIOS file name with its extension filename into the text box after file name to program.
6. If you want to save the old BIOS file(perform as soon as system is operational, this is recommended), select Y to **DO YOU WANT TO SAVE BIOS**, then type the old BIOS filename and the extension after filename to save: This option allows you to copy the contents of the flash memory chip onto a diskette, giving you a backup copy of the original motherboard BIOS in case you need to re-install it. Select N to **DO YOU WANT TO SAVE BIOS**, if you don't want to save the old BIOS file.
7. After the decision to save the old BIOS file or not is made, select Y to **ARE YOU SURE TO PROGRAM** when the next menu appear; wait until a message showing Power Off or Reset the system appears. Then turn off your system.
8. Remove the diskette and restart your system.
9. Hold down <Delete> key to enter BIOS setup. You must select "Load Setup BIOS Default" to activate the new BIOS, then you may set other item from the main menu.

Appendix D: Issues To Beware Of When Installing CNR

Please use standard CNR card like the one in order to avoid mechanical problem.
(See Figure A)

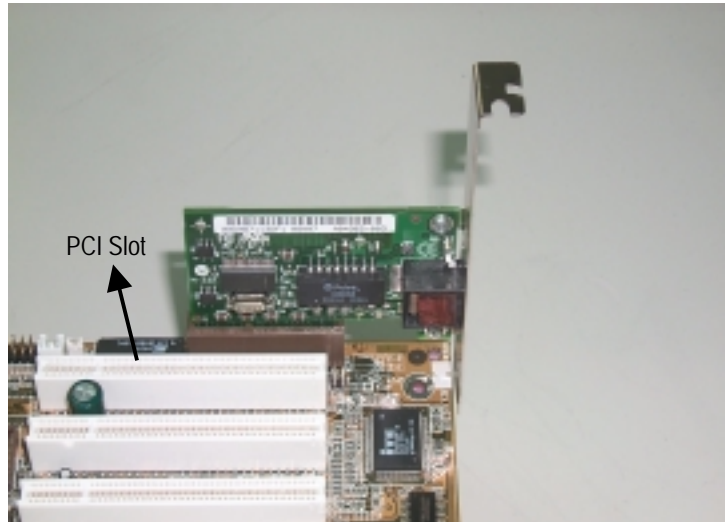

Figure A: Standard CNR Card

Appendix E: Acronyms

Acronyms	Meaning
ACPI	Advanced Configuration and Power Interface
APM	Advanced Power Management
AGP	Accelerated Graphics Port
AMR	Audio Modem Riser
ACR	Advanced Communications Riser
BIOS	Basic Input / Output System
CPU	Central Processing Unit
CMOS	Complementary Metal Oxide Semiconductor
CRIMM	Continuity RIMM
CNR	Communication and Networking Riser
DMA	Direct Memory Access
DMI	Desktop Management Interface
DIMM	Dual Inline Memory Module
DRM	Dual Retention Mechanism
DRAM	Dynamic Random Access Memory
DDR	Double Data Rate
ECP	Extended Capabilities Port
ESCD	Extended System Configuration Data
ECC	Error Checking and Correcting
EMC	Electromagnetic Compatibility
EPP	Enhanced Parallel Port
ESD	Electrostatic Discharge
FDD	Floppy Disk Device
FSB	Front Side Bus
HDD	Hard Disk Device
IDE	Integrated Dual Channel Enhanced
IRQ	Interrupt Request
I/O	Input / Output
IOAPIC	Input Output Advanced Programmable Input Controller
ISA	Industry Standard Architecture
LAN	Local Area Network
LBA	Logical Block Addressing
LED	Light Emitting Diode
MHz	Megahertz
MIDI	Musical Interface Digital Interface
MTH	Memory Translator Hub
MPT	Memory Protocol Translator
NIC	Network Interface Card
OS	Operating System

To be continued...

Acronyms	Meaning
OEM	Original Equipment Manufacturer
PAC	PCI A.G.P. Controller
POST	Power-On Self Test
PCI	Peripheral Component Interconnect
RIMM	Rambus in-line Memory Module
SCI	Special Circumstance Instructions
SECC	Single Edge Contact Cartridge
SRAM	Static Random Access Memory
SMP	Symmetric Multi-Processing
SMI	System Management Interrupt
USB	Universal Serial Bus
VID	Voltage ID