

FCC Compliance Statement:

<p style="text-align: center;">DECLARATION OF CONFORMITY <small>Per FCC Part 2 Section 2.107(a)</small></p> <p style="text-align: center;">FCC</p> <p>Responsible Party Name: G.B.T. INC. Address: 18305 Valley Blvd., Suite 6A LA Puente, CA 91744 Phone/Fax No: (818) 854-9338 / (818) 854-9339</p> <p>hereby declares that the product Product Name: Mother Board Model Number: GA-7VFX-P</p> <p>Conforms to the following specifications: FCC Part 15, Subpart B, Section 15.107(a) and Section 15.109(a), Class B Digital Device</p> <p>Supplementary Information: This device complies with part 15 of the FCC Rules. Operation is subject to the following two conditions: (1) This device may not cause harmful interference, and (2) this device must accept any interference received, including that which may cause undesired operation.</p> <p>Representative Person's Name: <u>ERIC LU</u> Signature: <u>Eric Lu</u> Date: <u>Sep. 26, 2001</u></p>
--

This equipment has been tested and found to comply with limits for a Class B digital device, pursuant to Part 15 of the FCC rules. These limits are designed to provide reasonable protection against harmful interference in residential installations. This equipment generates, uses, and can radiate radio frequency energy, and if not installed and used in accordance with the instructions, may cause harmful interference to radio communications. However, there is no guarantee that interference will not occur in a particular installation. If this equipment does cause interference to radio or television equipment reception, which can be

determined by turning the equipment off and on, the user is encouraged to try to correct the interference by one or more of the following measures:

- Reorient or relocate the receiving antenna
- Move the equipment away from the receiver
- Plug the equipment into an outlet on a circuit different from that to which the receiver is connected
- Consult the dealer or an experienced radio/television technician for additional suggestions

You are cautioned that any change or modifications to the equipment not expressly approved by the party responsible for compliance could void Your authority to operate such equipment.

This device complies with Part 15 of the FCC Rules. Operation is subjected to the following two conditions 1) this device may not cause harmful interference and 2) this device must accept any interference received, including interference that may cause undesired operation.

Declaration of Conformity

We, Manufacturer/Importer
(full address)

G.B.T. Technology Trading GmbH
Ausschlagler Weg 41, 1F, 20537 Hamburg, Germany

declare that the product
(description of the apparatus, system, installation to which it refers)

Mother Board
GA-7VTX-P

is in conformity with
(reference to the specification under which conformity is declared)
in accordance with 89/336 EEC-EMC Directive

- | | | | |
|---|--|--|--|
| <input type="checkbox"/> EN 55011 | Limits and methods of measurement of radio disturbance characteristics of industrial, scientific and medical (ISM high frequency equipment | <input type="checkbox"/> EN 61000-3-2*
<input checked="" type="checkbox"/> EN60555-2 | Disturbances in supply systems caused by household appliances and similar electrical equipment "Harmonics" |
| <input type="checkbox"/> EN55013 | Limits and methods of measurement of radio disturbance characteristics of broadcast receivers and associated equipment | <input type="checkbox"/> EN61000-3-3*
<input checked="" type="checkbox"/> EN60555-3 | Disturbances in supply systems caused by household appliances and similar electrical equipment "Voltage fluctuations" |
| <input type="checkbox"/> EN 55014 | Limits and methods of measurement of radio disturbance characteristics of household electrical appliances, portable tools and similar electrical apparatus | <input checked="" type="checkbox"/> EN 50081-1
<input checked="" type="checkbox"/> EN 50082-1 | Generic emission standard Part 1: Residual, commercial and light industry
Generic immunity standard Part 1: Residual, commercial and light industry |
| <input type="checkbox"/> EN 55015 | Limits and methods of measurement of radio disturbance characteristics of fluorescent lamps and luminaries | <input type="checkbox"/> EN 55081-2 | Generic emission standard Part 2: Industrial environment |
| <input type="checkbox"/> EN 55020 | Immunity from radio interference of broadcast receivers and associated equipment | <input type="checkbox"/> EN 55082-2 | Generic immunity standard Part 2: Industrial environment |
| <input checked="" type="checkbox"/> EN 55022 | Limits and methods of measurement of radio disturbance characteristics of information technology equipment | <input type="checkbox"/> ENV 55104 | Immunity requirements for household appliances tools and similar apparatus |
| <input type="checkbox"/> DIN VDE 0855
<input type="checkbox"/> part 10
<input type="checkbox"/> part 12 | Cabled distribution systems; Equipment for receiving and/or distribution from sound and television signals | <input type="checkbox"/> EN 50091- 2 | EMC requirements for uninterruptible power systems (UPS) |

CE marking



(EC conformity marking)

The manufacturer also declares the conformity of above mentioned product with the actual required safety standards in accordance with LVD 73/23 EEC

- | | | | |
|-----------------------------------|---|-------------------------------------|---|
| <input type="checkbox"/> EN 60065 | Safety requirements for mains operated electronic and related apparatus for household and similar general use | <input type="checkbox"/> EN 60950 | Safety for information technology equipment including electrical business equipment |
| <input type="checkbox"/> EN 60335 | Safety of household and similar electrical appliances | <input type="checkbox"/> EN 50091-1 | General and Safety requirements for uninterruptible power systems (UPS) |

Manufacturer/Importer

Signature : Rex Lin

(Stamp)

Date : Sep. 26, 2001

Name : Rex Lin

7VTX-P
AMD Athlon™/Duron™ Socket A Processor
Motherboard

USER'S MANUAL

AMD Athlon™/Duron™ Socket A Processor Motherboard
REV. 1.0 First Edition
12ME-7VTP-1001

How This Manual Is Organized

This manual is divided into the following sections:

1) Revision History	Manual revision information
2) Item Checklist	Product item list
3) Features	Product information & specification
4) Installation Guide	Instructions on setting up the motherboard
5) Block Diagram	Product block diagram
6) Suspend to RAM & Dual BIOS	Instructions on STR & Dual BIOS installation
7) Four Speaker & SPDIF	Four Speaker & SPDIF introduction
8) @BIOS™ & EasyTuneIII™	@BIOS™ & EasyTuneIII™ introduction
9) BIOS Setup	Instructions on setting up the BIOS software
10) Technical Support/RMA Sheet	Document equipment used for after sales service
11) Appendix	General reference

Table Of Content

Revision History	P.1
Item Checklist	P.2
Summary of Features	P.3
7VTX-P Motherboard Layout	P.5
Installation Guide	P. 6
Page Index for CPU Speed Setup / Connectors / Panel and Jumper Definition	P.14
Block Diagram	P.38
Suspend to RAM Installation	P.39
Dual BIOS Introduction	P.45
Four Speaker & SPDIF Introduction	P.52
@BIOS™ Introduction	P.58
EasyTuneIII™ Introduction	P.59
Page Index for BIOS Setup	P.60
Technical Support / RMA Sheet	P.87
Appendix	P.88

Revision History

Revision	Revision Note	Date
1.0	Initial release of the 7VTX-P motherboard user's manual.	Sep. 2001

The author assumes no responsibility for any errors or omissions that may appear in this document nor does the author make a commitment to update the information contained herein.

Third-party brands and names are the property of their respective owners.

Please do not remove any labels on motherboard, this may void the warranty of this motherboard.

Sep. 24, 2001 Taipei, Taiwan, R.O.C

Item Checklist

- The 7VTX-P motherboard
- Cable for IDE / floppy device
- Diskettes or CD for motherboard driver & utility
- 7VTX-P user's manual

Summary Of Features

Form Factor	<ul style="list-style-type: none"> 31.1 cm x 25.3 cm ATX size form factor, 4 layers PCB.
CPU	<ul style="list-style-type: none"> AMD Athlon™/Duron™ (K7) Socket A Processor 128K L1 & 256K/64K L2 cache on die Supports 500MHz ~ 1.2GHz+ and faster
Chipset	<p>VIA Chipset consisting of:</p> <ul style="list-style-type: none"> KT266A Memory/AGP/PCI Controller(PAC) VT8233 Integrated Peripheral Controller (PSIPC)
Clock Generator	<ul style="list-style-type: none"> W255/W312/SOP48 105/110/115/133 MHz system bus speeds Supports 100~170MHz 200/266 MHz FSB and DDR bus speeds (PCI 33MHz)
Memory	<ul style="list-style-type: none"> 3 184-pin DDR sockets. Support DDR DRAM PC200/266 Supports up to 3 GB DDR Supports only 2.5V DDR DIMM
I/O Control	<ul style="list-style-type: none"> IT8705
Slots	<ul style="list-style-type: none"> 1 AGP Pro slot supports 4X mode & AGP 2.0 compliant 5 PCI slot supports 33MHz & PCI 2.2 compliant 1 AMR(Audio Modem Riser) slot
On-Board IDE	<ul style="list-style-type: none"> 2 IDE bus master (ATA 100/ATA66)IDE ports for up to 4 ATAPI devices Supports PIO mode 3, 4 (UDMA 33/ATA 66) IDE & ATAPI CD-ROM
On-Board Peripherals	<ul style="list-style-type: none"> 1 floppy port supports 2 FDD with 360K, 720K,1.2M, 1.44M and 2.88M bytes 1 parallel ports supports SPP/EPP/ECP mode 2 serial ports (COM A & COM B) 6 USB ports 1 IrDA connector for Fast IrDA
On-Board Sound	<ul style="list-style-type: none"> Creative CT5880 sound Line In/Line Out/Mic In/AUX In/CD In/TEL/Game Port SPDIF and Four Speaker

To be continued...

Hardware Monitor	<ul style="list-style-type: none"> • CPU/System fan revolution detect • CPU/System temperature detect • System voltage detect (Vcore,VDD ,Vcc,+12V)
PS/2 Connector	<ul style="list-style-type: none"> • PS/2[®] Keyboard interface and PS/2[®] Mouse interface
BIOS	<ul style="list-style-type: none"> • Licensed AMI BIOS, 2M bit flash ROM • Support Dual BIOS
Additional Features	<ul style="list-style-type: none"> • Support Wake-On-LAN (WOL)/ Wake-On-Ring (WOR) • Support Internal / External Modem Ring On • Support PS/2, KB/Mouse Power On. • Includes 3 fan power connectors • Poly fuse for keyboard over-current protection • Support STR (Suspend-To-RAM) function • Support Mic in , Line in, Line out, Game port, Front Audio, AUX IN, Telephony

7VTX-P Motherboard Layout

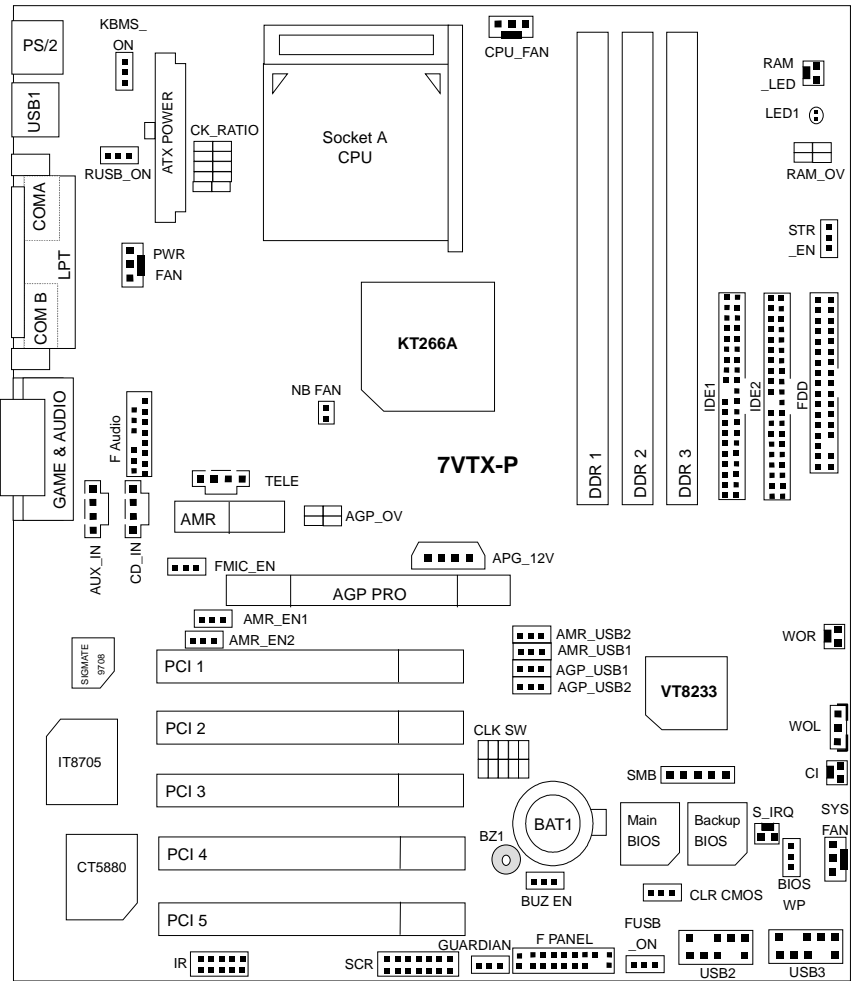

Installation Guide

Getting Started

**WARNING!**

Computer motherboards and expansion cards contain very delicate Integrated Circuit (IC) chips. To protect them against damage from static electricity, you should follow some precautions whenever you work on your computer.

1. Unplug your computer when working on the inside.
2. Use a grounded wrist strap before handling computer components. If you do not have one, touch both of your hands to a safely grounded object or to a metal object, such as the power supply case.
3. Hold components by the edges and try not touch the IC chips, leads or connectors, or other components.
4. Place components on a grounded antistatic pad or on the bag that came with the components whenever the components are separated from the system.
5. Ensure that the ATX power supply is switched off before you plug in or remove the ATX power connector on the motherboard.

Installing the motherboard to the chassis...

If the motherboard has mounting holes, but they don't line up with the holes on the base and there are no slots to attach the spacers, do not become alarmed you can still attach the spacers to the mounting holes. Just cut the bottom portion of the spacers (the spacer may be a little hard to cut off, so be careful of your hands). In this way you can still attach the motherboard to the base without worrying about short circuits. Sometimes you may need to use the plastic springs to isolate the screw from the motherboard PCB surface, because the circuit wire may be near by the hole. Be careful, don't let the screw contact any printed circuit write or parts on the PCB that are near the fixing hole, otherwise it may damage the board or cause board malfunctioning.

To set up your computer, you must complete the following steps:

- ▶ Step 1 - Set system jumpers
- ▶ Step 2- Install the Central Processing Unit (CPU)
- ▶ Step 3-Install memory modules
- ▶ Step 4-Install expansion cards
- ▶ Step 5-Connect ribbon cables, cabinet wires, and power supply
- ▶ Step 6-Set up BIOS software
- ▶ Step 7-Install supporting software tools

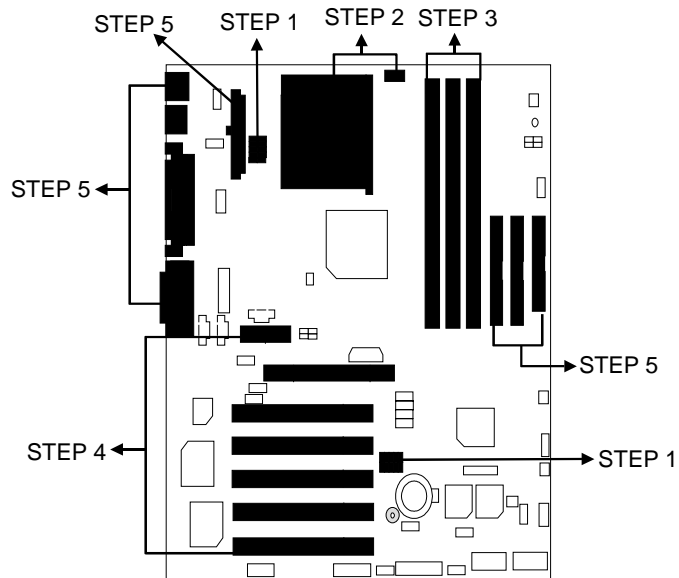

CPU Speed Setup

The CPU frequency can be switched by adjusting CLK_SW.
(The frequency ratio depend on CPU).

CLK_SW Select the CPU Speed 100MHz -170MHz by below table.

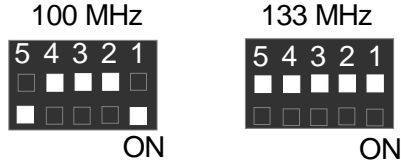
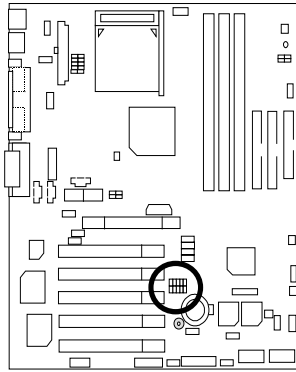

Clock Frequency Table							
CLK_SW			O:ON / X:OFF				
CPU	AGP	PCI	1	2	3	4	5
133.3	66.6	33.3	X	X	X	X	X
100	66.6	33.3	O	X	X	X	O
166.6	66.6	33.3	X	O	X	X	X
110	73.3	33.3	O	X	O	X	O
120	60	30	X	O	O	X	O
140	70	35	O	O	O	X	X
150	75	37.5	X	X	X	O	X
170	68	34	O	X	X	O	X

***We recommend you to setup your system speed by your CPU type.**

CK_RATIO: Frequency Override

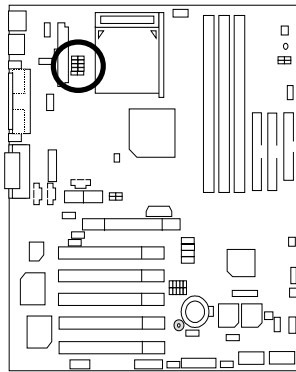

Ratio	1	2	3	4	5
Auto	X	X	X	X	O
5X	O	O	X	O	X
5.5X	X	O	X	O	X
6X	O	X	X	O	X
6.5X	X	X	X	O	X
7X	O	O	O	X	X
7.5X	X	O	O	X	X
8X	O	X	O	X	X
8.5X	X	X	O	X	X
9X	O	O	X	X	X
9.5X	X	O	X	X	X
10X	O	X	X	X	X
10.5X	X	X	X	X	X
11X	O	O	O	O	X
11.5X	X	O	O	O	X
12X	O	X	O	O	X
>=12.5X	X	X	O	O	X

O:ON, X:OFF

***We recommend you to setup your system speed by Auto.**

CPU Installation

Please make sure the CPU should be supported to the motherboard.

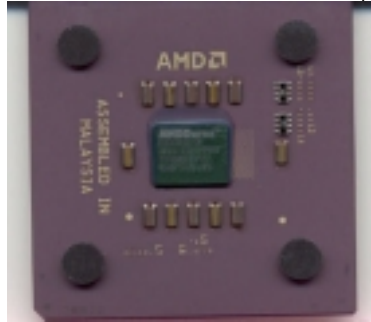

CPU Top View

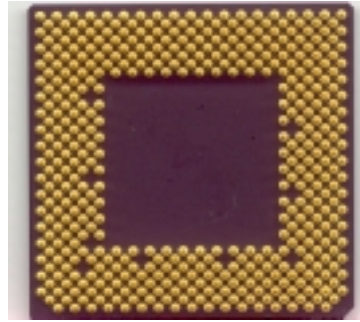

CPU Bottom View

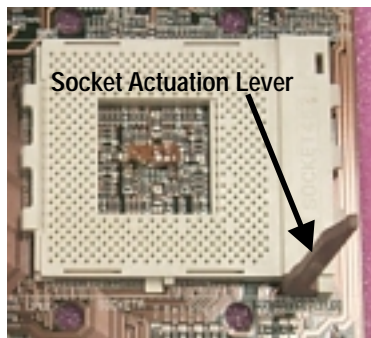

1. Pull the lever out and lift it up.

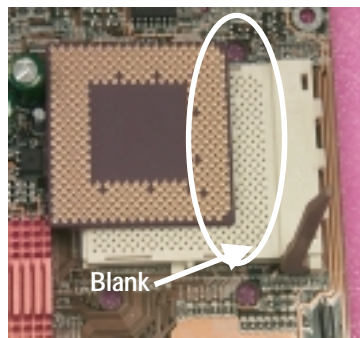

2. The notched corner should be orientated toward the blank space on the socket nearest the lever. The CPU will only fit in the orientation as shown.

CPU Heat Sink Installation:

Beware: Please check that the heat sink is in good contact with the CPU before you turn on your system. **The poor contact will cause over heat, and might cause damage to your processor!**

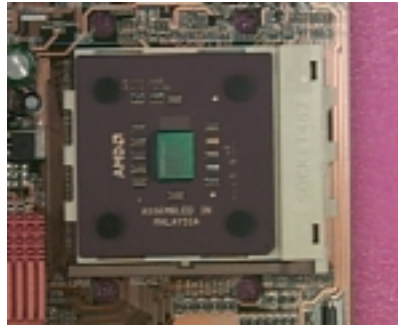

3. Align CPU and insert it
(Please refer to your heatsink installation manual for application of thermal grease to provide better heat conduction between your CPU and heatsink.)



4. Use compliant fan approved by AMD.

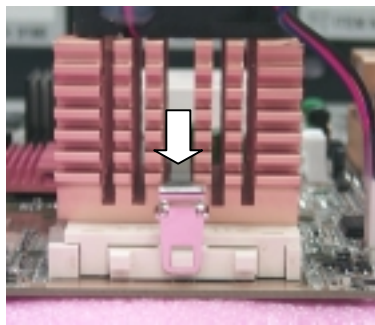
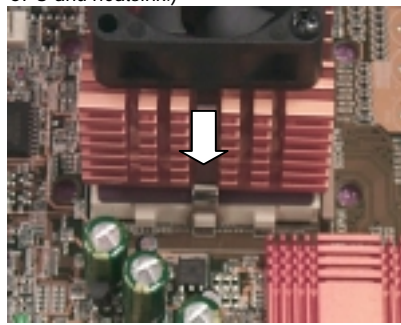

5. Hook one end of the cooler bracket to the CPU socket.

6. Hook the other end of the cooler bracket to the CPU socket.

 (Please refer to the cooler's installation manual for detailed installation steps)

Memory Installation

The motherboard has 3 dual DDR inline memory module (DIMM) sockets. The BIOS will automatically detects memory type and size. To install the memory module, just push it vertically into the DIMM Slot .The DIMM module can only fit in one direction due to the notch. Memory size can vary between sockets.

Total Memory Sizes With Registered DDR DIMMS

Devices used on DIMM	1 DIMM x64/x72	2 DIMMs x64/x72	3 DIMMs
64 Mbit (4Mx4x4 banks)	256 MBytes	512 MBytes	768 MBytes
64 Mbit (2Mx8x4 banks)	128 MBytes	256 MBytes	384 MBytes
64 Mbit (1Mx16x4 banks)	64 MBytes	128 MBytes	192 MBytes
128 Mbit (8Mx4x4 banks)	512 MBytes	1 GBytes	1.5 GBytes
128 Mbit (4Mx8x4 banks)	256 MBytes	512 MBytes	768 MBytes
128 Mbit (2Mx16x4 banks)	128 MBytes	256 MBytes	384 MBytes
256 Mbit (16Mx4x4 banks)	1 GBytes	2 GBytes	3 GBytes
256 Mbit (8Mx8x4 banks)	512 MBytes	1 GBytes	1.5 GBytes
256 Mbit (4Mx16x4 banks)	256 MBytes	512 MBytes	768 MBytes
512 Mbit (16Mx8x4 banks)	1 GBytes	2 GBytes	3 GBytes
512 Mbit (8Mx16x4 banks)	512 MBytes	1 GBytes	1.5 GBytes

Total Memory Sizes With Unbuffered DDR DIMMS

Devices used on DIMM	1 DIMM x64/x72	2 DIMMs x64/x72	3 DIMMs
64 Mbit (2Mx8x4 banks)	128 MBytes	256 MBytes	384 MBytes
64 Mbit (1Mx16x4 banks)	64 MBytes	128 MBytes	192 MBytes
128 Mbit (4Mx8x4 banks)	256 MBytes	512 MBytes	768 MBytes
128 Mbit (2Mx16x4 banks)	128 MBytes	256 MBytes	384 MBytes
256 Mbit (8Mx8x4 banks)	512 MBytes	1 GBytes	1.5 GBytes
256 Mbit (4Mx16x4 banks)	256 MBytes	512 MBytes	768 MBytes
512 Mbit (16Mx8x4 banks)	1 GBytes	2 GBytes	3 GBytes
512 Mbit (8Mx16x4 banks)	512 MBytes	1 GBytes	1.5 GBytes

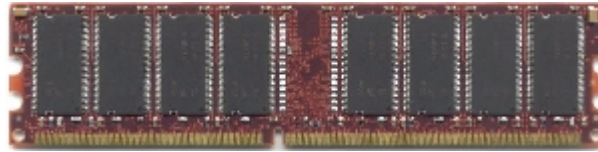

DDR

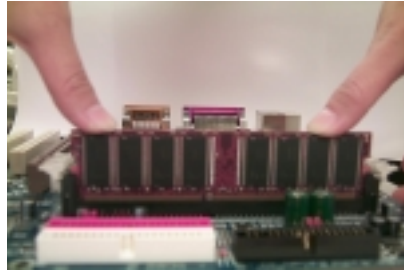

1. The DIMM slot has a notch, so the DIMM memory module can only fit in one direction.
 2. Insert the DIMM memory module vertically into the DIMM slot. Then push it down.
 3. Close the plastic clip at both edges of the DIMM slots to lock the DIMM module.
-  Reverse the installation steps when you wish to remove the DIMM module.

DDR Introduction

Established on the existing SDRAM industry infrastructure, DDR (Double Date Rate) memory is a high performance and cost-effective solution that allows easy adoption for memory vendors, OEMs and system integrators.

DDR memory is a sensible evolutionary solution for the PC industry that builds on the existing SDRAM infrastructure, yet makes awesome advances in solving the system performance bottleneck by doubling the memory bandwidth. DDR SDRAM will offer a superior solution and migration path from existing SDRAM designs due to its availability, pricing and overall market support. PC1600 DDR memory (DDR200) doubles the data rate through reading and writing at both the rising and falling edge of the clock, achieving data bandwidth 2X greater than PC100 when running with the same DRAM clock frequency. With peak bandwidth of 1.6GB per second, DDR memory enables system OEMs to build high performance and low latency DRAM subsystems that are suitable for servers, workstations, high-end PC's and value desktop SMA systems. With a core voltage of only 2.5 Volts compared to conventional SDRAM's 3.3 volts, DDR memory is a compelling solution for small form factor desktops and notebook applications.

Page Index for CPU Speed Setup / Connectors / Panel and Jumper Definition	Page
CPU Speed Setup	P.8
Connectors	P.16
ATX Power	P.16
COM A / COM B / LPT Port	P.16
PS/2 Keyboard & PS/2 Mouse Connector)	P.17
USB (USB Connector)	P.17
Front USB2/USB3(Front USB2/USB3 Connector)	P.18
Floppy Port	P.18
Game & Audio Port	P.19
IDE 1(Primary) / IDE 2(Secondary) Port	P.19
CD_IN(CD Audio Line In)	P.20
AUX_IN(AUXIN) [Optional]	P.20
TELE [Optional]	P.21
WOR(Ring Power On)	P.21
SMB(External SMBUS Device Connector)	P.22
SYS_FAN(System Fan Connector)	P.22
PWR_FAN(Power Fan Connector)	P.23
CPU_FAN(CPU Fan Connector)	P.23
WOL(Wake On LAN)	P.24
RAM LED & LED 1 (RAM LED Connector-Optional & LED1)	P.24
IR/CIR(IR/CIR Connector)	P.25
F_Audio(Front Audio Connector)[Optional]	P.25
SCR(Smart Card Reader Header)[Optional]	P.26
Panel and Jumper Definition	P.26
F_Panel (2x11 Pins Jumper)	P.27
CLR_CMOS(Clear CMOS Function)	P.28
BUZ_EN(Internal Buzzer Connector)[Optional]	P.28
BIOS_WP(BIOS Write Protect Function)[Optional]	P.29
KBMS_ON(Keyboard Power On Selection)	P.29
Guardian(FAN Detect)[Optional]	P.30
FUSB_ON(Front USB Wake Up)	P.30
RUSB_ON(Rear USB Wake Up)	P.31
FMIC_EN(Front MIC)[Optional]	P.31
AMR_EN1 & AMR_EN2(AMR Selection)[Optional]	P.32
NB_FAN(NB Heat Sink FAN)	P.32

7VTX-P Motherboard

AGP_OV(AGP Voltage Override)	P.33
AGP_12V(Power for AGP Pro)	P.33
CI(Case Open)	P.34
AMR_USB1/AMR_USB2(AMR_USB)[Optional]	P.34
AGP_USB1/AGP_USB2(AGP_USB)[Optional]	P.35
STR_EN(STR Selection)	P.35
RAM_OV(RAM Over voltage)	P.36
S_IRQ(Serial IRQ)	P.36
BAT1(Battery)	P.37

Connectors

ATX Power

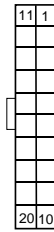
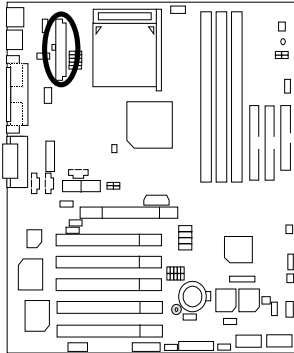

Pin No.	Definition
3,5,7,13, 15-17	GND
1,2,11	3.3V
4,6,19,20	VCC
10	+12V
12	-12V
18	-5V
8	Power Good
9	5V SB stand by+5V
14	PS-ON(Soft On/Off)



Please note:

AC power cord should only be connected to your power supply unit after ATX power cable and other related devices are firmly connected to the mainboard.

COM A / COM B / LPT Port

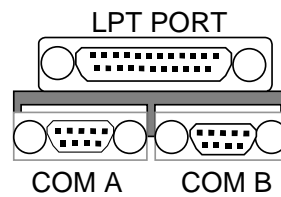
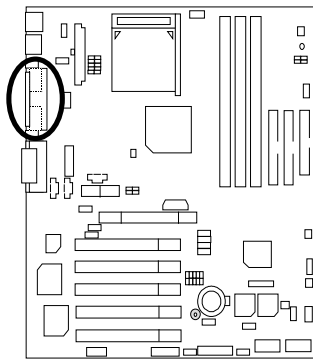

Please note:

This mainboard supports 2 standard COM ports and 1 LPT port. Device like printer can be connected to LPT port, mouse and modem etc can be connected to COM ports.

PS/2 Keyboard & PS/2 Mouse Connector

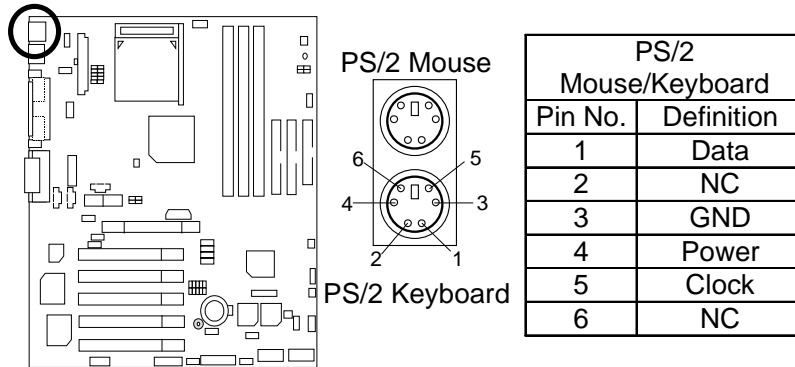

Please note:
This mainboard supports standard PS/2 keyboard and PS/2 mouse interface connector.

USB : USB Connector

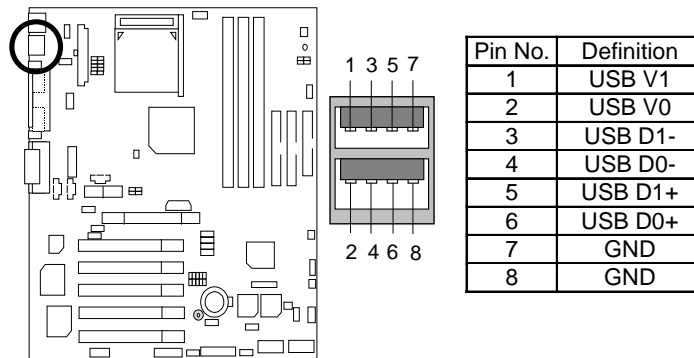

Please note:
Before you connect your device(s) into USB connector(s), please make sure your device(s) has a standard USB interface, like USB keyboard, mouse, scanner, zip, buzzer... Also make sure your OS supports USB controller (Win 95 w/ USB supperment, Win98, Windows 2000, Windows ME, Win NT w/ SP 6). If your OS does not support USB controller, please contact OS vendor for passible patch or driver upgrade. For more information please contact your OS or device(s) vendors.

Front USB 2 / USB 3: USB 2 / USB 3 Connector

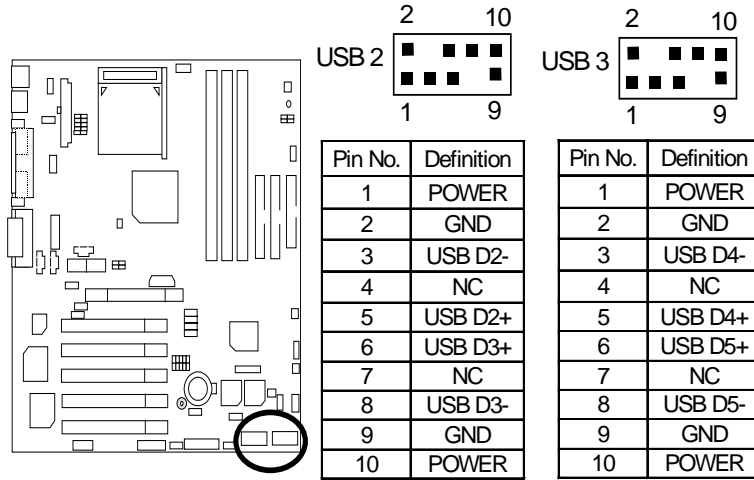
**Please note:**

Be careful with the polarity of the front panel USB connector. Check the pin assignment while you connect the front panel USB cable. Please contact your nearest dealer for optional front panel USB cable.

Floppy Port

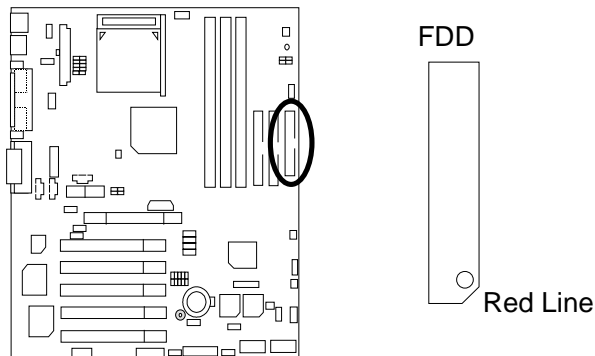
**Please note:**

Remove the smart card reader cable before you plug Floppy B, you cannot use Floppy B and smart card reader simultaneously.

Game & Audio Port

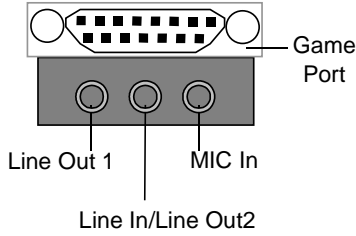
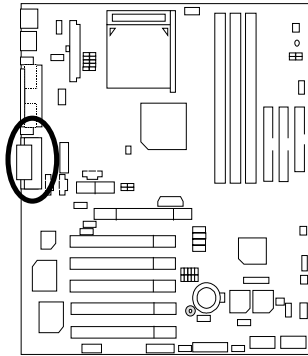

Please note: Line Out 1: Line Out or SPDIF (The SPDIF output is capable of providing digital audio to external speakers or compressed AC3 data to an external Dolby digital decoder). To enable SPDIF, simply insert SPDIF connector into Line Out1. Line Out1 will become SPDIF Out automatically. (see page 56 for more information).
To enable Four Speaker (for Creative 5880 audio only), simply follow instructions on page 53 and Line In will become Line Out2 to support second pair of stereo speakers.

IDE1(Primary), IDE2(Secondary) Port

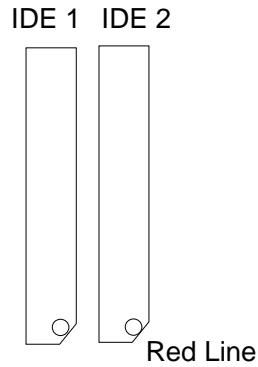
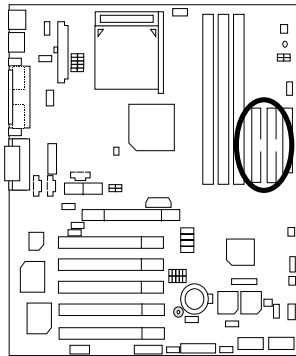

CD_IN: CD Audio Line In

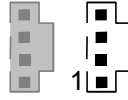
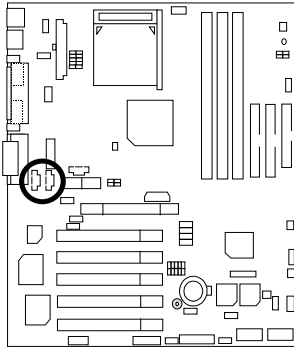

Pin No.	Definition
1	CD-L
2	GND
3	GND
4	CD-R

AUX_IN: AUXIN (Optional)

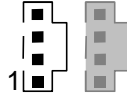
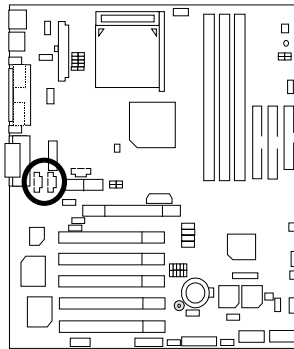

Pin No.	Definition
1	AUX-L
2	GND
3	GND
4	AUX-R

TELE: TEL (The connector is for internal modem card with voice connector) (Optional)

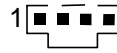
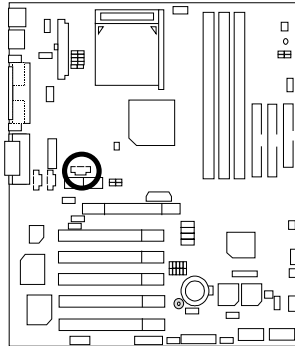

Pin No.	Definition
1	Signal-In
2	GND
3	GND
4	Signal-Out

WOR: Ring Power On (Internal Modem Card Wake Up)

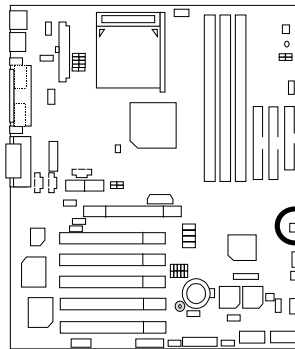

Pin No.	Definition
1	Signal
2	GND

SMB: External SMBUS Device Connector (Optional)

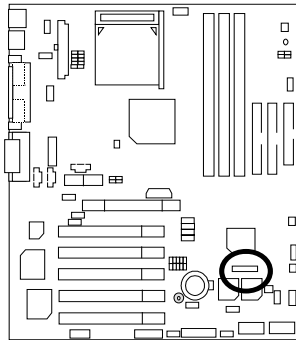

Pin No.	Definition
1	SMB CLK
2	NC
3	GND
4	SMB DATA
5	+5V

SYS_FAN: System Fan Connector

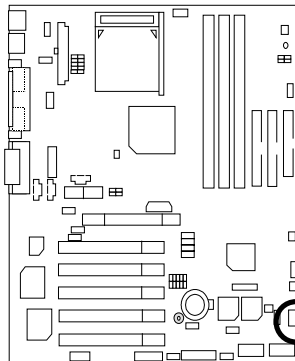

Pin No.	Definition
1	Control
2	+12V
3	SENSE

PWR_FAN: Power Fan Connector

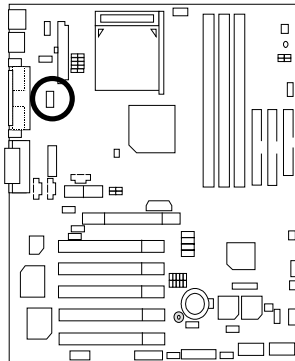

Pin No.	Definition
1	Control
2	+12V
3	SENSE

CPU_FAN: CPU Fan Connector

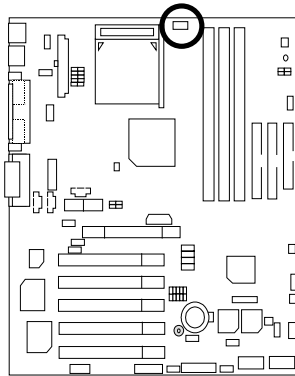

Pin No.	Definition
1	Control
2	+12V
3	SENSE



Please note:

A proper installation of the CPU cooler is essential to prevent the CPU from running under abnormal condition or damaged by overheating.

WOL: Wake On LAN

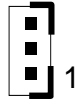
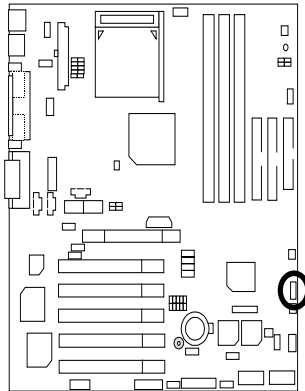

Pin No.	Definition
1	+5V SB
2	GND
3	Signal

RAM LED Conn. & LED1: RAM LED Connector & LED1
(RAM LED Connector is Optional)

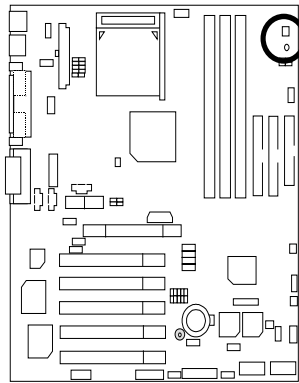

RAM LED Connector External.



Please note:

Do not remove memory modules while RAM LED is on. It might cause short or other unexpected damages due to the 2.5V stand by voltage. Remove memory modules only when STR function is disabled by jumper and AC Power cord is disconnected.

IR / CIR Connector

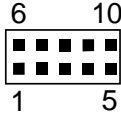
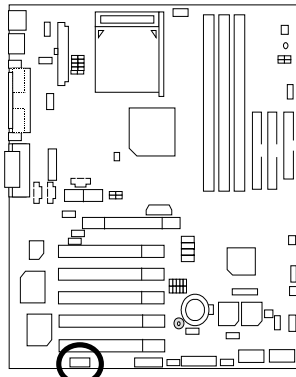

Pin No.	Definition
1	VCC
2	NC
3	IRRX
4	GND
5	IRTX
6	NC
7	CIRRX
8	5VSB
9	NC
10	CIRTX



Please note:

Please make sure that pin 1 on the IR device is align with pin 1 of the connector. To enable the IR/CIR function on the board, you are required to purchase an option IR/CIR module. For detail information please contact your authorized Giga-Byte distributor. To use IR function only, please connect IR module to Pin1 to Pin5.

F_Audio : Front Audio Connector (Optional)

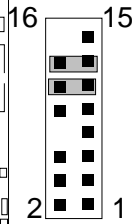
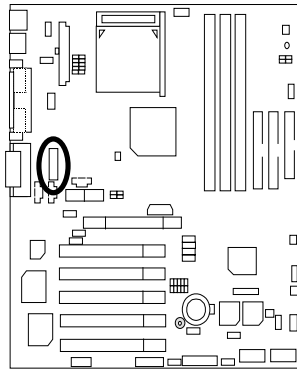

PIN No.	Definition
1	Incase speaker (R)
2	Incase speaker (L)
3, 4,5,6,10,15	GND
7	+12V
8,16	NC
9	MIC
11	Front Audio (R)
13	Front Audio (L)
12	Rear Audio (R)
14	Rear Audio (L)



Please note : If you want to use "Front Audio" connector, you must move 11-12,13-14 Jumper.

In order to utilize the front audio header, your chassis must have front audio connector. Also please make sure the pin assigment on the cable is the same as the pin assigment on the MB header. To find out if the chassis you are buying support front audio connector, please contact your dealer.

SCR: Smart Card Reader Header (Optional)

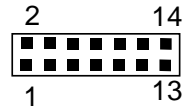
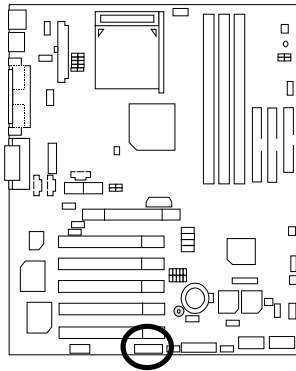

Pin No.	Definition
1	VCC
2,3,4,8,13	NC
5,6,10,12	DATA
7	Clock
9,14	NC
11	GND

**Please note:**

This MB supports smart card reader. To enable smart card reader function an optional smart card reader box is required. Please contact your authorized distributor.

Remove Floppy B before you plug smart card reader cable, you can not use smart card reader and Floppy B simultaneously.

Panel and Jumper Definition

F_Panel: 2x11 Pins Jumper

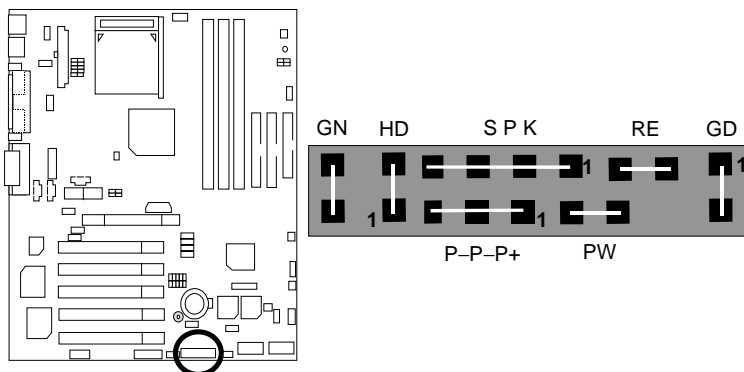

GN (Green Switch)	Open: Normal Operation Close: Entering Green Mode
GD (Green LED)	Pin 1: LED anode(+) Pin 2: LED cathode(-)
HD (IDE Hard Disk Active LED)	Pin 1: LED anode(+) Pin 2: LED cathode(-)
SPK (Speaker Connector)	Pin 1: VCC(+) Pin 2- Pin 3: NC Pin 4: Data(-)
RE (Reset Switch)	Open: Normal Operation Close: Reset Hardware System
P+P-P-(Power LED)	Pin 1: LED anode(+) Pin 2: LED cathode(-) Pin 3: LED cathode(-)
PW (Soft Power Connector)	Open: Normal Operation Close: Power On/Off



Please note:

Please connect the power LED, PC speaker, reset switch and power switch etc of your chassis front panel to the front panel jumper according to the pin assignment above.
When system is in STR or Suspend mode, Green LED will turn on.

CLR_CMOS : Clear CMOS Function

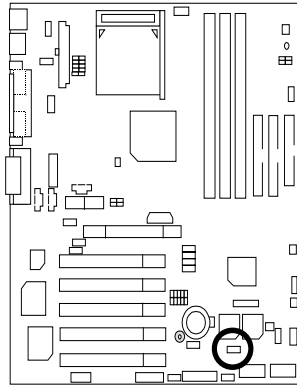

Pin No.	Definition
1-2 Close	Enable Clear CMOS Function
2-3 Close	Disable Clear CMOS Function (Default)



Please note:

You may clear the CMOS data to its default values by this jumper.

BUZ_EN: Internal Buzzer Connector (Optional)

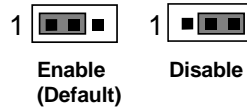
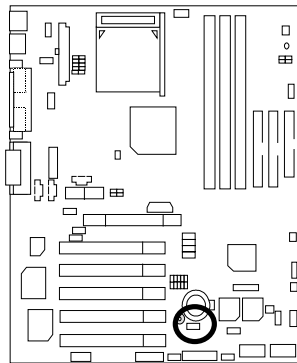

Pin No.	Definition
1-2 close	Internal Buzzer Enable (Default)
2-3 close	Internal Buzzer Disable

BIOS_WP: BIOS Write Protect Function (Optional)

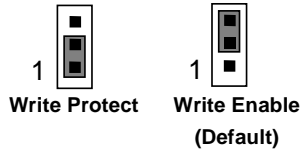
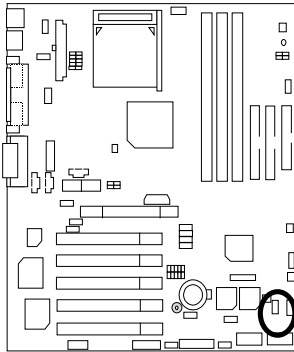

Pin No.	Definition
1-2 close	Write Protect
2-3 close	Write Enable (Default)



Please note:

To flash/upgrade BIOS on this MB BIOS_WP jumper must be set to 2-3 close, We recommend BIOS_WP jumper to be set to 1-2 close", whenever user is not try to flash/upgrade the BIOS.

KBMS_ON : Keyboard Power On Selection

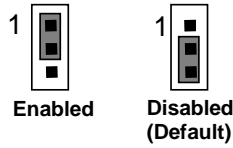
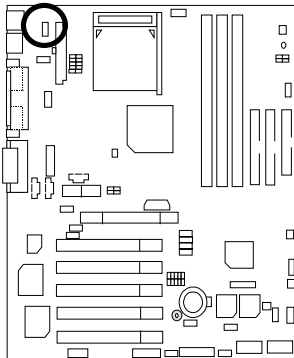

Pin No.	Definition
1-2 close	Enabled
2-3 close	Normal (Default)



Please Note: PS/2 keyboard power on, enable user to power on his computer by press the any key/keys on the PS/2 keyboard. To enable PS/2 keyboard power on, set jumper to 1-2 and go to the BIOS Setup "Resume On KBC" item, then select "S1/S3/S4/S5".

Guardian: FAN Detect (Optional)

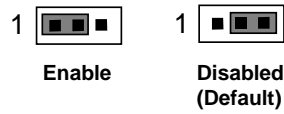
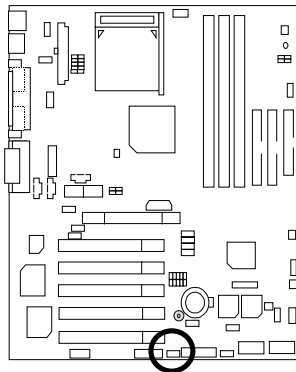

Pin No.	Definition
1-2 close	FAN Detect Enable
2-3 close	FAN Detect Disable(Default)

FUSB_ON: Front USB Wake Up

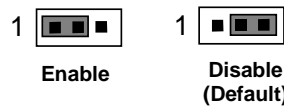
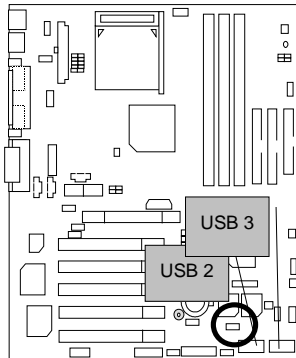

Pin No.	Definition
1-2 close	Front USB Wake Up Enable
2-3 close	Front USB Wake Up Disable (Default)



Please note:

(If you want to use "USB Dev Wakeup From S3-S5" function, you have to set the BIOS setting "USB Dev Wakeup from S3-S5" enabled, and the jumper "FUSB_ON & STR_EN" enabled.)

*(Power on the computer and as soon as memory counting starts, press . You will enter BIOS Setup. Select the item "POWER MANAGEMENT SETUP", then select "USB Dev Wakeup From S3-S5". Remember to save the setting by pressing "ESC" and choose the "SAVE & EXIT SETUP" option.)

RUSB_ON: Rear USB Wake Up

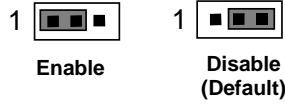
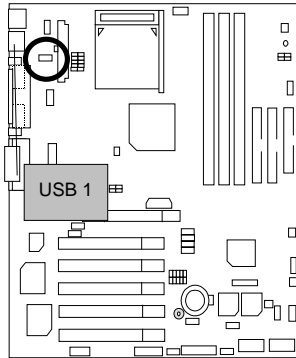

Pin No.	Definition
1-2 close	Rear USB Wake Up Enable
2-3 close	Rear USB Wake Up Disable (Default)



Please note:

(If you want to use "USB Dev Wakeup From S3-S5" function, you have to set the BIOS setting "USB Dev Wakeup From S3-S5" enabled, and the jumper "RUSB_ON & STR_EN" enabled)

*(Power on the computer and as soon as memory counting starts, press . You will enter BIOS Setup. Select the item "POWER MANAGEMENT SETUP", then select "USB Dev Wakeup From S3-S5". Remember to save the setting by pressing "ESC" and choose the "SAVE & EXIT SETUP" option.)

FMIC_EN: Front MIC (Optional)

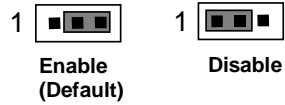
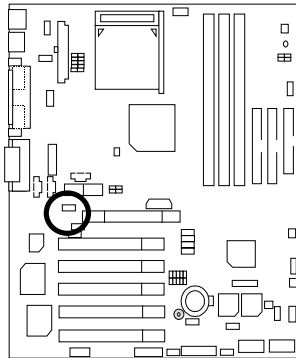

Pin No.	Definition
2-3 close	Enable (Default)
1-2 close	Disable

AMR_EN1 & AMR_EN2: AMR Selection (Optional)

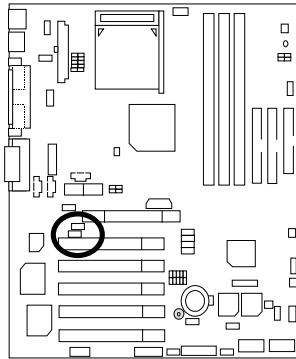

AMR_EN1	AMR_EN2	Primary CODEC
2-3 close	2-3 close	AMR Primary AC'97 Disabled (Disabled Onboard CODEC)
1-2 close	1-2 close	AMR Secondary (Default)



Please note:

7VTX: If M/B has hardware audio (CT5880), your modem riser has been set to "Primary" automatically. No Jumpers AMR_EN1 & AMR_EN2 for 7VTX.

7VTX: AMR_EN1 & AMR_EN2: 2-3 close: If you don't use onboard software audio, your audio/modem riser must be "Primary". Mainboard's software audio will be disabled. AMR_EN1 & AMR_EN2: 1-2 close: If you use software audio (onboard CODEC only), your modem riser must be "Secondary".

There are two kind of AMR/MR card in the market, Primary and secondary. If your AMR/MR card is primary, AMR_EN1 & AMR_EN2 should be set to 2-3, if you have secondary AMR/MR card AMR_EN1 & AMR_EN2 should be set to 1-2.

Warning! If Primary AMR/MR card is used, on-board audio will be disabled.

NB_FAN: NB Heat Sink FAN

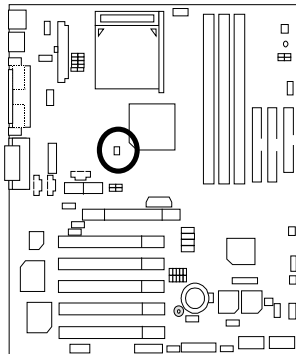

Pin No.	Definition
1	+12V
2	GND

AGP_OV: AGP Voltage Override

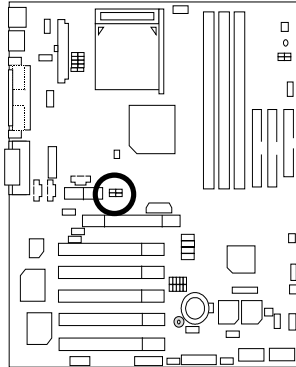

ON

	SW1	SW2
1.5V	OFF	OFF (Default)
1.6V	ON	OFF
1.7V	OFF	ON

AGP_12V: Power for AGP Pro

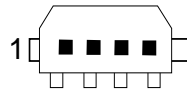
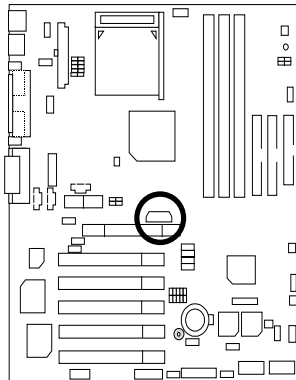

Pin No.	Definition
1	NC
2	GND
3	GND
4	+12V

CI: Case Open

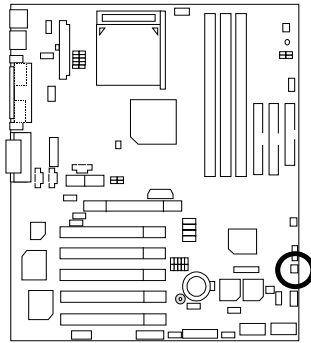

Pin No.	Definition
1	Signal
2	GND

AMR_USB1, AMR_USB2 : AMR_USB (Optional)

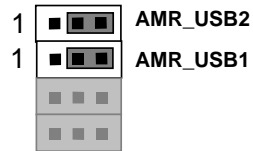
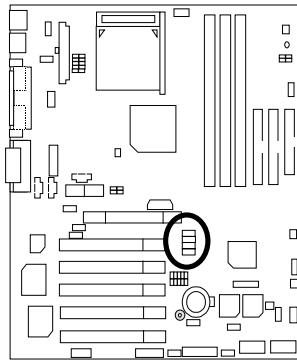

USB Select	AMR_USB1	AMR_USB2
AMR_USB	1-2 close	1-2 close
USB Port5	2-3 close	2-3 close (Default)

AGP_USB1, AGP_USB2: AGP_USB (Optional)

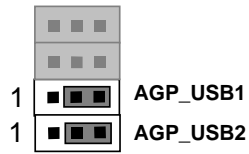
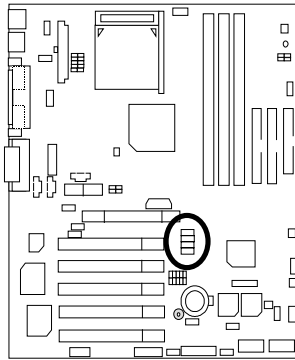

USB Select	AGP_USB1	AGP_USB2
AGP_USB	1-2 close	1-2 close
USB Port4	2-3 close	2-3 close (Default)

STR_EN: STR Selection

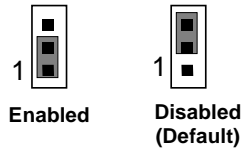
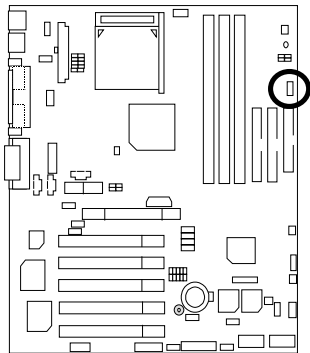

Pin No.	Definition
1-2 close	STR Enabled
2-3 close	STR Disabled (Default)

RAM_OV: RAM Overvoltage

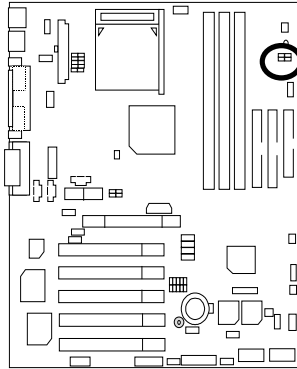

ON

O:ON, X:OFF

	SW1	SW2
2.5V	OFF	OFF (Default)
2.6V	ON	OFF
2.7V	OFF	ON

S_IRQ: Serial IRQ (Optional)

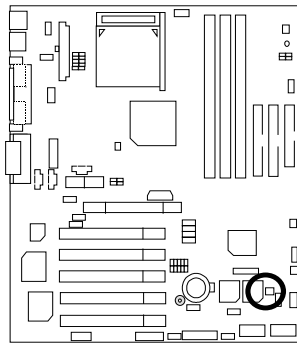

Pin No.	Definition
1	Signal
2	GND

BAT1 : Battery

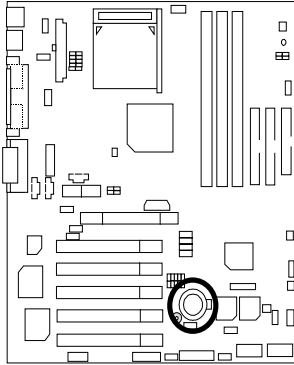

CAUTION

- ▶ Danger of explosion if battery is incorrectly replaced.
- ▶ Replace only with the same or equivalent type recommended by the manufacturer.
- ▶ Dispose of used batteries according to the manufacturer's instructions.

Block Diagram

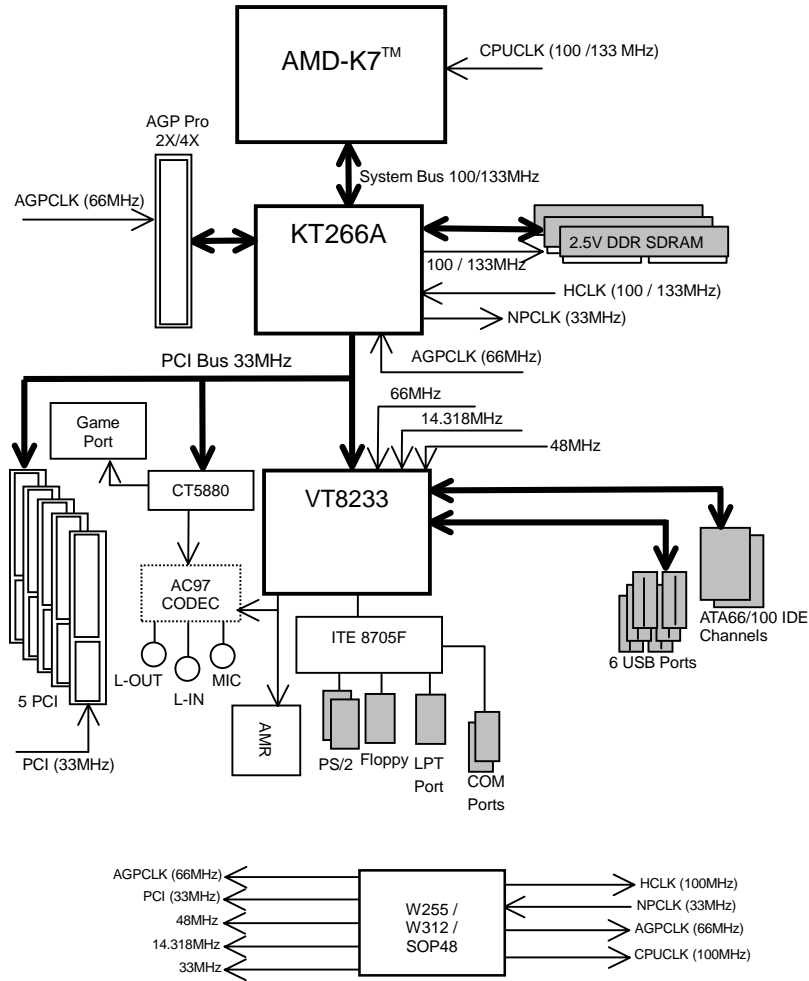

Suspend To RAM Installation

A.1 Introduce STR function:

Suspend-to-RAM (STR) is a Windows 98 ACPI sleep mode function. When recovering from STR (S3) sleep mode, the system is able, in just a few seconds, to retrieve the last "state" of the system before it went to sleep and recover to that state. The "state" is stored in memory (RAM) before the system goes to sleep. During STR sleep mode, your system uses only enough energy to maintain critical information and system functions, primarily the system state and the ability to recognize various "wake up" triggers or signals, respectively.

A.2 STR function Installation

Please use the following steps to complete the STR function installation.

Step-By-Step Setup

Step 1:

To utilize the STR function, the system must be in Windows 98 ACPI mode.

Putting Windows 98 into ACPI mode is fairly easy.

Setup with Windows 98 CD:

- A. Insert the Windows 98 CD into your CD-ROM drive, select Start, and then Run.
- B. Type (without quotes) "**D:\setup /p j**" in the window provided. Hit the enter key or click OK. 『 In Windows 98 second edition version, all the bios version dated 12/01/99 or later are ACPI compatible. Just type " D:\Setup", the operating system will be installed as ACPI mode. 』
- C. After setup completes, remove the CD, and reboot your system
(This manual assumes that your CD-ROM device drive letter is D:).

Step 2:

(If you want to use STR Function, please set jumper to 1-2 closed.)

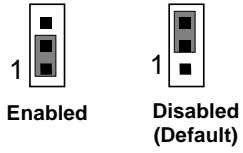
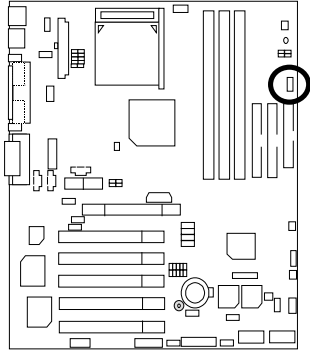

Pin No.	Definition
1-2 close	STR Enabled
2-3 close	STR Disabled (Default)

Step 3:

Power on the computer and as soon as memory counting starts, press . You will enter BIOS Setup. Select the item **"POWER MANAGEMENT SETUP"**, then select **"ACPI Sleep Type : S3 / STR"**. Remember to save the settings by pressing "ESC" and choose the **"SAVE & EXIT SETUP"** option.

Congratulation! You have completed the installation and now can use the STR function.

C. Select the "Advanced" tab and "Standby" mode in Power Buttons.

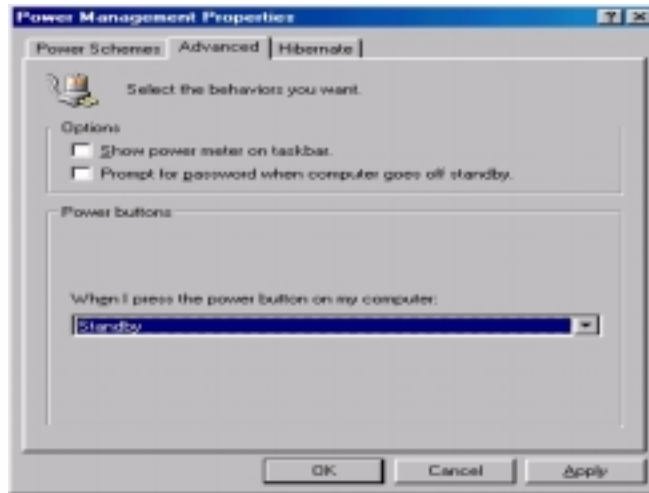

Step 4:

Restart your computer to complete setup.

Now when you want to enter STR sleep mode, just momentarily press the "Power on" button.

A.4 How to recover from the STR sleep mode?

There are five ways to "wake up" the system:

1. Press the "Power On" button.
2. Use the "Keyboard / Mouse Power On" function.
3. Use the "Resume by Alarm" function.
4. Use the "Modem Ring On" function.
5. Use the "Wake On LAN" function.
6. Use the "USB Device Wake Up from S3-S5" function.

A.5 Notices :

1. In order for STR to function properly, several hardware and software requirements must be satisfied:
 - A. Your ATX power supply must comply with the ATX 2.01 specification (provide more than 720 mA 5V Stand-By current).
 - B. Your DDR must be PC-200 compliant.
2. Jumper is provided to connect to the STR LED in your system chassis. [Some chassis may not provide this feature.] The STR LED will be illuminated when your system is in STR sleep mode.

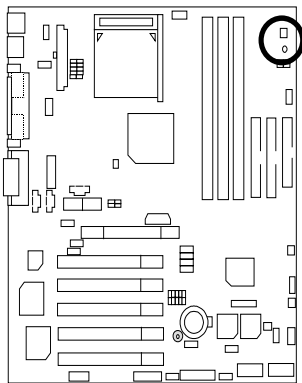

RAM LED Connector External.

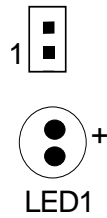

Please note:

Do not remove memory modules while RAM LED is on. It might cause short or other unexpected damages due to the 2.5V stand by voltage. Remove memory modules only when STR function is disabled by jumper and AC Power cord is disconnected.

Dual BIOS Introduction

A. What is Dual BIOS Technology?

Dual BIOS means that there are two system BIOS (ROM) on the motherboard, one is the Main BIOS and the other is Backup BIOS. Under the normal circumstances, the system works on the Main BIOS. If the Main BIOS is corrupted or damaged, the Backup BIOS can take over while the system is powered on. This means that your PC will still be able to run stably as if nothing has happened in your BIOS.

B. How to use Dual BIOS?

a. Boot Screen

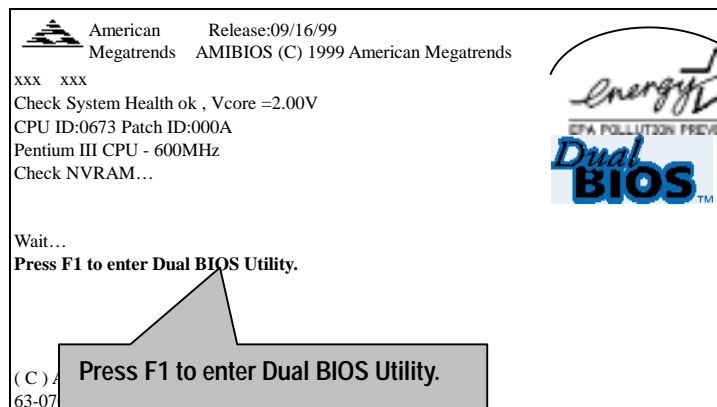

b. AMI Dual BIOS Flash ROM Programming Utility

AMI Dual BIOS Flash ROM Programming Utility	
Boot From.....	Main BIOS
Main ROM Type.....	SST 39SF020
Backup ROM Type.....	SST 39SF020
Wide Range Protection	Disable
Boot From	Main BIOS
Auto Recovery	Enable
Halt On Error	Disable
Copy Main ROM Data to Backup	
Load Default Settings	
Save Settings to CMOS	
PgDn/PgUp:Modify(Enter:Run) ↑↓:Move ESC:Reset F10:Power Off	

c. Dual BIOS Item explanation:

BIOS will auto detect:**Boot From:** Main BIOS**Main ROM Type:** SST 39SF020**Backup ROM Type:** SST 39SF020**Wide Range Protection: Disable(Default), Enable***Status 1:*

If any failure (ex. Update ESCD failure, checksum error or reset...) occurs in the Main BIOS, just before the Operating System is loaded and after the power is on, and that the Wide Range Protection is set to "Enable", the PC will boot from Backup BIOS automatically.

Status 2:

If the ROM BIOS on peripherals cards(ex. SCSI Cards, LAN Cards,..) emits signals to request restart of the system after the user make any alteration on it, the boot up BIOS will not be changed to the Backup BIOS.

Boot From: Main BIOS (Default), Backup BIOS

Status 1:

The user can set to boot from main BIOS or Backup BIOS.

Auto Recovery: Enabled (Default), Disabled

When one of the Main BIOS or Backup BIOS occurs checksum failure, the working BIOS will automatically recover the BIOS of checksum failure.

(In the Power Management Setup of the BIOS Setting, if ACPI Suspend Type is set to Suspend to RAM, the Auto Recovery will be set to Enable automatically.)

(If you want to enter the BIOS setting, please press "Del" key when the boot screen appears.)

Halt On Error : Disable(Default), Enable

If the BIOS occurs a checksum error or the Main BIOS occurs a WIDE RANGE PROTECTION error and Halt On BIOS Defects set to Enable, the PC will show messages on the boot screen, and the system will pause and wait for the user's instruction.

If Auto Recovery: **Disable**, it will show *<or the other key to continue.>*

If Auto Recovery: **Enable**, it will show *<or the other key to Auto Recover.>*

Copy Main ROM Data to Backup

Backup message:

Are you sure to copy BIOS?

[Enter] to continue or [Esc] to abort ...

The means that the Main BIOS works normally and could automatically recover the Backup BIOS. Or the means that the Backup BIOS works normally and could automatically recover the Main BIOS.

(This auto recovery utility is set by system automatically and can't be changed by user.)



DualBIOS™ Technology FAQ

GIGABYTE Technology is pleased to introduce DualBIOS technology, a hot spare for your system BIOS. This newest "Value-added" feature, in a long series of innovations from GIGABYTE, is available on GA-7VTX-P motherboard. Future GIGABYTE motherboards will also incorporate this innovation.

What's DualBIOS™?

On GIGABYTE motherboards with DualBIOS there are physically two BIOS chips. For simplicity we'll call one your "Main BIOS" and the other is your "Backup" BIOS (your "hot spare"). If your Main BIOS fails, the Backup BIOS almost automatically takes over on your next system boot. Almost automatically and with virtually zero down time! Whether the problem is a failure in flashing your BIOS or a virus or a catastrophic failure of the Main BIOS chip, the result is the same - the Backup BIOS backs you up, almost automatically.

I. Q: What is DualBIOS™ technology?

Answer:

DualBIOS technology is a patented technology from Giga-Byte Technology. The concept of this technology is based on the redundancy and fault tolerance theory. DualBIOS™ technology simply means there are two system BIOSes (ROM) integrated onto the motherboard. One is a main BIOS, and the other is a backup BIOS. The mainboard will operate normally with the main BIOS, however, if the main BIOS is corrupt or damaged for various reasons, the backup BIOS will be automatically used when the system powered-On. Your PC will operate as before the main BIOS was damaged, and is completely transparent to the user.

II. Q: Why does anyone need a motherboard with DualBIOS™ technology?

Answer:

In today's systems there are more and more BIOS failures. The most common reasons are virus attacks, BIOS upgrade failures, and/or deterioration of the BIOS (ROM) chip itself.

1. New computer viruses are being found that attack and destroy the system BIOS. They may corrupt your BIOS code, causing your PC to be unstable or even not boot normally.
2. BIOS data will be corrupted if a power loss/surge occurs, or if a user resets the system, or if the power button is pressed during the process of performing a system BIOS upgrade.
3. If a user mistakenly updates their mainboard with the incorrect BIOS file, then the system may not be able to boot correctly. This may cause the PC system hang in operation or during boot.
4. A flash ROM's life cycle is limited according to electronic characteristics. The modern PC utilizes the Plug and Play BIOS, and is updated regularly. If a user changes peripherals often, there is a slight chance of damage to the flash ROM.

With Giga-Byte Technology's patented DualBIOS™ technology you can reduce the possibility of hangs during system boot up, and/or loss BIOS data due to above reasons. This new technology will eliminate valuable system down time and costly repair bills cause by BIOS failures.

III. Q: How does DualBIOS™ technology work?

Answer:

1. DualBIOS™ technology provides a wide range of protection during the boot up procedure. It protects your BIOS during system POST, ESCD update, and even all the way to PNP detection/assignment.
2. DualBIOS™ provides automatic recovery for the BIOS. When the first BIOS used during boot up does not complete or if a BIOS checksum error occurs, boot-up is still possible. In the DualBIOS™ utility, the "Auto Recovery" option will guarantee that if either the main BIOS or backup BIOS is corrupted, the DualBIOS™ technology will use the good BIOS and correct the wrong BIOS automatically.
3. DualBIOS™ provides manual recovery for the BIOS. DualBIOS™ technology contains a built-in flash utility, which can flash your system BIOS from backup to main and/or visa versa. There is no need for an OS-dependent flash utility program.
4. DualBIOS™ contains a one-way flash utility. The built-in one-way flash utility will ensure that the corrupt BIOS is not mistaken as the good BIOS during recovery and that the correct BIOS (main vs. backup) will be flashed. This will prevent the good BIOS from being flashed.

IV. Q: Who Needs DualBIOS™ technology?

Answer:

1. Every user should have DualBIOS™ technology due to the advancement of computer viruses.
Everyday, there are new BIOS-type viruses discovered that will destroy your system BIOS. Most commercial products on the market do not have solutions to guard against this type of virus intrusion. The DualBIOS™ technology will provide a state-of-the-art solution to protect your PC:
Case I.) Vicious computer viruses may wipe out your entire system BIOS. With a conventional single system BIOS PC, the PC will not be functional until it is sent for repairs.
Case II.) If the "Auto Recovery" option is enabled in the DualBIOS™ utility, and if a virus corrupts your system BIOS, the backup BIOS will automatically reboot the system and correct the main BIOS.
Case III.) A user may override booting from the main system BIOS. The DualBIOS™ utility may be entered to manually change the boot sequence to boot from the backup BIOS.

2. During or after a BIOS upgrade, if DualBIOS™ detects that the main BIOS is corrupt, the backup BIOS will take over the boot-up process automatically. Moreover, it will verify the main and backup BIOS checksums when booting-up. DualBIOS™ technology examines the checksum of the main and backup BIOS while the system is powered on to guarantee your BIOS operates properly.
3. Power Users will have the advantage of having two BIOS versions on their mainboard. The benefit is being able to select either version BIOS to suit the performance system needs.
4. Flexibility for high-end desktop PCs and workstation/servers. In the DualBIOS™ utility, the option can be set, "Halt On When BIOS Defects," to be enabled to halt your system with a warning message that the main BIOS has been corrupted. Most workstation/servers require constant operation to guarantee services have not been interrupted. In this situation, the "Halt On When BIOS Defects" message may be disabled to avoid system pauses during normal booting.

Four Speaker & SPDIF Introduction

Four Speaker Introduction

A. What is Four Speaker?

The Creative CT5880 audio chip can support up to 4 speaker output. If you select "Four speaker out", Line In will be reconfigured as another line out to support a second pair of speakers.

B. How to use Four Speaker?

Microsoft Windows 98 Second Edition setup procedure:

- a. Click the audio icon along the task bar and select "Configure 3D Audio"

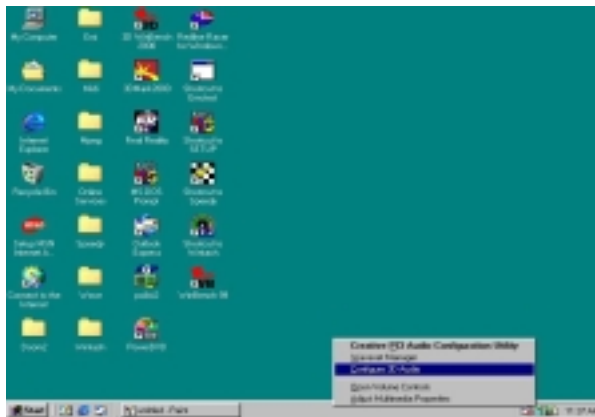

- b. Select two speaker (Default)



- c. Select "Four speaker" item.

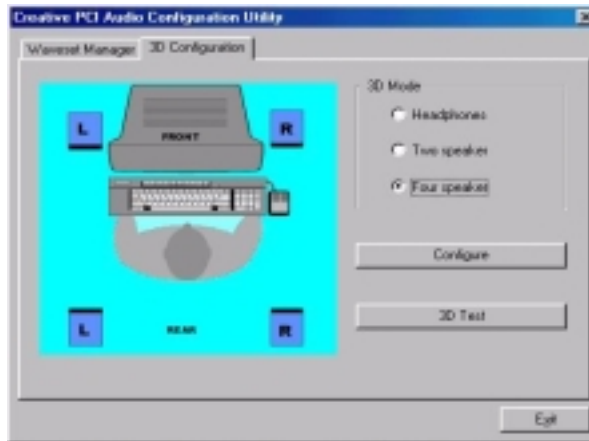

Microsoft Windows Me setup procedure:

- a. Go to "Control Panel"

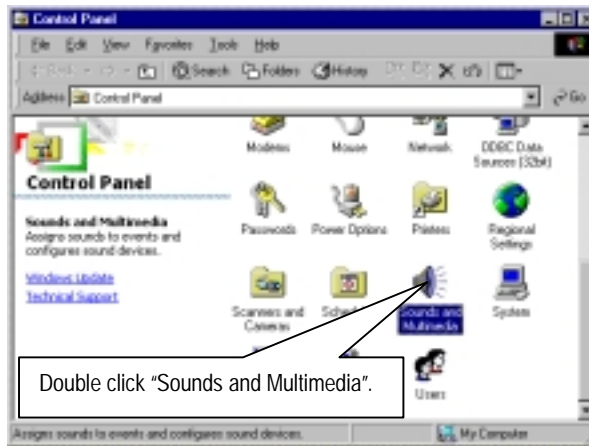

b. Select "Audio" Page, and click "Advanced" button.



c. Select "Quadraphonic Speakers" and click ok.



C. Four Speaker Application

The four speaker function will only be supported in application softwares that use Microsoft DirectX and Creative EAX, for example, the game titles, software DVD player and MP3 player.

SPDIF Introduction

A. What is SPDIF?

The SPDIF output is capable of providing digital audio to external speakers or compressed AC3 data to an external Dolby digital decoder.

B. How to use SPDIF?

- a. Click your mouse right button in "My Computer" and select the "Properties" item.

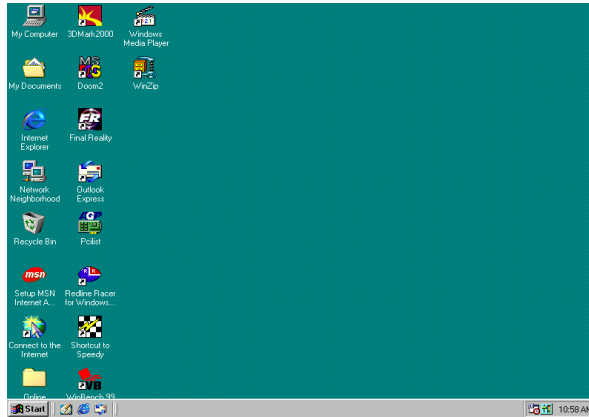

- b. Click "Device Manager" item.

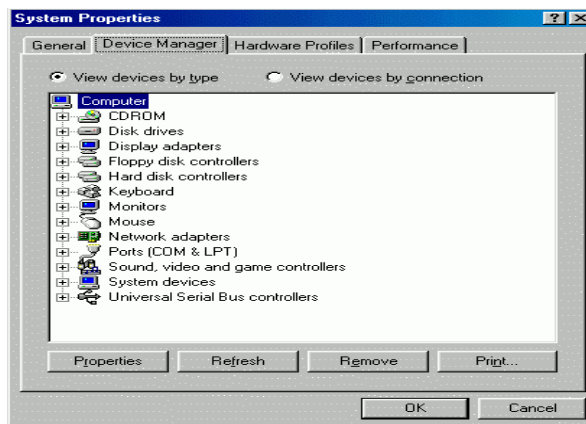

- c. Click "Sound, video and game controllers" item and select the "Creative Sound Blaster PCI128" item.

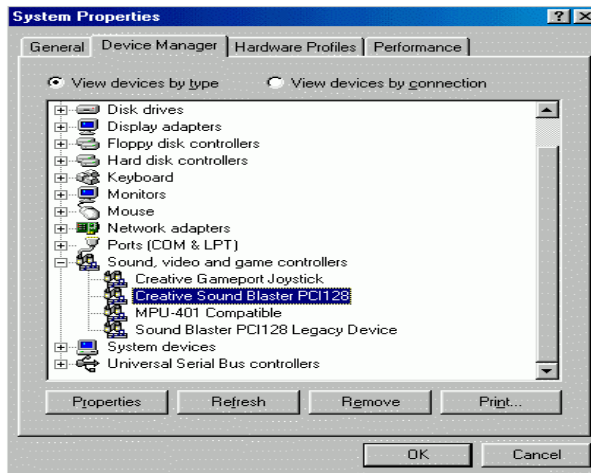

- d. Click "Settings" item and select the "Output Mode" item.

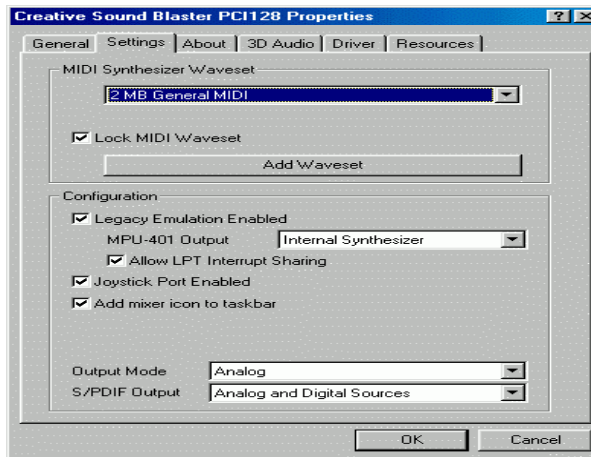

e. Click "Digital" item, Line Out will be reconfigure to SPDIF Out.

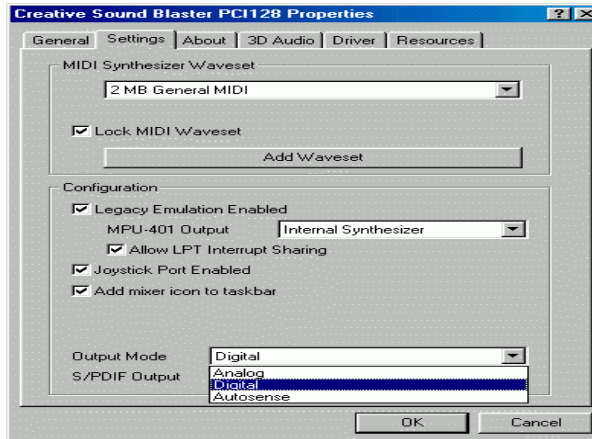

f. Recommend you to select "Autosense", It will automatically detect the type (mono or stereo) of the audio connector that you plug into Line Out audio jack, then configure Line Out to either SPDIF or Speaker accordingly.

@ BIOS Introduction

Gigabyte announces @ BIOS Windows BIOS live update utility



Have you ever updated BIOS by yourself? Or like many other people, you just know what BIOS is, but always hesitate to update it? Because you think updating newest BIOS is unnecessary and actually you don't know how to update it.

Maybe not like others, you are very experienced in BIOS updating and spend quite a lot of time to do it. But of course you don't like to do it too much. First, download different BIOS from website and then switch the operating system to DOS mode. Secondly, use different flash utility to update BIOS. The above process is not a interesting job. Besides, always be carefully to store the BIOS source code correctly in your disks as if you update the wrong BIOS, it will be a nightmare.

Certainly, you wonder why motherboard vendors could not just do something right to save your time and effort and save you from the lousy BIOS updating work? Here it comes! Now Gigabyte announces @BIOS--the first Windows BIOS live update utility. This is a smart BIOS update software. It could help you to download the BIOS from internet and update it. Not like the other BIOS update software, it's a Windows utility. With the help of '@BIOS', BIOS updating is no more than a click.

Besides, no matter which mainboard you are using, if it's a Gigabyte's product*, @BIOS help you to maintain the BIOS. This utility could detect your correct mainboard model and help you to choose the BIOS accordingly. It then downloads the BIOS from the nearest Gigabyte ftp site automatically. There are several different choices: you could use "Internet Update" to download and update your BIOS directly. Or you may want to keep a backup for your current BIOS, just choose "Save Current BIOS" to save it first. You make a wise choice to use Gigabyte, and @BIOS update your BIOS smartly. You are now worry free from updating wrong BIOS, and capable to maintain and manage your BIOS easily. Again, Gigabyte's innovative product erects a milestone in mainboard industries.

For such a wonderful software, how much it costs? Impossible! It's free! Now, if you buy a Gigabyte's motherboard, you could find this amazing software in the attached driver CD. But please remember, connected to internet at first, then you could have a internet BIOS update from your Gigabyte @BIOS.

EasyTuneIII™ Introduction

Gigabyte announces *EasyTuneIII* Windows overdrive utility



“Overdrive” might be one of the most common issues in computer field. But have many users ever tried it? The answer is probably “no”. Because “overdrive” is thought to be very difficult and includes a lot of technical know-how, sometimes “overdrive” is even considered as special skills found only in some enthusiasts.

But as to the experts in “overdrive”, what’s the truth? They may spend quite a lot of time and money to study, try and use many different hardware and software tools to do “overdrive”. And even with these technologies, they still learn that it’s quite a risk because the safety and stability of an “overdrive” system is unknown.

Now everything is different because of a Windows overdrive utility EasyTuneIII--announced by Gigabyte. This utility has totally changed the gaming rule of “overdrive”. This is the first overdrive utility suitable for both normal and power users. Users can choose either “Easy Mode” or “Advanced Mode” to run “overdrive” at their convenience. For users who choose “Easy Mode”, they just need to click “Auto Optimize” to have auto and immediate CPU overclocking. This software will then overdrive CPU speed automatically with the result being shown in the control panel. If someone prefers to “overdrive” by oneself, there is also another choice. Click “Advanced Mode” to enjoy “sport drive” class overclocking. In “Advanced Mode”, one can change the system bus speed in small increments to get ultimate system performance. And no matter which mainboard is used, if it’s a Gigabyte’s product*, EasyTuneIII helps to perform the best of system.

Besides, different from other traditional over-clocking methods, EasyTuneIII doesn’t require users to change neither BIOS nor hardware switch/ jumper setting; on the other hand, they can do “overdrive” at only one click. Therefore, this is a safer way for “overdrive” as nothing is changed on software or hardware. If user runs EasyTuneIII over system’s limitation, the biggest lost is only to restart the computer again and the side effect is then well controlled. Moreover, if one well-performed system speed been tested in EasyTuneIII, user can “Save” this bus speed and “Load” it in next time. Obviously, Gigabyte EasyTuneIII has already turned the “overdrive” technology toward to a newer generation.

This wonderful software is now free bundled in Gigabyte motherboard attached driver CD. Users may make a test drive of “EasyTuneIII” to find out more amazing features by themselves.

 Page Index for BIOS Setup	Page
The Main Menu	P.62
Standard CMOS Setup	P.64
BIOS Features Setup	P.67
Chipset Features Setup	P.69
Power Management Setup	P.72
PNP/ PCI Configuration	P.75
Load BIOS Defaults	P.77
Load Setup Defaults	P.78
Integrated Peripherals	P.79
Hardware Monitor & MISC Setup	P.82
Supervisor Password / User Password	P.83
IDE HDD Auto Detection	P.84
Save & Exit Setup	P.85
Exit Without Saving	P.86

BIOS Setup

BIOS Setup is an overview of the BIOS Setup Program. The program that allows users to modify the basic system configuration. This type of information is stored in battery-backed CMOS RAM so that it retains the Setup information when the power is turned off.

ENTERING SETUP

Power ON the computer and press immediately will allow you to enter Setup. If the message disappears before you respond and you still wish to enter Setup, restart the system to try again by turning it OFF then ON or pressing the "RESET" bottom on the system case. You may also restart by simultaneously press <Ctrl> – <Alt>– keys.

CONTROL KEYS

<↑>	Move to previous item
<↓>	Move to next item
<←>	Move to the item in the left hand
<→>	Move to the item in the right hand
<Esc>	Main Menu - Quit and not save changes into CMOS Status Page Setup Menu and Option Page Setup Menu - Exit current page and return to Main Menu
<+/PgUp>	Increase the numeric value or make changes
<-/PgDn>	Decrease the numeric value or make changes
<F1>	General help, only for Status Page Setup Menu and Option Page Setup Menu
<F2>	Reserved
<F3>	Reserved
<F4>	Reserved
<F5>	Restore the previous CMOS value from CMOS, only for Option Page Setup Menu
<F6>	Load the default CMOS value from BIOS default table, only for Option Page Setup Menu
<F7>	Load the Setup Defaults.
<F8>	Reserved
<F9>	Reserved
<F10>	Save all the CMOS changes, only for Main Menu

GETTING HELP

Main Menu

The on-line description of the highlighted setup function is displayed at the bottom of the screen.

Status Page Setup Menu / Option Page Setup Menu

Press F1 to pop up a small help window that describes the appropriate keys to use and the possible selections for the highlighted item. To exit the Help Window press <Esc>.

The Main Menu

Once you enter AMI BIOS CMOS Setup Utility, the Main Menu (Figure 1) will appear on the screen. The Main Menu allows you to select from nine setup functions and two exit choices. Use arrow keys to select among the items and press <Enter> to accept or enter the sub-menu.

AMIBIOS SIMPLE SETUP UTILITY-VERSION 1.24b (C) 1999 American Megatrends, Inc. All Rights Reserved	
STANDARD CMOS SETUP	INTEGRATED PERIPHERALS
BIOS FEATURES SETUP	HARDWARE MONITOR & MISC SETUP
CHIPSET FEATURES SETUP	SUPERVISOR PASSWORD
POWER MANAGEMENT SETUP	USER PASSWORD
PNP/PCI CONFIGURATION	IDE HDD AUTO DETECTION
LOAD BIOS DEFAULTS	SAVE & EXIT SETUP
LOAD SETUP DEFAULTS	EXIT WITHOUT SAVING
ESC : Quit ↑↓←→ : Select Item (Shift) F2 : Change Color F5 : Old Values F6 : Load BIOS Defaults F7 : Load Setup Defaults F10: Save & Exit	
Time, Date, Hard Disk Type, ...	

Figure 1: Main Menu

- **Standard CMOS Setup**
This setup page includes all the items in standard compatible BIOS.
- **BIOS Features Setup**
This setup page includes all the items of AMI special enhanced features.

- **Chipset Features Setup**

This setup page includes all the items of chipset special features.
- **Power Management Setup**

This setup page includes all the items of Green function features.
- **PnP/PCI Configurations**

This setup page includes all the configurations of PCI & PnP ISA resources.
- **Load BIOS Defaults**

Bios Defaults indicates the value of the system parameter which the system would be in the safe configuration.
- **Load Setup Defaults**

Setup Defaults indicates the value of the system parameter which the system would be in the most appropriate configuration.
- **Integrated Peripherals**

This setup page includes all onboard peripherals.
- **Hardware Monitor & MISC Setup**

Configure hardware monitor features, control frequency/voltage.
- **Supervisor password**

Change, set, or disable password. It allows you to limit access to the system and Setup, or just to Setup.
- **User password**

Change, set, or disable password. It allows you to limit access to the system.
- **IDE HDD auto detection**

Automatically configure hard disk parameters.
- **Save & Exit Setup**

Save CMOS value settings to CMOS and exit setup.
- **Exit Without Saving**

Abandon all CMOS value changes and exit setup.

Standard CMOS Setup

The items in Standard CMOS Features Menu (Figure 2) are divided into 9 categories. Each category includes no, one or more than one setup items. Use the arrows to highlight the item and then use the <PgUp> or <PgDn> keys to select the value you want in each item.

AMIBIOS SETUP – STANDARD CMOS SETUP (C) 1999 American Megatrends, Inc. All Rights Reserved	
Date (mm/dd/yyyy) : Tue Jan 25, 2000 Time (hh/mm/ss) : 10:36:24	
TYPE SIZE CYLS HEAD PRECOMP LANDZ SECTOR MODE	
Pri Master : Auto Pri Slave : Auto Sec Master : Auto Sec Slave : Auto	
Floppy Drive A: 1.44 MB 3 ½ Floppy Drive B: Not Installed	Base Memory : 640 Kb Other Memory: 384 Kb Extended Memory: 30Mb Total Memory: 31Mb
Boot Sector Virus Protection : Disabled	
Month: Jan – Dec Day: 01 – 31 Year: 1990– 2099	ESC : Exit ↑↓ : Select Item PU/PD/+/- : Modify (Shift)F2 : Color

Figure 2: Standard CMOS Setup

- **Date**

The date format is <Week>, <Month>, <Day>, <Year>.

Week	The week, from Sun to Sat, determined by the BIOS and is display-only
Month	The month, Jan. Through Dec.
Day	The day, from 1 to 31 (or the maximum allowed in the month)
Year	The year, from 1990 through 2099

- **Time**

The times format in <hour> <minute> <second>. The time is calculated base on the 24-hour military-time clock. For example, 1 p.m. is 13:00:00.

- **IDE Primary Master, Slave / Secondary Master, Slave**

The category identifies the types of hard disk from drive C to F that has been installed in the computer. There are two types: auto type, and user definable type. User type is user-definable; Auto type which will automatically detect HDD type.

Note that the specifications of your drive must match with the drive table. The hard disk will not work properly if you enter improper information for this category.

If you select User Type, related information will be asked to enter to the following items. Enter the information directly from the keyboard and press <Enter>. Such information should be provided in the documentation form your hard disk vendor or the system manufacturer.

CYLS.	Number of cylinders
HEADS	number of heads
PRECOMP	write precomp
LANDZONE	Landing zone
SECTORS	number of sectors

If a hard disk has not been installed select NONE and press <Enter>.

- **Drive A type / Drive B type**

The category identifies the types of floppy disk drive A or drive B that has been installed in the computer.

None	No floppy drive installed
360K, 5.25 in.	5.25 inch PC-type standard drive; 360K byte capacity.
1.2M, 5.25 in.	5.25 inch AT-type high-density drive; 1.2M byte capacity (3.5 inch when 3 Mode is Enabled).
720K, 3.5 in.	3.5 inch double-sided drive; 720K byte capacity
1.44M, 3.5 in.	3.5 inch double-sided drive; 1.44M byte capacity.
2.88M, 3.5 in.	3.5 inch double-sided drive; 2.88M byte capacity.

- **Boot Sector Virus Protection**

If it is set to enable, the category will flash on the screen when there is any attempt to write to the boot sector or partition table of the hard disk drive. The system will halt and the following error message will appear in the mean time. You can run anti-virus program to locate the problem.

Enabled	Activate automatically when the system boots up causing a warning message to appear when anything attempts to access the boot sector or hard disk partition table
Disabled	No warning message to appear when anything attempts to access the boot sector or hard disk partition table. (Default Value)

- **Memory**

The category is display-only which is determined by POST (Power On Self Test) of the BIOS.

Base Memory

The POST of the BIOS will determine the amount of base (or conventional) memory installed in the system.

The value of the base memory is typically 512 K for systems with 512 K memory installed on the motherboard, or 640 K for systems with 640 K or more memory installed on the motherboard.

Extended Memory

The BIOS determines how much extended memory is present during the POST.

This is the amount of memory located above 1 MB in the CPU's memory address map.

Other Memory

This refers to the memory located in the 640 K to 1024 K address space. This is memory that can be used for different applications.

DOS uses this area to load device drivers to keep as much base memory free for application programs. Most use for this area is Shadow RAM

BIOS Features Setup

AMIBIOS SETUP – BIOS FEATURES CMOS SETUP (C) 1999 American Megatrends, Inc. All Rights Reserved	
1st Boot Device	:Floppy
2nd Boot Device	:IDE-0
3rd Boot Device	:CDROM
S.M.A.R.T for Hard Disks	:Disabled
BootUp Num-Lock	:On
Floppy Drive Seek	:Disabled
Password Check	:Setup
ESC :Quit ↑↓←→: Select Item F1 : Help PU/PD/+/- : Modify F5 : Old Values (Shift)F2 :Color F6 : Load BIOS Defaults F7 : Load Setup Defaults	

Figure 3: BIOS Features Setup

- **1st / 2nd / 3rd Boot Device**

The default value is Floppy or LS-120 / ZIP A: or ATAPI ZIP C: or CDROM or SCSI or NETWORK / I20 or IDE-0-IDE-3 or Disabled.

Floppy	Boot Device by Floppy.
ZIP A: / LS120	Boot Device by LS-120 / ZIP A:.
CDROM	Boot Device by CDROM.
SCSI	Boot Device by SCSI.
NETWORK	Boot Device by NETWORK.
IDE-0-IDE-3	Boot Device by IDE-0-IDE-3.
Disabled	Boot Device by Disabled.
ATAPI ZIP C:	Boot Device by ATAPI ZIP C:.
USB FDD	Boot Device by USB Floppy.

- **S.M.A.R.T. for Hard Disks**

Enable	Enable S.M.A.R.T. Hard for Disks.
Disable	Disable S.M.A.R.T. Hard for Disks. (Default Value)

- **Boot Up Num-Lock**

On	Keypad is number keys. (Default Value)
Off	Keypad is arrow keys.

- **Floppy Drive Seek**

During POST, BIOS will determine if the floppy disk drive installed is 40 or 80 tracks. 360 type is 40 tracks while 720 , 1.2 and 1.44 are all 80 tracks.

Enabled	BIOS searches for floppy disk drive to determine if it is 40 or 80 tracks. Note that BIOS can not tell from 720, 1.2 or 1.44 drive type as they are all 80 tracks.
Disabled	BIOS will not search for the type of floppy disk drive by track number. Note that there will not be any warning message if the drive installed is 360. (Default Value)

- **Password Check**

 Please refer to the detail on P.84

Setup	Set Password Check to Setup. (Default Value)
Always	Set Password Check to Always.

Chipset Features Setup

AMIBIOS SETUP –CHIPSET FEATURE CMOS SETUP (C) 1999 American Megatrends, Inc. All Rights Reserved	
Top Performance	:Disabled
Configure SDRAM by SPD	:Enabled
DRAM Frequency	:100
SDRAM CAS# Latency	:2
SDRAM Command Rate	:2T Command
AGP Mode	:4X
AGP Comp. Driving	:Auto
Manual AGP Comp. Driving	:DA
AGP Fast Write	:Disable
AGP Aperture Size	:128MB
AGP Read Synchronization	:Disabled
PCI Delay Transaction	:Enabled
USB Controller	:All USB Port
USB Legacy Support	:Disabled
USB Port 64/60 Emulation	:Disabled
ESC : Quit ↑↓←→: Select Item F1 : Help PU/PD/+/- : Modify F5 : Old Values (Shift)F2 :Color F6 : Load BIOS Defaults F7 : Load Setup Defaults	

Figure 4: Chipset Features Setup

- **Top Performance**

Disabled	Top Performance Disabled. (Default Value)
Enabled	Top Performance Enabled.

- **Configure SDRAM by SPD**

Disabled	Disabled Configure SDRAM Timing by SPD.
Enabled	Enabled Configure SDRAM Timing by SPD. (Default Value)

- **DRAM Frequency**

100MHz	Set DRAM Frequency is 100MHz. (Default Value).
133MHz	Set DRAM Frequency is 133MHz.
Auto	Set DRAM Frequency is Auto.

- **SDRAM CAS# Latency**

2	For Fastest SDRAM DIMM module. (Default Value).
2.5	For Slower SDRAM DIMM module.

- **SDRAM Command Rate**

2T Command	Set SDRAM Command Rate to 2T Command. (Default Value)
1T Command	Set SDRAM Command Rate to 1T Command.

- **AGP Mode**

4X	Set AGP Mode is 4X. (Default Value)
1X	Set AGP Mode is 1X.
2X	Set AGP Mode is 2X.

- **AGP Comp. Driving**

Auto	Set AGP Comp. Driving is Auto. (Default Value)
Manual	Set AGP Comp. Driving is Manual.

If AGP Comp. Driving is Manual.

Manual AGP Comp. Driving :	00-FF
----------------------------	-------

- **AGP Fast Write**

Disabled	Disabled AGP Fast Write (Default Value)
Enabled	Enabled AGP Fast Write

- **AGP Aperture Size**

4MB	Set AGP Aperture Size to 4MB.
8MB	Set AGP Aperture Size to 8 MB.
16MB	Set AGP Aperture Size to 16 MB.
32MB	Set AGP Aperture Size to 32 MB.
64MB	Set AGP Aperture Size to 64 MB.
128MB	Set AGP Aperture Size to 128 MB. (Default Value)
256MB	Set AGP Aperture Size to 256 MB.

- **AGP Read Synchronization**

Enabled	Enable AGP Read Synchronization.
Disabled	Disable AGP Read Synchronization. (Default Value)

- **PCI Delay Transaction**

Enabled	Enabled PCI Delay Transaction. (Default Value)
Disabled	Disabled PCI Delay Transaction.

- **USB Controller**

Disabled	Disable USB Controller function.
USB Port 1&2	Enabled USB Port 1&2.
USB Port 2&3	Enabled USB Port 2&3.
USB Port 1&3	Enabled USB Port 1&3.
USB1	Enabled USB Port 1.
USB2	Enabled USB Port 2.
USB3	Enabled USB Port 3.
All USB Port	Enabled All USB Port . (Default Value)

- **USB Legacy Support**

Keyboard/FDD	Set USB Legacy Support Keyboard / Floppy.
KB/Mouse/FDD	Set USB Legacy Support Keyboard / Mouse / Floppy.
Disabled	Disabled USB Legacy Support Function. (Default Value)

- **USB Port 64/60 Emulation**

Enabled	To use USB mouse under Win NT environment, set USB Legacy Support to KB/Mouse/FDD and USB Port 64/60 Emulation to enabled.
Disabled	Disable this Function. (Default Value)

Power Management Setup

AMBIOS SETUP –POWER MANAGEMENT SETUP (C) 1999 American Megatrends, Inc. All Rights Reserved			
ACPI Sleep Type	:S1/POS	RTC Alarm Date	:15
USB Dev Wakeup From S3-S5	:Disabled	RTC Alarm Hour	:12
Suspend Time Out(Minute)	:Disabled	RTC Alarm Minute	:30
IRQ3	:Monitor	RTC Alarm Second	:30
IRQ 4	:Monitor		
IRQ 5	:Ignore		
IRQ 7	:Monitor		
IRQ 9	:Ignore		
IRQ 10	:Ignore		
IRQ 11	:Ignore		
IRQ 13	:Ignore		
IRQ 14	:Monitor		
IRQ 15	:Ignore		
Soft-off by Power Button	:Instant off		
System after AC Back	:Off		
Resume On Ring / LAN	:Enabled	ESC : Quit	↑↓←→: Select Item
Resume On PME#	:Enabled	F1 : Help	PU/PD/+/- : Modify
Resume On KBC	:S1(Suspend)	F5 : Old Values	(Shift)F2 :Color
Resume On PS/2 Mouse	:S1(Suspend)	F6 : Load BIOS Defaults	
Resume On RTC Alarm	:Disabled	F7 : Load Setup Default	

Figure 5: Power Management Setup

- **ACPI Sleep Type**

S1/POS	Set ACPI sleep type is S1. (Default Value)
S3/STR	Set ACPI sleep type is S3.

- **USB Dev Wakeup From S3-S5**

USB Dev Wakeup From S3 can be set when ACPI Sleep Type set to S3/STR.

Enabled	Enable USB Dev Wakeup From S3.
Disabled	Disable USB Dev Wakeup From S3 (Default Value) .

- **Suspend Time Out (Minute.)**

Disabled	Disabled Suspend Time Out Function. (Default Value)
1	Enabled Suspend Time Out after 1min.
2	Enabled Suspend Time Out after 2min.
4	Enabled Suspend Time Out after 4min.
8	Enabled Suspend Time Out after 8min.
10	Enabled Suspend Time Out after 10min.
20	Enabled Suspend Time Out after 20min.
30	Enabled Suspend Time Out after 30min.
40	Enabled Suspend Time Out after 40min.
50	Enabled Suspend Time Out after 50min.
60	Enabled Suspend Time Out after 60min.

- **IRQ 3-IRQ15**

Ignore	Ignore IRQ3 -IRQ15.
Monitor	Monitor IRQ3-IRQ15.

- **Soft-off by Power Button**

Instant-off	Soft switch ON/OFF for POWER ON/OFF. (Default Value)
Delay 4 sec	Soft switch on 4sec for power OFF.

- **System after AC Back**

Off	When AC-power back to the system, the system will be in "Off" state. (Default Value)
On	When AC-power back to the system, the system will be in "On" state.
Last State	When AC-power back to the system, the system will return to the Last state before AC-power off.

- **Resume On Ring / LAN**

Disabled	Disabled Resume On Ring / LAN.
Enabled	Enabled Resume On Ring / LAN. (Default Value)

- **Resume On PME#**

Disabled	Disable PME Event Wake Up.
Enabled	Enabled PME Event Wake Up. (Default Value)

- **Resume On KBC**

S1(Suspend)	Keyboard is able to Wakeup the system from S1(Suspend) state. (Default value)
S1/S3	Keyboard is able to Wakeup the system from S1/S3 state.
S1/S3/S4/S5	Keyboard is able to Wakeup the system from S1/S3/S4/S5 state.
Disabled	Disabled Resume On KBC.

- **Resume On PS/2 Mouse**

S1(Suspend)	PS/2 Mouse is able to Wakeup the system from S1(Suspend) state. (Default value)
S1/S3	PS/2 Mouse is able to Wakeup the system from S1/S3 state.
S1/S3/S4/S5	PS/2 Mouse is able to Wakeup the system from S1/S3/S4/S5 state.
Disabled	Disabled Resume On PS/2 Mouse.

- **Resume On RTC Alarm**

You can set "RTC Alarm Power On" item to enabled and key in Data/time to power on system.

Disabled	Disable this function. (Default Value)
Enabled	Enable alarm function to POWER ON system.

If RTC Alarm Lead To Power On is Enabled.

RTC Alarm Date :	Every Day,1-31
RTC Alarm Hour:	0-23
RTC Alarm Minute :	0-59
RTC Alarm Second :	0-59

PnP/PCI Configurations

AMIBIOS SETUP –PNP/PCI CONFIGURATION SETUP (C) 1999 American Megatrends, Inc. All Rights Reserved	
VGA Boot From	:PCI
PCI Slot 1/5 IRQ Priority	:Auto
PCI Slot 2 IRQ Priority	:Auto
PCI Slot 3 IRQ Priority	:Auto
PCI Slot 4 IRQ Priority	:Auto
IRQ 3	:PCI/PnP
IRQ 4	:PCI/PnP
IRQ 5	:PCI/PnP
IRQ 7	:PCI/PnP
IRQ 9	:PCI/PnP
IRQ 10	:PCI/PnP
IRQ 11	:PCI/PnP
IRQ 14	:PCI/PnP
IRQ 15	:PCI/PnP
ESC : Quit ↑↓←→ : Select Item F1 : Help PU/PD/+/- : Modify F5 : Old Values (Shift)F2 :Color F6 : Load BIOS Defaults F7 : Load Setup Defaults	

Figure 6: PnP/PCI Configuration

- **VGA Boot From**

AGP	Primary Graphics Adapter From AGP.
PCI	Primary Graphics Adapter From PCI. (Default Value)

- **PCI Slot 1,5 IRQ Priority**

Auto	The system will reserved a free IRQ for PCI slot 1 & 5 device. (Default Value)
3	The system will reserved IRQ3 for PCI slot 1 & 5 device if no legacy ISA device using IRQ3.
4	The system will reserved IRQ4 for PCI slot 1 & 5 device if no legacy ISA device using IRQ4.
5	The system will reserved IRQ5 for PCI slot 1 & 5 device if no legacy ISA device using IRQ5.

7	The system will reserved IRQ7 for PCI slot 1 & 5 device if no legacy ISA device using IRQ7.
9	The system will reserved IRQ9 for PCI slot 1 & 5 device if no legacy ISA device using IRQ9.
10	The system will reserved IRQ10 for PCI slot 1 & 5 device if no legacy ISA device using IRQ10.
11	The system will reserved IRQ11 for PCI slot 1 & 5 device if no legacy ISA device using IRQ11.

- **IRQ -(3,4,5,7,9, 10,11,14,15), assigned to ("ISA / EISA" or "PCI/PnP")**

ISA/EISA	The resource is used by Legacy ISA device.
PCI/PnP	The resource is used by PCI/ PnP device.

Load BIOS Defaults

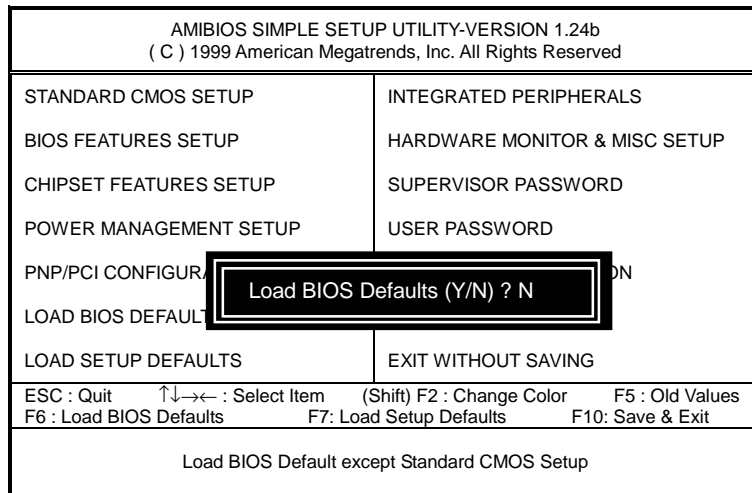

Figure 7: Load BIOS Defaults

- **Load BIOS Defaults**

BIOS defaults contain the most appropriate values of the system parameters that allow minimum system performance.

Load Setup Defaults

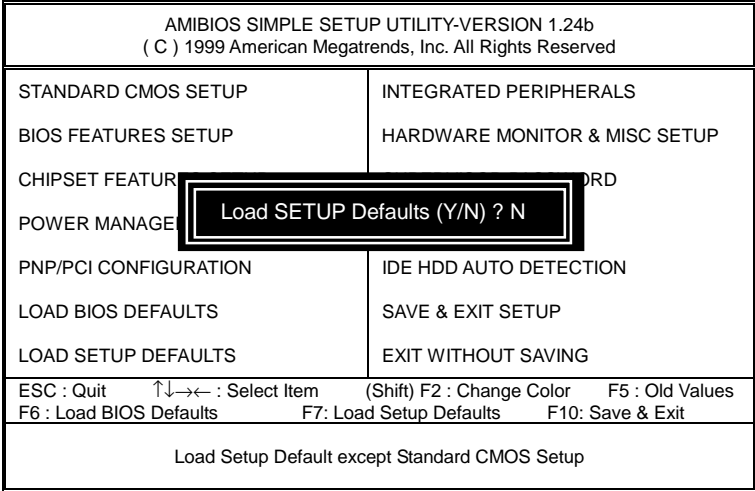

Figure 8: Load Setup Defaults

- **Load Setup Defaults**

Selecting this field loads the factory defaults for BIOS and Chipset Features which the system automatically detects.

Integrated Peripherals

AMIBIOS SETUP –INTEGRATED PERIPHERAL (C) 1999 American Megatrends, Inc. All Rights Reserved	
OnBoard FDC	:Auto
OnBoard Serial Port 1	:Auto
OnBoard Serial Port 2	:Auto
Serial Port2 Mode	:Normal
OnBoard CIR Port	:Disabled
CIR Port IRQ	:N/A
OnBoard Parallel Port	:Auto
Parallel Port Mode	:ECP
Parallel Port IRQ	:Auto
Parallel Port DMA	:Auto
OnBoard IDE	:Both
OnBoard MC'97 Modem	:Auto
OnBoard Creative Sound	:Enabled
ESC : Quit ↑↓←→: Select Item F1 : Help PU/PD/+/- : Modify F5 : Old Values (Shift)F2 :Color F6 : Load BIOS Defaults F7 : Load Setup Defaults	

Figure 9: Integrated Peripherals

- **On Board FDC**

Auto	Set On Board FDC is Auto (Default Value) .
Disabled	Disabled On Board FDC
Enabled	Enabled On Board FDC

- **Onboard Serial Port 1**

Auto	BIOS will automatically setup the port 1 address (Default Value) .
3F8/COM1	Enable onboard Serial port 1 and address is 3F8.
2F8/COM2	Enable onboard Serial port 1 and address is 2F8.
3E8/COM3	Enable onboard Serial port 1 and address is 3E8.
2E8/COM4	Enable onboard Serial port 1 and address is 2E8.
Disabled	Disable onboard Serial port 1.

- **Onboard Serial Port 2**

Auto	BIOS will automatically setup the port 2 address (Default Value) .
3F8/COM1	Enable onboard Serial port 2 and address is 3F8.
2F8/COM2	Enable onboard Serial port 2 and address is 2F8.
3E8/COM3	Enable onboard Serial port 2 and address is 3E8.
2E8/COM4	Enable onboard Serial port 2 and address is 2E8.
Disabled	Disable onboard Serial port 2.

- **Serial Port 2 Mode**

Normal	Normal operation. (Default Value)
IrDA	Onboard I/O chip supports IrDA
ASK IR	Onboard I/O chip supports ASK IR.
SCR	Onboard I/O chip supports SCR.

 **SCR option is shown only when there's SCR hardware function is installed.**

- **OnBoard CIR port**

Disabled	Disable this function. (Default Value)
Enabled	Enable Onboard CIR port.

- **CIR Port IRQ**

IRQ 3 / 4 / 5 / 10 / 11 / N/A. (Default Value)

- **OnBoard Parallel port**

378	Enable On Board LPT port and address is 378.
278	Enable On Board LPT port and address is 278.
3BC	Enable On Board LPT port and address is 3BC.
Auto	Set On Board LPT port is Auto. (Default Value)
Disabled	Disable On Board LPT port.

- **Parallel Port Mode**

EPP	Using Parallel port as Enhanced Parallel Port.
ECP	Using Parallel port as Extended Capabilities Port. (Default Value)
Normal	Normal Operation.
EPP+ECP	Using Parallel port as Enhanced Parallel Port & Extended Capabilities Port.

- **Parallel Port IRQ**

7	Set Parallel Port IRQ is 7.
Auto	Set Auto to parallel Port IRQ DMA Channel. . (Default Value) .
5	Set Parallel Port IRQ is 5.

- **Parallel Port DMA**

Auto	Set Auto to parallel port mode DMA Channel. . (Default Value) .
3	Set Parallel Port DMA is 3.
1	Set Parallel Port DMA is 1.
0	Set Parallel Port DMA is 0.

- **OnBoard IDE**

Disabled	Disabled OnBoard IDE
Both	Set OnBoard IDE is Both (Default Value) .
Primary	Set OnBoard IDE is Primary
Secondary	Set OnBoard IDE is Secondary

- **OnBoard MC'97 Modem**

Auto	Enabled On Board MC'97 Modem. (Default Value)
Disabled	Disabled On Board MC'97 Modem.

- **OnBoard Creative Sound**

Enabled	Enabled OnBoard Creative Sound. (Default Value)
Disabled	Disabled OnBoard Creative Sound.

Hardware Monitor & MISC Setup

AMBIOS SETUP –HARDWARE MONITOR & MISC Setup (C) 1999 American Megatrends, Inc. All Rights Reserved	
CPU Host Clock (Mhz)	:By Jumper
Reset Case Open Status	:No
Case Status	:Open
CPU Temp.	:64°C/147°F
System Temp.	:35°C/95°F
CPU Fan Speed	:4560 RPM
System Fan Speed	:0 RPM
Vcore	:+1.536v
Vtt	:1.216v
+3.300V	:+3.296v
+5.000v	:+4.972v
+12.000v	:+12.096v
-12.000v	:-12.096v
-5.000v	:-4.600v
5VSB	:+4.892v
ESC : Quit ↑↓←→: Select Item F1 : Help PU/PD/+/- : Modify F5 : Old Values (Shift)F2 :Color F6 : Load BIOS Defaults F7 : Load Setup Defaults	

Figure 10: Hardware Monitor & MISC Setup

- **CPU Host Clock (Mhz)**

By Jumper	Set CPU Host Clock by jumper. (Default Value)
133	Set CPU Host Clock to 133MHz~161MHz.
100	Set CPU Host Clock to 100Mhz~128MHz.

- **Reset Case Open Status**

- **Case Status**

If the case is closed, "Case Status" will show "Close".

If the case have been opened, "Case Status" will show "Open" .

If you want to reset "Case Status" value, set "Reset Case Open Status" to "Yes" and save CMOS, your computer will restart.

- **CPU / System Temp. (°C / °F)**

Detect CPU / SystemTemperature automatically.

- **CPU / System FAN Speed**

Detect CPU / System Fan speed status automatically .

- **Current Voltage (V) VCORE / VDD / +3.3V / +12V / +5V**

Detect system's voltage status automatically.

Set Supervisor / User Password

When you select this function, the following message will appear at the center of the screen to assist you in creating a password.

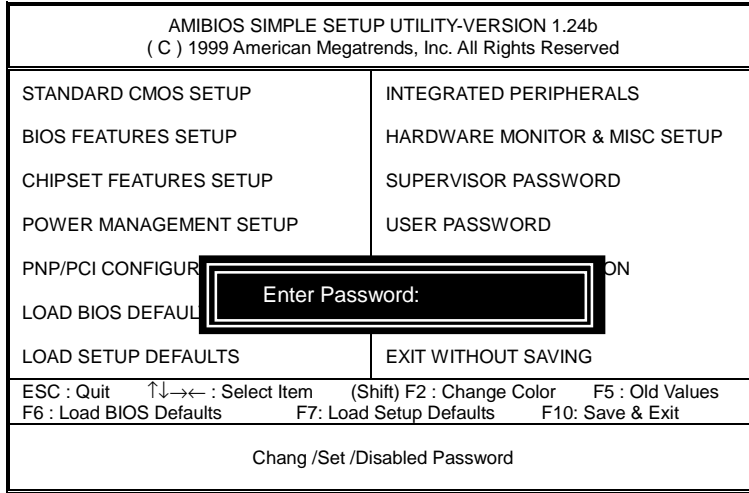

Figure 11: Password Setting

Type the password, up to six characters, and press <Enter>. The password typed now will clear the previously entered password from CMOS memory. You will be asked to confirm the password. Type the password again and press <Enter>. You may also press <Esc> to abort the selection and not enter a password.

To disable password, just press <Enter> when you are prompted to enter password. A message "PASSWORD DISABLED" will appear to confirm the password being disabled. Once the password is disabled, the system will boot and you can enter Setup freely.

If you select "Always" at "Password Check" Option in BIOS Features Setup Menu, you will be prompted for the password every time the system is rebooted or any time you try to enter Setup Menu. If you select "Setup" at "Password Check" Option in BIOS Features Setup Menu, you will be prompted only when you try to enter Setup.

IDE HDD AUTO Detection

AMBIOS SETUP – STANDARD CMOS SETUP (C) 1999 American Megatrends, Inc. All Rights Reserved							
Date (mm/dd/yyyy) : Tue Jan 25, 2000 Time (hh/mm/ss) : 10:36:24							
TYPE	SIZE	CYLS	HEAD	PRECOMP	LANDZ	SECTOR	MODE
Pri Master : Not Installed Pri Slave : Not Installed Sec Master : Not Installed Sec Slave : Not Installed							
Floppy Drive A: 1.44 MB 3 ½				Base Memory : 640 Kb			
Floppy Drive B: Not Installed				Other Memory: 384 Kb			
Boot Sector Virus Protection : Disabled				Extended Memory: 31Mb			
				Total Memory: 32Mb			
Month: Jan – Dec				ESC : Exit			
Day: 01 – 31				↑↓ : Select Item			
Year: 1990– 2099				PU/PD/+/- : Modify			
				(Shift)F2 : Color			

Figure 12: IDE HDD Auto Detection

Type "Y" will accept the H.D.D. parameter reported by BIOS.

Type "N" will keep the old H.D.D. parameter setup. If the hard disk cylinder number is over 1024, then the user can select LBA mode or LARGER mode for DOS partition larger than 528 MB.

Save & Exit Setup

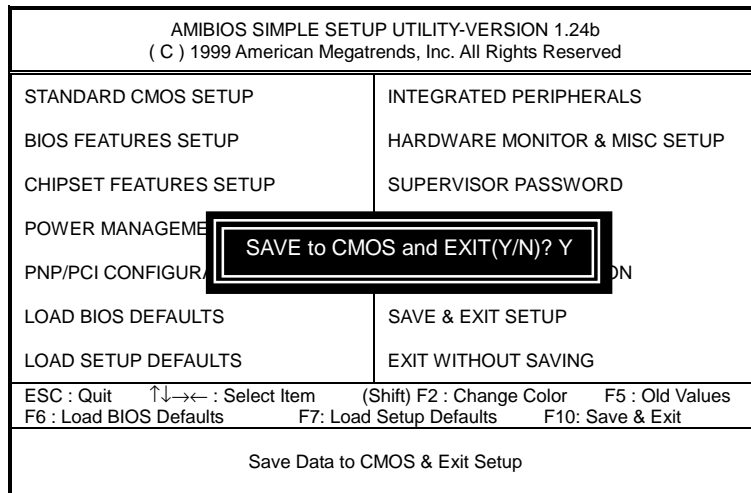

Figure 13: Save & Exit Setup

Type "Y" will quit the Setup Utility and save the user setup value to RTC CMOS.

Type "N" will return to Setup Utility.

Exit Without Saving

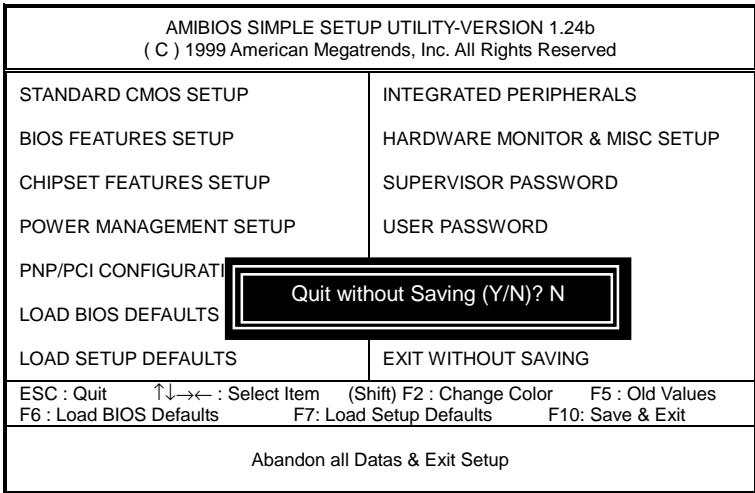

Figure 14: Exit Without Saving

Type "Y" will quit the Setup Utility without saving to RTC CMOS.
Type "N" will return to Setup Utility.



Technical Support /RMA Sheet

Customer/Country:	Company:	Phone No.:
Contact Person:	E-mail Add. :	
Model name/Lot Number:		PCB revision:
BIOS version:	O.S./A.S.:	

Hardware Configuration	Mfs.	Model name	Size:	Driver/Utility:
CPU				
Memory Brand				
Video Card				
Audio Card				
HDD				
CD-ROM / DVD-ROM				
Modem				
Network				
AMR / CNR				
Keyboard				
Mouse				
Power supply				
Other Device				

 Problem Description:



Appendix

Appendix A: VIA KT266A Chipsets Driver Installation

Insert the support CD that came with your motherboard into your CD-ROM driver or double-click the CD driver icon in My Computer to bring up the screen.



(1)

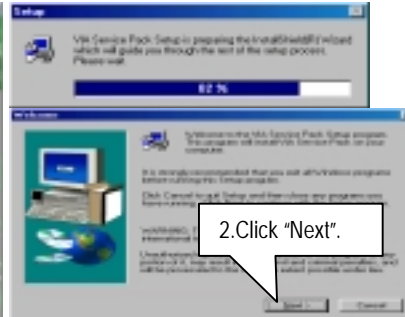

(2)

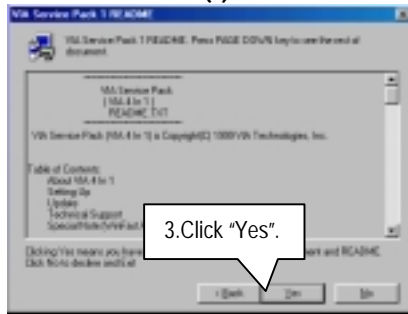

(3)



(4)

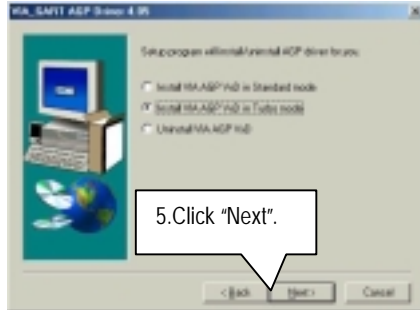

(5)



(6)

Appendix B: Creative Sound Driver Installation

Insert the support CD that came with your motherboard into your CD-ROM driver or double-click the CD driver icon in My Computer to bring up the screen.

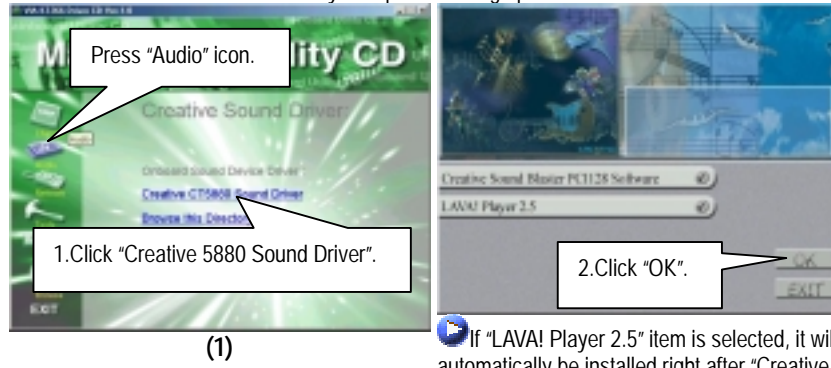

(1)

If "LAWI Player 2.5" item is selected, it will automatically be installed right after "Creative Sound Blaster PCI128 Software" installation.

(2)

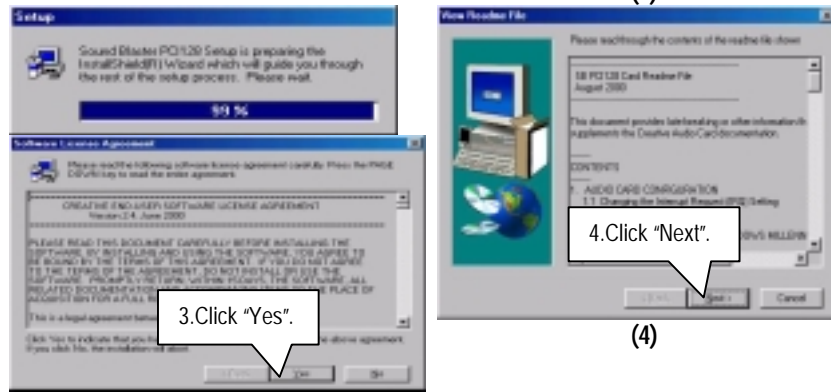

(3)

(4)

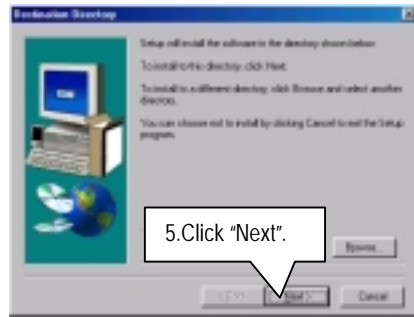

(5)

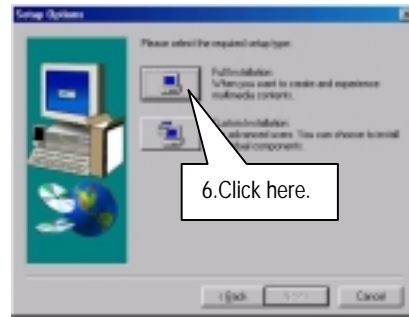

(6)

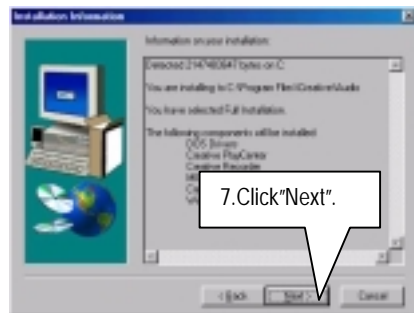

(7)

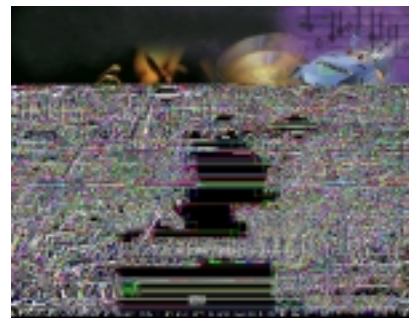

(8)

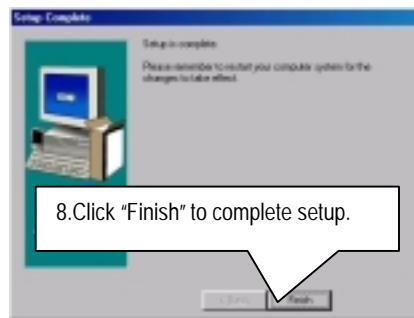

(9)

Appendix C: BIOS Flash Procedure

BIOS update procedure:

If your OS is Win9X, we recommend that you used Gigabyte @BIOS Program to flash BIOS.

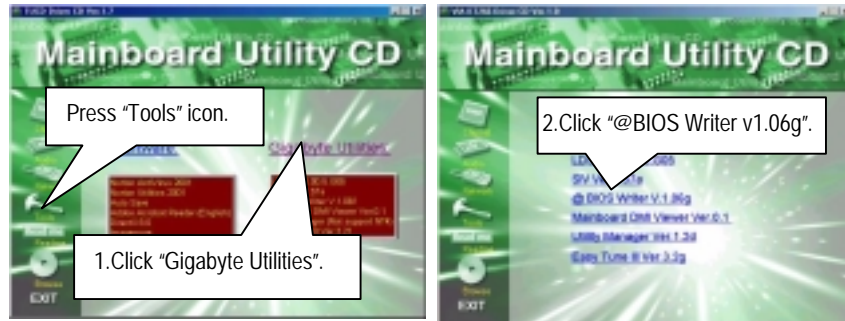

(1)

(2)

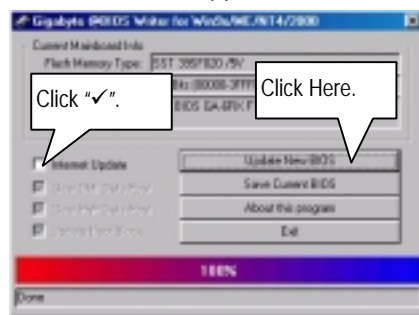

(3)

Methods and steps:

- I. Update BIOS through Internet
 - a. Click "Internet Update" icon
 - b. Click "Update New BIOS" icon
 - c. Select @BIOS sever ("Gigabyte @BIOS sever 1 in Taiwan" and "Gigabyte @BIOS sever 2 in Taiwan" are available for now, the others will be completed soon)
 - d. Select the exact model name on your motherboard
 - e. System will automatically download and update the BIOS.

II. Update BIOS **NOT** through Internet:

- a. **Do not** click "Internet Update" icon
- b. Click "Update New BIOS"
- c. Please select "All Files" in dialog box while opening the old file.
- d. Please search for BIOS unzip file, downloading from internet or any other methods (such as: 7VTX-P.F1).
- e. Complete update process following the instruction.

III. Save BIOS

In the very beginning, there is "Save Current BIOS" icon shown in dialog box. It means to save the current BIOS version.

IV. Check out supported motherboard and Flash ROM:

In the very beginning, there is "About this program" icon shown in dialog box. It can help you check out which kind of motherboard and which brand of Flash ROM are supported.

Note:

- a. In method I, if it shows two or more motherboard's model names to be selected, please make sure your motherboard's model name again. Selecting name will cause the system unbooted.
- b. In method II, be sure that motherboard's model name in BIOS unzip file are the same as your motherboard's. Otherwise, your system won't boot.
- c. In method I, if the BIOS file you need cannot be found in @BIOS server, please go onto Gigabyte's web site for downloading and updating it according to method II.
- d. Please note that any intercorruption during updating will cause system unbooted

Or else you can select flash BIOS in DOS mode.

☛ Please check your **BIOS vendor (AMI or AWARD)**, your **motherboard name** and **PCB version** on the motherboard.

1. Format a bootable system floppy diskette by the command "**format a:/s**" in command mode.
2. Visit the Gigabyte website at [http:// www.gigabyte.com.tw](http://www.gigabyte.com.tw) , Select the BIOS file you need and download it to your bootable floppy diskette.
3. Insert the bootable diskette containing the BIOS file into the floppy diskette driver.
4. Assuming that the floppy diskette driver is A, reboot the system by using the A: driver. At the A: > prompt, run the BIOS upgraded file by executing the Flash BIOS utility and the BIOS file with its appropriate extension.

Example: *(AMI tool) (Where 7VTX-P.f1 is name of the BIOS file name)*

A:>flashxxx.exe 7VTX-P.f1 ↵

Example: *(Award tool) (Where 7VTX-P.f1 is name of the BIOS file name)*

A:>Awdflash.exe 7VTX-P.f1 ↵

5. Upon pressing the <Enter> key, a flash memory writer menu will appear on screen. Enter the new BIOS file name with its extension filename into the text box after file name to program.
6. If you want to save the old BIOS file(perform as soon as system is operational, this is recommended), select Y to **DO YOU WANT TO SAVE BIOS**, then type the old BIOS filename and the extension after filename to save: This option allows you to copy the contents of the flash memory chip onto a diskette, giving you a backup copy of the original motherboard BIOS in case you need to re-install it. Select N to **DO YOU WANT TO SAVE BIOS**, if you don't want to save the old BIOS file.
7. After the decision to save the old BIOS file or not is made, select Y to **ARE YOU SURE TO PROGRAM** when the next menu appear; wait until a message showing Power Off or Reset the system appears. Then turn off your system.
8. Remove the diskette and restart your system.
9. Hold down <Delete> key to enter BIOS setup. You must select "Load Setup BIOS Default" to activate the new BIOS, then you may set other item from the main menu.

Appendix D: Acronyms

Acronyms	Meaning
ACPI	Advanced Configuration and Power Interface
APM	Advanced Power Management
AGP	Accelerated Graphics Port
AMR	Audio Modem Riser
ACR	Advanced Communications Riser
BIOS	Basic Input / Output System
CPU	Central Processing Unit
CMOS	Complementary Metal Oxide Semiconductor
CRIMM	Continuity RIMM
CNR	Communication and Networking Riser
DMA	Direct Memory Access
DMI	Desktop Management Interface
DIMM	Dual Inline Memory Module
DRM	Dual Retention Mechanism
DRAM	Dynamic Random Access Memory
DDR	Double Data Rate
ECP	Extended Capabilities Port
ESCD	Extended System Configuration Data
ECC	Error Checking and Correcting
EMC	Electromagnetic Compatibility
EPP	Enhanced Parallel Port
ESD	Electrostatic Discharge
FDD	Floppy Disk Device
FSB	Front Side Bus
HDD	Hard Disk Device
IDE	Integrated Dual Channel Enhanced
IRQ	Interrupt Request
I/O	Input / Output
IOAPIC	Input Output Advanced Programmable Input Controller
ISA	Industry Standard Architecture
LAN	Local Area Network
LBA	Logical Block Addressing
LED	Light Emitting Diode
MHz	Megahertz
MIDI	Musical Interface Digital Interface
MTH	Memory Translator Hub
MPT	Memory Protocol Translator
NIC	Network Interface Card
OS	Operating System

To be continued...

Acronyms	Meaning
OEM	Original Equipment Manufacturer
PAC	PCI A.G.P. Controller
POST	Power-On Self Test
PCI	Peripheral Component Interconnect
RIMM	Rambus in-line Memory Module
SCI	Special Circumstance Instructions
SECC	Single Edge Contact Cartridge
SRAM	Static Random Access Memory
SMP	Symmetric Multi-Processing
SMI	System Management Interrupt
USB	Universal Serial Bus
VID	Voltage ID