

## FCC Compliance Statement:

<p align="center"><b>DECLARATION OF CONFORMITY</b> Per FCC Part 2 Section 2.107(a)</p> <p align="center"><b>FC</b></p> <p>Responsible Party Name: G.B.T. INC.</p> <p align="center">Address: 1806 Valley Blvd., Suite#A LA Puente, CA 91744</p> <p align="center">Phone/Fax No: (818) 854-9338 / (818) 854-9339</p> <p>hereby declares that the product</p> <p>Product Name: Mother Board</p> <p>Model Number: GA-7VM</p> <p>Conforms to the following specifications:</p> <p>FCC Part 15, Subpart B, Section 15.107(a) and Section 15.109(a). Class B Digital Device.</p> <p><b>Supplementary Information:</b></p> <p>This device complies with part 15 of the FCC Rules. Operation is subject to the following two conditions: (1) This device may not cause harmful and (2) this device must accept any interference received, including that may cause undesired operation.</p> <p>Representative Person's Name: <u>ERIC LU</u></p> <p>Signature: <u>Eric Lu</u></p> <p>Date: <u>Mar. 3, 2000</u></p>
---

This equipment has been tested and found to comply with limits for a Class B digital device , pursuant to Part 15 of the FCC rules. These limits are designed to provide reasonable protection against harmful interference in residential installations. This equipment generates, uses, and can radiate radio frequency energy, and if not installed and used in accordance with the instructions, may cause harmful interference to radio communications. However, there is no guarantee that interference will not occur in a particular installation. If this equipment does cause interference to radio or television equipment reception, which can be

determined by turning the equipment off and on, the user is encouraged to try to correct the interference by one or more of the following measures:

- Reorient or relocate the receiving antenna
- Move the equipment away from the receiver
- Plug the equipment into an outlet on a circuit different from that to which the receiver is connected
- Consult the dealer or an experienced radio/television technician for additional suggestions

You are cautioned that any change or modifications to the equipment not expressly approve by the party responsible for compliance could void Your authority to operate such equipment.

This device complies with Part 15 of the FCC Rules. Operation is subjected to the following two conditions 1) this device may not cause harmful interference and 2) this device must accept any interference received, including interference that may cause undesired operation.

## Declaration of Conformity

We, Manufacturer/Importer  
(full address)

**G.B.T. Technology Trading GmbH**  
**Ausschlagler Weg 41, 1F, 20537 Hamburg, Germany**

declare that the product  
( description of the apparatus, system, installation to which it refers)

**Mother Board**  
GA-7VM

is in conformity with  
(reference to the specification under which conformity is declared)  
in accordance with 89/336 EEC-EMC Directive

- |   |  |  |  |
|---|--|--|--|
| <input type="checkbox"/> EN 55011   | Limits and methods of measurement of radio disturbance characteristics of industrial, scientific and medical (ISM) high frequency equipment                | <input checked="" type="checkbox"/> EN 61000-3-2*<br><input checked="" type="checkbox"/> EN60555-2 | Disturbances in supply systems caused by household appliances and similar electrical equipment "Harmonics"   |
| <input type="checkbox"/> EN55013  | Limits and methods of measurement of radio disturbance characteristics of broadcast receivers and associated equipment                                     | <input type="checkbox"/> EN61000-3-3*<br><input checked="" type="checkbox"/> EN60555-3             | Disturbances in supply systems caused by household appliances and similar electrical equipment "Voltage fluctuations"                                  |
| <input type="checkbox"/> EN 55014   | Limits and methods of measurement of radio disturbance characteristics of household electrical appliances, portable tools and similar electrical apparatus | <input checked="" type="checkbox"/> EN 50081-1<br><input checked="" type="checkbox"/> EN 50082-1   | Generic emission standard Part 1: Residual, commercial and light industry<br>Generic immunity standard Part 1: Residual, commercial and light industry |
| <input type="checkbox"/> EN 55015   | Limits and methods of measurement of radio disturbance characteristics of fluorescent lamps and luminaries   | <input type="checkbox"/> EN 55081-2  | Generic emission standard Part 2: Industrial environment   |
| <input type="checkbox"/> EN 55020   | Immunity from radio interference of broadcast receivers and associated equipment   | <input type="checkbox"/> EN 55082-2  | Generic immunity standard Part 2: Industrial environment   |
| <input checked="" type="checkbox"/> EN 55022  | Limits and methods of measurement of radio disturbance characteristics of information technology equipment   | <input type="checkbox"/> ENV 55104   | Immunity requirements for household appliances tools and similar apparatus   |
| <input type="checkbox"/> DIN VDE 0855<br><input type="checkbox"/> part 10<br><input type="checkbox"/> part 12 | Cabled distribution systems: Equipment for receiving and/or distribution from sound and television signals   | <input type="checkbox"/> EN 50091- 2   | EMC requirements for uninterruptible power systems (UPS)   |

CE marking



(EC conformity marking)

**The manufacturer also declares the conformity of above mentioned product with the actual required safety standards in accordance with LVD 73/23 EEC**

- |                                   |   |                                     |   |
|-----------------------------------|---|-------------------------------------|---|
| <input type="checkbox"/> EN 60065 | Safety requirements for mains operated electronic and related apparatus for household and similar general use | <input type="checkbox"/> EN 60950   | Safety for information technology equipment including electrical business equipment |
| <input type="checkbox"/> EN 60335 | Safety of household and similar electrical appliances   | <input type="checkbox"/> EN 50091-1 | General and Safety requirements for uninterruptible power systems (UPS)             |

**Manufacturer/Importer**

Signature : Rex Lin

Name : Rex Lin

(Stamp)

Date : Mar. 3, 2000

7VM  
AMD™ Athlon AGP Motherboard

# USER'S MANUAL

AMD™ Athlon Processor Motherboard  
REV. 1.1 Fourth Edition

R-11-04-000425



## How this manual is organized

This manual is divided into the following sections:

<b>1) Revision List</b>	Manual revision information
<b>2) Item Checklist</b>	Product item list
<b>3) Features</b>	Product information & specification
<b>4) Hardware Setup</b>	Instructions on setting up the motherboard
<b>5) Performance &amp; Block Diagram</b>	Product Performance & Block Diagram
<b>6) Suspend to RAM</b>	Instructions STR installation
<b>7) BIOS Setup</b>	Instructions on setting up the BIOS software
<b>8) Appendix</b>	General reference

## Table Of Content

Revision History	P.1
Item Checklist	P.2
Summary of Features	P.3
7VM Motherboard Layout	P.5
Page index for CPU Speed Setup / Connectors / Panel and Jumper Definition	P.6
Performance List	P.22
Block diagram	P.23
Suspend to RAM Installation	P.24
Memory Installation	P.30
Page index for BIOS Setup	P.31
Appendix	P.61

## Revision History

Revision	Revision Note	Date
1.1	Initial release of the 7VM motherboard user's manual.	Mar. 2000
1.1	Second release of the 7VM motherboard user's manual.	Mar. 2000
1.1	Third release of the 7VM motherboard user's manual.	Mar. 2000
1.1	Fourth release of the 7VM motherboard user's manual.	Apr. 2000

The author assumes no responsibility for any errors or omissions that may appear in this document nor does the author make a commitment to update the information contained herein. Third-party brands and names are the property of their respective owners.

## Item Checklist

- The 7VM Motherboard
- Cable for IDE / Floppy device
- Diskettes or CD (TUCD) for motherboard utilities
- 7VM User's Manual



## Summary Of Features

Form factor	<ul style="list-style-type: none"> <li>• 24.7 cm x 21.1 cm Micro ATX SIZE form factor, 4 layers PCB.</li> </ul>
CPU	<ul style="list-style-type: none"> <li>• AMD Athlon(K7) Slot A Processor</li> <li>• 512 KB 2nd cache in CPU Module</li> <li>• Supports 500MHz ~ 1GHz and faster</li> </ul>
Chipset	<p>Apollo KX133 ,consisting of:</p> <ul style="list-style-type: none"> <li>• VIA8371 Memory/AGP/PCI Controller(PAC)</li> <li>• VT82C686A PCI Super-I/O Integrated Peripheral Controller (PSIPC)</li> </ul>
Clock Generator	<ul style="list-style-type: none"> <li>• Supports 100~143MHz</li> </ul>
Memory	<ul style="list-style-type: none"> <li>• 3 168-pin DIMM Sockets</li> <li>• Supports SDRAM up to 1.5GB</li> <li>• Supports only 3.3V SDRAM DIMM, PC-133 supported</li> </ul>
I/O Control	<ul style="list-style-type: none"> <li>• VT82C686A</li> </ul>
Slots	<ul style="list-style-type: none"> <li>• 1 AGP (Accelerated Graphics Port) slot <ul style="list-style-type: none"> <li>- AGP 66 / 133 MHz, 3.3V/1.5V device support</li> </ul> </li> <li>• 3 32-bit Master PCI Bus slots</li> <li>• 1 AMR Slot</li> </ul>
On-Board IDE	<ul style="list-style-type: none"> <li>• An IDE controller on the VT82C686A PCI chipset provides IDE HDD/ CD-ROM with PIO, Bus Master , Ultra DMA/33, and ATA 66 Operation modes</li> <li>• Can connect up to four IDE devices</li> </ul>
On-Board Peripherals	<ul style="list-style-type: none"> <li>• 1 Floppy port supports 2 FDD with 360K, 720K,1.2M, 1.44M and 2.88M bytes</li> <li>• 1 Parallel port supports SPP/EPP/ECP mode</li> <li>• 2 Serial Ports (COM 1 &amp; COM 2)</li> <li>• 4 USB ports</li> <li>• 1 IrDA connector for Fast IrDA</li> </ul>
Hardware Monitor (Optional)	<ul style="list-style-type: none"> <li>• CPU/Power Supply/Panel Fan Revolution detect</li> <li>• System Voltage Detect</li> <li>• CPU Overheat Warning</li> <li>• Display Actual Current Voltage</li> </ul>

To be continued...

---

Summary Of Features

PS/2 Connector	<ul style="list-style-type: none"><li>• PS/2<sup>®</sup> Keyboard interface and PS/2<sup>®</sup> Mouse interface</li></ul>
BIOS	<ul style="list-style-type: none"><li>• Licensed AMI BIOS, 2M bit FLASH RAM</li></ul>
Additional Features	<ul style="list-style-type: none"><li>• Internal/External Modem Wake up</li><li>• STR (Suspend-To-RAM)</li><li>• LAN Wake up</li><li>• System after AC back</li></ul>

# 7VM Motherboard Layout

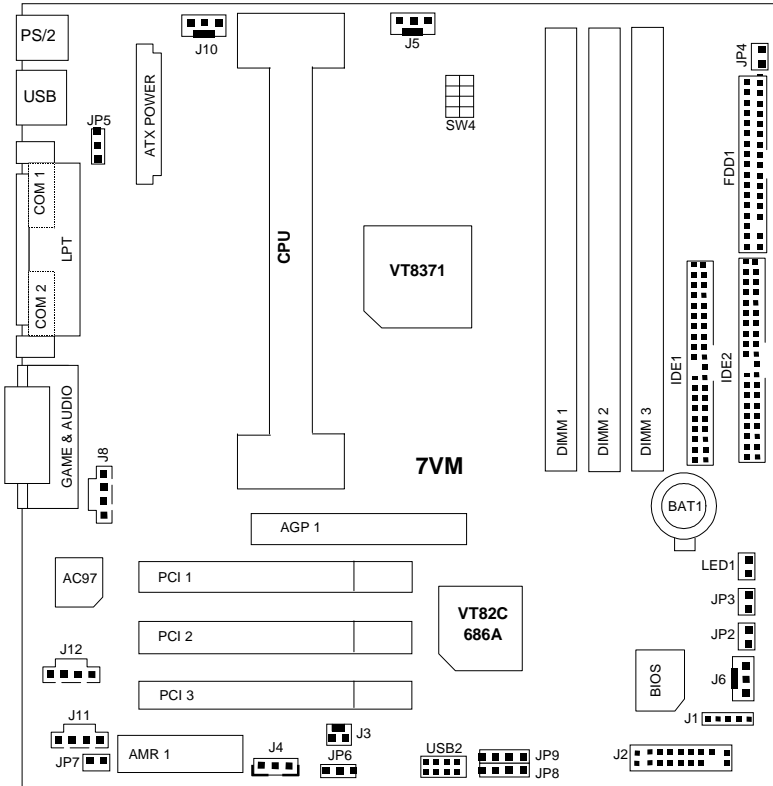

 Page index for CPU Speed Setup / Connectors / Panel and Jumper Definition	Page
CPU Speed Setup	P.7
Connectors	P.8
GAME & Audio Port	P.8
COM 1 / COM 2 / LPT Port	P.8
USB Connector	P.9
PS/2 Keyboard & PS/2 Mouse Connector	P.9
J10 (Power FAN)	P.10
J5 (CPU FAN)	P.10
J6 (System FAN)	P.11
ATX Power	P.11
Floppy Port	P.12
IDE 1(Primary) / IDE 2(Secondary) Prot	P.12
USB2 (USB Port)	P.13
IR	P.13
JP3 (STR LED Connector) & LED1(DRAM LED)	P.14
J3 (Modem Wake Up)	P.14
J4 (LAN Wake Up)	P.15
J12 (TEL)	P.15
J11 (AUX_IN)	P.16
J8 (CD Audio Line In)	P.16
Panel and Jumper Definition	P.17
J2 (2x11 PINs Jumper)	P.17
JP2 (BIOS Write Protection)	P.18
JP6 (Front Panel USB Device Wake Up Selection)[Optional]	P.18
JP5 (Rear Panel USB Device Wake Up Selection)[Optional]	P.19
JP4 (STR Enable)	P.19
JP7/JP8/JP9 (Onboard AC97 & AMR Select)	P.20
JP7 (AMR Primary / Secondary Select)	P.20
BAT1 (Battery)	P.21

## CPU Speed Setup

The system bus speed is selectable at 100 ~143MHz. The user can select the system bus speed by DIP switch **SW4**.

### Set System Bus Speed

SW4:

O : ON, X : OFF

4	3	2	1	CPU	PCI	Spectrum
X	X	X	X	133.3	33.3	5%
O	X	X	X	100.2	33	5%
X	O	X	O	110	36.7	X
O	X	X	O	115	38.3	X
O	O	X	O	120	30	X
X	X	O	X	133.3	33.3	X
O	X	O	X	100.2	33.3	X
X	X	O	O	124	31	X
X	O	O	O	129	32.3	X
O	X	O	O	138	34.5	X
O	O	O	O	143	35.8	X

## Connectors

### GAME & Audio Port

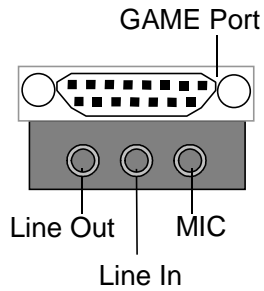
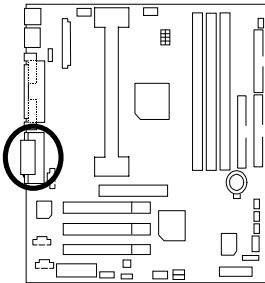

### COM 1 / COM 2 / LPT Port

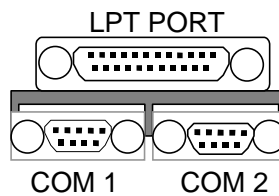
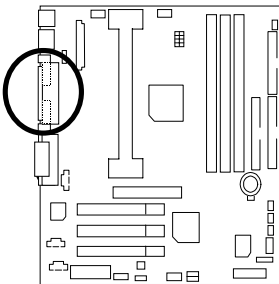

## USB Connector

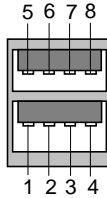
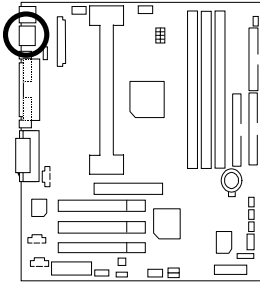

Pin No.	Definition
1	USB V0
2	USB D0-
3	USB D0+
4	GND
5	USB V1
6	USB D1-
7	USB D1+
8	GND

## PS/2 Keyboard & PS/2 Mouse Connector

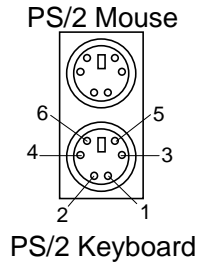
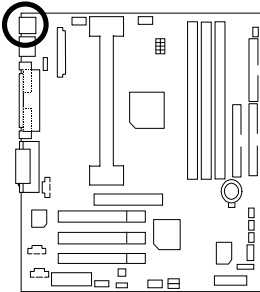

PS/2 Mouse/ Keyboard	
Pin No.	Definition
1	Data
2	NC
3	GND
4	VCC(+5V)
5	Clock
6	NC

## J10: Power FAN

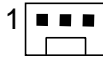
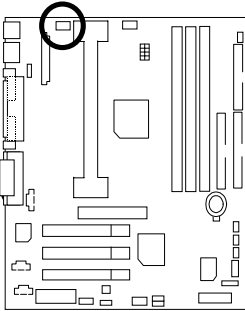

Pin No.	Definition
1	GND
2	+12V
3	SENSE

## J5: CPU FAN

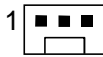
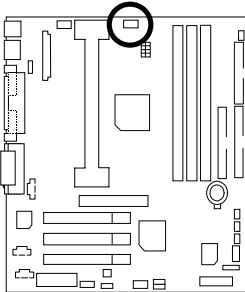

Pin No.	Definition
1	GND
2	+12V
3	SENSE



## J6: System FAN

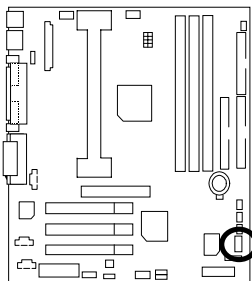

Pin No.	Definition
1	GND
2	+12V
3	SENSE

## ATX Power

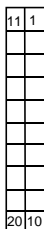
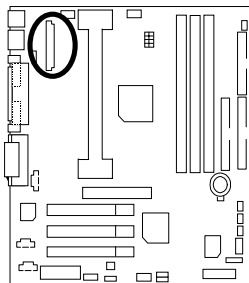

Pin No.	Definition
3,5,7,13,15-17	GND
1,2,11	3.3V
4,6,19,20	VCC
10	+12V
12	-12V
18	-5V
8	Power Good
9	5V SB stand by+5V
14	PS-ON(Soft On/Off)

## Floppy Port

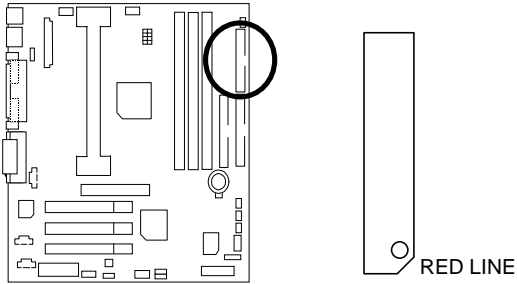

## IDE1 (Primary) , IDE2 (Secondary) Port

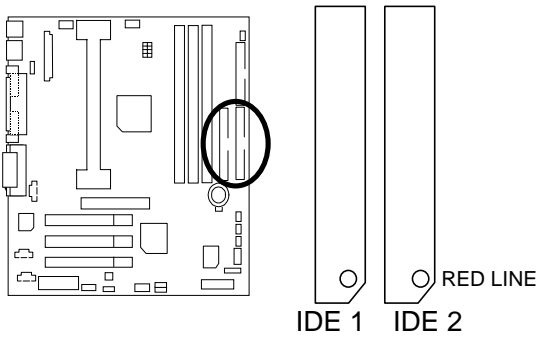

## USB2 : USB Port

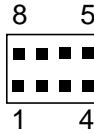
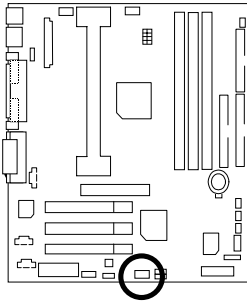

Pin No.	Definition
1	VCC
2	USB D0-
3	USB D0+
4	GND
5	VCC
6	USB D1-
7	USB D1+
8	GND

## IR : Infrared Connector

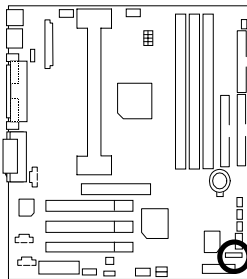

Pin No.	Definition
1	VCC (+5V)
2	NC
3	IR Data Input
4	GND
5	IR Data Output

### JP3 : STR LED Connector & LED1 (DRAM LED)

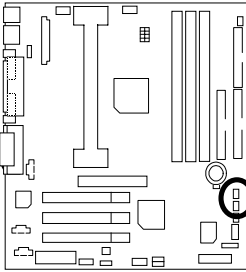

+ LED1  
(DRAM LED)

1 JP3

STR LED Connector External.

### J3 : Modem Wake Up (Internal Modem Card Wake Up)

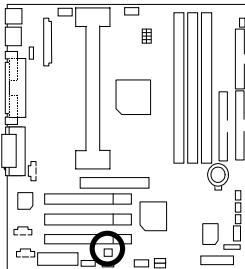

1

Pin No.	Definition
1	Signal
2	GND

### J4 : LAN Wake Up

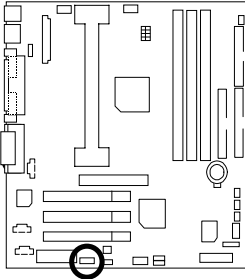

Pin No.	Definition
1	+5V SB
2	GND
3	Signal

J12 TEL: The connector is for Modem with internal voice connector

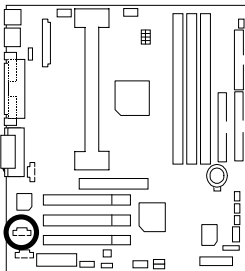

Pin No.	Definition
1	Signal-In
2	GND
3	GND
4	Signal-Out

## J11:AUX\_IN

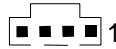
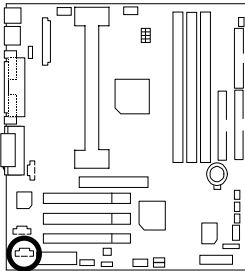

Pin No.	Definition
1	AUX-L
2	GND
3	GND
4	AUX-R

## J8 : CD Audio Line In

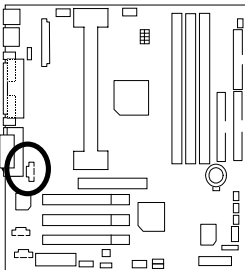

Pin No.	Definition
1	CD-L
2	GND
3	GND
4	CD-R

## Panel and Jumper Definition

J2 : For 2X11 PINs Jumper

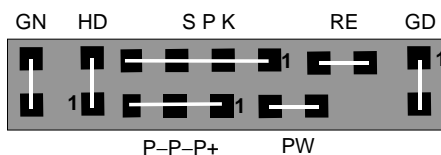
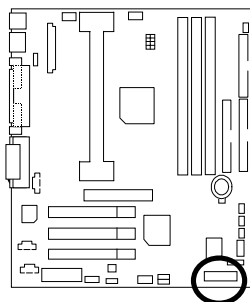

GN (Green Switch)	Open: Normal Operation Close: Entering Green Mode
GD (Green LED)	Pin 1: LED anode(+) Pin 2: LED cathode(-)
HD (IDE Hard Disk Active LED)	Pin 1: LED anode(+) Pin 2: LED cathode(-)
SPK (Speaker Connector)	Pin 1: VCC(+) Pin 2- Pin 3: NC Pin 4: Data(-)
RE (Reset Switch)	Open: Normal Operation Close: Reset Hardware System
P+P-P-(Power LED)	Pin 1: LED anode(+) Pin 2: LED cathode(-) Pin 3: LED cathode(-)
PW (Soft Power Connector)	Open: Normal Operation Close: Power On/Off

## JP2 : BIOS Write Protection

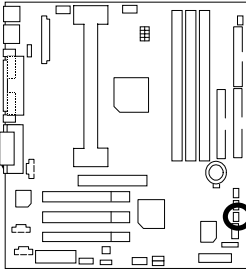

Pin No.	Definition
ON	Write Protect Enable
OFF	Write Protect Disable (Default)

## JP6 : Front Panel USB Device Wake up Selection(Optional)

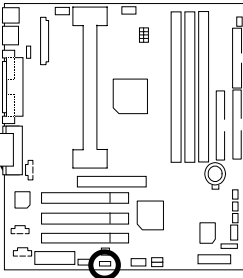

Pin No.	Definition
1-2 close	FP USB Wake Up
2-3 close	Normal (Default)

(If you want to use "USB KB/Mouse Wake from S3" function, you have to set the BIOS setting "USB KB/Mouse Wake from S3" enabled, and the jumper "JP6" enabled).  
 \*(Power on the computer and as soon as memory counting starts, press <Del>. You will enter BIOS Setup. Select the item "POWER MANAGEMENT SETUP", then select "USB KB/Mouse Wake from S3: Enabled". Remember to save the setting by pressing "ESC" and choose the "SAVE & EXIT SETUP" option.)



## JP5 : Rear Panel USB Device Wake up Selection(Optional)

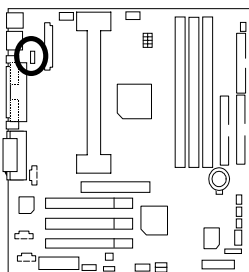

Pin No.	Definition
1-2 close	RP USB Wake Up
2-3 close	Normal (Default)

(If you want to use "USB KB/Mouse Wake from S3" function, you have to set the BIOS setting "USB KB/Mouse Wake from S3" enabled, and the jumper "JP5" enabled).  
 \*(Power on the computer and as soon as memory counting starts, press <Del>. You will enter BIOS Setup. Select the item "POWER MANAGEMENT SETUP", then select "USB KB/Mouse Wake from S3: Enabled". Remember to save the setting by pressing "ESC" and choose the "SAVE & EXIT SETUP" option.)

## JP4:STR Enable

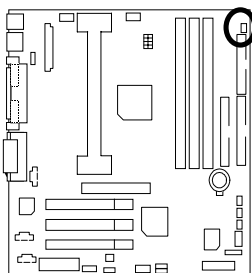

Pin No.	Definition
ON	STR Enabled
OFF	STR Disabled (Default)

JP7/JP8/JP9: Onboard AC97& AMR Select  
 (AMR→ Audio Modem Riser)

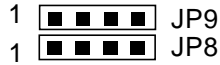
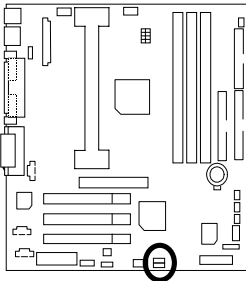

Function \ Jumper	JP7	JP8	JP9
Onboard AC97	OFF	1-2	1-2
AMR (Primary)	OFF	3-4	3-4
Onboard AC97+AMR (Secondary)	ON	1-2, 3-4	1-2

JP7: AMR Primary / Secondary Select

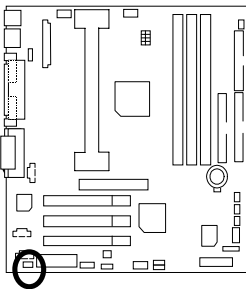

Pin No.	Definition
ON	AMR Secondary (Default)
OFF	AMR Primary

## BAT1 : Battery

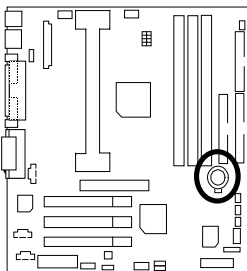

- ⚠ Danger of explosion if battery is incorrectly replaced.
- ⚠ Replace only with the same or equivalent type recommended by the manufacturer.
- ⚠ Dispose of used batteries according to the manufacturer's instructions.

## Performance List

The following performance data list is the testing results of some popular benchmark testing programs.

These data are just referred by users, and there is no responsibility for different testing data values gotten by users. (The different Hardware & Software configuration will result in different benchmark testing results.)

- CPU AMD Athlon™ 800MHz processor
- DRAM (128x1) MB SDRAM (MOSEL 9928PR V54C365804VCT7)
- CACHE SIZE 512 KB included in CPU
- DISPLAY GA-660 PLUS 32 (32MB)
- STORAGE Onboard IDE (Quantum KA13600AT)
- O.S. Windows NT™ 4.0 SP6
- DRIVER Display Driver at 1024 x 768 x 64k colors x 75Hz.
- BUS MASTER 4 IN 1 Driver (Ver. 4.20)

Processor	AMD Athlon
	800MHz (100x8)
<b>Winbench99</b>	
CPU mark 99	71.8
FPU Winmark 99	4400
Business Disk Winmark 99	5560
Hi-End Disk Winmark 99	12300
Business Graphics Winmark 99	393
Hi-End Graphics Winmark 99	793
<b>Winstone99</b>	
Business Winstone 99	43.8
Hi-End Winstone 99	44.2

# Block Diagram

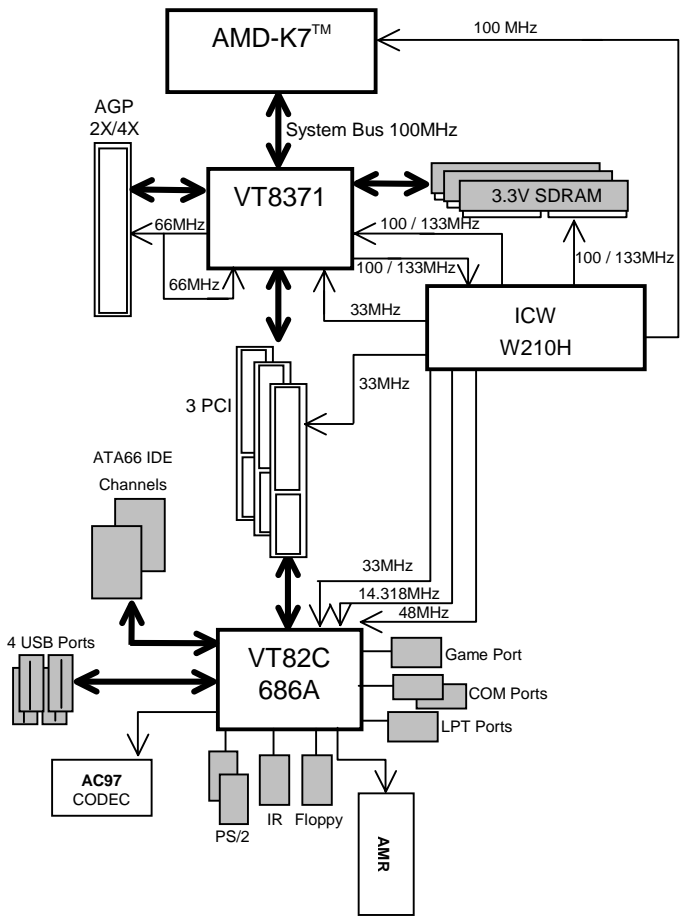

---

## Suspend to RAM Installation

### Suspend to RAM Installation

#### A.1 Introduce STR function:

Suspend-to-RAM (STR) is a Windows 98 ACPI sleep mode function. When recovering from STR (S3) sleep mode, the system is able, in just a few seconds, to retrieve the last "state" of the system before it went to sleep and recover to that state. The "state" is stored in memory (RAM) before the system goes to sleep. During STR sleep mode, your system uses only enough energy to maintain critical information and system functions, primarily the system state and the ability to recognize various "wake up" triggers or signals, respectively.

#### A.2 STR function Installation

Please use the following steps to complete the STR function installation.

##### Step-By-Step Setup

##### Step 1:

To utilize the STR function, the system must be in Windows 98 ACPI mode.

Putting Windows 98 into ACPI mode is fairly easy.

##### Setup with Windows 98 CD:

- A. Insert the Windows 98 CD into your CD-ROM drive, select Start, and then Run.
- B. Type (without quotes) "**D:\setup /p j**" in the window provided. Hit the enter key or click OK.  
『 In Windows 98 second edition version, all the bios version dated 12/01/99 or later are ACPI compatible. Just type" D:\Setup", the operating system will be installed as ACPI mode. 』
- C. After setup completes, remove the CD, and reboot your system  
(This manual assumes that your CD-ROM device drive letter is D:).

**Step 2:**

(If you want to use STR Function, please set jumper JP4 (Closed.)

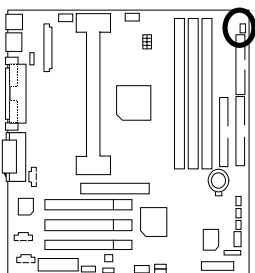

Pin No.	Definition
ON	STR Enabled
OFF	STR Disabled (Default)

**Step 3:**

Power on the computer and as soon as memory counting starts, press <Del>. You will enter BIOS Setup. Select the item **"POWER MANAGEMENT SETUP"**, then select **"ACPI Standby State: S3 /STR"**. Remember to save the settings by pressing "ESC" and choose the **"SAVE & EXIT SETUP"** option.

Congratulation! You have completed the installation and now can use the STR function.

### A.3 How to put your system into STR mode?

There are two ways to accomplish this:

1. Choose the "Stand by" item in the "Shut Down Windows" area.
  - A. Press the "Start" button and then select "Shut Down"



- B. Choose the "Stand by" item and press "OK"

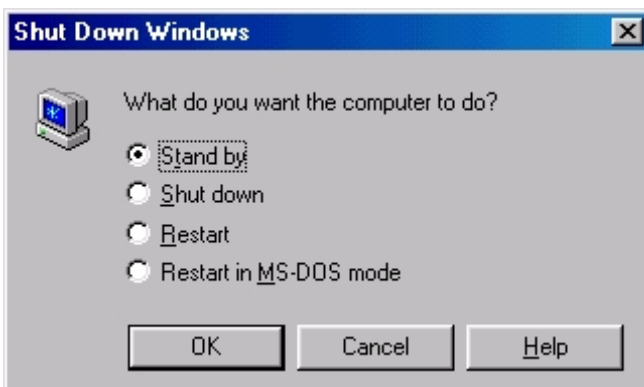



## 7VM Motherboard

---

2. Define the system "power on" button to initiate STR sleep mode:

A. Double click "My Computer" and then "Control Panel"

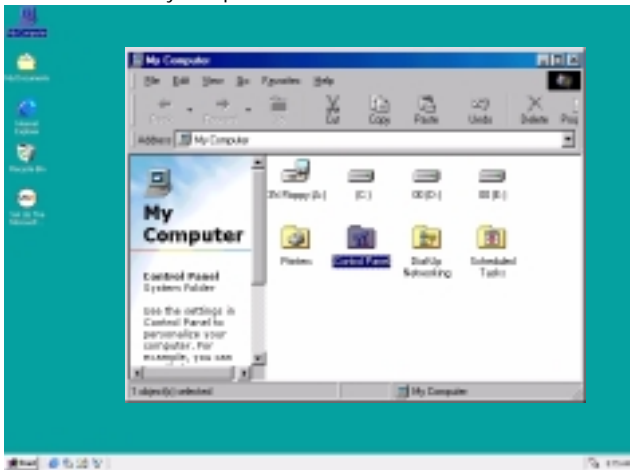

B. Double click the "Power Management" item.

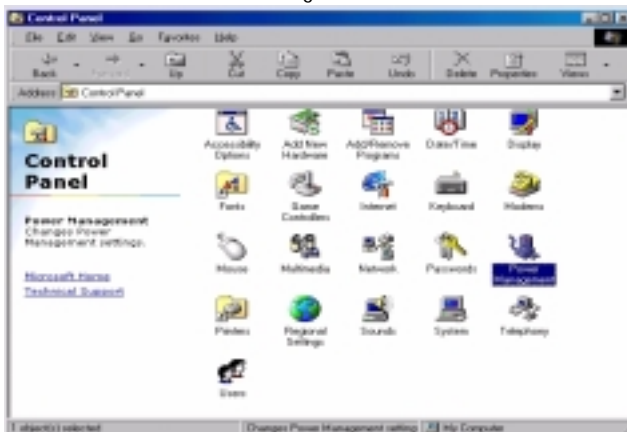

C. Select the "Advanced" tab and "Standby" mode in Power Buttons.

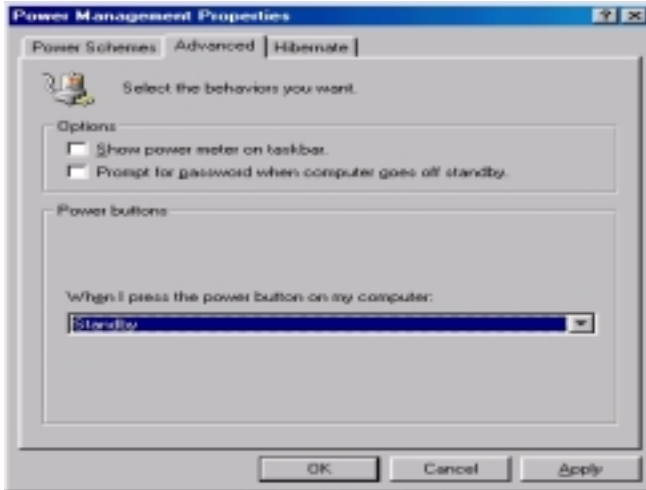

**Step 4:**

Restart your computer to complete setup.

Now when you want to enter STR sleep mode, just momentarily press the "Power on" button..

**A.4 How to recover from the STR sleep mode?**

There are seven ways to "wake up" the system:

1. Press the "Power On" button.
2. Use the "PS/2 Keyboard Power On" function.
3. Use the "PS/2 Mouse Power On" function.
4. Use the "Resume by Alarm" function.
5. Use the "Modem Ring On" function.
6. Use the "Wake On LAN" function.
7. Use the "USB Device Wake Up" function.

### A.5 Notices :

1. In order for STR to function properly, several hardware and software requirements must be satisfied:
  - A. Your ATX power supply must comply with the ATX 2.01 specification (provide more than 720 mA 5V Stand-By current).
  - B. Your SDRAM must be PC-100 compliant.
  
2. Jumper JP3 is provided to connect to the STR LED in your system chassis. [Your chassis may not provide this feature.] The STR LED will be illuminated when your system is in STR sleep mode.

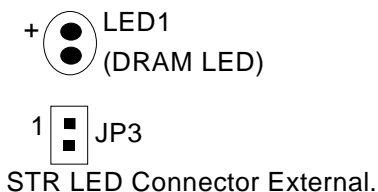
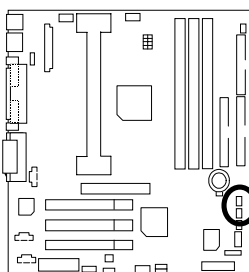

## Memory Installation

The motherboard has 3 dual inline memory module (DIMM) sockets. The BIOS will automatically detects memory type and size. To install the memory module, just push it vertically into the DIMM Slot .The DIMM module can only fit in one direction due to the two notch. Memory size can vary between sockets.

Install memory in any combination table:

DIMM	168-pin SDRAM DIMM Modules	
Bank 0	Supports 8 / 16 / 32 / 64 / 128 / 256 / 512 MB	X 1 pcs
Bank 1	Supports 8 / 16 / 32 / 64 / 128 / 256 / 512 MB	X 1 pcs
Bank 2	Supports 8 / 16 / 32 / 64 / 128 / 256 / 512 MB	X 1 pcs

## 7VM Motherboard

---

 Page index for BIOS Setup	Page
The MAIN MENU	P.33
Standard CMOS Features	P.36
BIOS Features Setup	P.39
Chipset Features Setup	P.41
Power Management Setup	P.44
PNP/ PCI Configuration	P.47
Load BIOS Defaults	P.49
Load SETUP Defaults	P.50
Integrated Peripherals	P.51
Hardware Monitor Setup	P.55
Set Supervisor / User Password	P.57
IDE HDD Auto Detection	P.58
Save & Exit Setup	P.59
Exit Without Saving	P.60

## BIOS Setup

BIOS Setup is an overview of the BIOS Setup Program. The program that allows users to modify the basic system configuration. This type of information is stored in battery-backed CMOS SRAM so that it retains the Setup information when the power is turned off.

### ENTERING SETUP

Power ON the computer and press <Del> immediately will allow you to enter Setup. If the message disappears before you respond and you still wish to enter Setup, restart the system to try again by turning it OFF then ON or pressing the "RESET" button on the system case. You may also restart by simultaneously press <Ctrl> – <Alt>– <Del> keys.

### CONTROL KEYS

<↑>	Move to previous item
<↓>	Move to next item
<←>	Move to the item in the left hand
<→>	Move to the item in the right hand
<Esc>	Main Menu - Quit and not save changes into CMOS Status Page Setup Menu and Option Page Setup Menu - Exit current page and return to Main Menu
<+/PgUp>	Increase the numeric value or make changes
<-/PgDn>	Decrease the numeric value or make changes
<F1>	General help, only for Status Page Setup Menu and Option Page Setup Menu
<F2>	Reserved
<F3>	Reserved
<F4>	Reserved
<F5>	Restore the previous CMOS value from CMOS, only for Option Page Setup Menu
<F6>	Load the default CMOS value from BIOS default table, only for Option Page Setup Menu
<F7>	Load the SETUP Defaults.
<F8>	Reserved
<F9>	Reserved
<F10>	Save all the CMOS changes, only for Main Menu

## GETTING HELP

### Main Menu

The on-line description of the highlighted setup function is displayed at the bottom of the screen.

### Status Page Setup Menu / Option Page Setup Menu

Press F1 to pop up a small help window that describes the appropriate keys to use and the possible selections for the highlighted item. To exit the Help Window press <Esc>.

## THE MAIN MENU

Once you enter AMI BIOS CMOS Setup Utility, the Main Menu (Figure 1) will appear on the screen. The Main Menu allows you to select from nine setup functions and two exit choices. Use arrow keys to select among the items and press <Enter> to accept or enter the sub-menu.

AMIBIOS SIMPLE SETUP UTILITY – VERSION 1.21 (C) 1999 American Megatrends, Inc. All Rights Reserved	
STANDARD CMOS SETUP	INTEGRATED PERIPHERALS
BIOS FEATURES SETUP	HARDWARE MONITOR SETUP
CHIPSET FEATURES SETUP	SUPERVISOR PASSWORD
POWER MANAGEMENT SETUP	USER PASSWORD
PNP / PCI CONFIGURATION	IDE HDD AUTO DETECTION
LOAD BIOS DEFAULTS	SAVE & EXIT SETUP
LOAD SETUP DEFAULTS	EXIT WITHOUT SAVING
ESC: Quit      ↑↓→← : Select Item      (Shift)F2 : Change Color      F5: Old Values F6: Load BIOS Defaults      F7: Load SETUP Defaults      F10: Save & Exit	
Time, Date , Hard Disk Type...	

Figure 1: Main Menu

- **Standard CMOS Features**

This setup page includes all the items in standard compatible BIOS.

- **BIOS Features Setup**

This setup page includes all the items of AMI special enhanced features.

- **Chipset Features Setup**

This setup page includes all the items of chipset special features.

- **Power Management Setup**

This setup page includes all the items of Green function features.

- **PnP/PCI Configurations**

This setup page includes all the configurations of PCI & PnP ISA resources.

- **Load BIOS Defaults**

BIOS Defaults indicates the value of the system parameters which the system would be in safe configuration.

- **Load Setup Defaults**

Setup Defaults indicates the value of the system parameters which the system would be in best performance configuration.

- **Integrated Peripherals**

This setup page includes all onboard peripherals.

- **Hardware Monitor Setup**

This setup page is the System auto detect Temperature, voltage , fan, speed.

- **Supervisor Password**

Change, set, or disable password. It allows you to limit access to the system and Setup, or just to Setup.

- **User Password**

Change, set, or disable password. It allows you to limit access to the system.

- **IDE HDD auto Detection**

Automatically configure hard disk parameters.



- **Save & Exit Setup**

Save CMOS value settings to CMOS and exit setup.

- **Exit Without Saving**

Abandon all CMOS value changes and exit setup.

## Standard CMOS Features

The items in Standard CMOS Setup Menu (Figure 2) are divided into 9 categories. Each category includes no, one or more than one setup items. Use the arrows to highlight the item and then use the <PgUp> or <PgDn> keys to select the value you want in each item.

AMIBIOS SETUP – STANDARD CMOS SETUP ( C ) 1999 American Megatrends, Inc. All Rights Reserved																																									
Date (mm/dd/yyyy) : Mon, Mar. 06, 2000 Time (hh/mm/ss) : 04:05:37																																									
<table border="1"> <thead> <tr> <th>TYPE</th> <th>SIZE</th> <th>CYLS</th> <th>HEAD</th> <th>PRECOMP</th> <th>LANDZ</th> <th>SECTOR</th> <th>MODE</th> </tr> </thead> <tbody> <tr> <td>Pri Master</td> <td>Auto</td> <td></td> <td></td> <td></td> <td></td> <td></td> <td></td> </tr> <tr> <td>Pri Slave</td> <td>Auto</td> <td></td> <td></td> <td></td> <td></td> <td></td> <td></td> </tr> <tr> <td>Sec Master</td> <td>Auto</td> <td></td> <td></td> <td></td> <td></td> <td></td> <td></td> </tr> <tr> <td>Sec Slave</td> <td>Auto</td> <td></td> <td></td> <td></td> <td></td> <td></td> <td></td> </tr> </tbody> </table>		TYPE	SIZE	CYLS	HEAD	PRECOMP	LANDZ	SECTOR	MODE	Pri Master	Auto							Pri Slave	Auto							Sec Master	Auto							Sec Slave	Auto						
TYPE	SIZE	CYLS	HEAD	PRECOMP	LANDZ	SECTOR	MODE																																		
Pri Master	Auto																																								
Pri Slave	Auto																																								
Sec Master	Auto																																								
Sec Slave	Auto																																								
Floppy Drive A : 1.44 MB 3½	Base Memory : 640 Kb																																								
Floppy Drive B : Not Installed	Other Memory : 384 Kb																																								
	Extended Memory : 63 Mb																																								
	Total Memory : 64 Mb																																								
Boot Sector Virus Protection : Disabled																																									
Month : Jan – Dec	ESC : Exit																																								
Day : 01– 31	↑↓ : Select Item																																								
Year : 1990 – 2099	PU / PD / + / - :Modify																																								
	(Shift) F2 : Color																																								

Figure 2: Standard CMOS Features

- **Date**

The date format is <week>, <month> <date> <year>.

week	The day, from Sun to Sat, determined by the BIOS and is display-only.
month	The month, Jan. Through Dec.
date	The date, from 1 to 31 (or the maximum allowed in the month).
year	The year, from 1990 through 2099.

- **Time**

The times format in <hour> <minute> <second>. The time is calculated base on the 24-hour military-time clock. For example, 1 p.m. is 13:00:00.

- **IDE Primary Master, Slave / Secondary Master, Slave**

The category identifies the types of hard disk from drive C to F that has been installed in the computer. There are two types: auto type, and manual type. Manual type is user-definable; Auto type which will automatically detect HDD type.

Note that the specifications of your drive must match with the drive table. The hard disk will not work properly if you enter improper information for this category.

If you select User Type, related information will be asked to enter to the following items. Enter the information directly from the keyboard and press <Enter>. Such information should be provided in the documentation form your hard disk vendor or the system manufacturer.

CYLS.	Number of cylinders.
HEADS	Number of heads.
PRECOMP	Write precomp.
LANDZONE	Landing zone.
SECTORS	Number of sectors.

If a hard disk has not been installed select NONE and press <Enter>.

- **Drive A type / Drive B type**

The category identifies the types of floppy disk drive A or drive B that has been installed in the computer.

None	No floppy drive installed.
360K, 5.25 in.	5.25 inch PC-type standard drive; 360K byte capacity.
1.2M, 5.25 in.	5.25 inch AT-type high-density drive; 1.2M byte capacity (3.5 inch when 3 Mode is Enabled).
720K, 3.5 in.	3.5 inch double-sided drive; 720K byte capacity.
1.44M, 3.5 in.	3.5 inch double-sided drive; 1.44M byte capacity.
2.88M, 3.5 in.	3.5 inch double-sided drive; 2.88M byte capacity.

- **Memory**

The category is display-only which is determined by POST (Power On Self Test) of the BIOS.

**Base Memory**

The POST of the BIOS will determine the amount of base (or conventional) memory installed in the system.

The value of the base memory is typically 512 K for systems with 512 K memory installed on the motherboard, or 640 K for systems with 640 K or more memory installed on the motherboard.

**Other Memory**

This refers to the memory located in the 640 K to 1024 K address space. This is memory that can be used for different applications.

DOS uses this area to load device drivers to keep as much base memory free for application programs. Most use for this area is Shadow RAM.

**Extended Memory**

The BIOS determines how much extended memory is present during the POST.

This is the amount of memory located above 1 MB in the CPU's memory address map.

## BIOS Features Setup

AMIBIOS SETUP – BIOS FEATURES SETUP	
( C ) 1999 American Megatrends, Inc. All Rights Reserved	
1st Boot Device	Floppy
2nd Boot Device	IDE-0
3rd Boot Device	CDROM
S.M.A.R.T. for Hard Disks	Disabled
BootUp Num-Lock	On
Floppy Drive Seek	Disabled
Password Check	Setup
ESC : Quit                      ↑↓→← : Select Item F1 : Help                        PU/PD+/- : Modify F5 :Old Values                (Shift)F2:Color F6 : Load BIOS Defaults F7 : Load SETUP Defaults	

Figure 3: BIOS Features Setup

- **1st / 2nd / 3rd Boot Device**

Floppy	Boot Device by Floppy.
ZIP A:/LS120	Boot Device by ZIP A:/LS120
CDROM	Boot Device by CDROM.
SCSI	Boot Device by SCSI.
NETWORK	Boot Device by NETWORK.
IDE-0-IDE-3	Boot Device by IDE-0-IDE-3.
Disabled	Boot Device by Disabled.
ATAPI ZIP C:	Boot Device by ATAPI ZIP C:.
USB FDD	Boot Device by USB FDD.

- **S.M.A.R.T. for Hard Disks**

Enabled	Enabled HDD S.M.A.R.T. Capability.
Disabled	Disabled HDD S.M.A.R.T. Capability. ( <b>Default value</b> )

- **Boot Up Num-Lock**

On	Keypad is number keys. ( <b>Default Value</b> )
Off	Keypad is arrow keys.

- **Floppy Drive Seek**

During POST, BIOS will determine if the floppy disk drive installed is 40 or 80 tracks. 360 type is 40 tracks while 720 , 1.2 and 1.44 are all 80 tracks.

Enabled	BIOS searches for floppy disk drive to determine if it is 40 or 80 tracks. Note that BIOS can not tell from 720, 1.2 or 1.44 drive type as they are all 80 tracks.
Disabled	BIOS will not search for the type of floppy disk drive by track number. Note that there will not be any warning message if the drive installed is 360. ( <b>Default Value</b> )

- **Password Check**

This category allows you to limit access to the Always and Setup, or just to Setup.

Always	The system can not boot and can not access to Setup page will be denied if the correct password is not entered at the prompt.
Setup	The system will boot, but access to Setup will be denied if the correct password is not entered at the prompt. ( <b>Default Value</b> )

## Chipset Features Setup

AMIBIOS SETUP – CHIPSET FEATURES SETUP ( C ) 1999 American Megatrends, Inc. All Rights Reserved			
*****DRAM Timing***		Memory Address Drive	16 mA
Top Performance	Disabled	CAS# Drive	8 mA
DRAM Frequency	100MHz	RAS# Drive	16 mA
SDRAM CAS# Latency	3		
DRAM Integrity Mode	Non-ECC		
AGP Mode	4X		
AGP Comp. Driving	Auto		
Manual AGP Comp. Driving	CB		
AGP Aperture Size	64MB		
PCI Delay Transaction	Enabled		
ClkGen Spread Spectrum	Disabled		
USB Controller	Enabled		
USB Legacy Support	Disabled		
BIOS Flash Protection	Disabled		
DRAM Drive Strength	Auto	ESC : Quit	↑↓→←: Select Item
MD Bus Strength	High	F1 : Help	PU/PD+/-/: Modify
CAS Bus Strength	High	F5 :Old Values	(Shift)F2:Color
Memory Data Drive	6 mA	F6 : Load BIOS Defaults	
SDRAM Command Drive	16 mA	F7 : Load SETUP Defaults	

Figure 4: Chipset Features Setup

- **Top Performance**

Disabled	Top Performance Disabled. <b>(Default Value)</b>
Enabled	Top Performance Enabled.

- **DRAM Frequency**

100MHz	Set DRAM Frequency is 100MHz <b>(Default Value)</b> .
133MHz	Set DRAM Frequency is 133MHz

\*\*If you want to set DRAM Frequency to 133MHz, you must set Top Performance as Enabled as first.

- **SDRAM CAS# Latency**

2	For Fastest SDRAM DIMM module.
3	For Slower SDRAM DIMM module. <b>(Default Value)</b> .
Auto	Detect SDRAM CAS# Latency by SPD.

- **DRAM Integrity Mode**

ECC	For 72 bit ECC type DIMM Model.
Non-ECC	Normal Setting. <b>(Default Value)</b>

- **AGP Mode**

4X	Set AGP Mode is 4X. <b>(Default Value)</b>
1X	Set AGP Mode is 1X.
2X	Set AGP Mode is 2X.

- **AGP Comp. Driving**

Auto	Set AGP Comp. Driving is Auto. <b>(Default Value)</b>
Manual	Set AGP Comp. Driving is Manual.

If AGP Comp. Driving is Manual.

Manual AGP Comp. Driving :	00-FF
----------------------------	-------

- **AGP Aperture Size**

4MB	Set AGP Aperture Size to 4MB.
8MB	Set AGP Aperture Size to 8 MB.
16MB	Set AGP Aperture Size to 16 MB.
32MB	Set AGP Aperture Size to 32 MB.
64MB	Set AGP Aperture Size to 64 MB. <b>(Default Value)</b>
128MB	Set AGP Aperture Size to 128 MB.
256MB	Set AGP Aperture Size to 256 MB.

- **PCI Delay Transaction**

Enabled	Enabled Delay Transaction. <b>(Default Value)</b>
Disabled	Disabled Delay Transaction.

- **ClkGen Spread Spectrum**

Disabled	Disabled ClkGen Spread Spectrum. <b>(Default Value)</b>
Enabled	Enabled ClkGen Spread Spectrum.

- **USB Controller**

Enable	Enable USB Controller. <b>(Default Value)</b>
Disable	Disable USB Controller.

- **USB Legacy Support**

Keyboard/FDD	Set USB Legacy Support Keyboard / Floppy.
KB/Mouse/FDD	Set USB Legacy Support Keyboard / Mouse /Floppy.
Disabled	Disabled USB Legacy Support Function. <b>(Default Value)</b>



● **BIOS Flash Protection**

Enable	BIOS Flash Write Protection.
Disable	Normal. <b>(Default Value)</b>

● **DRAM Drive Strength**

Auto	Set DRAM Drive Strength Auto.
Manual	Set DRAM Drive Strength Manual.

● **MD Bus Strength**

High	Set MD Bus Strength High.
Low	Set MD Bus Strength Low.

● **CAS Bus Strength**

High	Set CAS Bus Strength High.
Low	Set CAS Bus Strength High.

● **Memory Data Drive**

6 mA	Set Memory Data Drive 6 mA
8 mA	Set Memory Data Drive 8 mA

● **SDRAM Command Drive**

16 mA	Set SDRAM Command Drive 16 mA
24 mA	Set SDRAM Command Drive 24 mA

● **Memory Address Drive**

16 mA	Set Memory Address Drive 16 mA
24 mA	Set Memory Address Drive 24 mA

● **CAS# Drive**

8 mA	Set CAS# Drive 8 mA
12 mA	Set CAS# Drive 12 mA

● **RAS# Drive**

16 mA	Set RAS# Drive 16 mA
24 mA	Set RAS# Drive 24 mA

## Power Management Setup

AMIBIOS SETUP – POWER MANAGEMENT SETUP ( C ) 1999 American Megatrends, Inc. All Rights Reserved			
ACPI Standby State	S1/POS	RTC Alarm Date	Every Day
USB Dev Wakeup From S3	Disabled	RTC Alarm Hour	00
Suspend Time Out(Minute)	Disabled	RTC Alarm Minute	00
Display Activity	Ignore	RTC Alarm Second	00
IRQ3	Monitor		
IRQ4	Monitor		
IRQ5	Ignore		
IRQ7	Monitor		
IRQ9	Ignore		
IRQ10	Ignore		
IRQ11	Ignore		
IRQ13	Ignore		
IRQ14	Monitor		
IRQ15	Ignore		
Soft-Off by Power Button	Instant-Off		
System after AC Back	Soft-Off	ESC : Quit	↑↓→←: Select Item
Modem Use IRQ	4	F1 : Help	PU/PD+/- : Modify
Resume On Ring/LAN	Enabled	F5 :Old Values	(Shift)F2:Color
PME Event Wake Up	Enabled	F6 : Load BIOS Defaults	
Resume On RTC Alarm	Disabled	F7 : Load SETUP Defaults	

Figure 5: Power Management Setup

- **ACPI Standby State**

S1/POS	Set ACPI Standby State is S1 <b>(Default Value)</b> .
S3/STR	Set ACPI Standby State is S3.

- **USB Dev Wakeup From S3**

USB Dev Wakeup From S3 can be set when ACPI Sleep Type set to S3/STR.

Enabled	Enable USB Dev Wakeup From S3.
Disabled	Disable USB Dev Wakeup From S3 <b>(Default Value)</b> .

- **Suspend Time Out (Minute)**

Disabled	Disabled Suspend Time Out Function. <b>(Default Value)</b>
1	Enabled Suspend Time Out after 1min.
2	Enabled Suspend Time Out after 2min.
4	Enabled Suspend Time Out after 4min.
8	Enabled Suspend Time Out after 8min.
10	Enabled Suspend Time Out after 10min.
20	Enabled Suspend Time Out after 20min.
30	Enabled Suspend Time Out after 30min.
40	Enabled Suspend Time Out after 40min.
50	Enabled Suspend Time Out after 50min.
60	Enabled Suspend Time Out after 60min.

- **Display Activity**

Ignore	Ignore Display Activity. <b>(Default Value)</b> .
Monitor	Monitor Display Activity.

- **IRQ 3-IRQ15**

Ignore	Ignore IRQ3 -IRQ15.
Monitor	Monitor IRQ3-IRQ15.

- **Soft-off by Power Button**

Instant-off	Soft switch ON/OFF for POWER ON/OFF. <b>(Default Value)</b>
Delay 4 sec	Soft switch on 4sec for power OFF.

- **System after AC Back Function**

Memory	This function depends on computer status.
Soft-Off	Set System Soft-Off Status. <b>(Default Value)</b>
Full-On	Set System Full-On Status.

- **Modem USE IRQ**

3, 4, <b>(Default Value)</b> 5, 7, N/A
--

- **Resume On Ring / LAN**

Disabled	Disabled Resume On Ring / Lan.
Enabled	Enabled Resume On Ring / Lan. <b>(Default Value)</b>

- **PME Event Wake Up**

Disabled	Disable PME Event Wake Up.
Enabled	Enabled PME Event Wake Up. <b>(Default Value)</b>

- **Resume On RTC Alarm**

You can set "Resume On RTC Alarm" item to Enabled and key in date/time to power on system.

Disabled	Disable this function. <b>(Default Value)</b>
Enabled	Enable alarm function to POWER ON system.

If the default value is Enabled.

Date ( of Month) Alarm :	0-31
Hour Alarm	0-23
Minute Alarm	0-59
Second Alarm	0-59

## PnP/PCI Configuration

AMIBIOS SETUP – PNP / PCI CONFIGURATION	
( C ) 1999 American Megatrends, Inc. All Rights Reserved	
PnP OS Installed	No
Reset Configuration Data	No
VGA Boot from	AGP
PCI AGP Palette Snoop	Disabled
DMA Channel 0	PnP
DMA Channel 1	PnP
DMA Channel 3	PnP
DMA Channel 5	PnP
DMA Channel 6	PnP
DMA Channel 7	PnP
ESC: Quit                      ↑↓→←: Select Item F1 : Help                        PU/PD+/-/: Modify F5 :Old Values (Shift)F2:Color F6 : Load BIOS Defaults F7 : Load SETUP Defaults	

Figure 6: PnP/PCI Configuration

- PnP OS Installed**

Yes	Enable PNP OS Installed function.
No	Disable PNP OS Installed function. ( <b>Default value</b> )

- Reset Configuration Data**

No	Disable this function. ( <b>Default value</b> )
Yes	Clear PnP information in ESCD & update DMI data.

- VGA Boot From**

AGP	Primary Graphics Adapter From AGP. ( <b>Default Value</b> )
PCI	Primary Graphics Adapter From PCI.

- PCI/VGA Palette Snoop**

Enabled	For having Video Card on ISA Bus and VGA Card on PCI Bus.
Disabled	For VGA Card only. ( <b>Default Value</b> )

---

- DMA Channel( 0,1,3,5,6,7 )

ISA/ EISA	The resource is used by Legacy ISA device.
PnP	The resource is used by PnP device. <b>(Default Value)</b>

## Load BIOS Defaults

AMIBIOS SIMPLE SETUP UTILITY-VERSION 1.21 ( C ) 1999 American Megatrends, Inc. All Rights Reserved	
STANDARD CMOS SETUP	INTEGRATED PERIPHERALS
BIOS FEATURES SETUP	HARDWARE MONITOR SETUP
CHIPSET FEATURES SETUP	SUPERVISOR PASSWORD
POWER MANAGEMENT SETUP	USER PASSWORD
PNP/PCI CONFIGURATION	IDE HDD AUTO DETECTION
LOAD BIOS DEFAULTS	Load BIOS Defaults (Y/N)?N
LOAD SETUP DEFAULTS	EXIT WITHOUT SAVING
ESC : Quit    ↑↓→← : Select Item    (Shift) F2 : Change Color    F5 : Old Values F6 : Load BIOS Defaults    F7: Load SETUP Defaults    F10: Save & Exit	
Load BIOS Defaults except Standard CMOS SETUP	

Figure 7: Load BIOS Defaults

- **Load BIOS Defaults**

To load BIOS defaults value to CMOS, enter "Y". If not, enter "N".

## Load Setup Defaults

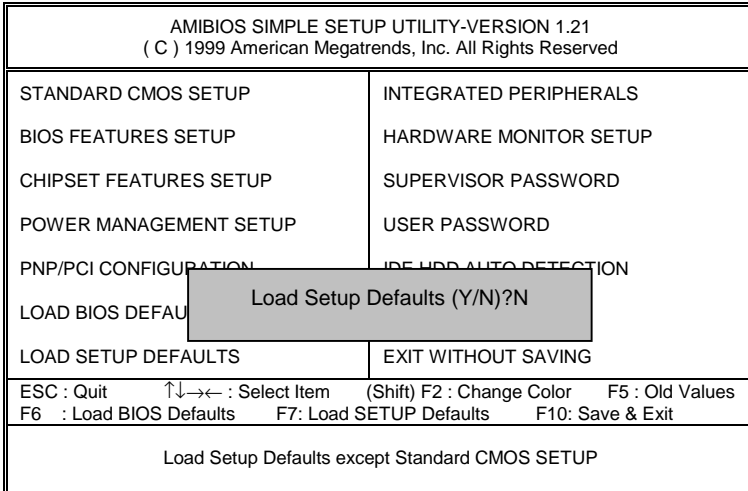

Figure 8: Load Setup Defaults

- **Load SETUP Defaults**

To load SETUP defaults value to CMOS, enter "Y". If not, enter "N".



## Integrated Peripherals

AMBIOS SETUP – INTEGRATED PERIPHERALS		( C ) 1999 American Megatrends, Inc. All Rights Reserved	
OnBoard Serial Port A	Auto		
OnBoard Serial Port B	Auto		
Serial PortB Mode	Normal		
*Duplex Mode	N/A		
IR Pins	N/A		
OnBoard Parallel Port	Auto		
Parallel Port Mode	ECP		
Parallel Port DMA	Auto		
Parallel Port IRQ	Auto		
AC97 Audio	Auto		
MC97 Modem	Auto		
OnBoard Legacy Audio	Enabled		
Sound Blaster	Disabled		
SB I/O Base Address	220h-22Fh		
SB IRQ Select	IRQ5	ESC: Quit	↑↓→←: Select Item
SB DMA Select	DMA1	F1 : Help	PU/PD+/-/ : Modify (Shift)F2:Color
MPU-401	Disabled	F5 :Old Values	
MPU-401 I/O Address	330h-333h	F6 : Load BIOS Defaults	
Game Port(200h-207h)	Enabled	F7 : Load SETUP Defaults	

Figure 9: Integrated Peripherals

- On Board Serial Port A

Auto	BIOS will automatically setup the port A address. <b>(Default Value)</b>
3F8/COM1	Enable on Board Serial port A and address is 3F8.
2F8/COM2	Enable on Board Serial port A and address is 2F8.
3E8/COM3	Enable on Board Serial port A and address is 3E8.
2E8/COM4	Enable on Board Serial port A and address is 2E8.
Disabled	Disable on Board Serial port A.

- **On Board Serial Port B**

Auto	BIOS will automatically setup the port B address. <b>(Default Value)</b>
3F8/COM1	Enable on Board Serial port B and address is 3F8.
2F8/COM2	Enable on Board Serial port B and address is 2F8.
3E8/COM3	Enable on Board Serial port B and address is 3E8.
2E8/COM4	Enable on Board Serial port B and address is 2E8.
Disabled	Disable on Board Serial port B.

- **Serial Port B Mode**

Normal	Normal operation. <b>(Default Value)</b>
IrDA	Onboard I/O chip supports IRDA
ASK IR	Onboard I/O chip supports ASK IR.

- **Duplex Mode**

Half Duplex	IR Function Duplex Half.
N/A	Disabled this function <b>(Default Value)</b> .
Full Duplex	IR Function Duplex Full.

- **IR Pins**

IRRX/IRTX	IR Pin Select is IRRX/IRTX. <b>(Default Value)</b>
From COM 2.	IR Pin Select is From COM 2.

- **OnBoard Parallel port**

378	Enable On Board LPT port and address is 378.
278	Enable On Board LPT port and address is 278.
3BC	Enable On Board LPT port and address is 3BC.
Auto	Set On Board LPT port is Auto. <b>(Default Value)</b>
Disabled	Disable On Board LPT port.

- **Parallel Port Mode**

EPP	Using Parallel port as Enhanced Parallel Port.
ECP	Using Parallel port as Extended Capabilities Port. <b>(Default Value)</b>
Normal	Normal Operation.
EPP+ECP	Using Parallel port as Enhanced Parallel Port & Extended Capabilities Port.

- **Parallel Port DMA**

Auto	Set Auto to parallel port mode DMA Channel. <b>(Default Value)</b> .
3	Set Parallel Port DMA is 3.
1	Set Parallel Port DMA is 1.
0	Set Parallel Port DMA is 0.

- **Parallel Port IRQ**

7	Set Parallel Port IRQ is 7.
Auto	Set Auto to parallel Port IRQ DMA Channel. <b>(Default Value)</b> .
5	Set Parallel Port IRQ is 5.

- **AC97 Audio**

Auto	Enabled On Board AC'97 Audio. <b>(Default Value)</b>
Disabled	Disabled On Board AC'97 Audio.

- **MC97 Modem**

Auto	Enabled On Board MC'97 Modem. <b>(Default Value)</b>
Disabled	Disabled On Board MC'97 Modem.

- **OnBoard Legacy Audio**

Enabled	Enabled OnBoard Legacy Audio. <b>(Default Value)</b>
Disabled	Disabled OnBoard Legacy Audio.

- **Sound Blaster**

Enabled	Enabled Sound Blaster.
Disabled	Disabled Sound Blaster. <b>(Default Value)</b>

- **SB I/O Base Address**

220h-22Fh	Set SB I/O Base Address is 220h-22Fh. <b>(Default Value)</b> .
280h-28Fh	Set SB I/O Base Address is 280h-28Fh.
260h-26Fh	Set SB I/O Base Address is 260h-26Fh.
240h-24Fh	Set SB I/O Base Address is 240h-24Fh.

- **SB IRQ Select**

IRQ 9 / 5 / 7 / 10 <b>(Default Value: 5)</b> .
--

- **SB DMA Select**

DMA 0 / 1 / 2 / 3 <b>(Default Value: 1)</b> .
---

- **MPU-401**

Enabled	Enabled MPU-401.
Disabled	Disabled MPU-401. <b>(Default Value)</b> .

Ps. When Force back joystick is used, MPU-401 needs to be Enable.

- **MUP-401 I/O Address**

330h-333h	Set MUP-401 I/O Address is 330h-333h. <b>(Default Value)</b> .
300h-303h	Set MUP-401 I/O Address is 300h-303h.
310h-313h	Set MUP-401 I/O Address is 310h-313h.
320h-323h	Set MUP-401 I/O Address is 320h-323h.

- **Game Port (200h-207h)**

Disabled	Disabled Game Port (200h-207h)
Enabled	Enabled Game Port (200h-207h) <b>(Default Value)</b> .

## Hardware Monitor Setup

AMIBIOS SETUP – HARDWARE MONITOR SETUP	
( C ) 1999 American Megatrends, Inc. All Rights Reserved	
ACPI Shut Down Temp.	65°C/149°F
CPU Temperature	32°C/89°F
System Temperature	32°C/89°F
CPU Fan Speed	7123 RPM
System Fan Speed	0 RPM
Vcore	1.6 V
Vcache	3.3 V
Vcc3	3.312 V
+5.000V	5.030 V
+12.000V	11.923 V
ESC: Quit                    ↑↓→←: Select Item F1 : Help                    PU/PD+/-: Modify F5 :Old Values            (Shift)F2:Color F6 : Load BIOS Defaults F7 : Load Setup Defaults	

Figure 10: Hardware Monitor Setup

- **ACPI Shutdown Temp.**

(This function will be effective only for the operating systems that support ACPI Function.)

Disabled	Normal Operation.
60°C / 140°F	Monitor CPU Temp. at 60°C / 140°F, if Temp. > 60°C / 140°F system will automatically power off .
65°C / 149°F	Monitor CPU Temp. at 65°C / 149°F, if Temp. > 65°C / 149°F system will automatically power off . <b>(Default Value)</b>
70°C / 158°F	Monitor CPU Temp. at 70°C / 158°F, if Temp. > 70°C / 158°F system will automatically power off .
75°C / 167°F	Monitor CPU Temp. at 75°C / 167°F, if Temp. > 75°C / 167°F system will automatically power off.

- **CPU Temperature**

Detect CPU Temperature automatically.

- **System Temperature**

Detect System Temperature automatically.

- **CPU FAN / System FAN Speed (RPM)**

Detect Fan speed status automatically.

- **Current CPU Vcore / Vcache / Vcc3 / +12V / +5V**

Detect system's voltage status automatically.

## Set Supervisor / User Password

When you select this function, the following message will appear at the center of the screen to assist you in creating a password.

AMBIOS SIMPLE SETUP UTILITY-VERSION 1.21 ( C ) 1999 American Megatrends, Inc. All Rights Reserved	
STANDARD CMOS SETUP	INTEGRATED PERIPHERALS
BIOS FEATURES SETUP	HARDWARE MONITOR SETUP
CHIPSET FEATURES SETUP	SUPERVISOR PASSWORD
POWER MANAGEMENT SETUP	USER PASSWORD
PNP/PCI CONFIGURATION	SECURITY OPTION
LOAD BIOS DEFAULTS	EXIT WITHOUT SAVING
ESC : Quit    ↑↓→← : Select Item    (Shift) F2 : Change Color    F5 : Old Values F6 : Load BIOS Defaults    F7: Load SETUP Defaults    F10: Save & Exit	
Enter new supervisor password:	
Change / Set / Disable Password	

Figure 11: Password Setting

Type the password, up to eight characters, and press <Enter>. The password typed now will clear the previously entered password from CMOS memory. You will be asked to confirm the password. Type the password again and press <Enter>. You may also press <Esc> to abort the selection and not enter a password.

To disable password, just press <Enter> when you are prompted to enter password. A message "PASSWORD DISABLED" will appear to confirm the password being disabled. Once the password is disabled, the system will boot and you can enter Setup freely.

If you select System at Security Option in BIOS Features Setup Menu, you will be prompted for the password every time the system is rebooted or any time you try to enter Setup Menu. If you select Setup at Security Option in BIOS Features Setup Menu, you will be prompted only when you try to enter Setup.

## IDE HDD Auto Detection

AMBIOS SETUP – STANDARD CMOS SETUP ( C ) 1999 American Megatrends, Inc. All Rights Reserved																																									
Date (mm/dd/yyyy) : Fri Mar. 25, 2000 Time (hh/mm/ss) : 10:36:24																																									
<table border="1"> <thead> <tr> <th>TYPE</th> <th>SIZE</th> <th>CYLS</th> <th>HEAD</th> <th>PRECOMP</th> <th>LANDZ</th> <th>SECTOR</th> <th>MODE</th> </tr> </thead> <tbody> <tr> <td>Pri Master</td> <td>: Auto</td> <td></td> <td></td> <td></td> <td></td> <td></td> <td></td> </tr> <tr> <td>Pri Slave</td> <td>: Auto</td> <td></td> <td></td> <td></td> <td></td> <td></td> <td></td> </tr> <tr> <td>Sec Master</td> <td>: Auto</td> <td></td> <td></td> <td></td> <td></td> <td></td> <td></td> </tr> <tr> <td>Sec Slave</td> <td>: Auto</td> <td></td> <td></td> <td></td> <td></td> <td></td> <td></td> </tr> </tbody> </table>		TYPE	SIZE	CYLS	HEAD	PRECOMP	LANDZ	SECTOR	MODE	Pri Master	: Auto							Pri Slave	: Auto							Sec Master	: Auto							Sec Slave	: Auto						
TYPE	SIZE	CYLS	HEAD	PRECOMP	LANDZ	SECTOR	MODE																																		
Pri Master	: Auto																																								
Pri Slave	: Auto																																								
Sec Master	: Auto																																								
Sec Slave	: Auto																																								
Floppy Drive A: 1.44 MB 3 ½ Floppy Driver B: Not Installed  Boot Sector Virus Protection : Disabled	Base Memory : 640 kb Other Memory: 384 kb Extended Memory: 31mb Total Memory: 32mb																																								
Month: Jan – Dec Day: 01 – 31 Year : 1990– 2099	ESC : Exit ↑↓ : Select Item PU/PD/+/- : Modify (Shift)F2 : Color																																								

Figure 12: IDE HDD Auto Detection

Type "Y" will accept the H.D.D. parameter reported by BIOS.

Type "N" will keep the old H.D.D. parameter setup. If the hard disk cylinder number is over 1024, then the user can select LBA mode or LARGER mode for DOS partition larger than 528 MB.



## Save & Exit Setup

AMBIOS SIMPLE SETUP UTILITY-VERSION 1.21 ( C ) 1999 American Megatrends, Inc. All Rights Reserved	
STANDARD CMOS SETUP	INTEGRATED PERIPHERALS
BIOS FEATURES SETUP	HARDWARE MONITOR SETUP
CHIPSET FEATURES SETUP	SUPERVISOR PASSWORD
POWER MANAGEMENT SETUP	USER PASSWORD
PNP/PCI CONFIGURATION	LOAD BIOS DEFAULTS
LOAD SETUP DEFAULTS	EXIT WITHOUT SAVING
ESC : Quit    ↑↓→← : Select Item    (Shift) F2 : Change Color    F5 : Old Values F6 : Load BIOS Defaults    F7: Load SETUP Defaults    F10: Save & Exit	
Save Data to CMOS & Exit SETUP	

Figure 13: Save & Exit Setup

Type "Y" will quit the Setup Utility and save the user setup value to RTC CMOS RAM.

Type "N" will return to Setup Utility.

## Exit Without Saving

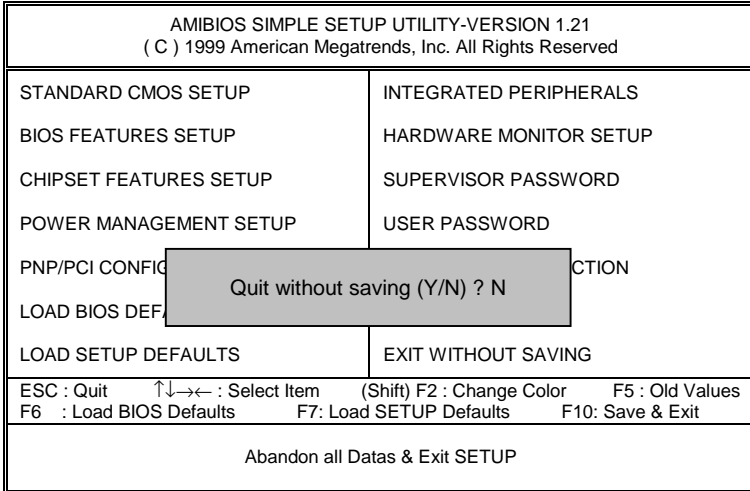

Figure 14: Exit Without Saving

Type "Y" will quit the Setup Utility without saving to RTC CMOS RAM.

Type "N" will return to Setup Utility.

# Appendix

## Appendix A: VIA Series VT82C686A Chipsets Driver Installation

### A. VIA 4 in 1 Service Pack Utility:

Insert the support CD that came with your motherboard into your CD-ROM drive or double-click the CD drive icon in My Computer to bring up the setup screen.

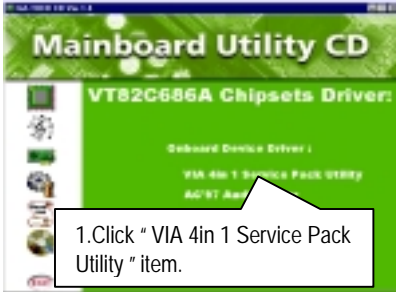

(1)

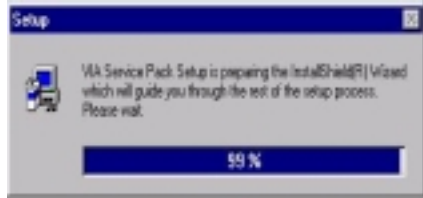

(2)

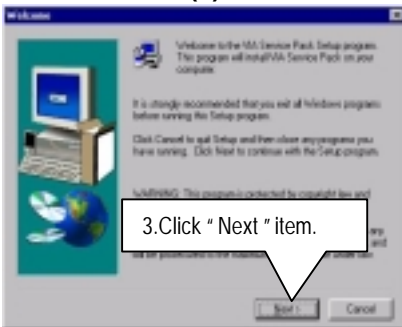

(3)

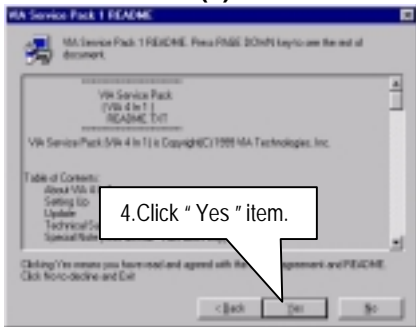

(4)

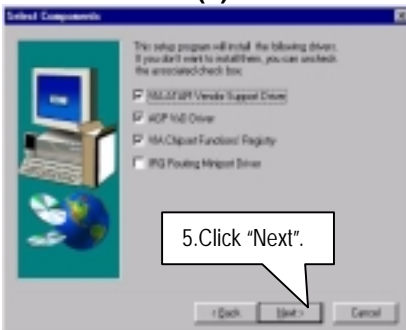

(5)

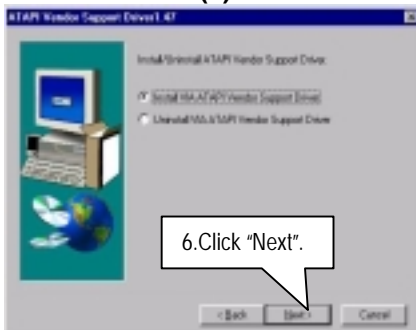

(6)

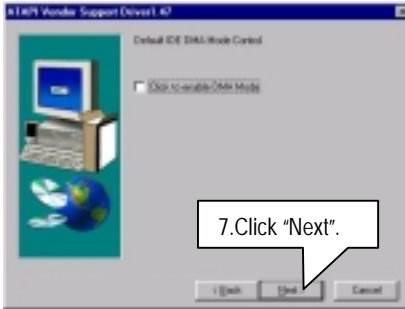

(7)

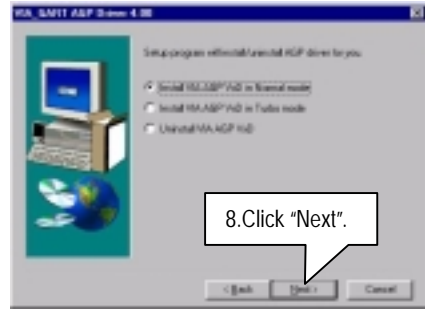

(8)

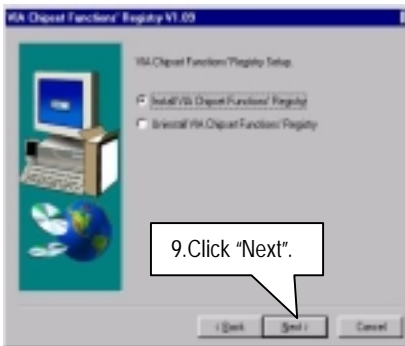

(9)



(10)

PS. This driver version doesn't support STR function, If you select "Click to enable DMA Mode" item.

## B. AC97 Audio Driver :

Insert the support CD that came with your motherboard into your CD-ROM driver or double –click the CD driver icon in My Computer to bring up the screen.

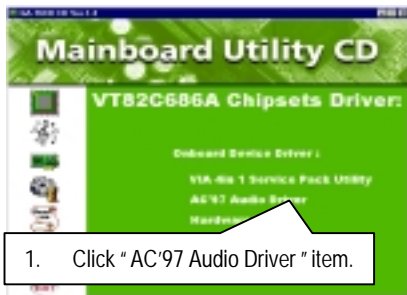

(1)

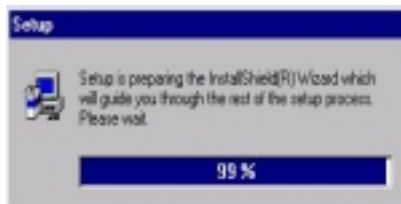

(2)

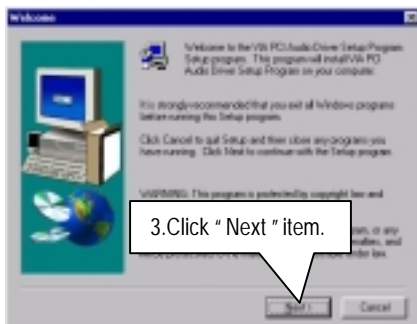

(3)



(4)

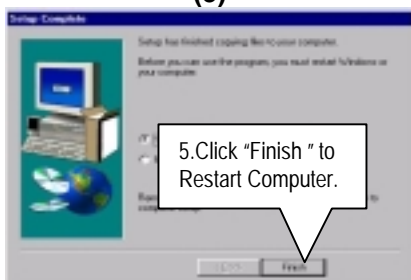

(5)

**BIOS update procedure:**

- ✓ Please check your BIOS vendor (AMI or AWARD) on the motherboard.
  - ✓ It is recommended you copy the AWDFlash.exe or AMIFlash.exe in driver CD (D:\>Utility\BIOSFlash) and the BIOS binary files into the directory you made in your hard disk. 【 i.e:C:\>Utility\ (C:\>Utility : denotes the driver and the directory where you put the flash utilities and BIOS file in.)】
  - ✓ Restart your computer into MS-DOS mode or command prompt only for Win95/98, go into the directory where the new BIOS file are located use the utility AWDFlash.exe or AMIFlash.exe to update the BIOS.
  - ✓ Type the following command once you have enter the directory where all the files are located C:\utility\ AWDFlash or AMIFlash <filename of the BIOS binary file intended for flashing>
  - ✓ Once the process is finished, reboot the system
- Note: Please download the newest BIOS from our website ([www.gigabyte.com.tw](http://www.gigabyte.com.tw)) or contact your local dealer for the file.

## Appendix B: Issues To Beware Of When Installing AMR

Please use inverse AMR card like the one in order to avoid mechanical problem. (See Figure A)

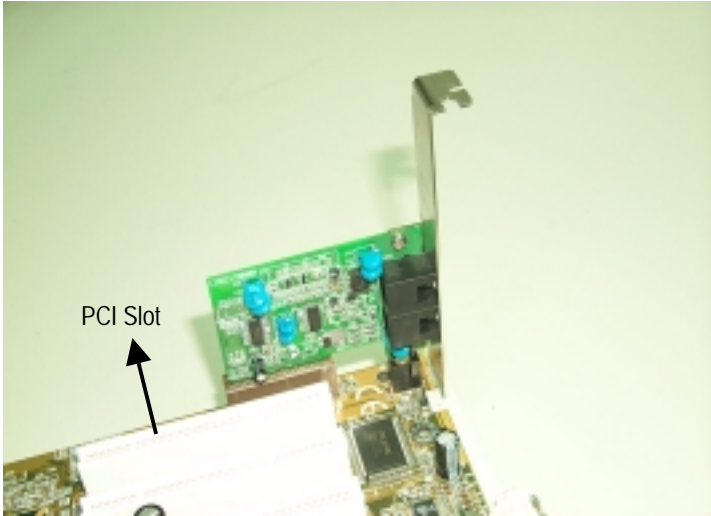

Figure A: Inverse AMR Card (Default)

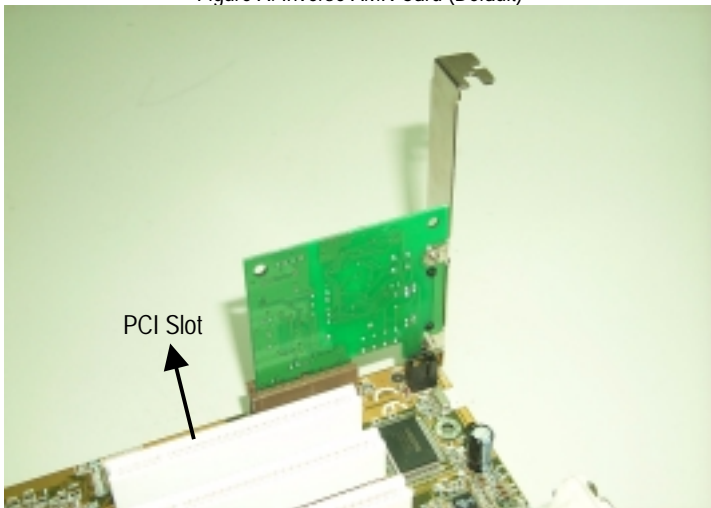

Figure B: Non inverse AMR Card

## Appendix C: Acronyms

Acor.	Meaning
ACPI	Advanced Configuration and Power Interface
POST	Power-On Self Test
LAN	Local Area Network
ECP	Extended Capabilities Port
APM	Advanced Power Management
DMA	Direct Memory Access
MHz	Megahertz
ESCD	Extended System Configuration Data
CPU	Central Processing Unit
SMP	Symmetric Multi-Processing
USB	Universal Serial Bus
OS	Operating System
ECC	Error Checking and Correcting
IDE	Integrated Dual Channel Enhanced
SCI	Special Circumstance Instructions
LBA	Logical Block Addressing
EMC	Electromagnetic Compatibility
BIOS	Basic Input / Output System
SMI	System Management Interrupt
IRQ	Interrupt Request
NIC	Network Interface Card
A.G.P.	Accelerated Graphics Port
S.E.C.C.	Single Edge Contact Cartridge
LED	Light Emitting Diode
EPP	Enhanced Parallel Port
CMOS	Complementary Metal Oxide Semiconductor
I/O	Input / Output
ESD	Electrostatic DISCHARGE
OEM	Original Equipment Manufacturer
SRAM	Static Random Access Memory
VID	Voltage ID
DMI	Desktop Management Interface
MIDI	Musical Interface Digital Interface
IOAPIC	Input Output Advanced Programmable Input Controller
DIMM	Dual Inline Memory Module
DRAM	Dynamic Random Access Memory
PAC	PCI A.G.P. Controller
AMR	Audio Modem Riser

To be continued...



## 7VM Motherboard

---

Acor.	Meaning
PCI	Peripheral Component Interconnect
RIMM	Rambus in-line Memory Module
DRM	Dual Retention Mechanism
ISA	Industry Standard Architecture
MTH	Memory Translator Hub
CRIMM	Continuity RIMM